

*price list* effective October 4, 2021

# TABLES + CASEGOODS

---

V2 N-Z



# JSI Price Lists

## Tables + Casegoods | Volume 1

- Apogee
- Bourne Tables
- Bravado
- Brogan
- Collective Office
- Collective Presentation
- Finale
- Fresco
- Power and Data

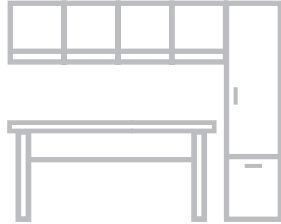

## Tables + Casegoods | Vision

- Casegoods
- Tables

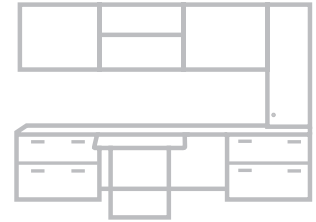

## Tables + Casegoods | Volume 2

- Native
- Nosh
- Prep
- Prost
- Reef
- Romy
- Trail
- Power and Data



## Seating | Volume 1

- |                |                   |        |
|----------------|-------------------|--------|
| Addison        | Cabaret           |        |
| Alden          | Collective Motion |        |
| Americana      | Connect           |        |
| Ansen          | Corbin            |        |
| Arwyn          | Cym               |        |
| Avalon         | Encore            |        |
| Avini          | Esque             |        |
| BeSpace        | Finn              |        |
| Bison          | Finn Nu           | Harbor |
| Boston         | Florette          | Hedron |
| Bourne Seating | Garvey R5         | Hoopz  |
| Bryn           | Gatsby            | Indie  |
| Caav           | Hanover           |        |

## Tables | Lok

- Training Tables
- Teamwork Tables
- Conference Tables
- Occasional Tables



## Tables + Casegoods | Flux

- Private Office
- Open Plan

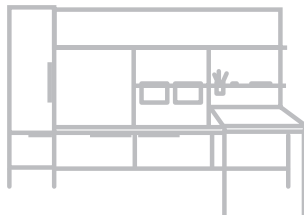

## Seating | Volume 2

- |          |          |         |
|----------|----------|---------|
| Jude     | Oxley    |         |
| Knox     | Pillow   |         |
| Kyla     | Portrait |         |
| Laurel   | Protocol |         |
| Luci     | Proxy    |         |
| Mackey   | Ramona   |         |
| Madison  | Ria      |         |
| Melrose  | Solara   |         |
| Milk     | Sosa     | Waltham |
| Moto     | Tara     | Wink    |
| Murphy   | Totem    | Ziva    |
| Newton   | Trinity  |         |
| Olympian | Tyler    |         |

## Online Only | [jsifurniture.com](http://jsifurniture.com)



- |          |           |           |         |          |            |
|----------|-----------|-----------|---------|----------|------------|
| Axis     | Class Act | Congress  | Lincoln | Shuffle  | Walden     |
| Bentley  | Classmate | Hudson    | Menu    | Stockton | Wellington |
| Broadway | Collegian | Jefferson | Regal   | Strata   |            |



# Casegoods and Tables Price List | Volume 2: N-Z

## General Information

Environmental Mission . . . . .	4
Warranty. . . . .	5
Laminate and Veneer Characteristics . . . . .	5
Samples. . . . .	6
Order Procedures . . . . .	6
Quickship Program. . . . .	6
Delivery . . . . .	6
Freight Damage . . . . .	7
Repairs and Returns . . . . .	7
Care and Maintenance. . . . .	7
Fire Retardancy / CAL 133 . . . . .	8
Textile Information / COM and COL Policy. . . . .	9

## Textile and Leather Swatch Card Programs

Maharam . . . . .	10-11
Momentum . . . . .	12-16
Spradling . . . . .	17
Stinson . . . . .	17
Ultrafabrics . . . . .	18
Cortina . . . . .	18

## Fabric Grading

Arc-Com. . . . .	19
Designtex . . . . .	20
Maharam . . . . .	21
Mayer . . . . .	22
Momentum . . . . .	23
Spradling . . . . .	25
Stinson . . . . .	24
Ultrafabrics . . . . .	25

## Leather Grading

Cortina . . . . .	26
-------------------	----

## Specification Tools. . . . .

	27
--	----

## GSA Terms and Conditions . . . . .

	28-30
--	-------

<b>Native . . . . .</b>	<b>31</b>
Table with Open Loop Bases . . . . .	50
Table with Panel Bases. . . . .	58
Table with Box Bases. . . . .	78
Table with Height Adjustable Bases. . . . .	98
Table with X Base . . . . .	106
Peninsula Table with Open Loop Base . . . . .	108
Peninsula Table with Panel Base . . . . .	114
Credenzas . . . . .	120, 146
Runoff Table with Open Loop Base . . . . .	128
Runoff Table with Panel Base. . . . .	134
Media Wall Space Divider . . . . .	140
Towers. . . . .	144
Hospitality Cart . . . . .	146
Open Shelves . . . . .	146
Mobile Lecterns . . . . .	147
Mobile Boards . . . . .	148
Coffee Tables . . . . .	149
Benches. . . . .	149
Wire Management . . . . .	150
Power Units . . . . .	150
<b>Nosh . . . . .</b>	<b>153</b>
29”h Tables . . . . .	166
36”h Tables . . . . .	218
42”h Tables . . . . .	266
<b>Prep . . . . .</b>	<b>315</b>
Multi-Purpose Tables. . . . .	316
Conference Tables . . . . .	332
Training Tables . . . . .	337
<b>Prost . . . . .</b>	<b>352</b>
<b>Reef . . . . .</b>	<b>357</b>
Panel Tables . . . . .	366
Layered Tables . . . . .	370
Layered Tables with Bookshelves . . . . .	374
Layered Tables with Bookcases . . . . .	382

<b>Romy . . . . .</b>	<b>383</b>
<b>Shuffle . . . . .</b>	<b>Online at jsifurniture.com</b>
<b>Stockton . . . . .</b>	<b>Online at jsifurniture.com</b>
<b>Strata . . . . .</b>	<b>Online at jsifurniture.com</b>
<b>Trail. . . . .</b>	<b>386</b>
<b>Vision. . . . .</b>	<b>See Vision Book</b>
<b>Walden . . . . .</b>	<b>Online at jsifurniture.com</b>
<b>Wellington . . . . .</b>	<b>Online at jsifurniture.com</b>
<b>Accessories, Power and Data . . . . .</b>	<b>391</b>
Power and Data . . . . .	393
Wire Management . . . . .	397
Task Lights. . . . .	404
Keyboard Accessories . . . . .	407
<b>Index . . . . .</b>	<b>408</b>

## Environmental Mission

Our vision and goal is a sustaining supplier, manufacturer and customer for the long term protection and preservation of our environment for future generations.

### MISSION

To achieve this vision, we are dedicated to ensuring the health and wellbeing of all of our partners, reducing negative impact on the environment, and maintaining price structure by increasing efficiencies and reducing consumption.

JSI, and it's parent company, is an internal manufacturer and has been an environmentally conscious organization for more than 80 years.

We are proud to use wood as our primary sustainable material resource and all corporate policies and procedures support the efforts to "recover, recycle, reuse, repurpose, reduce, refuse, and re-engineer". In doing this, we are committed to the conservation of the environment and its natural resources as well as encouraging our suppliers and customers to do the same. A goal of a "Sustainable Partnership", supplier, manufacturer and customer, is essential for the long term protection preservation and sustainability of our environment for future generations.

### LOCATION

Our manufacturing facilities are located in the center of Southern Indiana. With our diverse product offering and manufacturing capabilities, we provide a single source for all of your project needs allowing you to conserve our fossil fuels and reduce greenhouse gases.

### PACKAGING

We place emphasis on the minimal use of disposable packaging while still providing adequate protection to the finished product. Our corrugated packaging is recyclable, reusable, and up to 100% recycled content. We reuse or recycle more than 175 tons of corrugated material annually.

### REGULATORY

All of our manufacturing facilities are in compliance with applicable OSHA regulations and meet or exceed all applicable DEM and EPA regulations for air emissions, storm water and hazardous waste disposal.

### MANUFACTURING FACILITIES

Our manufacturing facilities are geared toward eco-efficiency and are encouraged to continually improve and conserve. Solid wood not used in the direct manufacturing process is recovered for the operation of our dry kilns, thus reducing greenhouse gases, the use of fossil fuels, and the burden of waste placed on landfills. Composite panels not used in the direct manufacturing process are ground and sold for use as animal bedding and boiler fuel. In addition to other energy savings techniques, our manufacturing facilities use high efficient lighting, make use of power factor capacitors, and encourage all to conserve and reduce energy consumption and water usage. Condensation pumps are used to aid in water conservation as well as extending boiler life.

### MANUFACTURING PROCESSES

Our finish processes utilize efficient spray guns and proper spray techniques to reduce wasted material. Excess finish material, solvents, and waste are recycled. Many of the assembly processes use water based glues that contain no hazardous ingredients.

### TEXTILES

Many of our fabric options utilize up to 100% recycled content. Our leather alternative program includes selections that contain no toxic materials, plasticizers, heavy metals, or formaldehyde and have a 100% biodegradable back cloth. Some of the available panel fabric used, if discarded is a biological nutrient for the soil. Most of the components (foam, batting, and polycord) used in upholstered products are recyclable. Excess fabrics and leathers not utilized in the upholstery process go to recyclers and local charities for additional use.

### WOOD

Wood is the most diverse, most process friendly, and most widely utilized natural resource in mankind's history. No other natural resource can match the environmental advantages of wood, including being renewable, recyclable, natural, carbon negative, and biodegradable. Utilizing the sun's energy, trees grow and remove carbon dioxide from the air while giving off oxygen to benefit the entire planet. Approximately 49% of wood's dry weight is carbon and harvesting mature trees in a sustainable forest, which has slowed in the absorption of carbon dioxide, allows the photosynthetic cycle to continue at full optimization and allow for the carbon to remain sequestered. We are proud to use wood as our primary "sustainable" renewable resource.

### WOOD OPTIONS

Many environmentally friendly solid wood and engineered wood options are available for quote, including: Lyptus®, Plyboo®, reclaimed woods, agricultural and post-consumer waste fiber products, etc.

### INDOOR AIR QUALITY

Our goal is to reduce the impact our products will have on the indoor air quality. We practice the latest technologies and utilize a third party to assure we meet this goal. GreenGuard, one of the leaders in IAQ certification, continues to certify our product offering with UL2818 - GreenGuard Indoor Air Quality certification.

### PARTNERSHIPS

BIFMA  
*Business and Institutional Furniture Manufacturer Association*  
 USGBC  
*United States Green Building Council*  
 IIDA  
*International Interior Design Association*  
 FSC  
*Forest Stewardship Council - Forestland*  
*UL GreenGuard*  
*Indiana Department of Natural Resources - Division of Forestry - Classified Forest, Wildlands Program*

### Lifetime Warranty

JSI warrants to the original purchaser that each piece of furniture will be free from defects in workmanship, given normal use and care for as long as the original customer owns and uses the product. Normal use is defined as the equivalent of a single shift, 40-hour work week.

JSI will, at its option, repair or replace with comparable product within the terms of the warranty.

#### Exceptions to Warranty:

##### 12 Years (from date of purchase)

- Wood Seating
- Seating Controls
- Veneer Surfaces
- Laminate Surfaces
- Pneumatic Cylinders

##### 5 Years (from date of purchase)

- Glides · Casters · Task Lights
- Mesh/Knit Material · Foam
- Florette Plastic Frame Chairs
- Electrical Components
- Electric Height Adjustable Bases

#### This Warranty Does Not Cover:

- Natural variations in color, grain or texture of wood and other covering materials over which JSI has no control.
- Normal wear, color fastness, shrinkage, puddling, wrinkling and stretching of upholsteries including fabric, vinyl, leather and other textiles. This warranty does not cover any defects that may arise in the use of COM or COL upholstery materials. Textile manufacturer's warranty will apply.
- Damages resulting from transportation, improper assembly, installation, handling, accident, user modification attachments, misuse, or neglect of product care.
- Damage resulting from extreme climate conditions.
- Finish damages resulting from normal wear and tear, improper maintenance, water damage, exposure to sunlight, extreme high or low humidity or temperature, or other acts of nature.
- Damage created by loading file drawers with anything other than hanging folders.

JSI makes no expressed or implied warranties to any product and, in particular, makes no warranty of merchantability of fitness for any particular purpose. JSI will not be liable for any consequential or incidental damages under this warranty.

### Unique Characteristic of Natural Woods and Veneers

JSI uses high quality wood and veneer harvested from sustainably managed forests. Every tree has unique and defining characteristics, like fingerprints. These characteristics can be defined by differences in color, grain configuration, and textures. These characteristics will be more noticeable if the product has a clear or lighter finish.

Maple and Cherry species have a higher degree of uneven distribution of grain, small color streaks, and pin knots.

At JSI, we take care of selecting woods and veneers that are used in our products. With this in mind, we hope you appreciate the beauty of each tree's fingerprints. Products will not be replaced due to these natural characteristics.

Veneers can be sliced in a variety of ways to create unique patterns. JSI uses several different patterns, as shown below.

Flat (Plain) Cut as shown in diagram

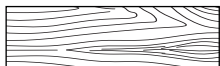

Quarter Sliced as shown in diagram

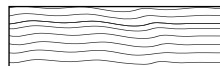

Double Cut as shown in diagram



#### Double Cut

The Double Cut veneer is a processed product that has at least two cuttings to create the final veneers. These cuts of veneer strands are dyed and layered into a block to create variation of patterns from a very tight grain pattern to an exotic figure grain pattern.

JSI uses select beech, cherry, maple, oak and walnut cut wood products to produce the desired look of our furniture products.

Please reference the featured highlights of each product line to identify the species and grain patterns available for that product.

### Laminates (Veneer Series)

HPL (Higher Pressure Laminate) laminates can be specified on most of our work surface tops in most of our product lines. Refer to the specification pages for each series. The specification pages will also list the available coordinating finishes.

### Laminate Series

JSI laminate series offer a full laminated product with imprinted grain to hide finger prints and provide durability. The worksurface tops are HPL (High Pressure Laminate). TFL (Thermal Fused Laminate) is used on the product's chassis. Please reference the featured highlights of each product for additional details.

### Finish - Top Coat

To reduce hazardous formaldehyde emissions, we use our proprietary specially designed top coat, DuraTex™. It significantly reduces hazardous formaldehyde emissions and helps improve indoor air quality.

### Finish - Color/Stains

A wide range of stains are available to bring out the beautiful characteristics of each wood species. We coordinate finish color between our veneer stains and solid lumber stains; however, not all may be a perfect match. The stains are continually reviewed for accuracy of color, as well as a constant monitoring of the latest color trends in the furniture market.

### Finish - Matching

Due to the natural characteristics of wood, environmental effects, and material upgrades, JSI cannot guarantee exact finish matches on existing furniture previously ordered.

If an exact match is required to accompany existing furniture, it must be specified at the time of order placement, so specific internal procedures can be followed to ensure a proper and acceptable finish match. We reserve the right to change our finish formula at any time to improve safety, quality, and appearance. Unless a finish match for existing furniture is requested at the time of ordering, we accept no liability for finish that may not match the existing furniture from prior orders.

Solid lumber may inherently have mineral streaks, pits, and various other natural occurrences. Care is taken in selecting the solid lumber to coordinate with the requested finish on our veneer products. This internal selection process is subject to availability of solid lumber parts.

### Custom/Special Finishes

JSI, upon request, will accommodate special finishes. A written request is required to proceed with custom finish orders. A sample reference is required for first time matches and must be included with the written request.

There is a one time charge of **\$332 list per order** for any non-standard wood finish.

Orders will be entered noting the special finish. A sample match will be provided to the customer. Written approval is needed before the finish process can be started. Delays in approval may have an impact on lead times.

Every effort will be made to create the requested match; however, an acceptable match may not be possible because of natural variations of wood. These natural variations can also cause minor differences in the final finish product.

### Samples

Samples of standard wood finishes, paints colors, metal colors, and standard laminate are available upon request. The fastest way for requests to be filled is by using our website. See below for options to request samples.

Website – jsifurniture.com (click the resource tab)

JSI Sales representatives

Phone – 800.457.4511 – Customer Service

Email – customerservice@jaspergroup.us.com

### Pricing

Prices found in this document or on our website are list prices in U.S. dollars for standard product delivery to one destination. Prices do not include storage, installation, or taxes. Possession of this price list does not constitute an offer to sell. Orders can only be received from approved authorized JSI dealers.

Prices and product information in this document, as well as our website, are subject to change without notice. Reference website for most up to date product offering and pricing.

### Orders

Detailed specification pages are available in the price list at the beginning of each series.

Additional information may be obtained by consulting the Customer Service Department or our website.

Indicate shipping address if different from billing address.

Send Orders To:

US Mail – JSI

225 Clay Street

Jasper, IN 47546

Fax – 812-482-1548

Email – orders@jaspergroup.us.com

JSI reserves the right to make changes in dimensions, styles, or specifications if we believe these changes will improve the safety, quality, or appearance of the product.

Acceptance of orders will be subject to credit approval, barring any acts of governments, or any other causes beyond our control (e.g. strikes, fire, embargo of materials, etc).

### Product Modifications

While we offer a wide range of products to accommodate many possible solutions, we also recognize the needs for our products to be modified from our standard offering.

In the series introduction section of each product, we address modification options for that series.

To see if the desired modification is possible, please contact our Customer Service Department for a quote. Note that order quantities and material availability can affect the quote. Additional information may be requested to fully quote modifications.

### Order Acknowledgments

All orders will be acknowledged promptly upon entry of a clean order. The acknowledgment will show how the order was entered, ship date and any other information pertinent to the order. It is the purchaser's responsibility to verify all the information on the acknowledgment carefully and notify us immediately, in writing, of any discrepancies.

Every reasonable effort is made to ship as acknowledged; however, the acknowledged ship date is approximate. Company will generally ship within five (5) working days of the acknowledged ship date. If a firm ship date is necessary, customer must inform company at time of order and company will make all reasonable efforts to meet each customer's request. Acknowledged shipping dates are contingent upon the force majeure conditions contained in these terms and conditions.

### Quickship

Items indicated with a Quickship symbol  ship within 10 business days of receipt of a clean, credit approved purchase order. Product for up to 20 offices or 20 tables can be selected from the Brogan, Finale, Flux or Vision series. See individual product pages for those models available on quickship. Available capacity is filled by orders as they are received. If normal 10 day Quickship is not available because capacity has been filled, you will be immediately notified. Changes and cancellations to Quickship orders are not allowed under any circumstances.

### Delivery

Our freight policy consists of prepaid freight to the 48 contiguous states; all other shipments are prepaid to port of exit ONLY. JSI reserves the right to select the appropriate carrier and shipment routes, most shipments are on freight carriers that are dedicated furniture specialists. Standard deliveries require a DOCK that can accommodate **75 foot trucks**. Ownership and inspection of product is the responsibility of the buyer upon pickup by the freight carrier. Pricing in this book is for standard delivery only. Standard delivery does **not** include non-dock delivery, inside delivery, residential delivery or installation of product. Fees and changes for non-standard deliveries are listed below.

### Standard Delivery Time

Between 8AM and 3PM Monday through Friday. Special delivery requests can be subject to additional fees to accommodate requests.

### Cancellations and Changes

All orders are considered firm and are not subject to cancellation or change without approval from JSI. All approved changes are subject to additional charges and revised lead times

### No Touch Freight

Our freight is considered "no touch". Therefore, customers are to be prepared to unload freight from inside the truck prior to arrival. In the instance that a driver must unload the shipment, driver assists fees will apply (see fees below).

### Detention Fees

- Carriers are given two-hour maximum time allotment to unload for one-stop truckloads.

- Carriers are given one hour maximum time allotment to unload for multi-stop truckloads

\*Detention fees apply after allotted unloading time and will be at buyer's expense.

### On-Site Deliveries

Shipments to the installation site, and time deliveries are available on full truckloads or slightly less, at no additional charge. Shipments or timed deliveries for smaller shipments may not be available, or if available may require an additional charge.

### Residential Deliveries

Our freight policy prohibits the delivery of freight to a residential property.

## Fees

Orders of less than \$1,000 net . . . . .	\$78 net per order
Weekday deliveries outside of standard delivery times . . . . .	\$250
Weekend deliveries (Saturday or Sunday) . . . . .	\$500
Liftgate Deliveries. . . . .	\$100 minimum 5% of net price
Driver Assist . . . . .	\$75
Jobsite Non-Dock Delivery . . . . .	\$100
Inside Delivery (first floor inside only) - no installation or carton removal. . . . .	\$125 minimum 5% of net price

## Warehouse/Storage Fees

Additional storage time with a provided two-week approved notice is calculated at 3% per month of the product amount or per day.

## Please be Advised

- Reconsignment fees are the responsibility of the buyer.
- Any charges arising from failure to meet shipment, re-routing while in transit or carrier storage charges are the responsibility of the buyer.
- Contact Customer Service to inquire about skidding of products, special crating of products and product installation. These requests must be approved by JSI and made at the time of order.
- Carriers have the right to refuse delivery to a specified location if it conflicts with their liability policy.

## Freight Damage

JSI products are packed in cartons and meet or exceed existing codes for furniture and seating products. All shipments are delivered to the carrier in good condition and our liability ceases thereafter. If delivery arrives short or damaged, contact the carrier immediately to file a claim. In the event of concealed damage, notify the carrier and request immediate inspection. Failure to file a claim within 15 days after receipt of merchandise constitutes acceptance and a waiver of any such claims. Please inspect merchandise immediately upon receipt, otherwise there is no recourse. Keep all cartons and packing material, discarding these materials may negate your claim.

Storage of product in areas of uncontrolled humidity and temperature may cause damage to the product and void the JSI warranty.

## Repairs

JSI will not issue credit allowance for any type of repairs without prior written consent.

Sales order, product model numbers, and reason for repair will be expected in order to process the repair request. A digital photo will help to expedite the request. JSI reserves the right to recommend solutions for repair.

## Returns

No merchandise may be returned to JSI without a signed Return Good Authorization (RGA) form issued by our Customer Service Department. Any authorized return not due to damage or defect will be assessed a 45% restocking fee and all return freight charges must be prepaid. Additional restocking fees may apply for any modification, special or custom built product.

Liability for defective merchandise shall be limited to replacement or repair.

Under no circumstance can we accept COD (Cash On Delivery) returns. Any such shipment will be refused.

## Replacement Parts

Obtain information and pricing on replacement parts by contacting Customer Service. Please have the model number available when requesting replacement parts. Additional information may be required to ensure proper replacement parts.

## Care and Maintenance

### Care of Upholstery Surfaces

Cleanability will vary based on the fabric type. For best results, a professional service is recommended. Dirt and crumbs may be gently brushed or vacuumed off. Spills should be wiped up immediately with a cloth. Vinyl textiles can be cleaned with warm soapy water and then wiped down with a warm damp cloth. For more details on any JSI carded fabric and vinyl, please visit our website at [jsifurniture.com](http://jsifurniture.com) or consult the back of the appropriate swatch card for cleaning codes and any specific instructions. For COM materials, consult with the individual textile manufacturer for cleaning codes and any specific instructions pertaining to your particular fabric.

### Maintenance of Mechanical Parts

Clean any lint or debris from the moving parts of the base mechanisms. Mechanisms have been designed and tested to not require lubrication under normal conditions; however, lubricant can be used if needed.

### Care of Wood Edges and Veneer Surfaces

Clean all surfaces frequently with water dampened soft cloth, moving the cloth with the grain direction. Immediately remove any liquids that come in contact with wood surfaces with a blotting action to absorb liquid. Buff dry. Lift objects to move them, never pull them across the finished surface. For an additional safeguard, use a protective surface pad. This will ensure a lasting finish by protecting your furniture from possible damage caused by pens, cups and sharp objects. Avoid exposure of furniture to extremes of heat and cold, or to wide humidity variances. Avoid exposure of furniture to strong sunlight. Avoid exposure of furniture to harsh solvents such as nail polish remover, acetates, etc., as it will cause finish deterioration. If using a protective glass top, place spacer pads under the glass top to allow the wood to breath.

### Care of Metal Finishes

Wash you powder-coated item at least one every six months. Use soft rags only - No abrasives. For stubborn stains and grease marks, use soap and water mixture. Combine 1 gallon of water and 1 cup of the neutral detergent in the bucket. Mix it up by swirling one of the rags around in it. Wipe down the powder coat with a rag that has been dampened with the cleaning solution. Do not scrub, but use gentle, repetitive pressure to remove any built-up grime. Rinse the powder coat off with a rag dampened with clear, clean water. Do not spray it down, but rather wipe it off with the rag. You may need to do this several times to get all the soap off. Wipe the powder coat down with a clean dry rag. This will prevent streaking and spotting.



### Care of Frosted Glass

Use a clean, dry lint free cloth to wipe the surface. Follow with warm water and a clean rag; no soap or chemicals. Wipe dry with a clean, dry lint free cloth. Cleaning the frosted side is not recommended, if desired to clean use the above method but do not spray the water on the frosted side, use a clean rag. Please allow 48 hours for the frosted side to dry and not to show cloudiness.

### Tempered Glass Information

JSI is aware of occasional occurrences of spontaneous glass breakage in various furniture products. Tempered glass makes it stronger and if it breaks, will cause it to break into many small pieces of “cubes” rather than sharp and potentially dangerous shards.

Glass breakage in furniture may occur for a variety of reasons. Tempered glass is particularly prone to breakage from damage (scratches, nicks, etc.) that may occur during shipping, handling, installation, use or maintenance. Exposure to rapid changes in temperature or concentrated temperature zones may also cause breakage.

Tempered glass may also break due to a specific type of imperfection or “inclusion” that occurs within the glass when manufactured. When this condition exists glass breakage may occur without any obvious cause. This is often referred to as “spontaneous” breakage but is a very isolated occurrence in the glass industry.

### Care of Dry Erase Boards

Erase after every use to eliminate ghosting. Clean weekly with a Dry Erase Cleaner. Avoid the use of orange and red Dry Erase Markers. Follow manufacturer cleaning instructions for the eraser. If ghosting or staining remains use a small amount of rubbing alcohol on a clean, soft towel to remove.

### Care of Solid Surface

Although liquids cannot penetrate Solid Surface, it is best to wipe up spills as they occur. Generally, a damp microfiber cloth used with a standard household kitchen spray should remove most stains.

For most residues, all you need to clean your Solid Surface countertops is a warm soapy water, ammonia-based household cleaner or a dedicated countertop cleaner. Do avoid window cleaners; however, as they can leave a waxy build-up that dulls the surface. Always clean using a circular motion.

Film will build up on countertops if water is left to dry on the surface. This film will dull the countertop surface, making the finish appear blotchy and uneven. To prevent film build-up, it is very important to wipe the countertop completely dry immediately after spills and cleaning.

Some color of Solid Surface may require more frequent cleaning to maintain a uniform finish. Darker colors tend to require more attention than lighter colors. Over time, even with proper care, your countertop will acquire a sheen. Dark colors may show light scratches more readily.

### Fire Retardancy

All JSI upholstered components comply with California Bureau of Home Furnishings and Thermal Insulation-Technical Bulletin 117-2013 issued by State of California Department of Consumer Affairs. This standard requires upholstered furniture to be safer from the hazards associated with smolder ignition in all four (4) categories of materials, as applicable.

Compliance with more stringent codes may require special manufacturing considerations and upcharges.

### California Technical Bulletin 133 (CAL 133)

JSI uses a barrier material between the foam cushioning and the upholstery cover in order to comply with CAL 133. The standard upcharge on products specified to comply with CAL 133 is **\$69 list per yard** of textile.

JSI has performed a series of full scale fire tests on samples - representing worst case scenarios of upholstered units - to comply with the requirements of the state of California Technical Bulletin 133 (CAL 133). Products in compliance are labeled in accordance of the standards.

Some product designs and fabric cannot be combined to comply with CAL 133. Because of this, we reserve the right to reject any request for an upholstery cover, including COM, textile may not contain olefin or product style that we feel may compromise the integrity or safety of a product specified to comply with CAL 133.

Contact Customer Service for a quote if you require laboratory certification that a specific product and upholstery combination WILL PASS CAL 133. The quotation will include testing, video, and transportation charges plus the list cost of the sample.

Our standard lead time will apply to products that do not require certification. Allow an additional six weeks over the standard lead time for products that need actual laboratory certification.

The end user, specifier and/or dealer have the responsibility to make sure all products specified will meet the flammability and safety codes of the jurisdiction where the products will be located and used.

### Flame Spread

All JSI may be required to comply with the requirements of Flame Spread based on ASTM standards/NFPA Life Safety Codes and general public knowledge are as follows:

Solid Wood - Class C  
 Topcoats - Class A  
 Carded Fabric - Class A  
 Composite Panels - Class C  
 Laminate - Class B

Plastics - According to the NFPA, the lack of stability of plastics under high temperature conditions and inherent combustibility have eliminated the use of plastics for applications requiring a flame spread rating.

Also be advised that improvements may be attained in certain instances with the addition of chemicals which may add additional costs, chemical exposure and/or compromise the integrity of the product.

### Textile Carded Programs

JSI is proud to partner with Maharam, Momentum, Spradling, Stinson, Ultrafabrics and Cortina Leather. Please refer to the respective pages in this pricer for each of these partners. Scan the QR codes on the back of the swatch card for latest grades and other information.

### Textile Grade-In Programs

For the convenience of our specifiers, we have graded in the following suppliers:

Arc Com [www.arc-com.com](http://www.arc-com.com)  
 Designtex [www.designtex.com](http://www.designtex.com)  
 Maharam [www.maharam.com](http://www.maharam.com)  
 Mayer [www.mayerfabrics.com](http://www.mayerfabrics.com)  
 Momentum [www.themomgroup.com](http://www.themomgroup.com)  
 Spradling [www.spradlingvinyl.com](http://www.spradlingvinyl.com)  
 Stinson [www.cfstinson.com](http://www.cfstinson.com)  
 Ultrafabrics [www.ultrafabricsllc.com](http://www.ultrafabricsllc.com)  
 Cortina Leather [www.cortinaleathers.com](http://www.cortinaleathers.com)

For memo samples, contact textile suppliers.

Please contact Customer Service for pricing grades on textiles and leathers not listed.

Indicate on purchase order if JSI is to order the fabric.

Grades and availability of fabric are subject to change without notice. Changes could include but are not limited to price increase, discontinued patterns, discontinued colors, etc. See [jsifurniture.com](http://jsifurniture.com) for up to date information.

Many textiles have repeats and the additional yardage required has been factored in for textiles ordered through the JSI Carded and Grade-In Programs. We reserve the right not to match textiles with a horizontal or vertical repeat greater than 17". Additional charges may apply for textile being applied with special instructions.

Some fabric thickness or stiffness may cause issue with proper upholstering of tackable wall panels or upholstery privacy screens. Please contact customer service with concerns on the fabric thickness for these items.

### COM/COL Address

JSI  
 Attn: COM/COL Department  
 Receiving B  
 Dock 71  
 201 East Martin St.  
 Orleans, IN 47452

Tag: Dealer Name / Purchase Order #

### General COM Fabric/COL Hide Policy

Refer to the COM/COL Price Columns for list prices.

All yardage requirements listed in the price list are based upon 54" plain non-directional material. Additional yardage may be required based on fabric repeat and matching.

All square footage requirements for COL are based on an average hide size of 50 square feet.

Contact Customer Service for any of the following conditions:

- + approval of COM/COL to be used  
 (see policy on the next page)
- + fabric repeats greater than 3"
- + fabric less than 54" wide
- + leather hides smaller than 50 square feet
- + special application requirements request

When requesting information from Customer Service on COM/COL please supply the following information:

- + model number and quantity of the product the COM/COL will be applied
- + COM/COL textile supplier's name
- + name of pattern and color of the textile
- + any special application request

Customer Service will check the database to see if the textile has already been approved. If there is no record for this particular textile then a Memo Sample will be required.

Send a Memo Sample of the COM/COL  
 (recommended memo be at least 4" x 4")

JSI  
 Attn: COM/COL Approval Department  
 Receiving B  
 Dock 71  
 201 East Martin St.  
 Orleans, IN 47452

JSI takes no responsibility when additional materials must be ordered.

All COM/COL must meet applicable codes and regulations, including TB117-2013. By selecting COM/COL, customer certifies that the material meets such codes. JSI assumes no responsibility for the applicable codes and regulation regarding flammability rating and safety rating of any COM/COL.

JSI will review and test as needed all requests. You will be notified as soon as results are documented by our review personnel. JSI reserves the right to reject any COM/COL on our products. We will provide COM/COL explanation of any unapproved textile whenever possible.

JSI cannot be held responsible for receipt of defective fabrics, as we apply all COM as first quality goods.

We can take no responsibility for tailoring, wear-ability or application of COM/COL textiles. Any warranty claims for the COM/COL Textile materials will fall to the original vendor of the textile, not JSI.

# Textile and Leather Swatch Card Program

## Maharam - M Series Card

### Pattern - Manner

#### Grade - C

##### Colorways

MAN013	Ablaze	MAN020	Parakeet
MAN022	Aquatic	MAN046	Passerine
MAN026	Basin	MAN014	Peel
MAN023	Cottage	MAN003	Porpoise
MAN035	Cruise	MAN048	Roseate
MAN043	Dill	MAN027	Schooner
MAN004	Flint	MAN050	Siltstone
MAN005	Hush	MAN029	Silverpoint
MAN051	Kimono	MAN038	Tidewater
MAN032	Magnetic	MAN052	Valiant
MAN040	Oceanside	MAN033	Woad

### Pattern - Meld

#### Grade - C

##### Colorways

MLD018	Amethyst	MLD020	Magma
MLD026	Bare	MLD041	Mariner
MLD027	Blonde	MLD036	Nordic
MLD009	Bulb	MLD002	Panda
MLD023	Clementine	MLD005	Quill
MLD029	Comet	MLD037	Reef
MLD014	Crater	MLD003	Skyline
MLD017	Fuchsia	MLD011	Stark
MLD007	Grate	MLD035	Waterfall
MLD022	Heat	MLD031	Wild
MLD034	Kale		

### Pattern - Messenger

#### Grade - C

##### Colorways

MES028	Apple	MES16	Ice
MES029	Ash	MES037	Lime
MES13	Azure	MES038	Longspur
MES04	Bayou	MES24	Lumine
MES030	Blanch	MES07	Mao
MES031	Capri	MES12	Nile
MES032	Cassis	MES09	Onyx
MES033	Cherry	MES039	Satsuma
MES10	Cloud	MES040	Snow
MES11	Depth	MES23	Tangelo
MES034	Dipper	MES041	Vireo
MES035	Everglade	MES042	Voyage
MES036	Hunter		

### Pattern - Metric

#### Grade - C

##### Colorways

MTR026	Admiral	MTR013	Lava
MTR020	Alligator	MTR034	Midday
MTR024	Anchor	MTR027	Seaport
MTR012	Cardinal	MTR029	Skate
MTR031	Film	MTR040	Sunny
MTR043	Galah	MTR035	Talisman
MTR030	Hopscotch		

### Pattern - Murmur

#### Grade - C

##### Colorways

MUR010	Baby	MUR002	Harmonica
MUR015	Biome	MUR012	Iceberg
MUR006	Cauldron	MUR019	Ignite
MUR004	Dim	MUR005	Peppercorn
MUR011	Elderberry	MUR008	Rapids
MUR001	Gust	MUR009	Seawater

### Pattern - Muse

#### Grade - C

##### Colorways

MUS004	Ascend	MUS018	Noble
MUS030	Celebrate	MUS029	Poinsetta
MUS007	Clear	MUS019	Pulsar
MUS010	Compass	MUS006	Refresh
MUS001	Crescendo	MUS002	Resonate
MUS016	Frigid	MUS017	Riverbend
MUS013	Goal	MUS003	Runway
MUS012	Grasshopper	MUS031	Spectacle
MUS027	Jovial	MUS028	Theater
MUS014	Mistletoe	MUS023	Vase
MUS026	Neat		

**NOW!**  
Need it.  
JSI Quickship

M Series patterns and colors listed above are available for quickship.

# Textile and Leather Swatch Card Program

## Maharam - Mode

### Pattern - Mode

#### Grade - D

#### Colorways

MOD01 Alder*	MOD08 Clavicle*	MOD17 Jetty*	MOD26 Ominous*	MOD35 Stroll*
MOD02 Angelfish	MOD09 Cottontail	MOD18 Kernes	MOD27 Oriole*	MOD36 Sycamore*
MOD03 Ballpoint	MOD10 Crush*	MOD19 Lemon	MOD28 Oxeye*	MOD37 Talus*
MOD04 Barberry	MOD11 Denim*	MOD20 Lichen	MOD29 Paradise	MOD38 Toile
MOD05 Billygoat*	MOD12 Eucalyptus	MOD21 Lioness	MOD30 Petal*	MOD42 Valley
MOD40 Blush*	MOD13 Goldenrod*	MOD22 Machine*	MOD31 Rust*	MOD39 Vermillion*
MOD41 Bonsai*	MOD14 Henge*	MOD23 Mallard	MOD32 Saltwater*	MOD43 Yucca
MOD06 Carotene	MOD15 Hollow*	MOD24 Marsh	MOD33 Sassafras*	
MOD07 Celtic*	MOD16 Intaglio*	MOD25 Odyssey*	MOD34 Spindle*	

**NOW!**  
Need it.  
JSI Quickship

Select Mode colors, denoted by \* are available on quickship.  
Check availability for all other colors.

## Maharam - Value Reference 6 Card

### Pattern - Brindle

#### Grade - C

#### Colorways

BRN001 Calico	BRN010 Seagrass
BRN003 Torch	BRN012 Aquarium
BRN009 Inland	

### Pattern - Keen

#### Grade - D

#### Colorways

KEE001 Gaur	KEE004 Oatmeal
KEE002 Lock	KEE007 Coyote

### Pattern - Multiply

#### Grade - E

#### Colorways

MUL002 Encore	MUL010 Deep
MUL006 Daze	

### Pattern - Wend

#### Grade - D

#### Colorways

WEN002 Tulle	WEN010 Sigma
WEN008 Midi	WEN011 Riverfront

### Pattern - Caper

#### Grade - E

#### Colorways

CAP006 Note	CAP007 Silverback
-------------	-------------------

### Pattern - Loop

#### Grade - D

#### Colorways

LO0003 Navel	LO0010 Penguin
LO0008 Wildfire	

### Pattern - Spry

#### Grade - D

#### Colorways

SPR003 Fizz	SPR007 Trance
SPR006 Jam	

### Pattern - Conduit

#### Grade - E

#### Colorways

CON003 Nimbus	CON007 Caribbean
CON005 Fawn	CON008 Canal

### Pattern - Lunar

#### Grade - D

#### Colorways

LUN002 Jingle	LUN005 Grace
LUN004 Code	

### Pattern - Trundle

#### Grade - D

#### Colorways

TRU002 Element	TRU008 Wake
TRU003 Ray	TRU011 Magnet
TRU005 Aloe	

**NOW!**  
Need it.  
JSI Quickship

Value Reference 6 patterns and colors listed above are available for quickship.

# Textile and Leather Swatch Card Program

## Momentum - Color Card

### Pattern - Infinity C-Zero

#### Grade - B

##### Colorways

INF01	Aluminum	INF17	Maize
INF02	Aster	INF18	Papaya
INF03	Atoll	INF19	Pewter
INF04	Barley	INF22	Rinse
INF05	Berry	INF24	Sable
INF07	Capri	INF25	Stucco
INF08	Dove	INF26	Terrain
INF10	Graphite	INF30	Vine
INF11	Gull		

### Pattern - Marathon C-Zero

#### Grade - B

##### Colorways

MRN01	Alert	MRN16	Noir
MRN03	Caravel	MRN18	Oz
MRN06	Clove	MRN19	Pinot
MRN07	Curry	MRN20	Pollen
MRN08	Cyan	MRN21	Rain
MRN09	Deep	MRN23	Sprite
MRN10	Flax	MRN24	Storm
MRN12	Foliage	MRN27	Toile
MRN13	Herb	MRN29	Vivacious
MRN15	Marigold		

### Pattern - Millennium C-Zero

#### Grade - B

##### Colorways

MLL02	Amber	MLL20	Plateau
MLL04	Cascade	MLL21	Pool
MLL06	Cerise	MLL22	Pyrite
MLL07	Clean	MLL23	Safari
MLL08	Coastal	MLL24	Sapphire
MLL10	Crisp	MLL25	Spark
MLL11	Electric	MLL26	Steel
MLL17	Onyx	MLL27	Tanzanite
MLL18	Orchid	MLL28	Thrill
MLL19	Peridot	MLL30	Zinc

### Pattern - Odyssey C-Zero

#### Grade - B

##### Colorways

ODY02	Amp	ODY17	Linen
ODY03	Breeze	ODY19	Maritime
ODY06	Cedar	ODY23	Primary
ODY07	Craft	ODY24	Roast
ODY08	Cruise	ODY25	Rue
ODY10	Eggplant	ODY26	Sangria
ODY11	Emerald	ODY27	Skim
ODY12	Fossil	ODY28	Smith
ODY13	Ink	ODY29	Tinge
ODY15	Iris	ODY30	Western

### Pattern - Tradition C-Zero

#### Grade - B

##### Colorways

TRD01	Ash	TRD14	Malbec
TRD02	Branch	TRD16	Mist
TRD03	Class	TRD18	Plated
TRD04	Distant	TRD19	Regal
TRD05	Flirt	TRD21	Soar
TRD06	Fronde	TRD22	Soy
TRD08	Hedge	TRD24	Sprout
TRD09	Hidden	TRD26	Sun
TRD12	Kelly	TRD27	Tango
TRD13	Latte	TRD29	Wash

**NOW!**  
Need it.  
JSI Quickship

Color Card patterns and colors listed above are available for quickship.

# Textile and Leather Swatch Card Program

## Momentum - Everyday Solutions III Card

### Pattern - Bangle

Grade - A

Colorways

BAN01	Baltic	BAN05	Sable
BAN02	Cork	BAN06	Suede
BAN03	Granite	BAN07	Teak
BAN04	Orchid		

### Pattern - Bobby

Grade - B

Colorways

BOB01	Anchor	BOB05	Iris
BOB02	Aqua	BOB06	Lemon
BOB03	Fuchsia	BOB07	Moss
BOB04	Glow		

### Pattern - Canter EPU

Grade - C

Colorways

CNR35	Folkstone Grey	CNR11	Safari
CNR19	Ink	CNR09	Sable
CNR20	Iron	CNR12	Sand
CNR08	Onyx		

### Pattern - Dart

Grade - B

Colorways

DAR01	Ash	DAR05	Geode
DAR02	Cadet	DAR06	Ink
DAR03	Carmine	DAR07	Slate
DAR04	Ebony		

### Pattern - Free

Grade - C

Colorways

FRE01	Cocoa	FRE05	Orbit
FRE02	Evening	FRE06	Pearl
FRE03	Graphite	FRE07	Platinum
FRE04	Oasis		

### Pattern - Fuse

Grade - A

Colorways

FUS11	Azurean	FUS07	Pepper
FUS01	Carmine	FUS13	Pristine
FUS02	Cress	FUS10	Walnut
FUS04	Lunar		

### Pattern - Graph

Grade - B

Colorways

GRA01	Alpine	GRA05	Parrot
GRA08	Anchor	GRA06	Ruby
GRA02	Chalice	GRA09	Wave
GRA03	Coal		

### Pattern - Guild

Grade - A

Colorways

GLD01	Celadon	GLD05	London
GLD02	Cyan	GLD06	Mandarin
GLD03	Earthen	GLD07	Shale
GLD04	Ink		

### Pattern - Insight

Grade - A

Colorways

INS07	Ebony	INS10	Real Red
INS08	Fossil	INS03	Summit
INS06	Midnight	INS012	Wasabi
INS09	Periwinkle		

### Pattern - Knack

Grade - C

Colorways

KNA05	Brisk	KNA01	Reed
KNA06	Carbon	KNA02	Teak
KNA08	Filament	KNA13	Zing
KNA09	Fresco		

### Pattern - Lens

Grade - C

Colorways

LEN01	Crimson	LEN04	Sand
LEN02	Graphite	LEN05	Silver
LEN03	Navy	LEN07	Terra
LEN06	Night		

### Pattern - Origin

Grade - A

Colorways

ORG20	Euro	ORG07	Iron
ORG22	Gaia	ORG08	Jet
ORG05	Garnet	ORG26	Poppy
ORG06	Indigo		

### Pattern - Parenthesis

Grade - A

Colorways

PAR01	Capri	PAR07	Mercury
PAR05	Charcoal	PAR03	Steel
PAR06	Ink	PAR04	Violet
PAR02	Lime		

### Pattern - Skip

Grade - C

Colorways

SKP01	Chalk	SKP09	Ruby
SKP04	Nickel	SKP06	Sprite
SKP08	Onyx	SKP07	Yacht
SKP05	Pool		

### Pattern - Slice

Grade - B

Colorways

SLI01	Admiral	SLI04	Miller
SLI02	Charcoal	SLI05	Pumice
SLI06	Graphite	SLI07	Slate
SLI03	Henna		

# Textile and Leather Swatch Card Program

## Momentum - Inspired Crypton Performance Card

### Pattern - Cover Cloth

#### Grade - C

##### Colorways

CVR02	Cyan	CVR08	Platinum
CVR03	Delft	CVR10	Sorrel
CVR04	Graphite	CVR17	Vesper
CVR14	Indigo	CVR12	Vessel
CVR06	Jet	CVR13	Zest
CVR07	Oat		

### Pattern - Faux Felt

#### Grade - D

##### Colorways

FXF08	Charcoal	FXF04	Pool
FXF09	Coral	FXF05	Quail
FXF02	Flannel	FXF06	Sprout
FXF10	Graphite	FXF07	Stone
FXF11	Lagoon	FXF13	Vibrant
FXF12	Pebble		

### Pattern - Flock

#### Grade - D

##### Colorways

FLC01	Amber	FLC07	Harp
FLC02	Baltic	FLC11	Lapis
FLC03	Cayman	FLC08	Nickel
FLC04	Dusk	FLC09	Paprika
FLC05	Fern	FLC10	Twine
FLC06	Flint		

### Pattern - Hobnob

#### Grade - D

##### Colorways

HOB01	Ash	HOB06	Iris
HOB02	Bay	HOB13	Limon
HOB03	Carbon	HOB07	Shale
HOB11	Depth	HOB08	Smith
HOB04	Dew	HOB09	Tangelo
HOB12	Forest	HOB14	Teal
HOB05	Ginger	HOB10	Zebra

### Pattern - Keynote

#### Grade - D

##### Colorways

KYN04	Chai	KYN05	Reflect
KYN01	Granite		

### Pattern - Solitaire

#### Grade - C

##### Colorways

SOL15	Aztec	SOL08	Griffin
SOL01	Cadet	SOL09	Jubilee
SOL02	Currant	SOL10	Midnight
SOL03	Cyan	SOL11	Onyx
SOL04	Dove	SOL12	Pumice
SOL05	Flax	SOL13	Tinsel
SOL06	Galena	SOL14	Tobacco
SOL07	Graphite		

### Pattern - Kit

#### Grade - D

##### Colorways

KIT01	Aqua	KIT06	Moonstone
KIT02	Blazer	KIT07	Pacific
KIT03	Earth	KIT08	Paradise
KIT04	Ebony	KIT09	Pebble
KIT05	Fiesta	KIT10	Quartz
KIT11	Mocha		

### Pattern - Oath

#### Grade - D

##### Colorways

OTH01	Azure	OTH03	Juniper
OTH02	Charcoal		

### Pattern - Synergy

#### Grade - D

##### Colorways

SGY01	Aegean	SGY03	Carbon
SGY02	Bedrock	SGY04	Denim

### Pattern - Sport

#### Grade - D

##### Colorways

SPT01	Alarm	SPT11	Mercury
SPT02	Apple	SPT08	Onyx
SPT03	Brick	SPT09	Pewter
SPT04	Cadet	SPT12	Pumice
SPT05	Cobalt	SPT13	Spa
SPT06	Dayglow	SPT10	Turquoise
SPT07	Flax		

**NOW!**  
Need it.  
JSI Quickship

Inspired Crypton Performance patterns and colors listed above are available for quickship.

# Textile and Leather Swatch Card Program

## Momentum - Midday Solutions II Card

### Pattern - Amuse

#### Grade - C

##### Colorways

AMU01	Admiral	AMU05	Poppy
AMU02	Alloy	AMU04	Quartz
AMU03	Mocha		

### Pattern - Boom II

#### Grade - C

##### Colorways

BOM14	Cloud	BOM06	Mushroom
BOM15	Foliage	BOM19	Toucan
BOM18	Pewter	BOM20	Wall Street

### Pattern - Habit

#### Grade - B

##### Colorways

HAB01	Aspen	HAB04	Pier
HAB05	Blueprint	HAB06	Salt
HAB02	Dune	HAB07	Tailor
HAB03	Kindle		

### Pattern - Otto

#### Grade - D

##### Colorways

OTT01	Alarm	OTT08	Midas
OTT02	Alloy	OTT09	Mineral
OTT03	Cyprus	OTT10	Pumice
OTT04	Driftwood	OTT11	Seed
OTT05	Flint	OTT12	Slate
OTT06	Grotto	OTT13	Vivid
OTT07	Gulf		

### Pattern - Stroll

#### Grade - D

##### Colorways

STO01	Alert	STO05	Parchment
STO02	Flax	STO06	Silver
STO03	Grotto	STO07	Steinway
STO04	Nitro		

### Pattern - Beep

#### Grade - D

##### Colorways

BEP01	Bridge	BEP04	Pontoon
BEP03	Greenlight	BEP05	Steel
BEP06	Jet		

### Pattern - Bravo II

#### Grade - D

##### Colorways

BRV19	Black	BRV13	Mica
BRV20	Cinder	BRV15	Night
BRV12	Dusk	BRV07	Saddle
BRV25	Graystone		

### Pattern - Lineup

#### Grade - B

##### Colorways

LUP01	Baltic	LUP05	Shadow
LUP02	Fern	LUP06	Spice
LUP03	Pewter	LUP07	Tranquil
LUP04	Sandstone		

### Pattern - Pip

#### Grade - D

##### Colorways

PIP01	Anise	PIP09	Malachite
PIP02	Calico	PIP10	Pepper
PIP03	Calypso	PIP11	Pewter
PIP04	Chalice	PIP07	Rune
PIP05	Crimson	PIP12	Turrent
PIP06	Dusk	PIP13	Yacht
PIP08	Lake	PIP14	Zest

### Pattern - Tanner

#### Grade - C

##### Colorways

TAN01	Black	TAN05	Nickel
TAN02	Bonsai	TAN06	Sapphire
TAN03	Lagoon	TAN07	Tint
TAN04	Natural		

### Pattern - Beta

#### Grade - D

##### Colorways

BET01	Bark	BET09	Koi
BET02	Basalt	BET10	Lapis
BET03	Cadet	BET11	Madder
BET04	Cassis	BET12	Malt
BET05	Cinder	BET13	Pearl
BET06	Crater	BET14	Sand
BET07	Deck	BET15	Twine
BET08	Ivy		

### Pattern - Faux Felt

#### Grade - D

##### Colorways

FXF01	Bark	FXF06	Sprout
FXF02	Flannel	FXF07	Stone
FXF12	Pebble	FXF13	Vibrant
FXF03	Pool		

### Pattern - Solace

#### Grade - C

##### Colorways

SOC02	Azul	SOC13	Lapis
SOC09	Fossil	SOC16	Nickel
SOC10	Glided	SOC18	Pear
SOC12	Ivory		

### Pattern - Toggle

#### Grade - C

##### Colorways

TOG01	Agave	TOG05	Lead
TOG02	Flint	TOG06	Punch
TOG03	Iron	TOG07	Quarry
TOG04	Lapis		



# Textile and Leather Swatch Card Program

## Momentum - PVC Free Coated Solutions Card

### Pattern - Beeline EPU

#### Grade - C

##### Colorways

BEL01	Canvas	BEL18	Oat
BEL02	Cork	BEL09	Oriole
BEL03	Eclipse	BEL11	Portobello
BEL04	Eucalyptus	BEL12	Sisal
BEL05	Forge	BEL13	Sprout
BEL06	Fossil	BEL14	Sundance
BEL07	Geyser	BEL15	Tidal
BEL19	Jetty	BEL21	Valley
BEL20	Lake	BEL16	Walnut
BEL08	Nimbus		

### Pattern - Canter EPU

#### Grade - C

##### Colorways

CNR01	Alfalfa	CNR08	Onyx
CNR14	Ballad	CNR25	Quarry
CNR16	Basalt	CNR09	Sable
CNR03	Bordeaux	CNR10	Saddle
CNR17	Brazen	CNR11	Safari
CNR05	Earth	CNR12	Sand
CNR19	Ink	CNR26	Storm
CNR20	Iron	CNR27	Sumac
CNR07	Night	CNR37	Summer White
CNR23	Nimbus		

### Pattern - Endurance EPU

#### Grade - C

##### Colorways

END01	Bisque	END11	Neptune
END02	Bluebell	END12	Noir
END03	Cascade	END13	Nordic
END04	Dove	END14	Paprika
END05	Gravel	END15	Seed
END06	Gull	END16	Smith
END07	Heather	END17	Taupe
END08	Ink	END18	Tobacco
END09	Java	END19	Toffee
END10	Jetty		

### Pattern - Eon EPU

#### Grade - C

##### Colorways

EON16	Anew	EON11	Grove
EON08	Arena	EON12	Hydra
EON09	Ascension	EON13	Mineral
EON17	Atlantic	EON04	Mystery
EON18	Blaze	EON05	Nocturnal
EON10	Coquette	EON06	Omega
EON19	Cove	EON07	Path
EON20	Fire	EON21	Spring
EON01	Freshwater	EON15	Typographic
EON02	Goldmine		

### Pattern - Groove EPU

#### Grade - C

##### Colorways

GRV01	Archive	GRV16	Intense
GRV02	Beach	GRV09	Khaki
GRV03	Calm	GRV17	Maize
GRV04	Demure	GRV10	Polar
GRV14	Digital	GRV18	Seed
GRV15	Ember	GRV11	Stone
GRV05	Expanse	GRV12	Surplus
GRV06	Glacier	GRV13	Vapor
GRV07	Guide	GRV19	Zest
GRV08	Harbor		

### Pattern - Silica

#### Grade - F

##### Colorways

SIL01	Alloy	SIL23	Manor
SIL02	Appletini	SIL24	Marigold
SIL05	Breakwater	SIL43	Nero
SIL07	Brownstone	SIL39	Petunia
SIL10	Cloak	SIL40	Quartz
SIL12	Cumulus	SIL41	Sands
SIL13	Dare	SIL44	Seacoast
SIL42	Eclipse	SIL34	Terra
SIL15	Gallant	SIL35	Tropic
SIL20	Haze		

### Pattern - Silica Leather

#### Grade - F

##### Colorways

SLL01	Almond	SLL10	Ink
SLL02	Aloe	SLL11	Juniper
SLL03	Barley	SLL12	Lichen
SLL04	Chambray	SLL20	Marigold
SLL19	Denim	SLL17	Mink
SLL18	Dove	SLL14	Pewter
SLL05	Driftwood	SLL16	Saddle
SLL06	Dune	SLL21	Shadow
SLL08	Eclipse	SLL22	Umber
SLL09	Hyacinth		

### Pattern - Silica Triad

#### Grade - F

##### Colorways

SLD01	Brew	SLD11	Luster
SLD02	Bronze	SLD12	Mood
SLD03	Char	SLD13	Orchid
SLD04	Conceal	SLD14	Remote
SLD05	Crest	SLD15	Settle
SLD06	Everglade	SLD16	Smoke
SLD07	Heat	SLD17	Sonar
SLD08	Heron	SLD18	Stark
SLD09	Hover	SLD19	Zing
SLD10	Lazuli		

### Pattern - Whit EPU

#### Grade - D

##### Colorways

WHT01	Blush	WHT11	Madder
WHT02	Cane	WHT12	Nightfall
WHT03	Castle	WHT13	Ocean
WHT04	Delft	WHT14	Path
WHT05	Driftwood	WHT15	Platinum
WHT06	Fable	WHT16	Smith
WHT07	Flint	WHT17	Storm
WHT08	Humble	WHT18	Verbena
WHT09	Inland	WHT19	Zephyr
WHT10	Jet		

**NOW!**  
Need it.  
JSI Quickship

PVC Free Coated Solutions patterns and colors listed above are available for quickship.

# Textile and Leather Swatch Card Program

## Spradling - Coated Solution - Vinyls by Spradling

### Pattern - Edgeline

#### Grade - C

##### Colorways

EDG1857	Atlantic	EDG1866	Jasper
EDG1860	Aubergine	EDG1865	Latte
EDG1862	Autumn	EDG1859	Midnight
EDG1868	Caramel	EDG1867	Mustard
EDG1872	Charcoal	EDG1856	Olive
EDG1853	Clover	EDG1852	Peacock
EDG1864	Crimson	EDG1870	Pewter
EDG1854	Emerald	EDG1858	Royal
EDG1869	Espresso	EDG1861	Ruby
EDG1851	Fullmoon	EDG1863	Sangria
EDG1871	Graphite	EDG1855	Storm

### Pattern - Maglia

#### Grade - C

##### Colorways

MAG1956	Aegean	MAG1964	Rose
MAG1967	Alaska	MAG1954	Sage
MAG1958	Aqua	MAG1952	Sapphire
MAG1962	Clay	MAG1957	Sky
MAG1963	Coral	MAG1968	Thunder*
MAG1951	Desert	MAG1966	Truffle
MAG1965	Driftwood	MAG1953	Vanilla
MAG1961	Goldenrod	MAG1955	Viridian
MAG1959	Indigo	MAG1960	Wisteria

### Pattern - Silvertex

#### Grade - C

##### Colorways

STX8834	Acid	STX8811	Mandarin
STX8820	Basil	STX8801	Marine Blue
STX8837	Bazaar	STX8824	Meteor
STX8817	Blackberry	STX8825	Mocha
STX8823	Carbon*	STX8839	Plata
STX8819	Celery	STX8818	Sage
STX8808	Champagne	STX8804	Sapphire*
STX8833	Creme de Menthe	STX8840	Sterling*
STX8805	Jet	STX8822	Storm
STX8802	Lagoon	STX8809	Taupe
STX8842	Limoncello	STX8803	Turquoise

### Pattern - Whisper

#### Grade - B

##### Colorways

WHI2120	Antelope	WHI2150	Fawn
WHI2140	Black*	WHI2157	Fog
WHI2117	Bone	WHI2129	Forest
WHI2118	Camel	WHI2163	Indigo
WHI2121	Cappuccino	WHI2123	Luggage
WHI2141	Cashew	WHI2165	Molten
WHI2136	Cerulean	WHI2137	Navy
WHI2139	Charcoal	WHI2162	Paradise
WHI2142	Cognac	WHI2134	Patina
WHI2138	Elephant*	WHI2154	Pewter*
WHI2143	Espresso	WHI2155	Storm

**NOW!**  
Need it.  
JSI Quickship

Select Coated Solutions colors, denoted by \* are available on quickship.  
Check availability for all other colors.

## Stinson - Lara Card

### Pattern - Lara

#### Grade - B

##### Colorways

LRA81	Athens	LRA86	Gate	LRA83	Minty	LRA61	Salsa	LRA82	Titanium
LRA90	Bahama	LRA87	Haze	LRA57	Miso	LRA103	Sherwood	LRA95	Tranquil
LRA97	Barista	LRA96	Hearth	LRA105	Mystery	LRA66	Spice	LRA76	Velvet
LRA78	Barre	LRA88	Hydro	LRA94	Patriot	LRA50	Stone	LRA68	Vicuna
LRA84	Blue Ice	LRA106	Java	LRA64	Pear	LRA67	Tamale	LRA100	Wizard
LRA52	Blush	LRA91	Kitten	LRA107	Pitch	LRA69	Taupe		
LRA70	Cashew	LRA85	Lake	LRA71	Plum	LRA75	Tawny		
LRA89	Champion	LRA65	Marigold	LRA72	Port	LRA101	Tempest		
LRA102	Espresso	LRA99	Mid-Blue	LRA73	Pumice	LRA74	Timberland		
LRA104	Evening	LRA92	Mink	LRA62	Red Earth	LRA80	Tint		

**NOW!**  
Need it.  
JSI Quickship

Lara patterns and colors listed above are available for quickship.

# Textile and Leather Swatch Card Program

## Ultrafabrics 2020 Card

### Pattern - Brisa | Original Grade - E

#### Colorways

BRI34 Ash*	BRI46 Evening Blue
BRI37 Bark	BRI47 Ginger
BRI31 Birch	BRI48 Mineral
BRI21 Black Onyx*	BRI49 New Sand
BRI20 Cabernet	BRI12 Night Navy
BRI35 Cambridge Blue	BRI15 Sage
BRI18 Canyon	BRI17 Truffle*
BRI44 Caramel	BRI24 White*
BRI23 Celery	BRI50 Wishbone
BRI45 Cinnabar	BRI51 Wrought Iron

### Pattern - Ultraleather Promessa Grade - E

#### Colorways

PME14 Ash	PME18 Horsehair
PME15 Aspen Green	PME02 Parchment*
PME01 Atlantic	PME19 Snow
PME16 Battleship	PME20 Sun Shower
PME05 Bronze	PME21 Tusk
PME17 Corn Flour	PME22 Woodpecker
PME08 Dogwood	

### Pattern - Brisa | Distressed Grade - E

#### Colorways

BDS03 Buckskin	BDS14 Navajo Ivory
BDS12 Coyote	BDS15 Railroad
BDS13 Moccasin	BDS11 Shield

### Pattern - Ultraleather Tottori Grade - E

#### Colorways

TOT01 Black Sesame*	TOT08 Rice Paper
TOT02 Blue Mirage	TOT09 Rouge
TOT03 Desert Dune	TOT10 Sand Castle
TOT04 Ginseng*	TOT11 Shibori Blue
TOT05 Hot Spring	TOT12 Soy Sauce
TOT06 Lichen*	TOT13 Udon
TOT07 Orchid	

### Pattern - Ultraleather Pro Grade - F

#### Colorways

ULP01 Blueberry	ULP16 Mortar
ULP02 Campfire*	ULP08 Parfait
ULP03 Char	ULP17 Sailor
ULP05 Cloud*	ULP18 Swan
ULP06 Coastal*	ULP12 White Wash*
ULP14 Cork*	ULP13 Woodcres
ULP15 Dark Chocolate	

**NOW!**  
Need it.  
JSI Quickship

Select Ultrafabrics 2020 colors, denoted by \* are available on quickship.  
Check availability for all other colors.

## Cortina - Davenport Leather Card

### Pattern - Davenport Grade - L1

#### Colorways

DAV9968 Aluminum	DAV1112 Black*	DAV9969 Evergreen	DAV9945 Rosewood
DAV9202 Amethyst	DAV1097 Brown	DAV4536 Fog*	DAV9788 Saddle
DAV7378 Atlantis*	DAV7835 Camel	DAV9970 Mist	DAV7579 Smoke
DAV7800 Austin	DAV8774 Chamois	DAV9967 Nutmeg	DAV9203 Spring
DAV8548 Bark	DAV9204 Copper	DAV8554 Olive*	DAV8779 Storm
DAV9206 Bayview	DAV8979 Cream	DAV4536 Plum	DAV8787 Tomato
DAV9201 Berry	DAV7298 Dusk	DAV7574 Porcellana	DAV7349 Wet Sand*
DAV7153 Bittersweet*	DAV7568 Earthy*	DAV9966 Powder*	DAV7582 Yonder

**NOW!**  
Need it.  
JSI Quickship

Select Cortina - Davenport Leather colors, denoted by \* are available on quickship.  
Check availability for all other colors.

## Cortina - Caprone + Old English Leather Card

### Pattern - Caprone Grade - L2

#### Colorways

CPN004 Acorn	CPN073 Koala
CPN032 Blueberry	CPN089 Laguna
CPN111 Bright White	CPN007 Maple
CPN027 Cloud	CPN071 Persimmon
CPN034 Cocoa	CPN092 Picholine
CPN039 Ebony	CPN016 Plum
CPN010 Glove	CPN037 Seal
CPN012 Gunmetal	CPN082 Stucco
CPN044 Heron	CPN087 Sublime
CPN030 Holly	CPN088 Tiffany
CPN030 It's A Boy	

### Pattern - Old English Grade - L2

#### Colorways

COA0096 Black	COA1572 Medium Blue
COA1520 Blackberry	COA1649 Navy
COA1263 Brown	COA1500 Rouge
COA7949 Camel	COA3144 Walnut
COA9887 Grey	

## Arc Com Fabric Grading

For memo samples order online at [www.arc-com.com](http://www.arc-com.com) or call Arc-Com at 800-223-5466Grades and availability of fabric are subject to change without notice. Changes could include but are not limited to price increases, discontinued patterns, discontinued colors, etc. See [jsifurniture.com](http://jsifurniture.com) for updated information.

Pattern	Grade	Pattern	Grade	Pattern	Grade
Aberdeen *	J	Harlequin	I	Quest	H
Alpha	E	High Rise	J	Radius	H
Ambiance	D	Highlands *	G	Raya	G
Apex	H	Hush	F	Reality Check	G
Apollo	E	Illusion	D	Rodeo	D
Arabesque	G	Illusion 2	D	Rodeo 2	D
Arashi	H	Insight	D	Rogue *	F
Around	G	Intaglio	F	Roundabout	F
Astor	F	Intaglio 2	F	Santa Fe	F
Atomic	I	Intersect*	F	Santorini	G
Axis	F	Interstate	F	Saxon	G
Bali	I	Iona	F	Sea Willow	J
Block Petal	I	Isabella	E	Sector	G
Boardwalk	F	Itajime	H	Sherlock	E
Bocce	H	Jive	G	Sherlock 2	E
Bronco	F	Journey	F	Shimmer	E
Burkina	H	Kaolin	E	Shimmer 2	E
Cadence	F	Katano	G	Silverado	E
Carnival	F	Key	G	Silverado 2	E
Cavo	G	Kinetic	H	Skye	G
Centring Stripe	H	Kirigami	G	Soho	D
Channel	E	Kuba	I	Solitude	F
Chroma	E	Kumo	G	Sonata Stripe	H
Cirque	H	Legacy	F	Sonic	F
Column	F	Legend	F	Spectrum	E
Compass	J	Linea	F	Speedway	G
Contour	F	Loara	H	Spin	H
Cosmos	G	Lore	F	Spinnaker	H
Crescendo	H	Lunette	J	Spirit	E
Dakota*	E	Luxe	G	Square One	I
Dakota 2	E	Lyre	F	Staccato	J
Daytona	H	Lyric	H	Stallion	C
Dazzle	H	Majorca	G	Strata	E
Delphi	E	Marathon	F	Streamline	F
Delta*	E	Marquee	G	Sukhala	I
Drifter	D	Mason	G	Sundial	H
Durango*	D	Mason Stripe	G	Sync	F
Dynasty	F	Meadow	H	Tailored	F
Eden	J	Mesa	E	Talavera	J
Elementary	I	Mirror, Mirror	H	Tally	F
Elevado	F	Montage	J	Tectonic *	G
Emerson	D	Moon Beam*	F	The Plaid	J
Empress *	E	Moon Beam 2	F	Theory	C
Encore	D	Morgan	F	Tick-Tock	G
Engrave	F	Nahouri	I	Transform	C
Etch	E	Navigator	G	Traverse	G
Evolution	H	Network	I	Vault	I
Fiji	E	Oculus	F	Venture	I
Fragment	I	Odyssey	F	Victoria	G
Francesca Wool*	H	Ombre Petal	H	Watson	D
Francesca Wool 2*	H	Omega	E		
Frontier*	D	Palatine*	F		
Galaxy	H	Palatine 2*	F		
Gamma	E	Paragon	I		
Gardenia	G	Paxton	G		
Gatsby	E	Perspective	H		
Gem	E	Plateau*	F		
Geostitch	H	Polished	F		
Gianni	H	Polo	G		
Glam	E	Posh*	G		
Glo	F	Primavera	G		
Great Wall	G	Prism	D		

Effective October 22, 2021

## Designtex Fabric Grading

For memo samples order online at [www.designtex.com](http://www.designtex.com) or call Designtex at 800-221-1540

Grades and availability of fabric are subject to change without notice. Changes could include but are not limited to price increases, discontinued patterns, discontinued colors, etc. See [jsifurniture.com](http://jsifurniture.com) for updated information.

Pattern	Grade	Pattern	Grade	Pattern	Grade
Acacia	H	Geometric II	J	Raia	J
Adler	F	Gleam	G	Rainwater	I
Alcazar	E	Glimmer	F	Reppweave	E
Aloft	F	Gridley	D	Revelry	G
Annex	F	Hashtag	E	Rider	F
Appleseed	G	Heather	G	Rise	E
Arne	E	Hint	F	Rocket	D
Aspect	D	Holmes	H	Rodenbach	I
Atria	H	Hyde	D	Rotary	J
Bark Cloth	F	Hyphen	F	Rove	H
Big Dot	G	Ink	I	Samba	H
Big Texture	G	Interlock	H	Scale	F
Billiard Cloth	F	Interlude	I	Schism	F
Birdseye	D	Iota	E	Segment	I
Bixby Macro	I	Jaunt	I	Shortcut	I
Bixby Micro	H	Josef *	G	Silicone Element	G
Boucle	G	Jumper	I	Silicone Element	H
Boucle Dot	G	Kami	I	Celliant	H
Boucle Melange	H	Keen *	G	Silicone Nappa	G
Brushed Flannel	E	Kindred	H	Sketch	I
Building Blocks	I	Kith	E	Sorano	E
Bunta	G	Lambert	I	Span	E
Burlap Weave	F	Latitude	I	Spandau	E
Burrard *	I	Lattice	H	Splice	F
Burrard Ground Cloth	G	Leap	G	Split	F
Bute Braemar *	J	Linen Like *	F	Sprint	H
Bute Melrose *	J	Linnen	F	Standard	H
Bute Tweed	I	Little Dot	G	Starburst	I
Carom	I	Loop To Loop	H	Stratum	I
Carrick	J	Lumi	I	Stride	E
Chapiteau	F	Luster	G	Subtle	F
Chenille Chevron	J	Mark	E	Symbol	J
Chunky Tweed	H	Mateo	F	System	F
Clad Celliant	E	Measure	F	Tack Cloth	G
Cloud Velvet *	E	Melange	E	Tap	H
Code	G	Metallo	F	Terra	F
Collier	F	Metta	E	Tilt	J
Colten	F	Microgrid	F	Tiny Boucle	F
Corded	H	Migration	I	Tiny Herringbone	F
Course	I	Minnie	D	Tramway	I
Crossweave	E	Mod	H	Treeline	I
Crosswind	G	Mohair Plus	J	Trim	I
Cubitt	I	Motif	H	Trove	E
Current	G	Mountainous	I	Tumbleweed	G
Dapple	H	Nest	F	Tweed Multi	E
Dart	H	Nook	E	Ulster 4149	C
Delaine	F	Opulent	E	Ulster Upholstery	D
Distressed Texture	G	Pause	F	3957	D
Double Weave	I	Pave *	H	Union Cloth	F
Draft	H	Pennant	J	Upholstery	F
Drift *	F	Pennant Celliant	J	Velvet Corduroy	I
Ellipsis*	D	Pennington	J	Vero	F
Encircle	J	Phenomena	H	Viewpoint	I
Everywhere Texture	F	Pigment	H	Vine	I
Felt 2MM	J	Pika	E	W	F
Flow	J	Pinball	I	Wend	E
Fluent	H	Pinpoint	H	Whim	F
Fomo	F	Pivot	F	Willis	I
Forestbound	F	Plaid	I	Windowpane	F
Gale	F	Plus	I	Crypton	F
Gamut	D	Prime *	D	Woolish	D
Gamut Celliant	E	Queue	I		

# Maharam Fabric Grading

For memo samples order online at [www.maharam.com](http://www.maharam.com) or call Maharam at 800-645-3943

Grades and availability of fabric are subject to change without notice. Changes could include but are not limited to price increases, discontinued patterns, discontinued colors, etc. See [jsifurniture.com](http://jsifurniture.com) for updated information.

<u>Pattern</u>	<u>Grade</u>	<u>Pattern</u>	<u>Grade</u>	<u>Pattern</u>	<u>Grade</u>
Across	H	Flurry	I	Rail	J
Albemarle	J	Frequency	G	Regatta	J
Ample	H	Gallant	F	Relay	I
Amulet	J	Gild	F	Rill	F
Anagram	I	Glen	E	Roster	E
Apt	G	Grade	I	Rule	H
Arabesque	J	Grove	H	Runner	H
Aria	J	Gust	F	Runner Standard	F
Article	E	Hearth	H	Scope	J
Beacon	H	Houndstooth	J	Scuba	F
Beryl	F	Instill	F	Scuttle	G
Bind	I	Keen	D	Sandal	F
Bluff	F	Lariat	E	Sequence	G
Boundary	G	Lea	H	Serried	J
Bright Angle	I	Lean	G	Shadow	G
Bright Cube	I	Ledger	F	Sheen	F
Bright Grid	H	Lens	G	Shift	H
Brindle	C	Levity	F	Shuttle Standard	F
Brio	H	Lift	I	Sift	I
Buffer	H	Limn	J	Skein	F
Bureau	E	Linden	H	Soft Tweed	I
Bushel	F	Lineage	G	Span	H
Candid	E	Link	H	Splay	G
Caper	E	Lithe	G	Spry	D
Chalet	G	Loop	D	Stature	F
Chasm	F	Lunar	D	Strum	F
Chassis	F	Manner	C	Sudden	F
Checker	J	Mantle	E	Sundry	H
Checker Split	J	Marquee	F	Switch	F
Circles by Charles and Ray Earnes	J	Medium	D	Swivel	H
Circuit	H	Melange Tweed	J	Taut Linen	J
Coach Cloth	J	Meld	C	Teatro	H
Coast	G	Merit	D	Tempera	H
Coin Crypton	G	Mesh	H	Tend	I
Coincide	F	Messenger	C	Ticker	H
Colorwheel	J	Metric	C	Tilt	H
Compound	F	Micro	E	Tracery	H
Conduit	E	Mikado	J	Trellis	J
Cosset	F	Milestone	D	Trundle	D
Cove	I	Mimic	G	Unisol	J
Crosspatch	J	Minicheck	J	Valor	I
Cursive	J	Mister	I	Vases	J
Cycle	F	Mode	D	Veer	E
Design 9297	J	Multiply	E	Vineyard	J
Disc	F	Murmur	C	Waver	F
Dots	F	Muse	C	Wend	D
Double Triangles	J	Nimble	F	Wide Corduroy	J
Dwell	D	Offset	I	Willow	H
Edges by Alexander Girard	J	Optik	J	Wool Rib	I
Ellipsis	I	Orakelblume	J	Wrap	J
Emit	E	Orbit	E		
Enmesh	G	Pallet	D		
Entwine	H	Pepper	F		
Equate	G	Pick	E		
Exchange	F	Pick Crypton	G		
Facets	J	Pinnacle	H		
Fathom	G	Pitch	F		
Feature	H	Pocket	H		
Festoon	J	Prime	G		
Flint	J	Prompt	F		
		Province	F		
		Queue	H		

Effective April 1, 2021

# Mayer Fabric Grading

For memo samples order online at [www.mayerfabrics.com](http://www.mayerfabrics.com) or call Mayer at 800-428-4415.

Grades and availability of fabric are subject to change without notice. Changes could include but are not limited to price increases, discontinued patterns, discontinued colors, etc. See [jsifurniture.com](http://jsifurniture.com) for updated information.

INFORMATION

Pattern	Grade	Pattern	Grade	Pattern	Grade	Pattern	Grade	Pattern	Grade
Abbey	D	Ecosphere	G	Laser	C	Quattro	B	Volante	H
Abstract	G	Elevation	F	Latitude	E	Ranchero	B	Voyager	E
Acclaim	D	Engrave	C	Lavish	D	Reflector	F	Wallaby SP Black	A
Acuco	G	Entwine	D	Links	D	Refuge	E	Whirligig	I
Align	C	Ephesus	G	London	F	Rejuvenate	G	Whirlwind	D
All Seasons	C	Equal	B	Longhorn	D	Relativity	F	Wildflower	H
Amadeus	G	Essence	D	Longitude	E	Replay	E	Wilson	H
Ankara	F	Etch	C	Lotus	H	Reveal	D	Wool Boucle	G
Antique	D	Evolve	H	Luminary	B	Reverb	C	Wool Felt	E
Apollo Silicone	F	Facets	E	Madras	D	Rift	D	Wool Heather	E
Arabesque	D	Fanfare	H	Madrid SP Black	A	Rumba	B	Xanadu	G
Aristocrat	D	Fedora	C	Malibu	D	Samba	C	Zazen	G
Array	E	Fiji	C	Mandala	I	Samurai	F	Zen	G
Ascension	F	Finale	D	Marathon II	A	Saori	H	Zest	C
Avenue	F	Flair	C	Marmara	F	Score	E		
Balance	F	Florentino	C	Matka	D	Sequel	C		
Bali	C	Form	E	Matter	E	Sequel Plus Nanoguard	D		
Basic	A	Forte	A	Maverick	C	Sequence	D		
Batik	C	Fortune	D	Mayfair	F	Shantung	E		
Blueprint	B	Foundation 10	C	Meander	D	Sherlock	C		
Boardwalk	F	Fresco	B	Melange	D	Sierra Sp Black	A		
Bolero	D	Fretwork	G	Metal Strips	G	Signs	H		
Boro	H	Function	D	Micro Dot	C	Silk Screen	D		
Botanica	F	Gala	F	Midway	C	Silverweave	D		
Botany	F	Galveston	D	Milagro	H	Sketch	C		
Boteh	J	Gatsby	D	Milano	D	Slick	C		
Caressa	C	Geisha	H	Mingle	D	Social Network	E		
Carousel	J	Gem	C	Mode	D	Soho	E		
Cascade	D	Genesis	C	Molecule	F	Soleil	F		
Catwalk	E	Genesis Plus	D	Monogram	D	Sophisticate	D		
Channel	D	Nanoguard	D	Moonscape	C	Space Odyssey	C		
Chaps	C	Graph	B	Mosaic	D	Spacer Mesh	C		
Charette	E	Grasscloth	C	Mosaic Plus Nanoguard	E	Special Black	A		
Chequers	E	Gravity	E	Multi-Crepe	B	Spectre	D		
Cipher	B	Gridline	D	Neo	D	Splendor	E		
Circuit	H	Groundworks	F	Nexus	C	Spokes	I		
Circumference	G	Haarlem	G	Niche	E	Static	F		
Cirque	E	Haberdash	C	Nirvana	G	Stellar	C		
Code	B	Habitat	B	Noble	C	Strata	C		
Collage	G	Havana	C	Nomad	E	Sula	H		
Comalapa	G	Hexagon	D	Nostalgia	D	Suna	G		
Contempo	C	Holiday	F	Nylon-Stat ESD	F	Sutra	G		
Continuum 10	C	Huipil	F	Obi	F	Sydney	B		
Copa	B	Images	D	Obsession	F	Synapse	G		
Cosmopolitan	D	Imprint	C	Odessa	F	Tango	C		
Cross Check	B	Infinity	G	Optic 10	C	Tattersall	F		
Cube	C	Interlace	D	Outback	C	Textura	F		
Cuddle Up	F	Interlochen	D	Oxen SP Black	A	Theory 10	C		
Curlicue	C	Interlude	B	Palermo	D	Time Line	D		
Dande	E	Intrigue	D	Paragon	C	Turnabout	G		
Darning	H	Jekyll & Hyde	C	Parallel	C	Valet	C		
Dazzle	D	Jitterbug	D	Pastime	F	Variant 10	C		
Debonair	G	Jive	C	Patio	C	Vector	H		
Decoy	C	Journey	D	Pebble Beach	B	Venetian	H		
Destiny	C	Jubilee	D	Phoenix	D	Verona	C		
Destiny Plus Nanoguard	D	Kantha	G	Plaza	E	Vibrant	D		
Disco	D	Katagami	J	Polygon	D	Viewpoint	G		
Drake	D	Kensington	D	Positive Thoughts	G	Villa	E		
Dublin Tweed	D	Key Largo	C	Primo	E	Vintage Mohair	J		
Durango	C	Kobe	C	Prism 10	C	Vinyl Stat ESD	E		
Duraweave 10	A	Labyrinth	F	Proportion	G	Vipassana	G		
Echo	D	Landscape	F	Puno	G	Vogue	E		

Effective April 1, 2021

# Momentum Fabric Grading

For memo samples order online at [www.memosamples.com](http://www.memosamples.com) or call Momentum at 800-366-6839

Grades and availability of fabric are subject to change without notice. Changes could include but are not limited to price increases, discontinued patterns, discontinued colors, etc. See [jsifurniture.com](http://jsifurniture.com) for updated information.

Pattern	Grade	Pattern	Grade	Pattern	Grade	Pattern	Grade	Pattern	Grade
Ace	C	Ebb	J	Lina	J	Silica Checker	H	Tufted	J
Acoustic	G	Edison	I	Lineup	B	Silica Chopsticks	H	Turin	H
Acrobat	I	Embark	G	Lore	I	Silica Compass	H	Uplift	H
Agora II	E	Endurance EPU	C	Ludwig	I	Silica Cusp	H	Vanguard CV	D
Allegory	J	Eon EPU	C	Mandala	H	Silica Deflect	I	Veer	I
Amenity II	H	Essay	H	Mapping Ideas	I	Silica Effloresce	H	Velocity	F
Amuse	C	Essex Uph	D	Marathon C-Zero	B	Silica Etc.	G	Vertu EPU	F
Analog	I	Etude	I	Marcel	I	Silica Etch	F	Via	D
April	G	Evo CV	D	Memory	I	Silica Fiona	I	Viva II	F
Archer	I	Evolve	I	Millennium C-Zero	B	Silica Flick	I	Vox	C
Ascend	F	Expo	C	Mogul EPU	E	Silica Fresco	G	Wander	H
Audubon	I	Faux Felt	D	Nagoya	I	Silica Fritz	I	Waver	F
Bandwidth II	G	Faux Mo	F	Nifty	D	Silica Gidget	I	Weaving Palettes	G
Bangle	A	Fleet	G	Nimble	I	Silica Hiatus	I	Whim	G
Banter	I	Float	E	Oath	D	Silica Hoop	G	Whit EPU	D
Beeline EPU	C	Flock	D	Odyssey C-Zero	B	Silica Jig	H	Widget	C
Beep	D	Flow	H	Ohs II	I	Silica Kip	I	Wish	F
Beta	D	Flux	H	Origin	A	Silica Leather	F	Zipped	I
Bobby	B	Focal	E	Otto	D	Silica Likely	I		
Boom II	C	Fold	I	Pantheon	I	Silica Reach	H		
Boxcar	H	Foray	E	Parable	F	Silica Roam	I		
Bravo II	D	Free	C	Parenthesis	A	Silica Scout	I		
Brink	G	Fuse	A	Pax	J	Silica Spoke	H		
Brisk	H	Gatsby	H	Perk	C	Silica Strata	I		
Build	E	Glide	G	Phase	I	Silica Stride	F		
Buoy	G	Graph	B	Photon	I	Silica Tao	H		
Byways	I	Grid	C	Phrase	G	Silica Tech	F		
Cairns	I	Groove EPU	C	Pierre	J	Silica Thatch	G		
Camber	H	Guild	A	Ping	F	Silica Triad	F		
Canter EPU	C	Habit	B	Pip	D	Silica Waltz	I		
Carlo	I	Halo	H	Pique	F	Silica Wifi	I		
Cashmere II	E	Hark EPU	G	Plan	F	Site Line	I		
Central	F	Hawking	F	Platform	G	Skip	C		
Centric	G	Hearsay	I	Point	D	Slice	B		
Channel	F	Highline	I	Polka	G	Small Talk	H		
Chime EPU	G	Hitch	G	Printwork EPU	I	Solace	C		
Chipper	J	Hobnob	D	Progress EPU	G	Solitaire	C		
Chromatic	I	Hop	G	Propel	H	Spontaneous	I		
Cityscape	I	Hue	D	Propensity II	D	Sport	D		
Civil	F	Infinity C-Zero	B	Prospect	E	Stamp EPU	H		
Clang	F	Infusion	G	Proximity	H	Starboard	H		
Climb	I	Insight	A	Raft	H	Stroll	D		
Club EPU	F	Interim	J	Rein II	E	Strum	F		
Collect	E	Interlock	J	Reverb	I	Strut	F		
Colorwheel	H	Intermix II	E	Revolve	I	Sullivan	D		
Cover Cloth	C	Iota	H	Riga	H	Sunny	G		
Croquet	H	Jitney	F	Ring	H	Swim	D		
Cube	H	Jot	D	Rise	D	Synergy	D		
Culture	F	Journal	I	Rivet	F	Syntax	D		
Current	E	Kayak	I	Row	E	Tack	D		
Cutout	J	Keynote	D	Rubato	G	Tactic	H		
Cycle	F	Kindle	G	Rush Hour	I	Tag	H		
Dante	F	Kindred	G	Sail	I	Tanner	C		
Dart	B	Kinney	F	Score	H	Tesla	H		
Dash	G	Kit	D	Scrabble	D	Tilt	G		
Dayspell	I	Knack	C	Shuttle	G	Toggle	C		
Decode	D	Lateral	F	Sidestep	I	Traction	H		
Delve	J	Ledge	F	Silica	F	Tradition C-Zero	B		
Dive	G	Lella	G	Silica Andy	I	Trapeze	I		
Docket	I	Leno	I	Silica Arc	I	Trefoil	J		
Domain	G	Lens	C	Silica Bauble	H	Tribeca CV	D		
Drift	I	Level	H	Silica Bracket	G	Trilogy	G		



## Stinson Fabric Grading

For memo samples order online at [www.cfstinson.com](http://www.cfstinson.com) or call Stinson at 800-841-6279

Grades and availability of fabric are subject to change without notice. Changes could include but are not limited to price increases, discontinued patterns, discontinued colors, etc. See [jsifurniture.com](http://jsifurniture.com) for updated information.

Pattern	Grade	Pattern	Grade	Pattern	Grade	Pattern	Grade	Pattern	Grade
Ace	D	Dakota	D	Kilkenny Tweed	C	Pierce	C	Splice	H
Acrobat	I	Dart	D	Knot	F	Pinball	G	Sprint	C
Adagio	E	Deflection	G	Kusari	D	Pivot	C	Square One	D
Adirondack	F	Detail	E	Lara	B	Polka	E	Squire	F
Affinity	F	Deza	H	Laredo	C	Portico	F	Staple	C
Alfresco	G	Didi	E	Lateral	D	Posey	F	Stat-Con	F
Alignment	G	Diva	D	Latitude	C	Posh	E	Stellar	D
Amplify	C	Dodgeball	G	Lava	H	Power Grid	I	Steppe	H
Anagram	G	Donegal	E	Level	E	Prisma	F	Stitch In Time	D
Ardent	C	Downtown	I	Lifecycle	I	Progression	G	Storyboard	I
Arioso	F	Drift	F	Lift	I	Promenade	G	Strand	D
Armature	H	Drizzle	I	Live Wire	H	Queue	G	Stratford	I
Artisan	D	Duet	F	Loophole	F	Radiance	H	Stride	D
Avail	G	Eddy	I	Luster	E	Raffia	E	Stuff	J
Avant	C	Effervescence	H	Mandala	H	Rainier	C	Summit	F
Banyan	F	Elderberry	H	Mantra	J	Rally	C	Sunburst	G
Bari	F	Eli	F	Marimba	F	Raquette	G	Sundance w/Stakleen	E
Basket	G	English Pub	C	Marquetry	H	Raya	I	Supersillyness	I
Bass Line	G	Equinox	F	Martini	F	Realm	E	Swipe	F
Beatbox	F	Essential	C	Matrix	E	Refraction	D	Swivel	G
Bespoke	E	Etch	F	Max	G	Retrograde	D	Symmetry	H
Bistro	C	Euclid	D	Maxwell	E	Revolution	G	Sync	I
Blip	D	Expressions	C	Maze	I	Revolve	I	Tangram	F
Bliss	I	Fast Lane	D	Median	F	Rhythm	J	Tender	H
Block Party	G	Fiberdrill	F	Mesa	I	Rialto	C	Tendrill	D
Bongo	H	Figment	H	Mica	D	Riddle	D	Tessuto	D
Boomerang	J	Fizz	E	Migration	I	Ritz	E	Thrive	I
Borderline	H	Flanders	D	Mingle	F	Rivera	F	Tidbit	F
Breton	G	Fleck	C	Moby	C	Rogue II	C	Torus	G
Brilliant	D	Flip Flops	H	Moccasin	C	Rouge II	C	Touch Base	F
Brixton	G	Folio	G	Mod	G	Round Trip	I	Touchstone	D
Brushwork	I	Fractal	G	Modena	F	Salinas	I	Tranquility	H
Bryant Park	C	Frequency	G	Monhegan	G	San Simeon	H	Transcend	C
Bubblerake	J	Full Turn	J	Montage	E	Satchel	D	Tribeca	C
Budget Black	A	Furrows	D	Montana	C	Satellite	E	Trio	I
Burkshire	C	Fuse	C	Moxie	F	Scintillate	G	Tweed	F
Calibration	H	Galileo	F	Natural World	J	Scout	C	Twiggy	F
Cannon Beach	I	Geomet	E	Nest	H	Script	D	Twist	H
Carlisle	D	Gliten	I	Network	G	Season	H	Uptown	I
Casablanca	I	Gradation	E	New Hempstead	C	Sedona	I	Vanish	I
Cassidy	C	Gravity	E	Nimble	G	Semaphore	H	Velocity	F
Catalina	G	Grille	D	Nishiki	D	Sensor	G	Voltage	I
Catalyst	C	Grove	H	Nova	E	Sentry - HC	C	Volterra-HC	I
Chainite	F	Handwork	G	Obscura	G	Sequence	D	Vortexia	I
Channel	E	Happy Tappy	I	Offset	H	Serene	H	Walk The Line	J
Chaos	J	Hashtag	G	Olivia	C	Seta	F	Whirl	G
Charlotte	E	Haven	F	Olympus	F	Shantung	C	Whisper	C
Chroma	E	Helix	H	Orbit	E	Shift	C	Winnly	E
Cirque	F	Hexie	I	Outlander	D	Shimmy	E	Wish	J
Cirro	G	Hi-Fi	D	Overlay	E	Shuffle	H	Wyatt	E
Citadel	C	Highlight	D	Oxford	C	Sideline	F	Ybor	F
Clean Slate	D	Hive	D	Pacifica	H	Silicone - Avail	G	Ziggy	C
Coco	F	Hopsack	D	Paloma	D	Silicone - Downtown	I	Zodiac	D
Colden	G	Hush	F	Paradox	H	Silicone - Max - One	G	Zoom	F
Comeback	H	I Spy	H	Park Avenue	F	Silicone - Uptown	I		
Concentric	G	Infinity Plush	I	Passport	F	Silver Point	G		
Connect	C	Inside Track	D	Patriot Plus II	C	Sirocco	G		
Continuum	E	Jala	I	Penelope	G	Sleek	D		
Converge	H	Jillian	D	Pergola	F	Sleeping Bear Dunes	G		
Core	C	Juxy	G	Perimeter	F	Smoothie	D		
Corium	F	Kennebunk	G	Perspective	H	Solitaire	C		
Criss Cross	D	Kid	E	Piccadilly	F	Spirit Millennium	C		



SPRADLING® Effective April 1, 2021

# Spradling Fabric Grading

For memo samples order online at [www.spradlingvinyl.com](http://www.spradlingvinyl.com).

Grades and availability of fabric are subject to change without notice. Changes could include but are not limited to price increases, discontinued patterns, discontinued colors, etc. See [jsifurniture.com](http://jsifurniture.com) for updated information.

<u>Pattern</u>	<u>Grade</u>
Edgeline	C
Maglia	C
Silvertext	C
Whisper	B



Ultrafabrics. Effective October 22, 2021

# Ultrafabrics Fabric Grading

For memo samples order online at [www.ultrafabricsllc.com](http://www.ultrafabricsllc.com).

Grades and availability of fabric are subject to change without notice. Changes could include but are not limited to price increases, discontinued patterns, discontinued colors, etc. See [jsifurniture.com](http://jsifurniture.com) for updated information.

<u>Pattern</u>	<u>Grade</u>
Brisa Distressed	E
Brisa Distressed Outdoor	G
Brisa Fresco	E
Brisa Mokume	F
Brisa Original	E
Ultraleather Cora Outdoor	G
Ultraleather Fusion	G
Ultraleather Fusion Shimmer	G
Ultraleather Geom	G
Ultraleather Linen	F
Ultraleather Original	E
Ultraleather Pearlized	G
Ultraleather Pony	F
Ultraleather Pro	F
Ultraleather Promessa	E
Ultraleather Reef Pro	G
Ultraleather Tottori	E
Ultraleather Volar Bio	H
Ultratech Cove	G
Ultratech Dwell	G
Ultratech Eco Tech	E
Ultratech Helix	G
Ultratech Wired *	H

Effective March 1, 2021

## Cortina Leather Grading

For memo samples order online at [jsi@cortinaleathers.com](mailto:jsi@cortinaleathers.com)

Grades and availability of leather are subject to change without notice. Changes could include but are not limited to price increases, discontinued patterns, discontinued colors, etc. See [jsifurniture.com](http://jsifurniture.com) for updated information.

<u>Pattern</u>	<u>Grade</u>
Caprone	L2
Davenport	L1
Old English	L2

If selecting non-carded patterns/colorways pricing will be based on Full Hide usage.  
Contact Customer Service for price quote.

## Specification Tools

JSI products are manufactured to order and provide a multitude of options to address your individual customer needs. As you process your order do not forget to include all the necessary information to allow the order entry process to be completed. Please see the order checklist at the beginning of every series.

JSI Customer Service edits every order for complete information. If details are not included with the purchase order, Customer Service will contact you to answer these questions. If information is not completed in a timely manner it will delay the entry process and could effect your product delivery date. To avoid delay in order entry and potential delay in delivery of your order, please double check the line items to ensure all selections have been completed.

To ensure completion of details on your purchase order, electronic catalogs and specification tools have been developed to aid in the process. These electronic tools include:

**20-20 GIZA Studio and 20-20 CAP Studio** software offers state-of-the-art design, specification, photo-realistic rendering and three-dimensional visualization capabilities for configurable products in the commercial interior design markets. 20-20 GIZA Studio and 20-20 CAP Studio are available for all JSI Casework and Seating products, in 2D and 3D graphics and the Specifier Catalog. Updates are made monthly reflecting any changes that occurred. To be sure the most up to date information is provided on orders, users of this software program are responsible to update their catalogs.

**CET Designer, by Configura** is an all-in-one software solution for space planning and configuration of products. The intuitive workflow guides you through entire process from idea to reality - supporting every step of the sales process

**ProjectMatrix, Inc.** offers a full software solution for the contract furniture industry. Their software can help you create space plans to specifications for ease of specifying our JSI Casework and Seating product lines. Updates are made monthly reflecting any changes that occurred. To be sure the most up to date information is provided on orders, users of this software program are responsible to update their catalogs.

**GSAdvantage** is a Federal Government electronic catalog site offered to assist GSA customers in specifying and pricing JSI product. Listed at this site are all contract items and prices under GSA Contract # GS-28F-0030U.

Our JSI website [jsifurniture.com](http://jsifurniture.com) provides many tools to assist in the design and order selection. Included in the site are downloadable images, typicals, product symbols, brochures, contact information, price lists, sales representative locations, warranty and environmental information.

# GSA Terms and Conditions



## Contract Holder

Contract # GS-28F-0030U

**In addition to the standard terms and conditions, the following terms and conditions apply to GSA contract.**

### Contract Number

GS-28F-0030U

### Contract Period

June 24, 2013 - June 24, 2023

### Statement of Intended Use

The furniture covered by special item number 33721 Office Furniture shall comply with the requirements defined in purchase description 3QSAB 09-608. All furniture offered under this SIN shall be GSA Chassis Grade 1, 2, 3 or NA, GSA Drawer Grade 1, 2, 3, 4 or NA, Design A B or C, as defined in 3QSAB 09-608.

### Description of Special Item Number SIN #33721

#### Cooperative Purchasing

No

#### Set Aside

No

#### FSC/PSC Code

7125

**NAICS** 337211 Wood Office Furniture Manufacturing 1000 employees

Includes all furniture placed in an office, such as chairs, desks, etc. In addition, ancillary services are included, however services performed shall not be the primary purpose of the work ordered.

#### Lowest Price Model

SIN #	Model Number	Net Price
33721	VS-LBRKT-20	\$28.03

### Maximum Order

\$250,000 net

### Geographic Coverage

48 contiguous states and Washington D.C.

### Point of Production

Jasper, Dubois County, Indiana  
Orleans, Orange County, Indiana  
Paoli, Orange County, Indiana

### Discount

Discount 61.6%\* off list.

\*Discount for Walden and Wellington is 61.71% off list.

### Discount Quantity

Walden and Wellington only  
\$300,000 to \$350,000 Net = 0.5%  
\$350,001 to \$400,000 Net = 1%  
\$400,001 to \$450,000 Net = 1.5%

### Prompt Payment Terms

1% 15 - net 30 days from date of invoice.

### Government purchase cards are accepted at or below the micro-purchase threshold

### Government purchase cards are accepted above the micro-purchase threshold

### Foreign Terms

Not applicable.

### Time of Delivery

30-75 days after receipt of order, 90 days maximum.

### Expedited Delivery

Contact Customer Service 800-457-4511

### Overnight and 2-day Delivery

Not applicable.

### Urgent Requirements

Contact Customer Service 800-457-4511

### F.O.B. Points

F.O.B. destination, freight prepaid and allowed to 48 contiguous states and Washington D.C. excludes special delivery requirements.

# GSA Terms and Conditions

## Ordering Address

Jasper Seating Company, Inc. d/b/a JSI  
 Attn: Participating Dealer  
 225 Clay Street  
 Jasper, IN 47546  
 Fax: 812-482-1548  
 Phone: 800-457-4511  
 Email: orders@jaspergroup.us.com

## Order Procedures:

Per contract

## Payment Address

JSI  
 225 Clay Street  
 Jasper, IN 47546

## Warranty Provision

Limited Lifetime

## Export Package Charges

Quoted on project-by-project basis.

## Terms of Government Commercial Credit Card Acceptance

Accepted.

## Rental, Maintenance, and Repair

Not applicable.

## Terms and Conditions of installation

12% of net purchase order for installation services up to \$150,000.00 of net purchase price.

## Terms and conditions of repair parts, etc.

See warranty.

## List of service and distribution points

Contact Customer Service 800-457-4511.

## List of participating dealers

Contact Customer Service 800-457-4511.

## Preventive Maintenance

N/A

## Environmental Attributes

GreenGuard Certified and recycled wood waste and fabric remnants

## Section 508 Compliance.

N/A

## DUNS #

00-636-7767

## CCR and SAMS Registration

Jasper Seating Company, Inc. is registered  
 Cage Code #31881  
 Federal ID #35-0420370

## Product Modifications

We willingly accept customers' modifications to standard products. See product modification information by series at the start of each series under the "Product Modification" sections. If there is a modification you desire that is not listed in this section, please call Customer Service for a modification quote/price

## Acceptance, Modification, Assignment

By placing this order for furniture, material or other products (sometimes collectively referred to as "goods"), customer agrees to these terms and conditions which shall prevail over inconsistent provisions in any other form or document of customer. No change or modification shall be applicable unless set forth in writing and signed by company. Neither this order nor any interest therein shall be assigned by customer except with the prior written consent of company.

## Payment

Customer agrees to pay to company the amount indicated on the invoice, 1% 15 days, net 30 days from date of invoice (U.S. funds only), for goods ordered. Interest will be charged after 30 days from the date of invoice at the rate of one and a half percent (1.5%) per month. International sales will require additional payment arrangements. No goods shall be sold on consignment or conditional sales basis. Payment for the goods delivered hereunder shall constitute acceptance thereof.

## Attorneys' Fees

Customer shall be responsible for all expenses and cost in connection with the enforcement by company of these terms and conditions and the cost of collection (including the fees of any collection agencies to whom the customer's account may be referred), plus reasonable attorneys' fees (which attorneys' fees shall not be less than 25% of the amount due, unless a lower amount is specified by applicable law).

## Remedies

The remedies herein reserved shall be cumulative, and additional to any other or further remedies provided in law or equity. No waiver of a breach of any provision of these terms and conditions shall constitute waiver of any other breach or of such provision.

## Insolvency

Company may forthwith cancel this order in the event of the happening of any of the following or any other comparable event: insolvency of the customer, the filing of a voluntary petition in bankruptcy, the filing of any involuntary petition to have customer declared bankrupt provided it is not vacated within thirty (30) days from the date of filing, the appointment of a receiver or trustee for customer provided such appointment is not vacated within thirty (30) days from the date of such appointment, or the execution by customer of an assignment for the benefit of creditors.

# GSA Terms and Conditions

## Limitation of Liability

The Company shall not under any circumstances be liable to the customer, owner of the goods or any third party for special, indirect, incidental, or consequential damages, including, without limitation, loss of profits or revenues, loss or damage to other property or equipment, cost of capital or of purchased or replacement goods, or expense, delay, or inconvenience cause by or arising from the purchase, sale, use, repair or inability to use the goods or by any performance or non-performance under, or breach of, these terms and conditions. The Company's sole liability for any defective goods shall be its repair or its replacement pursuant to the express warranties set forth above, or if amended, as applicable at the time of manufacture or repair of the goods. Some states do not allow the exclusion or limitation of incidental or consequential damages, so the above limitations or exclusion may not apply to all customers. Any action resulting from any breach on the part of company as to the goods or services delivered here under must be commenced within one year after the cause of action has occurred.

## Returns and Allowances

Reasonable touch-up and deluxing is the dealer's responsibility. The Company will not make allowances for trip or delivery charges, but will only make allowance for actual work performed to correct manufacturing defects. Allowances may be authorized only by a company officer. It is the responsibility of the field sales representative to inspect any defective merchandise and make suggestions and recommendations as to the proper disposition. Field personnel cannot obligate or bind the company by definite agreement, without final authorization by a company officer. Company will not accept automatic charge backs which do not have prior authorization. All defects must be called to the company's attention upon arrival at the customer's "ship to" destination. To initiate any type of claim or request for parts, it is imperative to have the model number or fabric number, which may be located on the tag attached to the frame of the unit. Authorization for return to the company via a return goods authorization. Company will not issue credit allowances for any repairs without company's prior consent. Under no circumstances shall the company accept COD (cash on delivery) returns, and any such shipment will be refused.

## Security Agreement

The Company may require and customer shall grant a security interest in goods sold pursuant to any credit the company may extend to the customer.

## Governing Law

All disputes between the parties, whether or not arising out of these terms and conditions, will be governed by the laws of the state of Indiana. Customer agrees to submit to the jurisdiction of and agrees all lawsuits relating to any disputes between the customer and the company will be brought only in a state court located in Dubois County, Indiana or the United States District Court for the Southern District of Indiana. The customer hereby waives the right to a trial by jury in any action, proceeding, claim, or counterclaim whether in contract or tort, at law or in equity, arising out of or relating in any way to these terms and conditions and all other disputes between the parties.

## Mitigation

If the company repossesses the goods prior to payment by the customer of all amounts due hereunder, the company may sell the goods, as is, where is, free and clear of all rights of the customer at either public or private sales, and apply the net proceeds (after deducting expenses of repossession and sale) to the obligation of customer hereunder. The customer may dispose of the goods in any commercially reasonable place and manner and the customer waives any notice of time, place and manner of sale.

## Integration

This order for goods, including these terms and conditions, along with any credit application, invoice, statement, dealer contract, acknowledgment, bill of lading (and any exhibits, addenda or amendments thereto) of which this order may be a part, constitutes the sole and complete agreement between the company and the customer with respect to the purchase of the goods.

## Dimensions/Specifications/Finishes

All dimensions are approximate and may vary due to the upholstery technique of each craftsman. If exact dimensions are required, it is necessary for the customer to state such specifications with the order. Detailed specifications sheets are available for each series of goods, and customer should consult the company's customer service department for these specification sheets. Company reserves the right to make changes in dimensions, style, or specifications if company believes these changes will improve the goods' quality or appearance. Company reserves the right to substitute hardwoods due to availability at production. Due to the natural characteristics of wood, environmental effects, and material upgrades, the company cannot guarantee exact finish matches on existing goods previously ordered from company. If an exact match to customer's existing goods is required, it must be specified so that the proper procedures can be followed to ensure an acceptable finish. Company will accept no liability for the finish if this procedure isn't followed. Company reserves the right to make changes in a finish formula if company believes the change will improve the quality or appearance of company's goods.

## Company's Performance of Its Obligation

The production and delivery of the goods to the extent delayed or hindered or prevented from the performance by reason of natural disasters, acts of god, strikes, lockouts, labor troubles, inability to procure materials, casualties, failure of power, restrictive governmental laws or regulations, riots, insurrections, acts of terrorism, war or other reason of a like nature not the fault of the company shall excuse for the period of the delay the company's performance and the period for the performance shall be extended for a period equivalent to the period of such delay.



General Information . . . . .	32	Table with Open Loop Bases . . . . .	50
Material Offering. . . . .	33	Table with Panel Bases. . . . .	58
Table Surface Material . . . . .	34	Table with Box Bases. . . . .	78
Top Sizes and Shapes . . . . .	36	Table with Height Adjustable Bases. . . . .	98
Bases . . . . .	37	Table with X Base . . . . .	106
Applied Materials . . . . .	38	Peninsula Table with Open Loop Base . . . . .	108
Product Information . . . . .	40	Peninsula Table with Panel Base . . . . .	114
Technology . . . . .	44	Credenzas . . . . .	120, 146
Typicals . . . . .	46	Runoff Table with Open Loop Base . . . . .	128
		Runoff Table with Panel Base. . . . .	134
		Media Wall Space Divider . . . . .	140
		Towers. . . . .	144
		Hospitality Cart . . . . .	146
		Open Shelves . . . . .	146
		Mobile Lecterns . . . . .	147
		Mobile Boards. . . . .	148
		Coffee Tables . . . . .	149
		Benches. . . . .	149
		Power and Wire Management. . . . .	150



## Native General Information

### Wood Materials

Exterior surfaces are made from the finest selected veneers. Matching solid lumber wood species are used to coordinate with the veneer. High quality MDF is used on the painted surfaces.

Native is available in Cherry, Maple or Walnut Flat Cut, or Double Cut veneer.

### Case Construction

#### All Models

Cabinets are constructed with dowels reinforced with screws, cleats and metal fasteners for increased stability. The metal glide housing inside the base provides for accurate leveling. Cabinets, with the exception of the waste credenza and hospitality carts, have sliding doors.

#### Laminate Models

Panels for chassis consist of a  $\frac{3}{4}$ " thick substrate with TFL surfaces and PVC bands on exposed edges.

#### Veneer Models

Panels for chassis are  $\frac{3}{4}$ " thick.

### Drawer Construction

Drawers are assembled using a four corner dovetail box and  $\frac{3}{4}$ " thick drawer bottom panel construction. The exterior front is attached separately. Sides and backs are approximately  $\frac{1}{2}$ " thick solid hardwood. Drawer components have a UV finish to protect against shrinking, swelling, or warping and to provide a clean smooth feel and appearance. Lateral files have reinforced bottoms.

The exterior front panel is 3-ply and  $\frac{3}{4}$ " thick. The front is attached to the assembled drawer box. The anodized aluminum pull runs along the top edge of the drawer front.

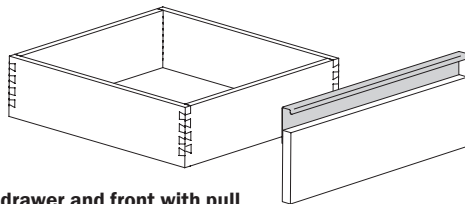

**box drawer and front with pull  
wood drawer box - DRW**

### Protective Top Coat

DuraTex™ offers exceptional hardness along with abrasion and impact resistance, it has been formulated to eliminate hazardous and harmful gases that are normally associated with wood finish.

### Finish - Stain/Colors

We offer a variety of wood stains and paint colors on Native. Please see the chart below. Samples are available upon request.

### DuraTex™ Features

**Safety** - Significantly reduces hazardous formaldehyde emissions which help improve the quality of the indoor air we breathe. **Quality** - Developed to be tough and durable with special attention to appearance. The DuraTex™ finish preserves the natural beauty of wood. **Durability** - Designed to meet a wide range of demanding performance and environmental standards to withstand even the highest wear and tear.

### Special Finishes

Special finishes can be requested by following the instructions in the conferencing general order section, page 3. There is a one time charge of \$332 list per order. This applies to the veneer surfaces, and not the solid wood plank top option.

# Native Material Offering

## Native Standard Laminate Offering

The chart below lists the laminates available on Native.

### Laminate Options

Wood Grain Laminate		Solid Laminate	
AGA	Aged Ash	ALB	Alabaster
ALL	Ale Light	BBL	Bridal Blanco
BLO	Blond Echo	DWH	Designer White
BOL	Bourbon Light	SHD	Shadow
BZW	Brazilwood	SLG	Slate Grey
BGL	Brighton Light		
CLL	Brighton		
FLO	Florence Walnut		
GRH	Graphite		
HGL	High Line		
OAT	Oatmeal Cookie		
PIN	Pinnacle Walnut		
STU	Studio Teak		
VIN	Vintage		
WLH	Walnut Heights		
WEA	Weathered Ash		

## Native Standard Veneer Finish Offering

The charts below list the veneer stains and paints available on Native. Finishes with an asterisk (\*) have coordinating laminate tops.

### Finish/Stain Colors

CH1	Cherry Flat Cut Veneer	WA1	Walnut Flat Cut Veneer
BRL	Barley	AUB	Auburn
BBM	Bourbon Medium	ESP	Espresso
BRM	Brighton Medium	MCH	Mocha*
CLA	Classic	NTO	Night Owl*
CLL	Collectors*	SIE	Sienna*
EAR	Earthy	TOF	Toffee
HRV	Harvest*	TRF	Truffle*
LGC	Legacy		
PRL	Praline*		
SAF	Saffron		
MA1	Maple Flat Cut Veneer	DC1	Double Cut Veneer
ALM	Ale Medium	COF	Coffee
BUT	Butterscotch	CRM	Cremello
CIN	Cinnamon	FOS	Fossil
FLX	Flax	GRH	Graphite
VEN	Venetian	KHK	Khaki
		STU	Studio Teak

### Solid Surface

S	Solid Surfaces
ARM	Armadillo
BLP	Black Pearl
PEB	Pebble Pearl
PUR	Pure White

### Glass

G	Glass - Back Painted White
G	Glossy Finish
M	Matte Finish

### Wood Plank Ash

W	Wood Plank Ash - Clear Coat
---	-----------------------------

### Customer Choice

B	Base and Subtop Only
---	----------------------

## Paint Colors

PNT	Paint (Maple Flat Cut Veneer)
BKD	Backdrop
BFX	Black Fox
BWH	Bright White
CGP	Cargo Pants
CHT	Chatroom
FRR	French Roast
GRV	Greek Villa
NET	Network Gray
NWH	Nonchalant White
STM	Storm
TRC	Tricorn Black

## Metal Finishes - Accent Colors

Metal Accents	
ASL	Arctic Silver
BWH	Bright White
CHR	Chrome
MBK	Matte Black
PEW	Pewter
RML	Raw Material
SNK	Soft Nickel

JSI's extended powdercoat program of bright colors is available upon request. Contact Customer Service for a specific quote based on color and qty of units.

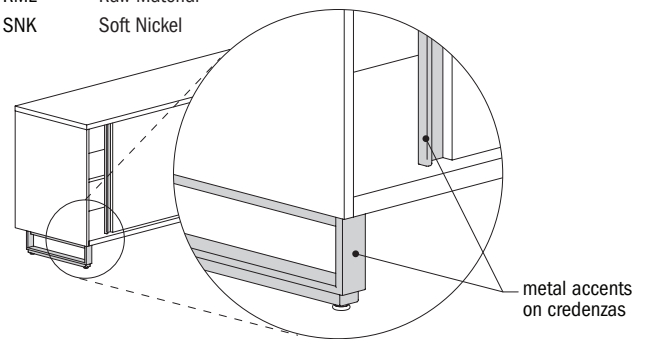

## Alternative Surfaces

Mobile Boards	
WMB	White Marker Board Surface
CKB	Corkboard Surface

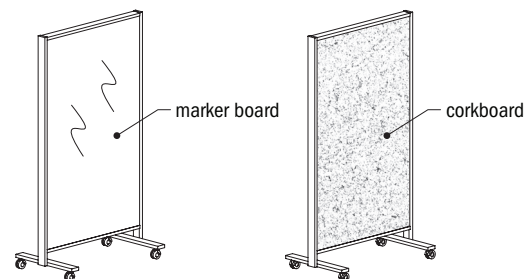

## Cove Electrical Finishes

B	Black
S	Silver
W	White

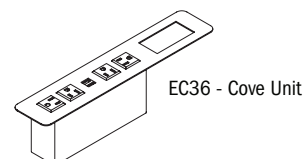

## Native Table Surface Materials

### NAT - Table Models

The NAT prefix is used to designate laminate material.

### Laminate Tops

HPL tops are 1 3/16" thick, 3 ply construction. The laminate face is horizontal grain, or solid, high pressure laminate. Particle board core and a phenolic backer sheet complete the balanced construction.

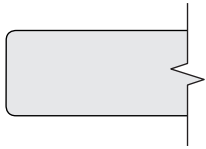

#### Eased Edge (R3)

Standard on worksurface tops

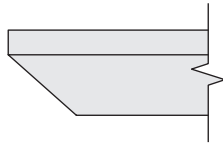

#### Reverse Bevel (E1)

PVC on top of Painted MDF

### Native Standard Laminates

#### Wood Grain Laminate

<b>AGA</b>	Aged Ash	<b>GRH</b>	Graphite
<b>ALL</b>	Ale Light	<b>HGL</b>	High Line
<b>BLO</b>	Blonde Echo	<b>OAT</b>	Oatmeal Cookie
<b>BOL</b>	Bourbon Light	<b>PIN</b>	Pinnacle Walnut
<b>BZW</b>	Brazilwood	<b>STU</b>	Studio Teak
<b>BGL</b>	Brighton Light	<b>VIN</b>	Vintage
<b>CLL</b>	Collectors	<b>WLH</b>	Walnut Heights
<b>FLO</b>	Florence Walnut	<b>WEA</b>	Weathered Ash

#### Solid Laminate

<b>ALB</b>	Alabaster
<b>BBL</b>	Bridal Blanco
<b>DWH</b>	Designer White
<b>SHD</b>	Shadow
<b>SLG</b>	Slate Grey

## Native Table Surface Materials

### NAV - Table Models

The NAV prefix is used to designate non-laminate material. Choose between Veneer - Flat Cut, Veneer - Double Cut, Solid Surface, Glass, Wood plank, or Customer Choice Material for NAV models.

### Veneer Tops

Tops are 1 3/16" thick, 5 ply balanced construction with particle board core. Flat cut is book match for cherry, maple and walnut veneer. Double cut is a processed product that has at least two cuttings to create the final veneers. These cuts of veneer strands are dyed and layered into a block to create the pattern.

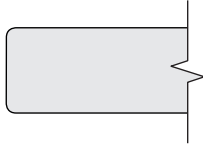

**Eased Edge (R3)**  
Internal Lumber Band

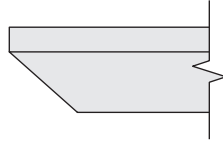

**Reverse Bevel (E1)**  
Veneer Band on Stained MDF

### Finish - Stain/Colors

#### Flat Cut Veneer

CH1	Cherry	MA1	Maple	WA1	Walnut
<b>BRL</b>	Barley	<b>ALM</b>	Ale Medium	<b>AUB</b>	Auburn
<b>BBM</b>	Bourbon Medium	<b>BUT</b>	Butterscotch	<b>ESP</b>	Espresso
<b>BRM</b>	Brighton Medium	<b>CIN</b>	Cinnamon	<b>MCH</b>	Mocha
<b>CLA</b>	Classic	<b>FLX</b>	Flax	<b>NTO</b>	Night Owl
<b>CLL</b>	Collectors	<b>VEN</b>	Venetian	<b>SIE</b>	Sienna
<b>EAR</b>	Earthy			<b>TOF</b>	Toffee
<b>HRV</b>	Harvest			<b>TRF</b>	Truffle
<b>LGC</b>	Legacy				
<b>PRL</b>	Praline				
<b>SAF</b>	Saffron				

#### Double Cut Veneer

DC1	Double Cut Veneer
<b>COF</b>	Coffee
<b>CRM</b>	Cremello
<b>FOS</b>	Fossil
<b>GRH</b>	Graphite
<b>KHK</b>	Khaki
<b>STU</b>	Studio Teak

### Premier Tops

#### Solid Surface Tops

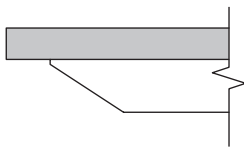

Solid Surface Tops are 1 7/16" thick constructed of 7/16" thick solid surface on top of a 1" MDF sub top. Sub top has an under cut bevel profile and is painted in a coordinated color to match the solid surface.

#### Solid Surfaces

<b>ARM</b>	Armadillo
<b>BLP</b>	Black Pearl
<b>PEB</b>	Pebble Pearl
<b>PUR</b>	Pure White

#### Glass Tops

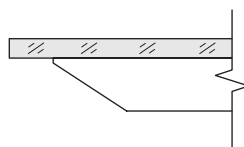

Glass Tops are 1 5/16" thick constructed of 1/4" thick glass surface on top of a 1" MDF sub top. Sub top has an under cut bevel profile and is always painted white, to match the back painted glass. Glass sits on top of the sub top with 1/16" bumpers.

#### Glass Selection

<b>G</b>	White Glossy
<b>M</b>	White Matte

#### Wood Plank Ash Tops

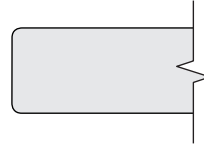

Wood Plank Ash Tops are a solid 1 3/16" thick plank of ash. Tops are finished with a clear coat.

#### Solid Wood Plank

<b>W</b>	Wood Plank Ash - Clear Coat
----------	-----------------------------

#### Customer Choice Tops

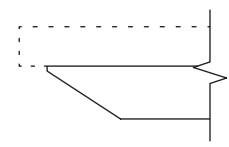

Sub tops are 1" thick and have an under cut bevel profile. Sub top is always painted in black. Customer is responsible for determining the best attachment method for their custom top. Weight of custom top not to exceed 13 lbs per square foot.

#### Customer Choice

<b>B</b>	Base and Subtop Only
----------	----------------------

## Native Tops Sizes & Seating Capacity

### Native Top Shapes and Sizes

Native offers six table top shapes with multiple sizes. The round and square come with an X base. All others available with Open Loop, Panel, or Box Base.

#### One piece top shapes and sizes:

PRODUCT INFORMATION



- rectangular**  
 54" x 120" Seats 8  
 48" x 120" Seats 8  
 48" x 108" Seats 8  
 48" x 96" Seats 8  
 48" x 84" Seats 8  
 48" x 72" Seats 6  
 42" x 120" Seats 8  
 42" x 108" Seats 8  
 42" x 96" Seats 8  
 42" x 84" Seats 8  
 42" x 72" Seats 6  
 36" x 84" Seats 8  
 36" x 72" Seats 6



- arc end**  
 54" x 120" Seats 8  
 48" x 120" Seats 8  
 48" x 108" Seats 8  
 48" x 96" Seats 8  
 48" x 84" Seats 8  
 48" x 72" Seats 6  
 42" x 120" Seats 8  
 42" x 108" Seats 8  
 42" x 96" Seats 8  
 42" x 84" Seats 8  
 42" x 72" Seats 6  
 36" x 84" Seats 8  
 36" x 72" Seats 6

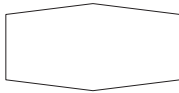

- boat**  
 48" x 120" Seats 8  
 48" x 108" Seats 8  
 48" x 96" Seats 8  
 48" x 84" Seats 8  
 42" x 72" Seats 6

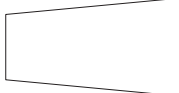

- view**  
 60" x 120" Seats 8  
 60" x 108" Seats 8  
 54" x 96" Seats 8  
 54" x 84" Seats 8  
 48" x 72" Seats 6



- square**  
 60" x 60" Seats 8  
 54" x 54" Seats 6  
 48" x 48" Seats 4



- round**  
 60" x 60" Seats 8  
 54" x 54" Seats 6  
 48" x 48" Seats 4

#### Two piece top shapes and sizes:



- rectangular**  
 60" x 240" Seats 20/22  
 60" x 216" Seats 18/20  
 60" x 192" Seats 16/18  
 60" x 168" Seats 14/16  
 60" x 144" Seats 10/12  
 54" x 240" Seats 18/20  
 54" x 216" Seats 16/18  
 54" x 192" Seats 14/16  
 54" x 168" Seats 12/14  
 54" x 144" Seats 10/12  
 54" x 132" Seats 8/10  
 48" x 192" Seats 14/16  
 48" x 168" Seats 12/14  
 48" x 144" Seats 8/10  
 48" x 132" Seats 6/8



- arc end**  
 60" x 240" Seats 18/20  
 60" x 216" Seats 16/18  
 60" x 192" Seats 14/16  
 60" x 168" Seats 12/14  
 60" x 144" Seats 10/12  
 54" x 240" Seats 18/20  
 54" x 216" Seats 16/18  
 54" x 192" Seats 14/16  
 54" x 168" Seats 12/14  
 54" x 144" Seats 10/12  
 54" x 132" Seats 8/10  
 48" x 192" Seats 14/16  
 48" x 168" Seats 12/14  
 48" x 144" Seats 8/10  
 48" x 132" Seats 6/8

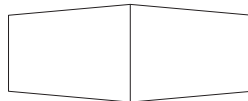

- boat**  
 60" x 240" Seats 16/18  
 60" x 216" Seats 14/16  
 60" x 192" Seats 12/14  
 54" x 168" Seats 10/12  
 54" x 144" Seats 8/10  
 54" x 132" Seats 6/8

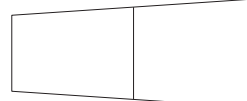

- view**  
 60" x 240" Seats 16/18  
 60" x 216" Seats 14/16  
 60" x 192" Seats 12/14  
 60" x 168" Seats 10/12  
 60" x 144" Seats 8/10  
 60" x 132" Seats 6/8

## Native Bases

Native's array of base styles allow users the option of a raw open aesthetic or a closed, polish function.

### Open Loop Base

Welded steel frame. Use NAB0301-24LBWM for magnetically attached wire management.

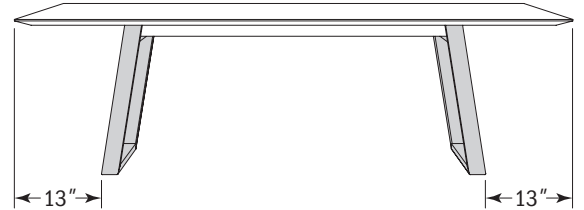
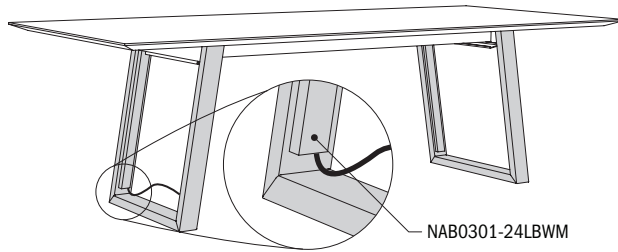

PRODUCT INFORMATION

### Panel Base

Panel encloses welded steel frame. "T" models: Choose any laminate for panel. "V" models: Choose matching veneer or painted panel. Design allows horizontal adjustment.

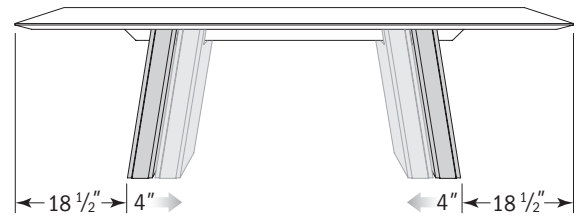
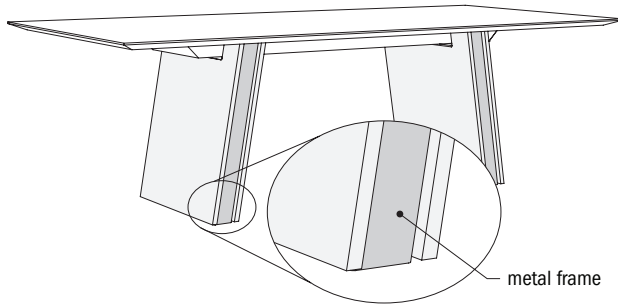

### Box Base

Box encloses welded steel frame. "T" models: Choose any laminate for panel. "V" models: Choose matching veneer or painted box. Design allows horizontal adjustment.

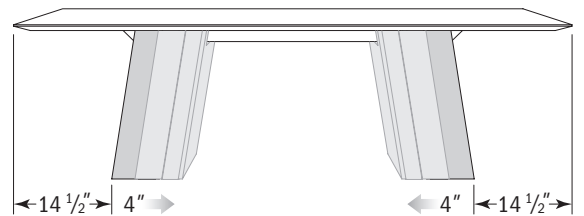
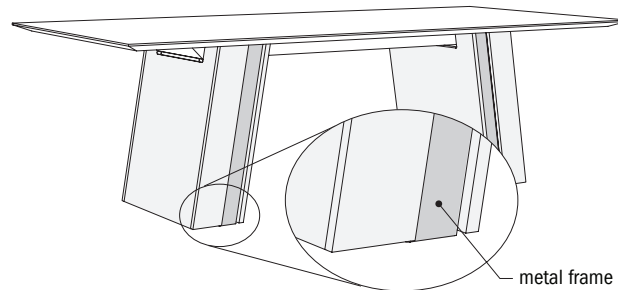

### X Base

Welded steel frame. For round and square tables only. Use NAB0201-24XBWM for magnetically attached wire management.

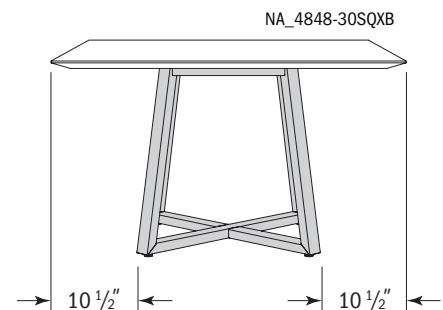
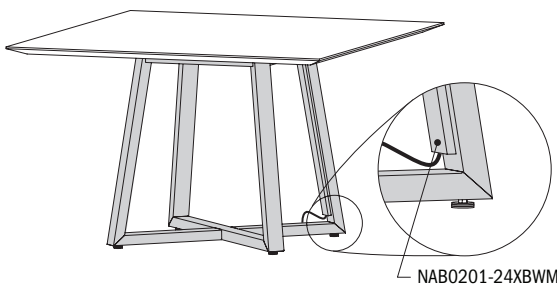

## Native Applied Materials

### Laminate Grain Direction

Laminate grain runs vertical as standard on all vertical surfaces. Worksurfaces run long grain. Below are examples of laminate grain direction.

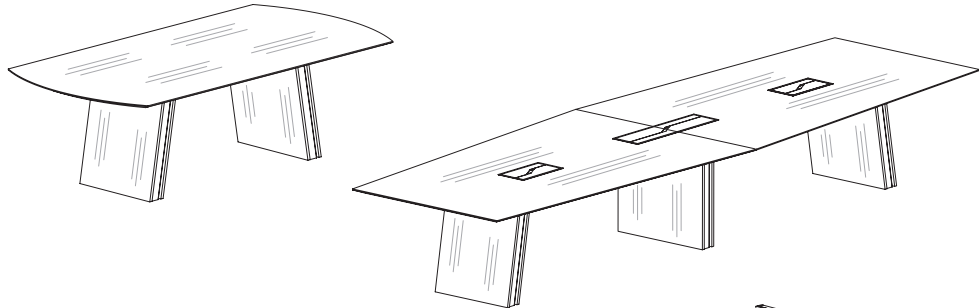
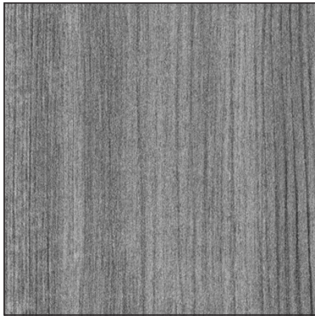

### Laminate Grain

Laminate grain direction varies according to its surface. Refer to the diagrams on this page for examples of standard direction.

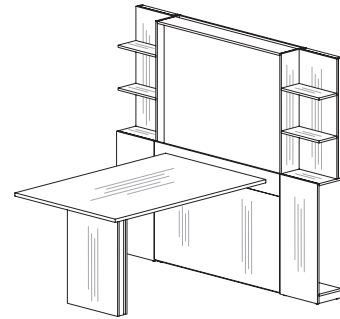
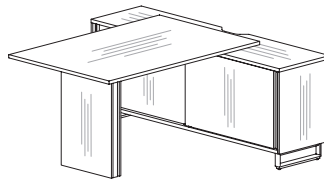
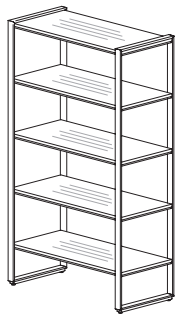
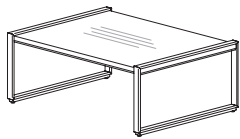

PRODUCT INFORMATION

### Flat Cut & Double Cut Grain Direction

Veneer grains runs vertical as standard on all vertical surfaces. 1-piece tables, runoffs, peninsula tables will run long grain. 2-piece tables will run short grain. Below are examples of veneer grain direction.

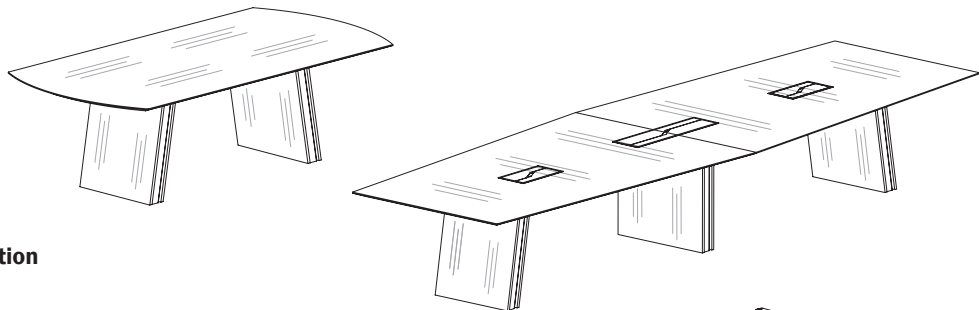

### Flat Cut & Double Cut Grain Direction

Veneer grain direction varies according to its surface. Refer to the diagrams on this page for examples of standard direction.

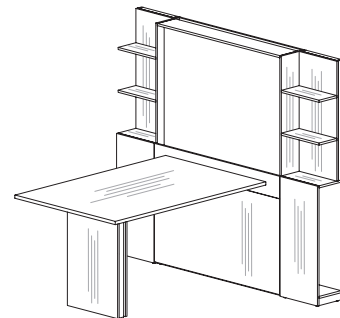
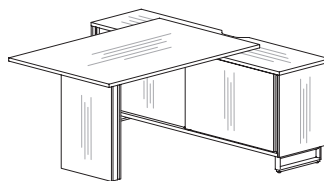
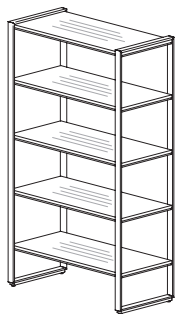
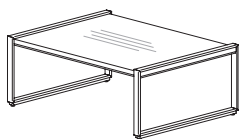

## Native Applied Materials

### Native Color Scheme

Native offers the flexibility to specify contrasting door fronts, or a contrasting base panels, separate from the worksurface selection. See the options available below, depending on whether a NAT or NAV model specified.

#### NAT Surface Options

- A = Worksurface**  
Laminate - see page 34 for selection
- B = Chassis**  
Laminate - see page 33 for selection
- C = Door Fronts, Base Panels & Front Panels**  
Any Laminate

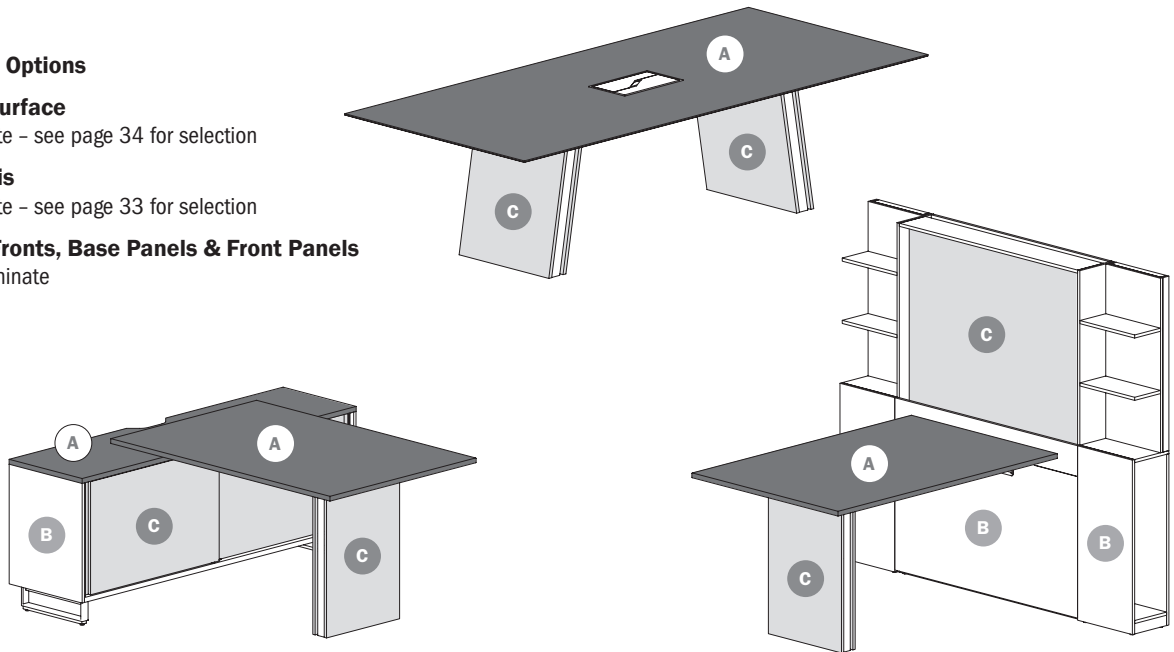

#### NAV Surface Options

- A = Worksurface**  
Veneer - see page 35 for selection  
Solid Surface - see page 35 for selection  
Glass - see page 35 for selection  
Wood Plank - see page 35 for selection  
Customer Choice Material - see page 35 for selection
- B = Chassis**  
Veneer - see page 33 for color selection
- C = Door Fronts, & Base Panels**  
Veneer - same as worksurface  
Paint - see page 33 for color selection
- D = Front Panel**  
Veneer - same as chassis  
Laminate - see page 33 for color selection

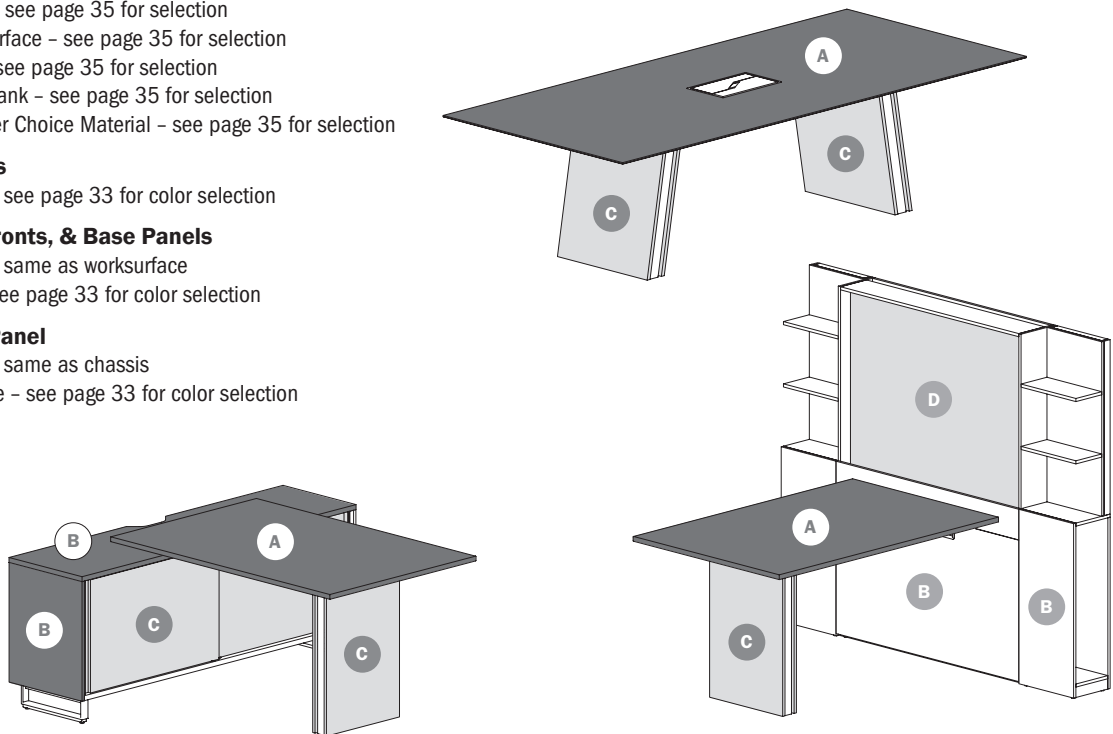



## Native Product Information

### Waste Credenza

PRODUCT INFORMATION

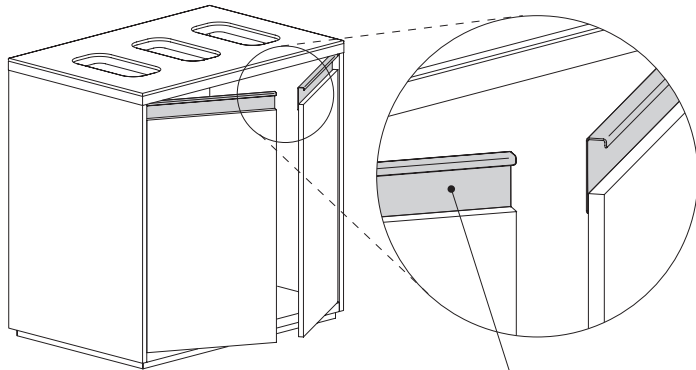

Integrated pulls are designed into all doors and drawers of Native Credenzas and are available in a variety of metal finish accents, see page 3.

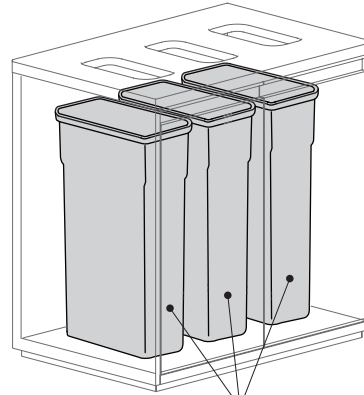

Waste Credenzas accommodate three Uline Thin #H-5148 (23 gallon) trash cans, not included

### AV Credenza

Removable back panel behind AV rack

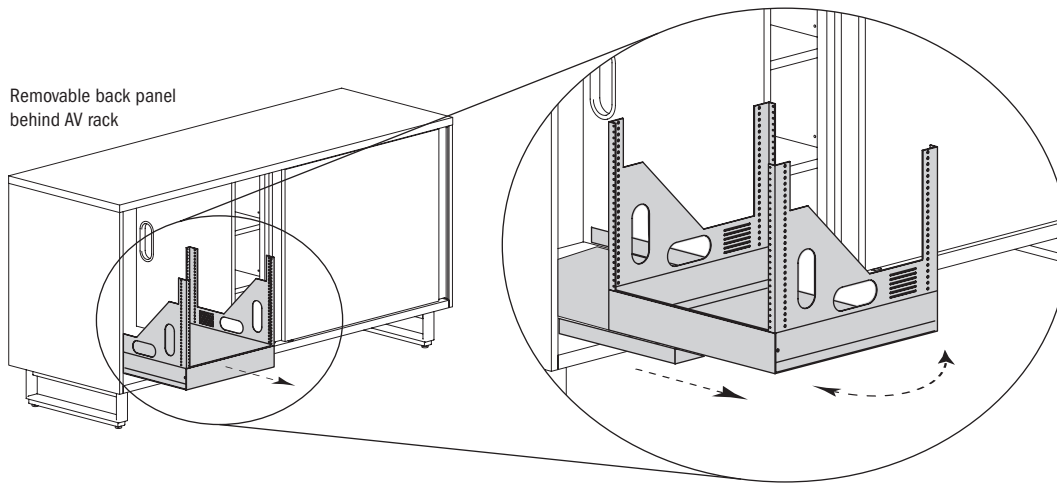

Pull-out and rotating AV rack is designed so you can access equipment and wiring. Rack can rotate 90° in either direction and can be locked in the rotated position.

### Credenza Waste Drawer

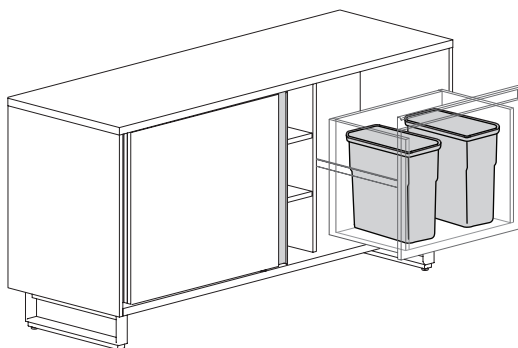

Waste drawer accommodates two Uline #S-13527 (10 gallon) trash cans, not included

## Native Product Information

### Mobile Boards

Multi-functional mobile boards can double as portable working space or serve to define boundaries within the office area. With three (3) material selections (markerboard, tackboard, and corkboard), Native mobile boards offer a variety of panel configurations to fit your needs.

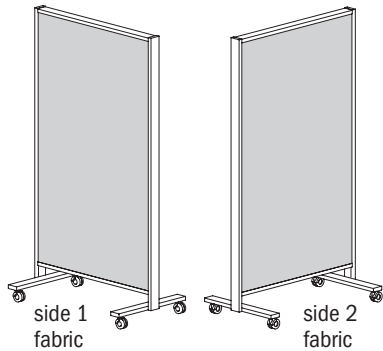

**NAB2442-75MTKD**  
Tackboard on both sides.

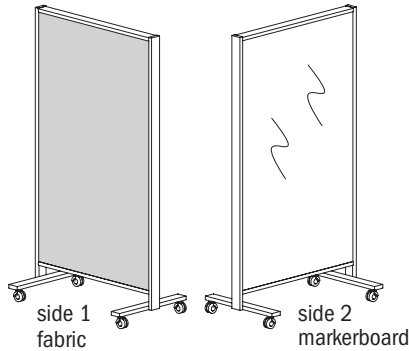

**NAB2442-75MTKS**  
Tackboard on one side, choice of markerboard or corkboard on reverse side; specify when ordering.

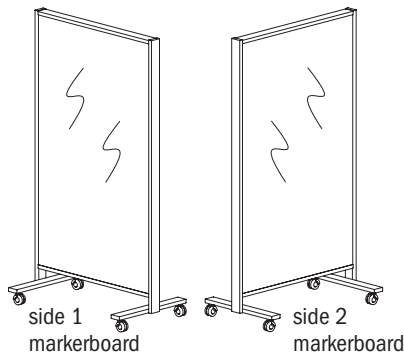
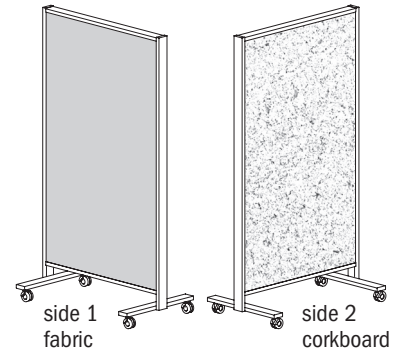

**NAB2442-75MMB**  
Markerboard both sides, corkboard both sides, or combination markerboard and corkboard; specify when ordering.

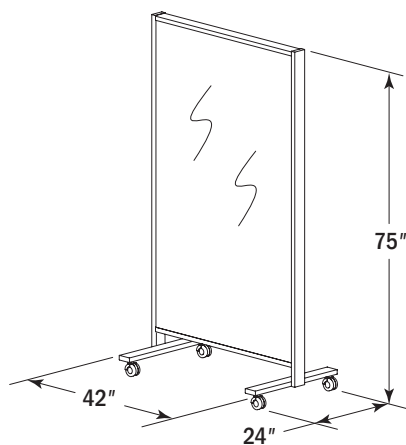
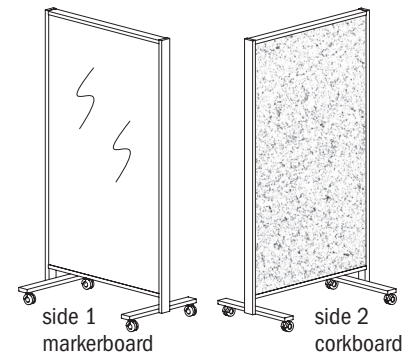
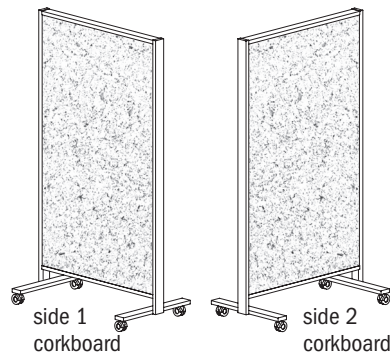

**Overall dimensions**  
Wide base for stability

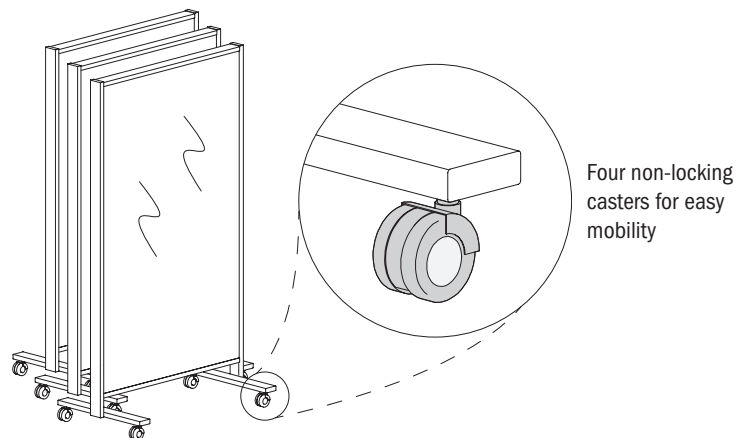

**Offset Nesting**  
Provides for organized storage

## Native Product Information

### Peninsula Tables with Credenza

Peninsula tables with credenza applications are offered at standard desk height and standing height. See below for overall unit heights.

PRODUCT INFORMATION

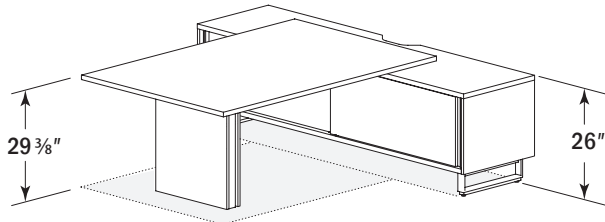

**Standard Desk Height Peninsula Table**  
Connects to a 26" h Credenza

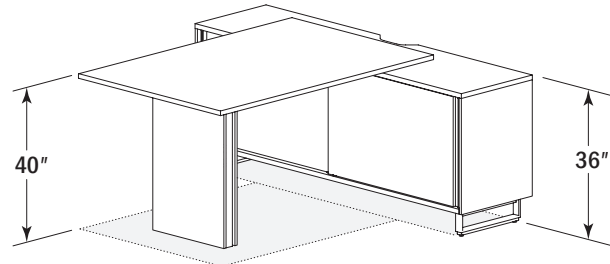

**Standing Height Peninsula Table**  
Connects to a 36" h Credenza

### Runoff Tables with Media Walls

Runoff tables with media wall applications are offered at standard desk height and standing height. See below for overall unit heights.

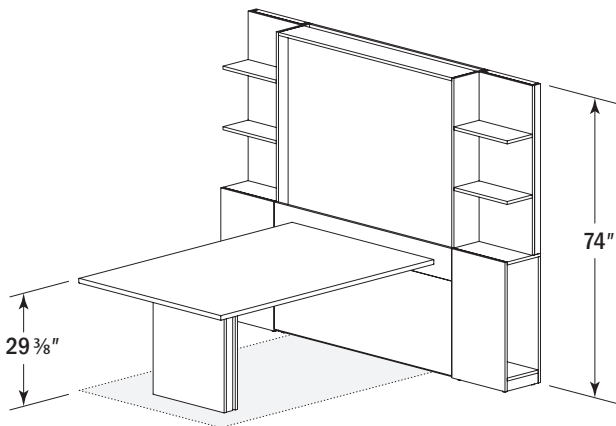

**Standard Desk Height Runoff Table**  
Connects to a 74" h Media Wall

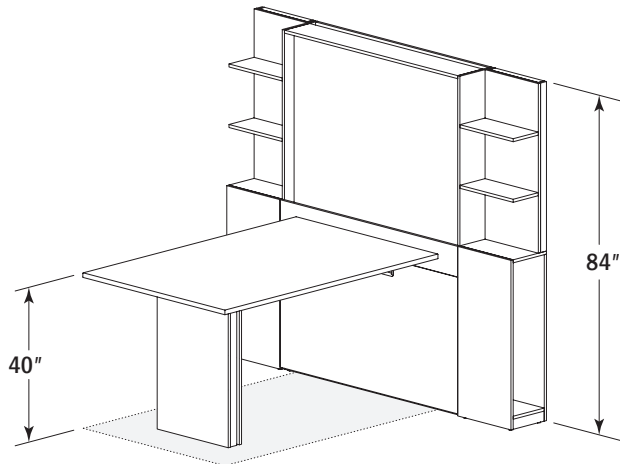

**Standing Height Runoff Table**  
Connects to a 84" h Media Wall

### TV/Monitor Sizes for Media Walls

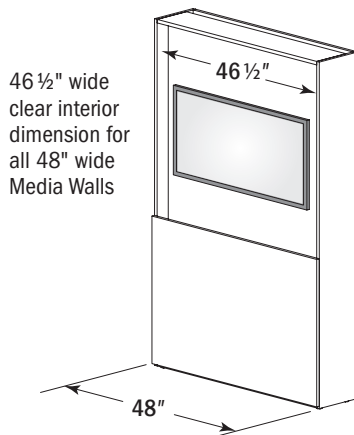

46 1/2" wide clear interior dimension for all 48" wide Media Walls

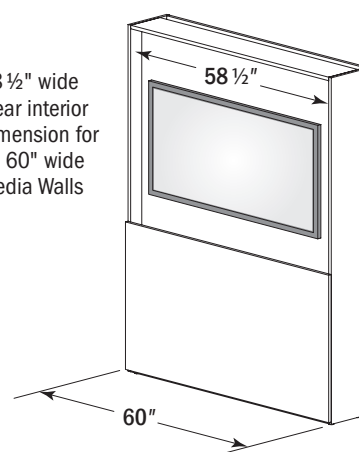

58 1/2" wide clear interior dimension for all 60" wide Media Walls

## Native Product Information

### Media Wall Applications

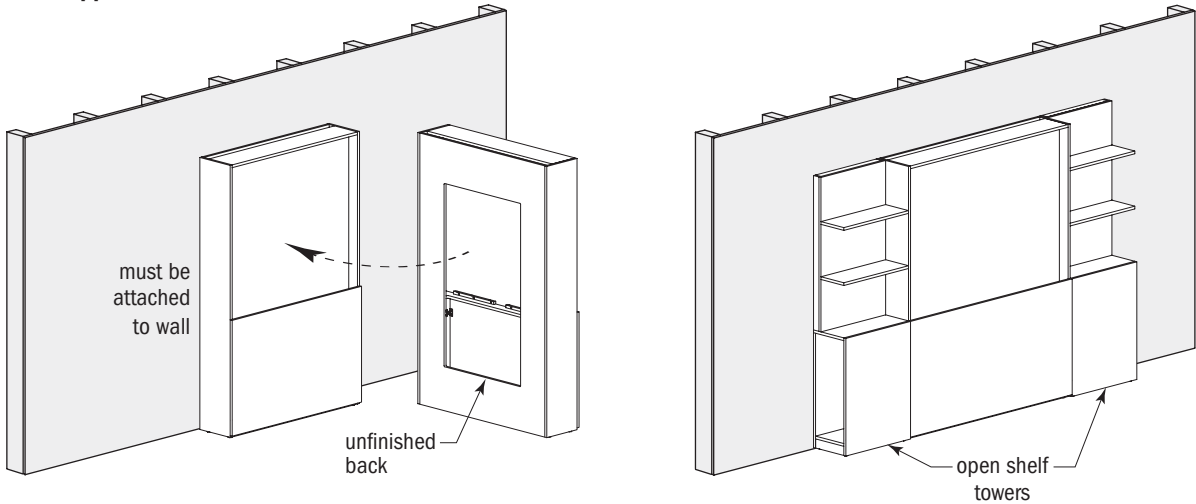

#### Media Wall - Wall Dependent

Media Walls have unfinished backs and are designed to be attached to a wall. Open Shelf and Side Access Wardrobe Towers are available and attach to Media Walls.

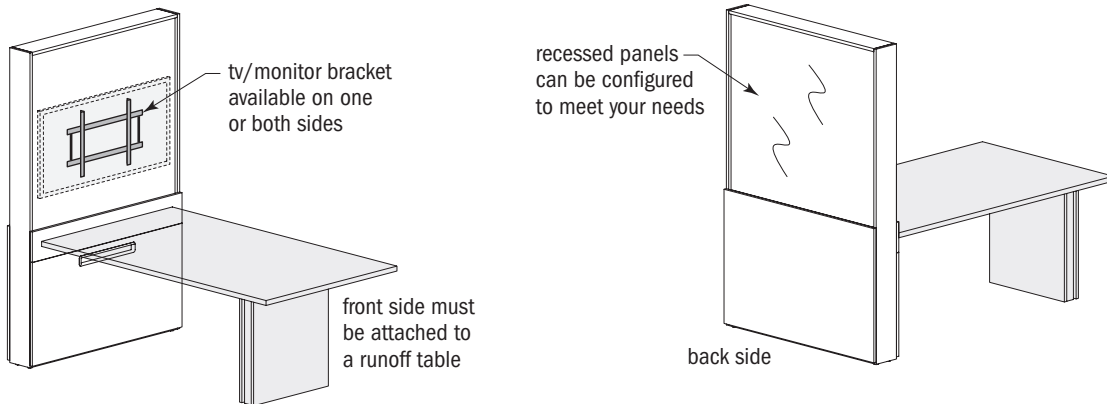

#### Media Wall Space Divider - Media Back

Media Wall Space Dividers with Media Back must be attach to a Runoff Table for support. The recessed panels on these dual sided units can be mixed and matched with contrasting laminates or veneers, and markerboards. TV brackets also available on one or both sides. Units not to be used with Open Shelf or Side Access Wardrobe Towers.

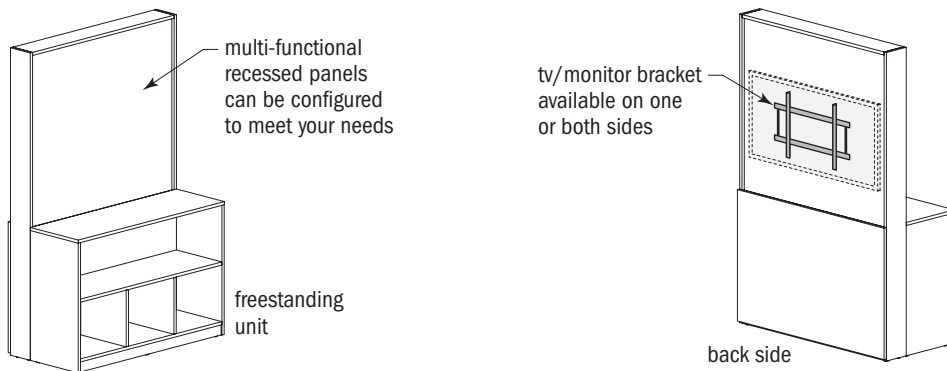

#### Media Wall Space Divider with Media Shelf - Media Back

Media Wall Space Divider with Media Shelf is a freestanding unit. Runoff Tables can be attached to the back side of unit but is not necessary. The recessed panels on these dual sided units can be mixed and matched with contrasting laminates or veneers, and markerboards. TV brackets also available on one or both sides. Units not to be used with Open Shelf or Side Access Wardrobe Towers.

# Native Technology

## Wire Management

Native accommodated wire management needs in a variety of ways, from ample technology choices to innovative adjustments.

PRODUCT INFORMATION

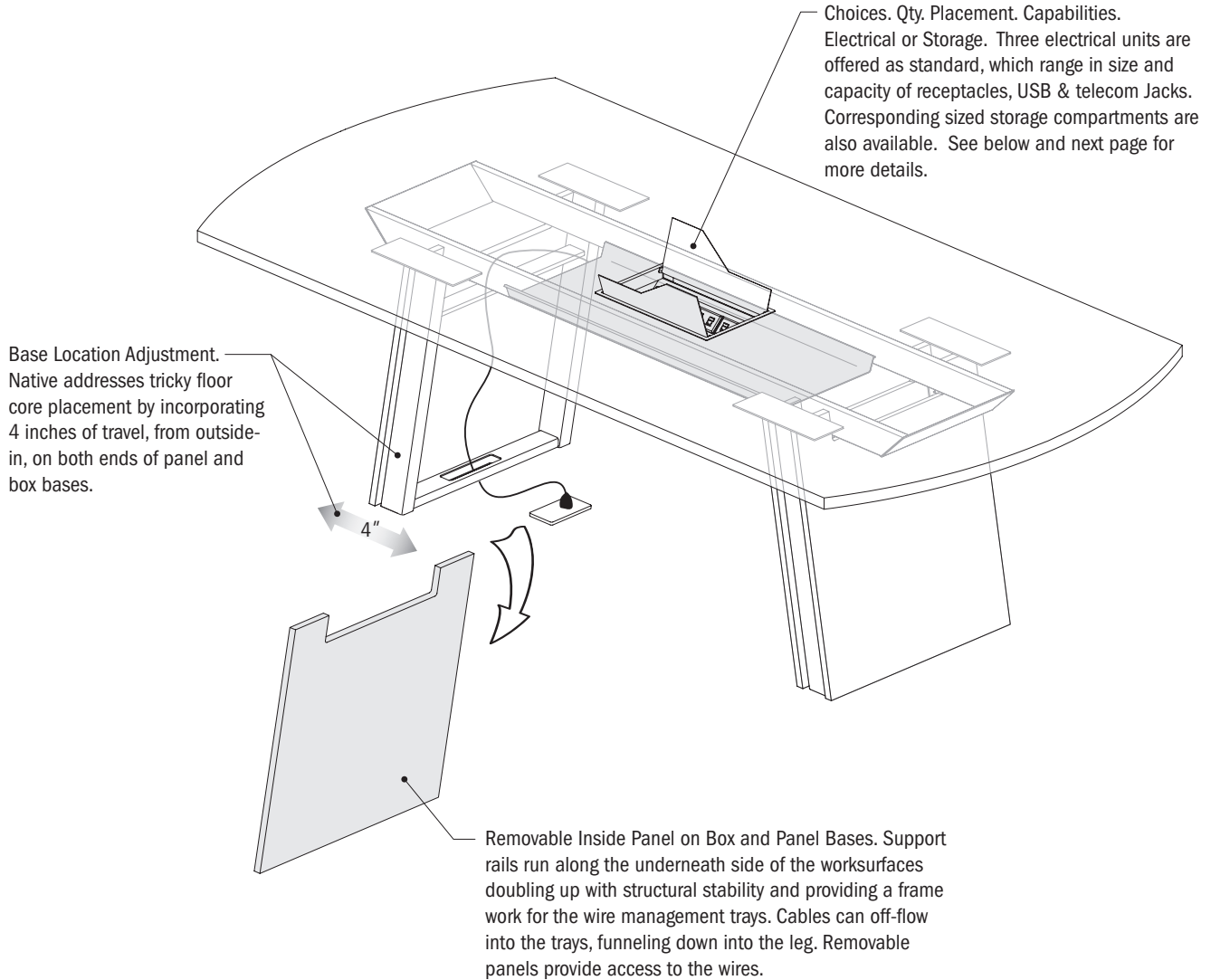

## Worksurface Power Units and Storage Compartments

(See chart on next page for cutout code configurations)



**EC36 - Cove Power Unit**  
Cutout Code C  
Available in silver, black, or white



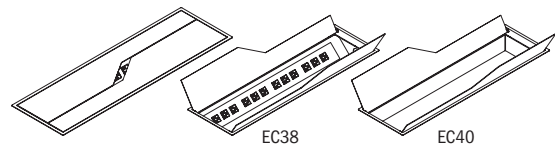

**EC37 - Oasis Mini Power Unit**  
**EC39 - Small Storage Compartment**  
Cutout Code M  
Available in arctic silver, bright white, matte black, pewter, or soft nickel



**EC38 - Oasis Power Unit**  
**EC40 - Large Storage Compartment**  
Cutout Code O  
Available in arctic silver, bright white, matte black, pewter, or soft nickel

Native Technology

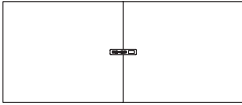
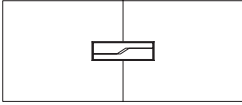
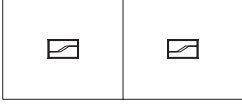
Power Unit and Storage Compartment Worksurface Cutout Code Configurations

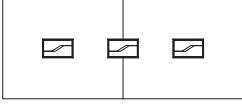
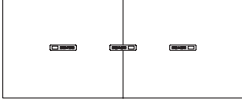
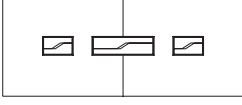
Cutout Code	Width	Square & Round Tables			1 Piece Tables, All Shapes					2 Piece Tables, All Shapes					
		48"	54"	60"	72"	84"	96"	108"	120"	132"	144"	168"	192"	216"	240"
<b>C1M</b>  1 Cutout: Oasis Mini		✓	✓	✓	✓	✓	✓	✓	✓	✓	✓	✓	✓	✓	✓
<b>C1C</b>  1 Cutout: Cove		✓	✓	✓	✓	✓	✓	✓	✓	✓	✓	✓	✓	✓	✓
<b>C1O</b>  1 Cutout: Oasis									✓	✓	✓	✓	✓	✓	✓
<b>C2M</b>  2 Cutouts: both Oasis Mini									✓	✓	✓	✓	✓	✓	✓
<b>C2C</b>  2 Cutouts: both Cove									✓	✓	✓	✓	✓	✓	✓
<b>C3M</b>  3 Cutouts: all Oasis Mini									✓	✓	✓	✓	✓	✓	✓
<b>C3C</b>  3 Cutouts: all Cove									✓	✓	✓	✓	✓	✓	✓
<b>C3MOM</b>  3 Cutouts: Mini, Oasis, Mini									✓	✓	✓	✓	✓	✓	✓

Native Typicals

NA001

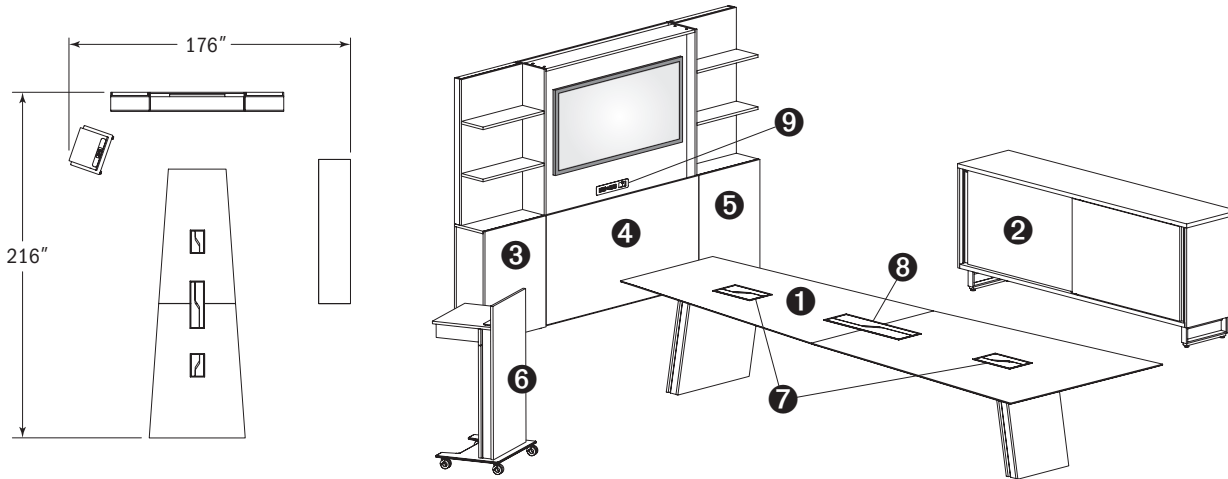

PRODUCT INFORMATION

Model	Description	Qty	Laminate	Flat Cut	Double Cut
1 NA_60168-30VTPB	view 2pc table with 2 panel bases, reverse bevel edge	1	\$10,366	\$13,021	\$14,587
2 NA_2090-36SCD	buffet credenza	1	\$4,027	\$4,909	\$5,711
3 NA_1224-74SSUR	open shelf tower, right	1	\$1,787	\$2,318	\$2,697
4 NA_1260-74CMUF	media wall with TV bracket	1	\$2,249	\$2,854	\$3,286
5 NA_1224-74SSUL	open shelf tower, left	1	\$1,787	\$2,318	\$2,697
6 NA_2026-47LES	mobile lectern with storage	1	\$3,604	\$4,239	\$4,663
7 EC37	oasis mini power unit	2	\$1,325	\$1,325	\$1,325
8 EC40	large storage unit	1	\$978	\$978	\$978
9 EC36	cove power unit	1	\$760	\$760	\$760
<b>Typical List Price</b>			<b>\$28,208</b>	<b>\$34,047</b>	<b>\$38,029</b>

NA002

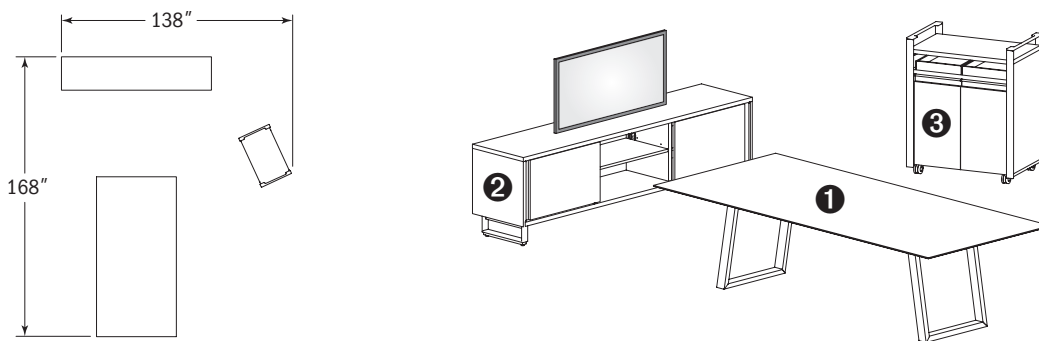

Model	Description	Qty	Laminate	Flat Cut	Double Cut
1 NA_4896-30TLB	rectangular table with open loop base, reverse bevel edge	1	\$4,745	\$6,172	\$6,730
2 NA_2090-26SCO	open storage credenza	1	\$3,899	\$4,783	\$5,562
3 NA_2033-40HCD	hospitality cart	1	\$4,199	\$5,058	\$5,719
<b>Typical List Price</b>			<b>\$12,843</b>	<b>\$16,013</b>	<b>\$18,011</b>

Native Typicals

NA003

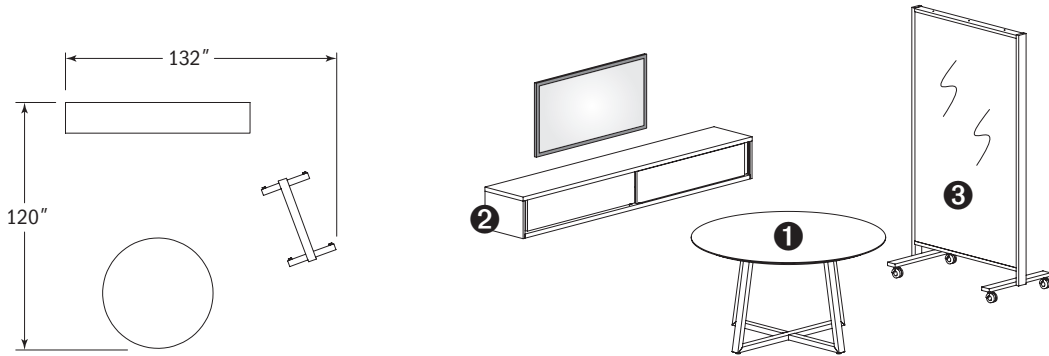

Model	Description	Qty	Laminate	Flat Cut	Double Cut
1 NA_5454-30RDXB	round table with X base, reverse bevel edge	1	\$2,822	\$3,516	\$3,878
2 NA_1590-12WSC	wall storage credenza	1	\$2,367	\$3,034	\$3,429
3 NAB2442-75MMB	mobile board	1	\$3,878	\$3,878	\$3,878
<b>Typical List Price</b>			<b>\$9,067</b>	<b>\$10,428</b>	<b>\$11,185</b>

PRODUCT INFORMATION

NA004

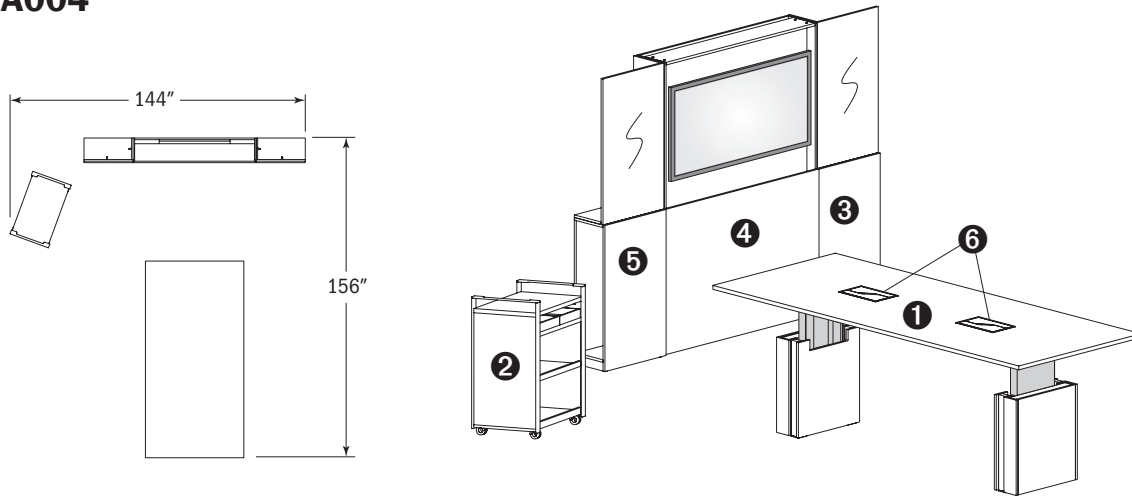

Model	Description	Qty	Laminate	Flat Cut	Double Cut
1 NA_4896-30TTAH	rectangular table with height adjustable base, eased edge	1	\$9,909	\$13,288	\$14,142
2 NA_2033-40HCO	hospitality cart - open	1	\$3,484	\$4,098	\$4,526
3 NA_1224-84SWUR	side access wardrobe tower, optional white markerboard panel right	1	\$1,932	\$2,449	\$2,815
4 NA_1260-84CMUF	media wall with TV bracket	1	\$2,315	\$2,942	\$3,387
5 NA_1224-84SWUL	side access wardrobe tower, optional white markerboard panel left	1	\$1,932	\$2,449	\$2,815
6 EC37	Oasis mini power unit	2	\$1,325	\$1,325	\$1,325
<b>Typical List Price</b>			<b>\$22,222</b>	<b>\$27,876</b>	<b>\$30,335</b>



Native Typicals

NA005

PRODUCT INFORMATION

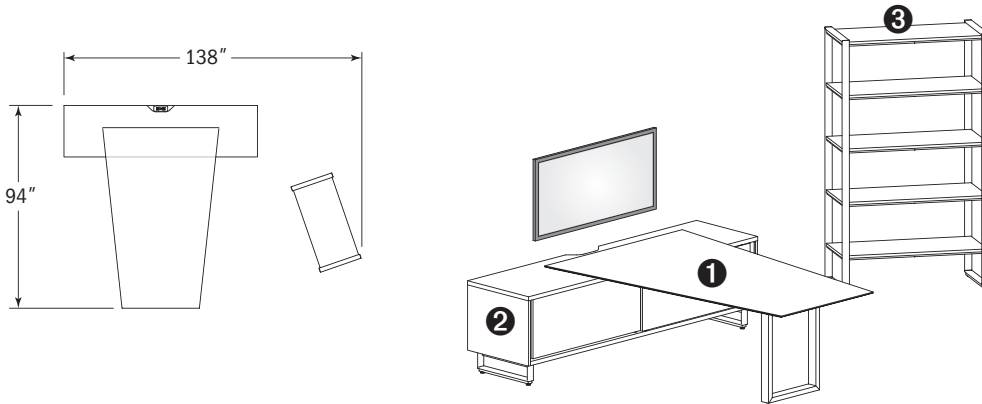

Model	Description	Qty	Laminate	Flat Cut	Double Cut
1 NA_5484-30VTPLB	view peninsula table with open loop base, reverse bevel edge	1	\$3,096	\$3,378	\$3,934
2 NA_2490-26PCO	power open storage credenza	1	\$4,618	\$5,598	\$6,328
3 NA_2042-72SHU	open shelves	1	\$3,594	\$4,226	\$4,668
<b>Typical List Price</b>			<b>\$11,308</b>	<b>\$13,202</b>	<b>\$14,930</b>

NA006

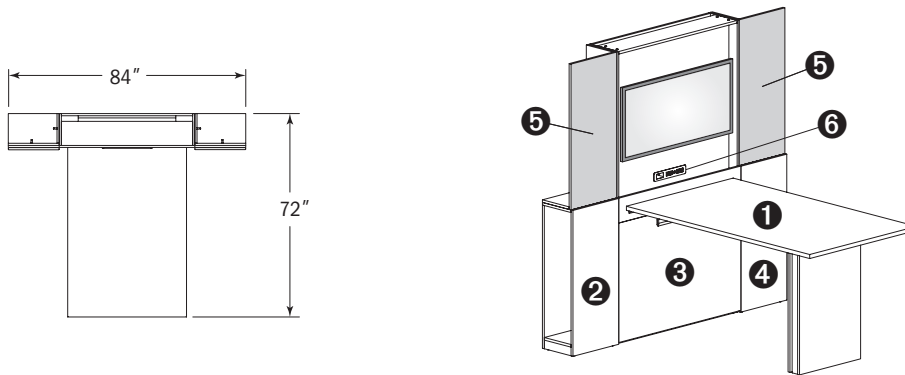

Model	Description	Qty	Laminate	Flat Cut	Double Cut
1 NA_4260-40TTRPB	standing height rectangular runoff table with panel base	1	\$2,742	\$3,304	\$3,843
2 NA_1218-84SWUR	side access wardrobe tower, right	1	\$1,677	\$2,176	\$2,530
3 NA_1248-84CMUC	media wall - table mount with TV bracket	1	\$2,260	\$2,872	\$3,305
4 NA_1218-84SWUL	side access wardrobe tower, left	1	\$1,677	\$2,176	\$2,530
5 NAB1842TK	tackboard for side access wardrobe tower, COM fabric grade	2	\$207	\$207	\$207
6 EC36	Cove power unit	1	\$760	\$760	\$760
<b>Typical List Price</b>			<b>\$9,530</b>	<b>\$11,702</b>	<b>\$13,382</b>

Notes

Description

Rectangular 2pc Table with 3 Open Loop Bases

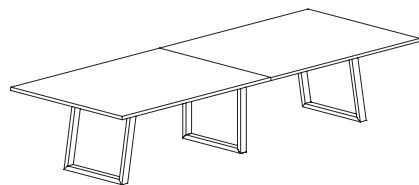

Laminate Tops "NAT" Models

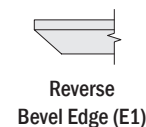
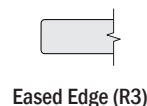

Features:

- three metal, open loop bases with structural support rails
- two-piece top
- glass top has additional seams

Options:

- metal frame available in powder coat, no upcharge, or chrome, add list upcharge: for 48" wide - \$2,555, for 54" & 60" wide - \$2,923
- worksurface power & storage available, specify cutout code and order power units separately, see pages 150-151
- magnetic wire manager available: order separately see page 150

D	W	H	CTN WT	CU FT	① Model	HPL	HPL
60	192	29 3/8	555	130	NAT60192-30TTLB	\$11,277	\$11,758
60	168	29 3/8	490	116	NAT60168-30TTLB	\$9,517	\$9,998
60	144	29 3/8	440	104	NAT60144-30TTLB	\$8,392	\$8,873
54	192	29 3/8	510	124	NAT54192-30TTLB	\$11,036	\$11,517
54	168	29 3/8	449	110	NAT54168-30TTLB	\$8,836	\$9,317
54	144	29 3/8	401	98	NAT54144-30TTLB	\$7,983	\$8,463
54	132	29 3/8	376	84	NAT54132-30TTLB	\$7,647	\$8,128
48	192	29 3/8	464	116	NAT48192-30TTLB	\$9,390	\$9,871
48	168	29 3/8	408	90	NAT48168-30TTLB	\$8,401	\$8,883
48	144	29 3/8	366	84	NAT48144-30TTLB	\$7,531	\$8,012
48	132	29 3/8	344	78	NAT48132-30TTLB	\$7,280	\$7,761

NATIVE

To Order, Specify:

① Laminate Model #	② Top Laminate	③ Top Edge	④ Metal Color	⑤ Electrical
Laminate (NAT)	<p>Solid Patterns:</p> <p>ALB Alabaster BBL Bridal Bianco DWH Designer White SHD Shadow SLG Slate Grey</p> <p>Wood Grain Patterns:</p> <p>AGA Aged Ash ALL Ale Light BLO Blonde Echo BOL Bourbon Light BZW Brazilwood</p> <p>BGL Brighton Light CLL Collectors FLO Florence Walnut GRH Graphite HGL High Line</p> <p>OAT Oatmeal Cookie PIN Pinnacle Walnut STU Studio Teak VIN Vintage WLH Walnut Heights WEA Weathered Ash</p>	<p>Edge Selection:</p> <p>R3 Eased E1 Reverse Bevel</p>	<p>Color:</p> <p>ASL Arctic Silver BWH Bright White MBK Matte Black PEW Pewter SNK Soft Nickel RML Raw (Clear) CHR Chrome* *Upcharge applies</p>	<p>Cutout Codes:</p> <p>N all tables C1M 132" - 192" wide C1C 132" - 192" wide C1O 132" - 192" wide C2M 132" - 192" wide C2C 132" - 192" wide C3C 132" - 192" wide C3M 132" - 192" wide C3MOM 132" - 192" wide</p>

Description

Rectangular 2pc Table with 3 Open Loop Bases  
(continued)

Veneer Tops "NAV" Models

Premier Tops "NAV" Models



Eased Edge (R3)



Reverse Bevel Edge (E1)

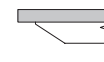

Solid Surface/Glass Reverse Bevel Edge



Wood Plank Ash



Sub-Top with Base

D	W	H	CTN WT	CU FT	Model	Veneer Tops "NAV" Models		Premier Tops "NAV" Models		Solid Surface	Glass	Wood Plank Ash	Sub-Top with Base
						Flat Cut	Double Cut	Flat Cut	Double Cut				
60	192	29 3/8	555	130	NAV60192-30TTLB	\$15,051	\$17,056	\$15,297	\$17,304	\$31,866	\$30,189	--	\$14,286
60	168	29 3/8	490	116	NAV60168-30TTLB	\$12,362	\$13,903	\$12,608	\$14,149	\$27,127	\$25,609	--	\$11,796
60	144	29 3/8	440	104	NAV60144-30TTLB	\$10,977	\$12,404	\$11,223	\$12,651	\$23,695	\$22,330	--	\$10,475
54	192	29 3/8	510	124	NAV54192-30TTLB	\$14,729	\$16,314	\$14,976	\$16,561	\$29,909	\$28,355	--	\$13,988
54	168	29 3/8	449	110	NAV54168-30TTLB	\$11,560	\$12,775	\$11,806	\$13,022	\$24,895	\$23,482	--	\$11,036
54	144	29 3/8	401	98	NAV54144-30TTLB	\$10,484	\$11,612	\$10,732	\$11,859	\$21,974	\$20,704	--	\$10,008
54	132	29 3/8	376	84	NAV54132-30TTLB	\$10,057	\$11,147	\$10,304	\$11,394	\$20,589	\$19,425	--	\$9,600
48	192	29 3/8	464	116	NAV48192-30TTLB	\$12,799	\$14,335	\$13,046	\$14,582	\$26,341	\$24,910	--	\$12,150
48	168	29 3/8	408	90	NAV48168-30TTLB	\$11,048	\$12,249	\$11,295	\$12,496	\$22,952	\$21,646	--	\$10,547
48	144	29 3/8	366	84	NAV48144-30TTLB	\$9,958	\$11,073	\$10,204	\$11,319	\$20,222	\$19,041	--	\$9,507
48	132	29 3/8	344	78	NAV48132-30TTLB	\$9,625	\$10,705	\$9,872	\$10,951	\$19,036	\$17,952	--	\$9,190

NATIVE

To Order, Specify:

1 Veneer Model #	2 Wood Species	3 Top Wood Finish	4 Top Edge	5 Metal Color	6 Electrical	
Veneer (NAV)	Flat Cut CH1 Cherry MA1 Maple WA1 Walnut	Cherry: BRL Barley BBM Bourbon Medium BRM Brighton Medium CLA Classic CLL Collectors* EAR Earthy HRV Harvest* LGC Legacy PRL Praline* SAF Saffron Maple: ALM Ale Medium BUT Butterscotch CIN Cinnamon FLX Flax VEN Venetian Walnut: AUB Auburn ESP Espresso MCH Mocha* NTO Night Owl* SIE Sienna* TOF Toffee TRF Truffle*	Finishes with an asterisk (*) have a coordinating laminate available	Edge Selection: R3 Eased E1 Reverse Bevel	Color: ASL Arctic Silver BWH Bright White MBK Matte Black PEW Pewter SNK Soft Nickel RML Raw (Clear) CHR Chrome* *Upcharge applies	Cutout Codes: N all tables C1M 132" - 192" wide C1C 132" - 192" wide C1O 132" - 192" wide C2M 132" - 192" wide C2C 132" - 192" wide C3C 132" - 192" wide C3M 132" - 192" wide C3MOM 132" - 192" wide See chart on page 45 for cutout codes
	Double Cut DC1 Double Cut	3 Top Wood Finish Double Cut: COF Coffee CRM Cremello FOS Fossil GRH Graphite KHK Khaki STU Studio Teak				

1 Specialty Top Model #	2 Top Surface Selection	3 Metal Color	4 Electrical
Solid Surface (NAV)	Patterns: ARM Armadillo BLP Black Pearl PEB Pebble Pearl PUR Pure White	See list above for Metal Paint Colors	Cutout Codes: N all tables C1M 132" - 192" wide C1C 132" - 192" wide C1O 132" - 192" wide C2M 132" - 192" wide C2C 132" - 192" wide C3C 132" - 192" wide C3M 132" - 192" wide C3MOM 132" - 192" wide
Glass Surface (NAV)	Backpainted Glass: G White Glossy M White Matte		
Sub-Top w/Base (NAV)	B (Table Ships with Sub-Top, Customer applies custom Top)		

Description

Rectangular Table with Open Loop Base

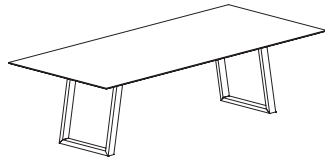

Laminate Tops "NAT" Models

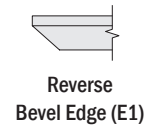
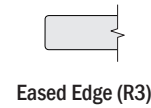

Features:

- two metal, open loop bases with structural support rails
- one-piece top
- glass top has additional seams

Options:

- metal base frame available in powder coat, no upcharge, or chrome, add list upcharge: for 36" wide - \$1,694, for 42" & 48" wide - \$1,966, for 54" wide - \$2,249
- worksurface power & storage available, specify cutout code and order power units separately, see pages 150-151
- magnetic wire manager available; order separately, see page 150

D	W	H	CTN WT	CU FT	① Model	HPL	HPL
54	120	29 3/8	312	78	NAT54120-30TTLB	\$5,317	\$5,697
48	120	29 3/8	283	76	NAT48120-30TTLB	\$5,057	\$5,439
48	108	29 3/8	247	70	NAT48108-30TTLB	\$4,819	\$5,201
48	96	29 3/8	241	63	NAT4896-30TTLB	\$4,363	\$4,745
48	84	29 3/8	221	57	NAT4884-30TTLB	\$4,168	\$4,549
48	72	29 3/8	194	53	NAT4872-30TTLB	\$3,870	\$4,251
42	120	29 3/8	247	72	NAT42120-30TTLB	\$4,977	\$5,358
42	108	29 3/8	247	68	NAT42108-30TTLB	\$4,667	\$5,049
42	96	29 3/8	241	62	NAT4296-30TTLB	\$4,228	\$4,609
42	84	29 3/8	204	61	NAT4284-30TTLB	\$4,050	\$4,430
42	72	29 3/8	179	51	NAT4272-30TTLB	\$3,829	\$4,211
36	84	29 3/8	183	53	NAT3684-30TTLB	\$4,002	\$4,384
36	72	29 3/8	164	49	NAT3672-30TTLB	\$3,789	\$4,170

NATIVE

To Order, Specify:

① Laminate Model #	② Top Laminate	③ Top Edge	④ Metal Color	⑤ Electrical
Laminate (NAT)	<p>Solid Patterns:</p> <p>ALB Alabaster BBL Bridal Blanco DWH Designer White SHD Shadow SLG Slate Grey</p> <p>Wood Grain Patterns:</p> <p>AGA Aged Ash ALL Ale Light BLO Blonde Echo BOL Bourbon Light BZW Brazilwood</p> <p>BGL Brighton Light CLL Collectors FLO Florence Walnut GRH Graphite HGL High Line</p> <p>OAT Oatmeal Cookie PIN Pinnacle Walnut STU Studio Teak VIN Vintage WLH Walnut Heights WEA Weathered Ash</p>	<p>Edge Selection:</p> <p>R3 Eased E1 Reverse Bevel</p>	<p>Color:</p> <p>ASL Arctic Silver BWH Bright White MBK Matte Black PEW Pewter SNK Soft Nickel RML Raw (Clear) CHR Chrome* *Upcharge applies</p>	<p>Cutout Codes:</p> <p>N all tables C1M 72" - 120" wide C1C 72" - 120" wide C1O 120" wide C2M 96" - 120" wide C2C 96" - 120" wide C3M 120" wide C3C 120" wide C3MOM 120" wide</p>

Description

Rectangular Table with Open Loop Base  
(continued)

						Veneer Tops "NAV" Models				Premier Tops "NAV" Models			
						Eased Edge (R3)		Reverse Bevel Edge (E1)		Solid Surface/Glass Reverse Bevel Edge		Wood Plank Ash	
D	W	H	CTN WT	CU FT	1 Model	Flat Cut	Double Cut	Flat Cut	Double Cut	Solid Surface	Glass	Wood Plank Ash	Sub-Top with Base
54	120	29 3/8	312	78	NAV54120-30TTLB	\$7,304	\$8,078	\$7,452	\$8,225	\$16,951	\$15,821	--	\$6,977
48	120	29 3/8	283	76	NAV48120-30TTLB	\$6,984	\$7,677	\$7,131	\$7,823	\$15,607	\$14,553	\$12,362	\$6,669
48	108	29 3/8	247	70	NAV48108-30TTLB	\$6,653	\$7,280	\$6,800	\$7,428	\$14,455	\$13,467	\$11,494	\$6,355
48	96	29 3/8	241	63	NAV4896-30TTLB	\$6,025	\$6,585	\$6,172	\$6,730	\$12,944	\$12,081	\$10,328	\$5,754
48	84	29 3/8	221	57	NAV4884-30TTLB	\$5,754	\$6,246	\$5,901	\$6,394	\$11,858	\$11,054	\$9,520	\$5,497
48	72	29 3/8	194	53	NAV4872-30TTLB	\$5,343	\$5,768	\$5,491	\$5,915	\$10,631	\$9,886	\$8,571	\$5,105
42	120	29 3/8	247	72	NAV42120-30TTLB	\$6,872	\$7,478	\$7,018	\$7,625	\$14,418	\$13,495	\$11,577	\$6,563
42	108	29 3/8	247	68	NAV42108-30TTLB	\$6,443	\$6,992	\$6,591	\$7,140	\$13,271	\$12,404	\$10,679	\$6,153
42	96	29 3/8	241	62	NAV4296-30TTLB	\$5,837	\$6,332	\$5,984	\$6,478	\$11,942	\$11,136	\$9,603	\$5,574
42	84	29 3/8	204	61	NAV4284-30TTLB	\$5,592	\$6,026	\$5,739	\$6,173	\$10,981	\$10,228	\$8,886	\$5,340
42	72	29 3/8	179	51	NAV4272-30TTLB	\$5,287	\$5,663	\$5,434	\$5,810	\$9,961	\$9,261	\$8,110	\$5,050
36	84	29 3/8	183	53	NAV3684-30TTLB	\$5,527	\$5,905	\$5,672	\$6,052	\$10,201	\$9,501	\$8,350	\$5,278
36	72	29 3/8	164	49	NAV3672-30TTLB	\$5,230	\$5,557	\$5,378	\$5,703	\$9,293	\$8,638	\$7,651	\$4,996

NATIVE

To Order, Specify:

1 Veneer Model #	2 Wood Species	3 Top Wood Finish	4 Top Edge	5 Metal Color	6 Electrical
Veneer (NAV)	Flat Cut CH1 Cherry MA1 Maple WA1 Walnut	Cherry: BR1 Barley BBM Bourbon Medium BRM Brighton Medium CLA Classic CLL Collectors* EAR Earthy HRV Harvest* LGC Legacy PRL Praline* SAF Saffron Finishes with an asterisk (*) have a coordinating laminate available	Edge Selection: R3 Eased E1 Reverse Bevel	Color: ASL Arctic Silver BWH Bright White MBK Matte Black PEW Pewter SNK Soft Nickel RML Raw (Clear) CHR Chrome* *Upcharge applies	Cutout Codes: N all tables C1M 72" - 120" wide C1C 72" - 120" wide C1O 120" wide C2M 96" - 120" wide C2C 96" - 120" wide C3M 120" wide C3C 120" wide C3MOM 120" wide See chart on page 45 for cutout codes and power and storage unit configurations
	Double Cut DC1 Double Cut	Maple: ALM Ale Medium BUT Butterscotch CIN Cinnamon FLX Flax VEN Venetian Walnut: AUB Auburn ESP Espresso MCH Mocha* NTO Night Owl* SIE Sienna* TOF Toffee TRF Truffle* Double Cut: COF Coffee FOS Fossil KHK Khaki CRM Cremello GRH Graphite STU Studio Teak			

1 Specialty Top Model #	2 Top Surface Selection	3 Metal Color	4 Electrical
Solid Surface (NAV)	Patterns: ARM Armadillo PEB Pebble Pearl BLP Black Pearl PUR Pure White	See list above for Metal Paint Colors	Cutout Codes: N all tables C1M 72" - 120" wide C1C 72" - 120" wide C1O 120" wide C2M 96" - 120" wide C2C 96" - 120" wide C3M 120" wide C3C 120" wide C3MOM 120" wide
Glass Surface (NAV)	Backpainted Glass: G White Glossy M White Matte		
Wood Plank (NAV)	W Wood Plank Ash, Clear Coat		
Sub-Top w/Base (NAV)	B (Table Ships with Sub-Top, Customer applies custom Top)		

Description

Arc End 2pc Table with 3 Open Loop Bases

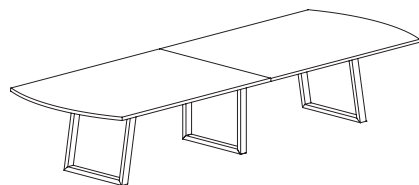

Laminate Tops "NAT" Models

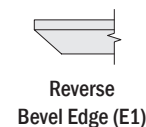
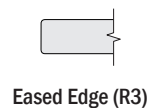

Features:

- three metal, open loop bases with structural support rails
- two-piece top
- glass top has additional seams

Options:

- metal frame available in powder coat, no upcharge, or chrome, add list upcharge: for 48" wide - \$2,555, for 54" & 60" wide - \$2,923
- worksurface power & storage available, specify cutout code and order power units separately, see pages 150-151
- magnetic wire manager available: order separately see page 150

D	W	H	CTN WT	CU FT	① Model	HPL	HPL
60	192	29 3/8	547	130	NAT60192-30ARLB	\$11,277	\$11,758
60	168	29 3/8	482	116	NAT60168-30ARLB	\$9,517	\$9,998
60	144	29 3/8	431	104	NAT60144-30ARLB	\$8,392	\$8,873
54	192	29 3/8	503	124	NAT54192-30ARLB	\$11,036	\$11,517
54	168	29 3/8	442	110	NAT54168-30ARLB	\$8,836	\$9,317
54	144	29 3/8	394	98	NAT54144-30ARLB	\$7,983	\$8,463
54	132	29 3/8	370	84	NAT54132-30ARLB	\$7,647	\$8,128
48	192	29 3/8	459	116	NAT48192-30ARLB	\$9,390	\$9,871
48	168	29 3/8	403	90	NAT48168-30ARLB	\$8,401	\$8,883
48	144	29 3/8	360	84	NAT48144-30ARLB	\$7,531	\$8,012
48	132	29 3/8	339	78	NAT48132-30ARLB	\$7,280	\$7,761

NATIVE

To Order, Specify:

① Laminate Model #	② Top Laminate	③ Top Edge	④ Metal Color	⑤ Electrical
Laminate (NAT)	<p>Solid Patterns:</p> <p>ALB Alabaster BBL Bridal Bianco DWH Designer White SHD Shadow SLG Slate Grey</p> <p>Wood Grain Patterns:</p> <p>AGA Aged Ash ALL Ale Light BLO Blonde Echo BOL Bourbon Light BZW Brazilwood</p> <p>BGL Brighton Light CLL Collectors FLO Florence Walnut GRH Graphite HGL High Line</p> <p>OAT Oatmeal Cookie PIN Pinnacle Walnut STU Studio Teak VIN Vintage WLH Walnut Heights WEA Weathered Ash</p>	<p>Edge Selection:</p> <p>R3 Eased E1 Reverse Bevel</p>	<p>Color:</p> <p>ASL Arctic Silver BWH Bright White MBK Matte Black PEW Pewter SNK Soft Nickel RML Raw (Clear) CHR Chrome* *Upcharge applies</p>	<p>Cutout Codes:</p> <p>N all tables C1M 132" - 192" wide C1C 132" - 192" wide C1O 132" - 192" wide C2M 132" - 192" wide C2C 132" - 192" wide C3C 132" - 192" wide C3M 132" - 192" wide C3MOM 132" - 192" wide</p>

Description

Arc End 2pc Table with 3 Open Loop Bases  
(continued)

						Veneer Tops "NAV" Models				Premier Tops "NAV" Models			
						Eased Edge (R3)		Reverse Bevel Edge (E1)		Solid Surface/Glass Reverse Bevel Edge			
D	W	H	CTN WT	CU FT	1 Model	Flat Cut	Double Cut	Flat Cut	Double Cut	Solid Surface	Glass	Wood Plank Ash	Sub-Top with Base
60	192	29 3/8	547	130	NAV60192-30ARLB	\$15,051	\$17,056	\$15,297	\$17,304	\$31,866	\$30,189	--	\$14,286
60	168	29 3/8	482	116	NAV60168-30ARLB	\$12,362	\$13,903	\$12,608	\$14,149	\$27,127	\$25,609	--	\$11,796
60	144	29 3/8	431	104	NAV60144-30ARLB	\$10,977	\$12,404	\$11,223	\$12,651	\$23,695	\$22,330	--	\$10,475
54	192	29 3/8	503	124	NAV54192-30ARLB	\$14,729	\$16,314	\$14,976	\$16,561	\$29,909	\$28,355	--	\$13,988
54	168	29 3/8	442	110	NAV54168-30ARLB	\$11,560	\$12,775	\$11,806	\$13,022	\$24,895	\$23,482	--	\$11,036
54	144	29 3/8	394	98	NAV54144-30ARLB	\$10,484	\$11,612	\$10,732	\$11,859	\$21,974	\$20,704	--	\$10,008
54	132	29 3/8	370	84	NAV54132-30ARLB	\$10,057	\$11,147	\$10,304	\$11,394	\$20,589	\$19,425	--	\$9,600
48	192	29 3/8	459	116	NAV48192-30ARLB	\$12,799	\$14,335	\$13,046	\$14,582	\$26,341	\$24,910	--	\$12,150
48	168	29 3/8	403	90	NAV48168-30ARLB	\$11,048	\$12,249	\$11,295	\$12,496	\$22,952	\$21,646	--	\$10,547
48	144	29 3/8	360	84	NAV48144-30ARLB	\$9,958	\$11,073	\$10,204	\$11,319	\$20,222	\$19,041	--	\$9,507
48	132	29 3/8	339	78	NAV48132-30ARLB	\$9,625	\$10,705	\$9,872	\$10,951	\$19,036	\$17,952	--	\$9,190

NATIVE

To Order, Specify:

1 Veneer Model #	2 Wood Species	3 Top Wood Finish	4 Top Edge	5 Metal Color	6 Electrical
Veneer (NAV)	Flat Cut CH1 Cherry MA1 Maple WA1 Walnut	Cherry: BRL Barley BBM Bourbon Medium BRM Brighton Medium CLA Classic CLL Collectors* EAR Earthy HRV Harvest* LGC Legacy PRL Praline* SAF Saffron Maple: ALM Ale Medium BUT Butterscotch CIN Cinnamon FLX Flax VEN Venetian Walnut: AUB Auburn ESP Espresso MCH Mocha* NTO Night Owl* SIE Sienna* TOF Toffee TRF Truffle* Finishes with an asterisk (*) have a coordinating laminate available	Edge Selection: R3 Eased E1 Reverse Bevel	Color: ASL Arctic Silver BWH Bright White MBK Matte Black PEW Pewter SNK Soft Nickel RML Raw (Clear) CHR Chrome* *Upcharge applies	Cutout Codes: N all tables C1M 132" - 192" wide C1C 132" - 192" wide C1O 132" - 192" wide C2M 132" - 192" wide C2C 132" - 192" wide C3C 132" - 192" wide C3M 132" - 192" wide C3MOM 132" - 192" wide See chart on page 45 for cutout codes
	Double Cut DC1 Double Cut	3 Top Wood Finish Double Cut: COF Coffee CRM Cremello FOS Fossil GRH Graphite KHK Khaki STU Studio Teak			

1 Specialty Top Model #	2 Top Surface Selection	3 Metal Color	4 Electrical
Solid Surface (NAV)	Patterns: ARM Armadillo BLP Black Pearl PEB Pebble Pearl PUR Pure White	See list above for Metal Paint Colors	Cutout Codes: N all tables C1M 132" - 192" wide C1C 132" - 192" wide C1O 132" - 192" wide C2M 132" - 192" wide C2C 132" - 192" wide C3C 132" - 192" wide C3M 132" - 192" wide C3MOM 132" - 192" wide
Glass Surface (NAV)	Backpainted Glass: G White Glossy M White Matte		
Sub-Top w/Base (NAV)	B (Table Ships with Sub-Top, Customer applies custom Top)		



Description

Arc End Table with Open Loop Base

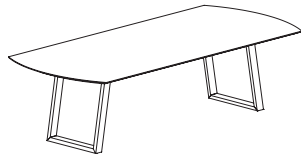

Laminate Tops "NAT" Models

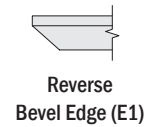
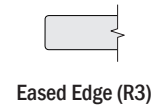

Features:

- two metal, open loop bases with structural support rails
- one-piece top
- glass top has additional seams

Options:

- metal base frame available in powder coat, no upcharge, or chrome, add list upcharge: for 36" wide - \$1,694, for 42" & 48" wide - \$1,966, for 54" wide - \$2,249
- worksurface power & storage available, specify cutout code and order power units separately, see pages 150-151
- magnetic wire manager available; order separately, see page 150

D	W	H	CTN WT	CU FT	① Model	HPL	HPL
54	120	29 3/8	305	78	NAT54120-30ARLB	\$3,679	\$4,061
48	120	29 3/8	277	76	NAT48120-30ARLB	\$5,057	\$5,439
48	108	29 3/8	263	70	NAT48108-30ARLB	\$4,819	\$5,201
48	96	29 3/8	195	63	NAT4896-30ARLB	\$4,363	\$4,745
48	84	29 3/8	216	57	NAT4884-30ARLB	\$4,168	\$4,549
48	72	29 3/8	140	29	NAT4872-30ARLB	\$3,870	\$4,251
42	120	29 3/8	254	72	NAT42120-30ARLB	\$4,977	\$5,358
42	108	29 3/8	254	68	NAT42108-30ARLB	\$4,667	\$5,049
42	96	29 3/8	207	62	NAT4296-30ARLB	\$4,228	\$4,609
42	84	29 3/8	199	61	NAT4284-30ARLB	\$4,050	\$4,430
42	72	29 3/8	119	51	NAT4272-30ARLB	\$3,829	\$4,211
36	84	29 3/8	179	53	NAT3684-30ARLB	\$4,002	\$4,384
36	72	29 3/8	111	49	NAT3672-30ARLB	\$3,789	\$4,170

NATIVE

To Order, Specify:

① Laminate Model #	② Top Laminate	③ Top Edge	④ Metal Color	⑤ Electrical
Laminate (NAT)	<p>Solid Patterns:</p> <p>ALB Alabaster BBL Bridal Blanco DWH Designer White SHD Shadow SLG Slate Grey</p> <p>Wood Grain Patterns:</p> <p>AGA Aged Ash ALL Ale Light BLO Blonde Echo BOL Bourbon Light BZW Brazilwood</p> <p>BGL Brighton Light CLL Collectors FLO Florence Walnut GRH Graphite HGL High Line</p> <p>OAT Oatmeal Cookie PIN Pinnacle Walnut STU Studio Teak VIN Vintage WLH Walnut Heights WEA Weathered Ash</p>	<p>Edge Selection:</p> <p>R3 Eased E1 Reverse Bevel</p>	<p>Color:</p> <p>ASL Arctic Silver BWH Bright White MBK Matte Black PEW Pewter SNK Soft Nickel RML Raw (Clear) CHR Chrome* *Upcharge applies</p>	<p>Cutout Codes:</p> <p>N all tables C1M 72" - 120" wide C1C 72" - 120" wide C1O 120" wide C2M 96" - 120" wide C2C 96" - 120" wide C3M 120" wide C3C 120" wide C3MOM 120" wide</p>

Description

Arc End Table with Open Loop Base  
(continued)

Veneer Tops "NAV" Models Premier Tops "NAV" Models

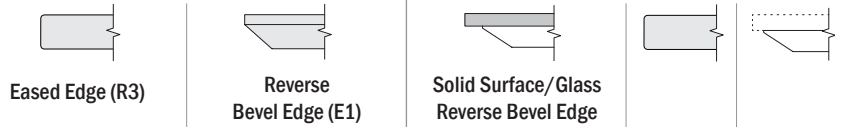

D	W	H	CTN WT	CU FT	① Model	Veneer Tops "NAV" Models		Premier Tops "NAV" Models		Solid Surface	Glass	Wood Plank Ash	Sub-Top with Base
						Flat Cut	Double Cut	Flat Cut	Double Cut				
54	120	29 3/8	305	78	NAV54120-30ARLB	\$5,055	\$5,828	\$5,203	\$5,975	\$14,702	\$13,570	--	\$4,828
48	120	29 3/8	277	76	NAV48120-30ARLB	\$6,984	\$7,677	\$7,131	\$7,823	\$15,607	\$14,553	--	\$6,669
48	108	29 3/8	263	70	NAV48108-30ARLB	\$6,653	\$7,280	\$6,800	\$7,428	\$14,455	\$13,467	--	\$6,355
48	96	29 3/8	195	63	NAV4896-30ARLB	\$6,025	\$6,585	\$6,172	\$6,730	\$12,944	\$12,081	--	\$5,754
48	84	29 3/8	216	57	NAV4884-30ARLB	\$5,754	\$6,246	\$5,901	\$6,394	\$11,858	\$11,054	--	\$5,497
48	72	29 3/8	140	29	NAV4872-30ARLB	\$5,343	\$5,768	\$5,491	\$5,915	\$10,631	\$9,886	--	\$5,105
42	120	29 3/8	254	72	NAV42120-30ARLB	\$6,872	\$7,478	\$7,018	\$7,625	\$14,418	\$13,495	--	\$6,563
42	108	29 3/8	254	68	NAV42108-30ARLB	\$6,443	\$6,992	\$6,591	\$7,140	\$13,271	\$12,404	--	\$6,153
42	96	29 3/8	207	62	NAV4296-30ARLB	\$5,837	\$6,332	\$5,984	\$6,478	\$11,942	\$11,136	--	\$5,574
42	84	29 3/8	199	61	NAV4284-30ARLB	\$5,592	\$6,026	\$5,739	\$6,173	\$10,981	\$10,228	--	\$5,340
42	72	29 3/8	119	51	NAV4272-30ARLB	\$5,287	\$5,663	\$5,434	\$5,810	\$9,961	\$9,261	--	\$5,050
36	84	29 3/8	179	53	NAV3684-30ARLB	\$5,527	\$5,905	\$5,672	\$6,052	\$10,201	\$9,501	--	\$5,278
36	72	29 3/8	111	49	NAV3672-30ARLB	\$5,230	\$5,557	\$5,378	\$5,703	\$9,293	\$8,638	--	\$4,996

NATIVE

To Order, Specify:

① Veneer Model #	② Wood Species	③ Top Wood Finish	④ Top Edge	⑤ Metal Color	⑥ Electrical
Veneer (NAV)	Flat Cut CH1 Cherry MA1 Maple WA1 Walnut	Cherry: BRL Barley      EAR Earthy BBM Bourbon Medium    HRV Harvest* BRM Brighton Medium    LGC Legacy CLA Classic      PRL Praline* CLL Collectors*    SAF Saffron Maple: ALM Ale Medium    BUT Butterscotch CIN Cinnamon    FLX Flax VEN Venetian Walnut: AUB Auburn    TOF Toffee ESP Espresso    MCH Mocha* NTO Night Owl*    SIE Sienna*	Edge Selection: R3 Eased E1 Reverse Bevel	Color: ASL Arctic Silver BWH Bright White MBK Matte Black PEW Pewter SNK Soft Nickel RML Raw (Clear) CHR Chrome* *Upcharge applies	Cutout Codes: N all tables C1M 72" - 120" wide C1C 72" - 120" wide C1O 120" wide C2M 96" - 120" wide C2C 96" - 120" wide C3M 120" wide C3C 120" wide C3MOM 120" wide See chart on page 45 for cutout codes
	Double Cut DC1 Double Cut	Finishes with an asterisk (*) have a coordinating laminate available ③ Top Wood Finish Double Cut: COF Coffee    FOS Fossil    KHK Khaki CRM Cremello    GRH Graphite    STU Studio Teak			

① Specialty Top Model #	② Top Surface Selection	③ Metal Color	④ Electrical
Solid Surface (NAV)	Patterns: ARM Armadillo    PEB Pebble Pearl BLP Black Pearl    PUR Pure White	See list above for Metal Paint Colors	Cutout Codes: N all tables C1M 72" - 120" wide C1C 72" - 120" wide C1O 120" wide C2M 96" - 120" wide C2C 96" - 120" wide C3M 120" wide C3C 120" wide C3MOM 120" wide
Glass Surface (NAV)	Backpainted Glass: G White Glossy M White Matte		
Sub-Top w/Base (NAV)	B (Table Ships with Sub-Top, Customer applies custom Top)		

Description

Boat Shape 2pc Table with 3 Open Loop Bases

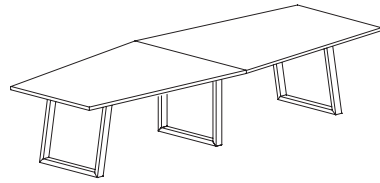

Laminate Tops "NAT" Models

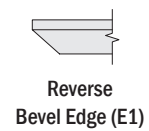
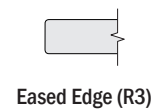

Features:

- three metal, open loop bases with structural support rails
- two-piece top
- glass top has additional seams

Options:

- narrow end of 60" wide table is 48"d; narrow end of 54" wide table is 42"d
- metal frame available in powder coat, no upcharge, or chrome, add list upcharge: for 48" wide - \$2,555, for 54" & 60" wide - \$2,923
- worksurface power & storage available, specify cutout code and order power units separately, see pages 150-151
- magnetic wire manager available; order separately, see page 150

D	W	H	CTN WT	CU FT	① Model	HPL	HPL
60	192	29 3/8	510	130	NAT60192-30BTLB	\$11,238	\$11,719
54	168	29 3/8	411	110	NAT54168-30BTLB	\$8,801	\$9,282
54	144	29 3/8	368	98	NAT54144-30BTLB	\$7,948	\$8,429
54	132	29 3/8	346	84	NAT54132-30BTLB	\$7,614	\$8,096

NATIVE

To Order, Specify:

① Laminate Model #	② Top Laminate	③ Top Edge	④ Metal Color	⑤ Electrical
Laminate (NAT)	Solid Patterns: ALB Alabaster BBL Bridal Bianco DWH Designer White SHD Shadow SLG Slate Grey  Wood Grain Patterns: AGA Aged Ash ALL Ale Light BLO Blonde Echo BOL Bourbon Light BZW Brazilwood BGL Brighton Light CLL Collectors FLO Florence Walnut GRH Graphite HGL High Line OAT Oatmeal Cookie PIN Pinnacle Walnut STU Studio Teak VIN Vintage WLH Walnut Heights WEA Weathered Ash	Edge Selection: R3 Eased E1 Reverse Bevel	Color: ASL Arctic Silver BWH Bright White MBK Matte Black PEW Pewter SNK Soft Nickel RML Raw (Clear) CHR Chrome* *Upcharge applies	

Description

Boat Shape 2pc Table with 3 Open Loop Bases  
(continued)

						Veneer Tops "NAV" Models				Premier Tops "NAV" Models			
						Eased Edge (R3)		Reverse Bevel Edge (E1)		Solid Surface/Glass Reverse Bevel Edge			
D	W	H	CTN WT	CU FT	1 Model	Flat Cut	Double Cut	Flat Cut	Double Cut	Solid Surface	Glass	Wood Plank Ash	Sub-Top with Base
60	192	29 3/8	510	130	NAV60192-30BTLB	\$14,999	\$16,600	\$15,246	\$16,847	\$31,814	\$30,139	--	\$14,237
54	168	29 3/8	411	110	NAV54168-30BTLB	\$11,515	\$12,726	\$11,762	\$12,973	\$24,850	\$23,437	--	\$10,991
54	144	29 3/8	368	98	NAV54144-30BTLB	\$10,440	\$11,562	\$10,687	\$11,809	\$21,930	\$20,658	--	\$9,965
54	132	29 3/8	346	84	NAV54132-30BTLB	\$10,016	\$11,100	\$10,261	\$11,347	\$20,548	\$19,383	--	\$9,560

NATIVE

To Order, Specify:

1 Veneer Model #	2 Wood Species	3 Top Wood Finish	4 Top Edge	5 Metal Color	6 Electrical
Veneer (NAV)	Flat Cut CH1 Cherry MA1 Maple WA1 Walnut	Cherry: BRL Barley      EAR Earthy BBM Bourbon Medium    HRV Harvest* BRM Brighton Medium    LGC Legacy CLA Classic      PRL Praline* CLL Collectors*    SAF Saffron Maple: ALM Ale Medium    BUT Butterscotch CIN Cinnamon FLX Flax VEN Venetian Walnut: AUB Auburn    TOF Toffee ESP Espresso    TRF Truffle* MCH Mocha* NTO Night Owl* SIE Sienna*	Edge Selection: R3 Eased E1 Reverse Bevel	Color: ASL Arctic Silver BWH Bright White MBK Matte Black PEW Pewter SNK Soft Nickel RML Raw (Clear) CHR Chrome* *Upcharge applies	Cutout Codes: N all tables C1M 132" - 192" wide C1C 132" - 192" wide C1O 132" - 192" wide C2M 132" - 192" wide C2C 132" - 192" wide C3C 132" - 192" wide C3M 132" - 192" wide C3MOM 132" - 192" wide See chart on page 45 for cutout codes
	Double Cut DC1 Double Cut	<b>3 Top Wood Finish</b> Double Cut: COF Coffee    FOS Fossil    KHK Khaki CRM Cremello    GRH Graphite    STU Studio Teak			

1 Specialty Top Model #	2 Top Surface Selection	3 Metal Color	4 Electrical
Solid Surface (NAV)	Patterns: ARM Armadillo    PEB Pebble Pearl BLP Black Pearl    PUR Pure White	See list above for Metal Paint Colors	Cutout Codes: N all tables C1M 132" - 192" wide C1C 132" - 192" wide C1O 132" - 192" wide C2M 132" - 192" wide C2C 132" - 192" wide C3C 132" - 192" wide C3M 132" - 192" wide C3MOM 132" - 192" wide
Glass Surface (NAV)	Backpainted Glass: G White Glossy M White Matte		
Sub-Top w/Base (NAV)	B (Table Ships with Sub-Top, Customer applies custom Top)		

Description

Boat Shape Table with Open Loop Base

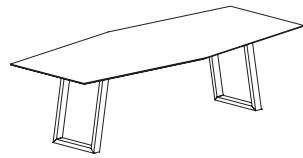

Laminate Tops "NAT" Models

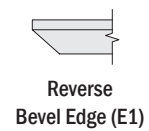
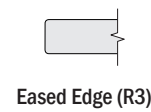

Features:

- two metal, open loop bases with structural support rails
- one-piece top
- narrow end of table is 36"d
- glass top has additional seams

Options:

- metal base frame available in powder coat, no upcharge, or chrome, add list upcharge: for 42" & 48" wide - \$1,966
- worksurface power & storage available, specify cutout code and order power units separately, see pages 150-151
- magnetic wire manager available; order separately, see page 150

D	W	H	CTN WT	CU FT	① Model	HPL	HPL
48	120	29 3/8	283	76	NAT48120-30BTLB	\$5,057	\$5,439
48	108	29 3/8	243	71	NAT48108-30BTLB	\$4,819	\$5,201
48	96	29 3/8	218	63	NAT4896-30BTLB	\$4,284	\$4,666
48	84	29 3/8	200	57	NAT4884-30BTLB	\$4,133	\$4,515
42	72	29 3/8	168	60	NAT4272-30BTLB	\$3,829	\$4,211

NATIVE

To Order, Specify:

① Laminate Model #	② Top Laminate	③ Top Edge	④ Metal Color	⑤ Electrical
Laminate (NAT)	<p>Solid Patterns:</p> <p>ALB Alabaster BBL Bridal Bianco DWH Designer White SHD Shadow SLG Slate Grey</p> <p>Wood Grain Patterns:</p> <p>AGA Aged Ash ALL Ale Light BLO Blonde Echo BOL Bourbon Light BZW Brazilwood</p> <p>BGL Brighton Light CLL Collectors FLO Florence Walnut GRH Graphite HGL High Line</p> <p>OAT Oatmeal Cookie PIN Pinnacle Walnut STU Studio Teak VIN Vintage WLH Walnut Heights WEA Weathered Ash</p>	<p>Edge Selection:</p> <p>R3 Eased E1 Reverse Bevel</p>	<p>Color:</p> <p>ASL Arctic Silver BWH Bright White MBK Matte Black PEW Pewter SNK Soft Nickel RML Raw (Clear) CHR Chrome* *Upcharge applies</p>	<p>Cutout Codes:</p> <p>N all tables C1M 72" - 120" wide C1C 72" - 120" wide C1O 120" wide C2M 96" - 120" wide C2C 96" - 120" wide C3M 120" wide C3C 120" wide C3MOM 120" wide</p>

Description

Boat Shape Table with Open Loop Base  
(continued)

Veneer Tops "NAV" Models

Premier Tops "NAV" Models



Eased Edge (R3)



Reverse Bevel Edge (E1)

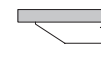

Solid Surface/Glass Reverse Bevel Edge



Wood Plank Ash

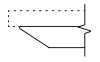

Sub-Top with Base

D	W	H	CTN WT	CU FT	① Model	Veneer Tops "NAV" Models		Veneer Tops "NAV" Models		Premier Tops "NAV" Models		Wood Plank Ash	Sub-Top with Base
						Flat Cut	Double Cut	Flat Cut	Double Cut	Solid Surface	Glass		
48	120	29 3/8	283	76	NAV48120-30BTLB	\$6,984	\$7,677	\$7,131	\$7,823	\$15,607	\$14,553	--	\$6,669
48	108	29 3/8	243	71	NAV48108-30BTLB	\$6,653	\$7,280	\$6,800	\$7,428	\$14,455	\$13,467	--	\$6,355
48	96	29 3/8	218	63	NAV4896-30BTLB	\$5,915	\$6,474	\$6,061	\$6,622	\$12,836	\$11,972	--	\$5,650
48	84	29 3/8	200	57	NAV4884-30BTLB	\$5,707	\$6,200	\$5,854	\$6,346	\$11,811	\$11,005	--	\$5,451
42	72	29 3/8	168	60	NAV4272-30BTLB	\$5,287	\$5,663	\$5,434	\$5,810	\$9,961	\$9,261	--	\$5,050

NATIVE

To Order, Specify:

① Veneer Model #	② Wood Species	③ Top Wood Finish	④ Top Edge	⑤ Metal Color	⑥ Electrical
Veneer (NAV)	Flat Cut CH1 Cherry MA1 Maple WA1 Walnut	Cherry: BRL Barley      EAR Earthy BBM Bourbon Medium    HRV Harvest* BRM Brighton Medium    LGC Legacy CLA Classic      PRL Praline* CLL Collectors*    SAF Saffron Maple: ALM Ale Medium    BUT Butterscotch CIN Cinnamon FLX Flax VEN Venetian Walnut: AUB Auburn    TOF Toffee ESP Espresso    TRF Truffle* MCH Mocha* NTO Night Owl* SIE Sienna*	Edge Selection: R3 Eased E1 Reverse Bevel	Color: ASL Arctic Silver BWH Bright White MBK Matte Black PEW Pewter SNK Soft Nickel RML Raw (Clear) CHR Chrome* *Upcharge applies	Cutout Codes: N all tables C1M 72" - 120" wide C1C 72" - 120" wide C1O 120" wide C2M 96" - 120" wide C2C 96" - 120" wide C3C 120" wide C3M 120" wide C3MOM 120" wide See chart on page 45 for cutout codes
	Double Cut DC1 Double Cut	<b>③ Top Wood Finish</b> Double Cut: COF Coffee    FOS Fossil    KHK Khaki CRM Cremello    GRH Graphite    STU Studio Teak			

① Specialty Top Model #	② Top Surface Selection	③ Metal Color	④ Electrical
Solid Surface (NAV)	Patterns: ARM Armadillo    PEB Pebble Pearl BLP Black Pearl    PUR Pure White	See list above for Metal Paint Colors	Cutout Codes: N all tables C1M 72" - 120" wide C1C 72" - 120" wide C1O 120" wide C2M 96" - 120" wide C2C 96" - 120" wide C3C 120" wide C3M 120" wide C3MOM 120" wide
Glass Surface (NAV)	Backpainted Glass: G White Glossy M White Matte		
Sub-Top w/Base (NAV)	B (Table Ships with Sub-Top, Customer applies custom Top)		

Description

View 2pc Table with 3 Open Loop Bases

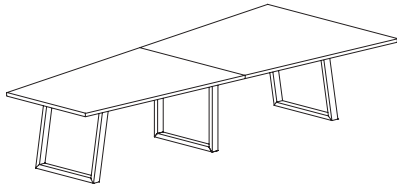

Laminate Tops "NAT" Models

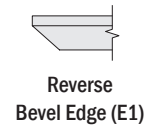
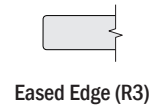

Features:

- three metal, open loop bases with structural support rails
- two-piece top
- glass top has additional seams

Options:

- narrow end of table is 36"d
- metal frame available in powder coat, no upcharge, or chrome, add list upcharge: for 48" wide - \$2,555, for 54" & 60" wide - \$2,923
- worksurface power & storage available, specify cutout code and order power units separately, see pages 150-151
- magnetic wire manager available; order separately, see page 150

D	W	H	CTN WT	CU FT	① Model	HPL	HPL
60	192	29 3/8	465	130	NAT60192-30VTLB	\$11,738	\$12,220
60	168	29 3/8	410	116	NAT60168-30VTLB	\$9,884	\$10,364
60	144	29 3/8	366	104	NAT60144-30VTLB	\$8,751	\$9,232
60	132	29 3/8	344	92	NAT60132-30VTLB	\$7,454	\$7,935

NATIVE

To Order, Specify:

① Laminate Model #	② Top Laminate	③ Top Edge	④ Metal Color	⑤ Electrical
Laminate (NAT)	<p>Solid Patterns:</p> <p>ALB Alabaster</p> <p>BBL Bridal Bianco</p> <p>DWH Designer White</p> <p>SHD Shadow</p> <p>SLG Slate Grey</p> <p>Wood Grain Patterns:</p> <p>AGA Aged Ash</p> <p>ALL Ale Light</p> <p>BLO Blonde Echo</p> <p>BOL Bourbon Light</p> <p>BZW Brazilwood</p> <p>BGL Brighton Light</p> <p>CLL Collectors</p> <p>FLO Florence Walnut</p> <p>GRH Graphite</p> <p>HGL High Line</p> <p>OAT Oatmeal Cookie</p> <p>PIN Pinnacle Walnut</p> <p>STU Studio Teak</p> <p>VIN Vintage</p> <p>WLH Walnut Heights</p> <p>WEA Weathered Ash</p>	<p>Edge Selection:</p> <p>R3 Eased</p> <p>E1 Reverse Bevel</p>	<p>Color:</p> <p>ASL Arctic Silver</p> <p>BWH Bright White</p> <p>MBK Matte Black</p> <p>PEW Pewter</p> <p>SNK Soft Nickel</p> <p>RML Raw (Clear)</p> <p>CHR Chrome*</p> <p>*Upcharge applies</p>	<p>Cutout Codes:</p> <p>N all tables</p> <p>C1M 132" - 192" wide</p> <p>C1C 132" - 192" wide</p> <p>C1O 132" - 192" wide</p> <p>C2M 132" - 192" wide</p> <p>C2C 132" - 192" wide</p> <p>C3M 132" - 192" wide</p> <p>C3C 132" - 192" wide</p> <p>C3MOM 132" - 192" wide</p>

Description

View 2pc Table with 3 Open Loop Bases  
(continued)

						Veneer Tops "NAV" Models				Premier Tops "NAV" Models			
						Eased Edge (R3)		Reverse Bevel Edge (E1)		Solid Surface/Glass Reverse Bevel Edge		Wood Plank Ash	
D	W	H	CTN WT	CU FT	1 Model	Flat Cut	Double Cut	Flat Cut	Double Cut	Solid Surface	Glass	Wood Plank Ash	Sub-Top with Base
60	192	29 3/8	465	130	NAV60192-30VTLB	\$15,553	\$17,580	\$15,800	\$17,827	\$32,368	\$30,693	--	\$14,780
60	168	29 3/8	410	116	NAV60168-30VTLB	\$12,774	\$14,339	\$13,020	\$14,586	\$27,539	\$26,020	--	\$12,201
60	144	29 3/8	366	104	NAV60144-30VTLB	\$11,381	\$12,832	\$11,628	\$13,079	\$24,099	\$22,735	--	\$10,869
60	132	29 3/8	344	92	NAV60132-30VTLB	\$9,714	\$10,970	\$9,962	\$11,217	\$21,374	\$20,123	--	\$9,278

NATIVE

To Order, Specify:

1 Veneer Model #	2 Wood Species	3 Top Wood Finish	4 Top Edge	5 Metal Color	6 Electrical	
Veneer (NAV)	Flat Cut CH1 Cherry MA1 Maple WA1 Walnut	Cherry: BRL Barley      EAR Earthy BBM Bourbon Medium    HRV Harvest* BRM Brighton Medium    LGC Legacy CLA Classic      PRL Praline* CLL Collectors*    SAF Saffron Maple: ALM Ale Medium    BUT Butterscotch CIN Cinnamon FLX Flax VEN Venetian Walnut: AUB Auburn    TOF Toffee ESP Espresso    TRF Truffle* MCH Mocha* NTO Night Owl* SIE Sienna*	Finishes with an asterisk (*) have a coordinating laminate available <b>3 Top Wood Finish</b> Double Cut: COF Coffee    FOS Fossil    KHK Khaki CRM Cremello    GRH Graphite    STU Studio Teak	Edge Selection: R3 Eased E1 Reverse Bevel	Color: ASL Arctic Silver BWH Bright White MBK Matte Black PEW Pewter SNK Soft Nickel RML Raw (Clear) CHR Chrome* *Upcharge applies	Cutout Codes: N all tables C1M 132" - 192" wide C1C 132" - 192" wide C1O 132" - 192" wide C2M 132" - 192" wide C2C 132" - 192" wide C3M 132" - 192" wide C3C 132" - 192" wide C3MOM 132" - 192" wide See chart on page 45 for cutout codes

1 Specialty Top Model #	2 Top Surface Selection	3 Metal Color	4 Electrical
Solid Surface (NAV)	Patterns: ARM Armadillo    PEB Pebble Pearl BLP Black Pearl    PUR Pure White	See list above for Metal Paint Colors	Cutout Codes: N all tables C1M 132" - 192" wide C1C 132" - 192" wide C1O 132" - 192" wide C2M 132" - 192" wide C2C 132" - 192" wide C3M 132" - 192" wide C3C 132" - 192" wide C3MOM 132" - 192" wide
Glass Surface (NAV)	Backpainted Glass: G White Glossy M White Matte		
Sub-Top w/Base (NAV)	B (Table Ships with Sub-Top, Customer applies custom Top)		



Description

View Table with Open Loop Base

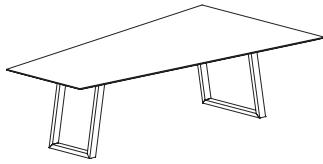

Laminate Tops "NAT" Models

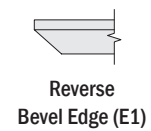
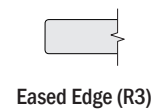

Features:

- two metal, open loop bases with structural support rails
- one-piece top
- narrow end of table is 36" d
- glass top has additional seams

Options:

- metal base frame available in powder coat, no upcharge, or chrome, add list upcharge: for 48" wide - \$1,966, for 54" wide - \$2,249
- worksurface power & storage available, specify cutout code and order power units separately, see pages 150-151
- magnetic wire manager available; order separately, see page 150

D	W	H	CTN WT	CU FT	① Model	HPL	HPL
60	120	29 3/8	283	104	NAT60120-30VTLB	\$5,576	\$5,958
60	108	29 3/8	269	92	NAT60108-30VTLB	\$5,222	\$5,604
54	96	29 3/8	231	86	NAT5496-30VTLB	\$4,482	\$4,864
54	84	29 3/8	213	80	NAT5484-30VTLB	\$4,284	\$4,666
48	72	29 3/8	140	116	NAT4872-30VTLB	\$3,870	\$4,251



NATIVE

To Order, Specify:

① Laminate Model #	② Top Laminate	③ Top Edge	④ Metal Color	⑤ Electrical
Laminate (NAT)	<p>Solid Patterns:</p> <p>ALB Alabaster BBL Bridal Bianco DWH Designer White SHD Shadow SLG Slate Grey</p> <p>Wood Grain Patterns:</p> <p>AGA Aged Ash ALL Ale Light BLO Blonde Echo BOL Bourbon Light BZW Brazilwood</p> <p>BGL Brighton Light CLL Collectors FLO Florence Walnut GRH Graphite HGL High Line</p> <p>OAT Oatmeal Cookie PIN Pinnacle Walnut STU Studio Teak VIN Vintage WLH Walnut Heights WEA Weathered Ash</p>	<p>Edge Selection:</p> <p>R3 Eased E1 Reverse Bevel</p>	<p>Color:</p> <p>ASL Arctic Silver BWH Bright White MBK Matte Black PEW Pewter SNK Soft Nickel RML Raw (Clear) CHR Chrome* *Upcharge applies</p>	<p>Cutout Codes:</p> <p>N all tables C1M 72" - 120" wide C1C 72" - 120" wide C1O 120" wide C2M 96" - 120" wide C2C 96" - 120" wide C3M 120" wide C3C 120" wide C3MOM 120" wide</p>

Description

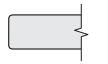
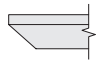
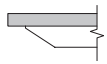
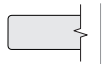
View Table with Open Loop Base  
(continued)

						Veneer Tops "NAV" Models				Premier Tops "NAV" Models					
						 Eased Edge (R3)		 Reverse Bevel Edge (E1)		 Solid Surface/Glass Reverse Bevel Edge					
D	W	H	CTN WT	CU FT	1 Model	Flat Cut	Double Cut	Flat Cut	Double Cut	Solid Surface	Glass	Wood Plank Ash	Sub-Top with Base		
60	120	29 3/8	283	104	NAV60120-30VTLB	\$7,626	\$8,481	\$7,774	\$8,627	\$18,295	\$17,088	--	\$7,283		
60	108	29 3/8	269	92	NAV60108-30VTLB	\$7,160	\$7,929	\$7,306	\$8,075	\$16,762	\$15,675	--	\$6,838		
54	96	29 3/8	231	86	NAV5496-30VTLB	\$6,157	\$6,782	\$6,305	\$6,929	\$13,895	\$12,972	--	\$5,882		
54	84	29 3/8	213	80	NAV5484-30VTLB	\$5,885	\$6,441	\$6,032	\$6,589	\$12,752	\$11,847	--	\$5,623		
48	72	29 3/8	140	116	NAV4872-30VTLB	\$5,343	\$5,768	\$5,491	\$5,915	\$10,631	\$9,886	--	\$5,105		

NATIVE

To Order, Specify:

1 Veneer Model #	2 Wood Species	3 Top Wood Finish	4 Top Edge	5 Metal Color	6 Electrical
Veneer (NAV)	Flat Cut CH1 Cherry MA1 Maple WA1 Walnut	Cherry: BRL Barley      EAR Earthy BBM Bourbon Medium    HRV Harvest* BRM Brighton Medium    LGC Legacy CLA Classic      PRL Praline* CLL Collectors*    SAF Saffron Maple: ALM Ale Medium    BUT Butterscotch CIN Cinnamon FLX Flax VEN Venetian Walnut: AUB Auburn    TOF Toffee ESP Espresso    MCH Mocha* NTO Night Owl* SIE Sienna*	Edge Selection: R3 Eased E1 Reverse Bevel	Color: ASL Arctic Silver BWH Bright White MBK Matte Black PEW Pewter SNK Soft Nickel RML Raw (Clear) CHR Chrome* *Upcharge applies	Cutout Codes: N all tables C1M 72" - 120" wide C1C 72" - 120" wide C1O 120" wide C2M 96" - 120" wide C2C 96" - 120" wide C3C 120" wide C3M 120" wide C3MOM 120" wide See chart on page 45 for cutout codes
	Double Cut DC1 Double Cut	Finishes with an asterisk (*) have a coordinating laminate available 3 Top Wood Finish Double Cut: COF Coffee    FOS Fossil    KHK Khaki CRM Cremello    GRH Graphite    STU Studio Teak			

1 Specialty Top Model #	2 Top Surface Selection	3 Metal Color	4 Electrical
Solid Surface (NAV)	Patterns: ARM Armadillo    PEB Pebble Pearl BLP Black Pearl    PUR Pure White	See list above for Metal Paint Colors	Cutout Codes: N all tables C1M 72" - 120" wide C1C 72" - 120" wide C1O 120" wide C2M 96" - 120" wide C2C 96" - 120" wide C3C 120" wide C3M 120" wide C3MOM 120" wide
Glass Surface (NAV)	Backpainted Glass: G White Glossy M White Matte		
Sub-Top w/Base (NAV)	B (Table Ships with Sub-Top, Customer applies custom Top)		

Description

Rectangular 2pc Table with 3 Panel Bases

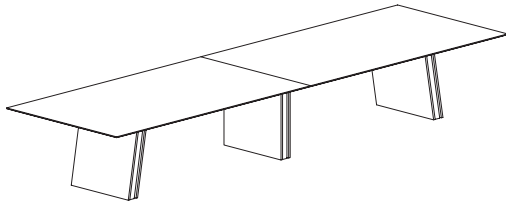

Laminate Tops "NAT" Models

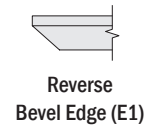
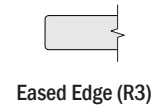

Features:

- three panel bases with structural support rails
- two-piece top
- glass top has additional seams

Options:

- metal base frame available in powder coat, no upcharge, or chrome, add list upcharge: for 48" wide - \$2,555, for 54" & 60" wide -\$2,923
- worksurface power & storage available, specify cutout code and order power units separately, see pages 150-151

D	W	H	CTN WT	CU FT	① Model	HPL	HPL
60	240	29 3/8	730	182	NAT60240-30TTPB	\$15,606	\$16,086
60	216	29 3/8	674	157	NAT60216-30TTPB	\$14,232	\$14,714
60	192	29 3/8	614	130	NAT60192-30TTPB	\$13,234	\$13,715
54	240	29 3/8	681	145	NAT54240-30TTPB	\$14,884	\$15,366
54	216	29 3/8	670	140	NAT54216-30TTPB	\$13,557	\$14,038
54	192	29 3/8	575	124	NAT54192-30TTPB	\$12,787	\$13,268
48	192	29 3/8	518	116	NAT48192-30TTPB	\$11,023	\$11,504

NATIVE

To Order, Specify:

① Laminate Model #	②a Top Laminate / ②b Base Laminate	③ Top Edge	④ Metal Color	⑤ Electrical
Laminate (NAT)	<p>Solid Patterns:</p> <p>ALB Alabaster BBL Bridal Bianco DWH Designer White SHD Shadow SLG Slate Grey</p> <p>Wood Grain Patterns:</p> <p>AGA Aged Ash ALL Ale Light BLO Blonde Echo BOL Bourbon Light BZW Brazilwood</p> <p>BGL Brighton Light CLL Collectors FLO Florence Walnut GRH Graphite HGL High Line</p> <p>OAT Oatmeal Cookie PIN Pinnacle Walnut STU Studio Teak VIN Vintage WLH Walnut Heights WEA Weathered Ash</p>	<p>Edge Selection:</p> <p>R3 Eased E1 Reverse Bevel</p>	<p>Color:</p> <p>ASL Arctic Silver BWH Bright White MBK Matte Black PEW Pewter SNK Soft Nickel RML Raw (Clear) CHR Chrome* *Upcharge applies</p>	<p>Cutout Codes:</p> <p>N all tables C1M 192" - 240" wide C1C 192" - 240" wide C1O 192" - 240" wide C2M 192" - 240" wide C2C 192" - 240" wide C3M 192" - 240" wide C3C 192" - 240" wide C3MOM 192" - 240" wide</p>

Description

Rectangular 2pc Table with 3 Panel Bases  
(continued)

						Veneer Tops "NAV" Models				Premier Tops "NAV" Models			
						Eased Edge (R3)		Reverse Bevel Edge (E1)		Solid Surface/Glass Reverse Bevel Edge			
D	W	H	CTN WT	CU FT	① Model	Flat Cut	Double Cut	Flat Cut	Double Cut	Solid Surface	Glass	Wood Plank Ash	Sub-Top with Base
60	240	29 3/8	730	182	NAV60240-30TTPB	\$19,795	\$21,918	\$20,043	\$22,164	\$40,883	\$38,719	--	\$18,906
60	216	29 3/8	674	157	NAV60216-30TTPB	\$18,196	\$20,264	\$18,443	\$20,511	\$37,223	\$35,227	--	\$17,377
60	192	29 3/8	614	130	NAV60192-30TTPB	\$17,008	\$19,013	\$17,254	\$19,261	\$33,823	\$32,146	--	\$16,243
54	240	29 3/8	681	145	NAV54240-30TTPB	\$18,953	\$20,626	\$19,200	\$20,873	\$37,984	\$35,984	--	\$18,101
54	216	29 3/8	670	140	NAV54216-30TTPB	\$17,408	\$19,040	\$17,655	\$19,287	\$34,583	\$32,737	--	\$16,625
54	192	29 3/8	575	124	NAV54192-30TTPB	\$16,480	\$18,065	\$16,728	\$18,311	\$31,659	\$30,106	--	\$15,739
48	192	29 3/8	518	116	NAV48192-30TTPB	\$14,432	\$15,968	\$14,679	\$16,215	\$27,974	\$26,543	--	\$13,783

NATIVE

To Order, Specify:

① Veneer Model #	② Wood Species	③ Top Wood Finish	④ Base Finish	⑤ Top Edge	⑥ Metal Color	⑦ Electrical		
Veneer (NAV)	<b>Flat Cut</b> CH1 Cherry MA1 Maple WA1 Walnut	Cherry: BRL Barley BBM Bourbon Medium BRM Brighton Medium CLA Classic CLL Collectors* EAR Earthy HRV Harvest* LGC Legacy PRL Praline* SAF Saffron Finishes with an asterisk (*) have a coordinating laminate available	Maple: ALM Ale Medium BUT Butterscotch CIN Cinnamon FLX Flax VEN Venetian	Walnut: AUB Auburn ESP Espresso MCH Mocha* NTO Night Owl* SIE Sienna* TOF Toffee TRF Truffle*	V - Same as Top Finish  P - Paint Color: BKD Backdrop BFX Black Fox BWH Bright White CGP Cargo Pants CHT Chatroom FRR French Roast GRV Greek Villa NET Network Gray NWH Nonchalant White STM Storm TRC Tricorn Black	Edge Selection: R3 Eased E1 Reverse Bevel	Color: ASL Arctic Silver BWH Bright White MBK Matte Black PEW Pewter SNK Soft Nickel RML Raw (Clear) CHR Chrome* *Upcharge applies	Cutout Codes: N all tables C1M 192" - 240" wide C1C 192" - 240" wide C1O 192" - 240" wide C2M 192" - 240" wide C2C 192" - 240" wide C3M 192" - 240" wide C3C 192" - 240" wide C3MOM 192" - 240" wide See chart on page 45 for cutout codes and power and storage unit configurations
		<b>Double Cut</b> DC1 Double Cut	<b>③ Top Wood Finish</b> Double Cut: COF Coffee FOS Fossil KHK Khaki CRM Cremello GRH Graphite STU Studio Teak					

① Specialty Top Model #	② Top Surface Selection	③ Base Wood Species	④a Base Wood Finish	④b Base Paint	⑤ Metal Color	⑥ Electrical
Solid Surface (NAV)	Patterns: ARM Armadillo PEB Pebble Pearl BLP Black Pearl PUR Pure White	<b>Flat Cut</b> CH1 Cherry MA1 Maple WA1 Walnut  <b>Double Cut</b> DC1 Double Cut	See list above for Cherry, Maple and Walnut Finishes  See list above for Double Cut Finishes	See list above for Paint Finishes	See list above for Metal Paint Colors	Cutout Codes: N all tables C1M 192" - 240" wide C1C 192" - 240" wide C1O 192" - 240" wide C2M 192" - 240" wide C2C 192" - 240" wide C3M 192" - 240" wide C3C 192" - 240" wide C3MOM 192" - 240" wide
Glass Surface (NAV)	Backpainted Glass: G White Glossy M White Matte					
Sub-Top w/Base (NAV)	B (Table Ships with Sub-Top, Customer applies custom Top)					

Description

Rectangular 2pc Table with 2 Panel Bases

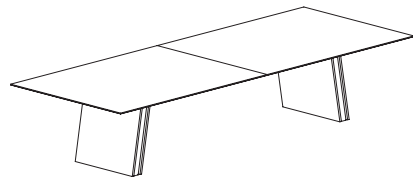

Laminate Tops "NAT" Models

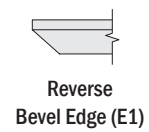
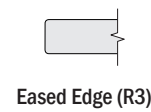

Features:

- two panel bases with structural support rails
- two-piece top
- glass top has additional seams

Options:

- metal base frame available in powder coat, no upcharge, or chrome, add list upcharge: for 48" wide - \$1,966, for 54" & 60" wide - \$2,249
- worksurface power & storage available, specify cutout code and order power units separately, see pages 150-151

D	W	H	CTN WT	CU FT	① Model	HPL	HPL
60	168	29 3/8	509	116	NAT60168-30TPB	\$9,731	\$10,212
60	144	29 3/8	450	104	NAT60144-30TPB	\$8,606	\$9,087
54	168	29 3/8	475	110	NAT54168-30TPB	\$8,945	\$9,426
54	144	29 3/8	420	98	NAT54144-30TPB	\$8,092	\$8,572
54	132	29 3/8	390	84	NAT54132-30TPB	\$7,756	\$8,237
48	168	29 3/8	429	90	NAT48168-30TPB	\$8,476	\$8,957
48	144	29 3/8	379	84	NAT48144-30TPB	\$7,606	\$8,087
48	132	29 3/8	351	78	NAT48132-30TPB	\$7,355	\$7,836

NATIVE

To Order, Specify:

① Laminate Model #	②a Top Laminate / ②b Base Laminate	③ Top Edge	④ Metal Color	⑤ Electrical
Laminate (NAT)	Solid Patterns: ALB Alabaster BBL Bridal Bianco DWH Designer White SHD Shadow SLG Slate Grey  Wood Grain Patterns: AGA Aged Ash ALL Ale Light BLO Blonde Echo BOL Bourbon Light BZW Brazilwood BGL Brighton Light CLL Collectors FLO Florence Walnut GRH Graphite HGL High Line OAT Oatmeal Cookie PIN Pinnacle Walnut STU Studio Teak VIN Vintage WLH Walnut Heights WEA Weathered Ash	Edge Selection: R3 Eased E1 Reverse Bevel	Color: ASL Arctic Silver BWH Bright White MBK Matte Black PEW Pewter SNK Soft Nickel RML Raw (Clear) CHR Chrome* *Upcharge applies	Cutout Codes: N all tables C1M 132" - 168" wide C1C 132" - 168" wide C1O 132" - 168" wide C2M 132" - 168" wide C2C 132" - 168" wide C3M 132" - 168" wide C3C 132" - 168" wide C3MOM 132" - 168" wide

Description

Rectangular 2pc Table with 2 Panel Bases  
(continued)

						Veneer Tops "NAV" Models				Premier Tops "NAV" Models			
						Eased Edge (R3)		Reverse Bevel Edge (E1)		Solid Surface/Glass Reverse Bevel Edge			
D	W	H	CTN WT	CU FT	① Model	Flat Cut	Double Cut	Flat Cut	Double Cut	Solid Surface	Glass	Wood Plank Ash	Sub-Top with Base
60	168	29 3/8	509	116	NAV60168-30TTPB	\$12,575	\$14,116	\$12,822	\$14,363	\$27,341	\$25,822	--	\$12,011
60	144	29 3/8	450	104	NAV60144-30TTPB	\$11,190	\$12,618	\$11,437	\$12,864	\$23,909	\$22,544	--	\$10,689
54	168	29 3/8	475	110	NAV54168-30TTPB	\$11,669	\$12,884	\$11,916	\$13,132	\$25,005	\$23,591	--	\$11,146
54	144	29 3/8	420	98	NAV54144-30TTPB	\$10,594	\$11,722	\$10,841	\$11,967	\$22,084	\$20,812	--	\$10,118
54	132	29 3/8	390	84	NAV54132-30TTPB	\$10,165	\$11,255	\$10,412	\$11,503	\$20,699	\$19,534	--	\$9,709
48	168	29 3/8	429	90	NAV48168-30TTPB	\$11,122	\$12,324	\$11,369	\$12,570	\$23,026	\$21,720	--	\$10,622
48	144	29 3/8	379	84	NAV48144-30TTPB	\$10,031	\$11,147	\$10,278	\$11,393	\$20,296	\$19,115	--	\$9,581
48	132	29 3/8	351	78	NAV48132-30TTPB	\$9,700	\$10,778	\$9,946	\$11,025	\$19,110	\$18,026	--	\$9,263

NATIVE

To Order, Specify:

① Veneer Model #	② Wood Species	③ Top Wood Finish	④ Base Finish	⑤ Top Edge	⑥ Metal Color	⑦ Electrical		
Veneer (NAV)	<b>Flat Cut</b> CH1 Cherry MA1 Maple WA1 Walnut	Cherry: BRL Barley BBM Bourbon Medium BRM Brighton Medium CLA Classic CLL Collectors* EAR Earthy HRV Harvest* LGC Legacy PRL Praline* SAF Saffron Finishes with an asterisk (*) have a coordinating laminate available	Maple: ALM Ale Medium BUT Butterscotch CIN Cinnamon FLX Flax VEN Venetian	Walnut: AUB Auburn ESP Espresso MCH Mocha* NTO Night Owl* SIE Sienna* TOF Toffee TRF Truffle*	V - Same as Top Finish  P - Paint Color: BKD Backdrop BFX Black Fox BWH Bright White CGP Cargo Pants CHT Chatroom FRR French Roast GRV Greek Villa NET Network Gray NWH Nonchalant White STM Storm TRC Tricorn Black	Edge Selection: R3 Eased E1 Reverse Bevel	Color: ASL Arctic Silver BWH Bright White MBK Matte Black PEW Pewter SNK Soft Nickel RML Raw (Clear) CHR Chrome* *Upcharge applies	Cutout Codes: N all tables C1M 132" - 168" wide C1C 132" - 168" wide C1O 132" - 168" wide C2M 132" - 168" wide C2C 132" - 168" wide C3M 132" - 168" wide C3C 132" - 168" wide C3MOM 132" - 168" wide See chart on page 45 for cutout codes and power and storage unit configurations
		<b>Double Cut</b> DC1 Double Cut	<b>③ Top Wood Finish</b> Double Cut: COF Coffee FOS Fossil KHK Khaki CRM Cremello GRH Graphite STU Studio Teak					

① Specialty Top Model #	② Top Surface Selection	③ Base Wood Species	④a Base Wood Finish	④b Base Paint	⑤ Metal Color	⑥ Electrical
Solid Surface (NAV)	Patterns: ARM Armadillo PEB Pebble Pearl BLP Black Pearl PUR Pure White	<b>Flat Cut</b> CH1 Cherry MA1 Maple WA1 Walnut  <b>Double Cut</b> DC1 Double Cut	See list above for Cherry, Maple and Walnut Finishes  See list above for Double Cut Finishes	See list above for Paint Finishes	See list above for Metal Paint Colors	Cutout Codes: N all tables C1M 132" - 168" wide C1C 132" - 168" wide C1O 132" - 168" wide C2M 132" - 168" wide C2C 132" - 168" wide C3M 132" - 168" wide C3C 132" - 168" wide C3MOM 132" - 168" wide
Glass Surface (NAV)	Backpainted Glass: G White Glossy M White Matte					
Sub-Top w/Base (NAV)	B (Table Ships with Sub-Top, Customer applies custom Top)					

Description

Rectangular Table with Panel Base

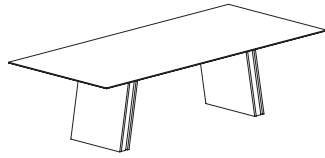

Laminate Tops "NAT" Models

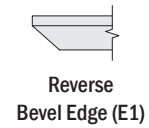
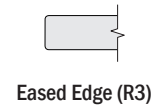

Features:

- two panel bases with structural support rails
- one-piece top
- glass top has additional seams

Options:

- metal base frame available in powder coat, no upcharge, or chrome, add list upcharge: for 36" wide - \$1,694, for 42" & 48" wide - \$1,966, for 54" wide - \$2,249
- worksurface power & storage available, specify cutout code and order power units separately, see pages 150-151

D	W	H	CTN WT	CU FT	① Model	HPL	HPL
54	120	29 3/8	366	78	NAT54120-30TTPB	\$6,621	\$7,001
48	120	29 3/8	329	72	NAT48120-30TTPB	\$6,287	\$6,668
48	108	29 3/8	311	69	NAT48108-30TTPB	\$5,854	\$6,236
48	96	29 3/8	287	62	NAT4896-30TTPB	\$5,593	\$5,974
48	84	29 3/8	264	57	NAT4884-30TTPB	\$5,356	\$5,738
48	72	29 3/8	238	52	NAT4872-30TTPB	\$4,886	\$5,268
42	120	29 3/8	305	68	NAT42120-30TTPB	\$6,206	\$6,588
42	108	29 3/8	289	66	NAT42108-30TTPB	\$5,635	\$6,017
42	96	29 3/8	268	63	NAT4296-30TTPB	\$5,530	\$5,911
42	84	29 3/8	247	67	NAT4284-30TTPB	\$5,298	\$5,679
42	72	29 3/8	204	50	NAT4272-30TTPB	\$4,940	\$5,322
36	84	29 3/8	219	53	NAT3684-30TTPB	\$4,924	\$5,305
36	72	29 3/8	198	45	NAT3672-30TTPB	\$4,792	\$5,174

NATIVE

To Order, Specify:

① Laminate Model #	②a Top Laminate / ②b Base Laminate	③ Top Edge	④ Metal Color	⑤ Electrical
Laminate (NAT)	Solid Patterns: ALB Alabaster BBL Bridal Bianco DWH Designer White SHD Shadow SLG Slate Grey  Wood Grain Patterns: AGA Aged Ash ALL Ale Light BLO Blonde Echo BOL Bourbon Light BZW Brazilwood BGL Brighton Light CLL Collectors FLO Florence Walnut GRH Graphite HGL High Line OAT Oatmeal Cookie PIN Pinnacle Walnut STU Studio Teak VIN Vintage WLH Walnut Heights WEA Weathered Ash	Edge Selection: R3 Eased E1 Reverse Bevel	Color: ASL Arctic Silver BWH Bright White MBK Matte Black PEW Pewter SNK Soft Nickel RML Raw (Clear) CHR Chrome* *Upcharge applies	Cutout Codes: N all tables C1M 72" - 120" wide C1C 72" - 120" wide C1O 120" wide C2M 96" - 120" wide C2C 96" - 120" wide C3M 120" wide C3C 120" wide C3MOM 120" wide

Description

Rectangular Table with Panel Base  
(continued)

						Veneer Tops "NAV" Models				Premier Tops "NAV" Models			
						Eased Edge (R3)		Reverse Bevel Edge (E1)		Solid Surface/Glass Reverse Bevel Edge		Wood Plank Ash	
D	W	H	CTN WT	CU FT	Model	Flat Cut	Double Cut	Flat Cut	Double Cut	Solid Surface	Glass	Wood Plank Ash	Sub-Top with Base
54	120	29 3/8	366	78	NAV54120-30TPB	\$9,097	\$10,079	\$9,244	\$10,226	\$18,743	\$17,612	--	\$8,687
48	120	29 3/8	329	72	NAV48120-30TPB	\$8,682	\$9,647	\$8,830	\$9,795	\$17,306	\$16,252	\$14,060	\$8,292
48	108	29 3/8	311	69	NAV48108-30TPB	\$8,083	\$8,982	\$8,231	\$9,129	\$15,887	\$14,897	\$12,924	\$7,720
48	96	29 3/8	287	62	NAV4896-30TPB	\$7,722	\$8,581	\$7,870	\$8,727	\$14,643	\$13,779	\$12,025	\$7,376
48	84	29 3/8	264	57	NAV4884-30TPB	\$7,395	\$8,218	\$7,543	\$8,365	\$13,499	\$12,694	\$11,160	\$7,064
48	72	29 3/8	238	52	NAV4872-30TPB	\$6,746	\$7,496	\$6,893	\$7,644	\$12,032	\$11,287	\$9,973	\$6,442
42	120	29 3/8	305	68	NAV42120-30TPB	\$8,569	\$9,522	\$8,716	\$9,670	\$16,116	\$15,192	\$13,275	\$8,185
42	108	29 3/8	289	66	NAV42108-30TPB	\$7,782	\$8,647	\$7,930	\$8,795	\$14,611	\$13,744	\$12,019	\$7,433
42	96	29 3/8	268	63	NAV4296-30TPB	\$7,633	\$8,484	\$7,781	\$8,629	\$13,740	\$12,934	\$11,400	\$7,292
42	84	29 3/8	247	67	NAV4284-30TPB	\$7,315	\$8,128	\$7,463	\$8,275	\$12,704	\$11,952	\$10,610	\$6,987
42	72	29 3/8	204	50	NAV4272-30TPB	\$6,821	\$7,581	\$6,969	\$7,726	\$11,496	\$10,796	\$9,645	\$6,515
36	84	29 3/8	219	53	NAV3684-30TPB	\$6,798	\$7,554	\$6,946	\$7,702	\$11,475	\$10,772	\$9,621	\$6,493
36	72	29 3/8	198	45	NAV3672-30TPB	\$6,619	\$7,354	\$6,765	\$7,500	\$10,680	\$10,025	\$9,039	\$6,320

To Order, Specify:

1 Veneer Model #	2 Wood Species	3 Top Wood Finish	4 Base Finish	5 Top Edge	6 Metal Color	7 Electrical		
Veneer (NAV) Flat Cut CH1 Cherry MA1 Maple WA1 Walnut		Cherry: BRL Barley BBM Bourbon Medium BRM Brighton Medium CLA Classic CLL Collectors* EAR Earthy HRV Harvest* LGC Legacy PRL Praline* SAF Saffron	Maple: ALM Ale Medium BUT Butterscotch CIN Cinnamon FLX Flax VEN Venetian	Walnut: AUB Auburn ESP Espresso MCH Mocha* NTO Night Owl* SIE Sienna* TOF Toffee TRF Truffle*	V - Same as Top Finish  P - Paint Color: BKD Backdrop BFX Black Fox BWH Bright White CGP Cargo Pants CHT Chatroom FRR French Roast GRV Greek Villa NET Network Gray NWH Nonchalant White STM Storm TRC Tricorn Black	Edge Selection: R3 Eased E1 Reverse Bevel	Color: ASL Arctic Silver BWH Bright White MBK Matte Black PEW Pewter SNK Soft Nickel RML Raw (Clear) CHR Chrome* *Upcharge applies	Cutout Codes: N all tables C1M 72" - 120" wide C1C 72" - 120" wide C1O 120" wide C2M 96" - 120" wide C2C 96" - 120" wide C3C 120" wide C3M 120" wide C3MOM 120" wide See chart on page 45 for cutout codes and power and storage unit configurations
		Double Cut DC1 Double Cut	3 Top Wood Finish Double Cut: COF Coffee FOS Fossil KHK Khaki CRM Cremello GRH Graphite STU Studio Teak					

1 Specialty Top Model #	2 Top Surface Selection	3 Base Wood Species	4a Base Wood Finish	4b Base Paint	5 Metal Color	6 Electrical
Solid Surface (NAV)	Patterns: ARM Armadillo PEB Pebble Pearl BLP Black Pearl PUR Pure White	Flat Cut CH1 Cherry MA1 Maple WA1 Walnut	See list above for Cherry, Maple and Walnut Finishes	See list above for Paint Finishes	See list above for Metal Paint Colors	Cutout Codes: N all tables C1M 72" - 120" wide C1C 72" - 120" wide C1O 120" wide C2M 96" - 120" wide C2C 96" - 120" wide C3C 120" wide C3M 120" wide C3MOM 120" wide
Glass Surface (NAV)	Backpainted Glass: G White Glossy M White Matte					
Wood Plank (NAV)	W Wood Plank Ash, Clear Coat	Double Cut DC1 Double Cut	See list above for Double Cut Finishes			
Sub-Top w/Base (NAV)	B (Table Ships with Sub-Top, Customer applies custom Top)					



Description

Arc End 2pc Table with 3 Panel Bases

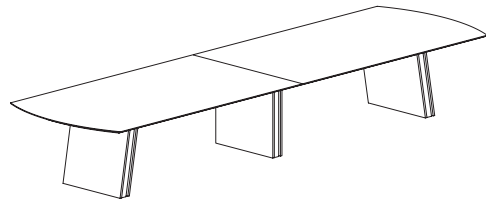

Laminate Tops "NAT" Models

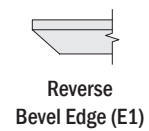
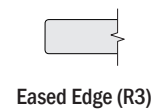

Features:

- three panel bases with structural support rails
- two-piece top
- glass top has additional seams

Options:

- metal base frame available in powder coat, no upcharge, or chrome, add list upcharge: for 48" wide - \$2,555, for 54" & 60" wide - \$2,923
- worksurface power & storage available, specify cutout code and order power units separately, see pages 150-151

D	W	H	CTN WT	CU FT	① Model	HPL	HPL
60	240	29 3/8	722	182	NAT60240-30ARPB	\$15,606	\$16,086
60	216	29 3/8	667	157	NAT60216-30ARPB	\$14,232	\$14,714
60	192	29 3/8	607	130	NAT60192-30ARPB	\$13,234	\$13,715
54	240	29 3/8	674	145	NAT54240-30ARPB	\$14,884	\$15,366
54	216	29 3/8	624	140	NAT54216-30ARPB	\$13,557	\$14,038
54	192	29 3/8	568	124	NAT54192-30ARPB	\$12,787	\$13,268
48	192	29 3/8	512	116	NAT48192-30ARPB	\$11,023	\$11,504

NATIVE

To Order, Specify:

① Laminate Model #	②a Top Laminate / ②b Base Laminate	③ Top Edge	④ Metal Color	⑤ Electrical
Laminate (NAT)	<p>Solid Patterns:</p> <p>ALB Alabaster BBL Bridal Bianco DWH Designer White SHD Shadow SLG Slate Grey</p> <p>Wood Grain Patterns:</p> <p>AGA Aged Ash ALL Ale Light BLO Blonde Echo BOL Bourbon Light BZW Brazilwood</p> <p>BGL Brighton Light CLL Collectors FLO Florence Walnut GRH Graphite HGL High Line</p> <p>OAT Oatmeal Cookie PIN Pinnacle Walnut STU Studio Teak VIN Vintage WLH Walnut Heights WEA Weathered Ash</p>	<p>Edge Selection:</p> <p>R3 Eased E1 Reverse Bevel</p>	<p>Color:</p> <p>ASL Arctic Silver BWH Bright White MBK Matte Black PEW Pewter SNK Soft Nickel RML Raw (Clear) CHR Chrome* *Upcharge applies</p>	<p>Cutout Codes:</p> <p>N all tables C1M 192" - 240" wide C1C 192" - 240" wide C1O 192" - 240" wide C2M 192" - 240" wide C2C 192" - 240" wide C3M 192" - 240" wide C3C 192" - 240" wide C3MOM 192" - 240" wide</p>

Description

Arc End 2pc Table with 3 Panel Bases  
(continued)

						Veneer Tops "NAV" Models				Premier Tops "NAV" Models			
						Eased Edge (R3)		Reverse Bevel Edge (E1)		Solid Surface/Glass Reverse Bevel Edge			
D	W	H	CTN WT	CU FT	① Model	Flat Cut	Double Cut	Flat Cut	Double Cut	Solid Surface	Glass	Wood Plank Ash	Sub-Top with Base
60	240	29 3/8	722	182	NAV60240-30ARPB	\$19,795	\$21,918	\$20,043	\$22,164	\$40,883	\$38,719	--	\$18,906
60	216	29 3/8	667	157	NAV60216-30ARPB	\$18,196	\$20,264	\$18,443	\$20,511	\$37,223	\$35,227	--	\$17,377
60	192	29 3/8	607	130	NAV60192-30ARPB	\$17,008	\$19,013	\$17,254	\$19,261	\$33,823	\$32,146	--	\$16,243
54	240	29 3/8	674	145	NAV54240-30ARPB	\$18,953	\$20,626	\$19,200	\$20,873	\$37,984	\$35,984	--	\$18,101
54	216	29 3/8	624	140	NAV54216-30ARPB	\$17,408	\$19,040	\$17,655	\$19,287	\$34,583	\$32,737	--	\$16,625
54	192	29 3/8	568	124	NAV54192-30ARPB	\$16,480	\$18,065	\$16,728	\$18,311	\$31,659	\$30,106	--	\$15,739
48	192	29 3/8	512	116	NAV48192-30ARPB	\$14,432	\$15,968	\$14,679	\$16,215	\$27,974	\$26,543	--	\$13,783

NATIVE

To Order, Specify:

① Veneer Model #	② Wood Species	③ Top Wood Finish	④ Base Finish	⑤ Top Edge	⑥ Metal Color	⑦ Electrical		
Veneer (NAV)	<b>Flat Cut</b> CH1 Cherry MA1 Maple WA1 Walnut	Cherry: BRL Barley BBM Bourbon Medium BRM Brighton Medium CLA Classic CLL Collectors* EAR Earthy HRV Harvest* LGC Legacy PRL Praline* SAF Saffron Finishes with an asterisk (*) have a coordinating laminate available	Maple: ALM Ale Medium BUT Butterscotch CIN Cinnamon FLX Flax VEN Venetian	Walnut: AUB Auburn ESP Espresso MCH Mocha* NTO Night Owl* SIE Sienna* TOF Toffee TRF Truffle*	V - Same as Top Finish  P - Paint Color: BKD Backdrop BFX Black Fox BWH Bright White CGP Cargo Pants CHT Chatroom FRR French Roast GRV Greek Villa NET Network Gray NWH Nonchalant White STM Storm TRC Tricorn Black	Edge Selection: R3 Eased E1 Reverse Bevel	Color: ASL Arctic Silver BWH Bright White MBK Matte Black PEW Pewter SNK Soft Nickel RML Raw (Clear) CHR Chrome* *Upcharge applies	Cutout Codes: N all tables C1M 192" - 240" wide C1C 192" - 240" wide C1O 192" - 240" wide C2M 192" - 240" wide C2C 192" - 240" wide C3M 192" - 240" wide C3C 192" - 240" wide C3MOM 192" - 240" wide See chart on page 45 for cutout codes and power and storage unit configurations
		<b>Double Cut</b> DC1 Double Cut	<b>③ Top Wood Finish</b> Double Cut: COF Coffee FOS Fossil KHK Khaki CRM Cremello GRH Graphite STU Studio Teak					

① Specialty Top Model #	② Top Surface Selection	③ Base Wood Species	④a Base Wood Finish	④b Base Paint	⑤ Metal Color	⑥ Electrical
Solid Surface (NAV)	Patterns: ARM Armadillo PEB Pebble Pearl BLP Black Pearl PUR Pure White	<b>Flat Cut</b> CH1 Cherry MA1 Maple WA1 Walnut  <b>Double Cut</b> DC1 Double Cut	See list above for Cherry, Maple and Walnut Finishes	See list above for Paint Finishes	See list above for Metal Paint Colors	Cutout Codes: N all tables C1M 192" - 240" wide C1C 192" - 240" wide C1O 192" - 240" wide C2M 192" - 240" wide C2C 192" - 240" wide C3M 192" - 240" wide C3C 192" - 240" wide C3MOM 192" - 240" wide
Glass Surface (NAV)	Backpainted Glass: G White Glossy M White Matte					
Sub-Top w/Base (NAV)	B (Table Ships with Sub-Top, Customer applies custom Top)					

Description

Arc End 2pc Table with 2 Panel Bases

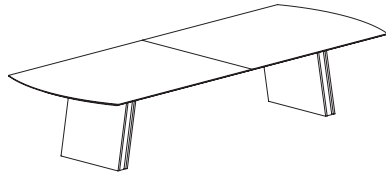

Laminate Tops "NAT" Models

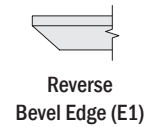
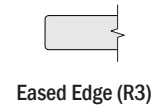

Features:

- two panel bases with structural support rails
- two-piece top
- glass top has additional seams

Options:

- metal base frame available in powder coat, no upcharge, or chrome, add list upcharge: for 48" wide - \$1,966, for 54" & 60" wide - \$2,249
- worksurface power & storage available, specify cutout code and order power units separately, see pages 150-151

D	W	H	CTN WT	CU FT	① Model	HPL	HPL
60	168	29 3/8	509	116	NAT60168-30ARPB	\$9,731	\$10,212
60	144	29 3/8	442	104	NAT60144-30ARPB	\$7,828	\$8,309
54	168	29 3/8	469	110	NAT54168-30ARPB	\$8,945	\$9,426
54	144	29 3/8	414	98	NAT54144-30ARPB	\$8,092	\$8,572
54	132	29 3/8	383	84	NAT54132-30ARPB	\$7,022	\$7,503
48	168	29 3/8	423	90	NAT48168-30ARPB	\$8,476	\$8,957
48	144	29 3/8	346	84	NAT48144-30ARPB	\$7,606	\$8,087
48	132	29 3/8	346	78	NAT48132-30ARPB	\$7,355	\$7,836

NATIVE

To Order, Specify:

① Laminate Model #	②a Top Laminate / ②b Base Laminate	③ Top Edge	④ Metal Color	⑤ Electrical
Laminate (NAT)	<p>Solid Patterns:</p> <p>ALB Alabaster BBL Bridal Bianco DWH Designer White SHD Shadow SLG Slate Grey</p> <p>Wood Grain Patterns:</p> <p>AGA Aged Ash ALL Ale Light BLO Blonde Echo BOL Bourbon Light BZW Brazilwood</p> <p>BGL Brighton Light CLL Collectors FLO Florence Walnut GRH Graphite HGL High Line</p> <p>OAT Oatmeal Cookie PIN Pinnacle Walnut STU Studio Teak VIN Vintage WLH Walnut Heights WEA Weathered Ash</p>	<p>Edge Selection:</p> <p>R3 Eased E1 Reverse Bevel</p>	<p>Color:</p> <p>ASL Arctic Silver BWH Bright White MBK Matte Black PEW Pewter SNK Soft Nickel RML Raw (Clear) CHR Chrome* *Upcharge applies</p>	<p>Cutout Codes:</p> <p>N all tables C1M 132" - 168" wide C1C 132" - 168" wide C1O 132" - 168" wide C2M 132" - 168" wide C2C 132" - 168" wide C3M 132" - 168" wide C3C 132" - 168" wide C3MOM 132" - 168" wide</p>

Description

Arc End 2pc Table with 2 Panel Bases  
(continued)

						Veneer Tops "NAV" Models				Premier Tops "NAV" Models			
						Eased Edge (R3)		Reverse Bevel Edge (E1)		Solid Surface/Glass Reverse Bevel Edge		Wood Plank Ash	
D	W	H	CTN WT	CU FT	① Model	Flat Cut	Double Cut	Flat Cut	Double Cut	Solid Surface	Glass	Wood Plank Ash	Sub-Top with Base
60	168	29 3/8	509	116	NAV60168-30ARPB	\$12,575	\$14,116	\$12,822	\$14,363	\$27,341	\$25,822	--	\$12,011
60	144	29 3/8	442	104	NAV60144-30ARPB	\$10,179	\$11,477	\$10,425	\$11,724	\$22,896	\$21,533	--	\$9,721
54	168	29 3/8	469	110	NAV54168-30ARPB	\$11,669	\$12,884	\$11,916	\$13,132	\$25,005	\$23,591	--	\$11,146
54	144	29 3/8	414	98	NAV54144-30ARPB	\$10,594	\$11,722	\$10,841	\$11,967	\$22,084	\$20,812	--	\$10,118
54	132	29 3/8	383	84	NAV54132-30ARPB	9202	10190	9450	10437	19735	18571	0	8790
48	168	29 3/8	423	90	NAV48168-30ARPB	\$11,122	\$12,324	\$11,369	\$12,570	\$23,026	\$21,720	--	\$10,622
48	144	29 3/8	346	84	NAV48144-30ARPB	\$10,031	\$11,147	\$10,278	\$11,393	\$20,296	\$19,115	--	\$9,581
48	132	29 3/8	346	78	NAV48132-30ARPB	\$9,700	\$10,778	\$9,946	\$11,025	\$19,110	\$18,026	--	\$9,263

NATIVE

To Order, Specify:

① Veneer Model #	② Wood Species	③ Top Wood Finish	④ Base Finish	⑤ Top Edge	⑥ Metal Color	⑦ Electrical		
Veneer (NAV)	Flat Cut CH1 Cherry MA1 Maple WA1 Walnut	Cherry: BRL Barley BBM Bourbon Medium BRM Brighton Medium CLA Classic CLL Collectors* EAR Earthy HRV Harvest* LGC Legacy PRL Praline* SAF Saffron Finishes with an asterisk (*) have a coordinating laminate available	Maple: ALM Ale Medium BUT Butterscotch CIN Cinnamon FLX Flax VEN Venetian	Walnut: AUB Auburn ESP Espresso MCH Mocha* NTO Night Owl* SIE Sienna* TOF Toffee TRF Truffle*	V - Same as Top Finish	Edge Selection: R3 Eased E1 Reverse Bevel	Color: ASL Arctic Silver BWH Bright White MBK Matte Black PEW Pewter SNK Soft Nickel RML Raw (Clear) CHR Chrome* *Upcharge applies	Cutout Codes: N all tables C1M 132" - 168" wide C1C 132" - 168" wide C1O 132" - 168" wide C2M 132" - 168" wide C2C 132" - 168" wide C3M 132" - 168" wide C3C 132" - 168" wide C3MOM 132" - 168" wide See chart on page 45 for cutout codes and power and storage unit configurations
	Double Cut DC1 Double Cut	③ Top Wood Finish	Double Cut: COF Coffee FOS Fossil KHK Khaki CRM Cremello GRH Graphite STU Studio Teak	P - Paint Color: BKD Backdrop BFX Black Fox BWH Bright White CGP Cargo Pants CHT Chatroom FRR French Roast GRV Greek Villa NET Network Gray NWH Nonchalant White STM Storm TRC Tricorn Black				

① Specialty Top Model #	② Top Surface Selection	③ Base Wood Species	④a Base Wood Finish	④b Base Paint	⑤ Metal Color	⑥ Electrical
Solid Surface (NAV)	Patterns: ARM Armadillo PEB Pebble Pearl BLP Black Pearl PUR Pure White	Flat Cut CH1 Cherry MA1 Maple WA1 Walnut  Double Cut DC1 Double Cut	See list above for Cherry, Maple and Walnut Finishes	See list above for Paint Finishes	See list above for Metal Paint Colors	Cutout Codes: N all tables C1M 132" - 168" wide C1C 132" - 168" wide C1O 132" - 168" wide C2M 132" - 168" wide C2C 132" - 168" wide C3M 132" - 168" wide C3C 132" - 168" wide C3MOM 132" - 168" wide
Glass Surface (NAV)	Backpainted Glass: G White Glossy M White Matte					
Sub-Top w/Base (NAV)	B (Table Ships with Sub-Top, Customer applies custom Top)					

Description

Arc End Table with Panel Base

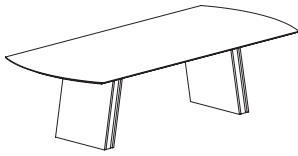

Laminate Tops "NAT" Models

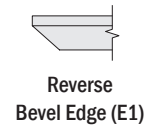
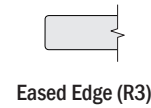

Features:

- two panel bases with structural support rails
- one-piece top
- glass top has additional seams

Options:

- metal base frame available in powder coat, no upcharge, or chrome, add list upcharge: for 36" wide - \$1,694, for 42" & 48" wide - \$1,966, for 54" wide - \$2,249
- worksurface power & storage available, specify cutout code and order power units separately, see pages 150-151

D	W	H	CTN WT	CU FT	① Model	HPL	HPL
54	120	29 3/8	359	78	NAT54120-30ARPB	\$6,621	\$7,001
48	120	29 3/8	324	72	NAT48120-30ARPB	\$6,287	\$6,668
48	108	29 3/8	305	69	NAT48108-30ARPB	\$5,854	\$6,236
48	96	29 3/8	281	62	NAT4896-30ARPB	\$5,593	\$5,974
48	84	29 3/8	258	57	NAT4884-30ARPB	\$5,356	\$5,738
48	72	29 3/8	188	52	NAT4872-30ARPB	\$4,990	\$5,370
42	120	29 3/8	300	68	NAT42120-30ARPB	\$6,206	\$6,588
42	108	29 3/8	221	66	NAT42108-30ARPB	\$5,635	\$6,017
42	96	29 3/8	263	63	NAT4296-30ARPB	\$5,530	\$5,911
42	84	29 3/8	242	67	NAT4284-30ARPB	\$5,298	\$5,679
42	72	29 3/8	204	50	NAT4272-30ARPB	\$4,940	\$5,322
36	84	29 3/8	215	53	NAT3684-30ARPB	\$4,924	\$5,305
36	72	29 3/8	181	45	NAT3672-30ARPB	\$4,778	\$5,158

NATIVE

To Order, Specify:

① Laminate Model #	②a Top Laminate / ②b Base Laminate	③ Top Edge	④ Metal Color	⑤ Electrical
Laminate (NAT)	<p>Solid Patterns:</p> <p>ALB Alabaster BBL Bridal Blanco DWH Designer White SHD Shadow SLG Slate Grey</p> <p>Wood Grain Patterns:</p> <p>AGA Aged Ash    BGL Brighton Light    OAT Oatmeal Cookie ALL Ale Light    CLL Collectors    PIN Pinnacle Walnut BLO Blonde Echo    FLO Florence Walnut    STU Studio Teak BOL Bourbon Light    GRH Graphite    VIN Vintage BZW Brazilwood    HGL High Line    WLH Walnut Heights WEA Weathered Ash</p>	<p>Edge Selection:</p> <p>R3 Eased E1 Reverse Bevel</p>	<p>Color:</p> <p>ASL Arctic Silver BWH Bright White MBK Matte Black PEW Pewter SNK Soft Nickel RML Raw (Clear) CHR Chrome* *Upcharge applies</p>	<p>Cutout Codes:</p> <p>N all tables C1M 72" - 120" wide C1C 72" - 120" wide C1O 120" wide C2M 96" - 120" wide C2C 96" - 120" wide C3M 120" wide C3C 120" wide C3MOM 120" wide</p>

Description

Arc End Table with Panel Base  
(continued)

Veneer Tops "NAV" Models

Premier Tops "NAV" Models



Eased Edge (R3)



Reverse Bevel Edge (E1)

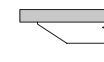

Solid Surface/Glass Reverse Bevel Edge



Wood Plank Ash

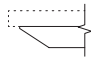

Sub-Top with Base

D	W	H	CTN WT	CU FT	① Model	Veneer Tops "NAV" Models		Premier Tops "NAV" Models		Solid Surface	Glass	Wood Plank Ash	Sub-Top with Base
						Flat Cut	Double Cut	Flat Cut	Double Cut				
54	120	29 3/8	359	78	NAV54120-30ARPB	\$9,097	\$10,079	\$9,244	\$10,226	\$18,743	\$17,612	--	\$8,687
48	120	29 3/8	324	72	NAV48120-30ARPB	\$8,682	\$9,647	\$8,830	\$9,795	\$17,306	\$16,252	--	\$8,292
48	108	29 3/8	305	69	NAV48108-30ARPB	\$8,083	\$8,982	\$8,231	\$9,129	\$15,887	\$14,897	--	\$7,720
48	96	29 3/8	281	62	NAV4896-30ARPB	\$7,722	\$8,581	\$7,870	\$8,727	\$14,643	\$13,779	--	\$7,376
48	84	29 3/8	258	57	NAV4884-30ARPB	\$7,395	\$8,218	\$7,543	\$8,365	\$13,499	\$12,694	--	\$7,064
48	72	29 3/8	188	52	NAV4872-30ARPB	\$6,889	\$7,655	\$7,036	\$7,802	\$12,175	\$11,430	--	\$6,579
42	120	29 3/8	300	68	NAV42120-30ARPB	\$8,569	\$9,522	\$8,716	\$9,670	\$16,116	\$15,192	--	\$8,185
42	108	29 3/8	221	66	NAV42108-30ARPB	\$7,782	\$8,647	\$7,930	\$8,795	\$14,611	\$13,744	--	\$7,433
42	96	29 3/8	263	63	NAV4296-30ARPB	\$7,633	\$8,484	\$7,781	\$8,629	\$13,740	\$12,934	--	\$7,292
42	84	29 3/8	242	67	NAV4284-30ARPB	\$7,315	\$8,128	\$7,463	\$8,275	\$12,704	\$11,952	--	\$6,987
42	72	29 3/8	204	50	NAV4272-30ARPB	\$6,821	\$7,581	\$6,969	\$7,726	\$11,496	\$10,796	--	\$6,515
36	84	29 3/8	215	53	NAV3684-30ARPB	\$6,798	\$7,554	\$6,946	\$7,702	\$11,475	\$10,772	--	\$6,493
36	72	29 3/8	181	45	NAV3672-30ARPB	\$6,596	\$7,330	\$6,744	\$7,477	\$10,660	\$10,003	--	\$6,300

NATIVE

To Order, Specify:

① Veneer Model #	② Wood Species	③ Top Wood Finish	④ Base Finish	⑤ Top Edge	⑥ Metal Color	⑦ Electrical		
Veneer (NAV)	<b>Flat Cut</b> CH1 Cherry MA1 Maple WA1 Walnut	Cherry: BRL Barley BBM Bourbon Medium BRM Brighton Medium CLA Classic CLL Collectors* EAR Earthy HRV Harvest* LGC Legacy PRL Praline* SAF Saffron Finishes with an asterisk (*) have a coordinating laminate available	Maple: ALM Ale Medium BUT Butterscotch CIN Cinnamon FLX Flax VEN Venetian	Walnut: AUB Auburn ESP Espresso MCH Mocha* NTO Night Owl* SIE Sienna* TOF Toffee TRF Truffle*	V - Same as Top Finish  P - Paint Color: BKD Backdrop BFX Black Fox BWH Bright White CGP Cargo Pants CHT Chatroom FRR French Roast GRV Greek Villa NET Network Gray NWH Nonchalant White STM Storm TRC Tricorn Black	Edge Selection: R3 Eased E1 Reverse Bevel	Color: ASL Arctic Silver BWH Bright White MBK Matte Black PEW Pewter SNK Soft Nickel RML Raw (Clear) CHR Chrome* *Upcharge applies	Cutout Codes: N all tables C1M 72" - 120" wide C1C 72" - 120" wide C1O 120" wide C2M 96" - 120" wide C2C 96" - 120" wide C3C 120" wide C3M 120" wide C3MOM 120" wide See chart on page 45 for cutout codes and power and storage unit configurations
		<b>Double Cut</b> DC1 Double Cut	<b>③ Top Wood Finish</b> Double Cut: COF Coffee FOS Fossil KHK Khaki CRM Cremello GRH Graphite STU Studio Teak					

① Specialty Top Model #	② Top Surface Selection	③ Base Wood Species	④a Base Wood Finish	④b Base Paint	⑤ Metal Color	⑥ Electrical
Solid Surface (NAV)	Patterns: ARM Armadillo PEB Pebble Pearl BLP Black Pearl PUR Pure White	<b>Flat Cut</b> CH1 Cherry MA1 Maple WA1 Walnut  <b>Double Cut</b> DC1 Double Cut	See list above for Cherry, Maple and Walnut Finishes	See list above for Paint Finishes	See list above for Metal Paint Colors	Cutout Codes: N all tables C1M 72" - 120" wide C1C 72" - 120" wide C1O 120" wide C2M 96" - 120" wide C2C 96" - 120" wide C3C 120" wide C3M 120" wide C3MOM 120" wide
Glass Surface (NAV)	Backpainted Glass: G White Glossy M White Matte					
Sub-Top w/Base (NAV)	B (Table Ships with Sub-Top, Customer applies custom Top)					

Description

Boat Shape 2pc Table with 3 Panel Bases

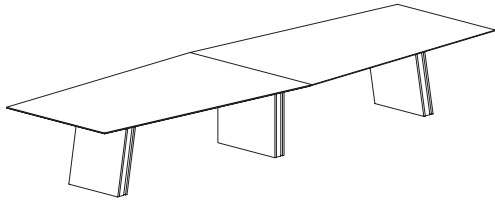

Laminate Tops "NAT" Models

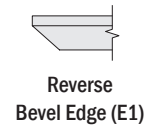
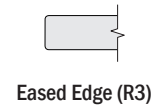

Features:

- three panel bases with structural support rails
- two-piece top
- narrow ends of table are 48"d
- glass top has additional seams

D	W	H	CTN WT	CU FT	① Model	HPL	HPL
60	240	29 3/8	669	170	NAT60240-30BTPB	\$15,769	\$16,250
60	216	29 3/8	618	145	NAT60216-30BTPB	\$14,194	\$14,676
60	192	29 3/8	572	133	NAT60192-30BTPB	\$13,195	\$13,676

Options:

- metal base frame available in powder coat, no upcharge, or chrome, add \$2,923 list upcharge for 60" wide
- worksurface power & storage available, specify cutout code and order power units separately, see pages 150-151

Description

Boat Shape 2pc Table with 2 Panel Bases

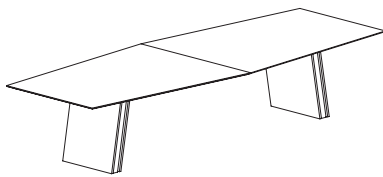

Laminate Tops "NAT" Models

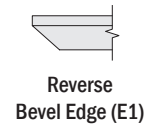
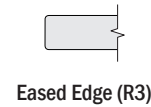

Features:

- two panel bases with structural support rails
- two-piece top
- narrow ends of table are 42"d
- glass top has additional seams

D	W	H	CTN WT	CU FT	① Model	HPL	HPL
54	168	29 3/8	429	98	NAT54168-30BTPB	\$8,910	\$9,391
54	144	29 3/8	379	98	NAT54144-30BTPB	\$8,058	\$8,539
54	132	29 3/8	352	83	NAT54132-30BTPB	\$7,723	\$8,204

Options:

- metal base frame available in powder coat, no upcharge, or chrome, add \$1,170 list upcharge for 54" wide
- worksurface power & storage available, specify cutout code and order power units separately, see pages 150-151

To Order, Specify:

① Laminate Model #	②a Top Laminate / ②b Base Laminate	③ Top Edge	④ Metal Color	⑤ Electrical
Laminate (NAT)	<p>Solid Patterns:</p> <p>ALB Alabaster BBL Bridal Bianco DWH Designer White SHD Shadow SLG Slate Grey</p> <p>Wood Grain Patterns:</p> <p>AGA Aged Ash    BGL Brighton Light    OAT Oatmeal Cookie ALL Ale Light    CLL Collectors    PIN Pinnacle Walnut BLO Blonde Echo    FLO Florence Walnut    STU Studio Teak BOL Bourbon Light    GRH Graphite    VIN Vintage BZW Brazilwood    HGL High Line    WLH Walnut Heights WEA Weathered Ash</p>	<p>Edge Selection:</p> <p>R3 Eased E1 Reverse Bevel</p>	<p>Color:</p> <p>ASL Arctic Silver BWH Bright White MBK Matte Black PEW Pewter SNK Soft Nickel RML Raw (Clear) CHR Chrome* *Upcharge applies</p>	<p>Cutout Codes:</p> <p>N all tables C1M 132" - 240" wide C1C 132" - 240" wide C1O 132" - 240" wide C2M 132" - 240" wide C2C 132" - 240" wide C3M 132" - 240" wide C3C 132" - 240" wide C3MOM 132" - 240" wide</p>

Description

Boat Shape 2pc Table with 3 Panel Bases  
(continued)

Veneer Tops "NAV" Models

Premier Tops "NAV" Models

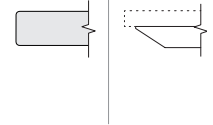
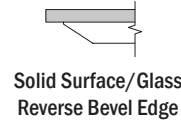
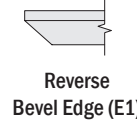
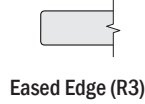

D	W	H	CTN WT	CU FT	① Model	Veneer Tops "NAV" Models		Veneer Tops "NAV" Models		Premier Tops "NAV" Models		Wood Plank Ash	Sub-Top with Base
						Flat Cut	Double Cut	Flat Cut	Double Cut	Solid Surface	Glass		
60	240	29 3/8	669	170	NAV60240-30BTPB	\$20,002	\$21,717	\$20,249	\$21,963	\$41,089	\$38,926	--	\$19,102
60	216	29 3/8	618	145	NAV60216-30BTPB	\$18,146	\$19,795	\$18,393	\$20,043	\$37,172	\$35,177	--	\$17,331
60	192	29 3/8	572	133	NAV60192-30BTPB	\$16,956	\$18,557	\$17,203	\$18,804	\$33,771	\$32,096	--	\$16,194

Description

Boat Shape 2pc Table with 2 Panel Bases  
(continued)

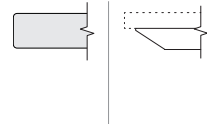
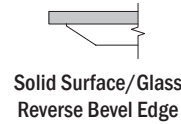
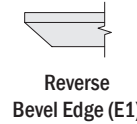
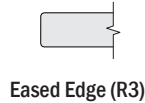

D	W	H	CTN WT	CU FT	① Model	Veneer Tops "NAV" Models		Veneer Tops "NAV" Models		Premier Tops "NAV" Models		Wood Plank Ash	Custom Sub-Base
						Flat Cut	Double Cut	Flat Cut	Double Cut	Solid Surface	Glass		
54	168	29 3/8	429	98	NAV54168-30BTPB	\$11,624	\$12,836	\$11,870	\$13,081	\$24,959	\$23,546	--	\$11,100
54	144	29 3/8	379	98	NAV54144-30BTPB	\$10,548	\$11,671	\$10,795	\$11,918	\$22,038	\$20,768	--	\$10,074
54	132	29 3/8	352	83	NAV54132-30BTPB	\$10,124	\$11,210	\$10,371	\$11,457	\$20,656	\$19,492	--	\$9,670

To Order, Specify:

① Veneer Model #	② Wood Species	③ Top Wood Finish	④ Base Finish	⑤ Top Edge	⑥ Metal Color	⑦ Electrical		
Veneer (NAV)	<b>Flat Cut</b> CH1 Cherry MA1 Maple WA1 Walnut	Cherry: BRL Barley BBM Bourbon Medium BRM Brighton Medium CLA Classic CLL Collectors* EAR Earthy HRV Harvest* LGC Legacy PRL Praline* SAF Saffron Finishes with an asterisk (*) have a coordinating laminate available	Maple: ALM Ale Medium BUT Butterscotch CIN Cinnamon FLX Flax VEN Venetian	Walnut: AUB Auburn ESP Espresso MCH Mocha* NTO Night Owl* SIE Sienna* TOF Toffee TRF Truffle*	V - Same as Top Finish  P - Paint Color: BKD Backdrop BFX Black Fox BWH Bright White CGP Cargo Pants CHT Chatroom FRR French Roast GRV Greek Villa NET Network Gray NWH Nonchalant White STM Storm TRC Tricorn Black	Edge Selection: R3 Eased E1 Reverse Bevel	Color: ASL Arctic Silver BWH Bright White MBK Matte Black PEW Pewter SNK Soft Nickel RML Raw (Clear) CHR Chrome* *Upcharge applies	Cutout Codes: N all tables C1M 132" - 240" wide C1C 132" - 240" wide C1O 132" - 240" wide C2M 132" - 240" wide C2C 132" - 240" wide C3M 132" - 240" wide C3C 132" - 240" wide C3MOM 132" - 240" wide See chart on page 45 for cutout codes and power and storage unit configurations
		<b>Double Cut</b> DC1 Double Cut	<b>③ Top Wood Finish</b> Double Cut: COF Coffee FOS Fossil KHK Khaki CRM Cremello GRH Graphite STU Studio Teak					

① Specialty Top Model #	② Top Surface Selection	③ Base Wood Species	④a Base Wood Finish	④b Base Paint	⑤ Metal Color	⑥ Electrical
Solid Surface (NAV)	Patterns: ARM Armadillo PEB Pebble Pearl BLP Black Pearl PUR Pure White	<b>Flat Cut</b> CH1 Cherry MA1 Maple WA1 Walnut  <b>Double Cut</b> DC1 Double Cut	See list above for Cherry, Maple and Walnut Finishes	See list above for Paint Finishes	See list above for Metal Paint Colors	Cutout Codes: N all tables C1M 132" - 240" wide C1C 132" - 240" wide C1O 132" - 240" wide C2M 132" - 240" wide C2C 132" - 240" wide C3M 132" - 240" wide C3C 132" - 240" wide C3MOM 132" - 240" wide
Glass Surface (NAV)	Backpainted Glass: G White Glossy M White Matte					
Sub-Top w/Base (NAV)	B (Table Ships with Sub-Top, Customer applies custom Top)					



Description

Boat Shape Table with Panel Base

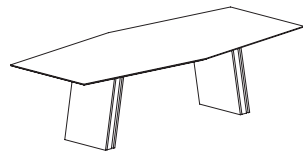

Laminate Tops "NAT" Models

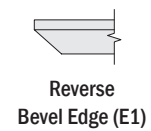
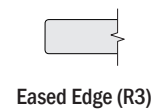

Features:

- two panel bases with structural support rails
- one-piece top
- narrow ends of table are 36" d
- glass top has additional seams

Options:

- metal base frame available in powder coat, no upcharge, or chrome, add \$1,966 list upcharge for 42" & 48" wide
- worksurface power & storage available, specify cutout code and order power units separately, see pages 150-151

D	W	H	CTN WT	CU FT	① Model	HPL	HPL
48	120	29 3/8	295	70	NAT48120-30BTPB	\$6,256	\$6,636
48	108	29 3/8	279	69	NAT48108-30BTPB	\$5,628	\$6,010
48	96	29 3/8	236	59	NAT4896-30BTPB	\$5,671	\$6,053
48	84	29 3/8	236	55	NAT4884-30BTPB	\$5,441	\$5,822
42	72	29 3/8	171	60	NAT4272-30BTPB	\$4,908	\$5,290

NATIVE

To Order, Specify:

① Laminate Model #	②a Top Laminate / ②b Base Laminate	③ Top Edge	④ Metal Color	⑤ Electrical
Laminate (NAT)	<p>Solid Patterns:</p> <p>ALB Alabaster BBL Bridal Bianco DWH Designer White SHD Shadow SLG Slate Grey</p> <p>Wood Grain Patterns:</p> <p>AGA Aged Ash    BGL Brighton Light    OAT Oatmeal Cookie ALL Ale Light    CLL Collectors    PIN Pinnacle Walnut BLO Blonde Echo    FLO Florence Walnut    STU Studio Teak BOL Bourbon Light    GRH Graphite    VIN Vintage BZW Brazilwood    HGL High Line    WLH Walnut Heights WEA Weathered Ash</p>	<p>Edge Selection:</p> <p>R3 Eased E1 Reverse Bevel</p>	<p>Color:</p> <p>ASL Arctic Silver BWH Bright White MBK Matte Black PEW Pewter SNK Soft Nickel RML Raw (Clear) CHR Chrome* *Upcharge applies</p>	<p>Cutout Codes:</p> <p>N all tables C1M 72" - 120" wide C1C 72" - 120" wide C1O 120" wide C2M 96" - 120" wide C2C 96" - 120" wide C3C 120" wide C3M 120" wide C3MOM 120" wide</p>

Description

Boat Shape Table with Panel Base  
(continued)

Veneer Tops "NAV" Models

Premier Tops "NAV" Models



Eased Edge (R3)



Reverse Bevel Edge (E1)

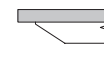

Solid Surface/Glass Reverse Bevel Edge



Wood Plank Ash



Sub-Top with Base

D	W	H	CTN WT	CU FT	① Model	Veneer Tops "NAV" Models		Veneer Tops "NAV" Models		Premier Tops "NAV" Models		Wood Plank Ash	Sub-Top with Base
						Flat Cut	Double Cut	Flat Cut	Double Cut	Solid Surface	Glass		
48	120	29 3/8	295	70	NAV48120-30BTPB	\$8,640	\$9,599	\$8,787	\$9,746	\$17,261	\$16,208	--	\$8,252
48	108	29 3/8	279	69	NAV48108-30BTPB	7772	8636	7918	8781	15573	14585	0	7422
48	96	29 3/8	236	59	NAV4896-30BTPB	\$7,833	\$8,703	\$7,979	\$8,850	\$14,752	\$13,889	--	\$7,480
48	84	29 3/8	236	55	NAV4884-30BTPB	\$7,513	\$8,349	\$7,660	\$8,495	\$13,617	\$12,812	--	\$7,176
42	72	29 3/8	171	60	NAV4272-30BTPB	\$6,779	\$7,532	\$6,926	\$7,680	\$11,453	\$10,754	--	\$6,474

NATIVE

To Order, Specify:

① Veneer Model #	② Wood Species	③ Top Wood Finish	④ Base Finish	⑤ Top Edge	⑥ Metal Color	⑦ Electrical		
Veneer (NAV)	<b>Flat Cut</b> CH1 Cherry MA1 Maple WA1 Walnut	Cherry: BRL Barley BBM Bourbon Medium BRM Brighton Medium CLA Classic CLL Collectors* EAR Earthy HRV Harvest* LGC Legacy PRL Praline* SAF Saffron Finishes with an asterisk (*) have a coordinating laminate available	Maple: ALM Ale Medium BUT Butterscotch CIN Cinnamon FLX Flax VEN Venetian	Walnut: AUB Auburn ESP Espresso MCH Mocha* NTO Night Owl* SIE Sienna* TOF Toffee TRF Truffle*	V - Same as Top Finish  P - Paint Color: BKD Backdrop BFX Black Fox BWH Bright White CGP Cargo Pants CHT Chatroom FRR French Roast GRV Greek Villa NET Network Gray NWH Nonchalant White STM Storm TRC Tricorn Black	Edge Selection: R3 Eased E1 Reverse Bevel	Color: ASL Arctic Silver BWH Bright White MBK Matte Black PEW Pewter SNK Soft Nickel RML Raw (Clear) CHR Chrome* *Upcharge applies	Cutout Codes: N all tables C1M 72" - 120" wide C1C 72" - 120" wide C1O 120" wide C2M 96" - 120" wide C2C 96" - 120" wide C3C 120" wide C3M 120" wide C3MOM 120" wide See chart on page 45 for cutout codes and power and storage unit configurations
		<b>Double Cut</b> DC1 Double Cut	<b>③ Top Wood Finish</b> Double Cut: COF Coffee FOS Fossil KHK Khaki CRM Cremello GRH Graphite STU Studio Teak					

① Specialty Top Model #	② Top Surface Selection	③ Base Wood Species	④a Base Wood Finish	④b Base Paint	⑤ Metal Color	⑥ Electrical
Solid Surface (NAV)	Patterns: ARM Armadillo PEB Pebble Pearl BLP Black Pearl PUR Pure White	<b>Flat Cut</b> CH1 Cherry MA1 Maple WA1 Walnut  <b>Double Cut</b> DC1 Double Cut	See list above for Cherry, Maple and Walnut Finishes  See list above for Double Cut Finishes	See list above for Paint Finishes	See list above for Metal Paint Colors	Cutout Codes: N all tables C1M 72" - 120" wide C1C 72" - 120" wide C1O 120" wide C2M 96" - 120" wide C2C 96" - 120" wide C3C 120" wide C3M 120" wide C3MOM 120" wide
Glass Surface (NAV)	Backpainted Glass: G White Glossy M White Matte					
Sub-Top w/Base (NAV)	B (Table Ships with Sub-Top, Customer applies custom Top)					

Description

View 2pc Table with 3 Panel Bases

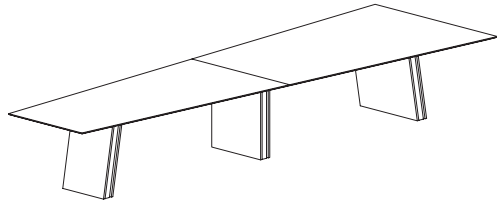

Laminate Tops "NAT" Models

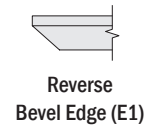
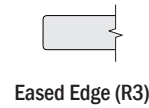

Features:

- three panel bases with structural support rails
- two-piece top
- narrow end of table is 36"d
- glass top has additional seams

D	W	H	CTN WT	CU FT	① Model	HPL	HPL
60	240	29 3/8	614	173	NAT60240-30VTPB	\$15,765	\$16,246
60	216	29 3/8	568	94	NAT60216-30VTPB	\$14,171	\$14,652
60	192	29 3/8	518	133	NAT60192-30VTPB	\$13,375	\$13,856

Options:

- metal base frame available in powder coat, no upcharge, or chrome, add \$2,923 list upcharge for 60" wide
- worksurface power & storage available, specify cutout code and order power units separately, see pages 150-151

Description

View 2pc Table with 2 Panel Bases

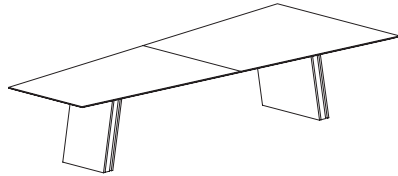

Laminate Tops "NAT" Models

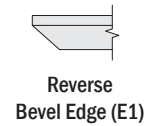
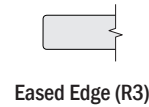

Features:

- two panel bases with structural support rails
- two-piece top
- narrow end of table is 36"d
- glass top has additional seams

D	W	H	CTN WT	CU FT	① Model	HPL	HPL
60	168	29 3/8	430	109	NAT60168-30VTPB	\$9,885	\$10,366
60	144	29 3/8	380	97	NAT60144-30VTPB	\$8,752	\$9,233
60	132	29 3/8	352	91	NAT60132-30VTPB	\$7,455	\$7,936

Options:





- metal base frame available in powder coat, no upcharge, or chrome, add \$2,131 list upcharge for 60" wide
- worksurface power & storage available, specify cutout code and order power units separately, see pages 150-151

To Order, Specify:

① Laminate Model #	②a Top Laminate / ②b Base Laminate	③ Top Edge	④ Metal Color	⑤ Electrical
Laminate (NAT)	<p>Solid Patterns:</p> <p>ALB Alabaster BBL Bridal Bianco DWH Designer White SHD Shadow SLG Slate Grey</p> <p>Wood Grain Patterns:</p> <p>AGA Aged Ash ALL Ale Light BLO Blonde Echo BOL Bourbon Light BZW Brazilwood</p> <p>BGL Brighton Light CLL Collectors FLO Florence Walnut GRH Graphite HGL High Line</p> <p>OAT Oatmeal Cookie PIN Pinnacle Walnut STU Studio Teak VIN Vintage WLH Walnut Heights WEA Weathered Ash</p>	<p>Edge Selection:</p> <p>R3 Eased E1 Reverse Bevel</p>	<p>Color:</p> <p>ASL Arctic Silver BWH Bright White MBK Matte Black PEW Pewter SNK Soft Nickel RML Raw (Clear) CHR Chrome* *Upcharge applies</p>	<p>Cutout Codes:</p> <p>N all tables C1M 132" - 240" wide C1C 132" - 240" wide C1O 132" - 240" wide C2M 132" - 240" wide C2C 132" - 240" wide C3M 132" - 240" wide C3C 132" - 240" wide C3MOM 132" - 240" wide</p>





Description

View 2pc Table with 3 Panel Bases  
(continued)

						Veneer Tops "NAV" Models				Premier Tops "NAV" Models			
						 Eased Edge (R3)		 Reverse Bevel Edge (E1)		 Solid Surface/Glass Reverse Bevel Edge		 	
D	W	H	CTN WT	CU FT	1 Model	Flat Cut	Double Cut	Flat Cut	Double Cut	Solid Surface	Glass	Wood Plank Ash	Sub-Top with Base
60	240	29 3/8	614	173	NAV60240-30VTPB	\$19,998	\$22,141	\$20,244	\$22,387	\$41,084	\$38,922	--	\$19,098
60	216	29 3/8	568	94	NAV60216-30VTPB	\$18,118	\$20,176	\$18,365	\$20,423	\$37,144	\$35,149	--	\$17,304
60	192	29 3/8	518	133	NAV60192-30VTPB	\$17,190	\$19,216	\$17,436	\$19,463	\$34,004	\$32,329	--	\$16,416

Description

View 2pc Table with 2 Panel Bases  
(continued)

						Veneer Tops "NAV" Models				Premier Tops "NAV" Models			
						 Eased Edge (R3)		 Reverse Bevel Edge (E1)		 Solid Surface/Glass Reverse Bevel Edge		 	
D	W	H	CTN WT	CU FT	1 Model	Flat Cut	Double Cut	Flat Cut	Double Cut	Solid Surface	Glass	Wood Plank Ash	Custom Sub-Base
60	168	29 3/8	430	109	NAV60168-30VTPB	\$12,775	\$14,340	\$13,021	\$14,587	\$27,540	\$26,022	--	\$12,202
60	144	29 3/8	380	97	NAV60144-30VTPB	\$11,382	\$12,834	\$11,629	\$13,080	\$24,100	\$22,736	--	\$10,870
60	132	29 3/8	352	91	NAV60132-30VTPB	\$9,715	\$10,971	\$9,963	\$11,218	\$21,375	\$20,124	--	\$9,279

To Order, Specify:

1 Veneer Model #	2 Wood Species	3 Top Wood Finish	4 Base Finish	5 Top Edge	6 Metal Color	7 Electrical		
Veneer (NAV)	Flat Cut CH1 Cherry MA1 Maple WA1 Walnut	Cherry: BRL Barley BBM Bourbon Medium BRM Brighton Medium CLA Classic CLL Collectors* EAR Earthy HRV Harvest* LGC Legacy PRL Praline* SAF Saffron Finishes with an asterisk (*) have a coordinating laminate available	Maple: ALM Ale Medium BUT Butterscotch CIN Cinnamon FLX Flax VEN Venetian	Walnut: AUB Auburn ESP Espresso MCH Mocha* NTO Night Owl* SIE Sienna* TOF Toffee TRF Truffle*	V - Same as Top Finish	Edge Selection: R3 Eased E1 Reverse Bevel	Color: ASL Arctic Silver BWH Bright White MBK Matte Black PEW Pewter SNK Soft Nickel RML Raw (Clear) CHR Chrome* *Upcharge applies	Cutout Codes: N all tables C1M 132" - 240" wide C1C 132" - 240" wide C1O 132" - 240" wide C2M 132" - 240" wide C2C 132" - 240" wide C3M 132" - 240" wide C3C 132" - 240" wide C3MOM 132" - 240" wide See chart on page 45 for cutout codes and power and storage unit configurations
	Double Cut DC1 Double Cut	3 Top Wood Finish Double Cut: COF Coffee FOS Fossil KHK Khaki CRM Cremello GRH Graphite STU Studio Teak	P - Paint Color: BKD Backdrop BFX Black Fox BWH Bright White CGP Cargo Pants CHT Chatroom FRR French Roast GRV Greek Villa NET Network Gray NWH Nonchalant White STM Storm TRC Tricorn Black					

1 Specialty Top Model #	2 Top Surface Selection	3 Base Wood Species	4a Base Wood Finish	4b Base Paint	5 Metal Color	6 Electrical
Solid Surface (NAV)	Patterns: ARM Armadillo PEB Pebble Pearl BLP Black Pearl PUR Pure White	Flat Cut CH1 Cherry MA1 Maple WA1 Walnut  Double Cut DC1 Double Cut	See list above for Cherry, Maple and Walnut Finishes	See list above for Paint Finishes	See list above for Metal Paint Colors	Cutout Codes: N all tables C1M 132" - 240" wide C1C 132" - 240" wide C1O 132" - 240" wide C2M 132" - 240" wide C2C 132" - 240" wide C3M 132" - 240" wide C3C 132" - 240" wide C3MOM 132" - 240" wide
Glass Surface (NAV)	Backpainted Glass: G White Glossy M White Matte					
Sub-Top w/Base (NAV)	B (Table Ships with Sub-Top, Customer applies custom Top)					

Description

View Table with Panel Base

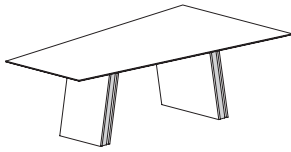

Laminate Tops "NAT" Models

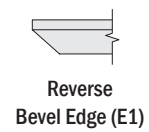
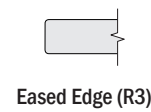

Features:

- two panel bases with structural support rails
- one-piece top
- narrow end of table is 36"d
- glass top has additional seams

Options:

- metal base frame available in powder coat, no upcharge, or chrome, add list upcharge: for 48" wide - \$1,966, for 54" & 60" wide - \$2,249
- worksurface power & storage available, specify cutout code and order power units separately, see pages 150-151

D	W	H	CTN WT	CU FT	① Model	HPL	HPL
60	120	29 3/8	330	94	NAT60120-30VTPB	\$7,109	\$7,491
60	108	29 3/8	311	76	NAT60108-30VTPB	\$6,717	\$7,099
54	96	29 3/8	278	69	NAT5496-30VTPB	\$5,919	\$6,300
54	84	29 3/8	256	62	NAT5484-30VTPB	\$6,343	\$6,724
48	72	29 3/8	177	52	NAT4872-30VTPB	\$5,131	\$5,513



NATIVE

To Order, Specify:

① Laminate Model #	②a Top Laminate / ②b Base Laminate	③ Top Edge	④ Metal Color	⑤ Electrical
Laminate (NAT)	<p>Solid Patterns:</p> <p>ALB Alabaster BBL Bridal Blanco DWH Designer White SHD Shadow SLG Slate Grey</p> <p>Wood Grain Patterns:</p> <p>AGA Aged Ash ALL Ale Light BLO Blonde Echo BOL Bourbon Light BZW Brazilwood</p> <p>BGL Brighton Light CLL Collectors FLO Florence Walnut GRH Graphite HGL High Line</p> <p>OAT Oatmeal Cookie PIN Pinnacle Walnut STU Studio Teak VIN Vintage WLH Walnut Heights WEA Weathered Ash</p>	<p>Edge Selection:</p> <p>R3 Eased E1 Reverse Bevel</p>	<p>Color:</p> <p>ASL Arctic Silver BWH Bright White MBK Matte Black PEW Pewter SNK Soft Nickel RML Raw (Clear) CHR Chrome* *Upcharge applies</p>	<p>Cutout Codes:</p> <p>N all tables C1M 72" - 120" wide C1C 72" - 120" wide C1O 120" wide C2M 96" - 120" wide C2C 96" - 120" wide C3M 120" wide C3C 120" wide C3MOM 120" wide</p>

Description

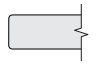
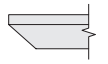
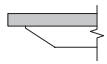
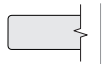
View Table with Panel Base  
(continued)

						Veneer Tops "NAV" Models				Premier Tops "NAV" Models					
						 Eased Edge (R3)		 Reverse Bevel Edge (E1)		 Solid Surface/Glass Reverse Bevel Edge					
D	W	H	CTN WT	CU FT	1 Model	Flat Cut	Double Cut	Flat Cut	Double Cut	Solid Surface	Glass	Wood Plank Ash	Sub-Top with Base		
60	120	29 3/8	330	94	NAV60120-30VTPB	\$9,723	\$10,998	\$9,869	\$11,146	\$20,390	\$19,184	--	\$9,286		
60	108	29 3/8	311	76	NAV60108-30VTPB	\$9,205	\$10,431	\$9,353	\$10,578	\$18,810	\$17,722	--	\$8,794		
54	96	29 3/8	278	69	NAV5496-30VTPB	8132	9010	8280	9158	15868	14946	0	7767		
54	84	29 3/8	256	62	NAV5484-30VTPB	\$8,714	\$9,654	\$8,861	\$9,801	\$15,581	\$14,676	--	\$8,322		
48	72	29 3/8	177	52	NAV4872-30VTPB	\$7,085	\$7,873	\$7,233	\$8,020	\$12,371	\$11,628	--	\$6,767		

NATIVE

To Order, Specify:

1 Veneer Model #	2 Wood Species	3 Top Wood Finish	4 Base Finish	5 Top Edge	6 Metal Color	7 Electrical		
Veneer (NAV)	Flat Cut CH1 Cherry MA1 Maple WA1 Walnut	Cherry: BRL Barley BBM Bourbon Medium BRM Brighton Medium CLA Classic CLL Collectors* EAR Earthy HRV Harvest* LGC Legacy PRL Praline* SAF Saffron Finishes with an asterisk (*) have a coordinating laminate available	Maple: ALM Ale Medium BUT Butterscotch CIN Cinnamon FLX Flax VEN Venetian	Walnut: AUB Auburn ESP Espresso MCH Mocha* NTO Night Owl* SIE Sienna* TOF Toffee TRF Truffle*	V - Same as Top Finish  P - Paint Color: BKD Backdrop BFX Black Fox BWH Bright White CGP Cargo Pants CHT Chatroom FRR French Roast GRV Greek Villa NET Network Gray NWH Nonchalant White STM Storm TRC Tricorn Black	Edge Selection: R3 Eased E1 Reverse Bevel	Color: ASL Arctic Silver BWH Bright White MBK Matte Black PEW Pewter SNK Soft Nickel RML Raw (Clear) CHR Chrome* *Upcharge applies	Cutout Codes: N all tables C1M 72" - 120" wide C1C 72" - 120" wide C1O 120" wide C2M 96" - 120" wide C2C 96" - 120" wide C3C 120" wide C3M 120" wide C3MOM 120" wide See chart on page 45 for cutout codes and power and storage unit configurations
		Double Cut DC1 Double Cut	3 Top Wood Finish Double Cut: COF Coffee FOS Fossil KHK Khaki CRM Cremello GRH Graphite STU Studio Teak					

1 Specialty Top Model #	2 Top Surface Selection	3 Base Wood Species	4a Base Wood Finish	4b Base Paint	5 Metal Color	6 Electrical
Solid Surface (NAV)	Patterns: ARM Armadillo PEB Pebble Pearl BLP Black Pearl PUR Pure White	Flat Cut CH1 Cherry MA1 Maple WA1 Walnut  Double Cut DC1 Double Cut	See list above for Cherry, Maple and Walnut Finishes	See list above for Paint Finishes	See list above for Metal Paint Colors	Cutout Codes: N all tables C1M 72" - 120" wide C1C 72" - 120" wide C1O 120" wide C2M 96" - 120" wide C2C 96" - 120" wide C3C 120" wide C3M 120" wide C3MOM 120" wide
Glass Surface (NAV)	Backpainted Glass: G White Glossy M White Matte					
Sub-Top w/Base (NAV)	B (Table Ships with Sub-Top, Customer applies custom Top)					

Description

Rectangular 2pc Table with 3 Box Bases

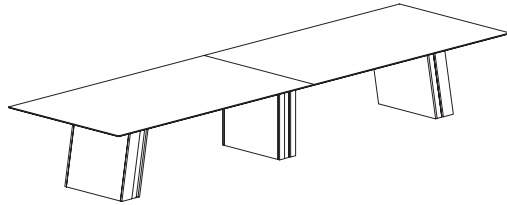

Laminate Tops "NAT" Models

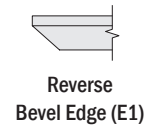
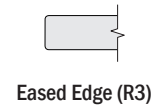

Features:

- three box bases with structural support rails
- two-piece top
- glass top has additional seams

Options:

- metal base frame available in powder coat, no upcharge, or chrome, add list upcharge: for 48" wide - \$2,555, for 54" & 60" wide - \$2,923
- worksurface power & storage available, specify cutout code and order power units separately, see pages 150-151

D	W	H	CTN WT	CU FT	① Model	HPL	HPL
60	240	29 3/8	750	176	NAT60240-30TTBB	\$15,782	\$16,263
60	216	29 3/8	704	150	NAT60216-30TTBB	\$14,197	\$14,678
60	192	29 3/8	644	133	NAT60192-30TTBB	\$13,209	\$13,690
54	240	29 3/8	701	149	NAT54240-30TTBB	\$14,977	\$15,458
54	216	29 3/8	660	141	NAT54216-30TTBB	\$13,528	\$14,009
54	192	29 3/8	605	159	NAT54192-30TTBB	\$12,766	\$13,247
48	192	29 3/8	547	118	NAT48192-30TTBB	\$11,189	\$11,670

NATIVE

To Order, Specify:

① Laminate Model #	②a Top Laminate / ②b Base Laminate	③ Top Edge	④ Metal Color	⑤ Electrical
Laminate (NAT)	Solid Patterns: ALB Alabaster BBL Bridal Bianco DWH Designer White SHD Shadow SLG Slate Grey  Wood Grain Patterns: AGA Aged Ash ALL Ale Light BLO Blonde Echo BOL Bourbon Light BZW Brazilwood BGL Brighton Light CLL Collectors FLO Florence Walnut GRH Graphite HGL High Line OAT Oatmeal Cookie PIN Pinnacle Walnut STU Studio Teak VIN Vintage WLH Walnut Heights WEA Weathered Ash	Edge Selection: R3 Eased E1 Reverse Bevel	Color: ASL Arctic Silver BWH Bright White MBK Matte Black PEW Pewter SNK Soft Nickel RML Raw (Clear) CHR Chrome* *Upcharge applies	Cutout Codes: N all tables C1M 192" - 240" wide C1C 192" - 240" wide C1O 192" - 240" wide C2M 192" - 240" wide C2C 192" - 240" wide C3M 120" - 240" wide C3C 120" - 240" wide C3MOM 120" - 240" wide

Description

Rectangular 2pc Table with 3 Box Bases  
(continued)

						Veneer Tops "NAV" Models				Premier Tops "NAV" Models			
						Eased Edge (R3)		Reverse Bevel Edge (E1)		Solid Surface/Glass Reverse Bevel Edge			
D	W	H	CTN WT	CU FT	① Model	Flat Cut	Double Cut	Flat Cut	Double Cut	Solid Surface	Glass	Wood Plank Ash	Sub-Top with Base
60	240	29 3/8	750	176	NAV60240-30TTBB	\$20,481	\$22,676	\$20,727	\$22,922	\$41,567	\$39,405	--	\$19,560
60	216	29 3/8	704	150	NAV60216-30TTBB	\$18,568	\$20,680	\$18,815	\$20,926	\$37,594	\$35,599	--	\$17,733
60	192	29 3/8	644	133	NAV60192-30TTBB	\$17,366	\$19,415	\$17,612	\$19,660	\$34,180	\$32,504	--	\$16,584
54	240	29 3/8	701	149	NAV54240-30TTBB	\$19,511	\$21,231	\$19,756	\$21,478	\$38,541	\$36,540	--	\$18,633
54	216	29 3/8	660	141	NAV54216-30TTBB	\$17,768	\$19,434	\$18,015	\$19,682	\$34,944	\$33,097	--	\$16,969
54	192	29 3/8	605	159	NAV54192-30TTBB	\$16,831	\$18,450	\$17,078	\$18,696	\$32,010	\$30,457	--	\$16,073
48	192	29 3/8	547	118	NAV48192-30TTBB	\$14,987	\$16,581	\$15,233	\$16,828	\$28,530	\$27,097	--	\$14,314

NATIVE

To Order, Specify:

① Veneer Model #	② Wood Species	③ Top Wood Finish	④ Base Finish	⑤ Top Edge	⑥ Metal Color	⑦ Electrical		
Veneer (NAV)	<b>Flat Cut</b> CH1 Cherry MA1 Maple WA1 Walnut	Cherry: BRL Barley BBM Bourbon Medium BRM Brighton Medium CLA Classic CLL Collectors* EAR Earthy HRV Harvest* LGC Legacy PRL Praline* SAF Saffron Finishes with an asterisk (*) have a coordinating laminate available	Maple: ALM Ale Medium BUT Butterscotch CIN Cinnamon FLX Flax VEN Venetian	Walnut: AUB Auburn ESP Espresso MCH Mocha* NTO Night Owl* SIE Sienna* TOF Toffee TRF Truffle*	V - Same as Top Finish  P - Paint Color: BKD Backdrop BFX Black Fox BWH Bright White CGP Cargo Pants CHT Chatroom FRR French Roast GRV Greek Villa NET Network Gray NWH Nonchalant White STM Storm TRC Tricorn Black	Edge Selection: R3 Eased E1 Reverse Bevel	Color: ASL Arctic Silver BWH Bright White MBK Matte Black PEW Pewter SNK Soft Nickel RML Raw (Clear) CHR Chrome* *Upcharge applies	Cutout Codes: N all tables C1M 192" - 240" wide C1C 192" - 240" wide C1O 192" - 240" wide C2M 192" - 240" wide C2C 192" - 240" wide C3M 120" - 240" wide C3C 120" - 240" wide C3MOM 120" - 240" wide See chart on page 45 for cutout codes and power and storage unit configurations
		<b>Double Cut</b> DC1 Double Cut	<b>③ Top Wood Finish</b> Double Cut: COF Coffee FOS Fossil KHK Khaki CRM Cremello GRH Graphite STU Studio Teak					

① Specialty Top Model #	② Top Surface Selection	③ Base Wood Species	④a Base Wood Finish	④b Base Paint	⑤ Metal Color	⑥ Electrical
Solid Surface (NAV)	Patterns: ARM Armadillo PEB Pebble Pearl BLP Black Pearl PUR Pure White	<b>Flat Cut</b> CH1 Cherry MA1 Maple WA1 Walnut  <b>Double Cut</b> DC1 Double Cut	See list above for Cherry, Maple and Walnut Finishes  See list above for Double Cut Finishes	See list above for Paint Finishes	See list above for Metal Paint Colors	Cutout Codes: N all tables C1M 192" - 240" wide C1C 192" - 240" wide C1O 192" - 240" wide C2M 192" - 240" wide C2C 192" - 240" wide C3M 120" - 240" wide C3C 120" - 240" wide C3MOM 120" - 240" wide
Glass Surface (NAV)	Backpainted Glass: G White Glossy M White Matte					
Sub-Top w/Base (NAV)	B (Table Ships with Sub-Top, Customer applies custom Top)					



Description

Rectangular 2pc Table with 2 Box Bases

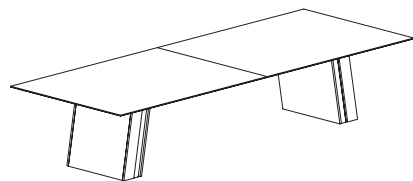

Laminate Tops "NAT" Models

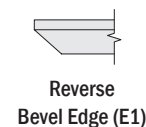
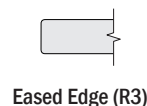

Features:

- two box bases with structural support rails
- two-piece top
- glass top has additional seams

Options:

- metal base frame available in powder coat, no upcharge, or chrome, add list upcharge: for 48" wide - \$1,966, for 54" & 60" wide - \$2,249
- worksurface power & storage available, specify cutout code and order power units separately, see pages 150-151

D	W	H	CTN WT	CU FT	① Model	HPL	HPL
60	168	29 3/8	522	108	NAT60168-30TTBB	\$9,890	\$10,371
60	144	29 3/8	469	97	NAT60144-30TTBB	\$8,013	\$8,494
54	168	29 3/8	495	96	NAT54168-30TTBB	\$9,097	\$9,578
54	144	29 3/8	440	94	NAT54144-30TTBB	\$8,255	\$8,736
54	132	29 3/8	410	91	NAT54132-30TTBB	\$7,924	\$8,405
48	168	29 3/8	448	90	NAT48168-30TTBB	\$8,585	\$9,066
48	144	29 3/8	398	84	NAT48144-30TTBB	\$7,724	\$8,205
48	132	29 3/8	371	78	NAT48132-30TTBB	\$7,526	\$8,007

NATIVE

To Order, Specify:

① Laminate Model #	②a Top Laminate / ②b Base Laminate	③ Top Edge	④ Metal Color	⑤ Electrical
Laminate (NAT)	<p>Solid Patterns:</p> <p>ALB Alabaster BBL Bridal Bianco DWH Designer White SHD Shadow SLG Slate Grey</p> <p>Wood Grain Patterns:</p> <p>AGA Aged Ash    BGL Brighton Light    OAT Oatmeal Cookie ALL Ale Light    CLL Collectors    PIN Pinnacle Walnut BLO Blonde Echo    FLO Florence Walnut    STU Studio Teak BOL Bourbon Light    GRH Graphite    VIN Vintage BZW Brazilwood    HGL High Line    WLH Walnut Heights WEA Weathered Ash</p>	<p>Edge Selection:</p> <p>R3 Eased E1 Reverse Bevel</p>	<p>Color:</p> <p>ASL Arctic Silver BWH Bright White MBK Matte Black PEW Pewter SNK Soft Nickel RML Raw (Clear) CHR Chrome* *Upcharge applies</p>	<p>Cutout Codes:</p> <p>N all tables C1M 132" - 168" wide C1C 132" - 168" wide C1O 132" - 168" wide C2M 132" - 168" wide C2C 132" - 168" wide C3M 132" - 168" wide C3C 132" - 168" wide C3MOM 132" - 168" wide</p>

Description

Rectangular 2pc Table with 2 Box Bases  
(continued)

Veneer Tops "NAV" Models

Premier Tops "NAV" Models



Eased Edge (R3)



Reverse Bevel Edge (E1)

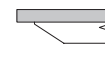

Solid Surface/Glass Reverse Bevel Edge

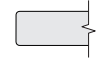

Wood Plank Ash

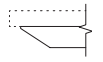

Sub-Top with Base

D	W	H	CTN WT	CU FT	Model	Veneer Tops "NAV" Models		Premier Tops "NAV" Models		Solid Surface	Glass	Wood Plank Ash	Sub-Top with Base
						Flat Cut	Double Cut	Flat Cut	Double Cut				
60	168	29 3/8	522	108	NAV60168-30TTBB	\$13,076	\$14,679	\$13,323	\$14,926	\$27,841	\$26,323	--	\$12,489
60	144	29 3/8	469	97	NAV60144-30TTBB	\$10,660	\$12,020	\$10,906	\$12,267	\$23,377	\$22,014	--	\$10,181
54	168	29 3/8	495	96	NAV54168-30TTBB	\$12,141	\$13,406	\$12,388	\$13,653	\$25,478	\$24,063	--	\$11,596
54	144	29 3/8	440	94	NAV54144-30TTBB	\$11,055	\$12,231	\$11,302	\$12,477	\$22,544	\$21,272	--	\$10,558
54	132	29 3/8	410	91	NAV54132-30TTBB	\$10,624	\$11,763	\$10,871	\$12,010	\$21,156	\$19,993	--	\$10,147
48	168	29 3/8	448	90	NAV48168-30TTBB	\$11,525	\$12,769	\$11,771	\$13,016	\$23,430	\$22,123	--	\$11,007
48	144	29 3/8	398	84	NAV48144-30TTBB	\$10,485	\$11,651	\$10,732	\$11,898	\$20,749	\$19,569	--	\$10,015
48	132	29 3/8	371	78	NAV48132-30TTBB	\$10,154	\$11,282	\$10,401	\$11,528	\$19,563	\$18,480	--	\$9,698

NATIVE

To Order, Specify:

1 Veneer Model #	2 Wood Species	3 Top Wood Finish	4 Base Finish	5 Top Edge	6 Metal Color	7 Electrical
Veneer (NAV)	Flat Cut CH1 Cherry MA1 Maple WA1 Walnut	<p>Cherry: BRL Barley BBM Bourbon Medium BRM Brighton Medium CLA Classic CLL Collectors* EAR Earthy HRV Harvest* LGC Legacy PRL Praline* SAF Saffron</p> <p>Maple: ALM Ale Medium BUT Butterscotch CIN Cinnamon FLX Flax VEN Venetian</p> <p>Walnut: AUB Auburn ESP Espresso MCH Mocha* NTO Night Owl* SIE Sienna* TOF Toffee TRF Truffle*</p> <p>Finishes with an asterisk (*) have a coordinating laminate available</p>	<p>V - Same as Top Finish</p> <p>P - Paint Color: BKD Backdrop BFX Black Fox BWH Bright White CGP Cargo Pants CHT Chatroom FRR French Roast GRV Greek Villa NET Network Gray NWH Nonchalant White STM Storm TRC Tricorn Black</p>	<p>Edge Selection: R3 Eased E1 Reverse Bevel</p>	<p>Color: ASL Arctic Silver BWH Bright White MBK Matte Black PEW Pewter SNK Soft Nickel RML Raw (Clear) CHR Chrome* *Upcharge applies</p>	<p>Cutout Codes: N all tables C1M 132" - 168" wide C1C 132" - 168" wide C1O 132" - 168" wide C2M 132" - 168" wide C2C 132" - 168" wide C3M 132" - 168" wide C3C 132" - 168" wide C3MOM 132" - 168" wide See chart on page 45 for cutout codes and power and storage unit configurations</p>
	Double Cut DC1 Double Cut	<p>3 Top Wood Finish</p> <p>Double Cut: COF Coffee FOS Fossil KHK Khaki CRM Cremello GRH Graphite STU Studio Teak</p>				

1 Specialty Top Model #	2 Top Surface Selection	3 Base Wood Species	4a Base Wood Finish	4b Base Paint	5 Metal Color	6 Electrical
Solid Surface (NAV)	<p>Patterns: ARM Armadillo PEB Pebble Pearl BLP Black Pearl PUR Pure White</p>	<p>Flat Cut CH1 Cherry MA1 Maple WA1 Walnut</p> <p>Double Cut DC1 Double Cut</p>	<p>See list above for Cherry, Maple and Walnut Finishes</p>	<p>See list above for Paint Finishes</p>	<p>See list above for Metal Paint Colors</p>	<p>Cutout Codes: N all tables C1M 132" - 168" wide C1C 132" - 168" wide C1O 132" - 168" wide C2M 132" - 168" wide C2C 132" - 168" wide C3M 132" - 168" wide C3C 132" - 168" wide C3MOM 132" - 168" wide</p>
Glass Surface (NAV)	<p>Backpainted Glass: G White Glossy M White Matte</p>					
Sub-Top w/Base (NAV)	<p>B (Table Ships with Sub-Top, Customer applies custom Top)</p>					

Description

Rectangular Table with Box Base

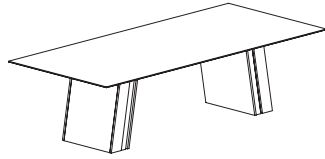

Laminate Tops "NAT" Models

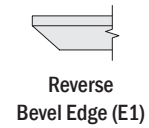
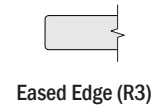

Features:

- two box bases with structural support rails
- one-piece top
- glass top has additional seams

Options:

- metal base frame available in powder coat, no upcharge, or chrome, add list upcharge: for 42" & 48" wide - \$1,966, for 54" wide - \$2,249
- worksurface power & storage available, specify cutout code and order power units separately, see pages 150-151

D	W	H	CTN WT	CU FT	① Model	HPL	HPL
54	120	29 3/8	385	82	NAT54120-30TTBB	\$6,788	\$7,170
48	120	29 3/8	349	72	NAT48120-30TTBB	\$6,461	\$6,842
48	108	29 3/8	330	66	NAT48108-30TTBB	\$5,972	\$6,353
48	96	29 3/8	307	66	NAT4896-30TTBB	\$5,783	\$6,165
42	120	29 3/8	324	68	NAT42120-30TTBB	\$6,381	\$6,763
42	108	29 3/8	308	63	NAT42108-30TTBB	\$5,824	\$6,206
42	96	29 3/8	287	63	NAT4296-30TTBB	\$5,720	\$6,102

NATIVE

To Order, Specify:

① Laminate Model #	②a Top Laminate / ②b Base Laminate	③ Top Edge	④ Metal Color	⑤ Electrical
Laminate (NAT)	<p>Solid Patterns:</p> <p>ALB Alabaster BBL Bridal Blanco DWH Designer White SHD Shadow SLG Slate Grey</p> <p>Wood Grain Patterns:</p> <p>AGA Aged Ash    BGL Brighton Light    OAT Oatmeal Cookie ALL Ale Light    CLL Collectors    PIN Pinnacle Walnut BLO Blonde Echo    FLO Florence Walnut    STU Studio Teak BOL Bourbon Light    GRH Graphite    VIN Vintage BZW Brazilwood    HGL High Line    WLH Walnut Heights WEA Weathered Ash</p>	<p>Edge Selection:</p> <p>R3 Eased E1 Reverse Bevel</p>	<p>Color:</p> <p>ASL Arctic Silver BWH Bright White MBK Matte Black PEW Pewter SNK Soft Nickel RML Raw (Clear) CHR Chrome* *Upcharge applies</p>	<p>Cutout Codes:</p> <p>N all tables C1M 96" - 120" wide C1C 96" - 120" wide C1O 120" wide C2M 96" - 120" wide C2C 96" - 120" wide C3M 120" wide C3C 120" wide C3MOM 120" wide</p>

Description

Rectangular Table with Box Base  
(continued)

						Veneer Tops "NAV" Models				Premier Tops "NAV" Models			
						Eased Edge (R3)		Reverse Bevel Edge (E1)		Solid Surface/Glass Reverse Bevel Edge		Wood Plank Ash	
D	W	H	CTN WT	CU FT	1 Model	Flat Cut	Double Cut	Flat Cut	Double Cut	Solid Surface	Glass	Wood Plank Ash	Sub-Top with Base
54	120	29 3/8	385	82	NAV54120-30TTBB	\$9,552	\$10,583	\$9,700	\$10,731	\$19,199	\$18,068	--	\$9,124
48	120	29 3/8	349	72	NAV48120-30TTBB	\$9,136	\$10,152	\$9,283	\$10,298	\$17,759	\$16,705	\$14,514	\$8,725
48	108	29 3/8	330	66	NAV48108-30TTBB	\$8,446	\$9,384	\$8,592	\$9,531	\$16,249	\$15,259	\$13,287	\$8,067
48	96	29 3/8	307	66	NAV4896-30TTBB	\$8,177	\$9,087	\$8,324	\$9,233	\$15,098	\$14,234	\$12,480	\$7,810
42	120	29 3/8	324	68	NAV42120-30TTBB	\$9,024	\$10,027	\$9,171	\$10,175	\$16,570	\$15,647	\$13,729	\$8,619
42	108	29 3/8	308	63	NAV42108-30TTBB	\$8,236	\$9,153	\$8,384	\$9,299	\$15,065	\$14,198	\$12,473	\$7,867
42	96	29 3/8	287	63	NAV4296-30TTBB	\$8,088	\$8,987	\$8,235	\$9,134	\$14,193	\$13,387	\$11,853	\$7,724

NATIVE

To Order, Specify:

1 Veneer Model #	2 Wood Species	3 Top Wood Finish	4 Base Finish	5 Top Edge	6 Metal Color	7 Electrical		
Veneer (NAV)	Flat Cut CH1 Cherry MA1 Maple WA1 Walnut	Cherry: BRL Barley BBM Bourbon Medium BRM Brighton Medium CLA Classic CLL Collectors* EAR Earthy HRV Harvest* LGC Legacy PRL Praline* SAF Saffron	Maple: ALM Ale Medium BUT Butterscotch CIN Cinnamon FLX Flax VEN Venetian	Walnut: AUB Auburn ESP Espresso MCH Mocha* NTO Night Owl* SIE Sienna* TOF Toffee TRF Truffle*	V - Same as Top Finish  P - Paint Color: BKD Backdrop BFX Black Fox BWH Bright White CGP Cargo Pants CHT Chatroom FRR French Roast GRV Greek Villa NET Network Gray NWH Nonchalant White STM Storm TRC Tricorn Black	Edge Selection: R3 Eased E1 Reverse Bevel	Color: ASL Arctic Silver BWH Bright White MBK Matte Black PEW Pewter SNK Soft Nickel RML Raw (Clear) CHR Chrome* *Upcharge applies	Cutout Codes: N all tables C1M 96" - 120" wide C1C 96" - 120" wide C1O 120" wide C2M 96" - 120" wide C2C 96" - 120" wide C3M 120" wide C3C 120" wide C3MOM 120" wide See chart on page 45 for cutout codes and power and storage unit configurations
		Double Cut DC1 Double Cut	3 Top Wood Finish Double Cut: COF Coffee FOS Fossil KHK Khaki CRM Cremello GRH Graphite STU Studio Teak					

1 Specialty Top Model #	2 Top Surface Selection	3 Base Wood Species	4a Base Wood Finish	4b Base Paint	5 Metal Color	6 Electrical
Solid Surface (NAV)	Patterns: ARM Armadillo PEB Pebble Pearl BLP Black Pearl PUR Pure White	Flat Cut CH1 Cherry MA1 Maple WA1 Walnut	See list above for Cherry, Maple and Walnut Finishes	See list above for Paint Finishes	See list above for Metal Paint Colors	Cutout Codes: N all tables C1M 96" - 120" wide C1C 96" - 120" wide C1O 120" wide C2M 96" - 120" wide C2C 96" - 120" wide C3M 120" wide C3C 120" wide C3MOM 120" wide
Glass Surface (NAV)	Backpainted Glass: G White Glossy M White Matte					
Wood Plank (NAV)	W Wood Plank Ash, Clear Coat	Double Cut DC1 Double Cut	See list above for Double Cut Finishes			
Sub-Top w/Base (NAV)	B (Table Ships with Sub-Top, Customer applies custom Top)					

Description

Arc End 2pc Table with 3 Box Bases

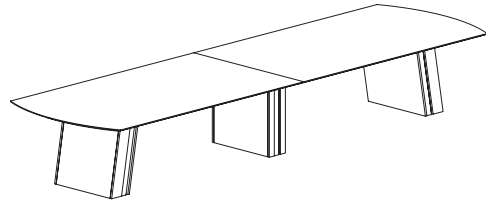

Laminate Tops "NAT" Models

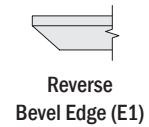
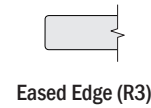

Features:

- three box bases with structural support rails
- two-piece top
- glass top has additional seams

Options:

- metal base frame available in powder coat, no upcharge, or chrome, add list upcharge: for 48" wide - \$2,555, for 54" & 60" wide - \$2,923
- worksurface power & storage available, specify cutout code and order power units separately, see pages 150-151

D	W	H	CTN WT	CU FT	① Model	HPL	HPL
60	240	29 3/8	742	176	NAT60240-30ARBB	\$15,782	\$16,263
60	216	29 3/8	696	150	NAT60216-30ARBB	\$14,197	\$14,678
60	192	29 3/8	636	133	NAT60192-30ARBB	\$13,209	\$13,690
54	240	29 3/8	653	150	NAT54240-30ARBB	\$14,977	\$15,458
54	216	29 3/8	654	141	NAT54216-30ARBB	\$13,528	\$14,009
54	192	29 3/8	598	134	NAT54192-30ARBB	\$12,766	\$13,247
48	192	29 3/8	341	116	NAT48192-30ARBB	\$11,189	\$11,670

NATIVE

To Order, Specify:

① Laminate Model #	②a Top Laminate / ②b Base Laminate	③ Top Edge	④ Metal Color	⑤ Electrical
Laminate (NAT)	<p>Solid Patterns:</p> <p>ALB Alabaster BBL Bridal Bianco DWH Designer White SHD Shadow SLG Slate Grey</p> <p>Wood Grain Patterns:</p> <p>AGA Aged Ash ALL Ale Light BLO Blonde Echo BOL Bourbon Light BZW Brazilwood</p> <p>BGL Brighton Light CLL Collectors FLO Florence Walnut GRH Graphite HGL High Line</p> <p>OAT Oatmeal Cookie PIN Pinnacle Walnut STU Studio Teak VIN Vintage WLH Walnut Heights WEA Weathered Ash</p>	<p>Edge Selection:</p> <p>R3 Eased E1 Reverse Bevel</p>	<p>Color:</p> <p>ASL Arctic Silver BWH Bright White MBK Matte Black PEW Pewter SNK Soft Nickel RML Raw (Clear) CHR Chrome* *Upcharge applies</p>	<p>Cutout Codes:</p> <p>N all tables C1M 192" - 240" wide C1C 192" - 240" wide C1O 192" - 240" wide C2M 192" - 240" wide C2C 192" - 240" wide C3M 192" - 240" wide C3C 192" - 240" wide C3MOM 192" - 240" wide</p>

Description

Arc End 2pc Table with 3 Box Bases  
(continued)

						Veneer Tops "NAV" Models				Premier Tops "NAV" Models			
						Eased Edge (R3)		Reverse Bevel Edge (E1)		Solid Surface/Glass Reverse Bevel Edge		Wood Plank Ash	
D	W	H	CTN WT	CU FT	1 Model	Flat Cut	Double Cut	Flat Cut	Double Cut	Solid Surface	Glass	Wood Plank Ash	Sub-Top with Base
60	240	29 3/8	742	176	NAV60240-30ARBB	\$20,481	\$22,676	\$20,727	\$22,922	\$41,567	\$39,405	--	\$19,560
60	216	29 3/8	696	150	NAV60216-30ARBB	\$18,568	\$20,680	\$18,815	\$20,926	\$37,594	\$35,599	--	\$17,733
60	192	29 3/8	636	133	NAV60192-30ARBB	\$17,366	\$19,415	\$17,612	\$19,660	\$34,180	\$32,504	--	\$16,584
54	240	29 3/8	653	150	NAV54240-30ARBB	\$19,511	\$21,231	\$19,756	\$21,478	\$38,541	\$36,540	--	\$18,633
54	216	29 3/8	654	141	NAV54216-30ARBB	\$17,768	\$19,434	\$18,015	\$19,682	\$34,944	\$33,097	--	\$16,969
54	192	29 3/8	598	134	NAV54192-30ARBB	\$16,831	\$18,450	\$17,078	\$18,696	\$32,010	\$30,457	--	\$16,073
48	192	29 3/8	341	116	NAV48192-30ARBB	\$14,987	\$16,581	\$15,233	\$16,828	\$28,530	\$27,097	--	\$14,314

NATIVE

To Order, Specify:

1 Veneer Model #	2 Wood Species	3 Top Wood Finish	4 Base Finish	5 Top Edge	6 Metal Color	7 Electrical
Veneer (NAV)	Flat Cut CH1 Cherry MA1 Maple WA1 Walnut	<p>Cherry: BRL Barley BBM Bourbon Medium BRM Brighton Medium CLA Classic CLL Collectors* EAR Earthy HRV Harvest* LGC Legacy PRL Praline* SAF Saffron</p> <p>Maple: ALM Ale Medium BUT Butterscotch CIN Cinnamon FLX Flax VEN Venetian</p> <p>Walnut: AUB Auburn ESP Espresso MCH Mocha* NTO Night Owl* SIE Sienna* TOF Toffee TRF Truffle*</p> <p>Finishes with an asterisk (*) have a coordinating laminate available</p>	<p>V - Same as Top Finish</p> <p>P - Paint Color: BKD Backdrop BFX Black Fox BWH Bright White CGP Cargo Pants CHT Chatroom FRR French Roast GRV Greek Villa NET Network Gray NWH Nonchalant White STM Storm TRC Tricorn Black</p>	<p>Edge Selection: R3 Eased E1 Reverse Bevel</p>	<p>Color: ASL Arctic Silver BWH Bright White MBK Matte Black PEW Pewter SNK Soft Nickel RML Raw (Clear) CHR Chrome* *Upcharge applies</p>	<p>Cutout Codes: N all tables C1M 192" - 240" wide C1C 192" - 240" wide C1O 192" - 240" wide C2M 192" - 240" wide C2C 192" - 240" wide C3M 192" - 240" wide C3C 192" - 240" wide C3MOM 192" - 240" wide See chart on page 45 for cutout codes and power and storage unit configurations</p>
	Double Cut DC1 Double Cut	<p>3 Top Wood Finish</p> <p>Double Cut: COF Coffee FOS Fossil KHK Khaki CRM Cremello GRH Graphite STU Studio Teak</p>				

1 Specialty Top Model #	2 Top Surface Selection	3 Base Wood Species	4a Base Wood Finish	4b Base Paint	5 Metal Color	6 Electrical
Solid Surface (NAV)	<p>Patterns: ARM Armadillo PEB Pebble Pearl BLP Black Pearl PUR Pure White</p>	<p>Flat Cut CH1 Cherry MA1 Maple WA1 Walnut</p> <p>Double Cut DC1 Double Cut</p>	<p>See list above for Cherry, Maple and Walnut Finishes</p>	<p>See list above for Paint Finishes</p>	<p>See list above for Metal Paint Colors</p>	<p>Cutout Codes: N all tables C1M 192" - 240" wide C1C 192" - 240" wide C1O 192" - 240" wide C2M 192" - 240" wide C2C 192" - 240" wide C3M 192" - 240" wide C3C 192" - 240" wide C3MOM 192" - 240" wide</p>
Glass Surface (NAV)	<p>Backpainted Glass: G White Glossy M White Matte</p>					
Sub-Top w/Base (NAV)	<p>B (Table Ships with Sub-Top, Customer applies custom Top)</p>					

Description

Arc End 2pc Table with 2 Box Bases

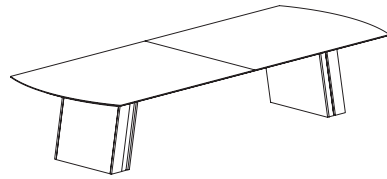

Laminate Tops "NAT" Models

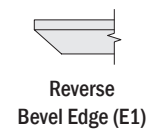
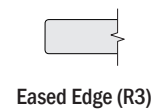

Features:

- two box bases with structural support rails
- two-piece top
- glass top has additional seams

Options:

- metal base frame available in powder coat, no upcharge, or chrome, add list upcharge: for 48" wide - \$1,966, for 54" & 60" wide - \$2,249
- worksurface power & storage available, specify cutout code and order power units separately, see pages 150-151

D	W	H	CTN WT	CU FT	① Model	HPL	HPL
60	168	29 3/8	529	108	NAT60168-30ARBB	\$9,890	\$10,371
60	144	29 3/8	462	97	NAT60144-30ARBB	\$8,013	\$8,494
54	168	29 3/8	489	104	NAT54168-30ARBB	\$9,097	\$9,578
54	144	29 3/8	434	92	NAT54144-30ARBB	\$8,255	\$8,736
54	132	29 3/8	303	86	NAT54132-30ARBB	\$7,205	\$7,686
48	168	29 3/8	341	90	NAT48168-30ARBB	\$8,585	\$9,066
48	144	29 3/8	365	84	NAT48144-30ARBB	\$7,773	\$8,254
48	132	29 3/8	365	78	NAT48132-30ARBB	\$7,479	\$7,960

NATIVE

To Order, Specify:

① Laminate Model #	②a Top Laminate / ②b Base Laminate	③ Top Edge	④ Metal Color	⑤ Electrical
Laminate (NAT)	<p>Solid Patterns:</p> <p>ALB Alabaster BBL Bridal Blanco DWH Designer White SHD Shadow SLG Slate Grey</p> <p>Wood Grain Patterns:</p> <p>AGA Aged Ash    BGL Brighton Light    OAT Oatmeal Cookie ALL Ale Light    CLL Collectors    PIN Pinnacle Walnut BLO Blonde Echo    FLO Florence Walnut    STU Studio Teak BOL Bourbon Light    GRH Graphite    VIN Vintage BZW Brazilwood    HGL High Line    WLH Walnut Heights WEA Weathered Ash</p>	<p>Edge Selection:</p> <p>R3 Eased E1 Reverse Bevel</p>	<p>Color:</p> <p>ASL Arctic Silver BWH Bright White MBK Matte Black PEW Pewter SNK Soft Nickel RML Raw (Clear) CHR Chrome* *Upcharge applies</p>	<p>Cutout Codes:</p> <p>N all tables C1M 132" - 168" wide C1C 132" - 168" wide C1O 132" - 168" wide C2M 132" - 168" wide C2C 132" - 168" wide C3M 132" - 168" wide C3C 132" - 168" wide C3MOM 132" - 168" wide</p>

Description

Arc End 2pc Table with 2 Box Bases  
(continued)

						Veneer Tops "NAV" Models				Premier Tops "NAV" Models			
						Eased Edge (R3)		Reverse Bevel Edge (E1)		Solid Surface/Glass Reverse Bevel Edge			
D	W	H	CTN WT	CU FT	1 Model	Flat Cut	Double Cut	Flat Cut	Double Cut	Solid Surface	Glass	Wood Plank Ash	Sub-Top with Base
60	168	29 3/8	529	108	NAV60168-30ARBB	\$13,076	\$14,679	\$13,323	\$14,926	\$27,841	\$26,323	--	\$12,489
60	144	29 3/8	462	97	NAV60144-30ARBB	\$10,660	\$12,020	\$10,906	\$12,267	\$23,377	\$22,014	--	\$10,181
54	168	29 3/8	489	104	NAV54168-30ARBB	\$12,141	\$13,406	\$12,388	\$13,653	\$25,478	\$24,063	--	\$11,596
54	144	29 3/8	434	92	NAV54144-30ARBB	\$11,055	\$12,231	\$11,302	\$12,477	\$22,544	\$21,272	--	\$10,558
54	132	29 3/8	303	86	NAV54132-30ARBB	9662	10697	9908	10944	20194	19030	0	9226
48	168	29 3/8	341	90	NAV48168-30ARBB	\$11,525	\$12,769	\$11,771	\$13,016	\$23,430	\$22,123	--	\$11,007
48	144	29 3/8	365	84	NAV48144-30ARBB	\$10,422	\$11,579	\$10,669	\$11,826	\$20,686	\$19,505	--	\$9,953
48	132	29 3/8	365	78	NAV48132-30ARBB	\$10,092	\$11,213	\$10,338	\$11,460	\$19,501	\$18,419	--	\$9,638

NATIVE

To Order, Specify:

1 Veneer Model #	2 Wood Species	3 Top Wood Finish	4 Base Finish	5 Top Edge	6 Metal Color	7 Electrical
Veneer (NAV)	Flat Cut CH1 Cherry MA1 Maple WA1 Walnut	<p>Cherry: BRL Barley BBM Bourbon Medium BRM Brighton Medium CLA Classic CLL Collectors* EAR Earthy HRV Harvest* LGC Legacy PRL Praline* SAF Saffron</p> <p>Maple: ALM Ale Medium BUT Butterscotch CIN Cinnamon FLX Flax VEN Venetian</p> <p>Walnut: AUB Auburn ESP Espresso MCH Mocha* NTO Night Owl* SIE Sienna* TOF Toffee TRF Truffle*</p> <p>Finishes with an asterisk (*) have a coordinating laminate available</p>	<p>V - Same as Top Finish</p> <p>P - Paint Color: BKD Backdrop BFX Black Fox BWH Bright White CGP Cargo Pants CHT Chatroom FRR French Roast GRV Greek Villa NET Network Gray NWH Nonchalant White STM Storm TRC Tricorn Black</p>	<p>Edge Selection: R3 Eased E1 Reverse Bevel</p>	<p>Color: ASL Arctic Silver BWH Bright White MBK Matte Black PEW Pewter SNK Soft Nickel RML Raw (Clear) CHR Chrome* *Upcharge applies</p>	<p>Cutout Codes: N all tables C1M 132" - 168" wide C1C 132" - 168" wide C1O 132" - 168" wide C2M 132" - 168" wide C2C 132" - 168" wide C3M 132" - 168" wide C3C 132" - 168" wide C3MOM 132" - 168" wide</p> <p>See chart on page 45 for cutout codes and power and storage unit configurations</p>
	Double Cut DC1 Double Cut	<p>3 Top Wood Finish</p> <p>Double Cut: COF Coffee FOS Fossil KHK Khaki CRM Cremello GRH Graphite STU Studio Teak</p>				

1 Specialty Top Model #	2 Top Surface Selection	3 Base Wood Species	4a Base Wood Finish	4b Base Paint	5 Metal Color	6 Electrical
Solid Surface (NAV)	<p>Patterns: ARM Armadillo PEB Pebble Pearl BLP Black Pearl PUR Pure White</p>	<p>Flat Cut CH1 Cherry MA1 Maple WA1 Walnut</p> <p>Double Cut DC1 Double Cut</p>	<p>See list above for Cherry, Maple and Walnut Finishes</p>	<p>See list above for Paint Finishes</p>	<p>See list above for Metal Paint Colors</p>	<p>Cutout Codes: N all tables C1M 132" - 168" wide C1C 132" - 168" wide C1O 132" - 168" wide C2M 132" - 168" wide C2C 132" - 168" wide C3M 132" - 168" wide C3C 132" - 168" wide C3MOM 132" - 168" wide</p>
Glass Surface (NAV)	<p>Backpainted Glass: G White Glossy M White Matte</p>					
Sub-Top w/Base (NAV)	<p>B (Table Ships with Sub-Top, Customer applies custom Top)</p>					



Description

Arc End Table with Box Base

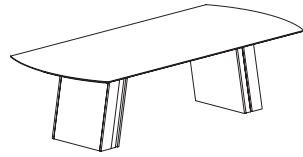

Laminate Tops "NAT" Models

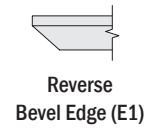
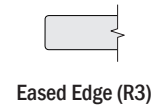

Features:

- two box bases with structural support rails
- one-piece top
- glass top has additional seams

Options:

- metal base frame available in powder coat, no upcharge, or chrome, add list upcharge: for 42" & 48" wide - \$1,966, for 54" wide - \$2,249
- worksurface power & storage available, specify cutout code and order power units separately, see pages 150-151

D	W	H	CTN WT	CU FT	① Model	HPL	HPL
54	120	29 3/8	379	80	NAT54120-30ARBB	\$6,788	\$7,170
48	120	29 3/8	343	74	NAT48120-30ARBB	\$6,461	\$6,842
48	108	29 3/8	325	68	NAT48108-30ARBB	\$5,972	\$6,353
48	96	29 3/8	301	63	NAT4896-30ARBB	\$5,783	\$6,165
42	120	29 3/8	319	70	NAT42120-30ARBB	\$6,381	\$6,763
42	108	29 3/8	304	66	NAT42108-30ARBB	\$5,824	\$6,206
42	96	29 3/8	282	63	NAT4296-30ARBB	\$5,790	\$6,172

NATIVE

To Order, Specify:

① Laminate Model #	②a Top Laminate / ②b Base Laminate	③ Top Edge	④ Metal Color	⑤ Electrical
Laminate (NAT)	<p>Solid Patterns:</p> <p>ALB Alabaster BBL Bridal Bianco DWH Designer White SHD Shadow SLG Slate Grey</p> <p>Wood Grain Patterns:</p> <p>AGA Aged Ash    BGL Brighton Light    OAT Oatmeal Cookie ALL Ale Light    CLL Collectors    PIN Pinnacle Walnut BLO Blonde Echo    FLO Florence Walnut    STU Studio Teak BOL Bourbon Light    GRH Graphite    VIN Vintage BZW Brazilwood    HGL High Line    WLH Walnut Heights WEA Weathered Ash</p>	<p>Edge Selection:</p> <p>R3 Eased E1 Reverse Bevel</p>	<p>Color:</p> <p>ASL Arctic Silver BWH Bright White MBK Matte Black PEW Pewter SNK Soft Nickel RML Raw (Clear) CHR Chrome* *Upcharge applies</p>	<p>Cutout Codes:</p> <p>N all tables C1M 96" - 120" wide C1C 96" - 120" wide C1O 120" wide C2M 96" - 120" wide C2C 96" - 120" wide C3M 120" wide C3C 120" wide C3MOM 120" wide</p>

Description

Arc End Table with Box Base  
(continued)

						Veneer Tops "NAV" Models				Premier Tops "NAV" Models			
						Eased Edge (R3)		Reverse Bevel Edge (E1)		Solid Surface/Glass Reverse Bevel Edge		Wood Plank Ash	
D	W	H	CTN WT	CU FT	① Model	Flat Cut	Double Cut	Flat Cut	Double Cut	Solid Surface	Glass	Wood Plank Ash	Sub-Top with Base
54	120	29 3/8	379	80	NAV54120-30ARBB	\$9,552	\$10,583	\$9,700	\$10,731	\$19,199	\$18,068	--	\$9,124
48	120	29 3/8	343	74	NAV48120-30ARBB	\$9,136	\$10,152	\$9,283	\$10,298	\$17,759	\$16,705	--	\$8,725
48	108	29 3/8	325	68	NAV48108-30ARBB	\$8,446	\$9,384	\$8,592	\$9,531	\$16,249	\$15,259	--	\$8,067
48	96	29 3/8	301	63	NAV4896-30ARBB	\$8,177	\$9,087	\$8,324	\$9,233	\$15,098	\$14,234	--	\$7,810
42	120	29 3/8	319	70	NAV42120-30ARBB	\$9,024	\$10,027	\$9,171	\$10,175	\$16,570	\$15,647	--	\$8,619
42	108	29 3/8	304	66	NAV42108-30ARBB	\$8,236	\$9,153	\$8,384	\$9,299	\$15,065	\$14,198	--	\$7,867
42	96	29 3/8	282	63	NAV4296-30ARBB	\$8,189	\$9,099	\$8,336	\$9,247	\$14,294	\$13,488	--	\$7,821

NATIVE

To Order, Specify:

① Veneer Model #	② Wood Species	③ Top Wood Finish	④ Base Finish	⑤ Top Edge	⑥ Metal Color	⑦ Electrical		
Veneer (NAV)	<b>Flat Cut</b> CH1 Cherry MA1 Maple WA1 Walnut	Cherry: BRL Barley BBM Bourbon Medium BRM Brighton Medium CLA Classic CLL Collectors* EAR Earthy HRV Harvest* LGC Legacy PRL Praline* SAF Saffron Finishes with an asterisk (*) have a coordinating laminate available	Maple: ALM Ale Medium BUT Butterscotch CIN Cinnamon FLX Flax VEN Venetian	Walnut: AUB Auburn ESP Espresso MCH Mocha* NTO Night Owl* SIE Sienna* TOF Toffee TRF Truffle*	V - Same as Top Finish  P - Paint Color: BKD Backdrop BFX Black Fox BWH Bright White CGP Cargo Pants CHT Chatroom FRR French Roast GRV Greek Villa NET Network Gray NWH Nonchalant White STM Storm TRC Tricorn Black	Edge Selection: R3 Eased E1 Reverse Bevel	Color: ASL Arctic Silver BWH Bright White MBK Matte Black PEW Pewter SNK Soft Nickel RML Raw (Clear) CHR Chrome* *Upcharge applies	Cutout Codes: N all tables C1M 96" - 120" wide C1C 96" - 120" wide C1O 120" wide C2M 96" - 120" wide C2C 96" - 120" wide C3M 120" wide C3C 120" wide C3MOM 120" wide See chart on page 45 for cutout codes and power and storage unit configurations
		<b>Double Cut</b> DC1 Double Cut	<b>③ Top Wood Finish</b> Double Cut: COF Coffee FOS Fossil KHK Khaki CRM Cremello GRH Graphite STU Studio Teak					

① Specialty Top Model #	② Top Surface Selection	③ Base Wood Species	④a Base Wood Finish	④b Base Paint	⑤ Metal Color	⑥ Electrical
Solid Surface (NAV)	Patterns: ARM Armadillo PEB Pebble Pearl BLP Black Pearl PUR Pure White	<b>Flat Cut</b> CH1 Cherry MA1 Maple WA1 Walnut  <b>Double Cut</b> DC1 Double Cut	See list above for Cherry, Maple and Walnut Finishes  See list above for Double Cut Finishes	See list above for Paint Finishes	See list above for Metal Paint Colors	Cutout Codes: N all tables C1M 96" - 120" wide C1C 96" - 120" wide C1O 120" wide C2M 96" - 120" wide C2C 96" - 120" wide C3M 120" wide C3C 120" wide C3MOM 120" wide
Glass Surface (NAV)	Backpainted Glass: G White Glossy M White Matte					
Sub-Top w/Base (NAV)	B (Table Ships with Sub-Top, Customer applies custom Top)					

Description

Boat Shape 2pc Table with 3 Box Bases

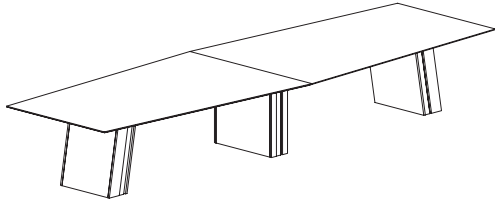

Laminate Tops "NAT" Models

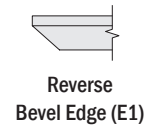
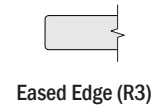

Features:

- three box bases with structural support rails
- two-piece top
- narrow ends of table are 48" d
- glass top has additional seams

D	W	H	CTN WT	CU FT	① Model	HPL	HPL
60	240	29 3/8	698	169	NAT60240-30BTBB	\$15,694	\$16,175
60	216	29 3/8	647	144	NAT60216-30BTBB	\$14,135	\$14,616
60	192	29 3/8	592	133	NAT60192-30BTBB	\$13,148	\$13,629

Options:

- metal base frame available in powder coat, no upcharge, or chrome, add \$2,923 list upcharge for 60" wide
- worksurface power & storage available, specify cutout code and order power units separately, see pages 150-151

NATIVE

Description

Boat Shape 2pc Table with 2 Box Bases

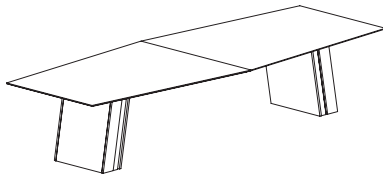

Laminate Tops "NAT" Models

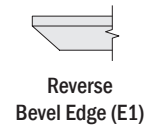
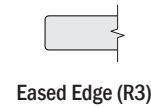

Features:

- two box bases with structural support rails
- two-piece top
- narrow ends of table are 42" d
- glass top has additional seams

D	W	H	CTN WT	CU FT	① Model	HPL	HPL
54	168	29 3/8	448	96	NAT54168-30BTBB	\$8,912	\$9,393
54	144	29 3/8	371	92	NAT54144-30BTBB	\$8,074	\$8,555
54	132	29 3/8	371	80	NAT54132-30BTBB	\$7,745	\$8,226

Options:

- metal base frame available in powder coat, no upcharge, or chrome, add \$2,249 list upcharge for 54" wide
- worksurface power & storage available, specify cutout code and order power units separately, see pages 150-151

To Order, Specify:

① Laminate Model #	②a Top Laminate / ②b Base Laminate	③ Top Edge	④ Metal Color	⑤ Electrical
Laminate (NAT)	<p>Solid Patterns:</p> <p>ALB Alabaster BBL Bridal Bianco DWH Designer White SHD Shadow SLG Slate Grey</p> <p>Wood Grain Patterns:</p> <p>AGA Aged Ash    BGL Brighton Light    OAT Oatmeal Cookie ALL Ale Light    CLL Collectors    PIN Pinnacle Walnut BLO Blonde Echo    FLO Florence Walnut    STU Studio Teak BOL Bourbon Light    GRH Graphite    VIN Vintage BZW Brazilwood    HGL High Line    WLH Walnut Heights WEA Weathered Ash</p>	<p>Edge Selection:</p> <p>R3 Eased E1 Reverse Bevel</p>	<p>Color:</p> <p>ASL Arctic Silver BWH Bright White MBK Matte Black PEW Pewter SNK Soft Nickel RML Raw (Clear) CHR Chrome* *Upcharge applies</p>	<p>Cutout Codes:</p> <p>N all tables C1M 132" - 240" wide C1C 132" - 240" wide C1O 132" - 240" wide C2M 132" - 240" wide C2C 132" - 240" wide C3M 132" - 240" wide C3C 132" - 240" wide C3MOM 132" - 240" wide</p>

Description

Boat Shape 2pc Table with 3 Box Bases  
(continued)

						Veneer Tops "NAV" Models				Premier Tops "NAV" Models			
						Eased Edge (R3)		Reverse Bevel Edge (E1)		Solid Surface/Glass Reverse Bevel Edge		Wood Plank Ash	
D	W	H	CTN WT	CU FT	1 Model	Flat Cut	Double Cut	Flat Cut	Double Cut	Solid Surface	Glass	Wood Plank Ash	Sub-Top with Base
60	240	29 3/8	698	169	NAV60240-30BTBB	\$20,364	\$22,546	\$20,611	\$22,794	\$41,450	\$39,288	--	\$19,449
60	216	29 3/8	647	144	NAV60216-30BTBB	\$18,488	\$20,590	\$18,734	\$20,837	\$37,514	\$35,519	--	\$17,656
60	192	29 3/8	592	133	NAV60192-30BTBB	\$17,286	\$19,325	\$17,532	\$19,571	\$34,100	\$32,425	--	\$16,508

Description

Boat Shape 2pc Table with 2 Box Bases  
(continued)

						Veneer Tops "NAV" Models				Premier Tops "NAV" Models			
						Eased Edge (R3)		Reverse Bevel Edge (E1)		Solid Surface/Glass Reverse Bevel Edge		Wood Plank Ash	
D	W	H	CTN WT	CU FT	1 Model	Flat Cut	Double Cut	Flat Cut	Double Cut	Solid Surface	Glass	Wood Plank Ash	Sub-Top with Base
54	168	29 3/8	448	96	NAV54168-30BTBB	\$11,895	\$13,134	\$12,141	\$13,381	\$25,230	\$23,817	--	\$11,361
54	144	29 3/8	371	92	NAV54144-30BTBB	\$10,814	\$11,964	\$11,060	\$12,211	\$22,303	\$21,032	--	\$10,328
54	132	29 3/8	371	80	NAV54132-30BTBB	\$10,386	\$11,498	\$10,633	\$11,746	\$20,918	\$19,753	--	\$9,920

To Order, Specify:

1 Veneer Model #	2 Wood Species	3 Top Wood Finish	4 Base Finish	5 Top Edge	6 Metal Color	7 Electrical		
Veneer (NAV)	<b>Flat Cut</b> CH1 Cherry MA1 Maple WA1 Walnut	Cherry: BRL Barley BBM Bourbon Medium BRM Brighton Medium CLA Classic CLL Collectors* EAR Earthy HRV Harvest* LGC Legacy PRL Praline* SAF Saffron Finishes with an asterisk (*) have a coordinating laminate available	Maple: ALM Ale Medium BUT Butterscotch CIN Cinnamon FLX Flax VEN Venetian	Walnut: AUB Auburn ESP Espresso MCH Mocha* NTO Night Owl* SIE Sienna* TOF Toffee TRF Truffle*	V - Same as Top Finish  P - Paint Color: BKD Backdrop BFX Black Fox BWH Bright White CGP Cargo Pants CHT Chatroom FRR French Roast GRV Greek Villa NET Network Gray NWH Nonchalant White STM Storm TRC Tricorn Black	Edge Selection: R3 Eased E1 Reverse Bevel	Color: ASL Arctic Silver BWH Bright White MBK Matte Black PEW Pewter SNK Soft Nickel RML Raw (Clear) CHR Chrome* *Upcharge applies	Cutout Codes: N all tables C1M 132" - 240" wide C1C 132" - 240" wide C1O 132" - 240" wide C2M 132" - 240" wide C2C 132" - 240" wide C3M 132" - 240" wide C3C 132" - 240" wide C3MOM 132" - 240" wide See chart on page 45 for cutout codes and power and storage unit configurations
		<b>Double Cut</b> DC1 Double Cut	<b>3 Top Wood Finish</b> Double Cut: COF Coffee FOS Fossil KHK Khaki CRM Cremello GRH Graphite STU Studio Teak					

1 Specialty Top Model #	2 Top Surface Selection	3 Base Wood Species	4a Base Wood Finish	4b Base Paint	5 Metal Color	6 Electrical
Solid Surface (NAV)	Patterns: ARM Armadillo PEB Pebble Pearl BLP Black Pearl PUR Pure White	<b>Flat Cut</b> CH1 Cherry MA1 Maple WA1 Walnut  <b>Double Cut</b> DC1 Double Cut	See list above for Cherry, Maple and Walnut Finishes	See list above for Paint Finishes	See list above for Metal Paint Colors	Cutout Codes: N all tables C1M 132" - 240" wide C1C 132" - 240" wide C1O 132" - 240" wide C2M 132" - 240" wide C2C 132" - 240" wide C3M 132" - 240" wide C3C 132" - 240" wide C3MOM 132" - 240" wide
Glass Surface (NAV)	Backpainted Glass: G White Glossy M White Matte					
Sub-Top w/Base (NAV)	B (Table Ships with Sub-Top, Customer applies custom Top)					

Description

Boat Shape Table with Box Base

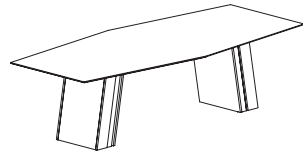

Laminate Tops "NAT" Models

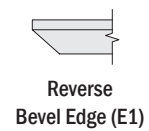
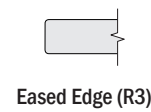

Features:

- two box bases with structural support rails
- one-piece top
- narrow ends of table are 36" d
- glass top has additional seams

D	W	H	CTN WT	CU FT	① Model	HPL	HPL
48	120	29 3/8	297	70	NAT48120-30BTBB	\$6,435	\$6,816
48	108	29 3/8	297	65	NAT48108-30BTBB	\$5,821	\$6,203
48	96	29 3/8	275	60	NAT4896-30BTBB	\$6,166	\$6,546

Options:

- metal base frame available in powder coat, no upcharge, or chrome, add \$1,966 list upcharge for 48" wide
- worksurface power & storage available, specify cutout code and order power units separately, see pages 150-151

NATIVE

To Order, Specify:

① Laminate Model #	②a Top Laminate / ②b Base Laminate	③ Top Edge	④ Metal Color	⑤ Electrical
Laminate (NAT)	<p>Solid Patterns:</p> <p>ALB Alabaster BBL Bridal Bianco DWH Designer White SHD Shadow SLG Slate Grey</p> <p>Wood Grain Patterns:</p> <p>AGA Aged Ash    BGL Brighton Light    OAT Oatmeal Cookie ALL Ale Light    CLL Collectors    PIN Pinnacle Walnut BLO Blonde Echo    FLO Florence Walnut    STU Studio Teak BOL Bourbon Light    GRH Graphite    VIN Vintage BZW Brazilwood    HGL High Line    WLH Walnut Heights WEA Weathered Ash</p>	<p>Edge Selection:</p> <p>R3 Eased E1 Reverse Bevel</p>	<p>Color:</p> <p>ASL Arctic Silver BWH Bright White MBK Matte Black PEW Pewter SNK Soft Nickel RML Raw (Clear) CHR Chrome* *Upcharge applies</p>	<p>Cutout Codes:</p> <p>N all tables C1M 96" - 120" wide C1C 96" - 120" wide C1O 120" wide C2M 96" - 120" wide C2C 96" - 120" wide C3M 120" wide C3C 120" wide C3MOM 120" wide</p>

Description

Boat Shape Table with Box Base  
(continued)

Veneer Tops "NAV" Models

Premier Tops "NAV" Models

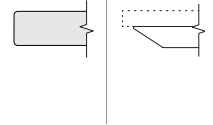
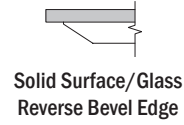
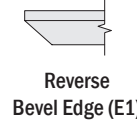
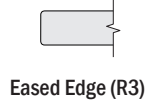

D	W	H	CTN WT	CU FT	① Model	Veneer Tops "NAV" Models		Premier Tops "NAV" Models					
						Flat Cut	Double Cut	Flat Cut	Double Cut	Solid Surface	Glass	Wood Plank Ash	Sub-Top with Base
48	120	29 3/8	297	70	NAV48120-30BTBB	\$9,099	\$10,111	\$9,247	\$10,257	\$17,722	\$16,668	--	\$8,689
48	108	29 3/8	297	65	NAV48108-30BTBB	\$8,232	\$9,146	\$8,379	\$9,293	\$16,034	\$15,045	--	\$7,862
48	96	29 3/8	275	60	NAV4896-30BTBB	\$8,718	\$9,686	\$8,866	\$9,834	\$15,639	\$14,775	--	\$8,327

NATIVE

To Order, Specify:

① Veneer Model #	② Wood Species	③ Top Wood Finish	④ Base Finish	⑤ Top Edge	⑥ Metal Color	⑦ Electrical		
Veneer (NAV)	<b>Flat Cut</b> CH1 Cherry MA1 Maple WA1 Walnut	Cherry: BRL Barley BBM Bourbon Medium BRM Brighton Medium CLA Classic CLL Collectors* EAR Earthy HRV Harvest* LGC Legacy PRL Praline* SAF Saffron Finishes with an asterisk (*) have a coordinating laminate available	Maple: ALM Ale Medium BUT Butterscotch CIN Cinnamon FLX Flax VEN Venetian	Walnut: AUB Auburn ESP Espresso MCH Mocha* NTO Night Owl* SIE Sienna* TOF Toffee TRF Truffle*	V - Same as Top Finish  P - Paint Color: BKD Backdrop BFX Black Fox BWH Bright White CGP Cargo Pants CHT Chatroom FRR French Roast GRV Greek Villa NET Network Gray NWH Nonchalant White STM Storm TRC Tricorn Black	Edge Selection: R3 Eased E1 Reverse Bevel	Color: ASL Arctic Silver BWH Bright White MBK Matte Black PEW Pewter SNK Soft Nickel RML Raw (Clear) CHR Chrome* *Upcharge applies	Cutout Codes: N all tables C1M 96" - 120" wide C1C 96" - 120" wide C1O 120" wide C2M 96" - 120" wide C2C 96" - 120" wide C3M 120" wide C3C 120" wide C3MOM 120" wide See chart on page 45 for cutout codes and power and storage unit configurations
		<b>Double Cut</b> DC1 Double Cut	<b>③ Top Wood Finish</b> Double Cut: COF Coffee FOS Fossil KHK Khaki CRM Cremello GRH Graphite STU Studio Teak					

① Specialty Top Model #	② Top Surface Selection	③ Base Wood Species	④a Base Wood Finish	④b Base Paint	⑤ Metal Color	⑥ Electrical
Solid Surface (NAV)	Patterns: ARM Armadillo PEB Pebble Pearl BLP Black Pearl PUR Pure White	<b>Flat Cut</b> CH1 Cherry MA1 Maple WA1 Walnut  <b>Double Cut</b> DC1 Double Cut	See list above for Cherry, Maple and Walnut Finishes  See list above for Double Cut Finishes	See list above for Paint Finishes	See list above for Metal Paint Colors	Cutout Codes: N all tables C1M 96" - 120" wide C1C 96" - 120" wide C1O 120" wide C2M 96" - 120" wide C2C 96" - 120" wide C3M 120" wide C3C 120" wide C3MOM 120" wide
Glass Surface (NAV)	Backpainted Glass: G White Glossy M White Matte					
Sub-Top w/Base (NAV)	B (Table Ships with Sub-Top, Customer applies custom Top)					

Description

View 2pc Table with 3 Box Bases

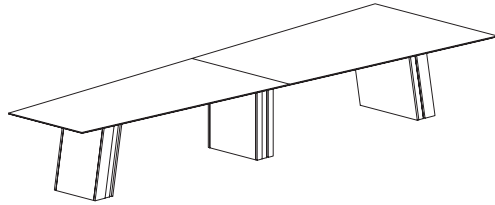

Laminate Tops "NAT" Models

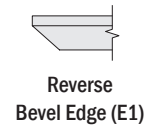
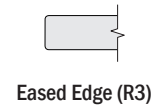

Features:

- three box bases with structural support rails
- two-piece top
- narrow end of table is 36"d
- glass top has additional seams

D	W	H	CTN WT	CU FT	① Model	HPL	HPL
60	240	29 3/8	643	90	NAT60240-30VTBB	\$16,373	\$16,854
60	216	29 3/8	597	84	NAT60216-30VTBB	\$14,755	\$15,236
60	192	29 3/8	547	133	NAT60192-30VTBB	\$13,757	\$14,238

Options:

- metal base frame available in powder coat, no upcharge, or chrome, add \$2,923 list upcharge for 60" wide
- worksurface power & storage available, specify cutout code and order power units separately, see pages 150-151

Description

View 2pc Table with 2 Box Bases

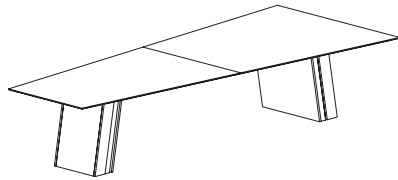

Laminate Tops "NAT" Models

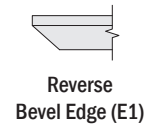
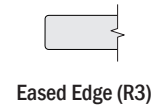

Features:

- two box bases with structural support rails
- two-piece top
- narrow end of table is 36"d
- glass top has additional seams

D	W	H	CTN WT	CU FT	① Model	HPL	HPL
60	168	29 3/8	449	74	NAT60168-30VTBB	\$10,423	\$10,904
60	144	29 3/8	399	95	NAT60144-30VTBB	\$8,406	\$8,887
60	132	29 3/8	371	63	NAT60132-30VTBB	\$8,003	\$8,484

Options:

- metal base frame available in powder coat, no upcharge, or chrome, add \$2,249 list upcharge for 60" wide
- worksurface power & storage available, specify cutout code and order order power units separately, see pages 150-151

To Order, Specify:

① Laminate Model #	②a Top Laminate / ②b Base Laminate	③ Top Edge	④ Metal Color	⑤ Electrical
Laminate (NAT)	<p>Solid Patterns:</p> <p>ALB Alabaster BBL Bridal Bianco DWH Designer White SHD Shadow SLG Slate Grey</p> <p>Wood Grain Patterns:</p> <p>AGA Aged Ash ALL Ale Light BLO Blonde Echo BOL Bourbon Light BZW Brazilwood</p> <p>BGL Brighton Light CLL Collectors FLO Florence Walnut GRH Graphite HGL High Line</p> <p>OAT Oatmeal Cookie PIN Pinnacle Walnut STU Studio Teak VIN Vintage WLH Walnut Heights WEA Weathered Ash</p>	<p>Edge Selection:</p> <p>R3 Eased E1 Reverse Bevel</p>	<p>Color:</p> <p>ASL Arctic Silver BWH Bright White MBK Matte Black PEW Pewter SNK Soft Nickel RML Raw (Clear) CHR Chrome* *Upcharge applies</p>	<p>Cutout Codes:</p> <p>N all tables C1M 132" - 240" wide C1C 132" - 240" wide C1O 132" - 240" wide C2M 132" - 240" wide C2C 132" - 240" wide C3M 132" - 240" wide C3C 132" - 240" wide C3MOM 132" - 240" wide</p>

Description

View 2pc Table with 3 Box Bases  
(continued)

						Veneer Tops "NAV" Models				Premier Tops "NAV" Models			
						Eased Edge (R3)		Reverse Bevel Edge (E1)		Solid Surface/Glass Reverse Bevel Edge		Wood Plank Ash	
D	W	H	CTN WT	CU FT	① Model	Flat Cut	Double Cut	Flat Cut	Double Cut	Solid Surface	Glass	Wood Plank Ash	Sub-Top with Base
60	240	29 3/8	643	90	NAV60240-30VTBB	\$21,246	\$23,524	\$21,493	\$23,770	\$42,332	\$40,169	--	\$20,291
60	216	29 3/8	597	84	NAV60216-30VTBB	\$19,299	\$21,492	\$19,545	\$21,739	\$38,324	\$36,329	--	\$18,430
60	192	29 3/8	547	133	NAV60192-30VTBB	\$18,087	\$20,221	\$18,334	\$20,467	\$34,902	\$33,226	--	\$17,274

Description

View 2pc Table with 2 Box Bases  
(continued)

						Veneer Tops "NAV" Models				Premier Tops "NAV" Models			
						Eased Edge (R3)		Reverse Bevel Edge (E1)		Solid Surface/Glass Reverse Bevel Edge		Wood Plank Ash	
D	W	H	CTN WT	CU FT	① Model	Flat Cut	Double Cut	Flat Cut	Double Cut	Solid Surface	Glass	Wood Plank Ash	Sub-Top with Base
60	168	29 3/8	449	74	NAV60168-30VTBB	\$13,781	\$15,470	\$14,028	\$15,716	\$28,546	\$27,027	--	\$13,163
60	144	29 3/8	399	95	NAV60144-30VTBB	\$11,341	\$12,916	\$11,588	\$13,164	\$24,059	\$22,695	--	\$10,831
60	132	29 3/8	371	63	NAV60132-30VTBB	\$10,669	\$12,049	\$10,916	\$12,295	\$22,326	\$21,076	--	\$10,189

To Order, Specify:

① Veneer Model #	② Wood Species	③ Top Wood Finish	④ Base Finish	⑤ Top Edge	⑥ Metal Color	⑦ Electrical		
Veneer (NAV)	<b>Flat Cut</b> CH1 Cherry MA1 Maple WA1 Walnut	Cherry: BRL Barley BBM Bourbon Medium BRM Brighton Medium CLA Classic CLL Collectors* EAR Earthy HRV Harvest* LGC Legacy PRL Praline* SAF Saffron	Maple: ALM Ale Medium BUT Butterscotch CIN Cinnamon FLX Flax VEN Venetian	Walnut: AUB Auburn ESP Espresso MCH Mocha* NTO Night Owl* SIE Sienna* TOF Toffee TRF Truffle*	V - Same as Top Finish  P - Paint Color: BKD Backdrop BFX Black Fox BWH Bright White CGP Cargo Pants CHT Chatroom FRR French Roast GRV Greek Villa NET Network Gray NWH Nonchalant White STM Storm TRC Tricorn Black	Edge Selection: R3 Eased E1 Reverse Bevel	Color: ASL Arctic Silver BWH Bright White MBK Matte Black PEW Pewter SNK Soft Nickel RML Raw (Clear) CHR Chrome* *Upcharge applies	Cutout Codes: N all tables C1M 132" - 240" wide C1C 132" - 240" wide C1O 132" - 240" wide C2M 132" - 240" wide C2C 132" - 240" wide C3M 132" - 240" wide C3C 132" - 240" wide C3MOM 132" - 240" wide  See chart on page 45 for cutout codes and power and storage unit configurations
		<b>Double Cut</b> DC1 Double Cut	<b>③ Top Wood Finish</b> Double Cut: COF Coffee FOS Fossil KHK Khaki CRM Cremello GRH Graphite STU Studio Teak					

① Specialty Top Model #	② Top Surface Selection	③ Base Wood Species	④a Base Wood Finish	④b Base Paint	⑤ Metal Color	⑥ Electrical
Solid Surface (NAV)	Patterns: ARM Armadillo PEB Pebble Pearl BLP Black Pearl PUR Pure White	<b>Flat Cut</b> CH1 Cherry MA1 Maple WA1 Walnut  <b>Double Cut</b> DC1 Double Cut	See list above for Cherry, Maple and Walnut Finishes  See list above for Double Cut Finishes	See list above for Paint Finishes	See list above for Metal Paint Colors	Cutout Codes: N all tables C1M 132" - 240" wide C1C 132" - 240" wide C1O 132" - 240" wide C2M 132" - 240" wide C2C 132" - 240" wide C3M 132" - 240" wide C3C 132" - 240" wide C3MOM 132" - 240" wide
Glass Surface (NAV)	Backpainted Glass: G White Glossy M White Matte					
Sub-Top w/Base (NAV)	B (Table Ships with Sub-Top, Customer applies custom Top)					



Description

View Table with Box Base

Laminate Tops "NAT" Models

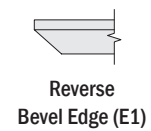
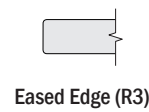
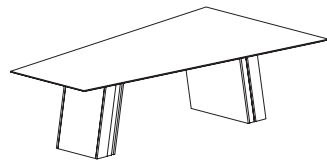

Features:

- two box bases with structural support rails
- one-piece top
- narrow end of table is 36"d
- glass top has additional seams

D	W	H	CTN WT	CU FT	1 Model	HPL	HPL
60	120	29 3/8	349	70	NAT60120-30VTBB	\$7,119	\$7,500
60	108	29 3/8	331	66	NAT60108-30VTBB	\$6,965	\$7,345
54	96	29 3/8	297	63	NAT5496-30VTBB	\$6,429	\$6,811

Options:

- metal base frame available in powder coat, no upcharge, or chrome, add list upcharge: for 54" & 60" wide - \$2,249
- worksurface power & storage available, specify cutout code and order power units separately, see pages 150-151



NATIVE

To Order, Specify:

1 Laminate Model #	2a Top Laminate / 2b Base Laminate	3 Top Edge	4 Metal Color	5 Electrical
Laminate (NAT)	<p>Solid Patterns:</p> <p>ALB Alabaster BBL Bridal Bianco DWH Designer White SHD Shadow SLG Slate Grey</p> <p>Wood Grain Patterns:</p> <p>AGA Aged Ash    BGL Brighton Light    OAT Oatmeal Cookie ALL Ale Light    CLL Collectors    PIN Pinnacle Walnut BLO Blonde Echo    FLO Florence Walnut    STU Studio Teak BOL Bourbon Light    GRH Graphite    VIN Vintage BZW Brazilwood    HGL High Line    WLH Walnut Heights WEA Weathered Ash</p>	<p>Edge Selection:</p> <p>R3 Eased E1 Reverse Bevel</p>	<p>Color:</p> <p>ASL Arctic Silver BWH Bright White MBK Matte Black PEW Pewter SNK Soft Nickel RML Raw (Clear) CHR Chrome* *Upcharge applies</p>	<p>Cutout Codes:</p> <p>N all tables C1M 96" - 120" wide C1C 96" - 120" wide C1O 120" wide C2M 96" - 120" wide C2C 96" - 120" wide C3M 120" wide C3C 120" wide C3MOM 120" wide</p>

Description

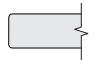
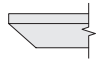
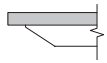
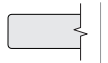
View Table with Box Base  
(continued)

						Veneer Tops "NAV" Models				Premier Tops "NAV" Models					
						 Eased Edge (R3)		 Reverse Bevel Edge (E1)		 Solid Surface/Glass Reverse Bevel Edge					
D	W	H	CTN WT	CU FT	1 Model	Flat Cut	Double Cut	Flat Cut	Double Cut	Solid Surface	Glass	Wood Plank Ash	Sub-Top with Base		
60	120	29 3/8	349	70	NAV60120-30VTBB	\$10,066	\$11,465	\$10,214	\$11,612	\$20,734	\$19,527	--	\$9,614		
60	108	29 3/8	331	66	NAV60108-30VTBB	\$9,776	\$11,077	\$9,924	\$11,224	\$19,381	\$18,293	--	\$9,338		
54	96	29 3/8	297	63	NAV5496-30VTBB	\$9,044	\$10,021	\$9,192	\$10,168	\$16,779	\$15,858	--	\$8,639		

NATIVE

To Order, Specify:

1 Veneer Model #	2 Wood Species	3 Top Wood Finish	4 Base Finish	5 Top Edge	6 Metal Color	7 Electrical		
Veneer (NAV)	Flat Cut CH1 Cherry MA1 Maple WA1 Walnut	Cherry: BRL Barley BBM Bourbon Medium BRM Brighton Medium CLA Classic CLL Collectors* EAR Earthy HRV Harvest* LGC Legacy PRL Praline* SAF Saffron Finishes with an asterisk (*) have a coordinating laminate available	Maple: ALM Ale Medium BUT Butterscotch CIN Cinnamon FLX Flax VEN Venetian	Walnut: AUB Auburn ESP Espresso MCH Mocha* NTO Night Owl* SIE Sienna* TOF Toffee TRF Truffle*	V - Same as Top Finish  P - Paint Color: BKD Backdrop BFX Black Fox BWH Bright White CGP Cargo Pants CHT Chatroom FRR French Roast GRV Greek Villa NET Network Gray NWH Nonchalant White STM Storm TRC Tricorn Black	Edge Selection: R3 Eased E1 Reverse Bevel	Color: ASL Arctic Silver BWH Bright White MBK Matte Black PEW Pewter SNK Soft Nickel RML Raw (Clear) CHR Chrome* *Upcharge applies	Cutout Codes: N all tables C1M 96" - 120" wide C1C 96" - 120" wide C1O 120" wide C2M 96" - 120" wide C2C 96" - 120" wide C3M 120" wide C3C 120" wide C3MOM 120" wide See chart on page 45 for cutout codes and power and storage unit configurations
		Double Cut DC1 Double Cut	3 Top Wood Finish Double Cut: COF Coffee FOS Fossil KHK Khaki CRM Cremello GRH Graphite STU Studio Teak					

1 Specialty Top Model #	2 Top Surface Selection	3 Base Wood Species	4a Base Wood Finish	4b Base Paint	5 Metal Color	6 Electrical
Solid Surface (NAV)	Patterns: ARM Armadillo PEB Pebble Pearl BLP Black Pearl PUR Pure White	Flat Cut CH1 Cherry MA1 Maple WA1 Walnut  Double Cut DC1 Double Cut	See list above for Cherry, Maple and Walnut Finishes	See list above for Paint Finishes	See list above for Metal Paint Colors	Cutout Codes: N all tables C1M 96" - 120" wide C1C 96" - 120" wide C1O 120" wide C2M 96" - 120" wide C2C 96" - 120" wide C3M 120" wide C3C 120" wide C3MOM 120" wide
Glass Surface (NAV)	Backpainted Glass: G White Glossy M White Matte					
Sub-Top w/Base (NAV)	B (Table Ships with Sub-Top, Customer applies custom Top)					

Description

Rectangular Table with Height Adjustable Base

Laminate Tops "NAT" Models

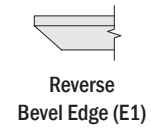
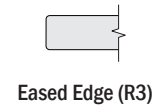
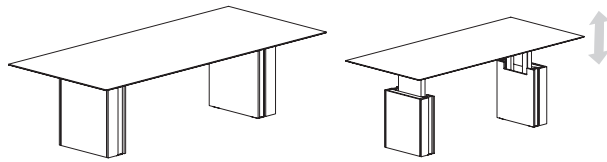

Features:

- height adjustable bases with structural support rails
- 30" to 40" height adjustment with digital controller; 10' power cord
- maximum weight rating 300lbs (evenly distributed load)
- one-piece top

Options:

- metal base frame available in powder coat, no upcharge, or chrome, add list upcharge: for 36" wide - \$1,982, 42" & 48" wide -\$2,249, for 54" wide -\$2,530
- worksurface power & storage available, specify cutout code and order power units separately, see pages 150-151

D	W	H	CTN WT	CU FT	1 Model	HPL	HPL
54	120	Adj.	428	89	NAT54120-30TTAH	\$10,841	\$11,221
48	120	Adj.	387	81	NAT48120-30TTAH	\$10,401	\$10,783
48	108	Adj.	373	71	NAT48108-30TTAH	\$9,999	\$10,380
48	96	Adj.	346	65	NAT4896-30TTAH	\$9,909	\$10,290
48	84	Adj.	318	61	NAT4884-30TTAH	\$9,696	\$10,077
48	72	Adj.	232	56	NAT4872-30TTAH	\$9,510	\$9,891
42	120	Adj.	366	77	NAT42120-30TTAH	\$10,314	\$10,696
42	108	Adj.	349	69	NAT42108-30TTAH	\$9,836	\$10,218
42	96	Adj.	326	64	NAT4296-30TTAH	\$9,766	\$10,147
42	84	Adj.	301	50	NAT4284-30TTAH	\$9,570	\$9,951
42	72	Adj.	278	47	NAT4272-30TTAH	\$9,417	\$9,799
36	84	Adj.	268	47	NAT3684-30TTAH	\$9,422	\$9,803
36	72	Adj.	249	43	NAT3672-30TTAH	\$9,324	\$9,705

NATIVE

To Order, Specify:

1 Laminate Model #	2a Top Laminate / 2b Base Laminate	3 Top Edge	4 Metal Color	5 Electrical
Laminate (NAT)	Solid Patterns: ALB Alabaster BBL Bridal Bianco DWH Designer White SHD Shadow SLG Slate Grey  Wood Grain Patterns: AGA Aged Ash ALL Ale Light BLO Blonde Echo BOL Bourbon Light BZW Brazilwood BGL Brighton Light CLL Collectors FLO Florence Walnut GRH Graphite HGL High Line OAT Oatmeal Cookie PIN Pinnacle Walnut STU Studio Teak VIN Vintage WLH Walnut Heights WEA Weathered Ash	Edge Selection: R3 Eased E1 Reverse Bevel	Color: ASL Arctic Silver BWH Bright White MBK Matte Black PEW Pewter SNK Soft Nickel RML Raw (Clear) CHR Chrome* *Upcharge applies	Cutout Codes: N all tables C1M 72" - 120" wide C1C 72" - 120" wide C1O 120" wide C2M 96" - 120" wide C2C 96" - 120" wide C3M 120" wide C3C 120" wide C3MOM 120" wide

Description

Rectangular Table with Height Adjustable Base  
(continued)

Veneer Tops "NAV" Models

Premier Tops "NAV" Models



Eased Edge (R3)



Reverse Bevel Edge (E1)

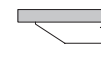

Solid Surface/Glass Reverse Bevel Edge



Wood Plank Ash

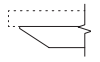

Sub-Top with Base

D	W	H	CTN WT	CU FT	① Model	Veneer Tops "NAV" Models		Veneer Tops "NAV" Models		Premier Tops "NAV" Models		Wood Plank Ash	Sub-Top with Base
						Flat Cut	Double Cut	Flat Cut	Double Cut	Solid Surface	Glass		
54	120	Adj.	428	89	NAV54120-30TTAH	\$14,469	\$15,374	\$14,616	\$15,521	\$24,115	--	--	\$13,818
48	120	Adj.	387	81	NAV48120-30TTAH	\$13,944	\$14,841	\$14,092	\$14,989	\$22,568	--	\$19,324	\$13,319
48	108	Adj.	373	71	NAV48108-30TTAH	\$13,406	\$14,268	\$13,554	\$14,416	\$21,208	--	\$18,247	\$12,805
48	96	Adj.	346	65	NAV4896-30TTAH	\$13,288	\$14,142	\$13,435	\$14,289	\$20,207	--	\$17,591	\$12,690
48	84	Adj.	318	61	NAV4884-30TTAH	\$13,000	\$13,837	\$13,147	\$13,983	\$19,103	--	\$16,766	\$12,416
48	72	Adj.	232	56	NAV4872-30TTAH	\$12,751	\$13,571	\$12,898	\$13,719	\$18,038	--	\$15,978	\$12,178
42	120	Adj.	366	77	NAV42120-30TTAH	\$13,830	\$14,719	\$13,977	\$14,867	\$21,377	--	\$18,536	\$13,208
42	108	Adj.	349	69	NAV42108-30TTAH	\$13,190	\$14,039	\$13,337	\$14,186	\$20,018	--	\$17,427	\$12,597
42	96	Adj.	326	64	NAV4296-30TTAH	\$13,095	\$13,937	\$13,242	\$14,084	\$19,200	--	\$16,860	\$12,506
42	84	Adj.	301	50	NAV4284-30TTAH	\$12,831	\$13,656	\$12,978	\$13,804	\$18,220	--	\$16,126	\$12,253
42	72	Adj.	278	47	NAV4272-30TTAH	\$12,629	\$13,441	\$12,777	\$13,589	\$17,304	--	\$15,452	\$12,060
36	84	Adj.	268	47	NAV3684-30TTAH	\$12,632	\$13,445	\$12,780	\$13,592	\$17,309	--	\$15,456	\$12,063
36	72	Adj.	249	43	NAV3672-30TTAH	\$12,502	\$13,306	\$12,650	\$13,454	\$16,565	--	\$14,923	\$11,940

NATIVE

To Order, Specify:

① Veneer Model #	② Wood Species	③ Top Wood Finish	④ Base Finish	⑤ Top Edge	⑥ Metal Color	⑦ Electrical		
Veneer (NAV)	<b>Flat Cut</b> CH1 Cherry MA1 Maple WA1 Walnut	Cherry: BRL Barley BBM Bourbon Medium BRM Brighton Medium CLA Classic CLL Collectors* EAR Earthy HRV Harvest* LGC Legacy PRL Praline* SAF Saffron Finishes with an asterisk (*) have a coordinating laminate available	Maple: ALM Ale Medium BUT Butterscotch CIN Cinnamon FLX Flax VEN Venetian	Walnut: AUB Auburn ESP Espresso MCH Mocha* NTO Night Owl* SIE Sienna* TOF Toffee TRF Truffle*	V - Same as Top Finish  P - Paint Color: BKD Backdrop BFX Black Fox BWH Bright White CGP Cargo Pants CHT Chatroom FRR French Roast GRV Greek Villa NET Network Gray NWH Nonchalant White STM Storm TRC Tricorn Black	Edge Selection: R3 Eased E1 Reverse Bevel	Color: ASL Arctic Silver BWH Bright White MBK Matte Black PEW Pewter SNK Soft Nickel RML Raw (Clear) CHR Chrome* *Upcharge applies	Cutout Codes: N all tables C1M 72" - 120" wide C1C 72" - 120" wide C1O 120" wide C2M 96" - 120" wide C2C 96" - 120" wide C3M 120" wide C3C 120" wide C3MOM 120" wide See chart on page 45 for cutout codes and power and storage unit configurations
		<b>Double Cut</b> DC1 Double Cut	<b>③ Top Wood Finish</b> Double Cut: COF Coffee FOS Fossil KHK Khaki CRM Cremello GRH Graphite STU Studio Teak					

① Specialty Top Model #	② Top Surface Selection	③ Base Wood Species	④a Base Wood Finish	④b Base Paint	⑤ Metal Color	⑥ Electrical
Solid Surface (NAV)	Patterns: ARM Armadillo PEB Pebble Pearl BLP Black Pearl PUR Pure White	<b>Flat Cut</b> CH1 Cherry MA1 Maple WA1 Walnut  <b>Double Cut</b> DC1 Double Cut	See list above for Cherry, Maple and Walnut Finishes	See list above for Paint Finishes	See list above for Metal Paint Colors	Cutout Codes: N all tables C1M 72" - 120" wide C1C 72" - 120" wide C1O 120" wide C2M 96" - 120" wide C2C 96" - 120" wide C3M 120" wide C3C 120" wide C3MOM 120" wide
Glass Surface (NAV)	Backpainted Glass: G White Glossy M White Matte					
Sub-Top w/Base (NAV)	B (Table Ships with Sub-Top, Customer applies custom Top)					

Description

Arc End Table with Height Adjustable Base

Laminate Tops "NAT" Models

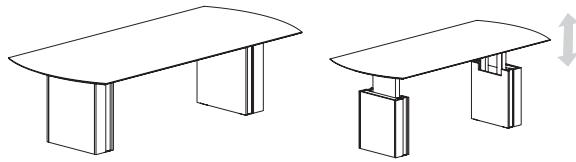

NATIVE

Features:

- height adjustable bases with structural support rails
- 30" to 40" height adjustment with digital controller; 10' power cord
- maximum weight rating 300lbs (evenly distributed load)
- one-piece top

Options:

- metal base frame available in powder coat, no upcharge, or chrome, add list upcharge: for 36" wide - \$1,982, 42" & 48" wide - \$2,249, for 54" wide - \$2,530
- worksurface power & storage available, specify cutout code and order power units separately, see pages 150-151

D	W	H	CTN WT	CU FT	① Model	HPL	HPL
54	120	Adj.	352	89	NAT54120-30ARAH	\$10,841	\$11,221
48	120	Adj.	381	81	NAT48120-30ARAH	\$10,401	\$10,783
48	108	Adj.	367	71	NAT48108-30ARAH	\$9,999	\$10,380
48	96	Adj.	385	65	NAT4896-30ARAH	\$9,909	\$10,290
48	84	Adj.	313	61	NAT4884-30ARAH	\$9,696	\$10,077
48	72	Adj.	292	56	NAT4872-30ARAH	\$9,510	\$9,891
42	120	Adj.	358	77	NAT42120-30ARAH	\$10,314	\$10,696
42	108	Adj.	353	69	NAT42108-30ARAH	\$9,836	\$10,218
42	96	Adj.	319	64	NAT4296-30ARAH	\$9,766	\$10,147
42	84	Adj.	312	50	NAT4284-30ARAH	\$8,199	\$8,581
42	72	Adj.	278	47	NAT4272-30ARAH	\$9,465	\$9,847
36	84	Adj.	264	47	NAT3684-30ARAH	\$9,422	\$9,803
36	72	Adj.	156	43	NAT3672-30ARAH	\$9,324	\$9,705

To Order, Specify:

① Laminate Model #	②a Top Laminate / ②b Base Laminate	③ Top Edge	④ Metal Color	⑤ Electrical
Laminate (NAT)	<p>Solid Patterns:</p> <p>ALB Alabaster BBL Bridal Bianco DWH Designer White SHD Shadow SLG Slate Grey</p> <p>Wood Grain Patterns:</p> <p>AGA Aged Ash ALL Ale Light BLO Blonde Echo BOL Bourbon Light BZW Brazilwood</p> <p>BGL Brighton Light CLL Collectors FLO Florence Walnut GRH Graphite HGL High Line</p> <p>OAT Oatmeal Cookie PIN Pinnacle Walnut STU Studio Teak VIN Vintage WLH Walnut Heights WEA Weathered Ash</p>	<p>Edge Selection:</p> <p>R3 Eased E1 Reverse Bevel</p>	<p>Color:</p> <p>ASL Arctic Silver BWH Bright White MBK Matte Black PEW Pewter SNK Soft Nickel RML Raw (Clear) CHR Chrome* *Upcharge applies</p>	<p>Cutout Codes:</p> <p>N all tables C1M 72" - 120" wide C1C 72" - 120" wide C1O 120" wide C2M 96" - 120" wide C2C 96" - 120" wide C3M 120" wide C3C 120" wide C3MOM 120" wide</p>

Description

Arc End Table with Height Adjustable Base  
(continued)

						Veneer Tops "NAV" Models				Premier Tops "NAV" Models			
						Eased Edge (R3)		Reverse Bevel Edge (E1)		Solid Surface/Glass Reverse Bevel Edge			
D	W	H	CTN WT	CU FT	① Model	Flat Cut	Double Cut	Flat Cut	Double Cut	Solid Surface	Glass	Wood Plank Ash	Sub-Top with Base
54	120	Adj.	352	89	NAV54120-30ARAH	\$14,469	\$15,374	\$14,616	\$15,521	\$24,115	--	--	\$13,818
48	120	Adj.	381	81	NAV48120-30ARAH	\$13,944	\$14,841	\$14,092	\$14,989	\$22,568	--	--	\$13,319
48	108	Adj.	367	71	NAV48108-30ARAH	\$13,406	\$14,268	\$13,554	\$14,416	\$21,208	--	--	\$12,805
48	96	Adj.	385	65	NAV4896-30ARAH	\$13,288	\$14,142	\$13,435	\$14,289	\$20,207	--	--	\$12,690
48	84	Adj.	313	61	NAV4884-30ARAH	\$13,000	\$13,837	\$13,147	\$13,983	\$19,103	--	--	\$12,416
48	72	Adj.	292	56	NAV4872-30ARAH	\$12,751	\$13,571	\$12,898	\$13,719	\$18,038	--	--	\$12,178
42	120	Adj.	358	77	NAV42120-30ARAH	\$13,830	\$14,719	\$13,977	\$14,867	\$21,377	--	--	\$13,208
42	108	Adj.	353	69	NAV42108-30ARAH	\$13,190	\$14,039	\$13,337	\$14,186	\$20,018	--	--	\$12,597
42	96	Adj.	319	64	NAV4296-30ARAH	\$13,095	\$13,937	\$13,242	\$14,084	\$19,200	--	--	\$12,506
42	84	Adj.	312	50	NAV4284-30ARAH	\$12,894	\$13,693	\$13,012	\$13,841	\$18,253	--	--	\$12,286
42	72	Adj.	278	47	NAV4272-30ARAH	\$12,692	\$13,508	\$12,840	\$13,655	\$17,367	--	--	\$12,121
36	84	Adj.	264	47	NAV3684-30ARAH	\$12,632	\$13,445	\$12,780	\$13,592	\$17,309	--	--	\$12,063
36	72	Adj.	156	43	NAV3672-30ARAH	\$12,502	\$13,306	\$12,650	\$13,454	\$16,565	--	--	\$11,940

NATIVE

To Order, Specify:

① Veneer Model #	② Wood Species	③ Top Wood Finish	④ Base Finish	⑤ Top Edge	⑥ Metal Color	⑦ Electrical		
Veneer (NAV)	<b>Flat Cut</b> CH1 Cherry MA1 Maple WA1 Walnut	Cherry: BRL Barley BBM Bourbon Medium BRM Brighton Medium CLA Classic CLL Collectors* EAR Earthy HRV Harvest* LGC Legacy PRL Praline* SAF Saffron	Maple: ALM Ale Medium BUT Butterscotch CIN Cinnamon FLX Flax VEN Venetian	Walnut: AUB Auburn ESP Espresso MCH Mocha* NTO Night Owl* SIE Sienna* TOF Toffee TRF Truffle*	V - Same as Top Finish  P - Paint Color: BKD Backdrop BFX Black Fox BWH Bright White CGP Cargo Pants CHT Chatroom FRR French Roast GRV Greek Villa NET Network Gray NWH Nonchalant White STM Storm TRC Tricorn Black	Edge Selection: R3 Eased E1 Reverse Bevel	Color: ASL Arctic Silver BWH Bright White MBK Matte Black PEW Pewter SNK Soft Nickel RML Raw (Clear) CHR Chrome* *Upcharge applies	Cutout Codes: N all tables C1M 72" - 120" wide C1C 72" - 120" wide C1O 120" wide C2M 96" - 120" wide C2C 96" - 120" wide C3M 120" wide C3C 120" wide C3MOM 120" wide See chart on page 45 for cutout codes and power and storage unit configurations
		<b>Double Cut</b> DC1 Double Cut	<b>③ Top Wood Finish</b> Double Cut: COF Coffee FOS Fossil KHK Khaki CRM Cremello GRH Graphite STU Studio Teak					

① Specialty Top Model #	② Top Surface Selection	③ Base Wood Species	④a Base Wood Finish	④b Base Paint	⑤ Metal Color	⑥ Electrical
Solid Surface (NAV)	Patterns: ARM Armadillo PEB Pebble Pearl BLP Black Pearl PUR Pure White	<b>Flat Cut</b> CH1 Cherry MA1 Maple WA1 Walnut  <b>Double Cut</b> DC1 Double Cut	See list above for Cherry, Maple and Walnut Finishes	See list above for Paint Finishes	See list above for Metal Paint Colors	Cutout Codes: N all tables C1M 72" - 120" wide C1C 72" - 120" wide C1O 120" wide C2M 96" - 120" wide C2C 96" - 120" wide C3M 120" wide C3C 120" wide C3MOM 120" wide
Glass Surface (NAV)	Backpainted Glass: G White Glossy M White Matte					
Sub-Top w/Base (NAV)	B (Table Ships with Sub-Top, Customer applies custom Top)					

Description

Boat Shape Table with Height Adjustable Base

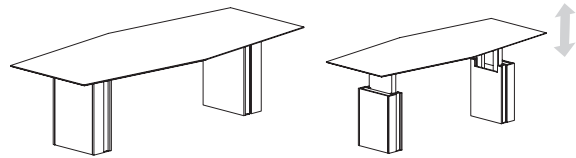

Laminate Tops "NAT" Models

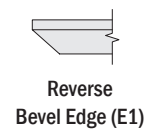
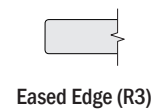

Features:

- height adjustable bases with structural support rails
- 30" to 40" height adjustment with digital controller; 10' power cord
- maximum weight rating 300lbs (evenly distributed load)
- one-piece top
- narrow ends of table are 36"d

Options:

- metal base frame available in powder coat, no upcharge, or chrome, add \$2,249 list upcharge for 42" & 48" wide
- worksurface power & storage available, specify cutout code and order power units separately, see pages 150-151

D	W	H	CTN WT	CU FT	① Model	HPL	HPL
48	120	Adj.	346	73	NAT48120-30BTAH	\$10,304	\$10,683
48	108	Adj.	335	71	NAT48108-30BTAH	\$10,222	\$10,604
48	96	Adj.	369	61	NAT4896-30BTAH	\$9,729	\$10,110
48	84	Adj.	313	59	NAT4884-30BTAH	\$9,520	\$9,902
42	72	Adj.	278	49	NAT4272-30BTAH	\$8,042	\$8,424

NATIVE

To Order, Specify:

① Laminate Model #	②a Top Laminate / ②b Base Laminate	③ Top Edge	④ Metal Color	⑤ Electrical
Laminate (NAT)	Solid Patterns: ALB Alabaster BBL Bridal Blanco DWH Designer White SHD Shadow SLG Slate Grey  Wood Grain Patterns: AGA Aged Ash ALL Ale Light BLO Blonde Echo BOL Bourbon Light BZW Brazilwood BGL Brighton Light CLL Collectors FLO Florence Walnut GRH Graphite HGL High Line OAT Oatmeal Cookie PIN Pinnacle Walnut STU Studio Teak VIN Vintage WLH Walnut Heights WEA Weathered Ash	Edge Selection: R3 Eased E1 Reverse Bevel	Color: ASL Arctic Silver BWH Bright White MBK Matte Black PEW Pewter SNK Soft Nickel RML Raw (Clear) CHR Chrome* *Upcharge applies	Cutout Codes: N all tables C1M 72" - 120" wide C1C 72" - 120" wide C1O 120" wide C2M 96" - 120" wide C2C 96" - 120" wide C3M 120" wide C3C 120" wide C3MOM 120" wide

Description

Boat Shape Table with Height Adjustable Base  
(continued)

Veneer Tops "NAV" Models

Premier Tops "NAV" Models



Eased Edge (R3)



Reverse Bevel Edge (E1)

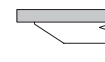

Solid Surface/Glass Reverse Bevel Edge

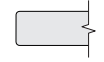

Wood Plank Ash

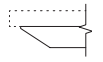

Sub-Top with Base

D	W	H	CTN WT	CU FT	① Model	Veneer Tops "NAV" Models		Veneer Tops "NAV" Models		Premier Tops "NAV" Models		Sub-Top with Base	
						Flat Cut	Double Cut	Flat Cut	Double Cut	Solid Surface	Glass		Wood Plank Ash
48	120	Adj.	346	73	NAV48120-30BTAH	\$13,814	\$14,703	\$13,961	\$14,849	\$22,437	--	--	\$13,193
48	108	Adj.	335	71	NAV48108-30BTAH	\$13,708	\$14,589	\$13,854	\$14,737	\$21,510	--	--	\$13,091
48	96	Adj.	369	61	NAV4896-30BTAH	\$13,045	\$13,882	\$13,192	\$14,030	\$19,964	--	--	\$12,458
48	84	Adj.	313	59	NAV4884-30BTAH	\$12,764	\$13,586	\$12,912	\$13,731	\$18,869	--	--	\$12,190
42	72	Adj.	278	49	NAV4272-30BTAH	\$10,784	\$11,477	\$10,930	\$11,624	\$15,457	--	--	\$10,298

NATIVE

To Order, Specify:

① Veneer Model #	② Wood Species	③ Top Wood Finish	④ Base Finish	⑤ Top Edge	⑥ Metal Color	⑦ Electrical		
Veneer (NAV)	<b>Flat Cut</b> CH1 Cherry MA1 Maple WA1 Walnut	Cherry: BRL Barley BBM Bourbon Medium BRM Brighton Medium CLA Classic CLL Collectors* EAR Earthy HRV Harvest* LGC Legacy PRL Praline* SAF Saffron Finishes with an asterisk (*) have a coordinating laminate available	Maple: ALM Ale Medium BUT Butterscotch CIN Cinnamon FLX Flax VEN Venetian	Walnut: AUB Auburn ESP Espresso MCH Mocha* NTO Night Owl* SIE Sienna* TOF Toffee TRF Truffle*	V - Same as Top Finish  P - Paint Color: BKD Backdrop BFX Black Fox BWH Bright White CGP Cargo Pants CHT Chatroom FRR French Roast GRV Greek Villa NET Network Gray NWH Nonchalant White STM Storm TRC Tricorn Black	Edge Selection: R3 Eased E1 Reverse Bevel	Color: ASL Arctic Silver BWH Bright White MBK Matte Black PEW Pewter SNK Soft Nickel RML Raw (Clear) CHR Chrome* *Upcharge applies	Cutout Codes: N all tables C1M 72" - 120" wide C1C 72" - 120" wide C1O 120" wide C2M 96" - 120" wide C2C 96" - 120" wide C3M 120" wide C3C 120" wide C3MOM 120" wide See chart on page 45 for cutout codes and power and storage unit configurations
		<b>Double Cut</b> DC1 Double Cut	<b>③ Top Wood Finish</b> Double Cut: COF Coffee FOS Fossil KHK Khaki CRM Cremello GRH Graphite STU Studio Teak					

① Specialty Top Model #	② Top Surface Selection	③ Base Wood Species	④a Base Wood Finish	④b Base Paint	⑤ Metal Color	⑥ Electrical
Solid Surface (NAV)	Patterns: ARM Armadillo PEB Pebble Pearl BLP Black Pearl PUR Pure White	<b>Flat Cut</b> CH1 Cherry MA1 Maple WA1 Walnut  <b>Double Cut</b> DC1 Double Cut	See list above for Cherry, Maple and Walnut Finishes  See list above for Double Cut Finishes	See list above for Paint Finishes	See list above for Metal Paint Colors	Cutout Codes: N all tables C1M 72" - 120" wide C1C 72" - 120" wide C1O 120" wide C2M 96" - 120" wide C2C 96" - 120" wide C3M 120" wide C3C 120" wide C3MOM 120" wide
Glass Surface (NAV)	Backpainted Glass: G White Glossy M White Matte					
Sub-Top w/Base (NAV)	B (Table Ships with Sub-Top, Customer applies custom Top)					



Description

View Table with Height Adjustable Base

Laminate Tops "NAT" Models

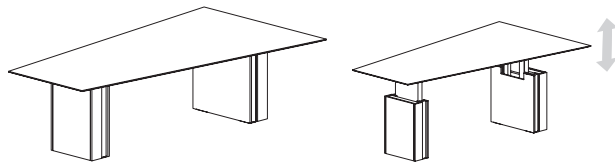

Features:

- height adjustable bases with structural support rails
- 30" to 40" height adjustment with digital controller; 10' power cord
- maximum weight rating 300lbs (evenly distributed load)
- one-piece top
- narrow end of table is 36"d

Options:

- metal base frame available in powder coat, no upcharge, or chrome, add list upcharge: for 48" wide - \$2,249, for 54" & 60" wide - \$2,530
- worksurface power & storage available, specify cutout code and order power units separately, see pages 150-151

D	W	H	CTN WT	CU FT	① Model	HPL	HPL
60	120	Adj.	386	94	NAT60120-30VTAH	\$11,665	\$12,046
60	108	Adj.	372	95	NAT60108-30VTAH	\$11,047	\$11,429
54	96	Adj.	335	100	NAT5496-30VTAH	\$10,585	\$10,967
54	84	Adj.	322	141	NAT5484-30VTAH	\$10,369	\$10,751
48	72	Adj.	292	134	NAT4872-30VTAH	\$6,669	\$7,051

NATIVE

To Order, Specify:

① Laminate Model #	②a Top Laminate / ②b Base Laminate	③ Top Edge	④ Metal Color	⑤ Electrical
Laminate (NAT)	<p>Solid Patterns:</p> <p>ALB Alabaster BBL Bridal Bianco DWH Designer White SHD Shadow SLG Slate Grey</p> <p>Wood Grain Patterns:</p> <p>AGA Aged Ash    BGL Brighton Light    OAT Oatmeal Cookie ALL Ale Light    CLL Collectors    PIN Pinnacle Walnut BLO Blonde Echo    FLO Florence Walnut    STU Studio Teak BOL Bourbon Light    GRH Graphite    VIN Vintage BZW Brazilwood    HGL High Line    WLH Walnut Heights WEA Weathered Ash</p>	<p>Edge Selection:</p> <p>R3 Eased E1 Reverse Bevel</p>	<p>Color:</p> <p>ASL Arctic Silver BWH Bright White MBK Matte Black PEW Pewter SNK Soft Nickel RML Raw (Clear) CHR Chrome* *Upcharge applies</p>	<p>Cutout Codes:</p> <p>N all tables C1M 72" - 120" wide C1C 72" - 120" wide C1O 120" wide C2M 96" - 120" wide C2C 96" - 120" wide C3M 120" wide C3C 120" wide C3MOM 120" wide</p>

Description

View Table with Height Adjustable Base (continued)

						Veneer Tops "NAV" Models				Premier Tops "NAV" Models			
						Eased Edge (R3)		Reverse Bevel Edge (E1)		Solid Surface/Glass Reverse Bevel Edge			
D	W	H	CTN WT	CU FT	1 Model	Flat Cut	Double Cut	Flat Cut	Double Cut	Solid Surface	Glass	Wood Plank Ash	Sub-Top with Base
60	120	Adj.	386	94	NAV60120-30VTAH	\$15,502	\$17,465	\$15,648	\$17,612	\$26,170	--	--	\$14,804
60	108	Adj.	372	95	NAV60108-30VTAH	\$14,714	\$16,604	\$14,861	\$16,751	\$24,316	--	--	\$14,052
54	96	Adj.	335	100	NAV5496-30VTAH	\$14,129	\$15,601	\$14,275	\$15,747	\$21,864	--	--	\$13,494
54	84	Adj.	322	141	NAV5484-30VTAH	\$13,839	\$15,281	\$13,986	\$15,428	\$20,705	--	--	\$13,215
48	72	Adj.	292	134	NAV4872-30VTAH	\$8,944	\$9,903	\$9,091	\$10,049	\$14,230	--	--	\$8,542

NATIVE

To Order, Specify:

1 Veneer Model #	2 Wood Species	3 Top Wood Finish	4 Base Finish	5 Top Edge	6 Metal Color	7 Electrical		
Veneer (NAV)	<b>Flat Cut</b> CH1 Cherry MA1 Maple WA1 Walnut	Cherry: BRL Barley BBM Bourbon Medium BRM Brighton Medium CLA Classic CLL Collectors* EAR Earthy HRV Harvest* LGC Legacy PRL Praline* SAF Saffron Finishes with an asterisk (*) have a coordinating laminate available	Maple: ALM Ale Medium BUT Butterscotch CIN Cinnamon FLX Flax VEN Venetian	Walnut: AUB Auburn ESP Espresso MCH Mocha* NTO Night Owl* SIE Sienna* TOF Toffee TRF Truffle*	V - Same as Top Finish  P - Paint Color: BKD Backdrop BFX Black Fox BWH Bright White CGP Cargo Pants CHT Chatroom FRR French Roast GRV Greek Villa NET Network Gray NWH Nonchalant White STM Storm TRC Tricorn Black	Edge Selection: R3 Eased E1 Reverse Bevel	Color: ASL Arctic Silver BWH Bright White MBK Matte Black PEW Pewter SNK Soft Nickel RML Raw (Clear) CHR Chrome* *Upcharge applies	Cutout Codes: N all tables C1M 72" - 120" wide C1C 72" - 120" wide C1O 120" wide C2M 96" - 120" wide C2C 96" - 120" wide C3M 120" wide C3C 120" wide C3MOM 120" wide See chart on page 45 for cutout codes and power and storage unit configurations
		<b>Double Cut</b> DC1 Double Cut	<b>3 Top Wood Finish</b> Double Cut: COF Coffee FOS Fossil KHK Khaki CRM Cremello GRH Graphite STU Studio Teak					

1 Specialty Top Model #	2 Top Surface Selection	3 Base Wood Species	4a Base Wood Finish	4b Base Paint	5 Metal Color	6 Electrical
Solid Surface (NAV)	Patterns: ARM Armadillo PEB Pebble Pearl BLP Black Pearl PUR Pure White	<b>Flat Cut</b> CH1 Cherry MA1 Maple WA1 Walnut  <b>Double Cut</b> DC1 Double Cut	See list above for Cherry, Maple and Walnut Finishes  See list above for Double Cut Finishes	See list above for Paint Finishes	See list above for Metal Paint Colors	Cutout Codes: N all tables C1M 72" - 120" wide C1C 72" - 120" wide C1O 120" wide C2M 96" - 120" wide C2C 96" - 120" wide C3M 120" wide C3C 120" wide C3MOM 120" wide
Glass Surface (NAV)	Backpainted Glass: G White Glossy M White Matte					
Sub-Top w/Base (NAV)	B (Table Ships with Sub-Top, Customer applies custom Top)					

Description

Square Table with X Base

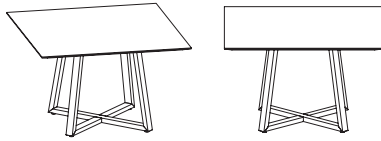

Laminate Tops "NAT" Models

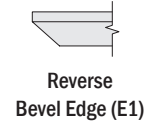
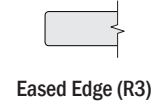

D	W	H	CTN WT	CU FT	① Model	HPL	HPL
60	60	29 3/8	176	63	NAT6060-30SQXB	\$2,621	\$3,003
54	54	29 3/8	149	59	NAT5454-30SQXB	\$2,449	\$2,830
48	48	29 3/8	123	41	NAT4848-30SQXB	\$2,336	\$2,717

Features:

- metal X-base
- glass top has additional seams

Options:

- worksurface power & storage available, specify cutout code and order power units separately, see pages 150-151
- metal base frame available in powder coat, no upcharge, or chrome, add list upcharge: for 48" wide - \$1,485, for 54" wide - \$1,665, for 60 wide - \$1,716
- magnetic wire manager available; order separately, see page 150

NATIVE

Description

Round Table with X Base



Laminate Tops "NAT" Models

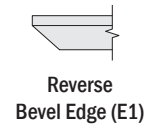
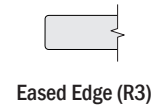

D	W	H	CTN WT	CU FT	① Model	HPL	HPL
60	60	29 3/8	151	63	NAT6060-30RDXB	\$2,613	\$2,995
54	54	29 3/8	129	45	NAT5454-30RDXB	\$2,441	\$2,822
48	48	29 3/8	109	41	NAT4848-30RDXB	\$2,325	\$2,707

Features:

- metal X-base

Options:

- worksurface power & storage available, specify cutout code and order power units separately, see page 150
- metal base frame available in powder coat, no upcharge, or chrome, add list upcharge: for 48" wide - \$1,485, for 54" wide - \$1,665, for 60 wide - \$1,716
- magnetic wire manager available; order separately, see page 150

To Order, Specify:

① Laminate Model #	② Top Laminate	③ Top Edge	④ Metal Color	⑤ Electrical
Laminate (NAT)	<p>Solid Patterns:</p> <p>ALB Alabaster BBL Bridal Bianco DWH Designer White SHD Shadow SLG Slate Grey</p> <p>Wood Grain Patterns:</p> <p>AGA Aged Ash ALL Ale Light BLO Blonde Echo BOL Bourbon Light BZW Brazilwood</p> <p>BGL Brighton Light CLL Collectors FLO Florence Walnut GRH Graphite HGL High Line</p> <p>OAT Oatmeal Cookie PIN Pinnacle Walnut STU Studio Teak VIN Vintage WLH Walnut Heights WEA Weathered Ash</p>	<p>Edge Selection:</p> <p>R3 Eased E1 Reverse Bevel</p>	<p>Color:</p> <p>ASL Arctic Silver BWH Bright White MBK Matte Black PEW Pewter SNK Soft Nickel RML Raw (Clear) CHR Chrome* *Upcharge applies</p>	<p>Cutout Codes:</p> <p>N all tables C1M 48" - 60" wide C1C 48" - 60" wide</p> <p>See chart on page 45 for cutout codes and power and storage unit configurations</p>

Description

Square Table with X Base  
(continued)

						Veneer Tops "NAV" Models				Premier Tops "NAV" Models			
						Eased Edge (R3)		Reverse Bevel Edge (E1)		Solid Surface/Glass Reverse Bevel Edge		Wood Plank Ash	
D	W	H	CTN WT	CU FT	① Model	Flat Cut	Double Cut	Flat Cut	Double Cut	Solid Surface	Glass	Wood Plank Ash	Sub-Top with Base
60	60	29 3/8	176	63	NAV6060-30SQXB	\$3,598	\$4,037	\$3,745	\$4,185	\$9,087	\$8,328	--	\$3,437
54	54	29 3/8	149	59	NAV5454-30SQXB	\$3,379	\$3,740	\$3,525	\$3,888	\$7,900	\$7,210	--	\$3,227
48	48	29 3/8	123	41	NAV4848-30SQXB	\$3,245	\$3,536	\$3,391	\$3,681	\$6,897	\$6,272	\$5,396	\$3,099

Description

Round Table with X Base  
(continued)

						Veneer Tops "NAV" Models				Premier Tops "NAV" Models			
						Eased Edge (R3)		Reverse Bevel Edge (E1)		Solid Surface/Glass Reverse Bevel Edge		Wood Plank Ash	
D	W	H	CTN WT	CU FT	① Model	Flat Cut	Double Cut	Flat Cut	Double Cut	Solid Surface	Glass	Wood Plank Ash	Custom Sub-Base
60	60	29 3/8	151	63	NAV6060-30RDXB	\$3,584	\$4,025	\$3,732	\$4,173	\$9,073	\$8,316	--	\$3,424
54	54	29 3/8	129	45	NAV5454-30RDXB	\$3,368	\$3,731	\$3,516	\$3,878	\$7,890	\$7,201	--	\$3,218
48	48	29 3/8	109	41	NAV4848-30RDXB	\$3,229	\$3,520	\$3,376	\$3,668	\$6,882	\$6,259	\$5,381	\$3,085

To Order, Specify:

① Veneer Model #	② Wood Species	③ Top Wood Finish	④ Top Edge	⑤ Metal Color	⑥ Electrical		
Veneer (NAV)	Flat Cut CH1 Cherry MA1 Maple WA1 Walnut	Cherry: BRL Barley BBM Bourbon Medium BRM Brighton Medium CLA Classic CLL Collectors* EAR Earthy HRV Harvest* LGC Legacy PRL Praline* SAF Saffron Finishes with an asterisk (*) have a coordinating laminate available	Maple: ALM Ale Medium BUT Butterscotch CIN Cinnamon FLX Flax VEN Venetian	Walnut: AUB Auburn ESP Espresso MCH Mocha* NTO Night Owl* SIE Sienna* TOF Toffee TRF Truffle*	Edge Selection: R3 Eased E1 Reverse Bevel	Color: ASL Arctic Silver BWH Bright White MBK Matte Black PEW Pewter SNK Soft Nickel RML Raw (Clear) CHR Chrome* *Upcharge applies	Cutout Codes: N all tables C1M 48" - 60" wide C1C 48" - 60" wide See chart on page 45 for cutout codes and power and storage unit configurations
	Double Cut DC1 Double Cut	③ Top Wood Finish	Double Cut: COF Coffee CRM Cremello	FOS Fossil GRH Graphite KHK Khaki STU Studio Teak			

① Specialty Top Model #	② Top Surface Selection	③ Metal Color	④ Electrical
Solid Surface (NAV)	Patterns: ARM Armadillo BLP Black Pearl PEB Pebble Pearl PUR Pure White	See list above for Metal Paint Colors	Cutout Codes: N all tables C1M 48" - 60" wide C1C 48" - 60" wide See chart on page 45 for cutout codes and power and storage unit configurations
Glass Surface (NAV)	Backpainted Glass: G White Glossy M White Matte		
Wood Plank (NAV)	W Wood Plank Ash, Clear Coat		
Sub-Top w/Base (NAV)	B (Table Ships with Sub-Top, Customer applies custom Top)		

Description

Rectangular Peninsula Table with Open Loop Base

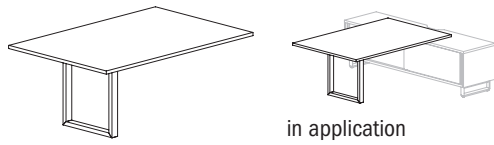

in application

Laminate Tops "NAT" Models

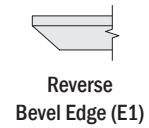
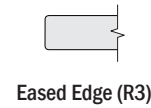

Features:

- must attach to 26" h Credenza, installation template included
- metal open loop base with structural support rails
- glass top has additional seams

Options:

- worksurface power & storage available, specify cutout code and order power units separately, see pages 150-151
- metal base frame available in powder coat, no upcharge, or chrome, add list upcharge: for 36" wide - \$849, for 42" & 48 wide - \$984, for 54 wide - \$1,126
- magnetic wire manager available; order separately, see page 150

D	W	H	CTN WT	CU FT	① Model	HPL	HPL
54	60	29 3/8	156	51	NAT5460-30TTPLB	\$2,706	\$3,087
48	84	29 3/8	186	47	NAT4884-30TTPLB	\$2,733	\$3,115
48	72	29 3/8	186	29	NAT4872-30TTPLB	\$2,668	\$3,047
48	60	29 3/8	129	37	NAT4860-30TTPLB	\$2,559	\$2,941
42	84	29 3/8	186	39	NAT4284-30TTPLB	\$2,685	\$3,067
42	72	29 3/8	151	42	NAT4272-30TTPLB	\$2,629	\$3,009
42	60	29 3/8	151	33	NAT4260-30TTPLB	\$2,503	\$2,885
36	84	29 3/8	149	42	NAT3684-30TTPLB	\$2,640	\$3,022
36	72	29 3/8	119	34	NAT3672-30TTPLB	\$2,587	\$2,969
36	60	29 3/8	114	42	NAT3660-30TTPLB	\$2,492	\$2,874

NATIVE

To Order, Specify:

① Laminate Model #	② Top Laminate	③ Top Edge	④ Metal Color	⑤ Electrical
Laminate (NAT)	<p>Solid Patterns:</p> <p>ALB Alabaster BBL Bridal Bianco DWH Designer White SHD Shadow SLG Slate Grey</p> <p>Wood Grain Patterns:</p> <p>AGA Aged Ash ALL Ale Light BLO Blonde Echo BOL Bourbon Light BZW Brazilwood</p> <p>BGL Brighton Light CLL Collectors FLO Florence Walnut GRH Graphite HGL High Line</p> <p>OAT Oatmeal Cookie PIN Pinnacle Walnut STU Studio Teak VIN Vintage WLH Walnut Heights WEA Weathered Ash</p>	<p>Edge Selection:</p> <p>R3 Eased E1 Reverse Bevel</p>	<p>Color:</p> <p>ASL Arctic Silver BWH Bright White MBK Matte Black PEW Pewter SNK Soft Nickel RML Raw (Clear) CHR Chrome* *Upcharge applies</p>	<p>Cutout Codes:</p> <p>N all tables C1M 72" - 84" wide C1C 72" - 84" wide</p> <p>See chart on page 45 for cutout codes and power and storage unit configurations</p>

Description

Rectangular Peninsula Table  
with Open Loop Base  
(continued)

						Veneer Tops "NAV" Models				Premier Tops "NAV" Models			
						Eased Edge (R3)		Reverse Bevel Edge (E1)		Solid Surface/Glass Reverse Bevel Edge		Wood Plank Ash	
D	W	H	CTN WT	CU FT	Model	Flat Cut	Double Cut	Flat Cut	Double Cut	Solid Surface	Glass	Wood Plank Ash	Sub-Top with Base
54	60	29 3/8	156	51	NAV5460-30TTPLB	\$3,220	\$3,651	\$3,367	\$3,798	\$8,585	\$7,478	--	\$3,076
48	84	29 3/8	186	47	NAV4884-30TTPLB	\$3,252	\$3,745	\$3,399	\$3,891	\$9,355	\$8,551	\$7,017	\$3,105
48	72	29 3/8	186	29	NAV4872-30TTPLB	\$3,174	\$3,599	\$3,321	\$3,746	\$8,461	\$7,716	\$6,402	\$3,032
48	60	29 3/8	129	37	NAV4860-30TTPLB	\$3,045	\$3,405	\$3,193	\$3,552	\$7,515	\$6,831	\$5,734	\$2,909
42	84	29 3/8	186	39	NAV4284-30TTPLB	\$3,196	\$3,632	\$3,344	\$3,778	\$8,586	\$7,834	\$6,492	\$3,054
42	72	29 3/8	151	42	NAV4272-30TTPLB	\$3,128	\$3,504	\$3,275	\$3,650	\$7,802	\$7,103	\$5,952	\$2,987
42	60	29 3/8	151	33	NAV4260-30TTPLB	\$2,979	\$3,295	\$3,126	\$3,442	\$6,938	\$6,291	\$5,332	\$2,846
36	84	29 3/8	149	42	NAV3684-30TTPLB	\$3,141	\$3,520	\$3,288	\$3,668	\$7,817	\$7,115	\$5,964	\$3,001
36	72	29 3/8	119	34	NAV3672-30TTPLB	\$3,079	\$3,406	\$3,227	\$3,553	\$7,143	\$6,487	\$5,501	\$2,942
36	60	29 3/8	114	42	NAV3660-30TTPLB	\$2,967	\$3,243	\$3,115	\$3,389	\$6,415	\$5,805	\$4,984	\$2,834

NATIVE

To Order, Specify:

1 Veneer Model #	2 Wood Species	3 Top Wood Finish	4 Top Edge	5 Metal Color	6 Electrical
Veneer (NAV)	Flat Cut CH1 Cherry MA1 Maple WA1 Walnut	Cherry: BRL Barley BBM Bourbon Medium BRM Brighton Medium CLA Classic CLL Collectors* EAR Earthy HRV Harvest* LGC Legacy PRL Praline* SAF Saffron Finishes with an asterisk (*) have a coordinating laminate available	Edge Selection: R3 Eased E1 Reverse Bevel	Color: ASL Arctic Silver BWH Bright White MBK Matte Black PEW Pewter SNK Soft Nickel RML Raw (Clear) CHR Chrome* *Upcharge applies	Cutout Codes: N all tables C1M 72" - 84" wide C1C 72" - 84" wide See chart on page 45 for cutout codes and power and storage unit configurations
	Double Cut DC1 Double Cut	Maple: ALM Ale Medium BUT Butterscotch CIN Cinnamon FLX Flax VEN Venetian Walnut: AUB Auburn ESP Espresso MCH Mocha* NTO Night Owl* SIE Sienna* TOF Toffee TRF Truffle*			

1 Specialty Top Model #	2 Top Surface Selection	3 Metal Color	4 Electrical
Solid Surface (NAV)	Patterns: ARM Armadillo PEB Pebble Pearl BLP Black Pearl PUR Pure White	See list above for Metal Paint Colors	Cutout Codes: N all tables C1M 72" - 84" wide C1C 72" - 84" wide See chart on page 45 for cutout codes and power and storage unit configurations
Glass Surface (NAV)	Backpainted Glass: G White Glossy M White Matte		
Wood Plank (NAV)	W Wood Plank Ash, Clear Coat		
Sub-Top w/Base (NAV)	B (Table Ships with Sub-Top, Customer applies custom Top)		

Description

Standing Height Rectangular Peninsula Table with Open Loop Base

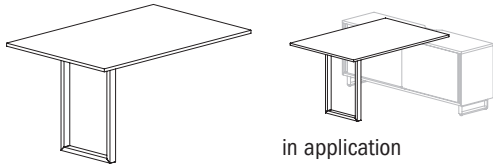

in application

Laminate Tops "NAT" Models

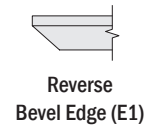
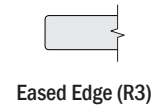

Features:

- must attach to 36" h Credenza, installation template included
- metal open loop base with structural support rails
- glass top has additional seams

Options:

- worksurface power & storage available, specify cutout code and order power units separately, see pages 150-151
- metal base frame available in powder coat, no upcharge, or chrome, add list upcharge: for 36" wide - \$935, for 42" & 48 wide - \$1,082, for 54 wide - \$1,170
- magnetic wire manager available; order separately, see page 150

D	W	H	CTN WT	CU FT	① Model	HPL	HPL
54	60	40	161	51	NAT5460-40TTPLB	\$2,674	\$3,056
48	84	40	192	47	NAT4884-40TTPLB	\$2,700	\$3,082
48	72	40	171	29	NAT4872-40TTPLB	\$2,636	\$3,016
48	60	40	147	36	NAT4860-40TTPLB	\$2,528	\$2,910
42	84	40	169	40	NAT4284-40TTPLB	\$2,654	\$3,036
42	72	40	156	53	NAT4272-40TTPLB	\$2,596	\$2,978
42	60	40	175	34	NAT4260-40TTPLB	\$2,497	\$2,879
36	84	40	155	34	NAT3684-40TTPLB	\$2,313	\$2,694
36	72	40	139	32	NAT3672-40TTPLB	\$2,557	\$2,939
36	60	40	119	35	NAT3660-40TTPLB	\$2,463	\$2,845

NATIVE

To Order, Specify:

① Laminate Model #	② Top Laminate	③ Top Edge	④ Metal Color	⑤ Electrical
Laminate (NAT)	<p>Solid Patterns:</p> <p>ALB Alabaster BBL Bridal Bianco DWH Designer White SHD Shadow SLG Slate Grey</p> <p>Wood Grain Patterns:</p> <p>AGA Aged Ash ALL Ale Light BLO Blonde Echo BOL Bourbon Light BZW Brazilwood</p> <p>BGL Brighton Light CLL Collectors FLO Florence Walnut GRH Graphite HGL High Line</p> <p>OAT Oatmeal Cookie PIN Pinnacle Walnut STU Studio Teak VIN Vintage WLH Walnut Heights WEA Weathered Ash</p>	<p>Edge Selection:</p> <p>R3 Eased E1 Reverse Bevel</p>	<p>Color:</p> <p>ASL Arctic Silver BWH Bright White MBK Matte Black PEW Pewter SNK Soft Nickel RML Raw (Clear) CHR Chrome* *Upcharge applies</p>	<p>Cutout Codes:</p> <p>N all tables C1M 72" - 84" wide C1C 72" - 84" wide</p> <p>See chart on page 45 for cutout codes and power and storage unit configurations</p>

Description

Standing Height Rectangular Peninsula Table with Open Loop Base (continued)

						Veneer Tops "NAV" Models				Premier Tops "NAV" Models			
						Eased Edge (R3)		Reverse Bevel Edge (E1)		Solid Surface/Glass Reverse Bevel Edge		Wood Plank Ash	
D	W	H	CTN WT	CU FT	Model	Flat Cut	Double Cut	Flat Cut	Double Cut	Solid Surface	Glass	Wood Plank Ash	Sub-Top with Base
54	60	40	161	51	NAV5460-40TTPLB	\$3,220	\$3,651	\$3,367	\$3,798	\$8,585	\$7,478	--	\$3,076
48	84	40	192	47	NAV4884-40TTPLB	\$3,252	\$3,745	\$3,399	\$3,891	\$9,355	\$8,551	\$7,017	\$3,105
48	72	40	171	29	NAV4872-40TTPLB	\$3,174	\$3,599	\$3,321	\$3,746	\$8,461	\$7,716	\$6,402	\$3,032
48	60	40	147	36	NAV4860-40TTPLB	\$3,045	\$3,405	\$3,193	\$3,552	\$7,515	\$6,831	\$5,734	\$2,909
42	84	40	169	40	NAV4284-40TTPLB	\$3,196	\$3,632	\$3,344	\$3,778	\$8,586	\$7,834	\$6,492	\$3,054
42	72	40	156	53	NAV4272-40TTPLB	\$3,128	\$3,504	\$3,275	\$3,650	\$7,802	\$7,103	\$5,952	\$2,987
42	60	40	175	34	NAV4260-40TTPLB	\$3,007	\$3,324	\$3,155	\$3,470	\$6,967	\$6,319	\$5,361	\$2,873
36	84	40	155	34	NAV3684-40TTPLB	\$2,786	\$3,164	\$2,933	\$3,312	\$7,463	\$6,760	\$5,609	\$2,661
36	72	40	139	32	NAV3672-40TTPLB	\$3,079	\$3,406	\$3,227	\$3,553	\$7,143	\$6,487	\$5,501	\$2,942
36	60	40	119	35	NAV3660-40TTPLB	\$2,967	\$3,243	\$3,115	\$3,389	\$6,415	\$5,805	\$4,984	\$2,834

NATIVE

To Order, Specify:

1 Veneer Model #	2 Wood Species	3 Top Wood Finish	4 Top Edge	5 Metal Color	6 Electrical
Veneer (NAV)	<p>Flat Cut</p> <p>CH1 Cherry MA1 Maple WA1 Walnut</p>	<p>Cherry:</p> <p>BRL Barley BBM Bourbon Medium BRM Brighton Medium CLA Classic CLL Collectors* EAR Earthy HRV Harvest* LGC Legacy PRL Praline* SAF Saffron</p> <p>Maple:</p> <p>ALM Ale Medium BUT Butterscotch CIN Cinnamon FLX Flax VEN Venetian</p> <p>Walnut:</p> <p>AUB Auburn ESP Espresso MCH Mocha* NTO Night Owl* SIE Sienna* TOF Toffee TRF Truffle*</p> <p>Finishes with an asterisk (*) have a coordinating laminate available</p>	<p>Edge Selection:</p> <p>R3 Eased E1 Reverse Bevel</p>	<p>Color:</p> <p>ASL Arctic Silver BWH Bright White MBK Matte Black PEW Pewter SNK Soft Nickel RML Raw (Clear) CHR Chrome* *Upcharge applies</p>	<p>Cutout Codes:</p> <p>N all tables C1M 72" - 84" wide C1C 72" - 84" wide See chart on page 45 for cutout codes and power and storage unit configurations</p>
	<p>Double Cut</p> <p>DC1 Double Cut</p>	<p>3 Top Wood Finish</p> <p>Double Cut:</p> <p>COF Coffee FOS Fossil KHK Khaki CRM Cremello GRH Graphite STU Studio Teak</p>			

1 Specialty Top Model #	2 Top Surface Selection	3 Metal Color	4 Electrical
Solid Surface (NAV)	<p>Patterns:</p> <p>ARM Armadillo PEB Pebble Pearl BLP Black Pearl PUR Pure White</p>	See list above for Metal Paint Colors	<p>Cutout Codes:</p> <p>N all tables C1M 72" - 84" wide C1C 72" - 84" wide See chart on page 45 for cutout codes and power and storage unit configurations</p>
Glass Surface (NAV)	<p>Backpainted Glass:</p> <p>G White Glossy M White Matte</p>		
Wood Plank (NAV)	<p>W Wood Plank Ash, Clear Coat</p>		
Sub-Top w/Base (NAV)	<p>B (Table Ships with Sub-Top, Customer applies custom Top)</p>		



Description

View Peninsula Table with Open Loop Base

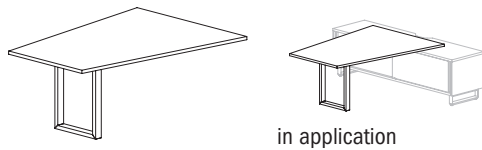

Laminate Tops "NAT" Models

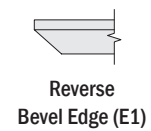
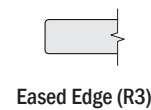

Features:

- must attach to 26" h Credenza, installation template included
- metal open loop base with structural support rails
- narrow end of table is 36" d
- glass top has additional seams

D	W	H	CTN WT	CU FT	① Model	HPL	HPL
54	84	29 3/8	175	52	NAT5484-30VTPLB	\$2,714	\$3,096
54	72	29 3/8	156	55	NAT5472-30VTPLB	\$2,640	\$3,022
54	60	29 3/8	138	51	NAT5460-30VTPLB	\$2,537	\$2,918

Options:

- metal base frame available in powder coat, no upcharge, or chrome, add \$1,126 list upcharge
- worksurface power & storage available, specify cutout code and order power units separately, see pages 150-151
- magnetic wire manager available; order separately, see page 150

Description

Standing Height View Peninsula Table with Open Loop Base

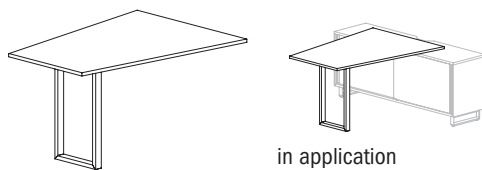

Laminate Tops "NAT" Models

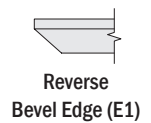
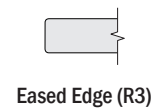

Features:

- must attach to 36" h Credenza, installation template included
- metal open loop base with structural support rails
- narrow end of table is 36" d
- glass top has additional seams

D	W	H	CTN WT	CU FT	① Model	HPL	HPL
54	84	40	181	52	NAT5484-40VTPLB	\$2,896	\$3,278
54	72	40	161	55	NAT5472-40VTPLB	\$2,823	\$3,205
54	60	40	139	51	NAT5460-40VTPLB	\$2,749	\$3,130

Options:

- metal base frame available in powder coat, no upcharge, or chrome, add \$1,126 list upcharge
- worksurface power & storage available, specify cutout code and order power units separately, see pages 150-151
- magnetic wire manager available; order separately, see page 150

To Order, Specify:

① Laminate Model #	②a Top Laminate / ②b Base Laminate	③ Top Edge	④ Metal Color	⑤ Electrical
Laminate (NAT)	<p>Solid Patterns:</p> <p>ALB Alabaster BBL Bridal Bianco DWH Designer White SHD Shadow SLG Slate Grey</p> <p>Wood Grain Patterns:</p> <p>AGA Aged Ash ALL Ale Light BLO Blonde Echo BOL Bourbon Light BZW Brazilwood</p> <p>BGL Brighton Light CLL Collectors FLO Florence Walnut GRH Graphite HGL High Line</p> <p>OAT Oatmeal Cookie PIN Pinnacle Walnut STU Studio Teak VIN Vintage WLH Walnut Heights WEA Weathered Ash</p>	<p>Edge Selection:</p> <p>R3 Eased E1 Reverse Bevel</p>	<p>Color:</p> <p>ASL Arctic Silver BWH Bright White MBK Matte Black PEW Pewter SNK Soft Nickel RML Raw (Clear) CHR Chrome* *Upcharge applies</p>	<p>Cutout Codes:</p> <p>N all tables C1M 72" - 84" wide C1C 72" - 84" wide</p> <p>See chart on page 45 for cutout codes and power and storage unit configurations</p>

Description

View Peninsula Table with Open Loop Base  
(continued)

						Veneer Tops "NAV" Models				Premier Tops "NAV" Models			
						Eased Edge (R3)		Reverse Bevel Edge (E1)		Solid Surface/Glass Reverse Bevel Edge		Wood Plank Ash	
D	W	H	CTN WT	CU FT	① Model	Flat Cut	Double Cut	Flat Cut	Double Cut	Solid Surface	Glass	Wood Plank Ash	Sub-Top with Base
54	84	29 3/8	175	52	NAV5484-30VTPLB	\$3,230	\$3,786	\$3,378	\$3,934	\$10,097	\$9,192	--	\$3,086
54	72	29 3/8	156	55	NAV5472-30VTPLB	\$3,142	\$3,638	\$3,289	\$3,785	\$9,311	\$8,253	--	\$3,002
54	60	29 3/8	138	51	NAV5460-30VTPLB	\$3,019	\$3,450	\$3,165	\$3,598	\$8,384	\$7,277	--	\$2,884

Description

Standing Height View Peninsula Table with Open Loop Base  
(continued)

						Veneer Tops "NAV" Models				Premier Tops "NAV" Models			
						Eased Edge (R3)		Reverse Bevel Edge (E1)		Solid Surface/Glass Reverse Bevel Edge		Wood Plank Ash	
D	W	H	CTN WT	CU FT	① Model	Flat Cut	Double Cut	Flat Cut	Double Cut	Solid Surface	Glass	Wood Plank Ash	Sub-Top with Base
54	84	40	181	52	NAV5484-40VTPLB	\$3,448	\$4,003	\$3,596	\$4,151	\$10,314	\$9,409	--	\$3,293
54	72	40	161	55	NAV5472-40VTPLB	\$3,360	\$3,855	\$3,507	\$4,002	\$9,527	\$8,469	--	\$3,209
54	60	40	139	51	NAV5460-40VTPLB	\$3,271	\$3,702	\$3,419	\$3,849	\$8,637	\$7,529	--	\$3,124

To Order, Specify:

① Veneer Model #	② Wood Species	③ Top Wood Finish	④ Base Finish	⑤ Top Edge	⑥ Metal Color	⑦ Electrical		
Veneer (NAV)	<b>Flat Cut</b> CH1 Cherry MA1 Maple WA1 Walnut	Cherry: BRL Barley BBM Bourbon Medium BRM Brighton Medium CLA Classic CLL Collectors* EAR Earthy HRV Harvest* LGC Legacy PRL Praline* SAF Saffron Finishes with an asterisk (*) have a coordinating laminate available	Maple: ALM Ale Medium BUT Butterscotch CIN Cinnamon FLX Flax VEN Venetian	Walnut: AUB Auburn ESP Espresso MCH Mocha* NTO Night Owl* SIE Sienna* TOF Toffee TRF Truffle*	V - Same as Top Finish  P - Paint Color: BKD Backdrop BFX Black Fox BWH Bright White CGP Cargo Pants CHT Chatroom FRR French Roast GRV Greek Villa NET Network Gray NWH Nonchalant White STM Storm TRC Tricorn Black	Edge Selection: R3 Eased E1 Reverse Bevel	Color: ASL Arctic Silver BWH Bright White MBK Matte Black PEW Pewter SNK Soft Nickel RML Raw (Clear) CHR Chrome* *Upcharge applies	Cutout Codes: N all tables C1M 72" - 84" wide C1C 72" - 84" wide See chart on page 45 for cutout codes and power and storage unit configurations
		<b>Double Cut</b> DC1 Double Cut	<b>③ Top Wood Finish</b> Double Cut: COF Coffee FOS Fossil KHK Khaki CRM Cremello GRH Graphite STU Studio Teak					

① Specialty Top Model #	② Top Surface Selection	③ Base Wood Species	④a Base Wood Finish	④b Base Paint	⑤ Metal Color	⑥ Electrical
Solid Surface (NAV)	Patterns: ARM Armadillo PEB Pebble Pearl BLP Black Pearl PUR Pure White	<b>Flat Cut</b> CH1 Cherry MA1 Maple WA1 Walnut  <b>Double Cut</b> DC1 Double Cut	See list above for Cherry, Maple and Walnut Finishes  See list above for Double Cut Finishes	See list above for Paint Finishes	See list above for Metal Paint Colors	Cutout Codes: N all tables C1M 72" - 84" wide C1C 72" - 84" wide See chart on page 45 for cutout codes and power and storage unit configurations
Glass Surface (NAV)	Backpainted Glass: G White Glossy M White Matte					
Sub-Top w/Base (NAV)	B (Table Ships with Sub-Top, Customer applies custom Top)					

Description

Rectangular Peninsula Table with Panel Base

Laminate Tops "NAT" Models

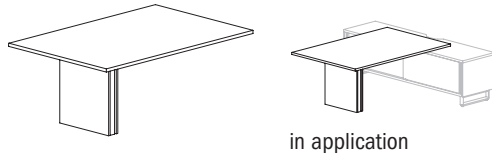

Features:

- must attach to 26" h Credenza, installation template included
- panel base with structural support rails
- glass top has additional seams

Options:

- metal base frame available in powder coat, no upcharge, or chrome, add list upcharge: for 36" wide - \$849, for 42" & 48 wide - \$984, for 54 wide - \$1,126
- worksurface power & storage available, specify cutout code and order power units separately, see pages 150-151

D	W	H	CTN WT	CU FT	① Model	HPL	HPL
54	60	29 3/8	180	55	NAT5460-30TTPPB	\$2,904	\$3,285
48	84	29 3/8	207	47	NAT4884-30TTPPB	\$2,924	\$3,305
48	72	29 3/8	207	40	NAT4872-30TTPPB	\$2,860	\$3,240
48	60	29 3/8	161	37	NAT4860-30TTPPB	\$3,025	\$3,406
42	84	29 3/8	190	39	NAT4284-30TTPPB	\$2,879	\$3,259
42	72	29 3/8	156	38	NAT4272-30TTPPB	\$2,821	\$3,202
42	60	29 3/8	149	33	NAT4260-30TTPPB	\$2,721	\$3,102
36	84	29 3/8	167	42	NAT3684-30TTPPB	\$2,522	\$2,904
36	72	29 3/8	151	34	NAT3672-30TTPPB	\$2,766	\$3,148
36	60	29 3/8	131	42	NAT3660-30TTPPB	\$2,649	\$3,030

NATIVE

To Order, Specify:

① Laminate Model #	②a Top Laminate / ②b Base Laminate	③ Top Edge	④ Metal Color	⑤ Electrical
Laminate (NAT)	<p>Solid Patterns:</p> <p>ALB Alabaster BBL Bridal Bianco DWH Designer White SHD Shadow SLG Slate Grey</p> <p>Wood Grain Patterns:</p> <p>AGA Aged Ash ALL Ale Light BLO Blonde Echo BOL Bourbon Light BZW Brazilwood</p> <p>BGL Brighton Light CLL Collectors FLO Florence Walnut GRH Graphite HGL High Line</p> <p>OAT Oatmeal Cookie PIN Pinnacle Walnut STU Studio Teak VIN Vintage WLH Walnut Heights WEA Weathered Ash</p>	<p>Edge Selection:</p> <p>R3 Eased E1 Reverse Bevel</p>	<p>Color:</p> <p>ASL Arctic Silver BWH Bright White MBK Matte Black PEW Pewter SNK Soft Nickel RML Raw (Clear) CHR Chrome* *Upcharge applies</p>	<p>Cutout Codes:</p> <p>N all tables C1M 72" - 84" wide C1C 72" - 84" wide</p> <p>See chart on page 45 for cutout codes and power and storage unit configurations</p>

Description

Rectangular Peninsula Table with Panel Base  
(continued)

						Veneer Tops "NAV" Models				Premier Tops "NAV" Models			
						Eased Edge (R3)		Reverse Bevel Edge (E1)		Solid Surface/Glass Reverse Bevel Edge			
D	W	H	CTN WT	CU FT	① Model	Flat Cut	Double Cut	Flat Cut	Double Cut	Solid Surface	Glass	Wood Plank Ash	Sub-Top with Base
54	60	29 3/8	180	55	NAV5460-30TPPB	\$3,497	\$4,044	\$3,644	\$4,191	\$8,862	\$7,755	--	\$3,341
48	84	29 3/8	207	47	NAV4884-30TPPB	\$3,521	\$4,095	\$3,669	\$4,243	\$9,624	\$8,820	\$7,287	\$3,364
48	72	29 3/8	207	40	NAV4872-30TPPB	\$3,445	\$4,005	\$3,591	\$4,153	\$8,732	\$7,986	\$6,672	\$3,290
48	60	29 3/8	161	37	NAV4860-30TPPB	\$3,642	\$4,237	\$3,790	\$4,384	\$8,111	\$7,428	\$6,332	\$3,480
42	84	29 3/8	190	39	NAV4284-30TPPB	\$3,467	\$4,033	\$3,614	\$4,180	\$8,857	\$8,104	\$6,761	\$3,312
42	72	29 3/8	156	38	NAV4272-30TPPB	\$3,398	\$3,953	\$3,545	\$4,099	\$8,072	\$7,373	\$6,222	\$3,246
42	60	29 3/8	149	33	NAV4260-30TPPB	\$3,277	\$3,811	\$3,424	\$3,959	\$7,236	\$6,589	\$5,630	\$3,130
36	84	29 3/8	167	42	NAV3684-30TPPB	\$3,037	\$3,533	\$3,184	\$3,679	\$7,714	\$7,012	\$5,861	\$2,902
36	72	29 3/8	151	34	NAV3672-30TPPB	\$3,331	\$3,874	\$3,479	\$4,022	\$7,394	\$6,738	\$5,752	\$3,182
36	60	29 3/8	131	42	NAV3660-30TPPB	\$3,191	\$3,711	\$3,339	\$3,859	\$6,639	\$6,029	\$5,208	\$3,047

NATIVE

To Order, Specify:

① Veneer Model #	② Wood Species	③ Top Wood Finish	④ Base Finish	⑤ Top Edge	⑥ Metal Color	⑦ Electrical		
Veneer (NAV)	Flat Cut CH1 Cherry MA1 Maple WA1 Walnut	Cherry: BRL Barley BBM Bourbon Medium BRM Brighton Medium CLA Classic CLL Collectors* EAR Earthy HRV Harvest* LGC Legacy PRL Praline* SAF Saffron	Maple: ALM Ale Medium BUT Butterscotch CIN Cinnamon FLX Flax VEN Venetian	Walnut: AUB Auburn ESP Espresso MCH Mocha* NTO Night Owl* SIE Sienna* TOF Toffee TRF Truffle*	V - Same as Top Finish  P - Paint Color: BKD Backdrop BFX Black Fox BWH Bright White CGP Cargo Pants CHT Chatroom FRR French Roast GRV Greek Villa NET Network Gray NWH Nonchalant White STM Storm TRC Tricorn Black	Edge Selection: R3 Eased E1 Reverse Bevel	Color: ASL Arctic Silver BWH Bright White MBK Matte Black PEW Pewter SNK Soft Nickel RML Raw (Clear) CHR Chrome* *Upcharge applies	Cutout Codes: N all tables C1M 72" - 84" wide C1C 72" - 84" wide See chart on page 45 for cutout codes and power and storage unit configurations
		Double Cut DC1 Double Cut	③ Top Wood Finish Double Cut: COF Coffee FOS Fossil KHK Khaki CRM Cremello GRH Graphite STU Studio Teak					

① Specialty Top Model #	② Top Surface Selection	③ Base Wood Species	④a Base Wood Finish	④b Base Paint	⑤ Metal Color	⑥ Electrical
Solid Surface (NAV)	Patterns: ARM Armadillo PEB Pebble Pearl BLP Black Pearl PUR Pure White	Flat Cut CH1 Cherry MA1 Maple WA1 Walnut	See list above for Cherry, Maple and Walnut Finishes	See list above for Paint Finishes	See list above for Metal Paint Colors	Cutout Codes: N all tables C1M 72" - 84" wide C1C 72" - 84" wide See chart on page 45 for cutout codes and power and storage unit configurations
Glass Surface (NAV)	Backpainted Glass: G White Glossy M White Matte					
Wood Plank (NAV)	W Wood Plank Ash, Clear Coat	Double Cut DC1 Double Cut	See list above for Double Cut Finishes			
Sub-Top w/Base (NAV)	B (Table Ships with Sub-Top, Customer applies custom Top)					

Description

Standing Height Rectangular Peninsula Table with Panel Base

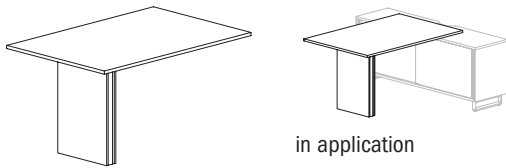

Laminate Tops "NAT" Models

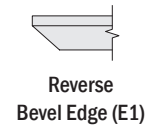
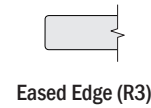

Features:

- must attach to 36" h Credenza, installation template included
- panel base with structural support rails
- glass top has additional seams

Options:

- metal base frame available in powder coat, no upcharge, or chrome, add list upcharge: for 36" wide - \$935, for 42" & 48 wide - \$1,082, for 54 wide - \$1,170
- worksurface power & storage available, specify cutout code and order power units separately, see pages 150-151

D	W	H	CTN WT	CU FT	① Model	HPL	HPL
54	60	40	198	55	NAT5460-40TTPPB	\$2,965	\$3,346
48	84	40	206	48	NAT4884-40TTPPB	\$2,946	\$3,328
48	72	40	202	40	NAT4872-40TTPPB	\$2,882	\$3,264
48	60	40	178	36	NAT4860-40TTPPB	\$2,776	\$3,158
42	84	40	206	40	NAT4284-40TTPPB	\$2,902	\$3,283
42	72	40	187	42	NAT4272-40TTPPB	\$2,843	\$3,224
42	60	40	165	34	NAT4260-40TTPPB	\$2,742	\$3,124
36	84	40	181	34	NAT3684-40TTPPB	\$2,834	\$3,216
36	72	40	165	38	NAT3672-40TTPPB	\$2,784	\$3,164
36	60	40	146	35	NAT3660-40TTPPB	\$2,690	\$3,071

NATIVE

To Order, Specify:

① Laminate Model #	②a Top Laminate / ②b Base Laminate	③ Top Edge	④ Metal Color	⑤ Electrical
Laminate (NAT)	<p>Solid Patterns:</p> <p>ALB Alabaster BBL Bridal Bianco DWH Designer White SHD Shadow SLG Slate Grey</p> <p>Wood Grain Patterns:</p> <p>AGA Aged Ash ALL Ale Light BLO Blonde Echo BOL Bourbon Light BZW Brazilwood</p> <p>BGL Brighton Light CLL Collectors FLO Florence Walnut GRH Graphite HGL High Line</p> <p>OAT Oatmeal Cookie PIN Pinnacle Walnut STU Studio Teak VIN Vintage WLH Walnut Heights WEA Weathered Ash</p>	<p>Edge Selection:</p> <p>R3 Eased E1 Reverse Bevel</p>	<p>Color:</p> <p>ASL Arctic Silver BWH Bright White MBK Matte Black PEW Pewter SNK Soft Nickel RML Raw (Clear) CHR Chrome* *Upcharge applies</p>	<p>Cutout Codes:</p> <p>N all tables C1M 72" - 84" wide C1C 72" - 84" wide</p> <p>See chart on page 45 for cutout codes and power and storage unit configurations</p>

Description

Standing Height Rectangular Peninsula Table with Panel Base (continued)

						Veneer Tops "NAV" Models				Premier Tops "NAV" Models			
						Eased Edge (R3)		Reverse Bevel Edge (E1)		Solid Surface/Glass Reverse Bevel Edge			
D	W	H	CTN WT	CU FT	① Model	Flat Cut	Double Cut	Flat Cut	Double Cut	Solid Surface	Glass	Wood Plank Ash	Sub-Top with Base
54	60	40	198	55	NAV5460-40TPPB	\$3,572	\$4,129	\$3,718	\$4,276	\$8,936	\$7,829	--	\$3,411
48	84	40	206	48	NAV4884-40TPPB	\$3,548	\$4,127	\$3,696	\$4,274	\$9,652	\$8,848	\$7,314	\$3,389
48	72	40	202	40	NAV4872-40TPPB	\$3,471	\$4,037	\$3,618	\$4,185	\$8,758	\$8,013	\$6,699	\$3,316
48	60	40	178	36	NAV4860-40TPPB	\$3,345	\$3,890	\$3,491	\$4,037	\$7,814	\$7,130	\$6,034	\$3,195
42	84	40	206	40	NAV4284-40TPPB	\$3,494	\$4,064	\$3,641	\$4,212	\$8,884	\$8,131	\$6,788	\$3,339
42	72	40	187	42	NAV4272-40TPPB	\$3,424	\$3,982	\$3,572	\$4,129	\$8,099	\$7,399	\$6,247	\$3,270
42	60	40	165	34	NAV4260-40TPPB	\$3,304	\$3,843	\$3,451	\$3,991	\$7,263	\$6,616	\$5,657	\$3,156
36	84	40	181	34	NAV3684-40TPPB	\$3,414	\$3,970	\$3,560	\$4,118	\$8,091	\$7,389	\$6,238	\$3,260
36	72	40	165	38	NAV3672-40TPPB	\$3,353	\$3,900	\$3,500	\$4,047	\$7,416	\$6,759	\$5,773	\$3,202
36	60	40	146	35	NAV3660-40TPPB	\$3,239	\$3,768	\$3,387	\$3,915	\$6,688	\$6,078	\$5,257	\$3,095

NATIVE

To Order, Specify:

① Veneer Model #	② Wood Species	③ Top Wood Finish	④ Base Finish	⑤ Top Edge	⑥ Metal Color	⑦ Electrical		
Veneer (NAV)	Flat Cut CH1 Cherry MA1 Maple WA1 Walnut	Cherry: BRL Barley BBM Bourbon Medium BRM Brighton Medium CLA Classic CLL Collectors* EAR Earthy HRV Harvest* LGC Legacy PRL Praline* SAF Saffron	Maple: ALM Ale Medium BUT Butterscotch CIN Cinnamon FLX Flax VEN Venetian	Walnut: AUB Auburn ESP Espresso MCH Mocha* NTO Night Owl* SIE Sienna* TOF Toffee TRF Truffle*	V - Same as Top Finish  P - Paint Color: BKD Backdrop BFX Black Fox BWH Bright White CGP Cargo Pants CHT Chatroom FRR French Roast GRV Greek Villa NET Network Gray NWH Nonchalant White STM Storm TRC Tricorn Black	Edge Selection: R3 Eased E1 Reverse Bevel	Color: ASL Arctic Silver BWH Bright White MBK Matte Black PEW Pewter SNK Soft Nickel RML Raw (Clear) CHR Chrome* *Upcharge applies	Cutout Codes: N all tables C1M 72" - 84" wide C1C 72" - 84" wide See chart on page 45 for cutout codes and power and storage unit configurations
		Double Cut DC1 Double Cut	③ Top Wood Finish Double Cut: COF Coffee FOS Fossil KHK Khaki CRM Cremello GRH Graphite STU Studio Teak					

① Specialty Top Model #	② Top Surface Selection	③ Base Wood Species	④a Base Wood Finish	④b Base Paint	⑤ Metal Color	⑥ Electrical
Solid Surface (NAV)	Patterns: ARM Armadillo PEB Pebble Pearl BLP Black Pearl PUR Pure White	Flat Cut CH1 Cherry MA1 Maple WA1 Walnut	See list above for Cherry, Maple and Walnut Finishes	See list above for Paint Finishes	See list above for Metal Paint Colors	Cutout Codes: N all tables C1M 72" - 84" wide C1C 72" - 84" wide See chart on page 45 for cutout codes and power and storage unit configurations
Glass Surface (NAV)	Backpainted Glass: G White Glossy M White Matte					
Wood Plank (NAV)	W Wood Plank Ash, Clear Coat	Double Cut DC1 Double Cut	See list above for Double Cut Finishes			
Sub-Top w/Base (NAV)	B (Table Ships with Sub-Top, Customer applies custom Top)					

Description

View Peninsula Table with Panel Base

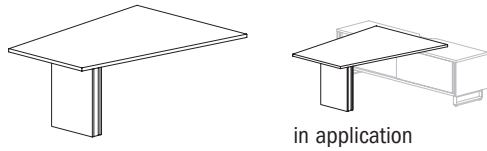

Laminate Tops "NAT" Models

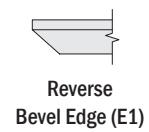
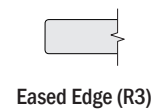

Features:

- must attach to 26" h Credenza, installation template included
- panel base with structural support rails
- narrow end of table is 36" d
- glass top has additional seams

D	W	H	CTN WT	CU FT	1 Model	HPL	HPL
54	84	29 3/8	192	55	NAT5484-30VTPPB	\$2,913	\$3,295
54	72	29 3/8	173	59	NAT5472-30VTPPB	\$2,841	\$3,221
54	60	29 3/8	150	55	NAT5460-30VTPPB	\$2,725	\$3,105

Options:

- metal base frame available in powder coat, no upcharge, or chrome, add \$1,126 list upcharge for 54" wide
- worksurface power & storage available, specify cutout code and order power units separately, see pages 150-151

NATIVE

Description

Standing Height View Peninsula Table with Panel Base

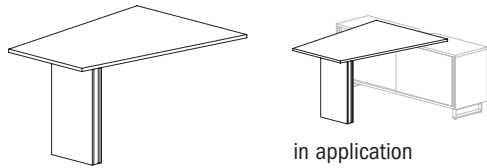

Laminate Tops "NAT" Models

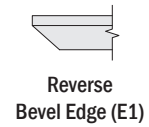
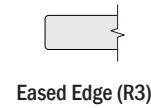

Features:

- must attach to 36" h Credenza, installation template included
- panel base with structural support rails
- narrow end of table is 36" d
- glass top has additional seams

D	W	H	CTN WT	CU FT	1 Model	HPL	HPL
54	84	40	207	55	NAT5484-40VTPPB	\$3,111	\$3,491
54	72	40	187	59	NAT5472-40VTPPB	\$3,025	\$3,406
54	60	40	187	55	NAT5460-40VTPPB	\$2,920	\$3,302

Options:

- metal base frame available in powder coat, no upcharge, or chrome, add \$1,170 list upcharge for 54" wide
- worksurface power & storage available, specify cutout code and order power units separately, see pages 150-151

To Order, Specify:

1 Laminate Model #	2a Top Laminate / 2b Base Laminate	3 Top Edge	4 Metal Color	5 Electrical
Laminate (NAT)	<p>Solid Patterns:</p> <p>ALB Alabaster BBL Bridal Bianco DWH Designer White SHD Shadow SLG Slate Grey</p> <p>Wood Grain Patterns:</p> <p>AGA Aged Ash    BGL Brighton Light    OAT Oatmeal Cookie ALL Ale Light    CLL Collectors    PIN Pinnacle Walnut BLO Blonde Echo    FLO Florence Walnut    STU Studio Teak BOL Bourbon Light    GRH Graphite    VIN Vintage BZW Brazilwood    HGL High Line    WLH Walnut Heights WEA Weathered Ash</p>	<p>Edge Selection:</p> <p>R3 Eased E1 Reverse Bevel</p>	<p>Color:</p> <p>ASL Arctic Silver BWH Bright White MBK Matte Black PEW Pewter SNK Soft Nickel RML Raw (Clear) CHR Chrome* *Upcharge applies</p>	<p>Cutout Codes:</p> <p>N all tables C1M 72" - 84" wide C1C 72" - 84" wide</p> <p>See chart on page 45 for cutout codes and power and storage unit configurations</p>

Description

View Peninsula Table with Panel Base  
(continued)

						Veneer Tops "NAV" Models				Premier Tops "NAV" Models			
						Eased Edge (R3)		Reverse Bevel Edge (E1)		Solid Surface/Glass Reverse Bevel Edge		Wood Plank Ash	
D	W	H	CTN WT	CU FT	1 Model	Flat Cut	Double Cut	Flat Cut	Double Cut	Solid Surface	Glass	Wood Plank Ash	Sub-Top with Base
54	84	29 3/8	192	55	NAV5484-30VTPPB	\$3,510	\$4,059	\$3,657	\$4,207	\$10,376	\$9,471	--	\$3,353
54	72	29 3/8	173	59	NAV5472-30VTPPB	\$3,421	\$3,955	\$3,569	\$4,101	\$9,588	\$8,530	--	\$3,268
54	60	29 3/8	150	55	NAV5460-30VTPPB	\$3,282	\$3,794	\$3,428	\$3,941	\$8,646	\$7,538	--	\$3,134

Description

Standing Height View Peninsula Table with Panel Base  
(continued)

						Veneer Tops "NAV" Models				Premier Tops "NAV" Models			
						Eased Edge (R3)		Reverse Bevel Edge (E1)		Solid Surface/Glass Reverse Bevel Edge		Wood Plank Ash	
D	W	H	CTN WT	CU FT	1 Model	Flat Cut	Double Cut	Flat Cut	Double Cut	Solid Surface	Glass	Wood Plank Ash	Sub-Top with Base
54	84	40	207	55	NAV5484-40VTPPB	\$3,747	\$4,331	\$3,893	\$4,479	\$10,613	\$9,708	--	\$3,579
54	72	40	187	59	NAV5472-40VTPPB	\$3,643	\$4,213	\$3,791	\$4,360	\$9,812	\$8,753	--	\$3,481
54	60	40	187	55	NAV5460-40VTPPB	\$3,518	\$4,068	\$3,666	\$4,215	\$8,883	\$7,776	--	\$3,361

To Order, Specify:

1 Veneer Model #	2 Wood Species	3 Top Wood Finish	4 Base Finish	5 Top Edge	6 Metal Color	7 Electrical		
Veneer (NAV)	Flat Cut CH1 Cherry MA1 Maple WA1 Walnut	Cherry: BRL Barley BBM Bourbon Medium BRM Brighton Medium CLA Classic CLL Collectors* EAR Earthy HRV Harvest* LGC Legacy PRL Praline* SAF Saffron Finishes with an asterisk (*) have a coordinating laminate available	Maple: ALM Ale Medium BUT Butterscotch CIN Cinnamon FLX Flax VEN Venetian	Walnut: AUB Auburn ESP Espresso MCH Mocha* NTO Night Owl* SIE Sienna* TOF Toffee TRF Truffle*	V - Same as Top Finish  P - Paint Color: BKD Backdrop BFX Black Fox BWH Bright White CGP Cargo Pants CHT Chatroom FRR French Roast GRV Greek Villa NET Network Gray NWH Nonchalant White STM Storm TRC Tricorn Black	Edge Selection: R3 Eased E1 Reverse Bevel	Color: ASL Arctic Silver BWH Bright White MBK Matte Black PEW Pewter SNK Soft Nickel RML Raw (Clear) CHR Chrome* *Upcharge applies	Cutout Codes: N all tables C1M 72" - 84" wide C1C 72" - 84" wide See chart on page 45 for cutout codes and power and storage unit configurations
	Double Cut DC1 Double Cut	3 Top Wood Finish Double Cut: COF Coffee FOS Fossil KHK Khaki CRM Cremello GRH Graphite STU Studio Teak						

1 Specialty Top Model #	2 Top Surface Selection	3 Base Wood Species	4a Base Wood Finish	4b Base Paint	5 Metal Color	6 Electrical
Solid Surface (NAV)	Patterns: ARM Armadillo PEB Pebble Pearl BLP Black Pearl PUR Pure White	Flat Cut CH1 Cherry MA1 Maple WA1 Walnut  Double Cut DC1 Double Cut	See list above for Cherry, Maple and Walnut Finishes	See list above for Paint Finishes	See list above for Metal Paint Colors	Cutout Codes: N all tables C1M 72" - 84" wide C1C 72" - 84" wide See chart on page 45 for cutout codes and power and storage unit configurations
Glass Surface (NAV)	Backpainted Glass: G White Glossy M White Matte					
Sub-Top w/Base (NAV)	B (Table Ships with Sub-Top, Customer applies custom Top)					



Description	D	W	H	CTN WT	CU FT	① Model	Laminate	Flat Cut Veneer	Double Cut Veneer
Storage Credenza	20	90	26	293	31	NAT2090-26SCD	\$3,850		
	20	90	26	293	31	NAV2090-26SCD		\$4,724	\$5,494
	20	72	26	228	25	NAT2072-26SCD	\$3,680		
	20	72	26	228	25	NAV2072-26SCD		\$4,515	\$5,251

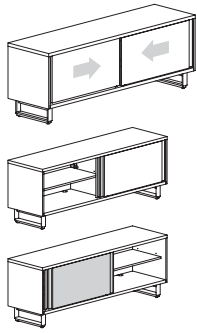

**Features:**

- sliding doors (non-locking)
- each compartment has one adjustable shelf

**Options:**

- metal available in powder coat, no upcharge, or chrome, add \$1,529 list upcharge
- laminate doors available in contrasting color, no upcharge, specify color; see page 33 for details
- veneer doors available in contrasting paint color, no upcharge, specify paint color; see page 33 for details

Power Storage Credenza	24	90	26	323	39	NAT2490-26PCD	\$4,636		
	24	90	26	323	39	NAV2490-26PCD		\$5,609	\$6,338
	24	72	26	253	32	NAT2472-26PCD	\$4,431		
	24	72	26	253	32	NAV2472-26PCD		\$5,370	\$6,072

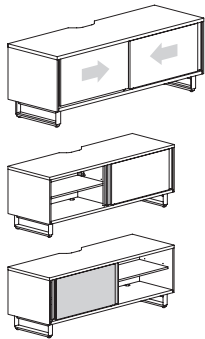

**Features:**

- sliding doors (non-locking)
- each compartment has one adjustable shelf
- power unit recessed in worksurface - ships installed

**Options:**

- metal available in powder coat, no upcharge, or chrome, add \$1,529 list upcharge
- laminate doors available in contrasting color, no upcharge, specify color; see page 33 for details
- veneer doors available in contrasting paint color, no upcharge, specify paint color; see page 33 for details

Open Storage Credenza	20	90	26	293	31	NAT2090-26SCO	\$3,899		
	20	90	26	293	31	NAV2090-26SCO		\$4,783	\$5,562
	20	72	26	228	25	NAT2072-26SCO	\$3,756		
	20	72	26	228	25	NAV2072-26SCO		\$4,607	\$5,358

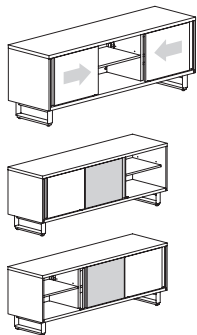

**Features:**

- sliding doors (non-locking) with open center compartment
- each compartment has one adjustable shelf

**Options:**

- metal available in powder coat, no upcharge, or chrome, add \$1,529 list upcharge
- laminate doors available in contrasting color, no upcharge, specify color; see page 33 for details
- veneer doors available in contrasting paint color, no upcharge, specify paint color; see page 33 for details

Power Open Storage Credenza	24	90	26	304	39	NAT2490-26PCO	\$4,618		
	24	90	26	304	39	NAV2490-26PCO		\$5,598	\$6,328
	24	72	26	253	32	NAT2472-26PCO	\$4,511		
	24	72	26	253	32	NAV2472-26PCO		\$5,466	\$6,179

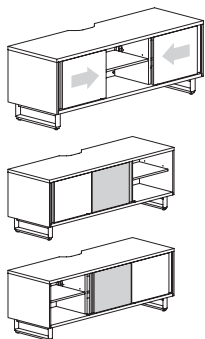

**Features:**

- sliding doors (non-locking) with open center compartment
- each compartment has one adjustable shelf
- power unit recessed in worksurface - ships installed

**Options:**

- metal available in powder coat, no upcharge, or chrome, add \$1,529 list upcharge
- laminate doors available in contrasting color, no upcharge, specify color; see page 33 for details
- veneer doors available in contrasting paint color, no upcharge, specify paint color; see page 33 for details

Description	D	W	H	CTN WT	CU FT	① Model	Laminate	Flat Cut Veneer	Double Cut Veneer
Buffet Credenza	20	90	36	346	45	NAT2090-36SCD	\$4,027		
	20	90	36	346	45	NAV2090-36SCD		\$4,909	\$5,711
	20	72	36	273	36	NAT2072-36SCD	\$3,817		
	20	72	36	273	36	NAV2072-36SCD		\$4,684	\$5,447

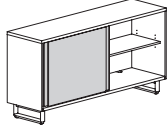
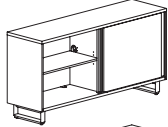
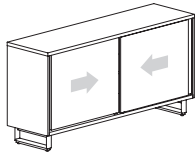

**Features:**

- sliding doors (non-locking)
- each compartment has one adjustable shelf

**Options:**

- metal available in powder coat, no upcharge, or chrome, add \$1,529 list upcharge
- laminate doors available in contrasting color, no upcharge, specify color; see page 33 for details
- veneer doors available in contrasting paint color, no upcharge, specify paint color; see page 33 for details

Description	D	W	H	CTN WT	CU FT	① Model	Laminate	Flat Cut Veneer	Double Cut Veneer
Power Buffet Credenza	24	90	36	378	49	NAT2490-36PCD	\$4,768		
	24	90	36	378	49	NAV2490-36PCD		\$5,780	\$6,533
	24	72	36	300	41	NAT2472-36PCD	\$4,575		
	24	72	36	300	41	NAV2472-36PCD		\$5,543	\$6,267

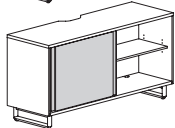
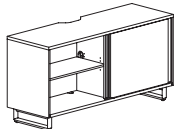
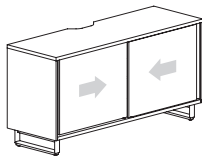

**Features:**

- sliding doors (non-locking)
- each compartment has one adjustable shelf
- power unit recessed in worksurface - ships installed

**Options:**

- metal available in powder coat, no upcharge, or chrome, add \$1,529 list upcharge
- laminate doors available in contrasting color, no upcharge, specify color; see page 33 for details
- veneer doors available in contrasting paint color, no upcharge, specify paint color; see page 33 for details

**To Order, Specify:**

① Laminate Model #	②a Chassis Laminate / ②b Door Front Laminate	③ Metal Color
Laminate (NAT)	<p>Solid Patterns:</p> <p>ALB Alabaster BBL Bridal Bianco DWH Designer White SHD Shadow SLG Slate Grey</p> <p>Wood Grain Patterns:</p> <p>AGA Aged Ash ALL Ale Light BLO Blonde Echo BOL Bourbon Light BZW Brazilwood</p> <p>BGL Brighton Light CLL Collectors FLO Florence Walnut GRH Graphite HGL High Line</p> <p>OAT Oatmeal Cookie PIN Pinnacle Walnut STU Studio Teak VIN Vintage WLH Walnut Heights WEA Weathered Ash</p>	<p>Color:</p> <p>ASL Arctic Silver BWH Bright White MBK Matte Black PEW Pewter SNK Soft Nickel RML Raw (Clear) CHR Chrome* *Upcharge applies</p>

① Veneer Model #	② Wood Species	③ Chassis Finish - Top	④ Door Front Paint	⑤ Metal Color
Veneer (NAV)	<p>Flat Cut</p> <p>CH1 Cherry MA1 Maple WA1 Walnut</p>	<p>Cherry:</p> <p>BRL Barley BBM Bourbon Medium BRM Brighton Medium CLA Classic CLL Collectors* EAR Earthy HRV Harvest* LGC Legacy PRL Praline* SAF Saffron</p> <p>Maple:</p> <p>ALM Ale Medium BUT Butterscotch CIN Cinnamon FLX Flax VEN Venetian</p> <p>Walnut:</p> <p>AUB Auburn ESP Espresso MCH Mocha* NTO Night Owl* SIE Sienna* TOF Toffee TRF Truffle*</p> <p>Finishes with an asterisk (*) have a coordinating laminate available</p>	<p>V - Same as Chassis</p> <p>P - Paint Color:</p> <p>BKD Backdrop BFX Black Fox BWH Bright White CGP Cargo Pants CHT Chatroom FRR French Roast GRV Greek Villa NET Network Gray NWH Nonchalant White STM Storm TRC Tricorn Black</p>	<p>Color:</p> <p>ASL Arctic Silver BWH Bright White MBK Matte Black PEW Pewter SNK Soft Nickel RML Raw (Clear) CHR Chrome* *Upcharge applies</p>
		<p>③ Wood Finish - Top</p> <p>Double Cut:</p> <p>COF Coffee FOS Fossil KHK Khaki CRM Cremello GRH Graphite STU Studio Teak</p>		

Description	D	W	H	CTN WT	CU FT	① Model	Laminate	Flat Cut Veneer	Double Cut Veneer
Buffet Credenza with Waste Drawer	20	90	36	380	45	NAT2090-36SCWR	\$4,885		
	20	90	36	380	45	NAV2090-36SCWR		\$5,957	\$6,928
	20	90	36	380	45	NAT2090-36SCWL	\$4,885		
	20	90	36	380	45	NAV2090-36SCWL		\$5,957	\$6,928
	20	72	36	314	36	NAT2072-36SCWR	\$4,858		
	20	72	36	314	36	NAV2072-36SCWR		\$5,923	\$6,889
	20	72	36	314	36	NAT2072-36SCWL	\$4,858		
	20	72	36	314	36	NAV2072-36SCWL		\$5,923	\$6,889

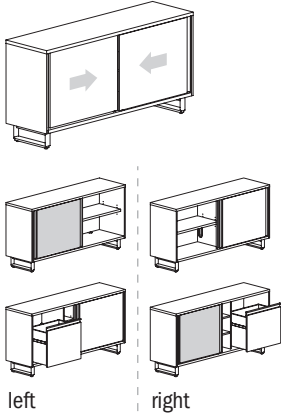

**Features:**

- sliding doors (non-locking)
- one side has one adjustable shelf, other side has waste drawer and cubbies (cubbies partially covered by door)
- waste drawer accommodates two Uline #S-13527 (10 gallon) trash cans, not included

**Options:**

- metal available in powder coat, no upcharge, or chrome, add \$1,529 list upcharge
- laminate doors available in contrasting color, no upcharge, specify color; see page 33 for details
- veneer doors available in contrasting paint color, no upcharge, specify paint color; see page 33 for details

Power Buffet Credenza with Waste Drawer	24	90	36	412	49	NAT2490-36PCWR	\$5,769		
	24	90	36	412	49	NAV2490-36PCWR		\$6,991	\$7,904
	24	90	36	412	49	NAT2490-36PCWL	\$5,769		
	24	90	36	412	49	NAV2490-36PCWL		\$6,991	\$7,904
	24	72	36	342	41	NAT2472-36PCWR	\$5,365		
	24	72	36	342	41	NAV2472-36PCWR		\$6,502	\$7,352
	24	72	36	342	41	NAT2472-36PCWL	\$5,365		
	24	72	36	342	41	NAV2472-36PCWL		\$6,502	\$7,352

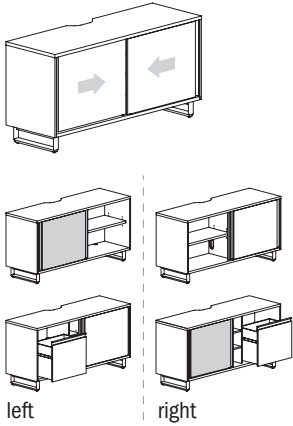

**Features:**

- sliding doors (non-locking)
- one side has one adjustable shelf, other side has waste drawer and cubbies (cubbies partially covered by door)
- waste drawer accommodates two Uline #S-13527 (10 gallon) trash cans, not included
- power unit recessed in worksurface - ships installed

**Options:**

- metal available in powder coat, no upcharge, or chrome, add \$1,529 list upcharge
- laminate doors available in contrasting color, no upcharge, specify color; see page 33 for details
- veneer doors available in contrasting paint color, no upcharge, specify paint color; see page 33 for details

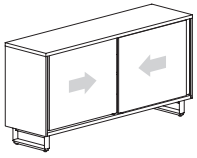
Description	D	W	H	CTN WT	CU FT	Model	Laminate	Flat Cut Veneer	Double Cut Veneer
Buffet Credenza with Utility Drawer 	20	90	36	344	45	NAT2090-36SCUR	\$4,632		
	20	90	36	344	45	NAV2090-36SCUR		\$5,649	\$6,569
	20	90	36	344	45	NAT2090-36SCUL	\$4,632		
	20	90	36	344	45	NAV2090-36SCUL		\$5,649	\$6,569
	20	72	36	284	36	NAT2072-36SCUR	\$4,453		
	20	72	36	284	36	NAV2072-36SCUR		\$5,430	\$6,315
	20	72	36	284	36	NAT2072-36SCUL	\$4,453		
	20	72	36	284	36	NAV2072-36SCUL		\$5,430	\$6,315

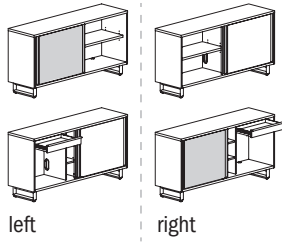

**Features:**

- sliding doors (non-locking)
- one side has one adjustable shelf, other side has utility drawer and cubbies (cubbies partially covered by door)

**Options:**

- metal available in powder coat, no upcharge, or chrome, add \$1,529 list upcharge
- laminate doors available in contrasting color, no upcharge, specify color; see page 33 for details
- veneer doors available in contrasting paint color, no upcharge, specify paint color; see page 33 for details

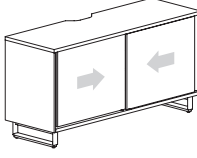
Description	D	W	H	CTN WT	CU FT	Model	Laminate	Flat Cut Veneer	Double Cut Veneer
Power Buffet Credenza with Utility Drawer 	24	90	36	376	49	NAT2490-36PCUR	\$5,390		
	24	90	36	376	49	NAV2490-36PCUR		\$6,533	\$7,385
	24	90	36	376	49	NAT2490-36PCUL	\$5,390		
	24	90	36	376	49	NAV2490-36PCUL		\$6,533	\$7,385
	24	72	36	306	41	NAT2472-36PCUR	\$5,110		
	24	72	36	306	41	NAV2472-36PCUR		\$6,192	\$7,000
	24	72	36	306	41	NAT2472-36PCUL	\$5,110		
	24	72	36	306	41	NAV2472-36PCUL		\$6,192	\$7,000

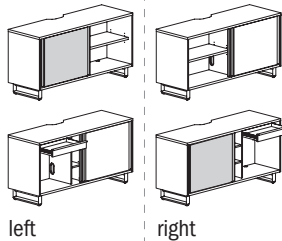

**Features:**

- sliding doors (non-locking)
- one side has one adjustable shelf, other side has utility drawer and cubbies (cubbies partially covered by door)
- power unit recessed in worksurface - ships installed

**Options:**

- metal available in powder coat, no upcharge, or chrome, add \$1,529 list upcharge
- laminate doors available in contrasting color, no upcharge, specify color; see page 33 for details
- veneer doors available in contrasting paint color, no upcharge, specify paint color; see page 33 for details

**To Order, Specify:**

1 Laminate Model #	2a Chassis Laminate / 2b Door Front Laminate	3 Metal Color
Laminate (NAT)	Solid Patterns: ALB Alabaster BBL Bridal Bianco DWH Designer White SHD Shadow SLG Slate Grey	Color: ASL Arctic Silver BWH Bright White MBK Matte Black PEW Pewter SNK Soft Nickel RML Raw (Clear) CHR Chrome* *Upcharge applies
	Wood Grain Patterns: AGA Aged Ash ALL Ale Light BLO Blonde Echo BOL Bourbon Light BZW Brazilwood BGL Brighton Light CLL Collectors FLO Florence Walnut GRH Graphite HGL High Line OAT Oatmeal Cookie PIN Pinnacle Walnut STU Studio Teak VIN Vintage WLH Walnut Heights WEA Weathered Ash	

1 Veneer Model #	2 Wood Species	3 Chassis Finish - Top	4 Door Front Paint	5 Metal Color
Veneer (NAV)	Flat Cut CH1 Cherry MA1 Maple WA1 Walnut	Cherry: BRL Barley BBM Bourbon Medium BRM Brighton Medium CLA Classic CLL Collectors* EAR Earthy HRV Harvest* LGC Legacy PRL Praline* SAF Saffron	V - Same as Chassis P - Paint Color: BKD Backdrop BFX Black Fox BWH Bright White CGP Cargo Pants CHT Chatroom FRR French Roast GRV Greek Villa NET Network Gray NWH Nonchalant White STM Storm TRC Tricorn Black	Color: ASL Arctic Silver BWH Bright White MBK Matte Black PEW Pewter SNK Soft Nickel RML Raw (Clear) CHR Chrome* *Upcharge applies
		Maple: ALM Ale Medium BUT Butterscotch CIN Cinnamon FLX Flax VEN Venetian		
		Walnut: AUB Auburn ESP Espresso MCH Mocha* NTO Night Owl* SIE Sienna* TOF Toffee TRF Truffle*		
		Finishes with an asterisk (*) have a coordinating laminate available		
		3 Wood Finish - Top		
	Double Cut DC1 Double Cut	Double Cut: COF Coffee FOS Fossil KHK Khaki CRM Cremello GRH Graphite STU Studio Teak		

Description	D	W	H	CTN WT	CU FT	① Model	Laminate	Flat Cut Veneer	Double Cut Veneer
Buffet Credenza with Utility Drawer and Waste Drawer	20	90	36	389	50	NAT2090-36SCULWR	\$5,197		
	20	90	36	389	50	NAV2090-36SCULWR		\$6,415	\$7,254
	20	90	36	389	50	NAT2090-36SCURWL	\$5,197		
	20	90	36	389	50	NAV2090-36SCURWL		\$6,415	\$7,254
	20	72	36	314	40	NAT2072-36SCULWR	\$5,060		
	20	72	36	314	40	NAV2072-36SCULWR		\$6,246	\$7,062
	20	72	36	314	40	NAT2072-36SCURWL	\$5,060		
	20	72	36	314	40	NAV2072-36SCURWL		\$6,246	\$7,062

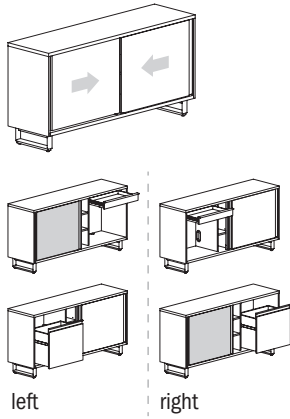

**Features:**

- sliding doors (non-locking)
- one side has utility drawer and cubbies, other side has waste drawer and cubbies (cubbies partially covered by door)
- waste drawer accommodates two Uline #S-13527 (10 gallon) trash cans, not included

**Options:**

- metal available in powder coat, no upcharge, or chrome, add \$1,529 list upcharge
- laminate doors available in contrasting color, no upcharge, specify color; see page 33 for details
- veneer doors available in contrasting paint color, no upcharge, specify paint color; see page 33 for details

Power Buffet Credenza with Utility Drawer and Waste Drawer	24	90	36	421	50	NAT2490-36PCULWR	\$6,023		
	24	90	36	421	50	NAV2490-36PCULWR		\$7,300	\$8,254
	24	90	36	421	50	NAT2490-36PCURWL	\$6,023		
	24	90	36	421	50	NAV2490-36PCURWL		\$7,300	\$8,254
	24	72	36	341	40	NAT2472-36PCULWR	\$5,847		
	24	72	36	341	40	NAV2472-36PCULWR		\$7,086	\$8,011
	24	72	36	341	40	NAT2472-36PCURWL	\$5,847		
	24	72	36	341	40	NAV2472-36PCURWL		\$7,086	\$8,011

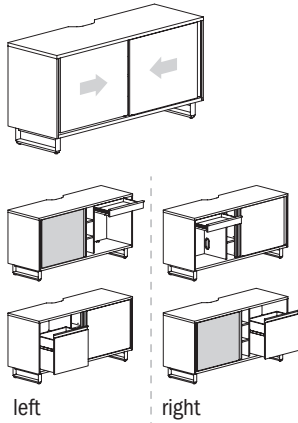

**Features:**

- sliding doors (non-locking)
- one side has utility drawer and cubbies, other side has waste drawer and cubbies (cubbies partially covered by door)
- waste drawer accommodates two Uline #S-13527 (10 gallon) trash cans, not included
- power unit recessed in worksurface - ships installed

**Options:**

- metal available in powder coat, no upcharge, or chrome, add \$1,529 list upcharge
- laminate doors available in contrasting color, no upcharge, specify color; see page 33 for details
- veneer doors available in contrasting paint color, no upcharge, specify paint color; see page 33 for details

Description	D	W	H	CTN WT	CU FT	① Model	Laminate	Flat Cut Veneer	Double Cut Veneer
	24	90	36	415	53	NAT2490-36AVCR	\$7,600		
	24	90	36	415	53	NAV2490-36AVCR		\$8,718	\$9,552
	24	90	36	415	53	NAT2490-36AVCL	\$7,600		
	24	90	36	415	53	NAV2490-36AVCL		\$8,718	\$9,552
	24	72	36	348	42	NAT2472-36AVCR	\$7,410		
	24	72	36	348	42	NAV2472-36AVCR		\$8,496	\$9,309
	24	72	36	348	42	NAT2472-36AVCL	\$7,410		
	24	72	36	348	42	NAV2472-36AVCL		\$8,496	\$9,309

**Features:**

- sliding doors (non-locking)
- one side has one adjustable shelf, other side has AV rack
- slide out and rotating AV rack included; provides easy rear access to equipment connections
- removable panel behind AV rack

**Options:**

- metal available in powder coat, no upcharge, or chrome, add \$1,529 list upcharge
- laminate doors available in contrasting color, no upcharge, specify color; see page 33 for details
- veneer doors available in contrasting paint color, no upcharge, specify paint color; see page 33 for details

**To Order, Specify:**

① Laminate Model #	②a Chassis Laminate / ②b Door Front Laminate	③ Metal Color
Laminate (NAT)	<p>Solid Patterns:</p> <p>ALB Alabaster BBL Bridal Bianco DWH Designer White SHD Shadow SLG Slate Grey</p> <p>Wood Grain Patterns:</p> <p>AGA Aged Ash ALL Ale Light BLO Blonde Echo BOL Bourbon Light BZW Brazilwood</p> <p>BGL Brighton Light CLL Collectors FLO Florence Walnut GRH Graphite HGL High Line</p> <p>OAT Oatmeal Cookie PIN Pinnacle Walnut STU Studio Teak VIN Vintage WLH Walnut Heights WEA Weathered Ash</p>	<p>Color:</p> <p>ASL Arctic Silver BWH Bright White MBK Matte Black PEW Pewter SNK Soft Nickel RML Raw (Clear) CHR Chrome* *Upcharge applies</p>

① Veneer Model #	② Wood Species	③ Chassis Finish - Top	④ Door Front Paint	⑤ Metal Color	
Veneer (NAV)	<p>Flat Cut</p> <p>CH1 Cherry MA1 Maple WA1 Walnut</p>	<p>Cherry:</p> <p>BRL Barley BBM Bourbon Medium BRM Brighton Medium CLA Classic CLL Collectors* EAR Earthy HRV Harvest* LGC Legacy PRL Praline* SAF Saffron</p> <p>Maple:</p> <p>ALM Ale Medium BUT Butterscotch CIN Cinnamon FLX Flax VEN Venetian</p> <p>Walnut:</p> <p>AUB Auburn ESP Espresso MCH Mocha* NTO Night Owl* SIE Sienna* TOF Toffee TRF Truffle*</p> <p>Finishes with an asterisk (*) have a coordinating laminate available</p>	<p>③ Wood Finish - Top</p> <p>Double Cut:</p> <p>COF Coffee FOS Fossil KHK Khaki CRM Cremello GRH Graphite STU Studio Teak</p>	<p>V - Same as Chassis</p> <p>P - Paint Color:</p> <p>BKD Backdrop BFX Black Fox BWH Bright White CGP Cargo Pants CHT Chatroom FRR French Roast GRV Greek Villa NET Network Gray NWH Nonchalant White STM Storm TRC Tricorn Black</p>	<p>Color:</p> <p>ASL Arctic Silver BWH Bright White MBK Matte Black PEW Pewter SNK Soft Nickel RML Raw (Clear) CHR Chrome* *Upcharge applies</p>

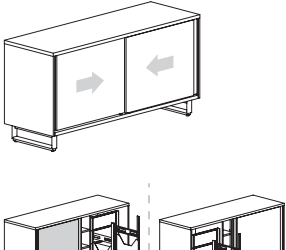
Description	D	W	H	CTN WT	CU FT	① Model	Laminate	Flat Cut Veneer	Double Cut Veneer
 <p>left right</p>	24	90	36	443	53	NAT2490-36AVWR	\$8,240		
	24	90	36	443	53	NAV2490-36AVWR		\$9,463	\$10,375
	24	90	36	443	53	NAT2490-36AVWL	\$8,240		
	24	90	36	443	53	NAV2490-36AVWL		\$9,463	\$10,375
	24	72	36	374	42	NAT2472-36AVWR	\$8,027		
	24	72	36	374	42	NAV2472-36AVWR		\$9,215	\$10,100
	24	72	36	374	42	NAT2472-36AVWL	\$8,027		
	24	72	36	374	42	NAV2472-36AVWL		\$9,215	\$10,100

**Features:**

- sliding doors (non-locking)
- one side has AV rack and cubbies, other side has waste drawer and cubbies (cubbies partially covered by door)
- slide out and rotating AV rack included; provides easy rear access to equipment connections
- removable panel behind AV rack

**Options:**

- waste drawer accommodates two Uline #S-13527 (10 gallon) trash cans, not included
- metal available in powder coat, no upcharge, or chrome, add \$1,529 list upcharge
- laminate doors available in contrasting color, no upcharge, specify color; see page 33 for details
- veneer doors available in contrasting paint color, no upcharge, specify paint color; see page 33 for details

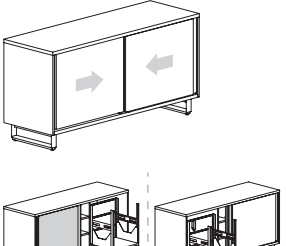
 <p>left right</p>	24	90	36	407	53	NAT2490-36AVUR	\$7,974		
	24	90	36	407	53	NAV2490-36AVUR		\$9,154	\$10,032
	24	90	36	407	53	NAT2490-36AVUL	\$7,974		
	24	90	36	407	53	NAV2490-36AVUL		\$9,154	\$10,032
	24	72	36	338	42	NAT2472-36AVUR	\$7,762		
	24	72	36	338	42	NAV2472-36AVUR		\$8,907	\$9,760
	24	72	36	338	42	NAT2472-36AVUL	\$7,762		
	24	72	36	338	42	NAV2472-36AVUL		\$8,907	\$9,760

**Features:**

- sliding doors (non-locking)
- one side has AV rack, other side has utility drawer and cubbies (cubbies partially covered by door)
- slide out and rotating AV rack included; provides easy rear access to equipment connections
- removable panel behind AV rack

**Options:**

- metal available in powder coat, no upcharge, or chrome, add \$1,529 list upcharge
- laminate doors available in contrasting color, no upcharge, specify color; see page 33 for details
- veneer doors available in contrasting paint color, no upcharge, specify paint color; see page 33 for details

Description	D	W	H	CTN WT	CU FT	① Model	Laminate	Flat Cut Veneer	Double Cut Veneer
Wall Storage Credenza	15	90	12	147	13	NAT1590-12WSC	\$2,367		
	15	90	12	147	13	NAV1590-12WSC		\$3,034	\$3,429
	15	72	12	122	11	NAT1572-12WSC	\$2,317		
	15	72	12	122	11	NAV1572-12WSC		\$2,969	\$3,356

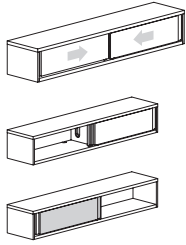

**Features:**

- sliding doors (non-locking)

**Options:**

- metal available in powder coat, no upcharge, or chrome, add \$284 list upcharge
- laminate doors available in contrasting color, no upcharge, specify color; see page 33 for details
- veneer doors available in contrasting paint color, no upcharge, specify paint color; see page 33 for details

**To Order, Specify:**

① Laminate Model #	②a Chassis Laminate / ②b Door Front Laminate	③ Metal Color
Laminate (NAT)	<p>Solid Patterns:</p> <p>ALB Alabaster BBL Bridal Bianco DWH Designer White SHD Shadow SLG Slate Grey</p> <p>Wood Grain Patterns:</p> <p>AGA Aged Ash ALL Ale Light BLO Blonde Echo BOL Bourbon Light BZW Brazilwood</p> <p>BGL Brighton Light CLL Collectors FLO Florence Walnut GRH Graphite HGL High Line</p> <p>OAT Oatmeal Cookie PIN Pinnacle Walnut STU Studio Teak VIN Vintage WLH Walnut Heights WEA Weathered Ash</p>	<p>Color:</p> <p>ASL Arctic Silver BWH Bright White MBK Matte Black PEW Pewter SNK Soft Nickel RML Raw (Clear) CHR Chrome* *Upcharge applies</p>

① Veneer Model #	② Wood Species	③ Chassis Finish - Top	④ Door Front Paint	⑤ Metal Color
Veneer (NAV)	<p>Flat Cut</p> <p>CH1 Cherry MA1 Maple WA1 Walnut</p>	<p>Cherry:</p> <p>BRL Barley BBM Bourbon Medium BRM Brighton Medium CLA Classic CLL Collectors* EAR Earthy HRV Harvest* LGC Legacy PRL Praline* SAF Saffron</p> <p>Maple:</p> <p>ALM Ale Medium BUT Butterscotch CIN Cinnamon FLX Flax VEN Venetian</p> <p>Walnut:</p> <p>AUB Auburn ESP Espresso MCH Mocha* NTO Night Owl* SIE Sienna* TOF Toffee TRF Truffle*</p> <p>Finishes with an asterisk (*) have a coordinating laminate available</p>	<p>V - Same as Chassis</p> <p>P - Paint Color:</p> <p>BKD Backdrop BFX Black Fox BWH Bright White CGP Cargo Pants CHT Chatroom FRR French Roast GRV Greek Villa NET Network Gray NWH Nonchalant White STM Storm TRC Tricorn Black</p>	<p>Color:</p> <p>ASL Arctic Silver BWH Bright White MBK Matte Black PEW Pewter SNK Soft Nickel RML Raw (Clear) CHR Chrome* *Upcharge applies</p>
		<p>③ Wood Finish - Top</p> <p>Double Cut:</p> <p>COF Coffee FOS Fossil KHK Khaki CRM Cremello GRH Graphite STU Studio Teak</p>		



Description

Rectangular Runoff Table with Open Loop Base

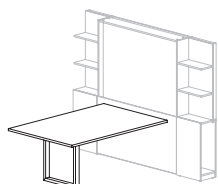
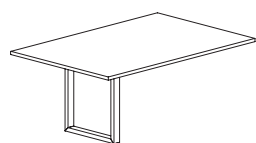

in application

Laminate Tops "NAT" Models

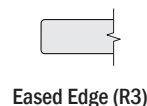

Eased Edge (R3)



Reverse Bevel Edge (E1)

Features:

- must attach to either a 74" Media Wall Space Divider without Media Shelf or a 74" Media Wall - Table Mount
- metal open loop base with structural support rails
- glass top has additional seams

Options:

- worksurface power & storage available, specify cutout code and order power units separately, see pages 150-151
- metal base frame available in powder coat, no upcharge, or chrome, add list upcharge: for 36" wide - \$849, for 42" & 48 wide - \$984, for 54 wide - \$1,126
- magnetic wire manager available; order separately, see page 150
- mounting brackets included

D	W	H	CTN WT	CU FT	① Model	HPL	HPL
54	60	29 3/8	162	52	NAT5460-30TTRLB	\$2,706	\$3,087
48	84	29 3/8	187	43	NAT4884-30TTRLB	\$2,733	\$3,115
48	72	29 3/8	166	29	NAT4872-30TTRLB	\$2,668	\$3,047
48	60	29 3/8	142	36	NAT4860-30TTRLB	\$2,559	\$2,941
42	84	29 3/8	170	37	NAT4284-30TTRLB	\$2,685	\$3,067
42	72	29 3/8	152	43	NAT4272-30TTRLB	\$2,629	\$3,009
42	60	29 3/8	129	32	NAT4260-30TTRLB	\$2,503	\$2,885
36	84	29 3/8	150	42	NAT3684-30TTRLB	\$2,640	\$3,022
36	72	29 3/8	131	34	NAT3672-30TTRLB	\$2,587	\$2,969
36	60	29 3/8	114	42	NAT3660-30TTRLB	\$2,492	\$2,874

NATIVE

To Order, Specify:

① Laminate Model #	② Top Laminate	③ Top Edge	④ Metal Color	⑤ Electrical
Laminate (NAT)	<p>Solid Patterns:</p> <p>ALB Alabaster BBL Bridal Bianco DWH Designer White SHD Shadow SLG Slate Grey</p> <p>Wood Grain Patterns:</p> <p>AGA Aged Ash ALL Ale Light BLO Blonde Echo BOL Bourbon Light BZW Brazilwood</p> <p>BGL Brighton Light CLL Collectors FLO Florence Walnut GRH Graphite HGL High Line</p> <p>OAT Oatmeal Cookie PIN Pinnacle Walnut STU Studio Teak VIN Vintage WLH Walnut Heights WEA Weathered Ash</p>	<p>Edge Selection:</p> <p>R3 Eased E1 Reverse Bevel</p>	<p>Color:</p> <p>ASL Arctic Silver BWH Bright White MBK Matte Black PEW Pewter SNK Soft Nickel RML Raw (Clear) CHR Chrome* *Upcharge applies</p>	<p>Cutout Codes:</p> <p>N all tables C1M 72" - 84" wide C1C 72" - 84" wide</p> <p>See chart on page 45 for cutout codes and power and storage unit configurations</p>

Description

Rectangular Runoff Table  
with Open Loop Base  
(continued)

						Veneer Tops "NAV" Models				Premier Tops "NAV" Models			
						Eased Edge (R3)		Reverse Bevel Edge (E1)		Solid Surface/Glass Reverse Bevel Edge		Wood Plank Ash	
D	W	H	CTN WT	CU FT	① Model	Flat Cut	Double Cut	Flat Cut	Double Cut	Solid Surface	Glass	Wood Plank Ash	Custom Sub-Base
54	60	29 3/8	162	52	NAV5460-30TTRLB	\$3,220	\$3,651	\$3,367	\$3,798	\$8,585	\$7,478	--	\$3,076
48	84	29 3/8	187	43	NAV4884-30TTRLB	\$3,252	\$3,745	\$3,399	\$3,891	\$9,355	\$8,551	\$7,017	\$3,105
48	72	29 3/8	166	29	NAV4872-30TTRLB	\$3,174	\$3,599	\$3,321	\$3,746	\$8,461	\$7,716	\$6,402	\$3,032
48	60	29 3/8	142	36	NAV4860-30TTRLB	\$3,045	\$3,405	\$3,193	\$3,552	\$7,515	\$6,831	\$5,734	\$2,909
42	84	29 3/8	170	37	NAV4284-30TTRLB	\$3,196	\$3,632	\$3,344	\$3,778	\$8,586	\$7,834	\$6,492	\$3,054
42	72	29 3/8	152	43	NAV4272-30TTRLB	\$3,128	\$3,504	\$3,275	\$3,650	\$7,802	\$7,103	\$5,952	\$2,987
42	60	29 3/8	129	32	NAV4260-30TTRLB	\$2,979	\$3,295	\$3,126	\$3,442	\$6,938	\$6,291	\$5,332	\$2,846
36	84	29 3/8	150	42	NAV3684-30TTRLB	\$3,141	\$3,520	\$3,288	\$3,668	\$7,817	\$7,115	\$5,964	\$3,001
36	72	29 3/8	131	34	NAV3672-30TTRLB	\$3,079	\$3,406	\$3,227	\$3,553	\$7,143	\$6,487	\$5,501	\$2,942
36	60	29 3/8	114	42	NAV3660-30TTRLB	\$2,967	\$3,243	\$3,115	\$3,389	\$6,415	\$5,805	\$4,984	\$2,834

NATIVE

To Order, Specify:

① Veneer Model #	② Wood Species	③ Top Wood Finish	④ Top Edge	⑤ Metal Color	⑥ Electrical
Veneer (NAV)	<p>Flat Cut</p> <p>CH1 Cherry MA1 Maple WA1 Walnut</p>	<p>Cherry: BRL Barley BBM Bourbon Medium BRM Brighton Medium CLA Classic CLL Collectors* EAR Earthy HRV Harvest* LGC Legacy PRL Praline* SAF Saffron</p> <p>Maple: ALM Ale Medium BUT Butterscotch CIN Cinnamon FLX Flax VEN Venetian</p> <p>Walnut: AUB Auburn ESP Espresso MCH Mocha* NTO Night Owl* SIE Sienna* TOF Toffee TRF Truffle*</p> <p>Finishes with an asterisk (*) have a coordinating laminate available</p>	<p>Edge Selection:</p> <p>R3 Eased E1 Reverse Bevel</p>	<p>Color:</p> <p>ASL Arctic Silver BWH Bright White MBK Matte Black PEW Pewter SNK Soft Nickel RML Raw (Clear) CHR Chrome* *Upcharge applies</p>	<p>Cutout Codes:</p> <p>N all tables C1M 72" - 84" wide C1C 72" - 84" wide See chart on page 45 for cutout codes and power and storage unit configurations</p>
	<p>Double Cut</p> <p>DC1 Double Cut</p>	<p>③ Top Wood Finish</p> <p>Double Cut: COF Coffee FOS Fossil KHK Khaki CRM Cremello GRH Graphite STU Studio Teak</p>			

① Specialty Top Model #	② Top Surface Selection	③ Metal Color	④ Electrical
Solid Surface (NAV)	<p>Patterns:</p> <p>ARM Armadillo PEB Pebble Pearl BLP Black Pearl PUR Pure White</p>	See list above for Metal Paint Colors	<p>Cutout Codes:</p> <p>N all tables C1M 72" - 84" wide C1C 72" - 84" wide See chart on page 45 for cutout codes and power and storage unit configurations</p>
Glass Surface (NAV)	<p>Backpainted Glass:</p> <p>G White Glossy M White Matte</p>		
Wood Plank (NAV)	W Wood Plank Ash, Clear Coat		
Sub-Top w/Base (NAV)	B (Table Ships with Sub-Top, Customer applies custom Top)		

Description

Standing Height Rectangular Runoff Table with Open Loop Base

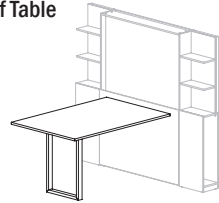
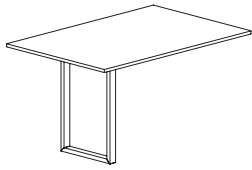

in application

Laminate Tops "NAT" Models



Eased Edge (R3)



Reverse Bevel Edge (E1)

Features:

- must attach to either a 84" Media Wall Space Divider without Media Shelf or a 84" Media Wall - Table Mount
- metal open loop base with structural support rails
- glass top has additional seams

Options:

- worksurface power & storage available, specify cutout code and order power units separately, see pages 150-151
- metal base frame available in powder coat, no upcharge, or chrome, add list upcharge: for 36" wide - \$935, for 42" & 48 wide - \$1,082, for 54 wide - \$1,170
- magnetic wire manager available; order separately, see page 150
- mounting brackets included

D	W	H	CTN WT	CU FT	① Model	HPL	HPL
54	60	40	157	52	NAT5460-40TTRLB	\$2,674	\$3,056
48	84	40	193	46	NAT4884-40TTRLB	\$2,700	\$3,082
48	72	40	177	40	NAT4872-40TTRLB	\$2,636	\$3,016
48	60	40	147	35	NAT4860-40TTRLB	\$2,528	\$2,910
42	84	40	194	38	NAT4284-40TTRLB	\$2,654	\$3,036
42	72	40	157	53	NAT4272-40TTRLB	\$2,596	\$2,978
42	60	40	135	38	NAT4260-40TTRLB	\$2,497	\$2,879
36	84	40	155	33	NAT3684-40TTRLB	\$2,313	\$2,694
36	72	40	139	32	NAT3672-40TTRLB	\$2,557	\$2,939
36	60	40	120	35	NAT3660-40TTRLB	\$2,463	\$2,845

To Order, Specify:

① Laminate Model #	② Top Laminate	③ Top Edge	④ Metal Color	⑤ Electrical
Laminate (NAT)	<p>Solid Patterns:</p> <p>ALB Alabaster BBL Bridal Bianco DWH Designer White SHD Shadow SLG Slate Grey</p> <p>Wood Grain Patterns:</p> <p>AGA Aged Ash ALL Ale Light BLO Blonde Echo BOL Bourbon Light BZW Brazilwood</p> <p>BGL Brighton Light CLL Collectors FLO Florence Walnut GRH Graphite HGL High Line</p> <p>OAT Oatmeal Cookie PIN Pinnacle Walnut STU Studio Teak VIN Vintage WLH Walnut Heights WEA Weathered Ash</p>	<p>Edge Selection:</p> <p>R3 Eased E1 Reverse Bevel</p>	<p>Color:</p> <p>ASL Arctic Silver BWH Bright White MBK Matte Black PEW Pewter SNK Soft Nickel RML Raw (Clear) CHR Chrome* *Upcharge applies</p>	<p>Cutout Codes:</p> <p>N all tables C1M 72" - 84" wide C1C 72" - 84" wide See chart on page 45 for cutout codes and power and storage unit configurations</p>

Description

Standing Height Rectangular Runoff Table with Open Loop Base (continued)

						Veneer Tops "NAV" Models				Premier Tops "NAV" Models			
						Eased Edge (R3)		Reverse Bevel Edge (E1)		Solid Surface/Glass Reverse Bevel Edge			
D	W	H	CTN WT	CU FT	① Model	Flat Cut	Double Cut	Flat Cut	Double Cut	Solid Surface	Glass	Wood Plank Ash	Custom Sub-Base
54	60	40	157	52	NAV5460-40TRLB	\$3,220	\$3,651	\$3,367	\$3,798	\$8,585	\$7,478	--	\$3,076
48	84	40	193	46	NAV4884-40TRLB	\$3,252	\$3,745	\$3,399	\$3,891	\$9,355	\$8,551	\$7,017	\$3,105
48	72	40	177	40	NAV4872-40TRLB	\$3,174	\$3,599	\$3,321	\$3,746	\$8,461	\$7,716	\$6,402	\$3,032
48	60	40	147	35	NAV4860-40TRLB	\$3,045	\$3,405	\$3,193	\$3,552	\$7,515	\$6,831	\$5,734	\$2,909
42	84	40	194	38	NAV4284-40TRLB	\$3,196	\$3,632	\$3,344	\$3,778	\$8,586	\$7,834	\$6,492	\$3,054
42	72	40	157	53	NAV4272-40TRLB	\$3,128	\$3,504	\$3,275	\$3,650	\$7,802	\$7,103	\$5,952	\$2,987
42	60	40	135	38	NAV4260-40TRLB	\$3,007	\$3,324	\$3,155	\$3,470	\$6,967	\$6,319	\$5,361	\$2,873
36	84	40	155	33	NAV3684-40TRLB	\$2,786	\$3,164	\$2,933	\$3,312	\$7,463	\$6,760	\$5,609	\$2,661
36	72	40	139	32	NAV3672-40TRLB	\$3,079	\$3,406	\$3,227	\$3,553	\$7,143	\$6,487	\$5,501	\$2,942
36	60	40	120	35	NAV3660-40TRLB	\$2,967	\$3,243	\$3,115	\$3,389	\$6,415	\$5,805	\$4,984	\$2,834

NATIVE

To Order, Specify:

① Veneer Model #	② Wood Species	③ Top Wood Finish	④ Top Edge	⑤ Metal Color	⑥ Electrical
Veneer (NAV)	<p>Flat Cut</p> <p>CH1 Cherry MA1 Maple WA1 Walnut</p>	<p>Cherry: BRL Barley BBM Bourbon Medium BRM Brighton Medium CLA Classic CLL Collectors* EAR Earthy HRV Harvest* LGC Legacy PRL Praline* SAF Saffron</p> <p>Maple: ALM Ale Medium BUT Butterscotch CIN Cinnamon FLX Flax VEN Venetian</p> <p>Walnut: AUB Auburn ESP Espresso MCH Mocha* NTO Night Owl* SIE Sienna* TOF Toffee TRF Truffle*</p> <p>Finishes with an asterisk (*) have a coordinating laminate available</p>	<p>Edge Selection:</p> <p>R3 Eased E1 Reverse Bevel</p>	<p>Color:</p> <p>ASL Arctic Silver BWH Bright White MBK Matte Black PEW Pewter SNK Soft Nickel RML Raw (Clear) CHR Chrome* *Upcharge applies</p>	<p>Cutout Codes:</p> <p>N all tables C1M 72" - 84" wide C1C 72" - 84" wide See chart on page 45 for cutout codes and power and storage unit configurations</p>
	<p>Double Cut</p> <p>DC1 Double Cut</p>	<p>③ Top Wood Finish</p> <p>Double Cut: COF Coffee FOS Fossil KHK Khaki CRM Cremello GRH Graphite STU Studio Teak</p>			

① Specialty Top Model #	② Top Surface Selection	③ Metal Color	④ Electrical
Solid Surface (NAV)	<p>Patterns:</p> <p>ARM Armadillo PEB Pebble Pearl BLP Black Pearl PUR Pure White</p>	See list above for Metal Paint Colors	<p>Cutout Codes:</p> <p>N all tables C1M 72" - 84" wide C1C 72" - 84" wide</p>
Glass Surface (NAV)	<p>Backpainted Glass:</p> <p>G White Glossy M White Matte</p>		
Wood Plank (NAV)	W Wood Plank Ash, Clear Coat		
Sub-Top w/Base (NAV)	B (Table Ships with Sub-Top, Customer applies custom Top)		

Description

View Runoff Table with Open Loop Base

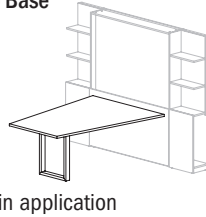
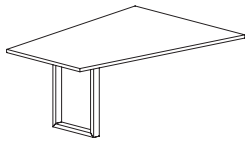

in application

Laminate Tops "NAT" Models

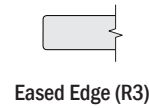

Eased Edge (R3)



Reverse Bevel Edge (E1)

Features:

- must attach to either a 74" Media Wall Space Divider without Media Shelf or a 74" Media Wall - Table Mount
- metal open loop base with structural support rails
- narrow end of table is 36"d
- glass top has additional seams

Options:

- metal base frame available in powder coat, no upcharge, or chrome, add \$1,170 list upcharge for 54" wide
- worksurface power & storage available, specify cutout code and order power units separately, see pages 150-151
- mounting brackets included

D	W	H	CTN WT	CU FT	① Model	HPL	HPL
54	84	29 3/8	175	51	NAT5484-30VTRLB	\$2,714	\$3,096
54	72	29 3/8	156	40	NAT5472-30VTRLB	\$2,640	\$3,022
54	60	29 3/8	134	52	NAT5460-30VTRLB	\$2,537	\$2,918

NATIVE

Description

Standing Height View Runoff Table with Open Loop Base

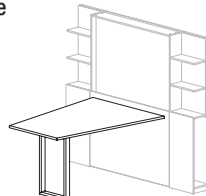
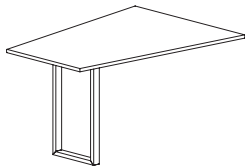

in application

Laminate Tops "NAT" Models

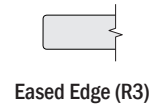

Eased Edge (R3)



Reverse Bevel Edge (E1)

Features:

- must attach to either a 84" Media Wall Space Divider without Media Shelf or a 84" Media Wall - Table Mount
- metal open loop base with structural support rails
- narrow end of table is 36"d
- glass top has additional seams

Options:

- metal base frame available in powder coat, no upcharge, or chrome, add \$1,170 list upcharge for 54" wide
- worksurface power & storage available, specify cutout code and order power units separately, see pages 150-151
- mounting brackets included

D	W	H	CTN WT	CU FT	① Model	HPL	HPL
54	84	40	181	54	NAT5484-40VTRLB	\$2,896	\$3,278
54	72	40	163	47	NAT5472-40VTRLB	\$2,823	\$3,205
54	60	40	138	52	NAT5460-40VTRLB	\$2,749	\$3,130

To Order, Specify:

① Laminate Model #	②a Top Laminate / ②b Base Laminate	③ Top Edge	④ Metal Color	⑤ Electrical
Laminate (NAT)	<p>Solid Patterns:</p> <p>ALB Alabaster BBL Bridal Bianco DWH Designer White SHD Shadow SLG Slate Grey</p> <p>Wood Grain Patterns:</p> <p>AGA Aged Ash ALL Ale Light BLO Blonde Echo BOL Bourbon Light BZW Brazilwood</p> <p>BGL Brighton Light CLL Collectors FLO Florence Walnut GRH Graphite HGL High Line</p> <p>OAT Oatmeal Cookie PIN Pinnacle Walnut STU Studio Teak VIN Vintage WLH Walnut Heights WEA Weathered Ash</p>	<p>Edge Selection:</p> <p>R3 Eased E1 Reverse Bevel</p>	<p>Color:</p> <p>ASL Arctic Silver BWH Bright White MBK Matte Black PEW Pewter SNK Soft Nickel RML Raw (Clear) CHR Chrome* *Upcharge applies</p>	<p>Cutout Codes:</p> <p>N all tables C1M 72" - 84" wide C1C 72" - 84" wide</p> <p>See chart on page 45 for cutout codes and power and storage unit configurations</p>

Description

View Runoff Table with Open Loop Base  
(continued)

						Veneer Tops "NAV" Models				Premier Tops "NAV" Models			
						Eased Edge (R3)		Reverse Bevel Edge (E1)		Solid Surface/Glass Reverse Bevel Edge		Wood Plank Ash	
D	W	H	CTN WT	CU FT	① Model	Flat Cut	Double Cut	Flat Cut	Double Cut	Solid Surface	Glass	Wood Plank Ash	Custom Sub-Base
54	84	29 3/8	175	51	NAV5484-30VTRLB	\$3,230	\$3,786	\$3,378	\$3,934	\$10,097	\$9,192	--	\$3,086
54	72	29 3/8	156	40	NAV5472-30VTRLB	\$3,142	\$3,638	\$3,289	\$3,785	\$9,311	\$8,253	--	\$3,002
54	60	29 3/8	134	52	NAV5460-30VTRLB	\$3,019	\$3,450	\$3,165	\$3,598	\$8,384	\$7,277	--	\$2,884

Description

Standing Height View Runoff Table with Open Loop Base  
(continued)

						Veneer Tops "NAV" Models				Premier Tops "NAV" Models			
						Eased Edge (R3)		Reverse Bevel Edge (E1)		Solid Surface/Glass Reverse Bevel Edge		Wood Plank Ash	
D	W	H	CTN WT	CU FT	① Model	Flat Cut	Double Cut	Flat Cut	Double Cut	Solid Surface	Glass	Wood Plank Ash	Custom Sub-Base
54	84	40	181	54	NAV5484-40VTRLB	\$3,448	\$4,003	\$3,596	\$4,151	\$10,314	\$9,409	--	\$3,293
54	72	40	163	47	NAV5472-40VTRLB	\$3,360	\$3,855	\$3,507	\$4,002	\$9,527	\$8,469	--	\$3,209
54	60	40	138	52	NAV5460-40VTRLB	\$3,271	\$3,702	\$3,419	\$3,849	\$8,637	\$7,529	--	\$3,124

To Order, Specify:

① Veneer Model #	② Wood Species	③ Top Wood Finish	④ Base Finish	⑤ Top Edge	⑥ Metal Color	⑦ Electrical		
Veneer (NAV)	<b>Flat Cut</b> CH1 Cherry MA1 Maple WA1 Walnut	Cherry: BRL Barley BBM Bourbon Medium BRM Brighton Medium CLA Classic CLL Collectors* EAR Earthy HRV Harvest* LGC Legacy PRL Praline* SAF Saffron Finishes with an asterisk (*) have a coordinating laminate available	Maple: ALM Ale Medium BUT Butterscotch CIN Cinnamon FLX Flax VEN Venetian	Walnut: AUB Auburn ESP Espresso MCH Mocha* NTO Night Owl* SIE Sienna* TOF Toffee TRF Truffle*	V - Same as Top Finish  P - Paint Color: BKD Backdrop BFX Black Fox BWH Bright White CGP Cargo Pants CHT Chatroom FRR French Roast GRV Greek Villa NET Network Gray NWH Nonchalant White STM Storm TRC Tricorn Black	Edge Selection: R3 Eased E1 Reverse Bevel	Color: ASL Arctic Silver BWH Bright White MBK Matte Black PEW Pewter SNK Soft Nickel RML Raw (Clear) CHR Chrome* *Upcharge applies	Cutout Codes: N all tables C1M 72" - 84" wide C1C 72" - 84" wide See chart on page 45 for cutout codes and power and storage unit configurations
		<b>Double Cut</b> DC1 Double Cut	<b>③ Top Wood Finish</b> Double Cut: COF Coffee FOS Fossil KHK Khaki CRM Cremello GRH Graphite STU Studio Teak					

① Specialty Top Model #	② Top Surface Selection	③ Base Wood Species	④a Base Wood Finish	④b Base Paint	⑤ Metal Color	⑥ Electrical
Solid Surface (NAV)	Patterns: ARM Armadillo PEB Pebble Pearl BLP Black Pearl PUR Pure White	<b>Flat Cut</b> CH1 Cherry MA1 Maple WA1 Walnut  <b>Double Cut</b> DC1 Double Cut	See list above for Cherry, Maple and Walnut Finishes	See list above for Paint Finishes	See list above for Metal Paint Colors	Cutout Codes: N all tables C1M 72" - 84" wide C1C 72" - 84" wide
Glass Surface (NAV)	Backpainted Glass: G White Glossy M White Matte					
Sub-Top w/Base (NAV)	B (Table Ships with Sub-Top, Customer applies custom Top)					

Description

Rectangular Runoff Table with Panel Base

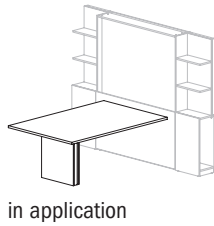
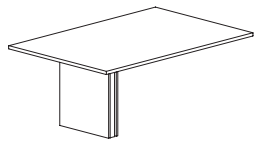

Laminate Tops "NAT" Models

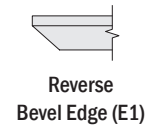
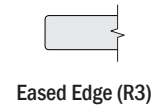

Features:

- must attach to either a 74" Media Wall Space Divider without Media Shelf or a 74" Media Wall - Table Mount
- panel base with structural support rails
- glass top has additional seams

Options:

- worksurface power & storage available, specify cutout code and order power units separately, see pages 150-151
- metal base frame available in powder coat, no upcharge, or chrome, add list upcharge: for 36" wide - \$849, for 42" & 48 wide - \$984, for 54 wide - \$1,126
- mounting brackets included

D	W	H	CTN WT	CU FT	① Model	HPL	HPL
54	60	29 3/8	181	54	NAT5460-30TTRPB	\$2,904	\$3,285
48	84	29 3/8	208	43	NAT4884-30TTRPB	\$2,924	\$3,305
48	72	29 3/8	190	40	NAT4872-30TTRPB	\$2,860	\$3,240
48	60	29 3/8	162	36	NAT4860-30TTRPB	\$3,025	\$3,406
42	84	29 3/8	190	37	NAT4284-30TTRPB	\$2,879	\$3,259
42	72	29 3/8	156	38	NAT4272-30TTRPB	\$2,821	\$3,202
42	60	29 3/8	150	32	NAT4260-30TTRPB	\$2,721	\$3,102
36	84	29 3/8	167	42	NAT3684-30TTRPB	\$2,522	\$2,904
36	72	29 3/8	151	34	NAT3672-30TTRPB	\$2,766	\$3,148
36	60	29 3/8	131	42	NAT3660-30TTRPB	\$2,649	\$3,030

NATIVE

To Order, Specify:

① Laminate Model #	②a Top Laminate / ②b Base Laminate	③ Top Edge	④ Metal Color	⑤ Electrical
Laminate (NAT)	<p>Solid Patterns:</p> <p>ALB Alabaster BBL Bridal Bianco DWH Designer White SHD Shadow SLG Slate Grey</p> <p>Wood Grain Patterns:</p> <p>AGA Aged Ash ALL Ale Light BLO Blonde Echo BOL Bourbon Light BZW Brazilwood</p> <p>BGL Brighton Light CLL Collectors FLO Florence Walnut GRH Graphite HGL High Line</p> <p>OAT Oatmeal Cookie PIN Pinnacle Walnut STU Studio Teak VIN Vintage WLH Walnut Heights WEA Weathered Ash</p>	<p>Edge Selection:</p> <p>R3 Eased E1 Reverse Bevel</p>	<p>Color:</p> <p>ASL Arctic Silver BWH Bright White MBK Matte Black PEW Pewter SNK Soft Nickel RML Raw (Clear) CHR Chrome* *Upcharge applies</p>	<p>Cutout Codes:</p> <p>N all tables C1M 72" - 84" wide C1C 72" - 84" wide</p> <p>See chart on page 45 for cutout codes and power and storage unit configurations</p>

Description

Rectangular Runoff Table with Panel Base  
(continued)

						Veneer Tops "NAV" Models				Premier Tops "NAV" Models			
						Eased Edge (R3)		Reverse Bevel Edge (E1)		Solid Surface/Glass Reverse Bevel Edge			
D	W	H	CTN WT	CU FT	Model	Flat Cut	Double Cut	Flat Cut	Double Cut	Solid Surface	Glass	Wood Plank Ash	Custom Sub-Base
54	60	29 3/8	181	54	NAV5460-30TTRPB	\$3,497	\$4,044	\$3,644	\$4,191	\$8,862	\$7,755	--	\$3,341
48	84	29 3/8	208	43	NAV4884-30TTRPB	\$3,521	\$4,095	\$3,669	\$4,243	\$9,624	\$8,820	\$7,287	\$3,364
48	72	29 3/8	190	40	NAV4872-30TTRPB	\$3,445	\$4,005	\$3,591	\$4,153	\$8,732	\$7,986	\$6,672	\$3,290
48	60	29 3/8	162	36	NAV4860-30TTRPB	\$3,642	\$4,237	\$3,790	\$4,384	\$8,111	\$7,428	\$6,332	\$3,480
42	84	29 3/8	190	37	NAV4284-30TTRPB	\$3,467	\$4,033	\$3,614	\$4,180	\$8,857	\$8,104	\$6,761	\$3,312
42	72	29 3/8	156	38	NAV4272-30TTRPB	\$3,398	\$3,953	\$3,545	\$4,099	\$8,072	\$7,373	\$6,222	\$3,246
42	60	29 3/8	150	32	NAV4260-30TTRPB	\$3,277	\$3,811	\$3,424	\$3,959	\$7,236	\$6,589	\$5,630	\$3,130
36	84	29 3/8	167	42	NAV3684-30TTRPB	\$3,037	\$3,533	\$3,184	\$3,679	\$7,714	\$7,012	\$5,861	\$2,902
36	72	29 3/8	151	34	NAV3672-30TTRPB	\$3,331	\$3,874	\$3,479	\$4,022	\$7,394	\$6,738	\$5,752	\$3,182
36	60	29 3/8	131	42	NAV3660-30TTRPB	\$3,191	\$3,711	\$3,339	\$3,859	\$6,639	\$6,029	\$5,208	\$3,047

NATIVE

To Order, Specify:

1 Veneer Model #	2 Wood Species	3 Top Wood Finish	4 Base Finish	5 Top Edge	6 Metal Color	7 Electrical		
Veneer (NAV)	Flat Cut CH1 Cherry MA1 Maple WA1 Walnut	Cherry: BRL Barley BBM Bourbon Medium BRM Brighton Medium CLA Classic CLL Collectors* EAR Earthy HRV Harvest* LGC Legacy PRL Praline* SAF Saffron	Maple: ALM Ale Medium BUT Butterscotch CIN Cinnamon FLX Flax VEN Venetian	Walnut: AUB Auburn ESP Espresso MCH Mocha* NTO Night Owl* SIE Sienna* TOF Toffee TRF Truffle*	V - Same as Top Finish  P - Paint Color: BKD Backdrop BFX Black Fox BWH Bright White CGP Cargo Pants CHT Chatroom FRR French Roast GRV Greek Villa NET Network Gray NWH Nonchalant White STM Storm TRC Tricorn Black	Edge Selection: R3 Eased E1 Reverse Bevel	Color: ASL Arctic Silver BWH Bright White MBK Matte Black PEW Pewter SNK Soft Nickel RML Raw (Clear) CHR Chrome* *Upcharge applies	Cutout Codes: N all tables C1M 72" - 84" wide C1C 72" - 84" wide See chart on page 45 for cutout codes and power and storage unit configurations
		Double Cut DC1 Double Cut	3 Top Wood Finish Double Cut: COF Coffee FOS Fossil KHK Khaki CRM Cremello GRH Graphite STU Studio Teak					

1 Specialty Top Model #	2 Top Surface Selection	3 Base Wood Species	4a Base Wood Finish	4b Base Paint	5 Metal Color	6 Electrical
Solid Surface (NAV)	Patterns: ARM Armadillo PEB Pebble Pearl BLP Black Pearl PUR Pure White	Flat Cut CH1 Cherry MA1 Maple WA1 Walnut	See list above for Cherry, Maple and Walnut Finishes	See list above for Paint Finishes	See list above for Metal Paint Colors	Cutout Codes: N all tables C1M 72" - 84" wide C1C 72" - 84" wide
Glass Surface (NAV)	Backpainted Glass: G White Glossy M White Matte					
Wood Plank (NAV)	W Wood Plank Ash, Clear Coat	Double Cut DC1 Double Cut	See list above for Double Cut Finishes			
Sub-Top w/Base (NAV)	B (Table Ships with Sub-Top, Customer applies custom Top)					



Description

Standing Height Rectangular Runoff Table with Panel Base

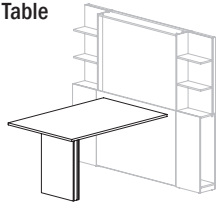
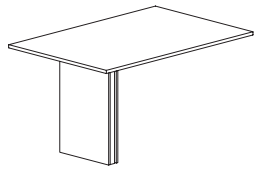

in application

Laminate Tops "NAT" Models

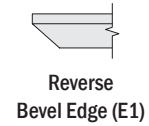
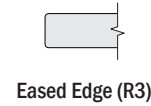

Features:

- must attach to either a 84" Media Wall Space Divider without Media Shelf or a 84" Media Wall - Table Mount
- panel base with structural support rails
- glass top has additional seams

Options:

- worksurface power & storage available, specify cutout code and order power units separately, see pages 150-151
- metal base frame available in powder coat, no upcharge, or chrome, add list upcharge: for 36" wide - \$935, for 42" & 48 wide - \$1,126, for 54 wide - \$1,170
- mounting brackets included

D	W	H	CTN WT	CU FT	① Model	HPL	HPL
54	60	40	199	54	NAT5460-40TTRPB	\$2,965	\$3,346
48	84	40	224	45	NAT4884-40TTRPB	\$2,946	\$3,328
48	72	40	207	41	NAT4872-40TTRPB	\$2,882	\$3,264
48	60	40	179	35	NAT4860-40TTRPB	\$2,776	\$3,158
42	84	40	207	38	NAT4284-40TTRPB	\$2,902	\$3,283
42	72	40	188	42	NAT4272-40TTRPB	\$2,843	\$3,224
42	60	40	166	33	NAT4260-40TTRPB	\$2,742	\$3,124
36	84	40	181	33	NAT3684-40TTRPB	\$2,834	\$3,216
36	72	40	166	38	NAT3672-40TTRPB	\$2,784	\$3,164
36	60	40	146	35	NAT3660-40TTRPB	\$2,690	\$3,071

NATIVE

To Order, Specify:

① Laminate Model #	②a Top Laminate / ②b Base Laminate	③ Top Edge	④ Metal Color	⑤ Electrical
Laminate (NAT)	<p>Solid Patterns:</p> <p>ALB Alabaster BBL Bridal Bianco DWH Designer White SHD Shadow SLG Slate Grey</p> <p>Wood Grain Patterns:</p> <p>AGA Aged Ash ALL Ale Light BLO Blonde Echo BOL Bourbon Light BZW Brazilwood</p> <p>BGL Brighton Light CLL Collectors FLO Florence Walnut GRH Graphite HGL High Line</p> <p>OAT Oatmeal Cookie PIN Pinnacle Walnut STU Studio Teak VIN Vintage WLH Walnut Heights WEA Weathered Ash</p>	<p>Edge Selection:</p> <p>R3 Eased E1 Reverse Bevel</p>	<p>Color:</p> <p>ASL Arctic Silver BWH Bright White MBK Matte Black PEW Pewter SNK Soft Nickel RML Raw (Clear) CHR Chrome* *Upcharge applies</p>	<p>Cutout Codes:</p> <p>N all tables C1M 72" - 84" wide C1C 72" - 84" wide</p> <p>See chart on page 45 for cutout codes and power and storage unit configurations</p>

Description

Standing Height Rectangular Runoff Table with Panel Base (continued)

						Veneer Tops "NAV" Models				Premier Tops "NAV" Models			
						Eased Edge (R3)		Reverse Bevel Edge (E1)		Solid Surface/Glass Reverse Bevel Edge		Wood Plank Ash	
D	W	H	CTN WT	CU FT	① Model	Flat Cut	Double Cut	Flat Cut	Double Cut	Solid Surface	Glass	Wood Plank Ash	Custom Sub-Base
54	60	40	199	54	NAV5460-40TRPB	\$3,572	\$4,129	\$3,718	\$4,276	\$8,936	\$7,829	--	\$3,411
48	84	40	224	45	NAV4884-40TRPB	\$3,548	\$4,127	\$3,696	\$4,274	\$9,652	\$8,848	\$7,314	\$3,389
48	72	40	207	41	NAV4872-40TRPB	\$3,471	\$4,037	\$3,618	\$4,185	\$8,758	\$8,013	\$6,699	\$3,316
48	60	40	179	35	NAV4860-40TRPB	\$3,345	\$3,890	\$3,491	\$4,037	\$7,814	\$7,130	\$6,034	\$3,195
42	84	40	207	38	NAV4284-40TRPB	\$3,494	\$4,064	\$3,641	\$4,212	\$8,884	\$8,131	\$6,788	\$3,339
42	72	40	188	42	NAV4272-40TRPB	\$3,424	\$3,982	\$3,572	\$4,129	\$8,099	\$7,399	\$6,247	\$3,270
42	60	40	166	33	NAV4260-40TRPB	\$3,304	\$3,843	\$3,451	\$3,991	\$7,263	\$6,616	\$5,657	\$3,156
36	84	40	181	33	NAV3684-40TRPB	\$3,414	\$3,970	\$3,560	\$4,118	\$8,091	\$7,389	\$6,238	\$3,260
36	72	40	166	38	NAV3672-40TRPB	\$3,353	\$3,900	\$3,500	\$4,047	\$7,416	\$6,759	\$5,773	\$3,202
36	60	40	146	35	NAV3660-40TRPB	\$3,239	\$3,768	\$3,387	\$3,915	\$6,688	\$6,078	\$5,257	\$3,095

NATIVE

To Order, Specify:

① Veneer Model #	② Wood Species	③ Top Wood Finish	④ Base Finish	⑤ Top Edge	⑥ Metal Color	⑦ Electrical		
Veneer (NAV)	Flat Cut CH1 Cherry MA1 Maple WA1 Walnut	Cherry: BRL Barley BBM Bourbon Medium BRM Brighton Medium CLA Classic CLL Collectors* EAR Earthy HRV Harvest* LGC Legacy PRL Praline* SAF Saffron	Maple: ALM Ale Medium BUT Butterscotch CIN Cinnamon FLX Flax VEN Venetian	Walnut: AUB Auburn ESP Espresso MCH Mocha* NTO Night Owl* SIE Sienna* TOF Toffee TRF Truffle*	V - Same as Top Finish  P - Paint Color: BKD Backdrop BFX Black Fox BWH Bright White CGP Cargo Pants CHT Chatroom FRR French Roast GRV Greek Villa NET Network Gray NWH Nonchalant White STM Storm TRC Tricorn Black	Edge Selection: R3 Eased E1 Reverse Bevel	Color: ASL Arctic Silver BWH Bright White MBK Matte Black PEW Pewter SNK Soft Nickel RML Raw (Clear) CHR Chrome* *Upcharge applies	Cutout Codes: N all tables C1M 72" - 84" wide C1C 72" - 84" wide See chart on page 45 for cutout codes and power and storage unit configurations
		Double Cut DC1 Double Cut	③ Top Wood Finish Double Cut: COF Coffee FOS Fossil KHK Khaki CRM Cremello GRH Graphite STU Studio Teak					

① Specialty Top Model #	② Top Surface Selection	③ Base Wood Species	④a Base Wood Finish	④b Base Paint	⑤ Metal Color	⑥ Electrical
Solid Surface (NAV)	Patterns: ARM Armadillo PEB Pebble Pearl BLP Black Pearl PUR Pure White	Flat Cut CH1 Cherry MA1 Maple WA1 Walnut	See list above for Cherry, Maple and Walnut Finishes	See list above for Paint Finishes	See list above for Metal Paint Colors	Cutout Codes: N all tables C1M 72" - 84" wide C1C 72" - 84" wide
Glass Surface (NAV)	Backpainted Glass: G White Glossy M White Matte					
Wood Plank (NAV)	W Wood Plank Ash, Clear Coat	Double Cut DC1 Double Cut	See list above for Double Cut Finishes			
Sub-Top w/Base (NAV)	B (Table Ships with Sub-Top, Customer applies custom Top)					

Description

View Runoff Table with Panel Base

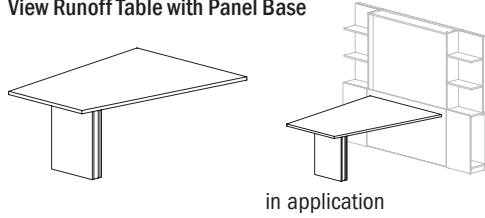

Laminate Tops "NAT" Models

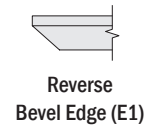
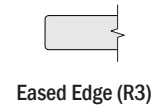

Features:

- must attach to either a 74" Media Wall Space Divider without Media Shelf or a 74" Media Wall - Table Mount
- panel base with structural support rails
- narrow end of table is 36"d
- glass top has additional seams

D	W	H	CTN WT	CU FT	① Model	HPL	HPL
54	84	29 3/8	194	51	NAT5484-30VTRPB	\$2,913	\$3,295
54	72	29 3/8	174	42	NAT5472-30VTRPB	\$2,841	\$3,221
54	60	29 3/8	151	54	NAT5460-30VTRPB	\$2,725	\$3,105

Options:

- metal base frame available in powder coat, no upcharge, or chrome, add \$1,170 list upcharge for 54" wide
- worksurface power & storage available, specify cutout code and order power units separately, see pages 150-151
- mounting brackets included

Description

Standing Height View Runoff Table with Panel Base

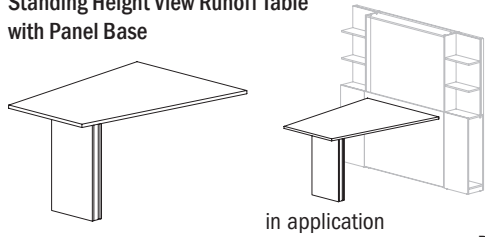

Laminate Tops "NAT" Models

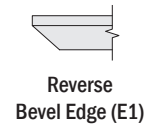
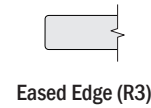

Features:

- must attach to either a 84" Media Wall Space Divider without Media Shelf or a 84" Media Wall - Table Mount
- panel base with structural support rails
- narrow end of table is 36"d
- glass top has additional seams

D	W	H	CTN WT	CU FT	① Model	HPL	HPL
54	84	40	208	54	NAT5484-40VTRPB	\$3,111	\$3,491
54	72	40	189	42	NAT5472-40VTRPB	\$3,025	\$3,406
54	60	40	165	54	NAT5460-40VTRPB	\$2,920	\$3,302

Options:

- metal base frame available in powder coat, no upcharge, or chrome, add \$1,170 list upcharge for 54" wide
- worksurface power & storage available, specify cutout code and order power units separately, see pages 150-151
- mounting brackets included

To Order, Specify:

① Laminate Model #	②a Top Laminate / ②b Base Laminate	③ Top Edge	④ Metal Color	⑤ Electrical
Laminate (NAT)	<p>Solid Patterns:</p> <p>ALB Alabaster BBL Bridal Bianco DWH Designer White SHD Shadow SLG Slate Grey</p> <p>Wood Grain Patterns:</p> <p>AGA Aged Ash ALL Ale Light BLO Blonde Echo BOL Bourbon Light BZW Brazilwood</p> <p>BGL Brighton Light CLL Collectors FLO Florence Walnut GRH Graphite HGL High Line</p> <p>OAT Oatmeal Cookie PIN Pinnacle Walnut STU Studio Teak VIN Vintage WLH Walnut Heights WEA Weathered Ash</p>	<p>Edge Selection:</p> <p>R3 Eased E1 Reverse Bevel</p>	<p>Color:</p> <p>ASL Arctic Silver BWH Bright White MBK Matte Black PEW Pewter SNK Soft Nickel RML Raw (Clear) CHR Chrome* *Upcharge applies</p>	<p>Cutout Codes:</p> <p>N all tables C1M 72" - 84" wide C1C 72" - 84" wide</p> <p>See chart on page 45 for cutout codes and power and storage unit configurations</p>

Description

View Runoff Table with Panel Base  
(continued)

						Veneer Tops "NAV" Models				Premier Tops "NAV" Models			
						Eased Edge (R3)		Reverse Bevel Edge (E1)		Solid Surface/Glass Reverse Bevel Edge			
D	W	H	CTN WT	CU FT	① Model	Flat Cut	Double Cut	Flat Cut	Double Cut	Solid Surface	Glass	Wood Plank Ash	Custom Sub-Base
54	84	29 3/8	194	51	NAV5484-30VTRPB	\$3,510	\$4,059	\$3,657	\$4,207	\$10,376	\$9,471	--	\$3,353
54	72	29 3/8	174	42	NAV5472-30VTRPB	\$3,421	\$3,955	\$3,569	\$4,101	\$9,588	\$8,530	--	\$3,268
54	60	29 3/8	151	54	NAV5460-30VTRPB	\$3,282	\$3,794	\$3,428	\$3,941	\$8,646	\$7,538	--	\$3,134

Description

Standing Height View Runoff Table with Panel Base  
(continued)

						Veneer Tops "NAV" Models				Premier Tops "NAV" Models			
						Eased Edge (R3)		Reverse Bevel Edge (E1)		Solid Surface/Glass Reverse Bevel Edge			
D	W	H	CTN WT	CU FT	① Model	Flat Cut	Double Cut	Flat Cut	Double Cut	Solid Surface	Glass	Wood Plank Ash	Custom Sub-Base
54	84	40	208	54	NAV5484-40VTRPB	\$3,747	\$4,331	\$3,893	\$4,479	\$10,613	\$9,708	--	\$3,579
54	72	40	189	42	NAV5472-40VTRPB	\$3,643	\$4,213	\$3,791	\$4,360	\$9,812	\$8,753	--	\$3,481
54	60	40	165	54	NAV5460-40VTRPB	\$3,518	\$4,068	\$3,666	\$4,215	\$8,883	\$7,776	--	\$3,361

To Order, Specify:

① Veneer Model #	② Wood Species	③ Top Wood Finish	④ Base Finish	⑤ Top Edge	⑥ Metal Color	⑦ Electrical		
Veneer (NAV)	<b>Flat Cut</b> CH1 Cherry MA1 Maple WA1 Walnut	Cherry: BRL Barley BBM Bourbon Medium BRM Brighton Medium CLA Classic CLL Collectors* EAR Earthy HRV Harvest* LGC Legacy PRL Praline* SAF Saffron Finishes with an asterisk (*) have a coordinating laminate available	Maple: ALM Ale Medium BUT Butterscotch CIN Cinnamon FLX Flax VEN Venetian	Walnut: AUB Auburn ESP Espresso MCH Mocha* NTO Night Owl* SIE Sienna* TOF Toffee TRF Truffle*	V - Same as Top Finish  P - Paint Color: BKD Backdrop BFX Black Fox BWH Bright White CGP Cargo Pants CHT Chatroom FRR French Roast GRV Greek Villa NET Network Gray NWH Nonchalant White STM Storm TRC Tricorn Black	Edge Selection: R3 Eased E1 Reverse Bevel	Color: ASL Arctic Silver BWH Bright White MBK Matte Black PEW Pewter SNK Soft Nickel RML Raw (Clear) CHR Chrome* *Upcharge applies	Cutout Codes: N all tables C1M 72" - 84" wide C1C 72" - 84" wide See chart on page 45 for cutout codes and power and storage unit configurations
		<b>Double Cut</b> DC1 Double Cut	<b>③ Top Wood Finish</b> Double Cut: COF Coffee FOS Fossil KHK Khaki CRM Cremello GRH Graphite STU Studio Teak					

① Specialty Top Model #	② Top Surface Selection	③ Base Wood Species	④a Base Wood Finish	④b Base Paint	⑤ Metal Color	⑥ Electrical
Solid Surface (NAV)	Patterns: ARM Armadillo PEB Pebble Pearl BLP Black Pearl PUR Pure White	<b>Flat Cut</b> CH1 Cherry MA1 Maple WA1 Walnut  <b>Double Cut</b> DC1 Double Cut	See list above for Cherry, Maple and Walnut Finishes  See list above for Double Cut Finishes	See list above for Paint Finishes	See list above for Metal Paint Colors	Cutout Codes: N all tables C1M 72" - 84" wide C1C 72" - 84" wide
Glass Surface (NAV)	Backpainted Glass: G White Glossy M White Matte					
Sub-Top w/Base (NAV)	B (Table Ships with Sub-Top, Customer applies custom Top)					

Description	D	W	H	CTN WT	CU FT	① Model	Laminate	Flat Cut Veneer	Double Cut Veneer
Media Wall Space Divider - Media Back	8	60	74	251	34	NAT0860-74MRUT	\$1,948		
	8	60	74	251	34	NAV0860-74MRUT		\$2,769	\$3,220
	8	48	74	206	28	NAT0848-74MRUT	\$1,814		
	8	48	74	206	28	NAV0848-74MRUT		\$2,578	\$2,999
	8	60	84	280	39	NAT0860-84MRUT	\$2,005		
	8	60	84	280	39	NAV0860-84MRUT		\$2,850	\$3,315
	8	48	84	229	32	NAT0848-84MRUT	\$1,860		
	8	48	84	229	32	NAV0848-84MRUT		\$2,645	\$3,076

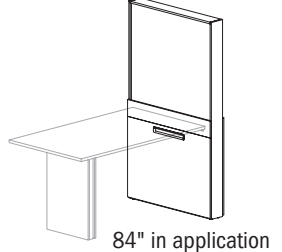
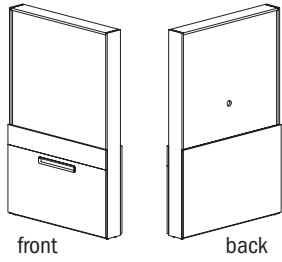

**Features:**

- not freestanding -must attach to Runoff Table on front side
- 84" media wall to be used with standing runoff units
- not to be used with side storage towers

**Options:**

- TV bracket available on each side, specify and add \$214 list per side
- recessed panel on each side available in contrasting laminate color or markerboard, specify color and add \$160 list for veneer models, no upcharge for laminate models; also available in markerboard, specify and add \$358 list
- EC36 power available on front side, specify CO\_EC36 for cut out and order EC36 separately, see page 150

Media Wall Space Divider with Media Shelf - Media Back	23	60	74	380	76	NAT2360-74MSUT	\$2,719		
	23	60	74	380	76	NAV2360-74MSUT		\$3,867	\$4,497
	23	48	74	314	61	NAT2348-74MSUT	\$2,559		
	23	48	74	314	61	NAV2348-74MSUT		\$3,640	\$4,234
	23	60	84	454	86	NAT2360-84MSUT	\$2,965		
	23	60	84	454	86	NAV2360-84MSUT		\$4,215	\$4,902
	23	48	84	377	70	NAT2348-84MSUT	\$2,794		
	23	48	84	377	70	NAV2348-84MSUT		\$3,972	\$4,618

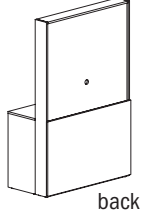
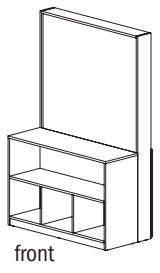

**Features:**

- media shelf included
- 84" media wall to be used with standing runoff units
- not to be used with side storage towers
- media shelf is always same finish as chassis

**Options:**

- TV bracket available on each side, specify and add \$214 list per side
- EC36 power available on front side, specify CO\_EC36 for cut out and order EC36 separately, see page 150
- recessed panel on each side available in contrasting laminate color or markerboard, specify color and add \$160 list for veneer models, no upcharge for laminate models; also available in markerboard, specify and add \$358 list

Description	D	W	H	CTN WT	CU FT	① Model	Laminate	Flat Cut Veneer	Double Cut Veneer
Media Wall Space Divider - Markerboard Back	8	60	74	251	34	NAT0860-74MRUM	\$2,112		
	8	60	74	251	34	NAV0860-74MRUM		\$3,002	\$3,491
	8	48	74	206	28	NAT0848-74MRUM	\$1,996		
	8	48	74	206	28	NAV0848-74MRUM		\$2,836	\$3,299
	8	60	84	280	39	NAT0860-84MRUM	\$2,155		
	8	60	84	280	39	NAV0860-84MRUM		\$3,063	\$3,561
	8	48	84	229	32	NAT0848-84MRUM	\$2,048		
	8	48	84	229	32	NAV0848-84MRUM		\$2,913	\$3,389

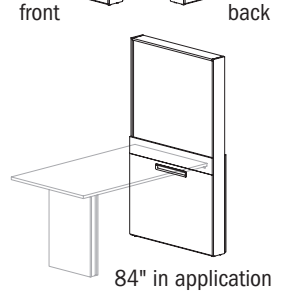
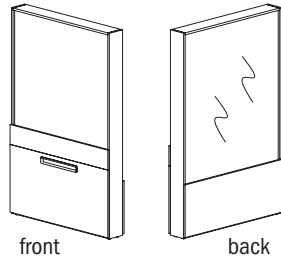

**Features:**

- not freestanding -must attach to Runoff Table on front side
- back panel is always markerboard
- TV bracket available on the front side, specify and add \$214 list

**Options:**

- not to be used with side storage towers
- EC36 power available on front side, specify CO\_EC36 for cut out and order EC36 separately, see page 150
- recessed panel on front side available in contrasting laminate color or markerboard, specify color and add \$160 list for veneer models, no upcharge for laminate models; also available in markerboard, specify and add \$358 list

Description	D	W	H	CTN WT	CU FT	Model	Laminate	Flat Cut Veneer	Double Cut Veneer
Media Wall Space Divider With Media Shelf - Markerboard Back	23	60	74	380	76	NAT2360-74MSUM	\$2,842		
	23	60	74	380	76	NAV2360-74MSUM		\$4,039	\$4,698
	23	48	74	314	61	NAT2348-74MSUM	\$2,669		
	23	48	74	314	61	NAV2348-74MSUM		\$3,793	\$4,413
	23	60	84	454	86	NAT2360-84MSUM	\$3,149		
	23	60	84	454	86	NAV2360-84MSUM		\$4,477	\$5,207
	23	48	84	377	70	NAT2348-84MSUM	\$2,932		
	23	48	84	377	70	NAV2348-84MSUM		\$4,169	\$4,849

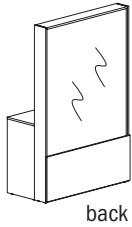
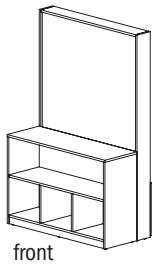

**Features:**

- media shelf included
- back panel is always markerboard
- media shelf is always same finish as chassis
- not to be used with side storage towers
- TV bracket available on each side, specify and add \$214 list per side

**Options:**

- EC36 power available on front side, specify CO\_EC36 for cut out and order EC36 separately, see page 150
- recessed panel on front side available in contrasting laminate color or markerboard, specify color and add \$160 list for veneer models, no upcharge for laminate models; also available in markerboard, specify and add \$358 list

**To Order, Specify:**

① Laminate Model #	② Chasis	③ Front Panel / ④ Back Panel	⑤ TV Brackets	⑥ Grommet			
Laminate (NAT)	Solid Patterns: ALB Alabaster BBL Bridal Blanco DWH Designer White SHD Shadow SLG Slate Grey	Wood Grain Patterns: AGA Aged Ash ALL Ale Light BLO Blonde Echo BOL Bourbon Light BZW Brazilwood BGL Brighton Light	CLL Collectors FLO Florence Walnut GRH Graphite HGL High Line OAT Oatmeal Cookie PIN Pinnacle Walnut	STU Studio Teak VIN Vintage WLN Walnut Heights WEA Weathered Ash	WMB - white markerboard laminate; specify and add \$358 or T - laminate panel; see list to left of solid and wood grain laminates	N - None FTV - TV Brkt on Front; add \$214 BTW - TV Brkt on Front; add \$214 ATV - TV Brkt on Front; add \$427	N - None CO EC36 - Cutout for EC36

① Veneer Model #	② Wood Species	③ Chasis Finish	④ Front Panel / ⑤ Back Panel	⑥ TV Brackets	⑦ Grommet			
Veneer (NAV)	Cherry: BRL Barley BBM Bourbon Medium BRM Brighton Medium CLA Classic CLL Collectors*	EAR Earthy HRV Harvest* LGC Legacy PRL Praline* SAF Saffron	Maple: ALM Ale Medium BUT Butterscotch CIN Cinnamon FLX Flax VEN Venetian	Walnut: AUB Auburn ESP Espresso MCH Mocha* NTO Night Owl* SIE Sienna*	TOF Toffee TRF Truffle*	V - same Veneer as chassis or WMB - white markerboard laminate; specify and add \$358 or T - laminate panel; see list above of solid and wood grain laminates; specify and add \$140	N - None FTV - TV Brkt on Front; add \$214 BTW - TV Brkt on Front; add \$214 ATV - TV Brkt on Front; add \$427	N - None CO EC36 - Cutout for EC36
	Double Cut DC1 Double Cut	Double Cut: COF Coffee CRM Cremello	FOS Fossil GRH Graphite	KHK Khaki STU Studio Teak				

NATIVE

Description	D	W	H	CTN WT	CU FT	① Model	Laminate	Flat Cut Veneer	Double Cut Veneer
Media Wall	12	60	74	227	39	NAT1260-74CMUF	\$2,036		
	12	60	74	227	39	NAV1260-74CMUF		\$2,642	\$3,073
	12	48	74	193	31	NAT1248-74CMUF	\$1,939		
	12	48	74	193	31	NAV1248-74CMUF		\$2,517	\$2,927
	12	60	84	254	44	NAT1260-84CMUF	\$2,102		
	12	60	84	254	44	NAV1260-84CMUF		\$2,730	\$3,174
	12	48	84	217	35	NAT1248-84CMUF	\$1,999		
	12	48	84	217	35	NAV1248-84CMUF		\$2,593	\$3,016

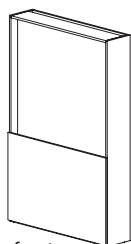

front

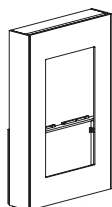

back

**Features:**

- not freestanding - must attach to wall
- unfinished back

**Options:**

- TV bracket available on the front side, specify and add \$214 list
- EC36 power available , specify CO\_EC36 for cut out and order EC36 separately, see page 150
- recessed panel on front side available in contrasting laminate color or markerboard, specify color and add \$160 list for veneer models, no upcharge for laminate models; also available in markerboard, specify and add \$358 list

NATIVE

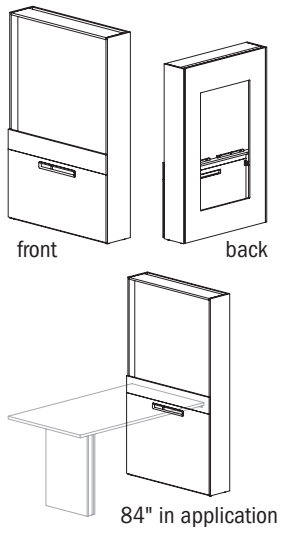
Description	D	W	H	CTN WT	CU FT	① Model	Laminate	Flat Cut Veneer	Double Cut Veneer
	12	60	74	229	39	NAT1260-74CMUC	\$2,085		
	12	60	74	229	39	NAV1260-74CMUC		\$2,707	\$3,149
	12	48	74	196	31	NAT1248-74CMUC	\$1,988		
	12	48	74	196	31	NAV1248-74CMUC		\$2,582	\$3,003
	12	60	84	255	44	NAT1260-84CMUC	\$2,153		
	12	60	84	255	44	NAV1260-84CMUC		\$2,794	\$3,250
	12	48	84	218	35	NAT1248-84CMUC	\$2,047		
	12	48	84	218	35	NAV1248-84CMUC		\$2,659	\$3,093

**Features:**

- not freestanding - must attach to wall and Runoff Table on front side
- unfinished back
- TV bracket available on the front side, specify and add \$214 list

**Options:**

- EC36 power available , specify CO\_EC36 for cut out and order EC36 separately, see page 150
- recessed panel on front side available in contrasting laminate color or markerboard, specify color and add \$160 list for veneer models, no upcharge for laminate models; also available in markerboard, specify and add \$358 list



NATIVE

**To Order, Specify:**

① Laminate Model #	② Chasis			③ Front Panel / ④ Back Panel	⑤ TV Brackets	⑥ Grommet	
<b>Laminate (NAT)</b>	<b>Solid Patterns:</b> ALB Alabaster BBL Bridal Blanco DWH Designer White SHD Shadow SLG Slate Grey	<b>Wood Grain Patterns:</b> AGA Aged Ash ALL Ale Light BLO Blonde Echo BOL Bourbon Light BZW Brazilwood BGL Brighton Light	CLL Collectors FLO Florence Walnut GRH Graphite HGL High Line OAT Oatmeal Cookie PIN Pinnacle Walnut	STU Studio Teak VIN Vintage WLH Walnut Heights WEA Weathered Ash	WMB - white markerboard laminate; specify and add \$358 or T - laminate panel; see list to left of solid and wood grain laminates	N - None FTV - TV Brkt on Front; add \$214 BTV - TV Brkt on Front; add \$214 ATV - TV Brkt on Front; add \$427	N - None CO EC36 - Cutout for EC36
	<b>Flat Cut</b> CH1 Cherry MA1 Maple WA1 Walnut	EAR Earthy HRV Harvest* LGC Legacy PRL Praline* SAF Saffron	ALM Ale Medium BUT Butterscotch CIN Cinnamon FLX Flax VEN Venetian	AUB Auburn ESP Espresso MCH Mocha* NTO Night Owl* SIE Sienna*	V - same Veneer as chasis or WMB - white markerboard laminate; specify and add \$358 or T - laminate panel; see list above of solid and wood grain laminates; specify and add \$140	N - None FTV - TV Brkt on Front; add \$214 BTV - TV Brkt on Front; add \$214 ATV - TV Brkt on Front; add \$427	N - None CO EC36 - Cutout for EC36
<b>Double Cut</b> DC1 Double Cut	<b>③ Chasis Finish</b> Double Cut: COF Coffee FOS Fossil KHK Khaki CRM Cremello GRH Graphite STU Studio Teak						

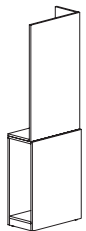
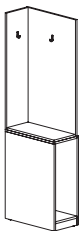
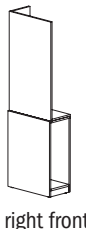

NATIVE

Description	D	W	H	CTN WT	CU FT	Model	Laminate	Flat Cut Veneer	Double Cut Veneer
Side Access Wardrobe Tower	12	24	74	95	16	NAT1224-74SWUR	\$1,702		
	12	24	74	95	16	NAV1224-74SWUR		\$2,209	\$2,569
 left front	12	24	74	95	16	NAT1224-74SWUL	\$1,702		
	12	24	74	95	16	NAV1224-74SWUL		\$2,209	\$2,569
 left back	12	18	74	76	16	NAT1218-74SWUR	\$1,651		
	12	18	74	76	16	NAV1218-74SWUR		\$2,142	\$2,492
 right front	12	18	74	76	16	NAT1218-74SWUL	\$1,651		
	12	18	74	76	16	NAV1218-74SWUL		\$2,142	\$2,492
 right back	12	24	84	108	16	NAT1224-84SWUR	\$1,733		
	12	24	84	108	16	NAV1224-84SWUR		\$2,251	\$2,617
	12	24	84	108	16	NAT1224-84SWUL	\$1,733		
	12	24	84	108	16	NAV1224-84SWUL		\$2,251	\$2,617
	12	18	84	86	13	NAT1218-84SWUR	\$1,677		
	12	18	84	86	13	NAV1218-84SWUR		\$2,176	\$2,530
	12	18	84	86	13	NAT1218-84SWUL	\$1,677		
	12	18	84	86	13	NAV1218-84SWUL		\$2,176	\$2,530

**Features:**

- not freestanding -must attach to Media Wall or Media Wall- Table Mount
- 74" wardrobe tower attaches to 74" media wall. 84" wardrobe attached to 84" media wall
- unfinished back

**Options:**

- additional choice for front panel available in markerboard laminate or corkboard, specify and add \$200 list for markerboard, \$596 list for 18" wide corkboard and \$772 for 24" wide corkboard

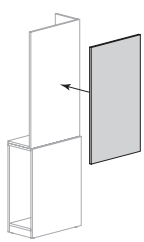
Tackboard for Side Access Wardrobe Tower	¾	24	42	1	2	NAB2442TK	COM	\$207	
	<b>Features:</b>							A	\$238
	· attaches to Wardrobe Tower							B	\$297
	· fabric runs railroad							C	\$401
	· com requirements: 1 yard							D	\$535
								E	\$669
								F	\$878
								G	\$1,101
								H	\$1,338
								I	\$1,710
								J	\$2,156

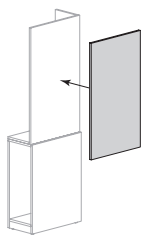
Tackboard for Side Access Wardrobe Tower	¾	18	42	1	2	NAB1842TK	COM	\$207	
	<b>Features:</b>							A	\$238
	· attaches to Wardrobe Tower							B	\$297
	· fabric runs railroad							C	\$401
	· com requirements: 1 yard							D	\$535
								E	\$669
								F	\$878
								G	\$1,101
								H	\$1,338
								I	\$1,710
								J	\$2,156

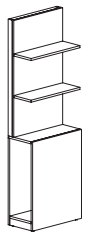
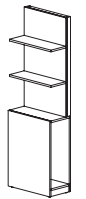
Description	D	W	H	CTN WT	CU FT	① Model	Laminate	Flat Cut Veneer	Double Cut Veneer
 left shown   right	12	24	74	96	16	NAT1224-74SSUR	\$1,787		
	12	24	74	96	16	NAV1224-74SSUR		\$2,318	\$2,697
	12	24	74	96	16	NAT1224-74SSUL	\$1,787		
	12	24	74	96	16	NAV1224-74SSUL		\$2,318	\$2,697
	12	18	74	77	13	NAT1218-74SSUR	\$1,733		
	12	18	74	77	13	NAV1218-74SSUR		\$2,251	\$2,617
	12	18	74	77	13	NAT1218-74SSUL	\$1,733		
	12	18	74	77	13	NAV1218-74SSUL		\$2,251	\$2,617
	12	24	84	109	19	NAT1224-84SSUR	\$1,818		
	12	24	84	109	19	NAV1224-84SSUR		\$2,361	\$2,745
	12	24	84	109	19	NAT1224-84SSUL	\$1,818		
	12	24	84	109	19	NAV1224-84SSUL		\$2,361	\$2,745
	12	18	84	87	14	NAT1218-84SSUR	\$1,758		
	12	18	84	87	14	NAV1218-84SSUR		\$2,282	\$2,654
	12	18	84	87	14	NAT1218-84SSUL	\$1,758		
	12	18	84	87	14	NAV1218-84SSUL		\$2,282	\$2,654

**Features:**

- not freestanding -must attach to Media Wall or Media Wall- Table Mount
- 74" wardrobe tower attaches to 74" media wall. 84" wardrobe attaches to 84" media wall
- unfinished back

**To Order, Specify:**

① Laminate Model #	② Chasis	③ Front Panel (side access wardrobe only)
Laminate (NAT)	Solid Patterns: ALB Alabaster BBL Bridal Blanco DWH Designer White SHD Shadow SLG Slate Grey  Wood Grain Patterns: AGA Aged Ash ALL Ale Light BLO Blonde Echo BOL Bourbon Light BZW Brazilwood BGL Brighton Light CLL Collectors FLO Florence Walnut GRH Graphite HGL High Line OAT Oatmeal Cookie PIN Pinnacle Walnut STU Studio Teak VIN Vintage WLH Walnut Heights WEA Weathered Ash	WMB - white markerboard laminate; specify and add \$175 or CKB - corkboard; specify and add \$596 or \$772 or T - laminate panel; see list to left of solid and wood grain laminates

① Veneer Model #	② Chasis Finish	③ Front Panel (side access wardrobe only)
Veneer (NAV)	Cherry: BRL Barley BBM Bourbon Medium BRM Brighton Medium CLA Classic CLL Collectors* EAR Earthy HRV Harvest* LGC Legacy PRL Praline* SAF Saffron Maple: ALM Ale Medium BUT Butterscotch CIN Cinnamon FLX Flax VEN Venetian Walnut: AUB Auburn ESP Espresso MCH Mocha* NTO Night Owl* SIE Sienna* TOF Toffee TRF Truffle* Finishes with an asterisk (*) have a coordinating laminate available	V - same Veneer as chasis or WMB - white markerboard laminate; specify and add \$175 or CKB - corkboard; specify and add \$596 or \$772
<b>③ Chasis Finish</b> Double Cut: COF Coffee CRM Cremello FOS Fossil GRH Graphite KHK Khaki STU Studio Teak		

① Model Number	② Fabric Selection
(NAB)	Vendor Pattern Color See a selection of graded in fabric manufacturers and patterns on pages 19-26 Contact Customer Service for additional fabric options.

Description	D	W	H	CTN WT	CU FT	① Model	Laminate	Flat Cut Veneer	Double Cut Veneer
Waste Credenza	24	36	36	158	21	NAT2436-36RSC	\$3,218		
	24	36	36	158	21	NAV2436-36RSC		\$3,830	\$4,330

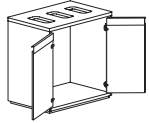
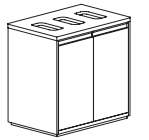

**Features:**

- accommodates three Uline Thin #H-5148 (23 gallon) trash cans, not included
- must specify solid surface top material, see page 35

**Options:**

- locking doors available, specify and add \$123 list
- laminate doors available in contrasting color, no upcharge, specify color; see page 33 for details
- veneer doors available in contrasting paint color, no upcharge, specify paint color; see page 33 for details
- metal available in powder coat, no upcharge, or chrome, add \$284 list upcharge

Hospitality Cart	20	33	40	188	19	NAT2033-40HCD	\$4,199		
	20	33	40	188	19	NAV2033-40HCD		\$5,058	\$5,719

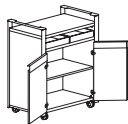
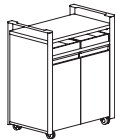

**Features:**

- four non-locking casters
- hinged door compartment has one fixed shelf

**Options:**

- two removable trays included, select paint color
- locking doors available, specify and add \$123 list
- metal available in powder coat, no upcharge, or chrome, add \$1,615 list upcharge

Hospitality Cart - Open	20	33	40	173	19	NAT2033-40HCO	\$3,484		
	20	33	40	173	19	NAV2033-40HCO		\$4,098	\$4,526



**Features:**

- four non-locking casters
- open compartment has one fixed shelf

**Options:**

- two removable trays included, select paint color
- metal available in powder coat, no upcharge, or chrome, add \$1,615 list upcharge

Open Shelves	20	42	72	148	42	NAT2042-72SHU	\$3,594		
	20	42	72	148	42	NAV2042-72SHU		\$4,226	\$4,668
	20	24	72	104	25	NAT2024-72SHU	\$3,440		
	20	24	72	104	25	NAV2024-72SHU		\$4,047	\$4,469
	20	42	42	94	24	NAT2042-42SHU	\$3,345		
	20	42	42	94	24	NAV2042-42SHU		\$3,935	\$4,345
	20	24	42	68	14	NAT2024-42SHU	\$3,123		
	20	24	42	68	14	NAV2024-42SHU		\$3,762	\$4,154

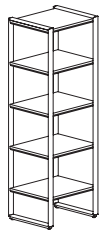
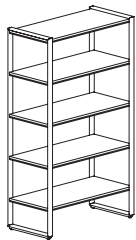

42w X 72h

24w X 72h

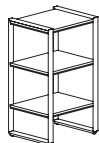

42w X 42h

24w X 42h

**Features:**

- 72" units must be loaded from bottom shelf up to be used in open areas
- wall-attachment hardware included

**Options:**

- metal frame available in powder coat, no upcharge. chrome not an option

Description	D	W	H	CTN WT	CU FT	① Model	Laminate	Flat Cut Veneer	Double Cut Veneer
Mobile Lectern	19	20	40 1/2	135	20	NAT2019-40LEC	\$2,846		
	19	20	40 1/2	135	20	NAV2019-40LEC		\$3,308	\$3,573

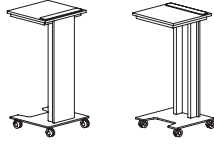

**Features:**

- cork tray strip on surface for coaster
- specify caster or leveling glide, glide option decreases height by 1 1/2"

**Options:**

- metal available in powder coat, no upcharge, or chrome, add \$1,467 list upcharge

Mobile Lectern with Storage	20	26	47	140	20	NAT2026-47LES	\$3,604		
	20	26	47	140	20	NAV2026-47LES		\$4,239	\$4,663

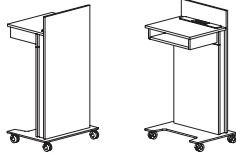

**Features:**

- surface height: 40 1/2"
- cork tray strip on surface for coasterpower unit standard; two power receptacles, two powered USB
- specify caster or leveling glide, glide option decreases height by 1 1/2"

**Options:**

- metal available in powder coat, no upcharge, or chrome, add \$1,558 list upcharge
- microphone available, contact customer service for special quote

**To Order, Specify:**

① Laminate Model #	②a Chassis Laminate / ②b Door Front Laminate	③ Metal Color
Laminate (NAT)	<p>Solid Patterns:</p> <p>ALB Alabaster BBL Bridal Bianco DWH Designer White SHD Shadow SLG Slate Grey</p> <p>Wood Grain Patterns:</p> <p>AGA Aged Ash ALL Ale Light BLO Blonde Echo BOL Bourbon Light BZW Brazilwood</p> <p>BGL Brighton Light CLL Collectors FLO Florence Walnut GRH Graphite HGL High Line</p> <p>OAT Oatmeal Cookie PIN Pinnacle Walnut STU Studio Teak VIN Vintage WLH Walnut Heights WEA Weathered Ash</p>	<p>Color:</p> <p>ASL Arctic Silver BWH Bright White MBK Matte Black PEW Pewter SNK Soft Nickel RML Raw (Clear) CHR Chrome* *Upcharge applies</p>

① Veneer Model #	② Wood Species	③ Chassis Finish - Top	④ Door Front Paint	⑤ Metal Color	
Veneer (NAV)	<p>Flat Cut</p> <p>CH1 Cherry MA1 Maple WA1 Walnut</p>	<p>Cherry:</p> <p>BRL Barley BBM Bourbon Medium BRM Brighton Medium CLA Classic CLL Collectors* EAR Earthy HRV Harvest* LGC Legacy PRL Praline* SAF Saffron</p> <p>Maple:</p> <p>ALM Ale Medium BUT Butterscotch CIN Cinnamon FLX Flax VEN Venetian</p> <p>Walnut:</p> <p>AUB Auburn ESP Espresso MCH Mocha* NTO Night Owl* SIE Sienna* TOF Toffee TRF Truffle*</p> <p>Finishes with an asterisk (*) have a coordinating laminate available</p>	<p>③ Wood Finish - Top</p> <p>Double Cut:</p> <p>COF Coffee FOS Fossil KHK Khaki CRM Cremello GRH Graphite STU Studio Teak</p>	<p>V - Same as Chassis</p> <p>P - Paint Color:</p> <p>BKD Backdrop BFX Black Fox BWH Bright White CGP Cargo Pants CHT Chatroom FRR French Roast GRV Greek Villa NET Network Gray NWH Nonchalant White STM Storm TRC Tricorn Black</p>	<p>Color:</p> <p>ASL Arctic Silver BWH Bright White MBK Matte Black PEW Pewter SNK Soft Nickel RML Raw (Clear) CHR Chrome* *Upcharge applies</p>

Description	D	W	H	CTN WT	CU FT	① Model	List Price
Mobile Board	24	42	75	162	58	NAB2442-75MMB	\$3,878

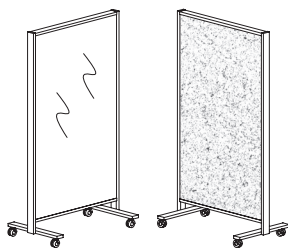

**Features:**

- four non-locking casters
- base allows for offset nesting

**Options:**

- front and back both available in markerboard or corkboard, add \$638 list for corkboard per side
- metal frame available in powder coat, no upcharge. chrome not an option

Description	D	W	H	CTN WT	CU FT	① Model	List Price Per Grade
Mobile Board - Tackboard One Side	24	42	75	1	51	NAB2442-75MTKS	COM \$4,059

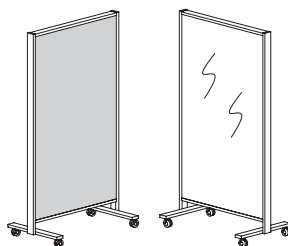

**Features:**

- casters standard
- base allows for offset nesting
- back available in markerboard or corkboard, add \$638 list for corkboard
- com requirements: 1 1/2 yards per side

**Options:**

- metal frame available in powder coat, no upcharge. chrome not an option.

- A \$4,084
- B \$4,131
- C \$4,214
- D \$4,322
- E \$4,427
- F \$4,595
- G \$4,773
- H \$4,963
- I \$5,261
- J \$5,618
- L1 \$4,903
- L2 \$5,143

Mobile Board - Tackboard Both Sides	24	42	75	1	51	NAB2442-75MTKD	COM \$3,954
-------------------------------------	----	----	----	---	----	----------------	-------------

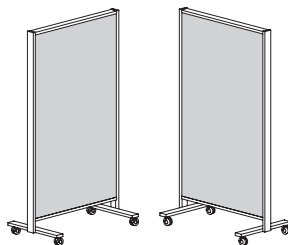

**Features:**

- casters standard
- base allows for offset nesting
- com requirements: 1 1/2 yards
- highest grade of fabric used on either side determines cost

**Options:**

- metal frame available in powder coat, no upcharge. chrome not an option.

- A \$4,002
- B \$4,097
- C \$4,264
- D \$4,478
- E \$4,692
- F \$5,024
- G \$5,381
- H \$5,762
- I \$6,357
- J \$7,070
- L1 \$5,642
- L2 \$6,118

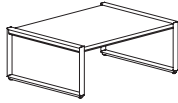
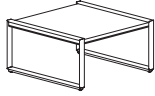
Description	D	W	H	CTN WT	CU FT	① Model	Laminate	Flat Cut Veneer	Double Cut Veneer
 <p>36d X 48w</p>  <p>36d X 36w</p>	36	48	19	93	24	NAT3648-19TT	\$2,219		
	36	48	19	93	24	NAV3648-19TT		\$2,610	\$2,852
	36	36	19	77	18	NAT3636-19TT	\$2,170		
	36	36	19	77	18	NAV3636-19TT		\$2,551	\$2,723

**Features:**

- two metal, open loop bases

**Options:**

- metal base frame available in powder coat, no upcharge, or chrome, add list upcharge: for 36" wide - \$1,840, for 48" wide - \$2,005

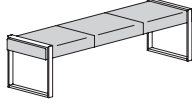
Description	D	W	H	CTN WT	CU FT	① Model	List Price Per Grade
	20	72	19	1	20	NAB2072-19BEN	COM \$2,367
							A \$2,392
							B \$2,443
							C \$2,529
							D \$2,644
							E \$2,757
							F \$2,933
							G \$3,122
							H \$3,324
							I \$3,638
							J \$4,017
							L1 \$3,462
						L2 \$3,765	

**Features:**

- two metal, open loop bases
- com requirements: 2 ¼ yards
- col requirements: 50 sq ft

**Options:**

- metal base frame available in powder coat, no upcharge, or chrome, add \$1,128 list upcharge

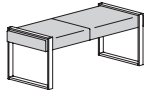
	20	48	19	1	14	NAB2048-19BEN	COM \$2,004
							A \$2,020
							B \$2,056
							C \$2,113
							D \$2,190
							E \$2,263
							F \$2,382
							G \$2,508
							H \$2,642
							I \$2,851
							J \$3,103
							L1 \$2,735
						L2 \$2,937	

**Features:**

- two metal, open loop bases
- com requirements: 1 ½ yards
- col requirements: 35 sq ft

**Options:**

- metal base frame available in powder coat, no upcharge, or chrome, add \$1,128 list upcharge

**To Order, Specify:**

① Model Number	② Fabric Selection	③ Metal Color
(NAB)	Vendor Pattern Color See a selection of graded in fabric manufacturers and patterns on pages 19-26. Contact Customer Service for additional fabric options.	Color: ASL Arctic Silver    SNK Soft Nickel BWH Bright White    RML Raw (Clear) MBK Matte Black    CHR Chrome* PEW Pewter    *Upcharge applies

Description	D	W	H	CTN WT	CU FT	① Model	List Price
Wire Manager - Open Loop Base	2 1/2	3/4	23 3/4	1	1	NAB0301-24LBWM	\$248

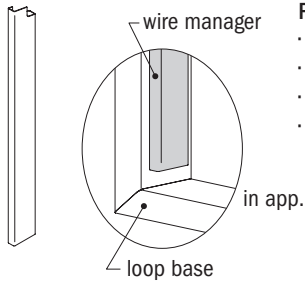

- Features:**
- magnetically attaches to inside of Open Loop Base
  - manage wires from underside of table to the floor
  - interior dimensions are 2 3/8" deep x 5/8" wide
  -

Wire Manager - X Base	2	3/4	23 5/16	1	1	NAB0201-24XBWM	\$248
-----------------------	---	-----	---------	---	---	----------------	-------

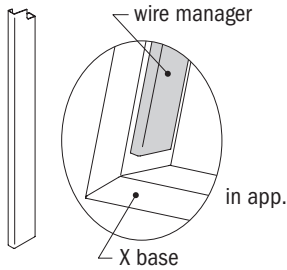

- Features:**
- magnetically attaches to inside of X Loop Base
  - manage wires from underside of table to the floor
  - interior dimensions are 1 3/4" deep x 1/2" wide
  -

Undermount Convenience Outlet	3 1/8	7 1/8	2 1/8	1	1	EC34	\$382
-------------------------------	-------	-------	-------	---	---	------	-------

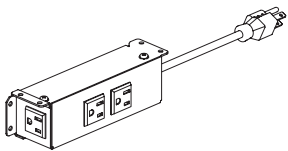

- Features:**
- mounts to underside of table
  - Unit is always black
  - 108" power cord

Cove Power Unit	2 1/2	12 1/2	3 1/4	1	1	EC36	\$760
-----------------	-------	--------	-------	---	---	------	-------

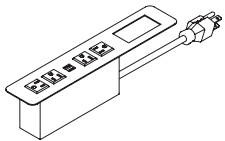

- Features:**
- surface mount power unit
  - use with cutout code C; see page 11 for additional details
  - four power receptacles - 120 volt, 15 amp and two powered USB
  - unit ships standard with one (1) TCP 101 and one (1) TCP110 Telecom Plate
  - 108" power cord

Description	D	W	H	CTN WT	CU FT	① Model	List Price
Oasis Mini Power Unit	9	14 3/8	4 3/4	1	1	EC37	\$1,325

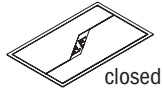

**Features:**

- undermount power unit with hinged lid
- use with cutout code M; see page 11 for additional details
- four power receptacles - 120 volt, 15 amp and accepts three telecom plates
- unit ships standard with three (3) TCP 101 and two (2) TCP110 Telecom Plates
- black interior
- 108" power cord
- UL listed component

**Options:**

- must specify metal finish for doors and trim (raw and chrome unavailable)

Oasis Power Unit	9	29 3/8	4 3/4	1	1	EC38	\$2,236
------------------	---	--------	-------	---	---	------	---------

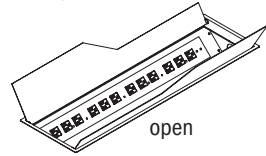
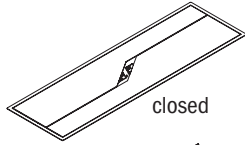

**Features:**

- undermount power unit with hinged lid
- use with cutout code O; see page 11 for additional details
- twelve power receptacles - 120 volt, 15 amp and accepts four telecom plates
- unit ships standard with four (4) TCP 101 and two (2) TCP110 Telecom Plates
- black interior
- two 108" power cords
- UL listed component

**Options:**

- must specify metal finish for doors and trim (raw and chrome unavailable)

Small Storage Compartment	9	14 3/8	4 3/4	1	1	EC39	\$924
---------------------------	---	--------	-------	---	---	------	-------

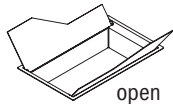

**Features:**

- storage compartment with hinged lid
- use with cutout code M; see page 11 for additional details
- interior dimensions: 8 1/8" x 13 3/4" x 4"H
- black interior

**Options:**

- must specify metal finish for doors and trim (raw and chrome unavailable)

Large Storage Compartment	9	29 3/8	4 3/4	1	1	EC40	\$978
---------------------------	---	--------	-------	---	---	------	-------

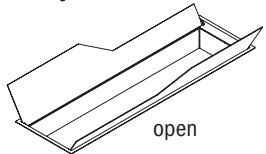
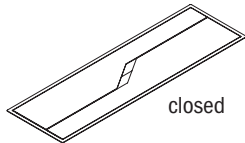

**Features:**

- storage compartment with hinged lid
- use with cutout code O; see page 11 for additional details
- interior dimensions: 8 1/8" x 28 3/4" x 4"H
- black interior

**Options:**

- must specify metal finish for doors and trim (raw and chrome unavailable)

**To Order, Specify:**

① Model Number	② Metal Color
(NAB) or (EC)	Color: ASL Arctic Silver    SNK Soft Nickel BWH Bright White    RML Raw (Clear) MBK Matte Black    CHR Chrome* PEW Pewter    *Upcharge applies





## Features

Nosh Multi-Purpose tables offer an unequalled breadth of offering for every table application



### Tops

- 6 Top Shapes: Rectangular, Rounded Rectangular, Round, Square, Rounded Square and Squircle
- 3 Material Options: Veneer, Laminate and Solid Surface
- 28 Veneer Finishes
- 22 Standard Laminates
- Graded In Laminate Program
- 22 PVC edge options
- 4 solid surface patterns
- 3 Edge Profiles: Eased, Square and Reverse Bevel
- Electrical options

### Bases

- 6 Styles: T, X, X4, X Extended, Round Disc, Square Disc
- 5 Metal Finishes, Two-Tone available

## Overview



Top Sizes and Shapes . . . . .	154	Tables - 29"h . . . . .	166
Laminate Tops . . . . .	155	Tables - 36"h . . . . .	218
Veneer Tops . . . . .	162	Tables - 42"h . . . . .	266
Solid Surface Tops . . . . .	163	Power & Wire Management. . . . .	314
Base Styles . . . . .	164		
Power Options . . . . .	165		

NOSH

# Nosh Product Information

## Nosh Top Shapes and Sizes

Nosh offers six table top shapes. Tables are available in 29", 36", and 42"h, with the exception of rectangular and rounded rectangular, 30" x 54" and smaller and 36" x 54" and smaller.

HSON

rectangular	rounded rectangular	round	square	rounded square	squire
29"h	29"h	29"h	29"h	29"h	29"h
36" x 72" Seats 6	36" x 72" Seats 6	60" Seats 6	60" x 60" Seats 8	60" x 60" Seats 8	60" x 60" Seats 8
36" x 66" Seats 6	36" x 66" Seats 6	54" Seats 6	54" x 54" Seats 6	54" x 54" Seats 6	54" x 54" Seats 6
36" x 60" Seats 4	36" x 60" Seats 4	48" Seats 4	48" x 48" Seats 4	48" x 48" Seats 4	48" x 48" Seats 4
36" x 54" Seats 4	36" x 54" Seats 4	42" Seats 4	42" x 42" Seats 4	42" x 42" Seats 4	42" x 42" Seats 4
36" x 48" Seats 4	36" x 48" Seats 4	36" Seats 3	36" x 36" Seats 4	36" x 36" Seats 4	36" x 36" Seats 4
		30" Seats 3	30" x 30" Seats 4	30" x 30" Seats 4	30" x 30" Seats 4
30" x 72" Seats 6	30" x 72" Seats 6				
30" x 66" Seats 4	30" x 66" Seats 4				
30" x 60" Seats 4	30" x 60" Seats 4				
30" x 54" Seats 4	30" x 54" Seats 4				
30" x 48" Seats 4	30" x 48" Seats 4				
36"h	36"h	36"h	36"h	36"h	36"h
60" x 72" Seats 6	60" x 72" Seats 6	60" Seats 6	60" x 60" Seats 8	60" x 60" Seats 8	60" x 60" Seats 8
60" x 66" Seats 6	60" x 66" Seats 6	54" Seats 6	54" x 54" Seats 6	54" x 54" Seats 6	54" x 54" Seats 6
60" x 60" Seats 4	60" x 60" Seats 4	48" Seats 4	48" x 48" Seats 4	48" x 48" Seats 4	48" x 48" Seats 4
		42" Seats 4	42" x 42" Seats 4	42" x 42" Seats 4	42" x 42" Seats 4
		36" Seats 3	36" x 36" Seats 4	36" x 36" Seats 4	36" x 36" Seats 4
		30" Seats 3	30" x 30" Seats 4	30" x 30" Seats 4	30" x 30" Seats 4
30" x 72" Seats 6	30" x 72" Seats 6				
30" x 66" Seats 4	30" x 66" Seats 4				
30" x 60" Seats 4	30" x 60" Seats 4				
42"h	42"h	42"h	42"h	42"h	42"h
60" x 72" Seats 6	60" x 72" Seats 6	60" Seats 6	60" x 60" Seats 8	60" x 60" Seats 8	60" x 60" Seats 8
60" x 66" Seats 6	60" x 66" Seats 6	54" Seats 6	54" x 54" Seats 6	54" x 54" Seats 6	54" x 54" Seats 6
60" x 60" Seats 4	60" x 60" Seats 4	48" Seats 4	48" x 48" Seats 4	48" x 48" Seats 4	48" x 48" Seats 4
		42" Seats 4	42" x 42" Seats 4	42" x 42" Seats 4	42" x 42" Seats 4
		36" Seats 3	36" x 36" Seats 4	36" x 36" Seats 4	36" x 36" Seats 4
		30" Seats 3	30" x 30" Seats 4	30" x 30" Seats 4	30" x 30" Seats 4
30" x 72" Seats 6	30" x 72" Seats 6				
30" x 66" Seats 4	30" x 66" Seats 4				
30" x 60" Seats 4	30" x 60" Seats 4				

## Corner Details

A more inviting approach can be achieved by selecting Rounded Corners on either Rectangular or Square Tables.

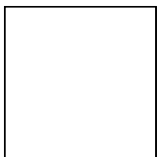

**Square Corner**

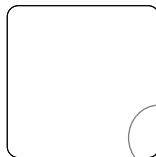

**Rounded Corner**

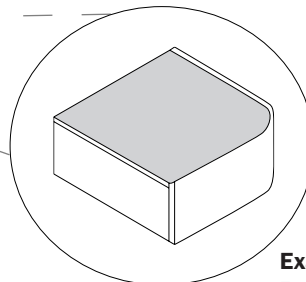

**Example**  
Eased (R3) PVC edge laminate with rounded corner

## Nosh Product Information

### Laminate Tops

HPL tops are 1 3/16" thick, 3 ply construction. The laminate face is horizontal grain or solid high pressure laminate. Particle board core and a phenolic backer sheet complete the balanced construction.

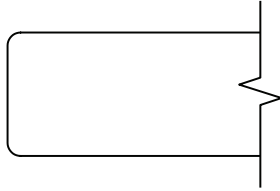

**Eased Edge (R3)**  
PVC

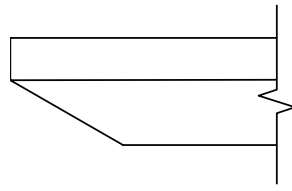

**Reverse Bevel (K9)**  
PVC on painted top of painted MDF

### Standard PVC Edge Colors

JSI supports 22 standard PVC edge colors listed below. These coordinate with our Standard (Tier1) Laminates.

When selecting a Standard (Tier 1) Laminate, the coordinating PVC edge color is automatically applied. When selecting a Graded-In Laminate (Tier 2 or 3), you will be prompted to choose one these 22 PVC edge colors to be applied to the edge.

<b>AGA</b> Aged Ash	<b>FLO</b> Florence Walnut
<b>ALB</b> Alabaster	<b>GRH</b> Graphite
<b>ALL</b> Ale Light	<b>HGL</b> High Line
<b>BLK</b> Black	<b>OAT</b> Oatmeal Cookie
<b>BLO</b> Blonde Echo	<b>PIN</b> Pinnacle Walnut
<b>BOL</b> Bourbon Light	<b>SHD</b> Shadow
<b>BZW</b> Brazilwood	<b>SLG</b> Slate Grey
<b>BBL</b> Bridal Blanco	<b>STU</b> Studio Teak
<b>BGL</b> Brighton Light	<b>VIN</b> Vintage
<b>CLL</b> Collectors	<b>WLH</b> Walnut Heights
<b>DWH</b> Designer White	<b>WEA</b> Weathered Ash

### Standard Laminates

JSI Standard Laminate program consists of 22 solid and wood grain patterns, and establish our Tier 1 laminate pricing. Each has a coordinating PVC edge color that is automatically used with the Standard Laminates.

#### Wood Grain Laminate

<b>AGA</b> Aged Ash	<b>GRH</b> Graphite
<b>ALL</b> Ale Light	<b>HGL</b> High Line
<b>BLO</b> Blonde Echo	<b>OAT</b> Oatmeal Cookie
<b>BOL</b> Bourbon Light	<b>PIN</b> Pinnacle Walnut
<b>BZW</b> Brazilwood	<b>STU</b> Studio Teak
<b>BGL</b> Brighton Light	<b>VIN</b> Vintage
<b>CLL</b> Collectors	<b>WLH</b> Walnut Heights
<b>FLO</b> Florence Walnut	<b>WEA</b> Weathered Ash

#### Solid Laminate

<b>ALB</b> Alabaster
<b>BLK</b> Black
<b>BBL</b> Bridal Blanco
<b>DWH</b> Designer White
<b>SHD</b> Shadow
<b>SLG</b> Slate Grey



# Formica Laminate Tier

JSI offers an extensive program for laminates beyond our Standard Program. Always reference our website for the most current listing when using a [Graded-In Laminate](#), on page 155 select the color of the PVC edge color.

Laminate	Pattern #	Tier	Laminate	Pattern #	Tier	Laminate	Pattern #	Tier
Acajou Mahogany	7008-43	2	Folkstone Grafix	507-58	2	Planked Deluxe Pear	6206-43	2
African Limba	7011-43	2	Fossil	5349-PX	3	Planked Raw Oak	7412-PG	3
Algae	8796-PG	3	Fox Teakwood	8907-NG	3	Planked Urban Oak	9312-NG	3
Almond	920-58	2	Ginger Root Maple	7288-58	2	Portico Marble	7735-58	2
Amber Maple	7012-58	2	Glamour Cherry	6208-43	2	Prestige Walnut	6209-43	2
Antique White	932-58	2	Graphite	837-58	2	Pumice	858-58	2
Ashen Ribbonwood	8839-58	2	Graphite Grafix	515-58	2	Rattan Cane	3699-58	2
Autumn Indian Slate	3687-58	2	Graphite Twill	8829-58	2	Raw Birchply	8910-NG	3
Basalt Slate	3690-34	3	Graystone	464-58	2	Raw Cedar	1545-PG	3
Beluga Beige	3698-58	2	Green Felt	4974-PA	3	Reclaimed Denim Fiber	9271-PX	3
Black	909-58	2	Green Slate	8793-58	2	Rolled Steel	8917-58	2
Black Birchply	8552-NG	3	Green Slate Birchply	8911-NG	3	Sail White	463-PX	3
Black Recycled Kraft	9685-58	2	Greige Softwood	4924-NG	3	Salvage Planked Elm	9480-58	2
Black Riftwood	6414-NG	3	Hard Rock Maple	86992-58	2	Sand Crystall	3517-58	2
Black Walnut	3485-58	2	Infinity Duotex	6448-58	2	Sarum Grey	2770-58	2
Blackened Fiberwood	8916-NG	3	Ivory Kashmir	6226-58	2	Sarum Twill	8827-58	2
Blackened Legno	8848-58	2	Jamocho Granite	7734-46	3	Seasoned Planked Elm	6477-NG	3
Blackened Steel	8918-58	2	Jarrah Legno	8847-58	2	Select Cherry	7759-43	2
Bleached Legno	8845-58	2	Just Rose	8858-PX	3	Silver Oak Herringbone	9311-58	2
Blond Cedar	8576-PG	3	Labrador Granite	3692-46	3	Silver Riftwood	6413-NG	3
Blossom Cherrywood	758-58	2	Layered Black Sand	9510-34	3	Smoky Brown Pear	5488-NT	2
Blue Felt	9320-PA	3	Layered Sand	9511-34	3	Smoky Walnut Woodline	6926-NT	2
Blush	8238-PX	3	Layered White Sand	9512-34	3	Solar Orange	8235-PX	3
Brite White	459-58	2	Lime Stone	7264-58	2	Sorrel Cherry	5886-43	2
Bronzed Steel	8919-58	2	Macchiato Walnut	6932-NT	2	Spectrum Blue	851-58	2
Bubble Art	8958-58	2	Maple Woodline	6225-NT	2	Spectrum Green	7897-58	2
Bubble Organic	8957-58	2	Marine Blue	914-58	2	Spectrum Red	845-58	2
Bubble Science	8956-58	2	Matrix Blue	8795-58	2	Stone Grafix	503-58	2
Burnt Strand	6307-58	2	MDF Solidz	7812-58	2	Stop Red	839-58	2
Butcherblock Maple	204-58	2	Millennium Oak	5887-NT	2	Storm	912-58	2
Cardboard Solidz	7813-58	2	Mineral Spa	6920-58	2	Storm Solidz	3505-SP	3
Carrara Envision	7494-58	2	Mission White	933-58	2	Storm Teakwood	8908-NG	3
Cascara Teakwood	8909-NG	3	Mojave	8751-58	2	Surf	923-58	2
Cassis	6903-58	2	Moonstone	7872-PX	3	Terril	2297-PX	3
Charcoal Boomerang	6942-58	2	Mouse	928-58	2	Thermo Walnut	6402-43	2
Charred Formwood	6416-NT	2	Natural Ash	8843-WR	3	Tinted Paper Terrazzo	8812-PA	3
Cherry Birch	7484-58	2	Natural Birch	7481-58	2	Tonal Paper Terrazzo	8813-PA	3
Cherry Riftwood	6411-NG	3	Natural Cane	6930-NT	2	Travertine	3526-58	2
Chestnut Woodline	5884-58	2	Natural Canvas	7022-58	2	Vibrant Green	6901-58	2
Chocolate Warp	5881-58	2	Natural Cherry	7737-58	2	Victorian Mahogany	7583-58	2
Chrome Yellow	1485-58	2	Natural Gray Felt	4971-PA	3	Violin Figured Annigre	7285-58	2
Citadel	1097-MC	3	Natural Maple	756-58	2	Walnut Fiberwood	8915-NG	3
Citadel Warp	5882-58	2	Natural Oak	346-58	2	Walnut Riftwood	9283-NG	3
Cocoa Maple	7739-58	2	Natural Recycled Kraft	9684-58	2	Walnut Softwood	4925-NG	3
Cognac Maple	7738-58	2	Natural Teak	8849-58	2	Washed Knotty Ash	6438-58	2
Concrete Formwood	6362-NT	2	Natural Walnut	6401-43	2	Waxed Maple	8905-58	2
Concrete Stone	7267-58	2	Navy Blue	969-58	2	Weathered Beamwood	6410-NG	3
Cream Softwood	4923-NG	3	Navy Grafix	7018-58	2	Weathered Fiberwood	8914-NG	3
Danish Maple	8906-58	2	Neutral Twill	8826-58	2	Wenge Strand	6306-58	2
Dark Chocolate	2200-SP	3	Neutral Weft	5875-58	2	Wheat Strand	6212-58	2
Denim Twill	8814-58	2	Neutral White	918-58	2	White	949-58	2
Desert Beige	899-58	2	New Burgundy	7966-58	2	White	949-MC	3
Dogbone White	5281-58	2	Night Forest	8244-58	2	White	949-SP	3
Dover White	7197-58	2	Night Shade	8243-58	2	White Ash	8841-WR	3
Earth	5342-SP	3	Nocturne	5323-58	2	White Drops	8824-58	2
Earth Wash	7213-58	2	Noir Cedar	1547-PG	3	White Ice Granite	9476-43	2
Earthen Twill	8828-58	2	Oak Fiberwood	8913-NG	3	White Painted Wood	8902-NG	3
Earthen Warp	5880-58	2	Oiled Legno	8846-58	2	White Twill	9285-58	2
Earthenware	8241-58	2	Oiled Olivewood	5481-43	2	White Washed Birchply	6372-NG	3
Ebony	9012-NT	2	Oiled Walnut	5487-NT	2	Wild Cherry	5904-43	2
Ebony Oxide	299-58	2	Orange Felt	4973-PA	3	Winter Sky	8792-58	2
Elemental Concrete	8830-58	2	Otter	3202-58	2	Winter Sky Birchply	8912-NG	3
Elemental Stone	8831-58	2	Oxidized Beamwood	9484-NG	3	Yellow Felt	4972-PA	3
Enamel	8794-58	2	Oyster Gray	929-58	2	Zebrano	9011-NT	2
Espresso Pear	5489-NT	2	Paint Scrape Sky	8995-PX	3			
Figured Annigre	7284-58	2	Paint Scrape Steel	8994-PX	3			
Finnish Oak	118-58	2	Paloma Polar	6698-58	2			
Flax Gauze	7708-58	2	Pearl	934-58	2			
Fog	961-58	2	Pecan Woodline	5883-58	2			
Folkstone	927-SP	3	Pencil Wood	7747-58	2			
Folkstone Celesta	692-58	2	Planked Coffee Oak	7413-PG	3			

NOSH

## Nevamar Laminate Tier

JSI offers an extensive program for laminates beyond our Standard Program. Always reference our website for the most current listing when using a [Graded-In Laminate](#), on page 155 select the color of the PVC edge color.

Laminate	Pattern #	Tier	Laminate	Pattern #	Tier	Laminate	Pattern #	Tier
Adaptable Muse	VU6001 T	3	Crema-ARP	WZ0049 T	3	Legendary Teak	WT0004 T	3
Aged Elements	EM6001 T	3	Crema-Timberline	WZ0049 TL	3	Liberty Red-ARP	S1027 T	3
Almond-ARP	S2037 T	3	Crème Tranquility	TQ2001 T	3	Liberty Red-Linez	S1027 LZ	3
Aluminite	AM6001 T	3	Crest Mahogany	W8343 PV	3	Limeade-ARP	SV7410 T	3
Amber Pearwood	WM8342 T	3	Crown Cherry	W8294 T	3	Limeade-Fineline	SV7410 FL	3
Antique White	S7005 T	3	Cutting Edge	WZ2009 T	3	Lino Frieze	FZ2001 T	3
Antoccino	WK0022 T	3	Decadent Allusion	ALN002 T	3	Luminary Teak	WT0005T	3
Aqua Lagoon	S5059 T	3	Deep Blue	S3022 T	3	Lunaria Shadow	LU6001 T	3
Babbling Brook	WW7800 T	3	Dove Gray	S6003 T	3	Macchiato-Aged Bark	WF0011 AB	3
Bailey-ARP	WK0027 T	3	Dragonfly	WZ0062 T	3	Macchiato-ARP	WF0011 T	3
Bailey-Fineline	WK0027 FL	3	Dry Creek Plum	WZ6001 T	3	Madura Gold Granite	GR4001 T	3
Basic Black Hautelink	HLT001 T	3	Easy Elegance	VA5002 T	3	Maize Shibori	SH2002 T	3
Basic	S2110 T	3	Edenwood	WF0001 T	3	Mallow White	S7038 T	3
Beige	S2019 T	3	Eiskaffe	WZ0056 T	3	Manhattan Glamour	MH6001 T	3
Beige Renaissance	WM8258 T	3	Endless Journey	WW0900 VE	3	Manhattan Gleam	MH8001 T	3
Bethany Beige	S2069 T	3	English Lace	S2085 T	3	Manhattan Glitz	MH4001 T	3
Birch Matrix	MR6008 T	3	Extreme Green Bamboo	WZ5001 T	3	Maritime Gray	S6027 T	3
Black Lodestone	LD6001 T	3	Fiji-ARP	SB0300 T	3	Marocchino	WK0023 PV	3
Black Pearl	S6014 T	3	Fiji-Fineline	SB0300 FL	3	Marrakesh Express	KH2001 T	3
Black-ARP	S6001 T	3	Fine Sycamore	W8351 T	3	Mazagran	WZ0052 T	3
Blissful Path	AT8000 T	3	Fossil Gray	S6031 T	3	Mikado Woodprint	WZ0002 T	3
Blossom Cherry	WC5581 MG	3	Foundry	S2084 T	3	Modern Edge	WZ6004 T	3
Blue Lunaria	LU3001 T	3	Frappe	LN6001 T	3	Natural Bamboo	WZ0018 T	3
Blue Shimmer Hautelink	HLB001 T	3	French Blue matrix	MR3003 T	3	Natural Beige	S2063 T	3
Bohemian Edge	WO1400 WE	3	Fresh Papaya	S8001 T	3	Navy Matrix II	MR3008 T	3
Bone White	S7032 T	3	Galao	WX0075 AB	3	Neutra Matrix	MR2003 T	3
Botanical Allusion	AL5002 T	3	Galloway Burl	WZ0017 T	3	Neutra	S7025 T	3
Brave Spirit	WU0060 T	3	Garden Mist	SG0004 T	3	Neutral Gray	S6012 T	3
Breve	WZ0054 T	3	Giant Gray Bamboo	WX1150 PV	3	Ochre Tempura	TM2001 T	3
Burgundy	S1015 T	3	Glistening Trail	WH1000 WE	3	Outer Limits	WU0010 WE	3
Café Allusion	AL2004 T	3	Golden Allusion	AL2002 T	3	Painted Woodlands	PDG002 T	3
Café Sienna	S03300 T	3	Golden Anigre	WA0001 SD	3	Palazzo	WK0024 T	3
Calcutta Marble	MW5800 SD	3	Golden Ash	WM8110 T	3	Papier Au Lait	PR2002 T	3
Calm Distinction	VA6001 T	3	Golden Years	AY1300 SD	3	Paris White Potteryware	PO7001 T	3
Caluna Cherry	WC2001 T	3	Grand Isle Maple	W8371 T	3	Passionfruit-ARP	SR5240 T	3
Calyпсо	WZ0057 T	3	Graphite Blue	S3023 T	3	Passionfruit-Fineline	SR5240 FL	3
Canyon Fissure	FS2001 T	3	Gray Matrix	MR6001 T	3	Patriot Blue	S3048 T	3
Carajillo	WZ0055 T	3	Gray Tranquility	TQ6001 T	3	Penny Lane-Textured	AT7500 SD	3
Caribbean Blue	S3070 T	3	Green Matrix II	MR5007 T	3	Suede		
Carmel Sagawood	WM8350 T	3	Greige Matrix	MR2002 T	3	Penny Lane-Timberline	AT7500 TL	3
Carmen Red	S1049 T	3	Gunmetal	S6020 T	3	Phantom Gray Matrix	MR6007 T	3
Casa Piedra	CK2002 T	3	Herbal Allusion	AL5001 T	3	Porcelain	S2050 T	3
Chai	WK0025 T	3	Honey Maple-ARP	WM8322 T	3	Precision White	S7036 T	3
Chalk White-ARP	S7024 T	3	Honey Plantain	S4025 T	3	Pure Spun Yarn	YSN002 T	3
Chalk White-Barnboard	S7024 BB	3	House Rock	RK4001 T	3	Rare Earth Slate	SL6003 T	3
Chalk White-Groovy	S7024 GV	3	Hybrid Slate	SL6002 T	3	Raven	S6033 T	3
Champagne Sagawood	WM8349 T	3	Iconic Maple-Aged Bark	WM0047 AB	3	Recon Oak	WZ0005 MG	3
Charcoal Essence	ES6002 T	3	Iconic Maple-ARP	WM0047 T	3	Red Dragon Bamboo	WZ1001 T	3
Charcoal Fusion	FN6001 T	3	Illustrious Maple	WM0046 T	3	Red Hot Allusion	ALR003 T	3
Charcoal Matrix	MR6002 T	3	Ivory Essence	ES2001 T	3	Regency Mahogany	W8352 VE	3
Cinder Gray Matrix	MR6006 T	3	Jett Black-ARP	S6053 T	3	Regimental Blue	S3016 T	3
Classic Rock	RK2001 T	3	Jett Black-Groovy	S6053 GV	3	Roaring Wind	WX8500 VE	3
Clear Maple	WM8340 T	3	Jett Black-Super Matte	S6053 SM	3	Rollin' Rock	RK2002 T	3
Cocoa Bean-ARP	S2115 T	3	Jute	S2086 T	3	Royal Mahogany	WS9450 MG	3
Cocoa Bean-Groovy	S2115 GV	3	Kendo	WZ2004 T	3	Rugged Trail	WH0050 PV	3
Cognac Birdseye	W8348 VE	3	Kindred Spirit	WU0030 WE	3	Rush	FS6001 T	3
Cool Chic	VA7002 T	3	Kona Blend	WZ0028 PV	3	Rustic Quartered Oak	WM8164 T	3
Copper Fusion 2	FN1002 T	3	Kool Kiwi	S5057 T	3	Sandcastle	S2093 T	3
Cordial Gray	S6024 T	3	Kopi Susu	LN6002 T	3	Sandpiper	S6047 T	3

NOSH

## Nevamar Laminate Tier (Continued)

JSI offers an extensive program for laminates beyond our Standard Program. Always reference our website for the most current listing when using a [Graded-In Laminate](#), on page 155 select the color of the PVC edge color.

Laminate	Pattern #	Tier	Laminate	Pattern #	Tier
Santa Rosa Plum	WZ2001 T	3	Vous Metal	VS6001 T	3
Scandia Maple	WM5577 SD	3	Vous Serene	VS5002 T	3
Serene Stardom	VA5001 T	3	Vous Tempest	VS6002 T	3
Shibui Woodprint	WZ0001 T	3	Wall Street Allusion	ALT005 T	3
Sienna Essence	ES2003 T	3	Washington Apple	WF0002 SD	3
Silver Alu Metalx	MXT003 T	3	Weathered Storm	WP3000 AB	3
Silver Dollar-Linez	AG8000 LZ	3	Whispering Wind	WX4600 VE	3
Silver Dollar-Textured Suede	AG8000 SD	3	White Essence	ES7001 T	3
Silver Wings	AG6300 SD	3	White Phantasy	PH7001 T	3
Silverline Hautelink	HLT004 T	3	Wild Oats Matrix	MR7002 T	3
Simplicity	WO7100 WE	3	Winter Gray Matrix	MR6005 T	3
Siren Maple	WM0005 T	3	Woodstock Granite	GR2004 T	3
Smoky White	S7027 T	3	Wrought Iron	S6054 T	3
Solid White	S7004 T	3	Xanadu Blue Bamboo	WZ3001 T	3
Sovereign Cherry	W8325 T	3	Yunnan	WZ0063 T	3
Spa White	S7040 T	3	Zebrano White	WZ0080 TL	3
Spicy Flavors	S8002 T	3	Zulu	WZ0053 T	3
Stainless Metalx	MXT002 T	3			
Stepping Stone	AE0500 SD	3			
Storm Gray Matrix	MR6004 T	3			
Stout Walnut	WW3100 T	3			
Straightaway Oak	WO0040 T	3			
Straw Matrix	MR2006 T	3			
String	S6052 T	3			
Studio Gray	S6037 T	3			
Studio White Matrix	MR7001 T	3			
Summer Night Glow	S8003 T	3			
Sunbeam	WW9000 WE	3			
Sunken Treasure	S3068 T	3			
Sunray	S4022 T	3			
Tangier Anigre	WA0002 SD	3			
Tawny Satinwood	WZ003 T	3			
Tea Stain Spun Yarn	YSN001 T	3			
Tendu	WZ2007 PV	3			
Topaz Khayawood	W8369 T	3			
Tranquility	WA3000 VE	3			
Tropical Allusion	ALB001 T	3			
Tyrian Purple	SP4170 T	3			
Umber Tempera	TM2002 T	3			
Untold Journey	WW4400 VE	3			
Urban Garden	AV2100 T	3			
Urban Life	AG1900 T	3			
Valencia Teak	WT0003 PV	3			
Validate We Do	WZ0045 T	3			
Vanilla Bean	VS2002 T	3			
Vantage Point Walnut	WW0013 MG	3			
Varnish	VS2003 T	3			
Venerable Old Oak-ARP	WK0017 T	3			
Venerable Old Oak-Barnboard	WK0017 BB	3			
Verdict's In	RK6003 T	3			
Vermont Maple	WM5528 SD	3			
Veta Shadows	VE6001 T	3			
Veto Proof	RK7002 T	3			
Violine	S3055 T	3			
Visible Vava	VA2001 T	3			
Vision Vava	VA2002 T	3			
Vous Fawn	VS2001 T	3			

## Pionite Laminate Tier

JSI offers an extensive program for laminates beyond our Standard Program. Always reference our website for the most current listing when using a [Graded-In Laminate](#), on page 155 select the color of the PVC edge color.

Laminate	Pattern #	Tier	Laminate	Pattern #	Tier	Laminate	Pattern #	Tier
A Good Book	WW120-WE	3	Dolphin Gray	SG246-SD	3	Mellow Marron	AT965-SD	3
Abraham	MG130-SX	3	Earle Gray Sorbe	WZ160-WE	3	Mercury	SG204-SD	3
Absolute Acajou -Textured Suede	WY160-SD	3	Eggshell White-Suede	CW803-SD	3	Meteoric Metallo	AG180-SD	3
Absolute Acajou - Timberline	WY160-TL	3	Eggshell White -Textured Suede	SW803-SD	3	Millwork Cherry	WC431-PV	3
Afternoon Nap	WA120-SD	3	Estella	AG011-SD	3	Mineral Talc	AG381-SD	3
Afternoon Showers	HP360-SD	3	Faded Memories	ME100-SD	3	Mocha Almond Fudge	WX600-SD	3
Agatha	AT181-SD	3	Fine Oak	WO951-SD	3	Molten Lava	WP130-SD	3
Aimtoo Savatre	WC115-SD	3	First Kiss -Fineline	SR537-FL	3	Moon Dust	MG115-SX	3
Almond -Textured Suede	ST655-SD	3	First Kiss -Textured Suede	SR537-SD	3	Moonlighting Papel	AV971-SD	3
Amber Curly Maple	WM221-SD	3	First N Main	AG031-SD	3	Moss Gray	SG240-SD	3
America's Pastime	WE360-SD	3	Folkstone Gray	SG241-SD	3	Mud Pie	AT970-LR	3
Angel White -Textured Suede	CW826-SD	3	Formal Mahogany	WY031-SD	3	Navajo Red	SR505-SD	3
Anigre	WX041-SD	3	Forsythia	SY913-SD	3	Navy Blue	SB007-SD	3
Appears Likatre	WP115-SD	3	Frederick	MT310-GR	3	Negotiating in Geneva	PFA60-SD	3
Arctic Flash	ME051-SD	3	Fresh Cut Grass -Textured Suede	SV750-SD	3	Nubian Brown	ST604-SD	3
Ash Gray	SG254-SD	3	Galactic Dust	MG180-SD	3	Oiled Cherry	WC421-SD	3
Azzurra	AB081-SD	3	Ginger Snap	AY120-SD	3	Old Friend	AG415-SD	3
Backwoods Sycamore	HP689-SD	3	Gold Pannin	AT710-SD	3	Olive Organix	AV674-SD	3
Bankers Gray -Textured Suede	SG214-SD	3	Grandiose Grid	AT106-SD	3	Opti Gray	SG213-SD	3
Beachcomber	AT988-SD	3	Graphite Spektrum	AE021-SD	3	Opto Printatre	WX230-SD	3
Beige Linen	AT301-SD	3	Graphite Talc	AG361-SD	3	Ornate Oak	WO095-SD	3
Bernard	MG071-GR	3	Graveyard of the Atlantic	AG611-SD	3	Passin Through	AV250-SD	3
Bittersweet	SO312-SD	3	Greige -Textured Suede	SG210-SD	3	Peach Cobbler	WT850-SD	3
Black Forest Cake	WX440-SD	3	Gridlock in L.A.	PFA51-SD	3	Peanut Brittle	WZ150-SD	3
Black -Textured Suede	SE101-SD	3	Gunstock Savoy Walnut	WW971-SD	3	Pearl of the Orient	AG601-SD	3
Blueberry Hill	SB040-SD	3	Happy Hour	AB400-SD	3	Pearwood	WX031-SD	3
Butter Toffee	WC230-PV	3	Hardrock Maple	WM791-SD	3	Pepperdust	HP451-SD	3
Cake Batter	AG500-LR	3	Harold	MG120-SX	3	Picnic In The Park -Super Matte	WA030-SM	3
Cardamom Fiber	AG371-SD	3	Hazel	MT390-SX	3	Picnic In The Park - Textured Suede	WA030-SD	3
Carnation White -Ashwood	SW806-AW	3	Head Over Heels -Fineline	AB300-FL	3	Polar Cap	MW570-SL	3
Carnation White -Textured Suede	SW806-SD	3	Head Over Heels -Textured Suede	AB300-SD	3	Pralines & Cream -Fineline	WW160-FL	3
Catching Fireflies	WA110-SD	3	Hearth Oak	WO862-SD	3	Pralines & Cream - Textured Suede	WW160-SD	3
Cavalcade South	AT650-SD	3	Hedgerow	MG170-SL	3	Primary Red	SR520-SD	3
Celery Fiber	AV751-SD	3	Honey Maple -Textured Suede	WM951-SD	3	Primary Yellow	SY914-SD	3
Chamomile Fiber	AT291-SD	3	Ice Fishin	WF181-SD	3	Pumice	SG203-SD	3
Charcoal Chromatix	AE011-CR	3	Ice White	SW813-SD	3	Pyrenees Marble	ME011-GL	3
Chocolate Malt	WC210-PV	3	IL Palio Papel	AV981-SD	3	Rock Around the Clock	MT340-SD	3
Cinder Gray Concrete	AG471-SD	3	Indigo Blue	SB006-SD	3	Rock Around the Clock II	MT500-SD	3
Cinnamon Noce	WW601-SD	3	Ingot Gray	SG211-SD	3	Rock of Ages	AW141-SD	3
City of Lights	MT330-SD	3	Jewel Mahogany-Textured Suede	WY351-SD	3	Rocky Mountain High	AT161-SD	3
Clear Ash	WA001-SD	3	Jumping In Puddles	AG801-SD	3	Royal Blue	SB009-SD	3
Coastal Cottage	WC652-WE	3	Kingsley-Aged Bark	WW011-AB	3	Royal Burgundy	SP401-SD	3
Connected Cubes	AT440-SD	3	Kingsley -Textured Suede	WW011-SD	3	Sable	AG021-SD	3
Cookies & Cream	AG130-SM	3	Leave Likatre	WP120-SD	3	Sage Coral	AV781-SD	3
Cool Autumn Night	WT880-SD	3	Licorice Stick	WP140-SD	3	Seems Likatre	WP125-SD	3
Coriander Fiber	AT981-SD	3	Limestone	SG208-SD	3	Shaker Cherry	WC521-SD	3
Cornwall	MT440-SD	3	Little Black Dress	AE100-PV	3	Sherwood Oak	WO891-SD	3
Crackle Crunch	WO680-LZ	3	Looks Likatre	WP110-SD	3	Shooting Star	AG041-SX	3
Cradle of Liberty	AB221-SD	3	Louise	MR120-SX	3	Silvio	WY131-SD	3
Cressida	AT371-SD	3	Love Letters	AW300-SD	3	Sipping Seattle Java	PFA48-SD	3
Crisscross	AT660-SD	3	Lunar Legno	WX800-SD	3	Slate	SG228-SD	3
Cubicle Papel	AG561-SD	3	Macadamia Nut	AG071-SD	3	Sleeping In -Textured Suede	WT870-SD	3
Daydreaming	AG750-SD	3	Man On The Moon	MT250-SD	3	Sleeping In -Timberline	WT870-TL	3
Dining By Candle Light	WA090-SD	3	Manila Linen	AT231-SD	3	Smooth Paddlin	WX110-SD	3



## Pionite Laminate Tier (Continued)

JSI offers an extensive program for laminates beyond our Standard Program. Always reference our website for the most current listing when using a [Graded-In Laminate](#), on page 155 select the color of the PVC edge color.

Laminate	Pattern #	Tier
S'mores	WP500-LZ	3
Spice Walnut	WW561-SD	3
Springtime	SV709-SD	3
Stargazing	AE060-SD	3
Stonedust	SG224-SD	3
Storm Gray	HP565-SD	3
Sugar Maple II	WM115-SD	3
Sugar Pie	AG081-SM	3
Summer Vacation - Textured Suede	SB027-SD	3
Sunset	HP336-SD	3
Sweet 16 -Fineline	SR525-FL	3
Sweet 16 -Textured Suede	SR525-SD	3
Tailgating	WT860-SD	3
Taj Teak	WT741-SD	3
Taupe	ST606-SD	3
Tea Party in Boston	PFA42-SD	3
Theodore	MR125-SX	3
Thunderstorm	HP359-PV	3
Tiramisu	WX170-SD	3
Toasted Coconut	WZ460-WE	3
Travelin Light	AT680-SD	3
Upland Stone	MG160-SL	3
Vana	WF131-SD	3
Vanilla Fiber	AW871-SD	3
Victorian Cherry	WC331-PV	3
Viola	AT191-SD	3
Walnut Grove -Textured Suede	WW050-SD	3
Walnut Grove -Timberline	WW050-TL	3
Wedding Cake -Barnboard	WT790-BB	3
Wedding Cake -Textured Suede	WT790-SD	3
Wheat Fiber	AT991-SD	3
White Elm -Super Matte	WE261-SM	3
White Elm -Textured Suede	WE261-SD	3
White Fiesta	MW550-SD	3
White	SW811-SD	3
White Spektrum	AW785-SD	3
Winter White -Textured Suede	SW836-SD	3
Wisconsin Oak	W0581-SD	3
Witchcraft -Polished Velvet	WX421-PV	3
Yorkshire Cherry	WC411-SD	3

## Wilsonart Laminate Tier

JSI offers an extensive program for laminates beyond our Standard Program. Always reference our website for the most current listing when using a [Graded-In Laminate](#), on page 155 select the color of the PVC edge color.

Laminate	Pattern #	Tier	Laminate	Pattern #	Tier	Laminate	Pattern #	Tier
Almond Leather	2932-60	2	Hampton Walnut	7959K-78	3	Polished Concrete	5022K-22	3
Amaretto Pine	8224K-16	3	Harvest Maple	7953-38	2	Port	D14-60	2
Amber Cherry	7919K-78	3	High Rise	4996-38	2	Portico Teak	8210K-28	3
Antique Bourbon Pine	8215K-12	3	Hollyberry	D307-60	2	Potter's Clay	5011K-22	3
Antique Marula Pine	8216K-28	3	Huntington Maple	7929-38	2	Pressed Linen	4991-38	2
Antique White-Matte	1572-60	2	Indigo	D379-60	2	Putty	1503-60	2
Asian Night	7949K-18	3	Irish Linen	4993-38	2	Raw Chestnut	7975K-12	3
Asian Sand	7952K-18	3	Island	D498K-18	3	Raw Cotton	4947-38	2
Asian Sun	7951K-18	3	Italian Silver Ash	8217K-16	3	Regimental Red	D12K-18	3
Astro Strandz	4940K-18	3	Khaki Brown	D50-60	2	Rio	7947K-18	3
Atlantis	D25-60	2	Kingswood Walnut	8218-38	2	River Cherry	7937-38	2
Bannister Oak	7806-60	2	Landmark Wood	7981K-12	3	Rugged Linen	4989-38	2
Battleship	5014K-19	3	Lapis Blue	D417-60	2	Rustic Slate	4888-38	2
Beige	1530-60	2	Light Beige	1531-60	2	Sable Soapstone	4883-38	2
Beige Pampus	4170-60	2	Light Oak Ply	8202K-28	3	Saddle Oak	8206K-16	3
Beigewood	7850-60	2	Limber Maple	10734-60	2	Sap Walnut	8221-38	2
Biltmore Cherry	7924K-07	3	Linen	D427-60	2	Satin Stainless	4830K-18	3
Black	1595-60	2	Loden Zephyr	4844-60	2	Shadow Zephyr	4857-60	2
Black Alicante	4926K-07	3	Loft Oak	7968K-12	3	Shaker Cherry	7935K-07	3
Blackbird	5024K-19	3	Low Line	7998K-18	3	Sheer Mesh	4876-38	2
Blackened Chestnut	8223K-12	3	Lowell Ash	7994-38	2	Sierra Cascade	5005-38	2
Blue Agave	4919-60	2	Madagascar	7944K-07	3	Silicon EV	4811-60	2
Boardwalk Oak	7983-38	2	Magnolia	5012K-19	3	Silver Alchemy	4860K-07	3
Branded Oak	8207K-16	3	Mambo	7948K-07	3	Silver Oak Ply	8203K-28	3
Brittany Blue	D321-60	2	Mangalore Mango	7984-38	2	Skyline Walnut	7964K-12	3
Bronze Legacy	4656-60	2	Manitoba Maple	7911-60	2	Soft Gold Mesh	4911-38	2
Buka Bark	7982-38	2	Marmo Bianco	1885K-07	3	Solar Oak	7816-60	2
Burnished Chestnut	4796-60	2	Maroochy Brush	4745-60	2	Sprout	4918-60	2
Calcutta Marble	4925K-07	3	Midnight	D505-60	2	Steel Mesh	4879-38	2
Canyon Zephyr	4842-60	2	Mission Maple	7990-38	2	Sterling Ash	7995-38	2
Carbon EV	4820-60	2	Misted Zephyr	4843-60	2	Tailored Linen	4992-38	2
Carbon Mesh	4880-38	2	Montana Walnut	7110K-78	3	Tan Echo	7941K-18	3
Castle Oak	7928-38	2	Monticello Maple	7925-38	2	Tan Soapstone	4887-38	2
Casual Linen	4944-38	2	Morelia Mango	7985-38	2	Tangerine	4915-60	2
Cement	D503-60	2	Morro Zephyr	4846-60	2	Tawny Legacy	4663-60	2
Classic Linen	4943-38	2	Mushroom	5013K-19	3	Titanium EV	4810-60	2
Cloud Nebula	4630-60	2	Natural Almond	D30-60	2	Tungsten EV	4814-60	2
Cloud Zephyr	4856-60	2	Natural Cotton	4946-38	2	Tuscan Walnut	7921-38	2
Cocobala	7942K-07	3	Natural Nebula	4633-60	2	Twilight Zephyr	4845-60	2
Coffee Bean	D495-60	2	Natural Pear	7061-60	2	Uptown Walnut	7971K-12	3
Colombian Walnut	7943K-07	3	Natural Recon	7996-38	2	Vapor Strandz	4939K-18	3
Cosmic Strandz	4941K-18	3	Natural Rift	7954-38	2	Veranda Teak	8209K-28	3
Crisp Linen	4942-38	2	Natural Tigris	4669-60	2	Versailles Anigre	7923K-07	3
Crystal	D388-60	2	Navy Legacy	4651-60	2	Wallaby	D439-60	2
Desert Zephyr	4841-60	2	NeoWalnut	7991-38	2	Warehouse Oak	7969K-12	3
Ebony Char	8205K-16	3	Nepal Teak	7209K-78	3	Washed Char	8222K-16	3
Ebony Recon	7997-38	2	Neutral Glace	4143-60	2	Washi Crystal	5017-38	2
Eggplant	4913-60	2	New Age Oak	7938-38	2	Washi Gold	5019-38	2
Evening Tigris	4674-60	2	Nickel EV	4813-60	2	Washi Pewter	5018-38	2
Fashion Grey	D381-60	2	Nightfall	5023K-19	3	Weathered Char	8204K-16	3
Fawn Cypress	8208K-16	3	Nordic Linen	5015-38	2	White Barn	7977K-12	3
Field Elm	7999K-12	3	North Sea	D90-60	2	White Carrara	4924-38	2
Figured Mahogany	7040K-78	3	Ocean	D502K-18	3	White Cascade	5003-38	2
Fired Steel	4994-60	2	Oiled Soapstone	4882-38	2	White Cypress	7976K-12	3
Flax Linen	4990-38	2	Old Mill Oak	7973K-12	3	White Driftwood	8200K-16	3
Fonthill Pear	10745-60	2	Orange Grove	D501-60	2	White Nebula	4621-60	2
Forged Steel	4995-60	2	Organic Cotton	4945-38	2	White Sand	D403-60	2
Fossil Shale	D504-60	2	Oxide	1787-60	2	White Tigris	4783-60	2
French Linen	5016-38	2	Palisades Oak	7987-38	2	White-Matte	1570-60	2
French Pear	8220-38	2	Pampus	4166-60	2	Wild Cherry	7054-60	2
Fusion Maple	7909-60	2	Park Elm	7967K-12	3	Windsor Mahogany	7039K-78	3
Gesso Tracery	4962-38	2	Pasadena Oak	7986-38	2	Windswept Bronze	4794-38	2
Glided Mesh	4912-38	2	Pearl Soapstone	4886-38	2	Windswept Pewter	4795-60	2
Graphite Nebula	4623-60	2	Pepperdust	D327-60	2	Woolamai Brush	4746-60	2
Green Soapstone	4885-38	2	Pewter	D73-60	2	Xanadu	7945K-18	3
Green Tigris	4667-60	2	Pewter Brush	4779-60	2	Zanzibar	7957K-78	3
Grey	1500-60	2	Pewter Mesh	4878-38	2	ZebraWood	7980K-18	3
Grey Elm	8201K-12	3	Phantom Charcoal	8214K-28	3			
Grey Glace	4142-60	2	Phantom Cocoa	8213K-28	3			
Grey Mesh	4877-38	2	Phantom Ecru	8212K-28	3			
Grey Nebula	4622-60	2	Phantom Pearl	8211K-28	3			
Grey Pampus	4168-60	2	Pinball	4937-38	2			

NOSH

## Nosh Product Information

### Veneer Tops

Tops are 1 3/8" thick, 5 ply balanced construction with particle board core. Standard Tier 1 veneer is flat cut, book matched for cherry, maple and walnut veneer. Standard Tier 2 veneer is double cut.

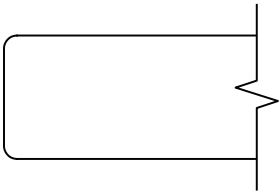

**Eased Edge (R3)**  
Internal Lumber Band

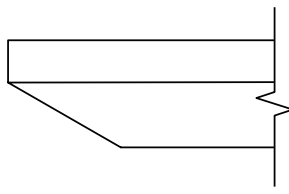

**Reverse Bevel (K9)**  
Veneer Band on Stained MDF

### Finish - Stain/Colors

Flat Cuts are Tier 1 Veneer pricing, while Double Cut is Tier 2 Veneer pricing. Finishes with an asterisk (\*) have coordinating laminate tops.

**CH1 Cherry** *Flat Cut Veneer*

BRL Barley	EAR Earthy
BBN Bourbon	HRV Harvest*
BRG Brighton	LGC Legacy
CLA Classic	PRL Praline*
CLL Collectors*	SAF Saffron

**MA1 Maple** *Flat Cut Veneer*

ALE Ale	FLX Flax
BUT Butterscotch	VEN Venetian
CIN Cinnamon	

**WA1 Walnut** *Flat Cut Veneer*

AUB Auburn	SIE Sienna*
ESP Espresso	TOF Toffee
MCH Mocha*	TRF Truffle*
NTO Night Owl*	

**DC1 Double Cut Veneer**

COF Coffee	GRH Graphite
CRM Cremello	KHK Khaki
FOS Fossil	STU Studio Teak

HSON

## Nosh Product Information

### Solid Surface Tops

Tops are 1 3/16" thick constructed of 1/2" thick Solid Surface on top of a 1/16" MDF sub top. Sub top has an under cut bevel profile and is painted in a coordinated color to match the Solid Surface.

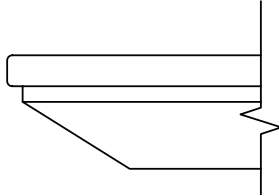

### Reverse Bevel Edge (K7)

Solid Surface over painted MDF

---

### Standard Solid Surface

#### Tier 1 (S1)

- ARM Armadillo
- BLP Black Pearl
- PEB Pebble Pearl
- PUR Pure White

## Nosh Product Information

### Base Styles

Nosh provides a choice selection of bases in both function and aesthetics to serve a variety of needs. It offers six base styles with: T-base, X-base, X-extended base, X4 base, Round Disc and Square Disc.

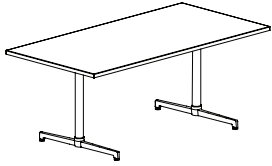

#### T-Base

- available in 29", 36" and 42"h
- used only with rectangular tops
- base finish bright white, matte black, pewter, arctic silver, or two-tone aesthetics are achieved when selecting arctic silver or polished aluminum foot

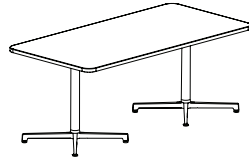

#### X-Base

- available in 29", 36" and 42"h
- used with all Nosh top shapes
- base finish bright white, matte black, pewter, arctic silver, or two-tone aesthetics are achieved when selecting arctic silver or polished aluminum foot
- power access version available with an upcharge

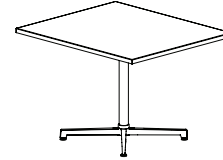

#### X-Extended Base

- available in 29"h only
- used with rectangular tops
- base finish bright white, matte black, pewter, arctic silver, or two-tone aesthetics are achieved when selecting arctic silver or polished aluminum foot
- cannot be used in conjunction with power cutouts

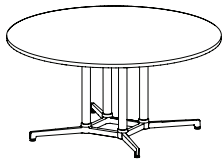

#### X4 Base

- available in 29", 36" and 42"h
- used only on round, rounded square and squircle tops
- base finish bright white, matte black, pewter, arctic silver, or two-tone aesthetics are achieved when selecting arctic silver or polished aluminum foot

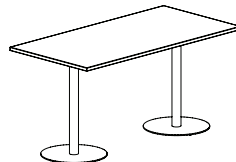

#### Round Disc

- available in 29", 36" and 42"h
- used with all Nosh top shapes
- base finish bright white, matte black, pewter, arctic silver, or two-tone aesthetics are achieved when selecting arctic silver foot

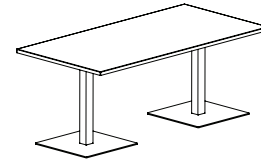

#### Square Disc

- available in 29", 36" and 42"h
- used with all Nosh top shapes
- base finish bright white, matte black, pewter, arctic silver, or two-tone aesthetics are achieved when selecting arctic silver foot
- round and square tables cannot be used in conjunction with power cutouts

### Two - Two Aesthetics.

#### T and X Base Two-Tone Finishes

##### a - Column

- Arctic Silver
- Bright White
- Matte Black
- Pewter

##### b - Base Rail Finish

- Arctic Silver
- Polished Aluminum

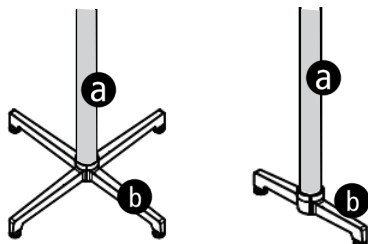

#### Round and Disc Base Two-Tone Finishes

##### a - Column

- Bright White
- Matte Black
- Pewter

##### b - Base Rail Finish

- Arctic Silver

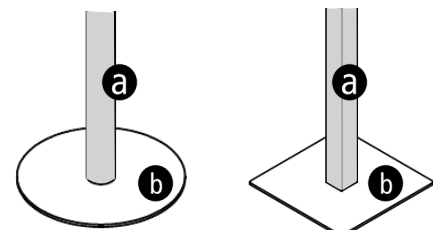

## Nosh Product Information

### Power/Charging Options

Nosh offers the ability to place power and charging options in the center of most tables. Select your choice of EC23 or EC24, available in black and white.

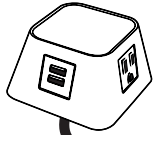

**Moire - EC23**

- Three 110 outlets
- Dual USB port with 72" power cord
- Black (B) or White (W)



**Node - EC24**

- One 110 outlet
- Dual USB port with 72" power cord
- Black (B) or White (W)

Cut outs are located in the center of each table. See below for representation or location.

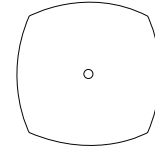
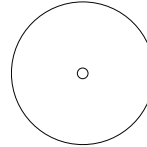
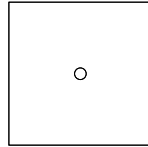
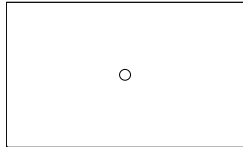

### Power Access Base

In round, square, rounded square and squircle tables that use X base, when you select power accessibility; the table is bored for the electrical unit and a power accessible base is used. This provides a drawn mounting bracket and the ability to run the power cord down through the base. See individual product pricing pages for upcharge.

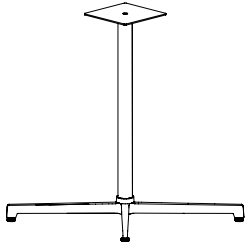

**Standard  
X Base**

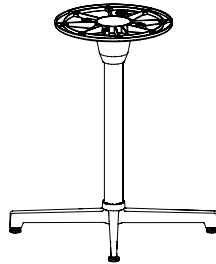

**Power Accessible  
X Base**

Description

Rectangular Table with T Base

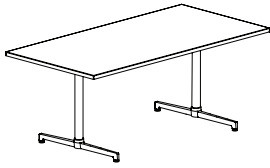

Laminate Tables  
"NST" Models

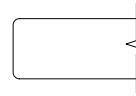

Eased Edge (R3)

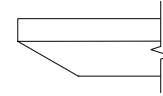

Reverse Bevel Edge (K9)

LAMINATE

D	W	H	CTN WT	CU FT	① Model	Eased Edge (R3)			Reverse Bevel Edge (K9)		
						Standard Tier 1	Graded In Tier 2	Graded In Tier 3	Standard Tier 1	Graded In Tier 2	Graded In Tier 3
36	72	29	136	47	NST3672-29TTT	\$1,467	\$1,523	\$1,645	\$1,836	\$1,893	\$2,014
36	66	29	127	44	NST3666-29TTT	\$1,415	\$1,467	\$1,579	\$1,785	\$1,836	\$1,949
36	60	29	119	38	NST3660-29TTT	\$1,353	\$1,402	\$1,501	\$1,722	\$1,771	\$1,870
36	54	29	111	33	NST3654-29TTT	\$1,208	\$1,253	\$1,344	\$1,579	\$1,624	\$1,714
36	48	29	96	46	NST3648-29TTT	\$1,127	\$1,166	\$1,245	\$1,496	\$1,538	\$1,615
30	72	29	120	47	NST3072-29TTT	\$1,245	\$1,295	\$1,394	\$1,615	\$1,664	\$1,764
30	66	29	103	41	NST3066-29TTT	\$1,194	\$1,240	\$1,330	\$1,563	\$1,609	\$1,699
30	60	29	106	36	NST3060-29TTT	\$1,131	\$1,175	\$1,254	\$1,501	\$1,544	\$1,625
30	54	29	99	33	NST3054-29TTT	\$1,088	\$1,124	\$1,199	\$1,457	\$1,495	\$1,568
30	48	29	85	33	NST3048-29TTT	\$1,023	\$1,059	\$1,122	\$1,392	\$1,429	\$1,492

Features:

- price reflects complete table - top and base
- ships KD in multiple cartons
- top has option for cutout to receive electrical component, ordered separately
- optional vertical wire manager for base, order separately
- base has leveling glides
- width of base foot is 27"

To Order Specify

① Laminate Model #	② Edge Detail	③ Laminate Selection	③a PVC Edge Color	④ Electrical Cut Out	⑤ Metal Finish
Laminate (NST)	R3 Eased	<b>Standard Laminates (T1)</b> Solid Patterns: ALB Alabaster      DWH Designer White BLK Black          SHD Shadow BBL Bridal Blanco    SLG Slate Grey  Wood Grain Patterns: AGA Aged Ash      GRH Graphite ALL Ale Light        HGL High Line BLO Blonde Echo    OAT Oatmeal Cookie BOL Bourbon Light    PIN Pinnacle Walnut BZW Brazilwood      STU Studio Teak BGL Brighton Light    VIN Vintage CLL Collectors        WLH Walnut Heights FLO Florence Walnut    WEA Weathered Ash	Color: <b>Standard (T1) laminates have a matching PVC.</b> AGA Aged Ash ALB Alabaster ALL Ale Light BLK Black BLO Blonde Echo BOL Bourbon Light BZW Brazilwood BBL Bridal Blanco BGL Brighton Light CLL Collectors DWH Designer White FLO Florence Walnut GRH Graphite HGL High Line OAT Oatmeal Cookie PIN Pinnacle Walnut SHD Shadow SLG Slate Grey STU Studio Teak VIN Vintage WLH Walnut Heights WEA Weathered Ash	N None CO_EC23 Cut out for EC23 CO_EC24 Cut out for EC24	BWH Bright White Feet & Post MBK Matte Black Feet & Post PEW Pewter Feet & Post ASLASL Arctic Silver Feet & Post ASLBWH Arctic Silver Feet & Bright White Post ASLMBK Arctic Silver Feet & Matte Black Post ASLPEW Arctic Silver Feet & Pewter Post PAMASL Polished Aluminum Feet & Arctic Silver Post PAMBWH Polished Aluminum Feet & Bright White Post PAMMBK Polished Aluminum Feet & Matte Black Post PAMPEW Polished Aluminum Feet & Pewter Post
	K9 Reverse Bevel				

Model Number Breakdown

NST3048-29TTT					
NS	T	3048	29	TT	T
Nosh	Laminate	30" x 48"	Height	Rectangular Top Shape	T Base

HSON

Description

Rectangular Table with T Base  
(continued)

Veneer Tops  
"NSV" Models

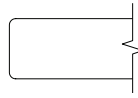

Eased Edge (R3)

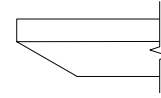

Reverse Bevel Edge (K9)

D	W	H	CTN WT	CU FT	① Model	Eased Edge (R3)		Reverse Bevel Edge (K9)	
						Flat Cut	Double Cut	Flat Cut	Double Cut
36	72	29	136	47	NSV3672-29TTT	\$1,715	\$1,876	\$1,856	\$2,016
36	66	29	127	44	NSV3666-29TTT	\$1,678	\$1,830	\$1,815	\$1,964
36	60	29	119	38	NSV3660-29TTT	\$1,629	\$1,770	\$1,761	\$1,898
36	54	29	111	33	NSV3654-29TTT	\$1,490	\$1,619	\$1,613	\$1,737
36	48	29	96	46	NSV3648-29TTT	\$1,456	\$1,574	\$1,572	\$1,688
30	72	29	120	47	NSV3072-29TTT	\$1,611	\$1,754	\$1,743	\$1,881
30	66	29	103	41	NSV3066-29TTT	\$1,564	\$1,697	\$1,691	\$1,819
30	60	29	106	36	NSV3060-29TTT	\$1,523	\$1,668	\$1,643	\$1,763
30	54	29	99	33	NSV3054-29TTT	\$1,391	\$1,503	\$1,502	\$1,609
30	48	29	85	33	NSV3048-29TTT	\$1,361	\$1,464	\$1,468	\$1,566

VENEER

NOSH

To Order Specify

① Veneer Model #	② Edge Detail	③ Wood Species	④ Wood Finish			⑤ Electrical Cut Out	⑥ Metal Finish
Veneer (NSV)	R3 Eased	Flat Cut CH1 Cherry MA1 Maple WA1 Walnut	Cherry:	Maple:	Walnut:	N None CO_EC23 Cut out for EC23 CO_EC24 Cut out for EC24	BWH Bright White Feet & Post MBK Matte Black Feet & Post PEW Pewter Feet & Post ASLASH Arctic Silver Feet & Post ASLBWH Arctic Silver Feet & Bright White Post ASLMBK Arctic Silver Feet & Matte Black Post ASLPEW Arctic Silver Feet & Pewter Post PAMASL Polished Aluminum Feet & Arctic Silver Post PAMBWH Polished Aluminum Feet & Bright White Post PAMMBK Polished Aluminum Feet & Matte Black Post PAMPEW Polished Aluminum Feet & Pewter Post
	K9 Reverse Bevel		BRL Barley BBM Bourbon Medium BRM Brighton Medium CLA Classic CLL Collectors* EAR Earthy HRV Harvest* LGC Legacy PRL Praline* SAF Saffron	ALM Ale Medium BUT Butterscotch CIN Cinnamon FLX Flax VEN Venetian	AUB Auburn ESP Espresso MCH Mocha* NTO Night Owl* SIE Sienna* TOF Toffee TRF Truffle*		
		Double Cut DC2 Double Cut	④ Wood Finish Double Cut: COF Coffee FOS Fossil KHK Khaki CRM Cremello GRH Graphite STU Studio Teak				



Description

Rounded Rectangular Table with T Base

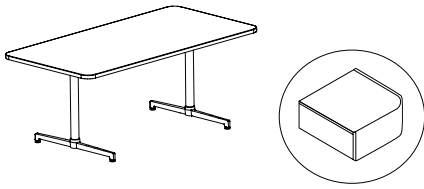

Laminate Tables  
"NST" Models

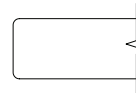

Eased Edge (R3)

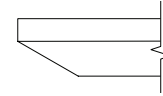

Reverse Bevel (K9)

LAMINATE

D	W	H	CTN WT	CU FT	① Model	Eased Edge (R3)			Reverse Bevel (K9)		
						Standard Tier 1	Graded In Tier 2	Graded In Tier 3	Standard Tier 1	Graded In Tier 2	Graded In Tier 3
36	72	29	129	47	NST3672-29TTRT	\$1,548	\$1,605	\$1,725	\$1,917	\$1,974	\$2,095
36	66	29	121	44	NST3666-29TTRT	\$1,501	\$1,553	\$1,662	\$1,870	\$1,923	\$2,032
36	60	29	112	38	NST3660-29TTRT	\$1,444	\$1,494	\$1,591	\$1,813	\$1,864	\$1,961
36	54	29	104	33	NST3654-29TTRT	\$1,251	\$1,295	\$1,384	\$1,620	\$1,664	\$1,754
36	48	29	89	46	NST3648-29TTRT	\$1,208	\$1,251	\$1,329	\$1,579	\$1,620	\$1,698
30	72	29	113	47	NST3072-29TTRT	\$1,406	\$1,456	\$1,553	\$1,776	\$1,826	\$1,923
30	66	29	106	41	NST3066-29TTRT	\$1,351	\$1,398	\$1,488	\$1,721	\$1,768	\$1,857
30	60	29	99	36	NST3060-29TTRT	\$1,303	\$1,348	\$1,427	\$1,674	\$1,718	\$1,797
30	54	29	92	33	NST3054-29TTRT	\$1,139	\$1,178	\$1,250	\$1,508	\$1,547	\$1,619
30	48	29	79	33	NST3048-29TTRT	\$1,103	\$1,140	\$1,202	\$1,473	\$1,509	\$1,571

Features:

- price reflects complete table - top and base
- ships KD in multiple cartons
- top has option for cutout to receive electrical component, ordered separately
- optional vertical wire manager for base, order separately
- base has leveling glides
- width of base foot is 27"

To Order Specify

① Laminate Model #	② Edge Detail	③ Laminate Selection	③a PVC Edge Color	④ Electrical Cut Out	⑤ Metal Finish
Laminate (NST)	R3 Eased	<b>Standard Laminates (T1)</b> Solid Patterns: ALB Alabaster      DWH Designer White BLK Black          SHD Shadow BBL Bridal Blanco    SLG Slate Grey  Wood Grain Patterns: AGA Aged Ash      GRH Graphite ALL Ale Light      HGL High Line BLO Blonde Echo    OAT Oatmeal Cookie BOL Bourbon Light    PIN Pinnacle Walnut BZW Brazilwood      STU Studio Teak BGL Brighton Light    VIN Vintage CLL Collectors        WLH Walnut Heights FLO Florence Walnut    WEA Weathered Ash	Color: <b>Standard (T1) laminates have a matching PVC.</b> AGA Aged Ash ALB Alabaster ALL Ale Light BLK Black BLO Blonde Echo BOL Bourbon Light BZW Brazilwood BBL Bridal Blanco BGL Brighton Light CLL Collectors DWH Designer White FLO Florence Walnut GRH Graphite HGL High Line OAT Oatmeal Cookie PIN Pinnacle Walnut SHD Shadow SLG Slate Grey STU Studio Teak VIN Vintage WLH Walnut Heights WEA Weathered Ash	N None CO_EC23 Cut out for EC23 CO_EC24 Cut out for EC24	BWH Bright White Feet & Post MBK Matte Black Feet & Post PEW Pewter Feet & Post ASLASL Arctic Silver Feet & Post ASLBWH Arctic Silver Feet & Bright White Post ASLMBK Arctic Silver Feet & Matte Black Post ASLPEW Arctic Silver Feet & Pewter Post PAMASL Polished Aluminum Feet & Arctic Silver Post PAMBWH Polished Aluminum Feet & Bright White Post PAMMBK Polished Aluminum Feet & Matte Black Post PAMPEW Polished Aluminum Feet & Pewter Post
	K9 Reverse Bevel				

Model Number Breakdown

NST3048-29TTRT						
NS	T	3048	29	TT	R	T
Nosh	Laminate	30" x 48"	Height	Rectangular Top Shape	Rounded Corner	T Base

NOSH

Description

Rounded Rectangular Table with T Base  
(continued)

Veneer Tables  
"NSV" Models

Solid Surface Tables  
"NSS" Models

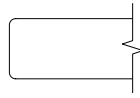

Eased Edge (R3)

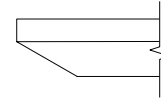

Reverse Bevel Edge (K9)

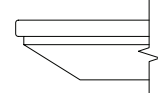

Reverse Bevel Edge (S7)

	D	W	H	CTN WT	CU FT	① Model	Veneer Tables "NSV" Models		Solid Surface Tables "NSS" Models		
							Flat Cut	Double Cut	Flat Cut	Double Cut	Standard
VENEER	36	72	29	129	47	NSV3672-29TTRT	\$1,843	\$2,013	\$1,913	\$2,075	--
	36	66	29	121	44	NSV3666-29TTRT	\$1,805	\$1,964	\$1,872	\$2,021	--
	36	60	29	112	38	NSV3660-29TTRT	\$1,750	\$1,898	\$1,814	\$1,953	--
	36	54	29	104	33	NSV3654-29TTRT	\$1,598	\$1,733	\$1,657	\$1,783	--
	36	48	29	89	46	NSV3648-29TTRT	\$1,561	\$1,683	\$1,616	\$1,732	--
	30	72	29	113	47	NSV3072-29TTRT	\$1,726	\$1,876	\$1,790	\$1,929	--
	30	66	29	106	41	NSV3066-29TTRT	\$1,676	\$1,815	\$1,728	\$1,857	--
	30	60	29	99	36	NSV3060-29TTRT	\$1,632	\$1,760	\$1,686	\$1,808	--
	30	54	29	92	33	NSV3054-29TTRT	\$1,490	\$1,607	\$1,538	\$1,646	--
	30	48	29	79	33	NSV3048-29TTRT	\$1,459	\$1,565	\$1,508	\$1,608	--
SOLID SURFACE	36	72	29	170	47	NSS3672-29TTRT	--	--	--	--	\$4,478
	36	66	29	158	44	NSS3666-29TTRT	--	--	--	--	\$4,251
	36	60	29	140	28	NSS3660-29TTRT	--	--	--	--	\$4,011
	36	54	29	129	33	NSS3654-29TTRT	--	--	--	--	\$3,670
	36	48	29	118	46	NSS3648-29TTRT	--	--	--	--	\$3,445
	30	72	29	144	47	NSS3072-29TTRT	--	--	--	--	\$3,988
	30	66	29	137	41	NSS3066-29TTRT	--	--	--	--	\$3,780
	30	60	29	128	36	NSS3060-29TTRT	--	--	--	--	\$3,579
	30	54	29	117	33	NSS3054-29TTRT	--	--	--	--	\$3,282
	30	48	29	151	33	NSS3048-29TTRT	--	--	--	--	\$3,096

To Order Specify

① Veneer Model #	② Edge Detail	③ Wood Species	④ Wood Finish	⑤ Electrical Cut Out	⑥ Metal Finish		
Veneer (NSV)	R3 Eased K9 Reverse Bevel	<b>Flat Cut</b> CH1 Cherry MA1 Maple WA1 Walnut	Cherry: BRL Barley BBM Bourbon Medium BRM Brighton Medium CLA Classic CLL Collectors* EAR Earthy HRV Harvest* LGC Legacy PRL Praline* SAF Saffron	Maple: ALM Ale Medium BUT Butterscotch CIN Cinnamon FLX Flax VEN Venetian	Walnut: AUB Auburn ESP Espresso MCH Mocha* NTO Night Owl* SIE Sienna* TOF Toffee TRF Truffle*	N None CO_EC23 Cut out for EC23 CO_EC24 Cut out for EC24	BWH Bright White Feet & Post MBK Matte Black Feet & Post PEW Pewter Feet & Post ASLASL Arctic Silver Feet & Post ASLBWH Arctic Silver Feet & Bright White Post ASLMBK Arctic Silver Feet & Matte Black Post ASLPEW Arctic Silver Feet & Pewter Post PAMASL Polished Aluminum Feet & Arctic Silver Post PAMBWH Polished Aluminum Feet & Bright White Post PAMMBK Polished Aluminum Feet & Matte Black Post PAMPEW Polished Aluminum Feet & Pewter Post
		<b>Double Cut</b> DC2 Double Cut	④ Wood Finish Double Cut: COF Coffee FOS Fossil KHK Khaki CRM Cremello GRH Graphite STU Studio Teak				

① Solid Surface Model #	② Edge Detail	③ Solid Surface	④ Electrical Cut Out	⑤ Metal Finish
Solid Surface (NSS)	S7 Reverse Bevel	<b>Tier 1</b> ARM Armadillo BLP Black Pearl GRA Graphite Granite PEB Pebble Pearl PUR Pure White	N None CO_EC23 Cut out for EC23 CO_EC24 Cut out for EC24	BWH Bright White Feet & Post MBK Matte Black Feet & Post PEW Pewter Feet & Post ASLASL Arctic Silver Feet & Post ASLBWH Arctic Silver Feet & Bright White Post ASLMBK Arctic Silver Feet & Matte Black Post ASLPEW Arctic Silver Feet & Pewter Post PAMASL Polished Aluminum Feet & Arctic Silver Post PAMBWH Polished Aluminum Feet & Bright White Post PAMMBK Polished Aluminum Feet & Matte Black Post PAMPEW Polished Aluminum Feet & Pewter Post

Description

Rectangular Table with X Base

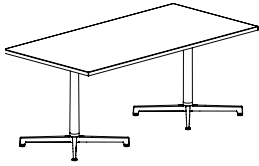

Laminate Tables  
"NST" Models

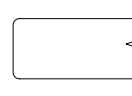

Eased Edge (R3)

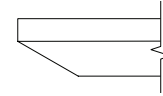

Reverse Bevel Edge (K9)

LAMINATE	D	W	H	CTN WT	CU FT	① Model	Eased Edge (R3)			Reverse Bevel Edge (K9)		
							Standard	Graded In		Standard	Graded In	
							Tier 1	Tier 2	Tier 3	Tier 1	Tier 2	Tier 3
	36	72	29	140	41	NST3672-29TTX	\$1,921	\$1,977	\$2,099	\$2,290	\$2,347	\$2,468
	30	72	29	124	31	NST3072-29TTX	\$1,728	\$1,778	\$1,876	\$2,097	\$2,147	\$2,246

Features:

- price reflects complete table - top and base
- ships KD in multiple cartons
- top has option for cutout to receive electrical component, ordered separately
- optional vertical wire manager for base, order separately
- base has leveling glides
- width of base foot is 26"

HSON

To Order Specify

① Laminate Model #	② Edge Detail	③ Laminate Selection	③a PVC Edge Color	④ Electrical Cut Out	⑤ Metal Finish
Laminate (NST)	R3 Eased K9 Reverse Bevel	<b>Standard Laminates (T1)</b> Solid Patterns: ALB Alabaster      DWH Designer White BLK Black          SHD Shadow BBL Bridal Blanco    SLG Slate Grey  Wood Grain Patterns: AGA Aged Ash      GRH Graphite ALL Ale Light      HGL High Line BLO Blonde Echo    OAT Oatmeal Cookie BOL Bourbon Light    PIN Pinnacle Walnut BZW Brazilwood      STU Studio Teak BGL Brighton Light    VIN Vintage CLL Collectors        WLH Walnut Heights FLO Florence Walnut    WEA Weathered Ash	Color: <b>Standard (T1) laminates have a matching PVC.</b> AGA Aged Ash ALB Alabaster ALL Ale Light BLK Black BLO Blonde Echo BOL Bourbon Light BZW Brazilwood BBL Bridal Blanco BGL Brighton Light CLL Collectors DWH Designer White FLO Florence Walnut GRH Graphite HGL High Line OAT Oatmeal Cookie PIN Pinnacle Walnut SHD Shadow SLG Slate Grey STU Studio Teak VIN Vintage WLH Walnut Heights WEA Weathered Ash	N None CO_EC23 Cut out for EC23 CO_EC24 Cut out for EC24	BWH Bright White Feet & Post MBK Matte Black Feet & Post PEW Pewter Feet & Post ASLASL Arctic Silver Feet & Post ASLBWH Arctic Silver Feet & Bright White Post ASLMBK Arctic Silver Feet & Matte Black Post ASLPEW Arctic Silver Feet & Pewter Post PAMASL Polished Aluminum Feet & Arctic Silver Post PAMBWH Polished Aluminum Feet & Bright White Post PAMMBK Polished Aluminum Feet & Matte Black Post PAMPEW Polished Aluminum Feet & Pewter Post
		Graded-In Laminates (T2) & (T3) see pages 156-161	PVC color must be selected with Graded-In Laminates (T2) & (T3)		

Model Number Breakdown

NST3072-29TTX					
NS	T	3072	29	TT	X
Nosh	Laminate	30" x 72"	Height	Rectangular Top Shape	X Base

Description

Rectangular Table with X Base  
(continued)

Veneer Tables  
"NSV" Models

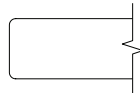

Eased Edge (R3)

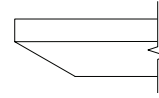

Reverse Bevel Edge (K9)

VENEER	D	W	H	CTN WT	CU FT	① Model	Eased Edge (R3)		Reverse Bevel Edge (K9)	
							Flat Cut	Double Cut	Flat Cut	Double Cut
	36	72	29	140	41	NSV3672-29TTX	\$2,169	\$2,330	\$2,310	\$2,469
	30	72	29	124	31	NSV3072-29TTX	\$2,094	\$2,236	\$2,225	\$2,364

NOSH

To Order Specify

① Veneer Model #	② Edge Detail	③ Wood Species	④ Wood Finish			⑤ Electrical Cut Out	⑥ Metal Finish	
Veneer (NSV)	R3 Eased	Flat Cut CH1 Cherry MA1 Maple WA1 Walnut	Cherry:	Maple:	Walnut:	N None	BWH Bright White Feet & Post	
	K9 Reverse Bevel		BRL Barley	ALM Ale Medium	AUB Auburn	CO_EC23 Cut out for EC23	MBK Matte Black Feet & Post	
			BBM Bourbon Medium	BUT Bitterscotch	ESP Espresso	CO_EC24 Cut out for EC24	PEW Pewter Feet & Post	
			BRM Brighton Medium	CIN Cinnamon	MCH Mocha*		ASLASL Arctic Silver Feet & Post	
			CLA Classic	FLX Flax	NTO Night Owl*		ASLBWH Arctic Silver Feet & Bright White Post	
			CLL Collectors*	VEN Venetian	SIE Sienna*		ASLMBK Arctic Silver Feet & Matte Black Post	
			EAR Earthy	*finishes with coordinating laminate tops				ASLPEW Arctic Silver Feet & Pewter Post
			HRV Harvest*					PAMASL Polished Aluminum Feet & Arctic Silver Post
			LGC Legacy					PAMBWH Polished Aluminum Feet & Bright White Post
			PRL Praline*					PAMMBK Polished Aluminum Feet & Matte Black Post
			SAF Saffron					PAMPEW Polished Aluminum Feet & Pewter Post
		Double Cut DC2 Double Cut	④ Wood Finish					
			Double Cut:					
			COF Coffee	FOS Fossil	KHK Khaki			
			CRM Cremello	GRH Graphite	STU Studio Teak			

Description

Rounded Rectangular Table with X Base

Laminate Tables  
"NST" Models

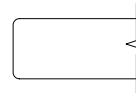
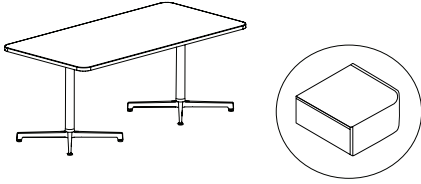

Eased Edge (R3)

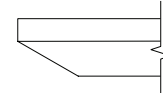

Reverse Bevel (K9)

LAMINATE	D	W	H	CTN WT	CU FT	① Model	Eased Edge (R3)			Reverse Bevel (K9)		
							Standard	Graded In		Standard	Graded In	
							Tier 1	Tier 2	Tier 3	Tier 1	Tier 2	Tier 3
	36	72	29	140	47	NST3672-29TTRX	\$2,002	\$2,059	\$2,179	\$2,371	\$2,428	\$2,548
	30	72	29	123	31	NST3072-29TTRX	\$1,888	\$1,939	\$2,037	\$2,258	\$2,308	\$2,406

Features:

- price reflects complete table - top and base
- ships KD in multiple cartons
- top has option for cutout to receive electrical component, ordered separately
- optional vertical wire manager for base, order separately
- base has leveling glides
- width of base foot is 26"

HSON

To Order Specify

① Laminate Model #	② Edge Detail	③ Laminate Selection	③a PVC Edge Color	④ Electrical Cut Out	⑤ Metal Finish
Laminate (NST)	R3 Eased K9 Reverse Bevel	<b>Standard Laminates (T1)</b> Solid Patterns: LB Alabaster      DWH Designer White BLK Black          SHD Shadow BBL Bridal Blanco    SLG Slate Grey  Wood Grain Patterns: AGA Aged Ash      GRH Graphite ALL Ale Light        HGL High Line BLO Blonde Echo    OAT Oatmeal Cookie BOL Bourbon Light    PIN Pinnacle Walnut BZW Brazilwood      STU Studio Teak BGL Brighton Light    VIN Vintage CLL Collectors        WLH Walnut Heights FLO Florence Walnut    WEA Weathered Ash	Color: Standard (T1) laminates have a matching PVC. AGA Aged Ash ALB Alabaster ALL Ale Light BLK Black BLO Blonde Echo BOL Bourbon Light BZW Brazilwood BBL Bridal Blanco BGL Brighton Light CLL Collectors DWH Designer White FLO Florence Walnut GRH Graphite HGL High Line OAT Oatmeal Cookie PIN Pinnacle Walnut SHD Shadow SLG Slate Grey STU Studio Teak VIN Vintage WLH Walnut Heights WEA Weathered Ash	N None CO_EC23 Cut out for EC23 CO_EC24 Cut out for EC24	BWH Bright White Feet & Post MBK Matte Black Feet & Post PEW Pewter Feet & Post ASLASL Arctic Silver Feet & Post ASLBWH Arctic Silver Feet & Bright White Post ASLMBK Arctic Silver Feet & Matte Black Post ASLPEW Arctic Silver Feet & Pewter Post PAMASL Polished Aluminum Feet & Arctic Silver Post PAMBWH Polished Aluminum Feet & Bright White Post PAMMBK Polished Aluminum Feet & Matte Black Post PAMPEW Polished Aluminum Feet & Pewter Post
			Graded-In Laminates (T2) & (T3) see pages 156-161	PVC color must be selected with Graded-In Laminates (T2) & (T3)	

Model Number Breakdown

NST3072-29TTRX						
NS	T	3072	29	TT	R	X
Nosh	Laminate	30" x 72"	Height	Rectangular Top Shape	Rounded Corner	X Base

Description

Rounded Rectangular Table with X Base  
(continued)

Veneer Tables  
"NSV" Models

Solid Surface Tables  
"NSS" Models

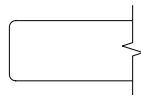

Eased Edge (R3)

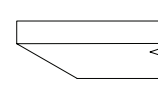

Reverse Bevel Edge (K9)

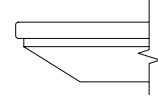

Reverse Bevel Edge (S7)

	D	W	H	CTN WT	CU FT	① Model	④ Wood Finish		⑤ Electrical Cut Out		⑥ Metal Finish
							Flat Cut	Double Cut	Flat Cut	Double Cut	
VENEER	36	72	29	140	47	NSV3672-29TTRX	\$2,325	\$2,496	\$2,395	\$2,557	--
	36	66	29	134	36	NSV3666-29TTRX	\$2,286	\$2,447	\$2,354	\$2,503	--
	36	60	29	140	28	NSV3660-29TTRX	\$2,233	\$2,381	\$2,296	\$2,435	--
	30	72	29	123	31	NSV3072-29TTRX	\$2,180	\$2,330	\$2,243	\$2,383	--
	30	66	29	118	29	NSV3066-29TTRX	\$2,129	\$2,269	\$2,181	\$2,311	--
	30	60	29	111	28	NSV3060-29TTRX	\$2,085	\$2,214	\$2,140	\$2,261	--
SOLID SURFACE	36	72	29	173	47	NSS3672-29TTRX	--	--	--	--	\$4,960
	36	66	29	162	36	NSS3666-29TTRX	--	--	--	--	\$4,733
	36	60	29	150	28	NSS3660-29TTRX	--	--	--	--	\$4,492
	30	72	29	149	31	NSS3072-29TTRX	--	--	--	--	\$4,442
	30	66	29	140	29	NSS3066-29TTRX	--	--	--	--	\$4,234
	30	60	29	130	28	NSS3060-29TTRX	--	--	--	--	\$4,033

To Order Specify

① Veneer Model #	② Edge Detail	③ Wood Species	④ Wood Finish	⑤ Electrical Cut Out	⑥ Metal Finish		
Veneer (NSV)	R3 Eased K9 Reverse Bevel	<b>Flat Cut</b> CH1 Cherry MA1 Maple WA1 Walnut	Cherry: BRL Barley BBM Bourbon Medium BRM Brighton Medium CLA Classic CLL Collectors* EAR Earthy HRV Harvest* LGC Legacy PRL Praline* SAF Saffron	Maple: ALM Ale Medium BUT Butterscotch CIN Cinnamon FLX Flax VEN Venetian	Walnut: AUB Auburn ESP Espresso MCH Mocha* NTO Night Owl* SIE Sienna* TOF Toffee* TRF Truffle*	N None CO_EC23 Cut out for EC23 CO_EC24 Cut out for EC24	BWH Bright White Feet & Post MBK Matte Black Feet & Post PEW Pewter Feet & Post ASLASL Arctic Silver Feet & Post ASLBWH Arctic Silver Feet & Bright White Post ASLMBK Arctic Silver Feet & Matte Black Post ASLPEW Arctic Silver Feet & Pewter Post PAMASL Polished Aluminum Feet & Arctic Silver Post PAMBWH Polished Aluminum Feet & Bright White Post PAMMBK Polished Aluminum Feet & Matte Black Post PAMPEW Polished Aluminum Feet & Pewter Post
		<b>Double Cut</b> DC2 Double Cut	<b>④ Wood Finish</b> Double Cut: COF Coffee FOS Fossil KHK Khaki CRM Cremello GRH Graphite STU Studio Teak				

① Solid Surface Model #	② Edge Detail	③ Solid Surface	④ Electrical Cut Out	⑤ Metal Finish
Solid Surface (NSS)	S7 Reverse Bevel	<b>Tier 1</b> ARM Armadillo BLP Black Pearl GRA Graphite Granite PEB Pebble Pearl PUR Pure White	N None CO_EC23 Cut out for EC23 CO_EC24 Cut out for EC24	BWH Bright White Feet & Post MBK Matte Black Feet & Post PEW Pewter Feet & Post ASLASL Arctic Silver Feet & Post ASLBWH Arctic Silver Feet & Bright White Post ASLMBK Arctic Silver Feet & Matte Black Post ASLPEW Arctic Silver Feet & Pewter Post PAMASL Polished Aluminum Feet & Arctic Silver Post PAMBWH Polished Aluminum Feet & Bright White Post PAMMBK Polished Aluminum Feet & Matte Black Post PAMPEW Polished Aluminum Feet & Pewter Post

Description

Rectangular Table with X Extended Base

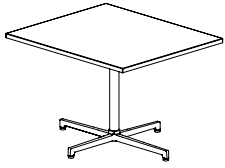

Laminate Tables  
"NST" Models

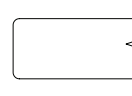

Eased Edge (R3)

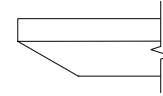

Reverse Bevel Edge (K9)

LAMINATE	D	W	H	CTN WT	CU FT	① Model	Eased Edge (R3)			Reverse Bevel Edge (K9)		
							Standard	Graded In		Standard	Graded In	
							Tier 1	Tier 2	Tier 3	Tier 1	Tier 2	Tier 3
	36	42	29	75	17	NST3642-29TTX	\$1,159	\$1,200	\$1,299	\$1,528	\$1,569	\$1,670
	30	42	29	66	15	NST3042-29TTX	\$1,123	\$1,162	\$1,259	\$1,494	\$1,532	\$1,629
	30	36	29	60	17	NST3036-29TTX	\$1,022	\$1,054	\$1,077	\$1,391	\$1,424	\$1,447

Features:

- price reflects complete table - top and base
- ships KD in multiple cartons
- cut out for power is not available on these tables
- base has leveling glides
- width of base short foot varies from 25" or 31"
- width of base long foot varies from 31" or 37"

HSON

To Order Specify

① Laminate Model #	② Edge Detail	③ Laminate Selection	③a PVC Edge Color	④ Metal Finish
Laminate (NST)	R3 Eased K9 Reverse Bevel	<b>Standard Laminates (T1)</b> Solid Patterns: ALB Alabaster      DWH Designer White BLK Black          SHD Shadow BBL Bridal Blanco    SLG Slate Grey  Wood Grain Patterns: AGA Aged Ash      GRH Graphite ALL Ale Light      HGL High Line BLO Blonde Echo    OAT Oatmeal Cookie BOL Bourbon Light    PIN Pinnacle Walnut BZW Brazilwood      STU Studio Teak BGL Brighton Light    VIN Vintage CLL Collectors        WLH Walnut Heights FLO Florence Walnut    WEA Weathered Ash	Color: Standard (T1) laminates have a matching PVC. AGA Aged Ash ALB Alabaster ALL Ale Light BLK Black BLO Blonde Echo BOL Bourbon Light BZW Brazilwood BBL Bridal Blanco BGL Brighton Light CLL Collectors DWH Designer White FLO Florence Walnut GRH Graphite HGL High Line OAT Oatmeal Cookie PIN Pinnacle Walnut SHD Shadow SLG Slate Grey STU Studio Teak VIN Vintage WLH Walnut Heights WEA Weathered Ash	BWH Bright White Feet & Post MBK Matte Black Feet & Post PEW Pewter Feet & Post ASLASL Arctic Silver Feet & Post ASLBWH Arctic Silver Feet & Bright White Post ASLMBK Arctic Silver Feet & Matte Black Post ASLPEW Arctic Silver Feet & Pewter Post PAMASL Polished Aluminum Feet & Arctic Silver Post PAMBWH Polished Aluminum Feet & Bright White Post PAMMBK Polished Aluminum Feet & Matte Black Post PAMPEW Polished Aluminum Feet & Pewter Post
			Graded-In Laminates (T2) & (T3) see pages 156-161	PVC color must be selected with Graded-In Laminates (T2) & (T3)

Model Number Breakdown

NST3036-29TTX					
NS	T	3036	29	TT	X
Nosh	Laminate	30" x 36"	Height	Rectangular Top Shape	X Extended Base

Description

Rectangular Table with X Extended Base  
(continued)

Veneer Tables  
"NSV" Models

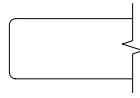

Eased Edge (R3)

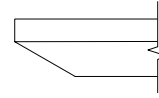

Reverse Bevel Edge (K9)

VENEER	D	W	H	CTN WT	CU FT	① Model	Eased Edge (R3)		Reverse Bevel Edge (K9)	
							Flat Cut	Double Cut	Flat Cut	Double Cut
	36	42	29	75	17	NSV3642-29TTX	\$1,668	\$1,785	\$1,735	\$1,856
	30	42	29	66	15	NSV3042-29TTX	\$1,617	\$1,732	\$1,682	\$1,800
	30	36	29	60	17	NSV3036-29TTX	\$1,469	\$1,572	\$1,528	\$1,637

NOSH

To Order Specify

① Veneer Model #	② Edge Detail	③ Wood Species	④ Wood Finish			⑤ Metal Finish
Veneer (NSV)	R3 Eased	<b>Flat Cut</b> CH1 Cherry MA1 Maple WA1 Walnut	Cherry:	Maple:	Walnut:	<b>BWH</b> Bright White Feet & Post <b>MBK</b> Matte Black Feet & Post <b>PEW</b> Pewter Feet & Post <b>ASL</b> Arctic Silver Feet & Post <b>ASLBWH</b> Arctic Silver Feet & Bright White Post <b>ASLMBK</b> Arctic Silver Feet & Matte Black Post <b>ASLPEW</b> Arctic Silver Feet & Pewter Post <b>PAMASL</b> Polished Aluminum Feet & Arctic Silver Post <b>PAMBWH</b> Polished Aluminum Feet & Bright White Post <b>PAMMBK</b> Polished Aluminum Feet & Matte Black Post <b>PAMPEW</b> Polished Aluminum Feet & Pewter Post
	K9 Reverse Bevel		BRL Barley BBM Bourbon Medium BRM Brighton Medium CLA Classic CLL Collectors* EAR Earthy HRV Harvest* LGC Legacy PRL Praline* SAF Saffron	ALM Ale Medium BUT Butterscotch CIN Cinnamon FLX Flax VEN Venetian	AUB Auburn ESP Espresso MCH Mocha* NTO Night Owl* SIE Sienna* TOF Toffee TRF Truffle*	
		<b>Double Cut</b> DC2 Double Cut	<b>④ Wood Finish</b> Double Cut: COF Coffee    FOS Fossil    KHK Khaki CRM Cremello    GRH Graphite    STU Studio Teak			



Description

Rounded Rectangular Table with X Extended Base

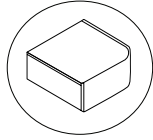

Laminate Tables "NST" Models

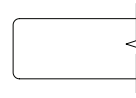

Eased Edge (R3)

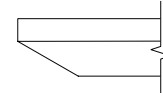

Reverse Bevel (K9)

LAMINATE	D	W	H	CTN WT	CU FT	① Model	Standard			Graded In		
							Tier 1	Tier 2	Tier 3	Tier 1	Tier 2	Tier 3
	36	42	29	76	17	<b>NST3642-29TTRX</b>	\$1,236	\$1,279	\$1,384	\$1,605	\$1,648	\$1,754
30	42	29	65	15	<b>NST3042-29TTRX</b>	\$1,198	\$1,239	\$1,340	\$1,567	\$1,608	\$1,711	
30	36	29	59	17	<b>NST3036-29TTRX</b>	\$1,089	\$1,123	\$1,148	\$1,459	\$1,494	\$1,518	

Features:

- price reflects complete table - top and base
- ships KD in multiple cartons
- cut out for power is not available on these tables
- base has leveling glides
- width of base short foot varies from 25" to 31"
- width of base long foot varies from 31" to 37"

HSON

To Order Specify

① Laminate Model #	② Edge Detail	③ Laminate Selection	③a PVC Edge Color	④ Metal Finish
Laminate (NST)	R3 Eased K9 Reverse Bevel	<b>Standard Laminates (T1)</b> Solid Patterns: ALB Alabaster      DWH Designer White BLK Black          SHD Shadow BBL Bridal Blanco    SLG Slate Grey  Wood Grain Patterns: AGA Aged Ash      GRH Graphite ALL Ale Light      HGL High Line BLO Blonde Echo    OAT Oatmeal Cookie BOL Bourbon Light    PIN Pinnacle Walnut BZW Brazilwood      STU Studio Teak BGL Brighton Light    VIN Vintage CLL Collectors      WLH Walnut Heights FLO Florence Walnut    WEA Weathered Ash	Color: Standard (T1) laminates have a matching PVC. AGA Aged Ash ALB Alabaster ALL Ale Light BLK Black BLO Blonde Echo BOL Bourbon Light BZW Brazilwood BBL Bridal Blanco BGL Brighton Light CLL Collectors DWH Designer White FLO Florence Walnut GRH Graphite HGL High Line OAT Oatmeal Cookie PIN Pinnacle Walnut SHD Shadow SLG Slate Grey STU Studio Teak VIN Vintage WLH Walnut Heights WEA Weathered Ash	BWH Bright White Feet & Post MBK Matte Black Feet & Post PEW Pewter Feet & Post ASLASL Arctic Silver Feet & Post ASLBWH Arctic Silver Feet & Bright White Post ASLMBK Arctic Silver Feet & Matte Black Post ASLPEW Arctic Silver Feet & Pewter Post PAMASL Polished Aluminum Feet & Arctic Silver Post PAMBWH Polished Aluminum Feet & Bright White Post PAMMBK Polished Aluminum Feet & Matte Black Post PAMPEW Polished Aluminum Feet & Pewter Post
			Graded-In Laminates (T2) & (T3) see pages 156-161	PVC color must be selected with Graded-In Laminates (T2) & (T3)

Model Number Breakdown

NST3036-29TTRX						
NS	T	3036	29	TT	R	X
Nosh	Laminate	30" x 36"	Height	Rectangular Top Shape	Rounded Corner	X Extended Base

Description

Rounded Rectangular Table with X Extended Base (continued)

		Veneer Tables "NSV" Models				Solid Surface Tables "NSS" Models					
		Eased Edge (R3)		Reverse Bevel Edge (K9)		Reverse Bevel Edge (S7)					
		Flat Cut	Double Cut	Flat Cut	Double Cut	Standard					
	D	W	H	CTN WT	CU FT	① Model	Flat Cut	Double Cut	Flat Cut	Double Cut	Standard
VENEER	36	42	29	76	17	NSV3642-29TTRX	\$1,726	\$1,848	\$1,796	\$1,922	--
	30	42	29	65	15	NSV3042-29TTRX	\$1,675	\$1,792	\$1,741	\$1,865	--
	30	36	29	59	17	NSV3036-29TTRX	\$1,522	\$1,629	\$1,584	\$1,695	--
SOL SURF	36	42	29	110	17	NSS3642-29TTRX	--	--	--	--	\$3,424
	30	42	29	92	15	NSS3042-29TTRX	--	--	--	--	\$3,153
	30	36	29	77	17	NSS3036-29TTRX	--	--	--	--	\$2,844

To Order Specify

① Veneer Model #	② Edge Detail	③ Wood Species	④ Wood Finish	⑤ Metal Finish		
Veneer (NSV)	R3 Eased K9 Reverse Bevel	<b>Flat Cut</b> CH1 Cherry MA1 Maple WA1 Walnut	Cherry: BRL Barley BBM Bourbon Medium BRM Brighton Medium CLA Classic CLL Collectors* EAR Earthy HRV Harvest* LGC Legacy PRL Praline* SAF Saffron	Maple: ALM Ale Medium BUT Butterscotch CIN Cinnamon FLX Flax VEN Venetian	Walnut: AUB Auburn ESP Espresso MCH Mocha* NTO Night Owl* SIE Sienna* TOF Toffee TRF Truffle*	BWH Bright White Feet & Post MBK Matte Black Feet & Post PEW Pewter Feet & Post ASLASL Arctic Silver Feet & Post ASLBWH Arctic Silver Feet & Bright White Post ASLMBK Arctic Silver Feet & Matte Black Post ASLPEW Arctic Silver Feet & Pewter Post PAMASL Polished Aluminum Feet & Arctic Silver Post PAMBWH Polished Aluminum Feet & Bright White Post PAMMBK Polished Aluminum Feet & Matte Black Post PAMPEW Polished Aluminum Feet & Pewter Post
		<b>Double Cut</b> DC2 Double Cut	<b>④ Wood Finish</b> Double Cut: COF Coffee FOS Fossil KHK Khaki CRM Cremello GRH Graphite STU Studio Teak			

① Solid Surface Model #	② Edge Detail	③ Solid Surface	④ Metal Finish
Solid Surface (NSS)	S7 Reverse Bevel	<b>Tier 1</b> ARM Armadillo BLP Black Pearl GRA Graphite Granite PEB Pebble Pearl PUR Pure White	BWH Bright White Feet & Post MBK Matte Black Feet & Post PEW Pewter Feet & Post ASLASL Arctic Silver Feet & Post ASLBWH Arctic Silver Feet & Bright White Post ASLMBK Arctic Silver Feet & Matte Black Post ASLPEW Arctic Silver Feet & Pewter Post PAMASL Polished Aluminum Feet & Arctic Silver Post PAMBWH Polished Aluminum Feet & Bright White Post PAMMBK Polished Aluminum Feet & Matte Black Post PAMPEW Polished Aluminum Feet & Pewter Post

Description

Rectangular Table with Round Disc Base

Laminate Tables  
"NST" Models

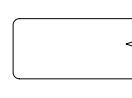
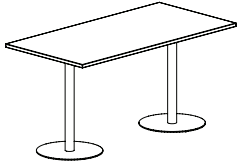

Eased Edge (R3)

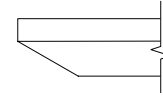

Reverse Bevel Edge (K9)

LAMINATE	D	W	H	CTN WT	CU FT	① Model	Eased Edge (R3)			Reverse Bevel Edge (K9)		
							Standard	Graded In		Standard	Graded In	
							Tier 1	Tier 2	Tier 3	Tier 1	Tier 2	Tier 3
	36	72	29	193	47	NST3672-29TTR	\$2,131	\$2,186	\$2,295	\$2,500	\$2,556	\$2,665
	36	66	29	185	44	NST3666-29TTR	\$2,001	\$2,064	\$2,165	\$2,370	\$2,434	\$2,535
	36	60	29	177	38	NST3660-29TTR	\$1,920	\$1,981	\$2,068	\$2,289	\$2,351	\$2,439
	30	72	29	154	41	NST3072-29TTR	\$1,922	\$1,983	\$2,069	\$2,291	\$2,352	\$2,440
	30	66	29	147	41	NST3066-29TTR	\$1,734	\$1,791	\$1,870	\$2,103	\$2,160	\$2,239
	30	60	29	140	36	NST3060-29TTR	\$1,672	\$1,725	\$1,794	\$2,041	\$2,095	\$2,165

Features:

- price reflects complete table - top and base
- ships KD in multiple cartons
- top has option for cutout to receive electrical component, ordered separately
- optional vertical wire manager for base, order separately
- base has anti-rock glides
- width of base foot varies from 17" or 22"

HSON

To Order Specify

① Laminate Model #	② Edge Detail	③ Laminate Selection	③a PVC Edge Color	④ Electrical Cut Out	⑤ Metal Finish
Laminate (NST)	R3 Eased K9 Reverse Bevel	<b>Standard Laminates (T1)</b> Solid Patterns: ALB Alabaster      DWH Designer White BLK Black          SHD Shadow BBL Bridal Blanco    SLG Slate Grey  Wood Grain Patterns: AGA Aged Ash      GRH Graphite ALL Ale Light      HGL High Line BLO Blonde Echo    OAT Oatmeal Cookie BOL Bourbon Light    PIN Pinnacle Walnut BZW Brazilwood      STU Studio Teak BGL Brighton Light    VIN Vintage CLL Collectors        WLH Walnut Heights FLO Florence Walnut    WEA Weathered Ash	Color: Standard (T1) laminates have a matching PVC. AGA Aged Ash ALB Alabaster ALL Ale Light BLK Black BLO Blonde Echo BOL Bourbon Light BZW Brazilwood BBL Bridal Blanco BGL Brighton Light CLL Collectors DWH Designer White FLO Florence Walnut GRH Graphite HGL High Line OAT Oatmeal Cookie PIN Pinnacle Walnut SHD Shadow SLG Slate Grey STU Studio Teak VIN Vintage WLH Walnut Heights WEA Weathered Ash	N None CO_EC23 Cut out for EC23 CO_EC24 Cut out for EC24	BWH Bright White Feet & Post MBK Matte Black Feet & Post PEW Pewter Feet & Post ASLASL Arctic Silver Feet & Post ASLBWH Arctic Silver Feet & Bright White Post ASLMBK Arctic Silver Feet & Matte Black Post ASLPEW Arctic Silver Feet & Pewter Post
		Graded-In Laminates (T2) & (T3) see pages 156-161	PVC color must be selected with Graded-In Laminates (T2) & (T3)		

Model Number Breakdown

NST3060-29TTR					
NS	T	3060	29	TT	R
Nosh	Laminate	30" x 60"	Height	Rectangular Top Shape	Round Disc Base

Description

Rectangular Table with Round Disc Base  
(continued)

Veneer Tables  
"NSV" Models

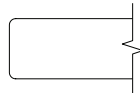

Eased Edge (R3)

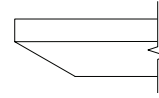

Reverse Bevel Edge (K9)

D	W	H	CTN WT	CU FT	1 Model	Flat Cut		Double Cut	
						Flat Cut	Double Cut	Flat Cut	Double Cut
36	72	29	193	47	NSV3672-29TTR	\$2,438	\$2,547	\$2,493	\$2,594
36	66	29	185	44	NSV3666-29TTR	\$2,354	\$2,455	\$2,418	\$2,507
36	60	29	177	38	NSV3660-29TTR	\$2,277	\$2,367	\$2,337	\$2,415
30	72	29	154	41	NSV3072-29TTR	\$2,251	\$2,411	\$2,308	\$2,458
30	66	29	147	41	NSV3066-29TTR	\$2,064	\$2,169	\$2,116	\$2,212
30	60	29	140	36	NSV3060-29TTR	\$2,004	\$2,099	\$2,054	\$2,139

VENEER

NOSH

To Order Specify

1 Veneer Model #	2 Edge Detail	3 Wood Species	4 Wood Finish	5 Electrical Cut Out	6 Metal Finish		
Veneer (NSV)	R3 Eased K9 Reverse Bevel	<b>Flat Cut</b> CH1 Cherry MA1 Maple WA1 Walnut	Cherry: BRL Barley BBM Bourbon Medium BRM Brighton Medium CLA Classic CLL Collectors* EAR Earthy HRV Harvest* LGC Legacy PRL Praline* SAF Saffron	Maple: ALM Ale Medium BUT Butterscotch CIN Cinnamon FLX Flax VEN Venetian	Walnut: AUB Auburn ESP Espresso MCH Mocha* NTO Night Owl* SIE Sienna* TOF Toffee TRF Truffle*	N None CO_EC23 Cut out for EC23 CO_EC24 Cut out for EC24	BWH Bright White Feet & Post MBK Matte Black Feet & Post PEW Pewter Feet & Post ASLASL Arctic Silver Feet & Post ASLBWH Arctic Silver Feet & Bright White Post ASLMBK Arctic Silver Feet & Matte Black Post ASLPEW Arctic Silver Feet & Pewter Post
	<b>Double Cut</b> DC2 Double Cut	<b>4 Wood Finish</b> Double Cut: COF Coffee FOS Fossil KHK Khaki CRM Cremello GRH Graphite STU Studio Teak					

Description

Rounded Rectangular Table with Round Disc Base

Laminate Tables "NST" Models

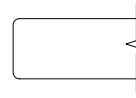
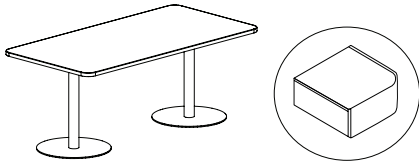

Eased Edge (R3)

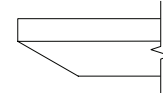

Reverse Bevel (K9)

LAMINATE	D	W	H	CTN WT	CU FT	① Model	Standard			Graded In		
							Tier 1	Tier 2	Tier 3	Tier 1	Tier 2	Tier 3
							36	72	29	193	47	NST3672-29TTRR
36	66	29	185	44	NST3666-29TTRR	\$2,025	\$2,089	\$2,190	\$2,395	\$2,459	\$2,559	
36	60	29	176	38	NST3660-29TTRR	\$1,970	\$2,030	\$2,139	\$2,339	\$2,400	\$2,509	
30	72	29	154	41	NST3072-29TTRR	\$2,004	\$2,065	\$2,152	\$2,373	\$2,435	\$2,521	
30	66	29	147	41	NST3066-29TTRR	\$1,950	\$2,008	\$2,086	\$2,319	\$2,377	\$2,455	
30	60	29	140	36	NST3060-29TTRR	\$1,902	\$1,958	\$2,025	\$2,272	\$2,327	\$2,395	

Features:

- price reflects complete table - top and base
- ships KD in multiple cartons
- top has option for cutout to receive electrical component, ordered separately
- optional vertical wire manager for base, order separately
- base has anti-rock glides
- width of base foot varies from 17" or 22"

HSON

To Order Specify

① Laminate Model #	② Edge Detail	③ Laminate Selection	③a PVC Edge Color	④ Electrical Cut Out	⑤ Metal Finish
Laminate (NST)	R3 Eased	<b>Standard Laminates (T1)</b> Solid Patterns: ALB Alabaster      DWH Designer White BLK Black          SHD Shadow BBL Bridal Blanco    SLG Slate Grey  Wood Grain Patterns: AGA Aged Ash      GRH Graphite ALL Ale Light      HGL High Line BLO Blonde Echo    OAT Oatmeal Cookie BOL Bourbon Light    PIN Pinnacle Walnut BZW Brazilwood      STU Studio Teak BGL Brighton Light    VIN Vintage CLL Collectors        WLH Walnut Heights FLO Florence Walnut    WEA Weathered Ash	Color: Standard (T1) laminates have a matching PVC. AGA Aged Ash ALB Alabaster ALL Ale Light BLK Black BLO Blonde Echo BOL Bourbon Light BZW Brazilwood BBL Bridal Blanco BGL Brighton Light CLL Collectors DWH Designer White FLO Florence Walnut GRH Graphite HGL High Line OAT Oatmeal Cookie PIN Pinnacle Walnut SHD Shadow SLG Slate Grey STU Studio Teak VIN Vintage WLH Walnut Heights WEA Weathered Ash	N None CO_EC23 Cut out for EC23 CO_EC24 Cut out for EC24	BWH Bright White Feet & Post MBK Matte Black Feet & Post PEW Pewter Feet & Post ASLASL Arctic Silver Feet & Post ASLBWH Arctic Silver Feet & Bright White Post ASLMBK Arctic Silver Feet & Matte Black Post ASLPEW Arctic Silver Feet & Pewter Post
	K9 Reverse Bevel				

Model Number Breakdown

NST3060-29TTRR						
NS	T	3060	29	TT	R	R
Nosh	Laminate	30" x 60"	Height	Rectangular Top Shape	Rounded Corner	Round Disc Base

Description

Rounded Rectangular Table with Round Disc Base (continued)

Veneer Tables "NSV" Models Solid Surface Tables "NSS" Models

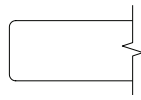

Eased Edge (R3)

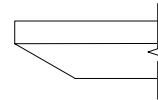

Reverse Bevel Edge (K9)

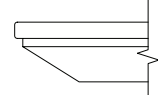

Reverse Bevel Edge (S7)

	D	W	H	CTN WT	CU FT	① Model	Eased Edge (R3)		Reverse Bevel Edge (K9)		Standard
							Flat Cut	Double Cut	Flat Cut	Double Cut	
VENEER	36	72	29	193	47	NSV3672-29TTRR	\$2,641	\$2,752	\$2,706	\$2,805	--
	36	66	29	185	44	NSV3666-29TTRR	\$2,372	\$2,472	\$2,431	\$2,523	--
	36	60	29	176	38	NSV3660-29TTRR	\$2,321	\$2,411	\$2,376	\$2,458	--
	30	72	29	154	41	NSV3072-29TTRR	\$2,325	\$2,438	\$2,389	\$2,489	--
	30	66	29	147	41	NSV3066-29TTRR	\$2,274	\$2,376	\$2,326	\$2,419	--
	30	60	29	140	36	NSV3060-29TTRR	\$2,230	\$2,323	\$2,285	\$2,369	--
SOLID SURFACE	36	72	29	226	47	NSS3672-29TTRR	--	--	--	--	\$5,277
	36	66	29	215	44	NSS3666-29TTRR	--	--	--	--	\$4,820
	36	60	29	203	38	NSS3660-29TTRR	--	--	--	--	\$4,580
	30	72	29	180	41	NSS3072-29TTRR	--	--	--	--	\$4,587
	30	66	29	171	41	NSS3066-29TTRR	--	--	--	--	\$4,379
	30	60	29	161	36	NSS3060-29TTRR	--	--	--	--	\$4,177

HSON

To Order Specify

① Veneer Model #	② Edge Detail	③ Wood Species	④ Wood Finish	⑤ Electrical Cut Out	⑥ Metal Finish
Veneer (NSV)	R3 Eased K9 Reverse Bevel	<b>Flat Cut</b> CH1 Cherry MA1 Maple WA1 Walnut	Cherry: BRL Barley BBM Bourbon Medium BRM Brighton Medium CLA Classic CLL Collectors* EAR Earthy HRV Harvest* LGC Legacy PRL Praline* SAF Saffron  Maple: ALM Ale Medium BUT Butterscotch CIN Cinnamon FLX Flax VEN Venetian  Walnut: AUB Auburn ESP Espresso MCH Mocha* NTO Night Owl* SIE Sienna* TOF Toffee TRF Truffle*  *finishes with coordinating laminate tops	N None CO_EC23 Cut out for EC23 CO_EC24 Cut out for EC24	BWH Bright White Feet & Post MBK Matte Black Feet & Post PEW Pewter Feet & Post ASLASE Arctic Silver Feet & Post ASLBWH Arctic Silver Feet & Bright White Post ASLMBK Arctic Silver Feet & Matte Black Post ASLPEW Arctic Silver Feet & Pewter Post
	<b>Double Cut</b> DC2 Double Cut	<b>④ Wood Finish</b> Double Cut: COF Coffee FOS Fossil KHK Khaki CRM Cremello GRH Graphite STU Studio Teak			

① Solid Surface Model #	② Edge Detail	③ Solid Surface	④ Electrical Cut Out	⑤ Metal Finish
Solid Surface (NSS)	S7 Reverse Bevel	<b>Tier 1</b> ARM Armadillo BLP Black Pearl GRA Graphite Granite PEB Pebble Pearl PUR Pure White	N None CO_EC23 Cut out for EC23 CO_EC24 Cut out for EC24	BWH Bright White Feet & Post MBK Matte Black Feet & Post PEW Pewter Feet & Post ASLASE Arctic Silver Feet & Post ASLBWH Arctic Silver Feet & Bright White Post ASLMBK Arctic Silver Feet & Matte Black Post ASLPEW Arctic Silver Feet & Pewter Post

Description

Rectangular Table with Square Disc Base

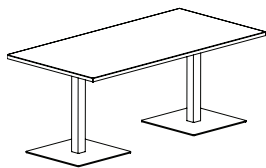

Laminate Tables  
"NST" Models

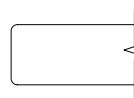

Eased Edge (R3)

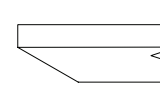

Reverse Bevel Edge (K9)

LAMINATE	D	W	H	CTN WT	CU FT	① Model	Eased Edge (R3)			Reverse Bevel Edge (K9)		
							Standard	Graded In		Standard	Graded In	
							Tier 1	Tier 2	Tier 3	Tier 1	Tier 2	Tier 3
	36	72	29	215	47	NST3672-29TTS	\$2,381	\$2,436	\$2,545	\$2,751	\$2,806	\$2,914
	36	66	29	207	44	NST3666-29TTS	\$2,251	\$2,315	\$2,414	\$2,621	\$2,684	\$2,784
	36	60	29	198	38	NST3660-29TTS	\$2,171	\$2,232	\$2,319	\$2,540	\$2,601	\$2,689
	30	72	29	165	41	NST3072-29TTS	\$2,173	\$2,233	\$2,320	\$2,542	\$2,602	\$2,690
	30	66	29	158	41	NST3066-29TTS	\$1,984	\$2,042	\$2,121	\$2,353	\$2,411	\$2,490
	30	60	29	151	36	NST3060-29TTS	\$1,921	\$1,975	\$2,045	\$2,290	\$2,346	\$2,414

Features:

- price reflects complete table - top and base
- ships KD in multiple cartons
- top has option for cutout to receive electrical component, ordered separately
- optional vertical wire manager for base, order separately
- base has anti-rock glides
- width of base foot varies from 17" or 22"

HSON

To Order Specify

① Laminate Model #	② Edge Detail	③ Laminate Selection	③a PVC Edge Color	④ Electrical Cut Out	⑤ Metal Finish
Laminate (NST)	R3 Eased K9 Reverse Bevel	<b>Standard Laminates (T1)</b> Solid Patterns: ALB Alabaster      DWH Designer White BLK Black          SHD Shadow BBL Bridal Blanco    SLG Slate Grey  Wood Grain Patterns: AGA Aged Ash      GRH Graphite ALL Ale Light      HGL High Line BLO Blonde Echo    OAT Oatmeal Cookie BOL Bourbon Light    PIN Pinnacle Walnut BZW Brazilwood      STU Studio Teak BGL Brighton Light    VIN Vintage CLL Collectors        WLH Walnut Heights FLO Florence Walnut    WEA Weathered Ash	Color: Standard (T1) laminates have a matching PVC. AGA Aged Ash ALB Alabaster ALL Ale Light BLK Black BLO Blonde Echo BOL Bourbon Light BZW Brazilwood BBL Bridal Blanco BGL Brighton Light CLL Collectors DWH Designer White FLO Florence Walnut GRH Graphite HGL High Line OAT Oatmeal Cookie PIN Pinnacle Walnut SHD Shadow SLG Slate Grey STU Studio Teak VIN Vintage WLH Walnut Heights WEA Weathered Ash	N None CO_EC23 Cut out for EC23 CO_EC24 Cut out for EC24	BWH Bright White Feet & Post MBK Matte Black Feet & Post PEW Pewter Feet & Post ASLASL Arctic Silver Feet & Post ASLBWH Arctic Silver Feet & Bright White Post ASLMBK Arctic Silver Feet & Matte Black Post ASLPEW Arctic Silver Feet & Pewter Post
		Graded-In Laminates (T2) & (T3) see pages 156-161	PVC color must be selected with Graded-In Laminates (T2) & (T3)		

Model Number Breakdown

NST3060-29TTS					
NS	T	3060	29	TT	S
Nosh	Laminate	30" x 60"	Height	Rectangular Top Shape	Square Disc Base

Description

Rectangular Table with Square Disc Base  
(continued)

Veneer Tables  
"NSV" Models

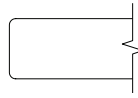

Eased Edge (R3)

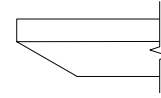

Reverse Bevel Edge (K9)

D	W	H	CTN WT	CU FT	1 Model	Flat Cut		Double Cut	
						Flat Cut	Double Cut	Flat Cut	Double Cut
36	72	29	215	47	NSV3672-29TTS	\$2,688	\$2,798	\$2,742	\$2,845
36	66	29	207	44	NSV3666-29TTS	\$2,604	\$2,707	\$2,669	\$2,758
36	60	29	198	38	NSV3660-29TTS	\$2,527	\$2,618	\$2,587	\$2,666
30	72	29	165	41	NSV3072-29TTS	\$2,501	\$2,662	\$2,558	\$2,709
30	66	29	158	41	NSV3066-29TTS	\$2,315	\$2,418	\$2,367	\$2,461
30	60	29	151	36	NSV3060-29TTS	\$2,255	\$2,349	\$2,305	\$2,390

VENEER

NOSH

To Order Specify

1 Veneer Model #	2 Edge Detail	3 Wood Species	4 Wood Finish	5 Electrical Cut Out	6 Metal Finish		
Veneer (NSV)	R3 Eased K9 Reverse Bevel	<b>Flat Cut</b> CH1 Cherry MA1 Maple WA1 Walnut	Cherry: BRL Barley BBM Bourbon Medium BRM Brighton Medium CLA Classic CLL Collectors* EAR Earthy HRV Harvest* LGC Legacy PRL Praline* SAF Saffron	Maple: ALM Ale Medium BUT Butterscotch CIN Cinnamon FLX Flax VEN Venetian	Walnut: AUB Auburn ESP Espresso MCH Mocha* NTO Night Owl* SIE Sienna* TOF Toffee TRF Truffle*	N None CO_EC23 Cut out for EC23 CO_EC24 Cut out for EC24	BWH Bright White Feet & Post MBK Matte Black Feet & Post PEW Pewter Feet & Post ASLASL Arctic Silver Feet & Post ASLBWH Arctic Silver Feet & Bright White Post ASLMBK Arctic Silver Feet & Matte Black Post ASLPEW Arctic Silver Feet & Pewter Post
	DC2 Double Cut	<b>4 Wood Finish</b> Double Cut: COF Coffee FOS Fossil KHK Khaki CRM Cremello GRH Graphite STU Studio Teak	*finishes with coordinating laminate tops				



Description

Rounded Rectangular Table with Square Disc Base

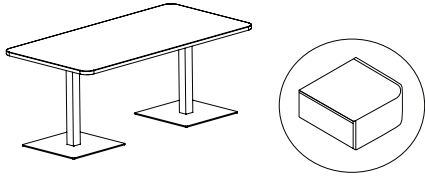

Laminate Tables "NST" Models



Eased Edge (R3)

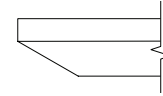

Reverse Bevel (K9)

LAMINATE	D	W	H	CTN WT	CU FT	① Model	Eased Edge (R3)			Reverse Bevel (K9)		
							Standard	Graded In		Standard	Graded In	
							Tier 1	Tier 2	Tier 3	Tier 1	Tier 2	Tier 3
	36	72	29	215	47	NST3672-29TTRS	\$2,584	\$2,656	\$2,762	\$2,953	\$3,026	\$3,132
	36	66	29	207	44	NST3666-29TTRS	\$2,276	\$2,339	\$2,440	\$2,645	\$2,710	\$2,809
	36	60	29	198	38	NST3660-29TTRS	\$2,220	\$2,280	\$2,390	\$2,589	\$2,650	\$2,759
	30	72	29	165	41	NST3072-29TTRS	\$2,255	\$2,316	\$2,403	\$2,624	\$2,685	\$2,772
	30	66	29	158	41	NST3066-29TTRS	\$2,199	\$2,259	\$2,336	\$2,569	\$2,629	\$2,707
	30	60	29	151	36	NST3060-29TTRS	\$2,152	\$2,209	\$2,276	\$2,521	\$2,578	\$2,645

Features:

- price reflects complete table - top and base
- ships KD in multiple cartons
- top has option for cutout to receive electrical component, ordered separately
- optional vertical wire manager for base, order separately
- base has anti-rock glides
- width of base foot varies from 17" or 22"

HSON

To Order Specify

① Laminate Model #	② Edge Detail	③ Laminate Selection	③a PVC Edge Color	④ Electrical Cut Out	⑤ Metal Finish
Laminate (NST)	R3 Eased	<b>Standard Laminates (T1)</b> Solid Patterns: ALB Alabaster      DWH Designer White BLK Black          SHD Shadow BBL Bridal Blanco    SLG Slate Grey  Wood Grain Patterns: AGA Aged Ash      GRH Graphite ALL Ale Light        HGL High Line BLO Blonde Echo    OAT Oatmeal Cookie BOL Bourbon Light    PIN Pinnacle Walnut BZW Brazilwood      STU Studio Teak BGL Brighton Light    VIN Vintage CLL Collectors        WLH Walnut Heights FLO Florence Walnut    WEA Weathered Ash	Color: <b>Standard (T1) laminates have a matching PVC.</b> AGA Aged Ash ALB Alabaster ALL Ale Light BLK Black BLO Blonde Echo BOL Bourbon Light BZW Brazilwood BBL Bridal Blanco BGL Brighton Light CLL Collectors DWH Designer White FLO Florence Walnut GRH Graphite HGL High Line OAT Oatmeal Cookie PIN Pinnacle Walnut SHD Shadow SLG Slate Grey STU Studio Teak VIN Vintage WLH Walnut Heights WEA Weathered Ash	N None CO_EC23 Cut out for EC23 CO_EC24 Cut out for EC24	BWH Bright White Feet & Post MBK Matte Black Feet & Post PEW Pewter Feet & Post ASLASL Arctic Silver Feet & Post ASLBWH Arctic Silver Feet & Bright White Post ASLMBK Arctic Silver Feet & Matte Black Post ASLPEW Arctic Silver Feet & Pewter Post
	K9 Reverse Bevel				

Model Number Breakdown

NST3060-29TTRS						
NS	T	3060	29	TT	R	S
Nosh	Laminate	30" x 60"	Height	Rectangular Top Shape	Rounded Corner	Square Disc Base

Description

Rounded Rectangular Table with Square Disc Base (continued)

		Veneer Tables "NSV" Models				Solid Surface Tables "NSS" Models					
		Eased Edge (R3)		Reverse Bevel Edge (K9)		Reverse Bevel Edge (S7)					
		Flat Cut	Double Cut	Flat Cut	Double Cut	Standard					
D	W	H	CTN WT	CU FT	① Model	Flat Cut	Double Cut	Flat Cut	Double Cut	Standard	
VENEER	36	72	29	215	47	NSV3672-29TTRS	\$2,891	\$3,001	\$2,954	\$3,055	--
	36	66	29	207	44	NSV3666-29TTRS	\$2,623	\$2,722	\$2,682	\$2,773	--
	36	60	29	198	38	NSV3660-29TTRS	\$2,572	\$2,662	\$2,627	\$2,709	--
	30	72	29	165	41	NSV3072-29TTRS	\$2,576	\$2,688	\$2,639	\$2,738	--
	30	66	29	158	41	NSV3066-29TTRS	\$2,524	\$2,627	\$2,577	\$2,670	--
	30	60	29	151	36	NSV3060-29TTRS	\$2,480	\$2,573	\$2,536	\$2,620	--
SOLID SURFACE	36	72	29	248	47	NSS3672-29TTRS	--	--	--	--	\$5,526
	36	66	29	237	44	NSS3666-29TTRS	--	--	--	--	\$5,070
	36	60	29	226	38	NSS3660-29TTRS	--	--	--	--	\$4,831
	30	72	29	191	41	NSS3072-29TTRS	--	--	--	--	\$4,837
	30	66	29	181	41	NSS3066-29TTRS	--	--	--	--	\$4,629
	30	60	29	172	36	NSS3060-29TTRS	--	--	--	--	\$4,427

To Order Specify

① Veneer Model #	② Edge Detail	③ Wood Species	④ Wood Finish	⑤ Electrical Cut Out	⑥ Metal Finish
Veneer (NSV)	R3 Eased K9 Reverse Bevel	<b>Flat Cut</b> CH1 Cherry MA1 Maple WA1 Walnut	Cherry: BRL Barley BBM Bourbon Medium BRM Brighton Medium CLA Classic CLL Collectors* EAR Earthy HRV Harvest* LGC Legacy PRL Praline* SAF Saffron  Maple: ALM Ale Medium BUT Butterscotch CIN Cinnamon FLX Flax VEN Venetian  Walnut: AUB Auburn ESP Espresso MCH Mocha* NTO Night Owl* SIE Sienna* TOF Toffee TRF Truffle*  *finishes with coordinating laminate tops	N None CO_EC23 Cut out for EC23 CO_EC24 Cut out for EC24	BWH Bright White Feet & Post MBK Matte Black Feet & Post PEW Pewter Feet & Post ASLASE Arctic Silver Feet & Post ASLBWH Arctic Silver Feet & Bright White Post ASLMBK Arctic Silver Feet & Matte Black Post ASLPEW Arctic Silver Feet & Pewter Post
		<b>Double Cut</b> DC2 Double Cut	<b>④ Wood Finish</b> Double Cut: COF Coffee FOS Fossil KHK Khaki CRM Cremello GRH Graphite STU Studio Teak		

① Solid Surface Model #	② Edge Detail	③ Solid Surface	④ Electrical Cut Out	⑤ Metal Finish
Solid Surface (NSS)	S7 Reverse Bevel	<b>Tier 1</b> ARM Armadillo BLP Black Pearl GRA Graphite Granite PEB Pebble Pearl PUR Pure White	N None CO_EC23 Cut out for EC23 CO_EC24 Cut out for EC24	BWH Bright White Feet & Post MBK Matte Black Feet & Post PEW Pewter Feet & Post ASLASE Arctic Silver Feet & Post ASLBWH Arctic Silver Feet & Bright White Post ASLMBK Arctic Silver Feet & Matte Black Post ASLPEW Arctic Silver Feet & Pewter Post

Description

Round Table with X Base

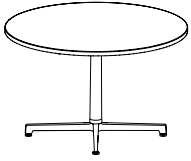

Laminate Tables  
"NST" Models

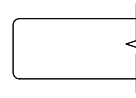

Eased Edge (R3)

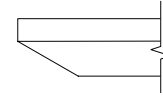

Reverse Bevel Edge (K9)

LAMINATE	D	W	H	CTN WT	CU FT	① Model	Eased Edge (R3)			Reverse Bevel Edge (K9)		
							Standard	Graded In		Standard	Graded In	
							Tier 1	Tier 2	Tier 3	Tier 1	Tier 2	Tier 3
	48	N/A	29	86	22	NST48-29RDX	\$1,274	\$1,371	\$1,477	\$1,643	\$1,740	\$1,848
	42	N/A	29	72	17	NST42-29RDX	\$1,163	\$1,259	\$1,337	\$1,533	\$1,629	\$1,706
	36	N/A	29	59	17	NST36-29RDX	\$1,127	\$1,161	\$1,218	\$1,496	\$1,530	\$1,587
	30	N/A	29	47	14	NST30-29RDX	\$1,085	\$1,112	\$1,145	\$1,454	\$1,482	\$1,515

Features:

- price reflects complete table - top and base
- ships KD in multiple cartons
- top has option for cutout to receive electrical component, ordered separately
- when electrical cut out selected, power accessible base is sent - add \$95
- base has leveling glides
- width of base foot varies from 26" or 32"

HSON

To Order Specify

① Laminate Model #	② Edge Detail	③ Laminate Selection	③a PVC Edge Color	④ Electrical Cut Out	⑤ Metal Finish
Laminate (NST)	R3 Eased K9 Reverse Bevel	<b>Standard Laminates (T1)</b> Solid Patterns: ALB Alabaster      DWH Designer White BLK Black          SHD Shadow BBL Bridal Blanco    SLG Slate Grey  Wood Grain Patterns: AGA Aged Ash      GRH Graphite ALL Ale Light      HGL High Line BLO Blonde Echo    OAT Oatmeal Cookie BOL Bourbon Light    PIN Pinnacle Walnut BZW Brazilwood      STU Studio Teak BGL Brighton Light    VIN Vintage CLL Collectors        WLH Walnut Heights FLO Florence Walnut    WEA Weathered Ash	Color: Standard (T1) laminates have a matching PVC. AGA Aged Ash ALB Alabaster ALL Ale Light BLK Black BLO Blonde Echo BOL Bourbon Light BZW Brazilwood BBL Bridal Blanco BGL Brighton Light CLL Collectors DWH Designer White FLO Florence Walnut GRH Graphite HGL High Line OAT Oatmeal Cookie PIN Pinnacle Walnut SHD Shadow SLG Slate Grey STU Studio Teak VIN Vintage WLH Walnut Heights WEA Weathered Ash	N None COB_EC23 Cut out for EC23 COB_EC24 Cut out for EC24	BWH Bright White Feet & Post MBK Matte Black Feet & Post PEW Pewter Feet & Post ASLASL Arctic Silver Feet & Post ASLBWH Arctic Silver Feet & Bright White Post ASLMBK Arctic Silver Feet & Matte Black Post ASLPEW Arctic Silver Feet & Pewter Post PAMASL Polished Aluminum Feet & Arctic Silver Post PAMBWH Polished Aluminum Feet & Bright White Post PAMMBK Polished Aluminum Feet & Matte Black Post PAMPEW Polished Aluminum Feet & Pewter Post
			Graded-In Laminates (T2) & (T3) see pages 156-161	PVC color must be selected with Graded-In Laminates (T2) & (T3)	

Model Number Breakdown

NST30-29RDX					
NS	T	30	29	RD	X
Nosh	Laminate	30" Diameter	Height	Round Top Shape	X Base

Description

Round Table with X Base  
(continued)

Veneer Tables  
"NSV" Models

Solid Surface Tables  
"NSS" Models

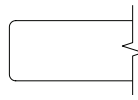

Eased Edge (R3)

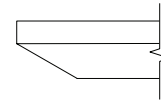

Reverse Bevel Edge (K9)

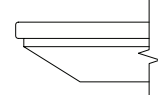

Reverse Bevel Edge (S7)

	D	W	H	CTN WT	CU FT	① Model	Eased Edge (R3)		Reverse Bevel Edge (K9)		Reverse Bevel Edge (S7) Standard
							Flat Cut	Double Cut	Flat Cut	Double Cut	
VENEER	48	N/A	29	86	22	NSV48-29RDX	\$1,706	\$1,827	\$1,776	\$1,901	--
	42	N/A	29	72	17	NSV42-29RDX	\$1,560	\$1,670	\$1,621	\$1,736	--
	36	N/A	29	59	17	NSV36-29RDX	\$1,509	\$1,615	\$1,570	\$1,681	--
	30	N/A	29	47	14	NSV30-29RDX	\$1,453	\$1,555	\$1,511	\$1,617	--
SOLID SURFACE	48	N/A	29	117	22	NSS48-29RDX	--	--	--	--	\$4,095
	42	N/A	29	95	17	NSS42-29RDX	--	--	--	--	\$3,478
	36	N/A	29	75	17	NSS36-29RDX	--	--	--	--	\$3,022
	30	N/A	29	58	14	NSS30-29RDX	--	--	--	--	\$2,620

NOSH

To Order Specify

① Veneer Model #	② Edge Detail	③ Wood Species	④ Wood Finish	⑤ Electrical Cut Out	⑥ Metal Finish
Veneer (NSV)	R3 Eased K9 Reverse Bevel	<b>Flat Cut</b> CH1 Cherry MA1 Maple WA1 Walnut	Cherry: BRL Barley BBM Bourbon Medium BRM Brighton Medium CLA Classic CLL Collectors* EAR Earthy HRV Harvest* LGC Legacy PRL Praline* SAF Saffron  Maple: ALM Ale Medium BUT Butterscotch CIN Cinnamon FLX Flax VEN Venetian  Walnut: AUB Auburn ESP Espresso MCH Mocha* NTO Night Owl* SIE Sienna* TOF Toffee* TRF Truffle*  *finishes with coordinating laminate tops	N None COB_EC23 Cut out for EC23 COB_EC24 Cut out for EC24	BWH Bright White Feet & Post MBK Matte Black Feet & Post PEW Pewter Feet & Post ASLASL Arctic Silver Feet & Post ASLBWH Arctic Silver Feet & Bright White Post ASLMBK Arctic Silver Feet & Matte Black Post ASLPEW Arctic Silver Feet & Pewter Post PAMASL Polished Aluminum Feet & Arctic Silver Post PAMBWH Polished Aluminum Feet & Bright White Post PAMMBK Polished Aluminum Feet & Matte Black Post PAMPEW Polished Aluminum Feet & Pewter Post
		<b>Double Cut</b> DC2 Double Cut	<b>④ Wood Finish</b>  Double Cut: COF Coffee FOS Fossil KHK Khaki CRM Cremello GRH Graphite STU Studio Teak		

① Solid Surface Model #	② Edge Detail	③ Solid Surface	④ Electrical Cut Out	⑤ Metal Finish
Solid Surface (NSS)	S7 Reverse Bevel	<b>Tier 1</b> ARM Armadillo BLP Black Pearl GRA Graphite Granite PEB Pebble Pearl PUR Pure White	N None COB_EC23 Cut out for EC23 COB_EC24 Cut out for EC24	BWH Bright White Feet & Post MBK Matte Black Feet & Post PEW Pewter Feet & Post ASLASL Arctic Silver Feet & Post ASLBWH Arctic Silver Feet & Bright White Post ASLMBK Arctic Silver Feet & Matte Black Post ASLPEW Arctic Silver Feet & Pewter Post PAMASL Polished Aluminum Feet & Arctic Silver Post PAMBWH Polished Aluminum Feet & Bright White Post PAMMBK Polished Aluminum Feet & Matte Black Post PAMPEW Polished Aluminum Feet & Pewter Post

Description

Round Table with X4 Base

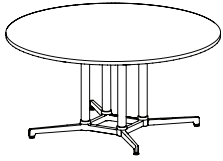

Laminate Tables  
"NST" Models

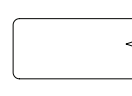

Eased Edge (R3)

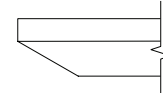

Reverse Bevel Edge (K9)

LAMINATE	D	W	H	CTN WT	CU FT	① Model	Eased Edge (R3)			Reverse Bevel Edge (K9)		
							Standard	Graded In		Standard	Graded In	
							Tier 1	Tier 2	Tier 3	Tier 1	Tier 2	Tier 3
	60	N/A	29	148	46	NST60-29RDZ	\$2,078	\$2,153	\$2,323	\$2,447	\$2,523	\$2,692
	54	N/A	29	103	26	NST54-29RDZ	\$2,036	\$2,094	\$2,152	\$2,405	\$2,463	\$2,521

Features:

- price reflects complete table - top and base
- ships KD in multiple cartons
- top has option for cutout to receive electrical component, ordered separately
- optional vertical wire manager for base, order separately
- base has leveling glides
- width of base foot is 38"

HSON

To Order Specify

① Laminate Model #	② Edge Detail	③ Laminate Selection	③a PVC Edge Color	④ Electrical Cut Out	⑤ Metal Finish
Laminate (NST)	R3 Eased K9 Reverse Bevel	<b>Standard Laminates (T1)</b> Solid Patterns: ALB Alabaster      DWH Designer White BLK Black          SHD Shadow BBL Bridal Blanco    SLG Slate Grey  Wood Grain Patterns: AGA Aged Ash      GRH Graphite ALL Ale Light      HGL High Line BLO Blonde Echo    OAT Oatmeal Cookie BOL Bourbon Light    PIN Pinnacle Walnut BZW Brazilwood      STU Studio Teak BGL Brighton Light    VIN Vintage CLL Collectors        WLH Walnut Heights FLO Florence Walnut    WEA Weathered Ash	Color: Standard (T1) laminates have a matching PVC. AGA Aged Ash ALB Alabaster ALL Ale Light BLK Black BLO Blonde Echo BOL Bourbon Light BZW Brazilwood BBL Bridal Blanco BGL Brighton Light CLL Collectors DWH Designer White FLO Florence Walnut GRH Graphite HGL High Line OAT Oatmeal Cookie PIN Pinnacle Walnut SHD Shadow SLG Slate Grey STU Studio Teak VIN Vintage WLH Walnut Heights WEA Weathered Ash	N None CO_EC23 Cut out for EC23 CO_EC24 Cut out for EC24	BWH Bright White Feet & Post MBK Matte Black Feet & Post PEW Pewter Feet & Post ASLASL Arctic Silver Feet & Post ASLBWH Arctic Silver Feet & Bright White Post ASLMBK Arctic Silver Feet & Matte Black Post ASLPEW Arctic Silver Feet & Pewter Post PAMASL Polished Aluminum Feet & Arctic Silver Post PAMBWH Polished Aluminum Feet & Bright White Post PAMMBK Polished Aluminum Feet & Matte Black Post PAMPEW Polished Aluminum Feet & Pewter Post
			Graded-In Laminates (T2) & (T3) see pages 156-161	PVC color must be selected with Graded-In Laminates (T2) & (T3)	

Model Number Breakdown

NST54-29RDZ					
NS	T	54	29	RD	Z
Nosh	Laminate	54" Diameter	Height	Round Top Shape	X4 base

Description

Round Table with X4 Base  
(continued)

Veneer Tables  
"NSV" Models

Solid Surface Tables  
"NSS" Models

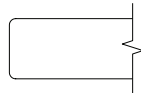

Eased Edge (R3)

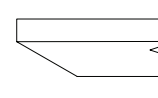

Reverse Bevel Edge (K9)

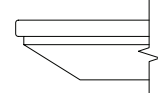

Reverse Bevel Edge (S7)

	D	W	H	CTN WT	CU FT	① Model	Eased Edge (R3)		Reverse Bevel Edge (K9)		Standard
							Flat Cut	Double Cut	Flat Cut	Double Cut	
VENEER	60	N/A	29	148	46	NSV60-29RDZ	\$2,783	\$2,979	\$2,894	\$3,098	--
	54	N/A	29	103	26	NSV54-29RDZ	\$2,727	\$2,917	\$2,835	\$3,035	--
SOL SURF	60	N/A	29	196	46	NSS60-29RDZ	--	--	--	--	\$6,295
	54	N/A	29	141	26	NSS54-29RDZ	--	--	--	--	\$5,646

NOSH

To Order Specify

① Veneer Model #	② Edge Detail	③ Wood Species	④ Wood Finish			⑤ Electrical Cut Out	⑥ Metal Finish
Veneer (NSV)	R3 Eased K9 Reverse Bevel	<b>Flat Cut</b> CH1 Cherry MA1 Maple WA1 Walnut	Cherry: BRL Barley BBM Bourbon Medium BRM Brighton Medium CLA Classic CLL Collectors* EAR Earthy HRV Harvest* LGC Legacy PRL Praline* SAF Saffron	Maple: ALM Ale Medium BUT Butterscotch CIN Cinnamon FLX Flax VEN Venetian	Walnut: AUB Auburn ESP Espresso MCH Mocha* NTO Night Owl* SIE Sienna* TOF Toffee* TRF Truffle*	N None CO_EC23 Cut out for EC23 CO_EC24 Cut out for EC24	BWH Bright White Feet & Post MBK Matte Black Feet & Post PEW Pewter Feet & Post ASLASL Arctic Silver Feet & Post ASLBWH Arctic Silver Feet & Bright White Post ASLMBK Arctic Silver Feet & Matte Black Post ASLPEW Arctic Silver Feet & Pewter Post PAMASL Polished Aluminum Feet & Arctic Silver Post PAMBWH Polished Aluminum Feet & Bright White Post PAMMBK Polished Aluminum Feet & Matte Black Post PAMPEW Polished Aluminum Feet & Pewter Post
		<b>Double Cut</b> DC2 Double Cut	④ Wood Finish Double Cut: COF Coffee FOS Fossil KHK Khaki CRM Cremello GRH Graphite STU Studio Teak				

① Solid Surface Model #	② Edge Detail	③ Solid Surface	④ Electrical Cut Out	⑤ Metal Finish
Solid Surface (NSS)	S7 Reverse Bevel	<b>Tier 1</b> ARM Armadillo BLP Black Pearl GRA Graphite Granite PEB Pebble Pearl PUR Pure White	N None CO_EC23 Cut out for EC23 CO_EC24 Cut out for EC24	BWH Bright White Feet & Post MBK Matte Black Feet & Post PEW Pewter Feet & Post ASLASL Arctic Silver Feet & Post ASLBWH Arctic Silver Feet & Bright White Post ASLMBK Arctic Silver Feet & Matte Black Post ASLPEW Arctic Silver Feet & Pewter Post PAMASL Polished Aluminum Feet & Arctic Silver Post PAMBWH Polished Aluminum Feet & Bright White Post PAMMBK Polished Aluminum Feet & Matte Black Post PAMPEW Polished Aluminum Feet & Pewter Post

Description

Round Table with Round Disc Base

Laminate Tables  
"NST" Models

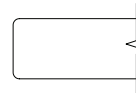
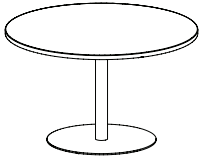

Eased Edge (R3)

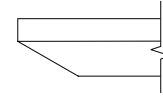

Reverse Bevel (K9)

LAMINATE	D	W	H	CTN WT	CU FT	Model	Eased Edge (R3)			Reverse Bevel (K9)		
							Standard	Graded In		Standard	Graded In	
							Tier 1	Tier 2	Tier 3	Tier 1	Tier 2	Tier 3
	48	N/A	29	130	22	NST48-29RDR	\$1,476	\$1,527	\$1,635	\$1,846	\$1,897	\$2,004
	42	N/A	29	97	17	NST42-29RDR	\$1,340	\$1,386	\$1,463	\$1,711	\$1,755	\$1,832
	36	N/A	29	85	14	NST36-29RDR	\$1,136	\$1,173	\$1,225	\$1,505	\$1,542	\$1,595
	30	N/A	29	62	12	NST30-29RDR	\$963	\$993	\$1,025	\$1,332	\$1,363	\$1,394

Features:

- price reflects complete table - top and base
- ships KD in multiple cartons
- cut out for power is not available on these tables
- base has anti-rock glides
- width of base foot varies from 17" to 27"

HSON

To Order Specify

1 Laminate Model #	2 Edge Detail	3 Laminate Selection	3a PVC Edge Color	4 Metal Finish
Laminate (NST)	R3 Eased	<b>Standard Laminates (T1)</b> Solid Patterns: ALB Alabaster      DWH Designer White BLK Black          SHD Shadow BBL Bridal Blanco    SLG Slate Grey  Wood Grain Patterns: AGA Aged Ash      GRH Graphite ALL Ale Light      HGL High Line BLO Blonde Echo    OAT Oatmeal Cookie BOL Bourbon Light    PIN Pinnacle Walnut BZW Brazilwood      STU Studio Teak BGL Brighton Light    VIN Vintage CLL Collectors      WLH Walnut Heights FLO Florence Walnut    WEA Weathered Ash	Color: Standard (T1) laminates have a matching PVC. AGA Aged Ash ALB Alabaster ALL Ale Light BLK Black BLO Blonde Echo BOL Bourbon Light BZW Brazilwood BBL Bridal Blanco BGL Brighton Light CLL Collectors DWH Designer White FLO Florence Walnut GRH Graphite HGL High Line OAT Oatmeal Cookie PIN Pinnacle Walnut SHD Shadow SLG Slate Grey STU Studio Teak VIN Vintage WLH Walnut Heights WEA Weathered Ash	BWH Bright White Feet & Post MBK Matte Black Feet & Post PEW Pewter Feet & Post ASLASL Arctic Silver Feet & Post ASLBWH Arctic Silver Feet & Bright White Post ASLMBK Arctic Silver Feet & Matte Black Post ASLPEW Arctic Silver Feet & Pewter Post
	K9 Reverse Bevel			

Model Number Breakdown

NST30-29RDR					
NS	T	30	29	RD	R
Nosh	Laminate	30" Diameter	Height	Round Top Shape	Round Disc Base

Description

Round Table with Round Disc Base  
(continued)

Veneer Tables  
"NSV" Models

Solid Surface Tables  
"NSS" Models

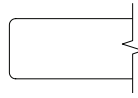

Eased Edge (R3)

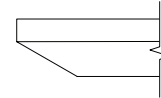

Reverse Bevel Edge (K9)

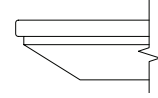

Reverse Bevel Edge (S7)

	D	W	H	CTN WT	CU FT	① Model	Eased Edge (R3)		Reverse Bevel Edge (K9)		Reverse Bevel Edge (S7)
							Flat Cut	Double Cut	Flat Cut	Double Cut	
VENEER	48	N/A	29	130	22	NSV48-29RDR	\$1,978	\$2,116	\$2,058	\$2,201	--
	42	N/A	29	97	17	NSV42-29RDR	\$1,797	\$1,923	\$1,870	\$2,002	--
	36	N/A	29	85	14	NSV36-29RDR	\$1,521	\$1,628	\$1,583	\$1,694	--
	30	N/A	29	62	12	NSV30-29RDR	\$1,290	\$1,380	\$1,342	\$1,436	--
SOLID SURFACE	48	N/A	29	160	22	NSS48-29RDR	--	--	--	--	\$4,365
	42	N/A	29	138	17	NSS42-29RDR	--	--	--	--	\$3,715
	36	N/A	29	71	14	NSS36-29RDR	--	--	--	--	\$3,034
	30	N/A	29	73	12	NSS30-29RDR	--	--	--	--	\$2,457

NOSH

To Order Specify

① Veneer Model #	② Edge Detail	③ Wood Species	④ Wood Finish	⑤ Metal Finish		
Veneer (NSV)	R3 Eased K9 Reverse Bevel	<b>Flat Cut</b> CH1 Cherry MA1 Maple WA1 Walnut	Cherry: BRL Barley BBM Bourbon Medium BRM Brighton Medium CLA Classic CLL Collectors* EAR Earthy HRV Harvest* LGC Legacy PRL Praline* SAF Saffron	Maple: ALM Ale Medium BUT Butterscotch CIN Cinnamon FLX Flax VEN Venetian	Walnut: AUB Auburn ESP Espresso MCH Mocha* NTO Night Owl* SIE Sienna* TOF Toffee TRF Truffle*	BWH Bright White Feet & Post MBK Matte Black Feet & Post PEW Pewter Feet & Post ASLASL Arctic Silver Feet & Post ASLBWH Arctic Silver Feet & Bright White Post ASLMBK Arctic Silver Feet & Matte Black Post ASLPEW Arctic Silver Feet & Pewter Post
			<b>Double Cut</b> DC2 Double Cut	<b>④ Wood Finish</b> Double Cut: COF Coffee FOS Fossil KHK Khaki CRM Cremello GRH Graphite STU Studio Teak		

① Solid Surface Model #	② Edge Detail	③ Solid Surface	④ Metal Finish
Solid Surface (NSS)	S7 Reverse Bevel	<b>Tier 1</b> ARM Armadillo BLP Black Pearl GRA Graphite Granite PEB Pebble Pearl PUR Pure White	BWH Bright White Feet & Post MBK Matte Black Feet & Post PEW Pewter Feet & Post ASLASL Arctic Silver Feet & Post ASLBWH Arctic Silver Feet & Bright White Post ASLMBK Arctic Silver Feet & Matte Black Post ASLPEW Arctic Silver Feet & Pewter Post



Description

Round Table with Square Disc Base

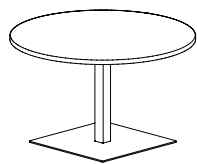

Laminate Tables  
"NST" Models



Eased Edge (R3)

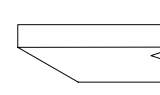

Reverse Bevel Edge (K9)

LAMINATE	D	W	H	CTN WT	CU FT	1 Model	Eased Edge (R3)			Reverse Bevel Edge (K9)		
							Standard	Graded In		Standard	Graded In	
							Tier 1	Tier 2	Tier 3	Tier 1	Tier 2	Tier 3
	48	N/A	29	145	22	NST48-29RDS	\$1,657	\$1,707	\$1,815	\$2,026	\$2,079	\$2,185
	42	N/A	29	108	17	NST42-29RDS	\$1,522	\$1,707	\$1,815	\$1,891	\$2,079	\$2,185
	36	N/A	29	96	14	NST36-29RDS	\$1,260	\$1,296	\$1,350	\$1,630	\$1,667	\$1,720
	30	N/A	29	68	12	NST30-29RDS	\$1,088	\$1,118	\$1,150	\$1,457	\$1,488	\$1,520

Features:

- price reflects complete table - top and base
- ships KD in multiple cartons
- cut out for power is not available on these tables
- base has anti-rock glides
- width of base foot varies from 17" to 27"

HSON

To Order Specify

1 Laminate Model #	2 Edge Detail	3 Laminate Selection	3a PVC Edge Color	4 Metal Finish
Laminate (NST)	R3 Eased K9 Reverse Bevel	<b>Standard Laminates (T1)</b> Solid Patterns: ALB Alabaster      DWH Designer White BLK Black          SHD Shadow BBL Bridal Blanco    SLG Slate Grey  Wood Grain Patterns: AGA Aged Ash      GRH Graphite ALL Ale Light      HGL High Line BLO Blonde Echo    OAT Oatmeal Cookie BOL Bourbon Light    PIN Pinnacle Walnut BZW Brazilwood      STU Studio Teak BGL Brighton Light    VIN Vintage CLL Collectors        WLH Walnut Heights FLO Florence Walnut    WEA Weathered Ash	Color: Standard (T1) laminates have a matching PVC. AGA Aged Ash ALB Alabaster ALL Ale Light BLK Black BLO Blonde Echo BOL Bourbon Light BZW Brazilwood BBL Bridal Blanco BGL Brighton Light CLL Collectors DWH Designer White FLO Florence Walnut GRH Graphite HGL High Line OAT Oatmeal Cookie PIN Pinnacle Walnut SHD Shadow SLG Slate Grey STU Studio Teak VIN Vintage WLH Walnut Heights WEA Weathered Ash	BWH Bright White Feet & Post MBK Matte Black Feet & Post PEW Pewter Feet & Post ASLASL Arctic Silver Feet & Post ASLBWH Arctic Silver Feet & Bright White Post ASLMBK Arctic Silver Feet & Matte Black Post ASLPEW Arctic Silver Feet & Pewter Post
		Graded-In Laminates (T2) & (T3) see pages 156-161	PVC color must be selected with Graded-In Laminates (T2) & (T3)	

Model Number Breakdown

NST30-29RDS					
NS	T	30	29	RD	S
Nosh	Laminate	30" Diameter	Height	Round Top Shape	Square Disc Base

Description

Round Table with Square Disc Base  
(continued)

Veneer Tables  
"NSV" Models

Solid Surface Tables  
"NSS" Models

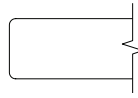

Eased Edge (R3)

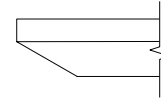

Reverse Bevel Edge (K9)

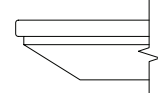

Reverse Bevel Edge (S7)

	D	W	H	CTN WT	CU FT	① Model	Eased Edge (R3)		Reverse Bevel Edge (K9)		Reverse Bevel Edge (S7)
							Flat Cut	Double Cut	Flat Cut	Double Cut	
VENEER	48	N/A	29	145	22	NSV48-29RDS	\$2,221	\$2,376	\$2,311	\$2,473	--
	42	N/A	29	108	17	NSV42-29RDS	\$2,040	\$2,182	\$2,122	\$2,270	--
	36	N/A	29	96	14	NSV36-29RDS	\$1,690	\$1,808	\$1,758	\$1,881	--
	30	N/A	29	68	12	NSV30-29RDS	\$1,457	\$1,560	\$1,517	\$1,624	--
SOLID SURFACE	48	N/A	29	175	22	NSS48-29RDS	--	--	--	--	\$4,610
	42	N/A	29	153	17	NSS42-29RDS	--	--	--	--	\$3,958
	36	N/A	29	145	14	NSS36-29RDS	--	--	--	--	\$3,202
	30	N/A	29	139	12	NSS30-29RDS	--	--	--	--	\$2,624

NOSH

To Order Specify

① Veneer Model #	② Edge Detail	③ Wood Species	④ Wood Finish	⑤ Metal Finish		
Veneer (NSV)	R3 Eased K9 Reverse Bevel	<b>Flat Cut</b> CH1 Cherry MA1 Maple WA1 Walnut	Cherry: BRL Barley BBM Bourbon Medium BRM Brighton Medium CLA Classic CLL Collectors* EAR Earthy HRV Harvest* LGC Legacy PRL Praline* SAF Saffron	Maple: ALM Ale Medium BUT Butterscotch CIN Cinnamon FLX Flax VEN Venetian *finishes with coordinating laminate tops	Walnut: AUB Auburn ESP Espresso MCH Mocha* NTO Night Owl* SIE Sienna* TOF Toffee TRF Truffle*	BWH Bright White Feet & Post MBK Matte Black Feet & Post PEW Pewter Feet & Post ASLASL Arctic Silver Feet & Post ASLBWH Arctic Silver Feet & Bright White Post ASLMBK Arctic Silver Feet & Matte Black Post ASLPEW Arctic Silver Feet & Pewter Post
	<b>Double Cut</b> DC2 Double Cut	<b>④ Wood Finish</b> Double Cut: COF Coffee FOS Fossil KHK Khaki CRM Cremello GRH Graphite STU Studio Teak				

① Solid Surface Model #	② Edge Detail	③ Solid Surface	④ Metal Finish
Solid Surface (NSS)	S7 Reverse Bevel	<b>Tier 1</b> ARM Armadillo BLP Black Pearl GRA Graphite Granite PEB Pebble Pearl PUR Pure White	BWH Bright White Feet & Post MBK Matte Black Feet & Post PEW Pewter Feet & Post ASLASL Arctic Silver Feet & Post ASLBWH Arctic Silver Feet & Bright White Post ASLMBK Arctic Silver Feet & Matte Black Post ASLPEW Arctic Silver Feet & Pewter Post

Description

Square Table with X Base



Laminate Tables  
"NST" Models

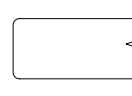

Eased Edge (R3)

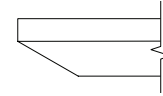

Reverse Bevel Edge (K9)

LAMINATE	D	W	H	CTN WT	CU FT	① Model	Standard			Graded In		
							Tier 1	Tier 2	Tier 3	Tier 1	Tier 2	Tier 3
							48	48	29	103	22	NST4848-29SQX
42	42	29	85	17	NST4242-29SQX	\$1,195	\$1,237	\$1,338	\$1,564	\$1,606	\$1,707	
36	36	29	68	17	NST3636-29SQX	\$1,052	\$1,087	\$1,110	\$1,422	\$1,456	\$1,480	
30	30	29	53	12	NST3030-29SQX	\$937	\$966	\$978	\$1,308	\$1,335	\$1,348	

Features:

- price reflects complete table - top and base
- ships KD in multiple cartons
- top has option for cutout to receive electrical component, ordered separately
- when electrical cut out selected, power accessible base is sent - add \$95
- base has leveling glides
- width of base foot varies from 26" to 38"

HSON

To Order Specify

① Laminate Model #	② Edge Detail	③ Laminate Selection	③a PVC Edge Color	④ Electrical Cut Out	⑤ Metal Finish
Laminate (NST)	R3 Eased K9 Reverse Bevel	<b>Standard Laminates (T1)</b> Solid Patterns: ALB Alabaster      DWH Designer White BLK Black          SHD Shadow BBL Bridal Blanco    SLG Slate Grey  Wood Grain Patterns: AGA Aged Ash      GRH Graphite ALL Ale Light      HGL High Line BLO Blonde Echo    OAT Oatmeal Cookie BOL Bourbon Light    PIN Pinnacle Walnut BZW Brazilwood      STU Studio Teak BGL Brighton Light    VIN Vintage CLL Collectors        WLH Walnut Heights FLO Florence Walnut    WEA Weathered Ash	Color: Standard (T1) laminates have a matching PVC. AGA Aged Ash ALB Alabaster ALL Ale Light BLK Black BLO Blonde Echo BOL Bourbon Light BZW Brazilwood BBL Bridal Blanco BGL Brighton Light CLL Collectors DWH Designer White FLO Florence Walnut GRH Graphite HGL High Line OAT Oatmeal Cookie PIN Pinnacle Walnut SHD Shadow SLG Slate Grey STU Studio Teak VIN Vintage WLH Walnut Heights WEA Weathered Ash	N None COB_EC23 Cut out for EC23 COB_EC24 Cut out for EC24	BWH Bright White Feet & Post MBK Matte Black Feet & Post PEW Pewter Feet & Post ASLASL Arctic Silver Feet & Post ASLBWH Arctic Silver Feet & Bright White Post ASLMBK Arctic Silver Feet & Matte Black Post ASLPEW Arctic Silver Feet & Pewter Post PAMASL Polished Aluminum Feet & Arctic Silver Post PAMBWH Polished Aluminum Feet & Bright White Post PAMMBK Polished Aluminum Feet & Matte Black Post PAMPEW Polished Aluminum Feet & Pewter Post
		Graded-In Laminates (T2) & (T3) see pages 156-161	PVC color must be selected with Graded-In Laminates (T2) & (T3)		

Model Number Breakdown

NST3030-29SQX					
NS	T	3030	29	SQ	X
Nosh	Laminate	30" x 30"	Height	Square Top Shape	X Base

Description

Square Table with X Base  
(continued)

Veneer Tables  
"NSV" Models

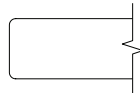

Eased Edge (R3)

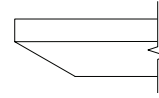

Reverse Bevel Edge (K9)

VENEER	D	W	H	CTN WT	CU FT	① Model	Flat Cut	Double Cut	Flat Cut	Double Cut
		48	48	29	103	22	NSV4848-29SQX	\$1,720	\$1,840	\$1,789
	42	42	29	85	17	NSV4242-29SQX	\$1,576	\$1,686	\$1,640	\$1,755
	36	36	29	68	17	NSV3636-29SQX	\$1,389	\$1,486	\$1,445	\$1,546
	30	30	29	53	12	NSV3030-29SQX	\$1,238	\$1,326	\$1,288	\$1,378

NOSH

To Order Specify

① Veneer Model #	② Edge Detail	③ Wood Species	④ Wood Finish			⑤ Electrical Cut Out	⑥ Metal Finish
Veneer (NSV)	R3 Eased K9 Reverse Bevel	<b>Flat Cut</b> CH1 Cherry MA1 Maple WA1 Walnut	Cherry: BRL Barley BBM Bourbon Medium BRM Brighton Medium CLA Classic CLL Collectors* EAR Earthy HRV Harvest* LGC Legacy PRL Praline* SAF Saffron	Maple: ALM Ale Medium BUT Butterscotch CIN Cinnamon FLX Flax VEN Venetian	Walnut: AUB Auburn ESP Espresso MCH Mocha* NTO Night Owl* SIE Sienna* TOF Toffee TRF Truffle*	N None COB_EC23 Cut out for EC23 COB_EC24 Cut out for EC24	BWH Bright White Feet & Post MBK Matte Black Feet & Post PEW Pewter Feet & Post ASLASL Arctic Silver Feet & Post ASLBWH Arctic Silver Feet & Bright White Post ASLMBK Arctic Silver Feet & Matte Black Post ASLPEW Arctic Silver Feet & Pewter Post PAMASL Polished Aluminum Feet & Arctic Silver Post PAMBWH Polished Aluminum Feet & Bright White Post PAMMBK Polished Aluminum Feet & Matte Black Post PAMPEW Polished Aluminum Feet & Pewter Post
			<b>Double Cut</b> DC2 Double Cut	<b>④ Wood Finish</b> Double Cut: COF Coffee FOS Fossil KHK Khaki CRM Cremello GRH Graphite STU Studio Teak			

Description

Rounded Square Table with X Base

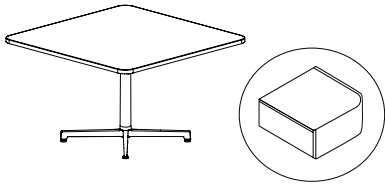

Laminate Tables  
"NST" Models

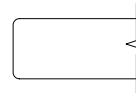

Eased Edge (R3)

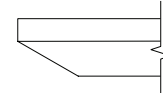

Reverse Bevel (K9)

LAMINATE	D	W	H	CTN WT	CU FT	1 Model	Eased Edge (R3)			Reverse Bevel (K9)		
							Standard	Graded In		Standard	Graded In	
							Tier 1	Tier 2	Tier 3	Tier 1	Tier 2	Tier 3
	48	48	29	103	22	NST4848-29SQRX	\$1,603	\$1,648	\$1,781	\$1,972	\$2,018	\$2,151
	42	42	29	85	17	NST4242-29SQRX	\$1,483	\$1,526	\$1,671	\$1,853	\$1,896	\$2,040
	36	36	29	69	17	NST3636-29SQRX	\$1,224	\$1,259	\$1,313	\$1,594	\$1,629	\$1,682
	30	30	29	53	12	NST3030-29SQRX	\$1,088	\$1,117	\$1,150	\$1,457	\$1,486	\$1,520

Features:

- price reflects complete table - top and base
- ships KD in multiple cartons
- top has option for cutout to receive electrical component, ordered separately
- when electrical cut out selected, power accessible base is sent - add \$95
- base has leveling glides
- width of base foot varies from 26" to 38"

HSON

To Order Specify

1 Laminate Model #	2 Edge Detail	3 Laminate Selection	3a PVC Edge Color	4 Electrical Cut Out	5 Metal Finish
Laminate (NST)	R3 Eased K9 Reverse Bevel	<b>Standard Laminates (T1)</b> Solid Patterns: ALB Alabaster      DWH Designer White BLK Black          SHD Shadow BBL Bridal Blanco    SLG Slate Grey  Wood Grain Patterns: AGA Aged Ash      GRH Graphite ALL Ale Light        HGL High Line BLO Blonde Echo    OAT Oatmeal Cookie BOL Bourbon Light    PIN Pinnacle Walnut BZW Brazilwood     STU Studio Teak BGL Brighton Light    VIN Vintage CLL Collectors        WLH Walnut Heights FLO Florence Walnut    WEA Weathered Ash	Color: Standard (T1) laminates have a matching PVC. AGA Aged Ash ALB Alabaster ALL Ale Light BLK Black BLO Blonde Echo BOL Bourbon Light BZW Brazilwood BBL Bridal Blanco BGL Brighton Light CLL Collectors DWH Designer White FLO Florence Walnut GRH Graphite HGL High Line OAT Oatmeal Cookie PIN Pinnacle Walnut SHD Shadow SLG Slate Grey STU Studio Teak VIN Vintage WLH Walnut Heights WEA Weathered Ash	N None COB_EC23 Cut out for EC23 COB_EC24 Cut out for EC24	BWH Bright White Feet & Post MBK Matte Black Feet & Post PEW Pewter Feet & Post ASLASL Arctic Silver Feet & Post ASLBWH Arctic Silver Feet & Bright White Post ASLMBK Arctic Silver Feet & Matte Black Post ASLPEW Arctic Silver Feet & Pewter Post PAMASL Polished Aluminum Feet & Arctic Silver Post PAMBWH Polished Aluminum Feet & Bright White Post PAMMBK Polished Aluminum Feet & Matte Black Post PAMPEW Polished Aluminum Feet & Pewter Post
			Graded-In Laminates (T2) & (T3) see pages 156-161	PVC color must be selected with Graded-In Laminates (T2) & (T3)	

Model Number Breakdown

NST3030-29SQRX						
NS	T	3030	29	SQ	R	X
Nosh	Laminate	30" x 30"	Height	Square Top Shape	Rounded Corner	X base

Description

Rounded Square Table with X Base  
(continued)

Veneer Tables  
"NSV" Models

Solid Surface Tables  
"NSS" Models

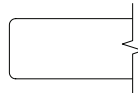

Eased Edge (R3)

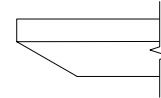

Reverse Bevel Edge (K9)

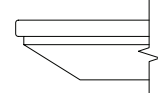

Reverse Bevel Edge (S7)

	D	W	H	CTN WT	CU FT	① Model	Eased Edge (R3)		Reverse Bevel Edge (K9)		Reverse Bevel Edge (S7)
							Flat Cut	Double Cut	Flat Cut	Double Cut	
VENEER	48	48	29	103	22	NSV4848-29SQRX	\$2,115	\$2,265	\$2,200	\$2,355	--
	42	42	29	85	17	NSV4242-29SQRX	\$1,965	\$2,103	\$2,045	\$2,189	--
	36	36	29	69	17	NSV3636-29SQRX	\$1,615	\$1,729	\$1,680	\$1,798	--
	30	30	29	53	12	NSV3030-29SQRX	\$1,435	\$1,538	\$1,494	\$1,598	--
SOLID SURFACE	48	48	29	145	22	NSS4848-29SQRX	--	--	--	--	\$4,504
	42	42	29	117	17	NSS4242-29SQRX	--	--	--	--	\$3,884
	36	36	29	93	17	NSS3636-29SQRX	--	--	--	--	\$3,128
	30	30	29	70	12	NSS3030-29SQRX	--	--	--	--	\$2,602

NOSH

To Order Specify

① Veneer Model #	② Edge Detail	③ Wood Species	④ Wood Finish			⑤ Electrical Cut Out	⑥ Metal Finish
Veneer (NSV)	R3 Eased K9 Reverse Bevel	<b>Flat Cut</b> CH1 Cherry MA1 Maple WA1 Walnut	Cherry: BRL Barley BBM Bourbon Medium BRM Brighton Medium CLA Classic CLL Collectors* EAR Earthy HRV Harvest* LGC Legacy PRL Praline* SAF Saffron	Maple: ALM Ale Medium BUT Butterscotch CIN Cinnamon FLX Flax VEN Venetian	Walnut: AUB Auburn ESP Espresso MCH Mocha* NTO Night Owl* SIE Sienna* TOF Toffee* TRF Truffle*	N None COB_EC23 Cut out for EC23 COB_EC24 Cut out for EC24	BWH Bright White Feet & Post MBK Matte Black Feet & Post PEW Pewter Feet & Post ASLASL Arctic Silver Feet & Post ASLBWH Arctic Silver Feet & Bright White Post ASLMBK Arctic Silver Feet & Matte Black Post ASLPEW Arctic Silver Feet & Pewter Post PAMASL Polished Aluminum Feet & Arctic Silver Post PAMBWH Polished Aluminum Feet & Bright White Post PAMMBK Polished Aluminum Feet & Matte Black Post PAMPEW Polished Aluminum Feet & Pewter Post
		<b>Double Cut</b> DC2 Double Cut	④ Wood Finish Double Cut: COF Coffee FOS Fossil KHK Khaki CRM Cremello GRH Graphite STU Studio Teak				

① Solid Surface Model #	② Edge Detail	③ Solid Surface	④ Electrical Cut Out	⑤ Metal Finish
Solid Surface (NSS)	S7 Reverse Bevel	<b>Tier 1</b> ARM Armadillo BLP Black Pearl GRA Graphite Granite PEB Pebble Pearl PUR Pure White	N None COB_EC23 Cut out for EC23 COB_EC24 Cut out for EC24	BWH Bright White Feet & Post MBK Matte Black Feet & Post PEW Pewter Feet & Post ASLASL Arctic Silver Feet & Post ASLBWH Arctic Silver Feet & Bright White Post ASLMBK Arctic Silver Feet & Matte Black Post ASLPEW Arctic Silver Feet & Pewter Post PAMASL Polished Aluminum Feet & Arctic Silver Post PAMBWH Polished Aluminum Feet & Bright White Post PAMMBK Polished Aluminum Feet & Matte Black Post PAMPEW Polished Aluminum Feet & Pewter Post

Description

Square Table with X4 Base

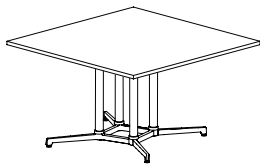

Laminate Tables  
"NST" Models

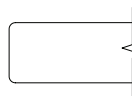

Eased Edge (R3)

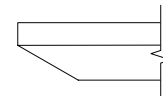

Reverse Bevel Edge (K9)

LAMINATE	D	W	H	CTN WT	CU FT	① Model	Eased Edge (R3)			Reverse Bevel Edge (K9)		
							Standard	Graded In		Standard	Graded In	
							Tier 1	Tier 2	Tier 3	Tier 1	Tier 2	Tier 3
	60	60	29	175	46	NST6060-29SQZ	\$2,385	\$2,460	\$2,631	\$2,755	\$2,829	\$3,000
	54	54	29	151	50	NST5454-29SQZ	\$2,262	\$2,328	\$2,461	\$2,632	\$2,697	\$2,830

Features:

- price reflects complete table - top and base
- ships KD in multiple cartons
- top has option for cutout to receive electrical component, ordered separately
- optional vertical wire manager for base, order separately
- base has leveling glides
- width of base foot is 38"

HSON

To Order Specify

① Laminate Model #	② Edge Detail	③ Laminate Selection	③a PVC Edge Color	④ Electrical Cut Out	⑤ Metal Finish
Laminate (NST)	R3 Eased K9 Reverse Bevel	<b>Standard Laminates (T1)</b> Solid Patterns: ALB Alabaster      DWH Designer White BLK Black          SHD Shadow BBL Bridal Blanco    SLG Slate Grey  Wood Grain Patterns: AGA Aged Ash      GRH Graphite ALL Ale Light      HGL High Line BLO Blonde Echo    OAT Oatmeal Cookie BOL Bourbon Light    PIN Pinnacle Walnut BZW Brazilwood     STU Studio Teak BGL Brighton Light    VIN Vintage CLL Collectors      WLH Walnut Heights FLO Florence Walnut    WEA Weathered Ash	Color: Standard (T1) laminates have a matching PVC. AGA Aged Ash ALB Alabaster ALL Ale Light BLK Black BLO Blonde Echo BOL Bourbon Light BZW Brazilwood BBL Bridal Blanco BGL Brighton Light CLL Collectors DWH Designer White FLO Florence Walnut GRH Graphite HGL High Line OAT Oatmeal Cookie PIN Pinnacle Walnut SHD Shadow SLG Slate Grey STU Studio Teak VIN Vintage WLH Walnut Heights WEA Weathered Ash	N None CO_EC23 Cut out for EC23 CO_EC24 Cut out for EC24	BWH Bright White Feet & Post MBK Matte Black Feet & Post PEW Pewter Feet & Post ASLASL Arctic Silver Feet & Post ASLBWH Arctic Silver Feet & Bright White Post ASLMBK Arctic Silver Feet & Matte Black Post ASLPEW Arctic Silver Feet & Pewter Post PAMASL Polished Aluminum Feet & Arctic Silver Post PAMBWH Polished Aluminum Feet & Bright White Post PAMMBK Polished Aluminum Feet & Matte Black Post PAMPEW Polished Aluminum Feet & Pewter Post
		Graded-In Laminates (T2) & (T3) see pages 156-161	PVC color must be selected with Graded-In Laminates (T2) & (T3)		

Model Number Breakdown

NSV6060-29SQZ					
NS	V	6060	29	SQ	Z
Nosh	Veneer	60" x 60"	Height	Square Top Shape	X4 Base

Description

Square Table with X4 Base  
(continued)

Veneer Tables  
"NSV" Models

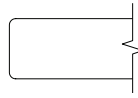

Eased Edge (R3)

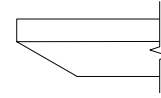

Reverse Bevel Edge (K9)

VENEER	D	W	H	CTN WT	CU FT	1 Model	Flat Cut	Double Cut	Flat Cut	Double Cut
	60	60	29	175	46	NSV6060-29SQZ	\$3,148	\$3,368	\$3,274	\$3,504
54	54	29	151	50	NSV5454-29SQZ	\$2,987	\$3,195	\$3,105	\$3,324	

To Order Specify

1 Veneer Model #	2 Edge Detail	3 Wood Species	4 Wood Finish			5 Electrical Cut Out	6 Metal Finish
Veneer (NSV)	R3 Eased K9 Reverse Bevel	<b>Flat Cut</b> CH1 Cherry MA1 Maple WA1 Walnut	Cherry: BRL Barley BBM Bourbon Medium BRM Brighton Medium CLA Classic CLL Collectors* EAR Earthy HRV Harvest* LGC Legacy PRL Praline* SAF Saffron	Maple: ALM Ale Medium BUT Butterscotch CIN Cinnamon FLX Flax VEN Venetian	Walnut: AUB Auburn ESP Espresso MCH Mocha* NTO Night Owl* SIE Sienna* TOF Toffee TRF Truffle*	N None CO_EC23 Cut out for EC23 CO_EC24 Cut out for EC24	BWH Bright White Feet & Post MBK Matte Black Feet & Post PEW Pewter Feet & Post ASLASL Arctic Silver Feet & Post ASLBWH Arctic Silver Feet & Bright White Post ASLMBK Arctic Silver Feet & Matte Black Post ASLPEW Arctic Silver Feet & Pewter Post PAMASL Polished Aluminum Feet & Arctic Silver Post PAMBWH Polished Aluminum Feet & Bright White Post PAMMBK Polished Aluminum Feet & Matte Black Post PAMPEW Polished Aluminum Feet & Pewter Post
			<b>Double Cut</b> DC2 Double Cut	<b>4 Wood Finish</b> Double Cut: COF Coffee FOS Fossil KHK Khaki CRM Cremello GRH Graphite STU Studio Teak			

NOSH



Description

Rounded Square Counter Height Table with X4 Base

Laminate Tables "NST" Models

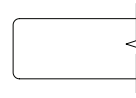
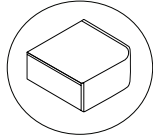
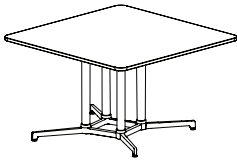

Eased Edge (R3)

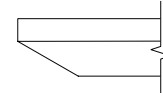

Reverse Bevel (K9)

LAMINATE	D	W	H	CTN WT	CU FT	① Model	Eased Edge (R3)			Reverse Bevel (K9)		
							Standard	Graded In		Standard	Graded In	
							Tier 1	Tier 2	Tier 3	Tier 1	Tier 2	Tier 3
	60	60	29	68	46	NST6060-29SQRZ	\$2,576	\$2,642	\$2,821	\$2,945	\$3,011	\$3,190
	54	54	29	174	50	NST5454-29SQRZ	\$2,102	\$2,170	\$2,301	\$2,471	\$2,539	\$2,671

Features:

- price reflects complete table - top and base
- ships KD in multiple cartons
- top has option for cutout to receive electrical component, ordered separately
- optional vertical wire manager for base, order separately
- base has leveling glides
- width of base foot is 38"

HSON

To Order Specify

① Laminate Model #	② Edge Detail	③ Laminate Selection	③a PVC Edge Color	④ Electrical Cut Out	⑤ Metal Finish
Laminate (NST)	R3 Eased K9 Reverse Bevel	<b>Standard Laminates (T1)</b> Solid Patterns: ALB Alabaster      DWH Designer White BLK Black          SHD Shadow BBL Bridal Blanco   SLG Slate Grey  Wood Grain Patterns: AGA Aged Ash      GRH Graphite ALL Ale Light      HGL High Line BLO Blonde Echo   OAT Oatmeal Cookie BOL Bourbon Light   PIN Pinnacle Walnut BZW Brazilwood    STU Studio Teak BGL Brighton Light VIN Vintage CLL Collectors     WLH Walnut Heights FLO Florence Walnut WEA Weathered Ash	Color: Standard (T1) laminates have a matching PVC. AGA Aged Ash ALB Alabaster ALL Ale Light BLK Black BLO Blonde Echo BOL Bourbon Light BZW Brazilwood BBL Bridal Blanco BGL Brighton Light CLL Collectors DWH Designer White FLO Florence Walnut GRH Graphite HGL High Line OAT Oatmeal Cookie PIN Pinnacle Walnut SHD Shadow SLG Slate Grey STU Studio Teak VIN Vintage WLH Walnut Heights WEA Weathered Ash	N None CO_EC23 Cut out for EC23 CO_EC24 Cut out for EC24	BWH Bright White Feet & Post MBK Matte Black Feet & Post PEW Pewter Feet & Post ASLASL Arctic Silver Feet & Post ASLBWH Arctic Silver Feet & Bright White Post ASLMBK Arctic Silver Feet & Matte Black Post ASLPEW Arctic Silver Feet & Pewter Post PAMASL Polished Aluminum Feet & Arctic Silver Post PAMBWH Polished Aluminum Feet & Bright White Post PAMMBK Polished Aluminum Feet & Matte Black Post PAMPEW Polished Aluminum Feet & Pewter Post
			Graded-In Laminates (T2) & (T3) see pages 156-161	PVC color must be selected with Graded-In Laminates (T2) & (T3)	

Model Number Breakdown

NST5454-29SQRZ						
NS	T	5454	29	SQ	R	Z
Nosh	Laminate	54" x 54"	Height	Square Top Shape	Rounded Corner	X4 Base

Description

Rounded Square Table with X4 Base  
(continued)

Veneer Tables  
"NSV" Models

Solid Surface Tables  
"NSS" Models

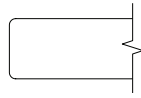

Eased Edge (R3)

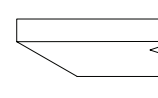

Reverse Bevel Edge (K9)

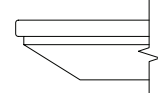

Reverse Bevel Edge (S7)

	D	W	H	CTN WT	CU FT	① Model	Veneer Tables "NSV" Models		Solid Surface Tables "NSS" Models		
							Flat Cut	Double Cut	Flat Cut	Double Cut	Standard
VENEER	60	60	29	174	46	NSV6060-29SQRZ	\$3,400	\$3,638	\$3,536	\$3,785	--
	54	54	29	151	50	NSV5454-29SQRZ	\$2,775	\$2,969	\$2,887	\$3,088	--
SOL SURF	60	60	29	235	46	NSS6060-29SQRZ	--	--	--	--	\$6,911
	54	54	29	200	50	NSS5454-29SQRZ	--	--	--	--	\$5,694

NOSH

To Order Specify

① Veneer Model #	② Edge Detail	③ Wood Species	④ Wood Finish			⑤ Electrical Cut Out	⑥ Metal Finish
Veneer (NSV)	R3 Eased K9 Reverse Bevel	Flat Cut CH1 Cherry MA1 Maple WA1 Walnut	Cherry: BRL Barley BBM Bourbon Medium BRM Brighton Medium CLA Classic CLL Collectors* EAR Earthy HRV Harvest* LGC Legacy PRL Praline* SAF Saffron	Maple: ALM Ale Medium BUT Butterscotch CIN Cinnamon FLX Flax VEN Venetian	Walnut: AUB Auburn ESP Espresso MCH Mocha* NTO Night Owl* SIE Sienna* TOF Toffee* TRF Truffle*	N None CO_EC23 Cut out for EC23 CO_EC24 Cut out for EC24	BWH Bright White Feet & Post MBK Matte Black Feet & Post PEW Pewter Feet & Post ASLASL Arctic Silver Feet & Post ASLBWH Arctic Silver Feet & Bright White Post ASLMBK Arctic Silver Feet & Matte Black Post ASLPEW Arctic Silver Feet & Pewter Post PAMASL Polished Aluminum Feet & Arctic Silver Post PAMBWH Polished Aluminum Feet & Bright White Post PAMMBK Polished Aluminum Feet & Matte Black Post PAMPEW Polished Aluminum Feet & Pewter Post
			Double Cut DC2 Double Cut	④ Wood Finish Double Cut: COF Coffee FOS Fossil KHK Khaki CRM Cremello GRH Graphite STU Studio Teak			

① Solid Surface Model #	② Edge Detail	③ Solid Surface	④ Electrical Cut Out	⑤ Metal Finish
Solid Surface (NSS)	S7 Reverse Bevel	Tier 1 ARM Armadillo BLP Black Pearl GRA Graphite Granite PEB Pebble Pearl PUR Pure White	N None CO_EC23 Cut out for EC23 CO_EC24 Cut out for EC24	BWH Bright White Feet & Post MBK Matte Black Feet & Post PEW Pewter Feet & Post ASLASL Arctic Silver Feet & Post ASLBWH Arctic Silver Feet & Bright White Post ASLMBK Arctic Silver Feet & Matte Black Post ASLPEW Arctic Silver Feet & Pewter Post PAMASL Polished Aluminum Feet & Arctic Silver Post PAMBWH Polished Aluminum Feet & Bright White Post PAMMBK Polished Aluminum Feet & Matte Black Post PAMPEW Polished Aluminum Feet & Pewter Post

Description

Square Table with Round Disc Base

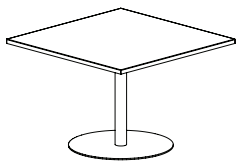

Laminate Tables  
"NST" Models

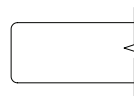

Eased Edge (R3)

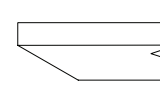

Reverse Bevel Edge (K9)

LAMINATE	D	W	H	CTN WT	CU FT	① Model	Eased Edge (R3)			Reverse Bevel Edge (K9)		
							Standard	Graded In		Standard	Graded In	
							Tier 1	Tier 2	Tier 3	Tier 1	Tier 2	Tier 3
	42	42	29	128	17	NST4242-29SQR	\$1,057	\$1,099	\$1,136	\$1,426	\$1,468	\$1,505
	36	36	29	94	15	NST3636-29SQR	\$959	\$994	\$1,016	\$1,329	\$1,365	\$1,387
	30	30	29	81	13	NST3030-29SQR	\$907	\$936	\$948	\$1,276	\$1,306	\$1,317

Features:

- price reflects complete table - top and base
- ships KD in multiple cartons
- cut out for power is not available on these tables
- base has anti-rock glides
- width of base foot varies from 22" or 27"

HSON

To Order Specify

① Laminate Model #	② Edge Detail	③ Laminate Selection	③a PVC Edge Color	④ Metal Finish
Laminate (NST)	R3 Eased K9 Reverse Bevel	<b>Standard Laminates (T1)</b> Solid Patterns: ALB Alabaster      DWH Designer White BLK Black          SHD Shadow BBL Bridal Blanco    SLG Slate Grey  Wood Grain Patterns: AGA Aged Ash      GRH Graphite ALL Ale Light      HGL High Line BLO Blonde Echo    OAT Oatmeal Cookie BOL Bourbon Light    PIN Pinnacle Walnut BZW Brazilwood      STU Studio Teak BGL Brighton Light    VIN Vintage CLL Collectors        WLH Walnut Heights FLO Florence Walnut    WEA Weathered Ash	Color: Standard (T1) laminates have a matching PVC. AGA Aged Ash ALB Alabaster ALL Ale Light BLK Black BLO Blonde Echo BOL Bourbon Light BZW Brazilwood BBL Bridal Blanco BGL Brighton Light CLL Collectors DWH Designer White FLO Florence Walnut GRH Graphite HGL High Line OAT Oatmeal Cookie PIN Pinnacle Walnut SHD Shadow SLG Slate Grey STU Studio Teak VIN Vintage WLH Walnut Heights WEA Weathered Ash	BWH Bright White Feet & Post MBK Matte Black Feet & Post PEW Pewter Feet & Post ASLASL Arctic Silver Feet & Post ASLBWH Arctic Silver Feet & Bright White Post ASLMBK Arctic Silver Feet & Matte Black Post ASLPEW Arctic Silver Feet & Pewter Post PAMASL Polished Aluminum Feet & Arctic Silver Post PAMBWH Polished Aluminum Feet & Bright White Post PAMMBK Polished Aluminum Feet & Matte Black Post PAMPEW Polished Aluminum Feet & Pewter Post
		Graded-In Laminates (T2) & (T3) see pages 156-161	PVC color must be selected with Graded-In Laminates (T2) & (T3)	

Model Number Breakdown

NST3030-29SQR					
NS	T	3030	29	SQ	R
Nosh	Laminate	30" x 30"	Height	Square Top Shape	Round Disc Base

Description

Square Table with Round Disc Base  
(continued)

Veneer Tables  
"NSV" Models

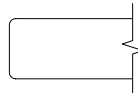

Eased Edge (R3)

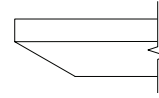

Reverse Bevel Edge (K9)

VENEER	D	W	H	CTN WT	CU FT	1 Model	Flat Cut	Double Cut	Flat Cut	Double Cut
	42	42	29	128	17	NSV4242-29SQR	\$1,394	\$1,492	\$1,451	\$1,552
36	36	29	94	15	NSV3636-29SQR	\$1,266	\$1,355	\$1,317	\$1,410	
30	30	29	81	13	NSV3030-29SQR	\$1,197	\$1,281	\$1,245	\$1,333	

To Order Specify

1 Veneer Model #	2 Edge Detail	3 Wood Species	4 Wood Finish	5 Metal Finish		
Veneer (NSV)	R3 Eased K9 Reverse Bevel	<b>Flat Cut</b> CH1 Cherry MA1 Maple WA1 Walnut	Cherry: BRL Barley BBM Bourbon Medium BRM Brighton Medium CLA Classic CLL Collectors* EAR Earthy HRV Harvest* LGC Legacy PRL Praline* SAF Saffron	Maple: ALM Ale Medium BUT Butterscotch CIN Cinnamon FLX Flax VEN Venetian *finishes with coordinating laminate tops	Walnut: AUB Auburn ESP Espresso MCH Mocha* NTO Night Owl* SIE Sienna* TOF Toffee TRF Truffle*	<b>BWH</b> Bright White Feet & Post <b>MBK</b> Matte Black Feet & Post <b>PEW</b> Pewter Feet & Post <b>ASLASL</b> Arctic Silver Feet & Post <b>ASLBWH</b> Arctic Silver Feet & Bright White Post <b>ASLMBK</b> Arctic Silver Feet & Matte Black Post <b>ASLPEW</b> Arctic Silver Feet & Pewter Post <b>PAMASL</b> Polished Aluminum Feet & Arctic Silver Post <b>PAMBWH</b> Polished Aluminum Feet & Bright White Post <b>PAMMBK</b> Polished Aluminum Feet & Matte Black Post <b>PAMPEW</b> Polished Aluminum Feet & Pewter Post
		<b>Double Cut</b> DC2 Double Cut	<b>4 Wood Finish</b> Double Cut: COF Coffee FOS Fossil KHK Khaki CRM Cremello GRH Graphite STU Studio Teak			

NOSH

Description

Rounded Square Table with Round Disc Base

Laminate Tables "NST" Models

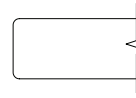
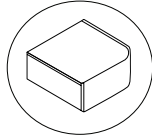
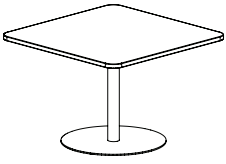

Eased Edge (R3)

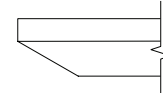

Reverse Bevel (K9)

LAMINATE	D	W	H	CTN WT	CU FT	① Model	Standard			Graded In		
							Tier 1	Tier 2	Tier 3	Tier 1	Tier 2	Tier 3
	42	42	29	128	17	<b>NST4242-29SQRR</b>	\$1,346	\$1,389	\$1,466	\$1,716	\$1,759	\$1,835
36	36	29	94	15	<b>NST3636-29SQRR</b>	\$1,131	\$1,166	\$1,220	\$1,501	\$1,538	\$1,589	
30	30	29	82	13	<b>NST3030-29SQRR</b>	\$1,057	\$1,088	\$1,119	\$1,426	\$1,457	\$1,489	

Features:

- price reflects complete table - top and base
- ships KD in multiple cartons
- cut out for power is not available on these tables
- base has anti-rock glides
- width of base foot varies from 22" or 27"

HSON

To Order Specify

① Laminate Model #	② Edge Detail	③ Laminate Selection	③a PVC Edge Color	④ Metal Finish
Laminate (NST)	R3 Eased	<b>Standard Laminates (T1)</b> Solid Patterns: ALB Alabaster      DWH Designer White BLK Black          SHD Shadow BBL Bridal Blanco    SLG Slate Grey  Wood Grain Patterns: AGA Aged Ash      GRH Graphite ALL Ale Light      HGL High Line BLO Blonde Echo    OAT Oatmeal Cookie BOL Bourbon Light    PIN Pinnacle Walnut BZW Brazilwood     STU Studio Teak BGL Brighton Light    VIN Vintage CLL Collectors      WLH Walnut Heights FLO Florence Walnut    WEA Weathered Ash	Color: <b>Standard (T1) laminates have a matching PVC.</b> AGA Aged Ash ALB Alabaster ALL Ale Light BLK Black BLO Blonde Echo BOL Bourbon Light BZW Brazilwood BBL Bridal Blanco BGL Brighton Light CLL Collectors DWH Designer White FLO Florence Walnut GRH Graphite HGL High Line OAT Oatmeal Cookie PIN Pinnacle Walnut SHD Shadow SLG Slate Grey STU Studio Teak VIN Vintage WLH Walnut Heights WEA Weathered Ash	BWH Bright White Feet & Post MBK Matte Black Feet & Post PEW Pewter Feet & Post ASLASL Arctic Silver Feet & Post ASLBWH Arctic Silver Feet & Bright White Post ASLMBK Arctic Silver Feet & Matte Black Post ASLPEW Arctic Silver Feet & Pewter Post PAMASL Polished Aluminum Feet & Arctic Silver Post PAMBWH Polished Aluminum Feet & Bright White Post PAMMBK Polished Aluminum Feet & Matte Black Post PAMPEW Polished Aluminum Feet & Pewter Post
	K9 Reverse Bevel			

Model Number Breakdown

NST3030-29SQRR						
NS	T	3030	29	SQ	R	R
Nosh	Laminate	30" x 30"	Height	Square Top Shape	Rounded Corner	Round Disc Base

Description

Rounded Square Table with Round Disc Base (continued)

		Veneer Tables "NSV" Models				Solid Surface Tables "NSS" Models					
		Eased Edge (R3)		Reverse Bevel Edge (K9)		Reverse Bevel Edge (S7)					
		Flat Cut	Double Cut	Flat Cut	Double Cut	Standard					
	D	W	H	CTN WT	CU FT	1 Model	Flat Cut	Double Cut	Flat Cut	Double Cut	Standard
VENEER	42	42	29	128	17	NSV4242-29SQRR	\$1,777	\$1,902	\$1,849	\$1,978	--
	36	36	29	94	15	NSV3636-29SQRR	\$1,492	\$1,597	\$1,552	\$1,661	--
	30	30	29	82	13	NSV3030-29SQRR	\$1,394	\$1,492	\$1,451	\$1,552	--
SOL SURF	42	42	29	157	17	NSS4242-29SQRR	--	--	--	--	\$3,695
	36	36	29	115	15	NSS3636-29SQRR	--	--	--	--	\$3,004
	30	30	29	83	13	NSS3030-29SQRR	--	--	--	--	\$2,561

To Order Specify

1 Veneer Model #	2 Edge Detail	3 Wood Species	4 Wood Finish	5 Metal Finish		
Veneer (NSV)	R3 Eased K9 Reverse Bevel	<b>Flat Cut</b> CH1 Cherry MA1 Maple WA1 Walnut	Cherry: BRL Barley BBM Bourbon Medium BRM Brighton Medium CLA Classic CLL Collectors* EAR Earthy HRV Harvest* LGC Legacy PRL Praline* SAF Saffron	Maple: ALM Ale Medium BUT Butterscotch CIN Cinnamon FLX Flax VEN Venetian	Walnut: AUB Auburn ESP Espresso MCH Mocha* NTO Night Owl* SIE Sienna* TOF Toffee TRF Truffle*	BWH Bright White Feet & Post MBK Matte Black Feet & Post PEW Pewter Feet & Post ASLASL Arctic Silver Feet & Post ASLBWH Arctic Silver Feet & Bright White Post ASLMBK Arctic Silver Feet & Matte Black Post ASLPEW Arctic Silver Feet & Pewter Post PAMASL Polished Aluminum Feet & Arctic Silver Post PAMBWH Polished Aluminum Feet & Bright White Post PAMMBK Polished Aluminum Feet & Matte Black Post PAMPEW Polished Aluminum Feet & Pewter Post
			<b>Double Cut</b> DC2 Double Cut	<b>4 Wood Finish</b> Double Cut: COF Coffee FOS Fossil KHK Khaki CRM Cremello GRH Graphite STU Studio Teak		

1 Solid Surface Model #	2 Edge Detail	3 Solid Surface	4 Metal Finish
Solid Surface (NSS)	S7 Reverse Bevel	<b>Tier 1</b> ARM Armadillo BLP Black Pearl GRA Graphite Granite PEB Pebble Pearl PUR Pure White	BWH Bright White Feet & Post MBK Matte Black Feet & Post PEW Pewter Feet & Post ASLASL Arctic Silver Feet & Post ASLBWH Arctic Silver Feet & Bright White Post ASLMBK Arctic Silver Feet & Matte Black Post ASLPEW Arctic Silver Feet & Pewter Post PAMASL Polished Aluminum Feet & Arctic Silver Post PAMBWH Polished Aluminum Feet & Bright White Post PAMMBK Polished Aluminum Feet & Matte Black Post PAMPEW Polished Aluminum Feet & Pewter Post

Description

Square Table with Square Disc Base

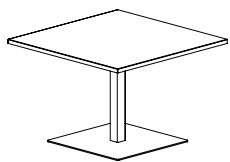

Laminate Tables  
"NST" Models

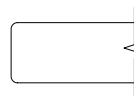

Eased Edge (R3)

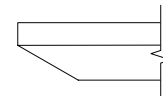

Reverse Bevel Edge (K9)

LAMINATE	D	W	H	CTN WT	CU FT	① Model	Eased Edge (R3)			Reverse Bevel Edge (K9)		
							Standard	Graded In		Standard	Graded In	
							Tier 1	Tier 2	Tier 3	Tier 1	Tier 2	Tier 3
	42	42	29	135	17	NST4242-29SQS	\$1,238	\$1,280	\$1,316	\$1,607	\$1,649	\$1,685
	36	36	29	126	15	NST3636-29SQS	\$1,085	\$1,119	\$1,142	\$1,454	\$1,489	\$1,511
	30	30	29	98	13	NST3030-29SQS	\$1,031	\$1,062	\$1,072	\$1,402	\$1,431	\$1,443

Features:

- price reflects complete table - top and base
- ships KD in multiple cartons
- cut out for power is not available on these tables
- base has anti-rock glides
- width of base foot varies from 17" to 27"

HSON

To Order Specify

① Laminate Model #	② Edge Detail	③ Laminate Selection	③a PVC Edge Color	④ Metal Finish
Laminate (NST)	R3 Eased	<b>Standard Laminates (T1)</b> Solid Patterns: ALB Alabaster      DWH Designer White BLK Black          SHD Shadow BBL Bridal Blanco    SLG Slate Grey  Wood Grain Patterns: AGA Aged Ash      GRH Graphite ALL Ale Light      HGL High Line BLO Blonde Echo    OAT Oatmeal Cookie BOL Bourbon Light    PIN Pinnacle Walnut BZW Brazilwood      STU Studio Teak BGL Brighton Light    VIN Vintage CLL Collectors        WLH Walnut Heights FLO Florence Walnut    WEA Weathered Ash	Color: Standard (T1) laminates have a matching PVC. AGA Aged Ash ALB Alabaster ALL Ale Light BLK Black BLO Blonde Echo BOL Bourbon Light BZW Brazilwood BBL Bridal Blanco BGL Brighton Light CLL Collectors DWH Designer White FLO Florence Walnut GRH Graphite HGL High Line OAT Oatmeal Cookie PIN Pinnacle Walnut SHD Shadow SLG Slate Grey STU Studio Teak VIN Vintage WLH Walnut Heights WEA Weathered Ash	BWH Bright White Feet & Post MBK Matte Black Feet & Post PEW Pewter Feet & Post ASLASL Arctic Silver Feet & Post ASLBWH Arctic Silver Feet & Bright White Post ASLMBK Arctic Silver Feet & Matte Black Post ASLPEW Arctic Silver Feet & Pewter Post
	K9 Reverse Bevel			

Model Number Breakdown

NST3030-29SQS					
NS	T	3030	29	SQ	S
Nosh	Laminate	30" x 30"	Height	Square Top Shape	Square Disc Base

Description

Square Table with Square Disc Base  
(continued)

Veneer Tables  
"NSV" Models

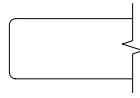

Eased Edge (R3)

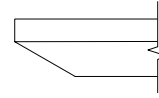

Reverse Bevel Edge (K9)

VENEER	D	W	H	CTN WT	CU FT	1 Model	Eased Edge (R3)		Reverse Bevel Edge (K9)	
							Flat Cut	Double Cut	Flat Cut	Double Cut
	42	42	29	135	17	NSV4242-29SQS	\$1,634	\$1,818	\$1,699	\$1,819
	36	36	29	126	15	NSV3636-29SQS	\$1,431	\$1,589	\$1,489	\$1,594
	30	30	29	98	13	NSV3030-29SQS	\$1,361	\$1,507	\$1,416	\$1,517

NOSH

To Order Specify

1 Veneer Model #	2 Edge Detail	3 Wood Species	4 Wood Finish			5 Metal Finish
Veneer (NSV)	R3 Eased	<b>Flat Cut</b> CH1 Cherry MA1 Maple WA1 Walnut	Cherry:	Maple:	Walnut:	<b>BWH</b> Bright White Feet & Post <b>MBK</b> Matte Black Feet & Post <b>PEW</b> Pewter Feet & Post <b>ASLASL</b> Arctic Silver Feet & Post <b>ASLBWH</b> Arctic Silver Feet & Bright White Post <b>ASLMBK</b> Arctic Silver Feet & Matte Black Post <b>ASLPEW</b> Arctic Silver Feet & Pewter Post
	K9 Reverse Bevel		BRL Barley BBM Bourbon Medium BRM Brighton Medium CLA Classic CLL Collectors* EAR Earthy HRV Harvest* LGC Legacy PRL Praline* SAF Saffron	ALM Ale Medium BUT Butterscotch CIN Cinnamon FLX Flax VEN Venetian	AUB Auburn ESP Espresso MCH Mocha* NTO Night Owl* SIE Sienna* TOF Toffee TRF Truffle*	
		<b>Double Cut</b> DC2 Double Cut	<b>4 Wood Finish</b> Double Cut: COF Coffee FOS Fossil KHK Khaki CRM Cremello GRH Graphite STU Studio Teak			



Description

Rounded Square Table with Square Disc Base

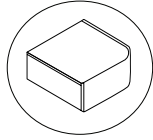
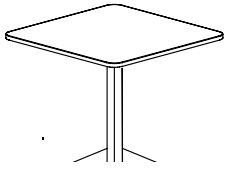

Laminate Tables "NST" Models

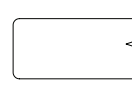

Eased Edge (R3)

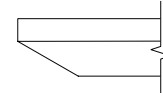

Reverse Bevel (K9)

LAMINATE	D	W	H	CTN WT	CU FT	① Model	Standard			Graded In		
							Tier 1	Tier 2	Tier 3	Tier 1	Tier 2	Tier 3
							42	42	29	143	17	<b>NST4242-29SQRS</b>
36	36	29	105	15	<b>NST3636-29SQRS</b>	\$1,380	\$1,417	\$1,469	\$1,750	\$1,787	\$1,839	
30	30	29	91	13	<b>NST3030-29SQRS</b>	\$1,308	\$1,337	\$1,370	\$1,677	\$1,706	\$1,739	

Features:

- price reflects complete table - top and base
- ships KD in multiple cartons
- cut out for power is not available on these tables
- base has anti-rock glides
- width of base foot varies from 17" to 27"

HSON

To Order Specify

① Laminate Model #	② Edge Detail	③ Laminate Selection	③a PVC Edge Color	④ Metal Finish
Laminate (NST)	R3 Eased	<b>Standard Laminates (T1)</b> Solid Patterns: ALB Alabaster      DWH Designer White BLK Black          SHD Shadow BBL Bridal Blanco    SLG Slate Grey  Wood Grain Patterns: AGA Aged Ash      GRH Graphite ALL Ale Light      HGL High Line BLO Blonde Echo    OAT Oatmeal Cookie BOL Bourbon Light    PIN Pinnacle Walnut BZW Brazilwood      STU Studio Teak BGL Brighton Light    VIN Vintage CLL Collectors      WLH Walnut Heights FLO Florence Walnut    WEA Weathered Ash	Color: Standard (T1) laminates have a matching PVC. AGA Aged Ash ALB Alabaster ALL Ale Light BLK Black BLO Blonde Echo BOL Bourbon Light BZW Brazilwood BBL Bridal Blanco BGL Brighton Light CLL Collectors DWH Designer White FLO Florence Walnut GRH Graphite HGL High Line OAT Oatmeal Cookie PIN Pinnacle Walnut SHD Shadow SLG Slate Grey STU Studio Teak VIN Vintage WLH Walnut Heights WEA Weathered Ash	BWH Bright White Feet & Post MBK Matte Black Feet & Post PEW Pewter Feet & Post ASLASL Arctic Silver Feet & Post ASLBWH Arctic Silver Feet & Bright White Post ASLMBK Arctic Silver Feet & Matte Black Post ASLPEW Arctic Silver Feet & Pewter Post
	K9 Reverse Bevel			

Model Number Breakdown

NSV3636-29SQRS						
NS	V	3636	29	SQ	R	S
Nosh	Veneer	36" x 36"	Height	Square Top Shape	Rounded Corner	Square Disc Base

Description

Rounded Square Table with Square Disc Base (continued)

		Veneer Tables "NSV" Models				Solid Surface Tables "NSS" Models					
		Eased Edge (R3)		Reverse Bevel Edge (K9)		Reverse Bevel Edge (S7)					
		Flat Cut	Double Cut	Flat Cut	Double Cut	Standard					
	D	W	H	CTN WT	CU FT	1 Model	Flat Cut	Double Cut	Flat Cut	Double Cut	Standard
VENEER	42	42	29	143	17	NSV4242-29SQRS	\$2,016	\$2,156	\$2,096	\$2,242	--
	36	36	29	105	15	NSV3636-29SQRS	\$1,824	\$1,952	\$1,897	\$2,030	--
	30	30	29	91	13	NSV3030-29SQRS	\$1,725	\$1,848	\$1,794	\$1,921	--
SOL SURF	42	42	29	172	17	NSS4242-29SQRS	--	--	--	--	\$3,934
	36	36	29	126	15	NSS3636-29SQRS	--	--	--	--	\$3,336
	30	30	29	88	13	NSS3030-29SQRS	--	--	--	--	\$2,892

NOSH

To Order Specify

1 Veneer Model #	2 Edge Detail	3 Wood Species	4 Wood Finish	5 Metal Finish		
Veneer (NSV)	R3 Eased K9 Reverse Bevel	<b>Flat Cut</b> CH1 Cherry MA1 Maple WA1 Walnut	Cherry: BRL Barley BBM Bourbon Medium BRM Brighton Medium CLA Classic CLL Collectors* EAR Earthy HRV Harvest* LGC Legacy PRL Praline* SAF Saffron	Maple: ALM Ale Medium BUT Butterscotch CIN Cinnamon FLX Flax VEN Venetian	Walnut: AUB Auburn ESP Espresso MCH Mocha* NTO Night Owl* SIE Sienna* TOF Toffee TRF Truffle*	BWH Bright White Feet & Post MBK Matte Black Feet & Post PEW Pewter Feet & Post ASLASL Arctic Silver Feet & Post ASLBWH Arctic Silver Feet & Bright White Post ASLMBK Arctic Silver Feet & Matte Black Post ASLPEW Arctic Silver Feet & Pewter Post
		<b>Double Cut</b> DC2 Double Cut	<b>4 Wood Finish</b> Double Cut: COF Coffee FOS Fossil KHK Khaki CRM Cremello GRH Graphite STU Studio Teak			

1 Solid Surface Model #	2 Edge Detail	3 Solid Surface	4 Metal Finish
Solid Surface (NSS)	S7 Reverse Bevel	<b>Tier 1</b> ARM Armadillo BLP Black Pearl GRA Graphite Granite PEB Pebble Pearl PUR Pure White	BWH Bright White Feet & Post MBK Matte Black Feet & Post PEW Pewter Feet & Post ASLASL Arctic Silver Feet & Post ASLBWH Arctic Silver Feet & Bright White Post ASLMBK Arctic Silver Feet & Matte Black Post ASLPEW Arctic Silver Feet & Pewter Post

Description

Squircle Table with X Base

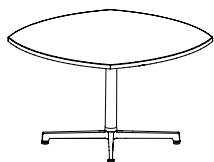

Laminate Tables  
"NST" Models

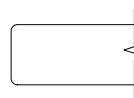

Eased Edge (R3)

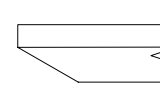

Reverse Bevel Edge (K9)

LAMINATE	D	W	H	CTN WT	CU FT	① Model	Eased Edge (R3)			Reverse Bevel Edge (K9)		
							Standard	Graded In		Standard	Graded In	
							Tier 1	Tier 2	Tier 3	Tier 1	Tier 2	Tier 3
	48	48	29	86	22	NST48-29SCX	\$1,291	\$1,388	\$1,495	\$1,661	\$1,759	\$1,866
	42	42	29	72	17	NST42-29SCX	\$1,181	\$1,276	\$1,355	\$1,551	\$1,647	\$1,725
	36	36	29	59	17	NST36-29SCX	\$1,142	\$1,178	\$1,233	\$1,512	\$1,548	\$1,604
	30	30	29	47	14	NST30-29SCX	\$1,100	\$1,129	\$1,161	\$1,470	\$1,500	\$1,532

Features:

- price reflects complete table - top and base
- ships KD in multiple cartons
- top has option for cutout to receive electrical component, ordered separately
- when electrical cut out selected, power accessible base is sent - add \$95
- base has leveling glides
- width of base foot varies from 26" to 38"

HSON

To Order Specify

① Laminate Model #	② Edge Detail	③ Laminate Selection	③a PVC Edge Color	④ Electrical Cut Out	⑤ Metal Finish
Laminate (NST)	R3 Eased	<b>Standard Laminates (T1)</b> Solid Patterns: ALB Alabaster      DWH Designer White BLK Black          SHD Shadow BBL Bridal Blanco    SLG Slate Grey  Wood Grain Patterns: AGA Aged Ash      GRH Graphite ALL Ale Light      HGL High Line BLO Blonde Echo    OAT Oatmeal Cookie BOL Bourbon Light    PIN Pinnacle Walnut BZW Brazilwood     STU Studio Teak BGL Brighton Light    VIN Vintage CLL Collectors      WLH Walnut Heights FLO Florence Walnut    WEA Weathered Ash	Color: <b>Standard (T1) laminates</b> have a matching PVC. AGA Aged Ash ALB Alabaster ALL Ale Light BLK Black BLO Blonde Echo BOL Bourbon Light BZW Brazilwood BBL Bridal Blanco BGL Brighton Light CLL Collectors DWH Designer White FLO Florence Walnut GRH Graphite HGL High Line OAT Oatmeal Cookie PIN Pinnacle Walnut SHD Shadow SLG Slate Grey STU Studio Teak VIN Vintage WLH Walnut Heights WEA Weathered Ash	N None COB_EC23 Cut out for EC23 COB_EC24 Cut out for EC24	BWH Bright White Feet & Post MBK Matte Black Feet & Post PEW Pewter Feet & Post ASLASL Arctic Silver Feet & Post ASLBWH Arctic Silver Feet & Bright White Post ASLMBK Arctic Silver Feet & Matte Black Post ASLPEW Arctic Silver Feet & Pewter Post PAMASL Polished Aluminum Feet & Arctic Silver Post PAMBWH Polished Aluminum Feet & Bright White Post PAMMBK Polished Aluminum Feet & Matte Black Post PAMPEW Polished Aluminum Feet & Pewter Post
	K9 Reverse Bevel				

Model Number Breakdown

NST30-29SCX					
NS	T	30	29	SC	X
Nosh	Laminate	30"	Height	Squircle Top Shape	X Base

Description

Squirrel Table with X Base  
(continued)

Veneer Tables  
"NSV" Models

Solid Surface Tables  
"NSS" Models

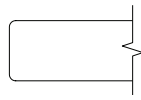

Eased Edge (R3)

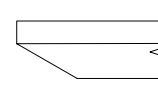

Reverse Bevel Edge (K9)

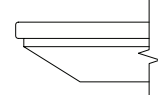

Reverse Bevel Edge (S7)

	D	W	H	CTN WT	CU FT	① Model	Eased Edge (R3)		Reverse Bevel Edge (K9)		Reverse Bevel Edge (S7)
							Flat Cut	Double Cut	Flat Cut	Double Cut	
VENEER	48	48	29	86	22	NSV48-29SCX	\$1,724	\$1,844	\$1,793	\$1,918	--
	42	42	29	72	17	NSV42-29SCX	\$1,576	\$1,685	\$1,640	\$1,754	--
	36	36	29	59	17	NSV36-29SCX	\$1,525	\$1,632	\$1,588	\$1,698	--
	30	30	29	47	14	NSV30-29SCX	\$1,468	\$1,570	\$1,528	\$1,635	--
SOLID SURFACE	48	48	29	117	22	NSS48-29SCX	--	--	--	--	\$4,127
	42	42	29	95	17	NSS42-29SCX	--	--	--	--	\$3,509
	36	36	29	75	17	NSS36-29SCX	--	--	--	--	\$3,054
	30	30	29	58	14	NSS30-29SCX	--	--	--	--	\$2,651

NOSH

To Order Specify

① Veneer Model #	② Edge Detail	③ Wood Species	④ Wood Finish	⑤ Electrical Cut Out	⑥ Metal Finish		
Veneer (NSV)	R3 Eased K9 Reverse Bevel	<b>Flat Cut</b> CH1 Cherry MA1 Maple WA1 Walnut	Cherry: BRL Barley BBM Bourbon Medium BRM Brighton Medium CLA Classic CLL Collectors* EAR Earthy HRV Harvest* LGC Legacy PRL Praline* SAF Saffron	Maple: ALM Ale Medium BUT Butterscotch CIN Cinnamon FLX Flax VEN Venetian	Walnut: AUB Auburn ESP Espresso MCH Mocha* NTO Night Owl* SIE Sienna* TOF Toffee* TRF Truffle*	N None COB_EC23 Cut out for EC23 COB_EC24 Cut out for EC24	BWH Bright White Feet & Post MBK Matte Black Feet & Post PEW Pewter Feet & Post ASLASL Arctic Silver Feet & Post ASLBWH Arctic Silver Feet & Bright White Post ASLMBK Arctic Silver Feet & Matte Black Post ASLPEW Arctic Silver Feet & Pewter Post PAMASL Polished Aluminum Feet & Arctic Silver Post PAMBWH Polished Aluminum Feet & Bright White Post PAMMBK Polished Aluminum Feet & Matte Black Post PAMPEW Polished Aluminum Feet & Pewter Post
		<b>Double Cut</b> DC2 Double Cut	<b>④ Wood Finish</b> Double Cut: COF Coffee FOS Fossil KHK Khaki CRM Cremello GRH Graphite STU Studio Teak				

① Solid Surface Model #	② Edge Detail	③ Solid Surface	④ Electrical Cut Out	⑤ Metal Finish
Solid Surface (NSS)	S7 Reverse Bevel	<b>Tier 1</b> ARM Armadillo BLP Black Pearl GRA Graphite Granite PEB Pebble Pearl PUR Pure White	N None COB_EC23 Cut out for EC23 COB_EC24 Cut out for EC24	BWH Bright White Feet & Post MBK Matte Black Feet & Post PEW Pewter Feet & Post ASLASL Arctic Silver Feet & Post ASLBWH Arctic Silver Feet & Bright White Post ASLMBK Arctic Silver Feet & Matte Black Post ASLPEW Arctic Silver Feet & Pewter Post PAMASL Polished Aluminum Feet & Arctic Silver Post PAMBWH Polished Aluminum Feet & Bright White Post PAMMBK Polished Aluminum Feet & Matte Black Post PAMPEW Polished Aluminum Feet & Pewter Post

Description

Squircle Table with X4 Base

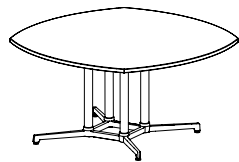

Laminate Tables  
"NST" Models

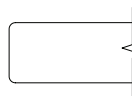

Eased Edge (R3)

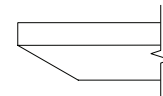

Reverse Bevel Edge (K9)

LAMINATE	D	W	H	CTN WT	CU FT	① Model	Standard			Graded In		
							Tier 1	Tier 2	Tier 3	Tier 1	Tier 2	Tier 3
							60	60	29	148	46	<b>NST60-29SCZ</b>
54	54	29	103	26	<b>NST54-29SCZ</b>	\$2,051	\$2,110	\$2,170	\$2,423	\$2,482	\$2,540	

Features:

- price reflects complete table - top and base
- ships KD in multiple cartons
- top has option for cutout to receive electrical component, ordered separately
- optional vertical wire manager for base, order separately
- base has leveling glides
- width of base foot is 38"

HSON

To Order Specify

① Laminate Model #	② Edge Detail	③ Laminate Selection	③a PVC Edge Color	④ Electrical Cut Out	⑤ Metal Finish
Laminate (NST)	R3 Eased K9 Reverse Bevel	<b>Standard Laminates (T1)</b> Solid Patterns: ALB Alabaster      DWH Designer White BLK Black          SHD Shadow BBL Bridal Blanco    SLG Slate Grey  Wood Grain Patterns: AGA Aged Ash      GRH Graphite ALL Ale Light      HGL High Line BLO Blonde Echo    OAT Oatmeal Cookie BOL Bourbon Light    PIN Pinnacle Walnut BZW Brazilwood      STU Studio Teak BGL Brighton Light    VIN Vintage CLL Collectors        WLH Walnut Heights FLO Florence Walnut    WEA Weathered Ash	Color: Standard (T1) laminates have a matching PVC. AGA Aged Ash ALB Alabaster ALL Ale Light BLK Black BLO Blonde Echo BOL Bourbon Light BZW Brazilwood BBL Bridal Blanco BGL Brighton Light CLL Collectors DWH Designer White FLO Florence Walnut GRH Graphite HGL High Line OAT Oatmeal Cookie PIN Pinnacle Walnut SHD Shadow SLG Slate Grey STU Studio Teak VIN Vintage WLH Walnut Heights WEA Weathered Ash	N None CO_EC23 Cut out for EC23 CO_EC24 Cut out for EC24	BWH Bright White Feet & Post MBK Matte Black Feet & Post PEW Pewter Feet & Post ASLASL Arctic Silver Feet & Post ASLBWH Arctic Silver Feet & Bright White Post ASLMBK Arctic Silver Feet & Matte Black Post ASLPEW Arctic Silver Feet & Pewter Post PAMASL Polished Aluminum Feet & Arctic Silver Post PAMBWH Polished Aluminum Feet & Bright White Post PAMMBK Polished Aluminum Feet & Matte Black Post PAMPEW Polished Aluminum Feet & Pewter Post
		Graded-In Laminates (T2) & (T3) see pages 156-161	PVC color must be selected with Graded-In Laminates (T2) & (T3)		

Model Number Breakdown

NST54-29SCZ					
NS	T	54	29	SC	Z
Nosh	Laminate	54"	Height	Squircle Top Shape	X4 Base

Description

Squire Table with X4 Base  
(continued)

		Veneer Tables "NSV" Models				Solid Surface Tables "NSS" Models					
		Eased Edge (R3)		Reverse Bevel Edge (K9)		Reverse Bevel Edge (S7)					
		Flat Cut	Double Cut	Flat Cut	Double Cut	Standard					
	D	W	H	CTN WT	CU FT	① Model	Flat Cut	Double Cut	Flat Cut	Double Cut	Standard
VENEER	60	60	29	148	46	NSV60-29SCZ	\$2,800	\$2,996	\$2,912	\$3,117	--
	54	54	29	103	26	NSV54-29SCZ	\$2,742	\$2,934	\$2,853	\$3,053	--
SOL SURF	60	60	29	196	46	NSS60-29SCZ	--	--	--	--	\$6,326
	54	54	29	141	46	NSS54-29SCZ	--	--	--	--	\$5,677

NOSH

To Order Specify

① Veneer Model #	② Edge Detail	③ Wood Species	④ Wood Finish			⑤ Electrical Cut Out	⑥ Metal Finish
Veneer (NSV)	R3 Eased K9 Reverse Bevel	<b>Flat Cut</b> CH1 Cherry MA1 Maple WA1 Walnut	Cherry: BRL Barley BBM Bourbon Medium BRM Brighton Medium CLA Classic CLL Collectors* EAR Earthy HRV Harvest* LGC Legacy PRL Praline* SAF Saffron	Maple: ALM Ale Medium BUT Butterscotch CIN Cinnamon FLX Flax VEN Venetian	Walnut: AUB Auburn ESP Espresso MCH Mocha* NTO Night Owl* SIE Sienna* TOF Toffee* TRF Truffle*	N None CO_EC23 Cut out for EC23 CO_EC24 Cut out for EC24	BWH Bright White Feet & Post MBK Matte Black Feet & Post PEW Pewter Feet & Post ASLASL Arctic Silver Feet & Post ASLBWH Arctic Silver Feet & Bright White Post ASLMBK Arctic Silver Feet & Matte Black Post ASLPEW Arctic Silver Feet & Pewter Post PAMASL Polished Aluminum Feet & Arctic Silver Post PAMBWH Polished Aluminum Feet & Bright White Post PAMMBK Polished Aluminum Feet & Matte Black Post PAMPEW Polished Aluminum Feet & Pewter Post
		<b>Double Cut</b> DC2 Double Cut	<b>④ Wood Finish</b> Double Cut: COF Coffee FOS Fossil KHK Khaki CRM Cremello GRH Graphite STU Studio Teak				

① Solid Surface Model #	② Edge Detail	③ Solid Surface	④ Electrical Cut Out	⑤ Metal Finish
Solid Surface (NSS)	S7 Reverse Bevel	<b>Tier 1</b> ARM Armadillo BLP Black Pearl GRA Graphite Granite PEB Pebble Pearl PUR Pure White	N None CO_EC23 Cut out for EC23 CO_EC24 Cut out for EC24	BWH Bright White Feet & Post MBK Matte Black Feet & Post PEW Pewter Feet & Post ASLASL Arctic Silver Feet & Post ASLBWH Arctic Silver Feet & Bright White Post ASLMBK Arctic Silver Feet & Matte Black Post ASLPEW Arctic Silver Feet & Pewter Post PAMASL Polished Aluminum Feet & Arctic Silver Post PAMBWH Polished Aluminum Feet & Bright White Post PAMMBK Polished Aluminum Feet & Matte Black Post PAMPEW Polished Aluminum Feet & Pewter Post

Description

Squircle Table with Round Disc Base

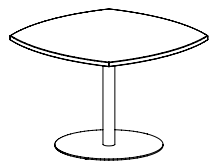

Laminate Tables  
"NST" Models

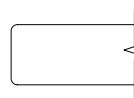

Eased Edge (R3)

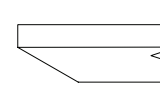

Reverse Bevel Edge (K9)

LAMINATE	D	W	H	CTN WT	CU FT	① Model	Standard			Graded In		
							Tier 1	Tier 2	Tier 3	Tier 1	Tier 2	Tier 3
							NST42-29SCR	\$1,358	\$1,403	\$1,480	\$1,729	\$1,773
NST36-29SCR	\$1,152	\$1,187	\$1,241	\$1,522	\$1,559	\$1,611						
NST30-29SCR	\$978	\$1,009	\$1,042	\$1,349	\$1,379	\$1,412						

Features:

- price reflects complete table - top and base
- ships KD in multiple cartons
- cut out for power is not available on these tables
- base has anti-rock glides
- width of base foot varies from 17" to 27"

HSON

To Order Specify

① Laminate Model #	② Edge Detail	③ Laminate Selection	③a PVC Edge Color	④ Metal Finish
Laminate (NST)	R3 Eased K9 Reverse Bevel	<b>Standard Laminates (T1)</b> Solid Patterns: ALB Alabaster      DWH Designer White BLK Black          SHD Shadow BBL Bridal Blanco    SLG Slate Grey  Wood Grain Patterns: AGA Aged Ash      GRH Graphite ALL Ale Light      HGL High Line BLO Blonde Echo    OAT Oatmeal Cookie BOL Bourbon Light    PIN Pinnacle Walnut BZW Brazilwood     STU Studio Teak BGL Brighton Light    VIN Vintage CLL Collectors      WLH Walnut Heights FLO Florence Walnut    WEA Weathered Ash	Color: Standard (T1) laminates have a matching PVC. AGA Aged Ash ALB Alabaster ALL Ale Light BLK Black BLO Blonde Echo BOL Bourbon Light BZW Brazilwood BBL Bridal Blanco BGL Brighton Light CLL Collectors DWH Designer White FLO Florence Walnut GRH Graphite HGL High Line OAT Oatmeal Cookie PIN Pinnacle Walnut SHD Shadow SLG Slate Grey STU Studio Teak VIN Vintage WLH Walnut Heights WEA Weathered Ash	BWH Bright White Feet & Post MBK Matte Black Feet & Post PEW Pewter Feet & Post ASLASL Arctic Silver Feet & Post ASLBWH Arctic Silver Feet & Bright White Post ASLMBK Arctic Silver Feet & Matte Black Post ASLPEW Arctic Silver Feet & Pewter Post
		Graded-In Laminates (T2) & (T3) see pages 156-161	PVC color must be selected with Graded-In Laminates (T2) & (T3)	

Model Number Breakdown

NST30-29SCR					
NS	T	30	29	SC	R
Nosh	Laminate	30"	Height	Squircle Top Shape	Round Disc Base

Description

Squirrel Table with Round Disc Base  
(continued)

Veneer Tables  
"NSV" Models

Solid Surface Tables  
"NSS" Models

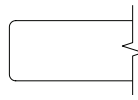

Eased Edge (R3)

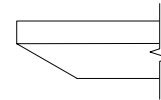

Reverse Bevel Edge (K9)

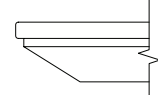

Reverse Bevel Edge (S7)

	D	W	H	CTN WT	CU FT	① Model	Eased Edge (R3)		Reverse Bevel Edge (K9)		Standard
							Flat Cut	Double Cut	Flat Cut	Double Cut	
VENEER	42	42	29	97	17	NSV42-29SCR	\$1,814	\$1,941	\$1,888	\$2,020	--
	36	36	29	85	14	NSV36-29SCR	\$1,538	\$1,643	\$1,599	\$1,711	--
	30	30	29	62	12	NSV30-29SCR	\$1,306	\$1,397	\$1,359	\$1,454	--
SOL SURF	42	42	29	138	17	NSS42-29SCR	--	--	--	--	\$3,748
	36	36	29	71	14	NSS36-29SCR	--	--	--	--	\$3,065
	30	30	29	73	12	NSS30-29SCR	--	--	--	--	\$2,489

To Order Specify

① Veneer Model #	② Edge Detail	③ Wood Species	④ Wood Finish	⑤ Metal Finish		
Veneer (NSV)	R3 Eased K9 Reverse Bevel	<b>Flat Cut</b> CH1 Cherry MA1 Maple WA1 Walnut	Cherry: BRL Barley BBM Bourbon Medium BRM Brighton Medium CLA Classic CLL Collectors* EAR Earthy HRV Harvest* LGC Legacy PRL Praline* SAF Saffron	Maple: ALM Ale Medium BUT Butterscotch CIN Cinnamon FLX Flax VEN Venetian	Walnut: AUB Auburn ESP Espresso MCH Mocha* NTO Night Owl* SIE Sienna* TOF Toffee TRF Truffle*	BWH Bright White Feet & Post MBK Matte Black Feet & Post PEW Pewter Feet & Post ASLASL Arctic Silver Feet & Post ASLBWH Arctic Silver Feet & Bright White Post ASLMBK Arctic Silver Feet & Matte Black Post ASLPEW Arctic Silver Feet & Pewter Post
			<b>Double Cut</b> DC2 Double Cut	<b>④ Wood Finish</b> Double Cut: COF Coffee FOS Fossil KHK Khaki CRM Cremello GRH Graphite STU Studio Teak		

① Solid Surface Model #	② Edge Detail	③ Solid Surface	④ Metal Finish
Solid Surface (NSS)	S7 Reverse Bevel	<b>Tier 1</b> ARM Armadillo BLP Black Pearl GRA Graphite Granite PEB Pebble Pearl PUR Pure White	BWH Bright White Feet & Post MBK Matte Black Feet & Post PEW Pewter Feet & Post ASLASL Arctic Silver Feet & Post ASLBWH Arctic Silver Feet & Bright White Post ASLMBK Arctic Silver Feet & Matte Black Post ASLPEW Arctic Silver Feet & Pewter Post



Description

Squircle Table with Square Disc Base

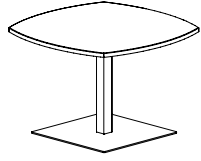

Laminate Tables  
"NST" Models

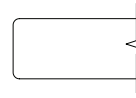

Eased Edge (R3)

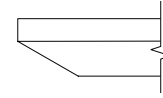

Reverse Bevel Edge (K9)

LAMINATE	D	W	H	CTN WT	CU FT	① Model	Eased Edge (R3)			Reverse Bevel Edge (K9)		
							Standard	Graded In		Standard	Graded In	
							Tier 1	Tier 2	Tier 3	Tier 1	Tier 2	Tier 3
	42	42	29	108	17	NST42-29SCS	\$1,540	\$1,725	\$1,832	\$1,910	\$2,096	\$2,202
	36	36	29	96	14	NST36-29SCS	\$1,276	\$1,313	\$1,367	\$1,647	\$1,683	\$1,737
	30	30	29	68	12	NST30-29SCS	\$1,103	\$1,135	\$1,165	\$1,474	\$1,505	\$1,538

Features:

- price reflects complete table - top and base
- ships KD in multiple cartons
- cut out for power is not available on these tables
- base has anti-rock glides

HSON

To Order Specify

① Laminate Model #	② Edge Detail	③ Laminate Selection	③a PVC Edge Color	④ Metal Finish
Laminate (NST)	R3 Eased K9 Reverse Bevel	<b>Standard Laminates (T1)</b> Solid Patterns: ALB Alabaster      DWH Designer White BLK Black          SHD Shadow BBL Bridal Blanco    SLG Slate Grey  Wood Grain Patterns: AGA Aged Ash      GRH Graphite ALL Ale Light      HGL High Line BLO Blonde Echo    OAT Oatmeal Cookie BOL Bourbon Light    PIN Pinnacle Walnut BZW Brazilwood      STU Studio Teak BGL Brighton Light    VIN Vintage CLL Collectors        WLH Walnut Heights FLO Florence Walnut    WEA Weathered Ash	Color: Standard (T1) laminates have a matching PVC. AGA Aged Ash ALB Alabaster ALL Ale Light BLK Black BLO Blonde Echo BOL Bourbon Light BZW Brazilwood BBL Bridal Blanco BGL Brighton Light CLL Collectors DWH Designer White FLO Florence Walnut GRH Graphite HGL High Line OAT Oatmeal Cookie PIN Pinnacle Walnut SHD Shadow SLG Slate Grey STU Studio Teak VIN Vintage WLH Walnut Heights WEA Weathered Ash	BWH Bright White Feet & Post MBK Matte Black Feet & Post PEW Pewter Feet & Post ASLASL Arctic Silver Feet & Post ASLBWH Arctic Silver Feet & Bright White Post ASLMBK Arctic Silver Feet & Matte Black Post ASLPEW Arctic Silver Feet & Pewter Post
		Graded-In Laminates (T2) & (T3) see pages 156-161	PVC color must be selected with Graded-In Laminates (T2) & (T3)	

Model Number Breakdown

NST30-29SCS					
NS	T	30	29	SC	S
Nosh	Laminate	30"	Height	Squircle Top Shape	Square Disc Base

Description

Squirrel Table with Square Disc Base  
(continued)

Veneer Tables  
"NSV" Models

Solid Surface Tables  
"NSS" Models

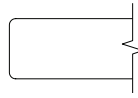

Eased Edge (R3)

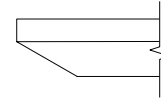

Reverse Bevel Edge (K9)

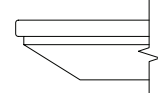

Reverse Bevel Edge (S7)

	D	W	H	CTN WT	CU FT	① Model	Eased Edge (R3)		Reverse Bevel Edge (K9)		Reverse Bevel Edge (S7) Standard
							Flat Cut	Double Cut	Flat Cut	Double Cut	
VENEER	42	42	29	108	17	NSV42-29SCS	\$2,057	\$2,199	\$2,139	\$2,288	--
	36	36	29	96	14	NSV36-29SCS	\$1,704	\$1,824	\$1,775	\$1,898	--
	30	30	29	68	12	NSV30-29SCS	\$1,473	\$1,575	\$1,533	\$1,640	--
SOL SURF	42	42	29	153	17	NSS42-29SCS	--	--	--	--	\$3,989
	36	36	29	145	14	NSS36-29SCS	--	--	--	--	\$3,233
	30	30	29	139	12	NSS30-29SCS	--	--	--	--	\$2,655

To Order Specify

Veneer Model #	② Edge Detail	③ Wood Species	④ Wood Finish	⑤ Metal Finish		
Veneer (NSV)	R3 Eased K9 Reverse Bevel	<b>Flat Cut</b> CH1 Cherry MA1 Maple WA1 Walnut	Cherry: BRL Barley BBM Bourbon Medium BRM Brighton Medium CLA Classic CLL Collectors* EAR Earthy HRV Harvest* LGC Legacy PRL Praline* SAF Saffron	Maple: ALM Ale Medium BUT Butterscotch CIN Cinnamon FLX Flax VEN Venetian	Walnut: AUB Auburn ESP Espresso MCH Mocha* NTO Night Owl* SIE Sienna* TOF Toffee TRF Truffle*	BWH Bright White Feet & Post MBK Matte Black Feet & Post PEW Pewter Feet & Post ASLASL Arctic Silver Feet & Post ASLBWH Arctic Silver Feet & Bright White Post ASLMBK Arctic Silver Feet & Matte Black Post ASLPEW Arctic Silver Feet & Pewter Post
		<b>Double Cut</b> DC2 Double Cut	<b>④ Wood Finish</b> Double Cut: COF Coffee FOS Fossil KHK Khaki CRM Cremello GRH Graphite STU Studio Teak	*finishes with coordinating laminate tops		

① Solid Surface Model #	② Edge Detail	③ Solid Surface	④ Metal Finish
Solid Surface (NSS)	S7 Reverse Bevel	<b>Tier 1</b> ARM Armadillo BLP Black Pearl GRA Graphite Granite PEB Pebble Pearl PUR Pure White	BWH Bright White Feet & Post MBK Matte Black Feet & Post PEW Pewter Feet & Post ASLASL Arctic Silver Feet & Post ASLBWH Arctic Silver Feet & Bright White Post ASLMBK Arctic Silver Feet & Matte Black Post ASLPEW Arctic Silver Feet & Pewter Post

Description

Rectangular Counter Height Table with T Base

Laminate Tables  
"NST" Models

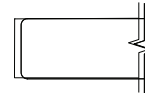
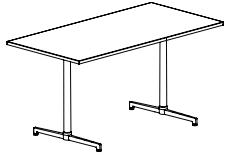

Eased Edge (R3)

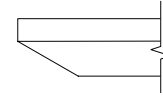

Reverse Bevel Edge (K9)

LAMINATE	D	W	H	CTN WT	CU FT	① Model	Standard			Graded In		
							Tier 1	Tier 2	Tier 3	Tier 1	Tier 2	Tier 3
	36	72	36	133	55	NST3672-36TTT	\$1,585	\$1,640	\$1,762	\$1,954	\$2,009	\$2,132
	36	66	36	124	54	NST3666-36TTT	\$1,532	\$1,585	\$1,696	\$1,902	\$1,954	\$2,065
	36	60	36	116	42	NST3660-36TTT	\$1,469	\$1,519	\$1,617	\$1,839	\$1,888	\$1,987
	30	72	36	117	55	NST3072-36TTT	\$1,363	\$1,413	\$1,511	\$1,733	\$1,782	\$1,881
	30	66	36	110	35	NST3066-36TTT	\$1,311	\$1,357	\$1,447	\$1,680	\$1,726	\$1,816
	30	60	36	103	36	NST3060-36TTT	\$1,248	\$1,291	\$1,372	\$1,617	\$1,660	\$1,741

Features:

- price reflects complete table - top and base
- ships KD in multiple cartons
- top has option for cut out to receive electrical component, order separately
- optional vertical wire manager for base, order separately
- base has leveling glides
- optional vertical wire manager for base, order separately
- width of base foot is 27"

HSON

To Order Specify

① Laminate Model #	② Edge Detail	③ Laminate Selection	③a PVC Edge Color	④ Electrical Cut Out	⑤ Metal Finish
Laminate (NST)	R3 Eased	<b>Standard Laminates (T1)</b> Solid Patterns: ALB Alabaster      DWH Designer White BLK Black          SHD Shadow BBL Bridal Blanco    SLG Slate Grey  Wood Grain Patterns: AGA Aged Ash      GRH Graphite ALL Ale Light      HGL High Line BLO Blonde Echo    OAT Oatmeal Cookie BOL Bourbon Light    PIN Pinnacle Walnut BZW Brazilwood      STU Studio Teak BGL Brighton Light    VIN Vintage CLL Collectors        WLH Walnut Heights FLO Florence Walnut    WEA Weathered Ash	Color: <b>Standard (T1) laminates</b> have a matching PVC. AGA Aged Ash ALB Alabaster ALL Ale Light BLK Black BLO Blonde Echo BOL Bourbon Light BZW Brazilwood BBL Bridal Blanco BGL Brighton Light CLL Collectors DWH Designer White FLO Florence Walnut GRH Graphite HGL High Line OAT Oatmeal Cookie PIN Pinnacle Walnut SHD Shadow SLG Slate Grey STU Studio Teak VIN Vintage WLH Walnut Heights WEA Weathered Ash	N None CO_EC23 Cut out for EC23 CO_EC24 Cut out for EC24	BWH Bright White Feet & Post MBK Matte Black Feet & Post PEW Pewter Feet & Post ASLASL Arctic Silver Feet & Post ASLBWH Arctic Silver Feet & Bright White Post ASLMBK Arctic Silver Feet & Matte Black Post ASLPEW Arctic Silver Feet & Pewter Post PAMASL Polished Aluminum Feet & Arctic Silver Post PAMBWH Polished Aluminum Feet & Bright White Post PAMMBK Polished Aluminum Feet & Matte Black Post PAMPEW Polished Aluminum Feet & Pewter Post
	K9 Reverse Bevel				

Model Number Breakdown

NST3060-36TTT					
NS	T	3060	36	TT	T
Nosh	Laminate	30" x 60"	Height	Rectangular Top Shape	T Base

Description

Rectangular Counter Height Table with T Base  
(continued)

Veneer Tables  
"NSV" Models

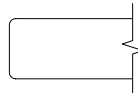

Eased Edge (R3)

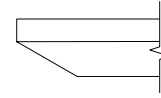

Reverse Bevel Edge (K9)

D	W	H	CTN WT	CU FT	1 Model	Eased Edge (R3)		Reverse Bevel Edge (K9)	
						Flat Cut	Double Cut	Flat Cut	Double Cut
36	72	36	133	55	NSV3672-36TTT	\$1,831	\$1,994	\$1,973	\$2,133
36	66	36	124	54	NSV3666-36TTT	\$1,794	\$1,948	\$1,932	\$2,082
36	60	36	116	42	NSV3660-36TTT	\$1,745	\$1,887	\$1,877	\$2,016
30	72	36	117	55	NSV3072-36TTT	\$1,729	\$1,871	\$1,862	\$1,999
30	66	36	110	35	NSV3066-36TTT	\$1,681	\$1,814	\$1,808	\$1,935
30	60	36	103	36	NSV3060-36TTT	\$1,640	\$1,785	\$1,761	\$1,879

VENEER

NOSH

To Order Specify

1 Veneer Model #	2 Edge Detail	3 Wood Species	4 Wood Finish			5 Electrical Cut Out	6 Metal Finish
Veneer (NSV)	R3 Eased	Flat Cut CH1 Cherry MA1 Maple WA1 Walnut	Cherry:	Maple:	Walnut:	N None CO_EC23 Cut out for EC23 CO_EC24 Cut out for EC24	BWH Bright White Feet & Post MBK Matte Black Feet & Post PEW Pewter Feet & Post ASLASL Arctic Silver Feet & Post ASLBWH Arctic Silver Feet & Bright White Post ASLMBK Arctic Silver Feet & Matte Black Post ASLPEW Arctic Silver Feet & Pewter Post PAMASL Polished Aluminum Feet & Arctic Silver Post PAMBWH Polished Aluminum Feet & Bright White Post PAMMBK Polished Aluminum Feet & Matte Black Post PAMPEW Polished Aluminum Feet & Pewter Post
	K9 Reverse Bevel		BRL Barley BBM Bourbon Medium BRM Brighton Medium CLA Classic CLL Collectors* EAR Earthy HRV Harvest* LGC Legacy PRL Praline* SAF Saffron	ALM Ale Medium BUT Butterscotch CIN Cinnamon FLX Flax VEN Venetian	AUB Auburn ESP Espresso MCH Mocha* NTO Night Owl* SIE Sienna* TOF Toffee TRF Truffle*		
		Double Cut DC2 Double Cut	4 Wood Finish				
			Double Cut:				
			COF Coffee	FOS Fossil	KHK Khaki		
			CRM Cremello	GRH Graphite	STU Studio Teak		

Description

Rounded Rectangular Counter Height Table with T Base

Laminate Tables "NST" Models

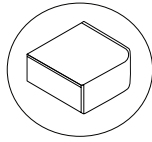
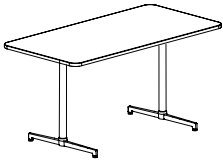

Eased Edge (R3)

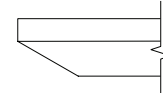

Reverse Bevel (K9)

LAMINATE	D	W	H	CTN WT	CU FT	① Model	Eased Edge (R3)			Reverse Bevel (K9)		
							Standard	Graded In		Standard	Graded In	
							Tier 1	Tier 2	Tier 3	Tier 1	Tier 2	Tier 3
	36	72	36	132	55	NST3672-36TTRT	\$1,664	\$1,722	\$1,843	\$2,036	\$2,092	\$2,213
	36	66	36	124	54	NST3666-36TTRT	\$1,617	\$1,672	\$1,780	\$1,987	\$2,041	\$2,150
	36	60	36	116	42	NST3660-36TTRT	\$1,561	\$1,610	\$1,707	\$1,930	\$1,980	\$2,079
	30	72	36	117	55	NST3072-36TTRT	\$1,523	\$1,572	\$1,672	\$1,893	\$1,943	\$2,041
	30	66	36	109	35	NST3066-36TTRT	\$1,468	\$1,515	\$1,605	\$1,837	\$1,885	\$1,974
	30	60	36	104	36	NST3060-36TTRT	\$1,421	\$1,465	\$1,545	\$1,790	\$1,834	\$1,914

Features:

- price reflects complete table - top and base
- ships KD in multiple cartons
- top has option for cut out to receive electrical component, order separately
- optional vertical wire manager for base, order separately
- base has leveling glides
- optional vertical wire manager for base, order separately
- width of base foot is 27"

HSON

To Order Specify

① Laminate Model #	② Edge Detail	③ Laminate Selection	③a PVC Edge Color	④ Electrical Cut Out	⑤ Metal Finish
Laminate (NST)	R3 Eased	<b>Standard Laminates (T1)</b> Solid Patterns: ALB Alabaster      DWH Designer White BLK Black          SHD Shadow BBL Bridal Blanco    SLG Slate Grey  Wood Grain Patterns: AGA Aged Ash      GRH Graphite ALL Ale Light        HGL High Line BLO Blonde Echo    OAT Oatmeal Cookie BOL Bourbon Light    PIN Pinnacle Walnut BZW Brazilwood     STU Studio Teak BGL Brighton Light    VIN Vintage CLL Collectors        WLH Walnut Heights FLO Florence Walnut    WEA Weathered Ash	Color: Standard (T1) laminates have a matching PVC. AGA Aged Ash ALB Alabaster ALL Ale Light BLK Black BLO Blonde Echo BOL Bourbon Light BZW Brazilwood BBL Bridal Blanco BGL Brighton Light CLL Collectors DWH Designer White FLO Florence Walnut GRH Graphite HGL High Line OAT Oatmeal Cookie PIN Pinnacle Walnut SHD Shadow SLG Slate Grey STU Studio Teak VIN Vintage WLH Walnut Heights WEA Weathered Ash	N None CO_EC23 Cut out for EC23 CO_EC24 Cut out for EC24	BWH Bright White Feet & Post MBK Matte Black Feet & Post PEW Pewter Feet & Post ASLASL Arctic Silver Feet & Post ASLBWH Arctic Silver Feet & Bright White Post ASLMBK Arctic Silver Feet & Matte Black Post ASLPEW Arctic Silver Feet & Pewter Post PAMASL Polished Aluminum Feet & Arctic Silver Post PAMBWH Polished Aluminum Feet & Bright White Post PAMMBK Polished Aluminum Feet & Matte Black Post PAMPEW Polished Aluminum Feet & Pewter Post
	K9 Reverse Bevel				

Model Number Breakdown

NST3060-36TTRT						
NS	T	3060	36	TT	R	T
Nosh	Laminate	30" x 60"	Height	Rectangular Top Shape	Rounded Corner	T Base

Description

Rounded Rectangular Counter Height Table with T Base (continued)

Veneer Tables "NSV" Models Solid Surface Tables "NSS" Models

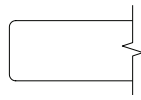

Eased Edge (R3)

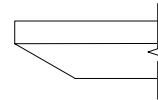

Reverse Bevel Edge (K9)

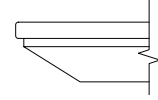

Reverse Bevel Edge (S7)

	D	W	H	CTN WT	CU FT	① Model	Eased Edge (R3)		Reverse Bevel Edge (K9)		Standard
							Flat Cut	Double Cut	Flat Cut	Double Cut	
VENEER	36	72	36	132	55	NSV3672-36TTRT	\$1,960	\$2,131	\$2,030	\$2,192	--
	36	66	36	124	54	NSV3666-36TTRT	\$1,921	\$2,082	\$1,989	\$2,138	--
	36	60	36	116	42	NSV3660-36TTRT	\$1,868	\$2,016	\$1,931	\$2,069	--
	30	72	36	117	55	NSV3072-36TTRT	\$1,844	\$1,994	\$1,908	\$2,046	--
	30	66	36	109	35	NSV3066-36TTRT	\$1,792	\$1,932	\$1,845	\$1,974	--
	30	60	36	104	36	NSV3060-36TTRT	\$1,748	\$1,876	\$1,805	\$1,924	--
SOLID SURFACE	36	72	36	132	55	NSS3672-36TTRT	--	--	--	--	\$4,595
	36	66	36	293	54	NSS3666-36TTRT	--	--	--	--	\$4,369
	36	60	36	275	42	NSS3660-36TTRT	--	--	--	--	\$4,127
	30	72	36	282	55	NSS3072-36TTRT	--	--	--	--	\$4,106
	30	66	36	272	35	NSS3066-36TTRT	--	--	--	--	\$3,898
	30	60	36	255	36	NSS3060-36TTRT	--	--	--	--	\$3,696

To Order Specify

① Veneer Model #	② Edge Detail	③ Wood Species	④ Wood Finish	⑤ Electrical Cut Out	⑥ Metal Finish		
Veneer (NSV)	R3 Eased K9 Reverse Bevel	Flat Cut CH1 Cherry MA1 Maple WA1 Walnut	Cherry: BRL Barley BBM Bourbon Medium BRM Brighton Medium CLA Classic CLL Collectors* EAR Earthy HRV Harvest* LGC Legacy PRL Praline* SAF Saffron	Maple: ALM Ale Medium BUT Butterscotch CIN Cinnamon FLX Flax VEN Venetian	Walnut: AUB Auburn ESP Espresso MCH Mocha* NTO Night Owl* SIE Sienna* TOF Toffee* TRF Truffle*	N None CO_EC23 Cut out for EC23 CO_EC24 Cut out for EC24	BWH Bright White Feet & Post MBK Matte Black Feet & Post PEW Pewter Feet & Post ASLASL Arctic Silver Feet & Post ASLBWH Arctic Silver Feet & Bright White Post ASLMBK Arctic Silver Feet & Matte Black Post ASLPEW Arctic Silver Feet & Pewter Post PAMASL Polished Aluminum Feet & Arctic Silver Post PAMBWH Polished Aluminum Feet & Bright White Post PAMMBK Polished Aluminum Feet & Matte Black Post PAMPEW Polished Aluminum Feet & Pewter Post
		Double Cut DC2 Double Cut	④ Wood Finish Double Cut: COF Coffee FOS Fossil KHK Khaki CRM Cremello GRH Graphite STU Studio Teak				

① Solid Surface Model #	② Edge Detail	③ Solid Surface	④ Electrical Cut Out	⑤ Metal Finish
Solid Surface (NSS)	S7 Reverse Bevel	Tier 1 ARM Armadillo BLP Black Pearl GRA Graphite Granite PEB Pebble Pearl PUR Pure White	N None CO_EC23 Cut out for EC23 CO_EC24 Cut out for EC24	BWH Bright White Feet & Post MBK Matte Black Feet & Post PEW Pewter Feet & Post ASLASL Arctic Silver Feet & Post ASLBWH Arctic Silver Feet & Bright White Post ASLMBK Arctic Silver Feet & Matte Black Post ASLPEW Arctic Silver Feet & Pewter Post PAMASL Polished Aluminum Feet & Arctic Silver Post PAMBWH Polished Aluminum Feet & Bright White Post PAMMBK Polished Aluminum Feet & Matte Black Post PAMPEW Polished Aluminum Feet & Pewter Post

Description

Rectangular Counter Height Table with X Base

Laminate Tables  
"NST" Models

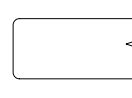
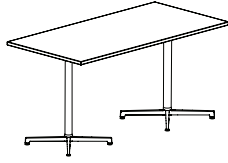

Eased Edge (R3)

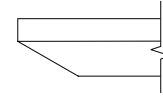

Reverse Bevel Edge (K9)

LAMINATE	D	W	H	CTN WT	CU FT	① Model	Eased Edge (R3)			Reverse Bevel Edge (K9)		
							Standard	Graded In		Standard	Graded In	
							Tier 1	Tier 2	Tier 3	Tier 1	Tier 2	Tier 3
	36	72	36	144	45	NST3672-36TTX	\$2,039	\$2,094	\$2,216	\$2,408	\$2,463	\$2,585
	30	72	36	127	33	NST3072-36TTX	\$1,845	\$1,895	\$1,994	\$2,215	\$2,265	\$2,364

Features:

- price reflects complete table - top and base
- ships KD in multiple cartons
- base has leveling glides
- top has option for cut out to receive electrical component, enter separately
- optional vertical wire manager for base, order separately
- width of base foot varies from 26" or 32"

HSON

To Order Specify

① Laminate Model #	② Edge Detail	③ Laminate Selection	③a PVC Edge Color	④ Electrical Cut Out	⑤ Metal Finish
Laminate (NST)	R3 Eased K9 Reverse Bevel	<b>Standard Laminates (T1)</b> Solid Patterns: ALB Alabaster      DWH Designer White BLK Black          SHD Shadow BBL Bridal Blanco    SLG Slate Grey  Wood Grain Patterns: AGA Aged Ash      GRH Graphite ALL Ale Light      HGL High Line BLO Blonde Echo    OAT Oatmeal Cookie BOL Bourbon Light    PIN Pinnacle Walnut BZW Brazilwood      STU Studio Teak BGL Brighton Light    VIN Vintage CLL Collectors        WLH Walnut Heights FLO Florence Walnut    WEA Weathered Ash	Color: <b>Standard (T1) laminates have a matching PVC.</b> AGA Aged Ash ALB Alabaster ALL Ale Light BLK Black BLO Blonde Echo BOL Bourbon Light BZW Brazilwood BBL Bridal Blanco BGL Brighton Light CLL Collectors DWH Designer White FLO Florence Walnut GRH Graphite HGL High Line OAT Oatmeal Cookie PIN Pinnacle Walnut SHD Shadow SLG Slate Grey STU Studio Teak VIN Vintage WLH Walnut Heights WEA Weathered Ash	N None CO_EC23 Cut out for EC23 CO_EC24 Cut out for EC24	BWH Bright White Feet & Post MBK Matte Black Feet & Post PEW Pewter Feet & Post ASLASL Arctic Silver Feet & Post ASLBWH Arctic Silver Feet & Bright White Post ASLMBK Arctic Silver Feet & Matte Black Post ASLPEW Arctic Silver Feet & Pewter Post PAMASL Polished Aluminum Feet & Arctic Silver Post PAMBWH Polished Aluminum Feet & Bright White Post PAMMBK Polished Aluminum Feet & Matte Black Post PAMPEW Polished Aluminum Feet & Pewter Post
			<b>Graded-In Laminates (T2) &amp; (T3)</b> see pages 156-161	PVC color must be selected with Graded-In Laminates (T2) & (T3)	

Model Number Breakdown

NST3672-36TTX					
NS	T	3672	36	TT	X
Nosh	Laminate	36" x 72"	Height	Rectangular Top Shape	X Base

Description

Rectangular Counter Height Table with X Base  
(continued)

Veneer Tables  
"NSV" Models

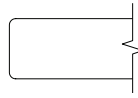

Eased Edge (R3)

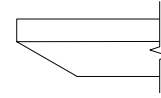

Reverse Bevel Edge (K9)

VENEER	D	W	H	CTN WT	CU FT	1 Model	Eased Edge (R3)		Reverse Bevel Edge (K9)	
							Flat Cut	Double Cut	Flat Cut	Double Cut
	36	72	36	144	45	NSV3672-36TTX	\$2,285	\$2,448	\$2,427	\$2,586
	30	72	36	127	33	NSV3072-36TTX	\$2,212	\$2,353	\$2,344	\$2,481

HSON

To Order Specify

1 Veneer Model #	2 Edge Detail	3 Wood Species	4 Wood Finish			5 Electrical Cut Out	6 Metal Finish
Veneer (NSV)	R3 Eased	Flat Cut CH1 Cherry MA1 Maple WA1 Walnut	Cherry:	Maple:	Walnut:	N None CO_EC23 Cut out for EC23 CO_EC24 Cut out for EC24	BWH Bright White Feet & Post MBK Matte Black Feet & Post PEW Pewter Feet & Post ASLACL Arctic Silver Feet & Post ASLBWH Arctic Silver Feet & Bright White Post ASLMBK Arctic Silver Feet & Matte Black Post ASLPEW Arctic Silver Feet & Pewter Post PAMASL Polished Aluminum Feet & Arctic Silver Post PAMBWH Polished Aluminum Feet & Bright White Post PAMMBK Polished Aluminum Feet & Matte Black Post PAMPEW Polished Aluminum Feet & Pewter Post
	K9 Reverse Bevel		BRB Barley BBM Bourbon Medium BRM Brighton Medium CLA Classic CLL Collectors* EAR Earthy HRV Harvest* LGC Legacy PRL Praline* SAF Saffron	ALM Ale Medium BUT Butterscotch CIN Cinnamon FLX Flax VEN Venetian	AUB Auburn ESP Espresso MCH Mocha* NTO Night Owl* SIE Sienna* TOF Toffee TRF Truffle*		
		Double Cut DC2 Double Cut	4 Wood Finish				
			Double Cut:	COF Coffee	FOS Fossil	KHK Khaki	
			CRM Cremello	GRH Graphite	STU Studio Teak		



Description

Rounded Rectangular Counter Height Table with X Base

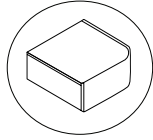
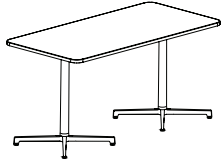

Laminate Tables "NST" Models

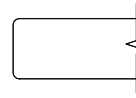

Eased Edge (R3)

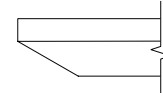

Reverse Bevel (K9)

LAMINATE	D	W	H	CTN WT	CU FT	① Model	Eased Edge (R3)			Reverse Bevel (K9)		
							Standard	Graded In		Standard	Graded In	
							Tier 1	Tier 2	Tier 3	Tier 1	Tier 2	Tier 3
	36	72	36	143	45	NST3672-36TTRX	\$2,119	\$2,176	\$2,296	\$2,489	\$2,545	\$2,666
	30	72	36	129	33	NST3072-36TTRX	\$2,005	\$2,056	\$2,153	\$2,374	\$2,425	\$2,523

Features:

- price reflects complete table - top and base
- ships KD in multiple cartons
- base has leveling glides
- top has option for cut out to receive electrical component, enter separately
- optional vertical wire manager for base, order separately
- width of base foot varies from 26" or 32"

HSON

To Order Specify

① Laminate Model #	② Edge Detail	③ Laminate Selection	③a PVC Edge Color	④ Electrical Cut Out	⑤ Metal Finish
Laminate (NST)	R3 Eased K9 Reverse Bevel	<b>Standard Laminates (T1)</b> Solid Patterns: ALB Alabaster      DWH Designer White BLK Black            SHD Shadow BBL Bridal Blanco    SLG Slate Grey  Wood Grain Patterns: AGA Aged Ash        GRH Graphite ALL Ale Light         HGL High Line BLO Blonde Echo     OAT Oatmeal Cookie BOL Bourbon Light    PIN Pinnacle Walnut BZW Brazilwood      STU Studio Teak BGL Brighton Light    VIN Vintage CLL Collectors        WLH Walnut Heights FLO Florence Walnut    WEA Weathered Ash	Color: Standard (T1) laminates have a matching PVC. AGA Aged Ash ALB Alabaster ALL Ale Light BLK Black BLO Blonde Echo BOL Bourbon Light BZW Brazilwood BBL Bridal Blanco BGL Brighton Light CLL Collectors DWH Designer White FLO Florence Walnut GRH Graphite HGL High Line OAT Oatmeal Cookie PIN Pinnacle Walnut SHD Shadow SLG Slate Grey STU Studio Teak VIN Vintage WLH Walnut Heights WEA Weathered Ash	N None CO_EC23 Cut out for EC23 CO_EC24 Cut out for EC24	BWH Bright White Feet & Post MBK Matte Black Feet & Post PEW Pewter Feet & Post ASLASL Arctic Silver Feet & Post ASLBWH Arctic Silver Feet & Bright White Post ASLMBK Arctic Silver Feet & Matte Black Post ASLPEW Arctic Silver Feet & Pewter Post PAMASL Polished Aluminum Feet & Arctic Silver Post PAMBWH Polished Aluminum Feet & Bright White Post PAMMBK Polished Aluminum Feet & Matte Black Post PAMPEW Polished Aluminum Feet & Pewter Post
		Graded-In Laminates (T2) & (T3) see pages 156-161	PVC color must be selected with Graded-In Laminates (T2) & (T3)		

Model Number Breakdown

NST3072-36TTRX						
NS	T	3072	36	TT	R	X
Nosh	Laminate	30" x 72"	Height	Rectangular Top Shape	Rounded Corner	X Base

Description

Rounded Rectangular Counter Height Table with X Base (continued)

Veneer Tables "NSV" Models Solid Surface Tables "NSS" Models

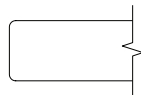

Eased Edge (R3)

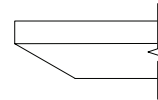

Reverse Bevel Edge (K9)

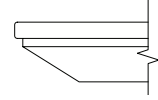

Reverse Bevel Edge (S7)

	D	W	H	CTN WT	CU FT	1 Model	Eased Edge (R3)		Reverse Bevel Edge (K9)		Standard
							Flat Cut	Double Cut	Flat Cut	Double Cut	
VENEER	36	72	36	143	45	NSV3672-36TTRX	\$2,442	\$2,613	\$2,512	\$2,674	--
	30	72	36	129	33	NSV3072-36TTRX	\$2,298	\$2,448	\$2,362	\$2,500	--
SOL SURF	36	72	36	177	45	NSS3672-36TTRX	--	--	--	--	\$5,076
	30	72	36	152	33	NSS3072-36TTRX	--	--	--	--	\$4,559

NOSH

To Order Specify

1 Veneer Model #	2 Edge Detail	3 Wood Species	4 Wood Finish	5 Electrical Cut Out	6 Metal Finish		
Veneer (NSV)	R3 Eased K9 Reverse Bevel	<b>Flat Cut</b> CH1 Cherry MA1 Maple WA1 Walnut	Cherry: BRL Barley BBM Bourbon Medium BRM Brighton Medium CLA Classic CLL Collectors* EAR Earthy HRV Harvest* LGC Legacy PRL Praline* SAF Saffron	Maple: ALM Ale Medium BUT Butterscotch CIN Cinnamon FLX Flax VEN Venetian	Walnut: AUB Auburn ESP Espresso MCH Mocha* NTO Night Owl* SIE Sienna* TOF Toffee* TRF Truffle*	N None CO_EC23 Cut out for EC23 CO_EC24 Cut out for EC24	BWH Bright White Feet & Post MBK Matte Black Feet & Post PEW Pewter Feet & Post ASLASL Arctic Silver Feet & Post ASLBWH Arctic Silver Feet & Bright White Post ASLMBK Arctic Silver Feet & Matte Black Post ASLPEW Arctic Silver Feet & Pewter Post PAMASL Polished Aluminum Feet & Arctic Silver Post PAMBWH Polished Aluminum Feet & Bright White Post PAMMBK Polished Aluminum Feet & Matte Black Post PAMPEW Polished Aluminum Feet & Pewter Post
			<b>Double Cut</b> DC2 Double Cut	<b>4 Wood Finish</b> Double Cut: COF Coffee FOS Fossil KHK Khaki CRM Cremello GRH Graphite STU Studio Teak			

1 Solid Surface Model #	2 Edge Detail	3 Solid Surface	4 Electrical Cut Out	5 Metal Finish
Solid Surface (NSS)	S7 Reverse Bevel	<b>Tier 1</b> ARM Armadillo BLP Black Pearl GRA Graphite Granite PEB Pebble Pearl PUR Pure White	N None CO_EC23 Cut out for EC23 CO_EC24 Cut out for EC24	BWH Bright White Feet & Post MBK Matte Black Feet & Post PEW Pewter Feet & Post ASLASL Arctic Silver Feet & Post ASLBWH Arctic Silver Feet & Bright White Post ASLMBK Arctic Silver Feet & Matte Black Post ASLPEW Arctic Silver Feet & Pewter Post PAMASL Polished Aluminum Feet & Arctic Silver Post PAMBWH Polished Aluminum Feet & Bright White Post PAMMBK Polished Aluminum Feet & Matte Black Post PAMPEW Polished Aluminum Feet & Pewter Post

Description

Rectangular Counter Height Table with Round Disc Base

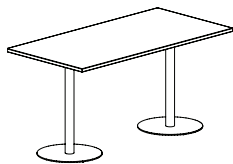

Laminate Tables "NST" Models

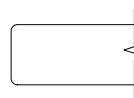

Eased Edge (R3)

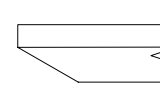

Reverse Bevel Edge (K9)

LAMINATE	D	W	H	CTN WT	CU FT	① Model	Eased Edge (R3)			Reverse Bevel Edge (K9)		
							Standard	Graded In		Standard	Graded In	
							Tier 1	Tier 2	Tier 3	Tier 1	Tier 2	Tier 3
	36	72	36	219	55	NST3672-36TTR	\$2,312	\$2,368	\$2,478	\$2,682	\$2,737	\$2,847
	36	66	36	210	54	NST3666-36TTR	\$2,182	\$2,246	\$2,347	\$2,553	\$2,616	\$2,716
	36	60	36	202	42	NST3660-36TTR	\$2,102	\$2,164	\$2,251	\$2,471	\$2,534	\$2,621
	30	72	36	169	55	NST3072-36TTR	\$2,104	\$2,165	\$2,253	\$2,473	\$2,535	\$2,622
	30	66	36	162	41	NST3066-36TTR	\$1,915	\$1,973	\$2,051	\$2,285	\$2,344	\$2,421
	30	60	36	155	36	NST3060-36TTR	\$1,853	\$1,908	\$1,977	\$2,222	\$2,277	\$2,347

Features:

- price reflects complete table - top and base
- ships KD in multiple cartons
- top has option for cutout to receive electrical component, ordered separately
- optional vertical wire manager for base, order separately
- base has anti-rock glides
- width of base foot varies from 17" or 22"

HSON

To Order Specify

① Laminate Model #	② Edge Detail	③ Laminate Selection	③a PVC Edge Color	④ Electrical Cut Out	⑤ Metal Finish
Laminate (NST)	R3 Eased	<b>Standard Laminates (T1)</b> Solid Patterns: ALB Alabaster      DWH Designer White BLK Black          SHD Shadow BBL Bridal Blanco    SLG Slate Grey  Wood Grain Patterns: AGA Aged Ash      GRH Graphite ALL Ale Light        HGL High Line BLO Blonde Echo    OAT Oatmeal Cookie BOL Bourbon Light    PIN Pinnacle Walnut BZW Brazilwood      STU Studio Teak BGL Brighton Light    VIN Vintage CLL Collectors        WLH Walnut Heights FLO Florence Walnut    WEA Weathered Ash	Color: <b>Standard (T1) laminates have a matching PVC.</b> AGA Aged Ash ALB Alabaster ALL Ale Light BLK Black BLO Blonde Echo BOL Bourbon Light BZW Brazilwood BBL Bridal Blanco BGL Brighton Light CLL Collectors DWH Designer White FLO Florence Walnut GRH Graphite HGL High Line OAT Oatmeal Cookie PIN Pinnacle Walnut SHD Shadow SLG Slate Grey STU Studio Teak VIN Vintage WLH Walnut Heights WEA Weathered Ash	N None CO_EC23 Cut out for EC23 CO_EC24 Cut out for EC24	BWH Bright White Feet & Post MBK Matte Black Feet & Post PEW Pewter Feet & Post ASLASL Arctic Silver Feet & Post ASLBWH Arctic Silver Feet & Bright White Post ASLMBK Arctic Silver Feet & Matte Black Post ASLPEW Arctic Silver Feet & Pewter Post
	K9 Reverse Bevel				

Model Number Breakdown

NST3672-36TTR					
NS	T	3672	36	TT	R
Nosh	Laminate	36" x 72"	Height	Rectangular Top Shape	Round Disc Base

Description

Rectangular Counter Height Table  
with Round Disc Base  
(continued)

Veneer Tables  
"NSV" Models

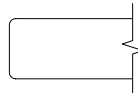

Eased Edge (R3)

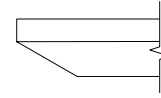

Reverse Bevel Edge (K9)

D	W	H	CTN WT	CU FT	1 Model	Eased Edge (R3)		Reverse Bevel Edge (K9)	
						Flat Cut	Double Cut	Flat Cut	Double Cut
36	72	36	219	55	NSV3672-36TTR	\$2,620	\$2,730	\$2,675	\$2,776
36	66	36	210	54	NSV3666-36TTR	\$2,537	\$2,637	\$2,600	\$2,690
36	60	36	202	42	NSV3660-36TTR	\$2,459	\$2,548	\$2,519	\$2,598
30	72	36	169	55	NSV3072-36TTR	\$2,433	\$2,593	\$2,490	\$2,640
30	66	36	162	41	NSV3066-36TTR	\$2,246	\$2,350	\$2,299	\$2,393
30	60	36	155	36	NSV3060-36TTR	\$2,186	\$2,280	\$2,236	\$2,321

VENEER

NOSH

To Order Specify

1 Veneer Model #	2 Edge Detail	3 Wood Species	4 Wood Finish			5 Electrical Cut Out	6 Metal Finish
Veneer (NSV)	R3 Eased	Flat Cut CH1 Cherry MA1 Maple WA1 Walnut	Cherry: BRL Barley BBM Bourbon Medium BRM Brighton Medium CLA Classic CLL Collectors* EAR Earthy HRV Harvest* LGC Legacy PRL Praline* SAF Saffron	Maple: ALM Ale Medium BUT Butterscotch CIN Cinnamon FLX Flax VEN Venetian	Walnut: AUB Auburn ESP Espresso MCH Mocha* NTO Night Owl* SIE Sienna* TOF Toffee TRF Truffle*	N None CO_EC23 Cut out for EC23 CO_EC24 Cut out for EC24	BWH Bright White Feet & Post MBK Matte Black Feet & Post PEW Pewter Feet & Post ASLASL Arctic Silver Feet & Post ASLBWH Arctic Silver Feet & Bright White Post ASLMBK Arctic Silver Feet & Matte Black Post ASLPEW Arctic Silver Feet & Pewter Post
	K9 Reverse Bevel						

Description

Rounded Rectangular Counter Height Table with Round Disc Base

Laminate Tables "NST" Models

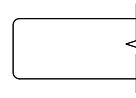
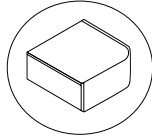
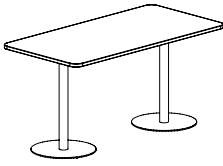

Eased Edge (R3)

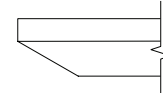

Reverse Bevel (K9)

LAMINATE	D	W	H	CTN WT	CU FT	1 Model	Standard			Graded In		
							Tier 1	Tier 2	Tier 3	Tier 1	Tier 2	Tier 3
	36	72	36	196	55	<b>NST3672-36TTRR</b>	\$2,516	\$2,588	\$2,694	\$2,886	\$2,958	\$3,064
36	66	36	188	54	<b>NST3666-36TTRR</b>	\$2,209	\$2,272	\$2,371	\$2,578	\$2,641	\$2,740	
36	60	36	180	42	<b>NST3660-36TTRR</b>	\$2,152	\$2,213	\$2,321	\$2,521	\$2,582	\$2,691	
30	72	36	157	55	<b>NST3072-36TTRR</b>	\$2,186	\$2,247	\$2,333	\$2,556	\$2,618	\$2,704	
30	66	36	150	41	<b>NST3066-36TTRR</b>	\$2,132	\$2,191	\$2,268	\$2,501	\$2,560	\$2,637	
30	60	36	143	36	<b>NST3060-36TTRR</b>	\$2,084	\$2,139	\$2,209	\$2,453	\$2,509	\$2,578	

Features:

- price reflects complete table - top and base
- ships KD in multiple cartons
- top has option for cutout to receive electrical component, ordered separately
- optional vertical wire manager for base, order separately
- base has anti-rock glides
- width of base foot varies from 17" or 22"

HSON

To Order Specify

1 Laminate Model #	2 Edge Detail	3 Laminate Selection	3a PVC Edge Color	4 Electrical Cut Out	5 Metal Finish
Laminate (NST)	R3 Eased K9 Reverse Bevel	<b>Standard Laminates (T1)</b> Solid Patterns: ALB Alabaster      DWH Designer White BLK Black          SHD Shadow BBL Bridal Blanco    SLG Slate Grey  Wood Grain Patterns: AGA Aged Ash      GRH Graphite ALL Ale Light      HGL High Line BLO Blonde Echo    OAT Oatmeal Cookie BOL Bourbon Light    PIN Pinnacle Walnut BZW Brazilwood      STU Studio Teak BGL Brighton Light    VIN Vintage CLL Collectors      WLH Walnut Heights FLO Florence Walnut    WEA Weathered Ash	Color: Standard (T1) laminates have a matching PVC. AGA Aged Ash ALB Alabaster ALL Ale Light BLK Black BLO Blonde Echo BOL Bourbon Light BZW Brazilwood BBL Bridal Blanco BGL Brighton Light CLL Collectors DWH Designer White FLO Florence Walnut GRH Graphite HGL High Line OAT Oatmeal Cookie PIN Pinnacle Walnut SHD Shadow SLG Slate Grey STU Studio Teak VIN Vintage WLH Walnut Heights WEA Weathered Ash	N None CO_EC23 Cut out for EC23 CO_EC24 Cut out for EC24	BWH Bright White Feet & Post MBK Matte Black Feet & Post PEW Pewter Feet & Post ASLASL Arctic Silver Feet & Post ASLBWH Arctic Silver Feet & Bright White Post ASLMBK Arctic Silver Feet & Matte Black Post ASLPEW Arctic Silver Feet & Pewter Post
			<b>Graded-In Laminates (T2) &amp; (T3)</b> see pages 156-161	PVC color must be selected with Graded-In Laminates (T2) & (T3)	

Model Number Breakdown

NST3060-36TTRR						
NS	T	3060	36	TT	R	R
Nosh	Laminate	30" x 60"	Height	Rectangular Top Shape	Rounded Corner	Round Disc Base

Description

Rounded Rectangular Counter Height Table with Round Disc Base (continued)

Veneer Tables "NSV" Models Solid Surface Tables "NSS" Models

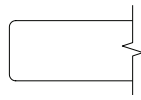

Eased Edge (R3)

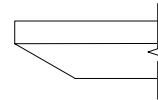

Reverse Bevel Edge (K9)

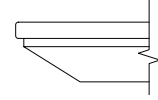

Reverse Bevel Edge (S7)

	D	W	H	CTN WT	CU FT	① Model	Eased Edge (R3)		Reverse Bevel Edge (K9)		Standard
							Flat Cut	Double Cut	Flat Cut	Double Cut	
VENEER	36	72	36	196	55	NSV3672-36TTRR	\$2,823	\$2,933	\$2,887	\$2,987	--
	36	66	36	188	54	NSV3666-36TTRR	\$2,555	\$2,654	\$2,614	\$2,706	--
	36	60	36	180	42	NSV3660-36TTRR	\$2,503	\$2,593	\$2,559	\$2,640	--
	30	72	36	157	55	NSV3072-36TTRR	\$2,506	\$2,620	\$2,570	\$2,671	--
	30	66	36	150	41	NSV3066-36TTRR	\$2,455	\$2,559	\$2,507	\$2,601	--
	30	60	36	143	36	NSV3060-36TTRR	\$2,411	\$2,504	\$2,467	\$2,550	--
SOLID SURFACE	36	72	36	229	55	NSS3672-36TTRR	--	--	--	--	\$5,458
	36	66	36	218	54	NSS3666-36TTRR	--	--	--	--	\$5,002
	36	60	36	207	42	NSS3660-36TTRR	--	--	--	--	\$4,763
	30	72	36	183	55	NSS3072-36TTRR	--	--	--	--	\$4,768
	30	66	36	174	41	NSS3066-36TTRR	--	--	--	--	\$4,560
	30	60	36	165	36	NSS3060-36TTRR	--	--	--	--	\$4,359

To Order Specify

① Veneer Model #	② Edge Detail	③ Wood Species	④ Wood Finish	⑤ Electrical Cut Out	⑥ Metal Finish		
Veneer (NSV)	R3 Eased K9 Reverse Bevel	Flat Cut CH1 Cherry MA1 Maple WA1 Walnut	Cherry: BRL Barley BBM Bourbon Medium BRM Brighton Medium CLA Classic CLL Collectors* EAR Earthy HRV Harvest* LGC Legacy PRL Praline* SAF Saffron	Maple: ALM Ale Medium BUT Butterscotch CIN Cinnamon FLX Flax VEN Venetian	Walnut: AUB Auburn ESP Espresso MCH Mocha* NTO Night Owl* SIE Sienna* TOF Toffee TRF Truffle*	N None CO_EC23 Cut out for EC23 CO_EC24 Cut out for EC24	BWH Bright White Feet & Post MBK Matte Black Feet & Post PEW Pewter Feet & Post ASLASL Arctic Silver Feet & Post ASLBWH Arctic Silver Feet & Bright White Post ASLMBK Arctic Silver Feet & Matte Black Post ASLPEW Arctic Silver Feet & Pewter Post
		Double Cut DC2 Double Cut	④ Wood Finish Double Cut: COF Coffee FOS Fossil KHK Khaki CRM Cremello GRH Graphite STU Studio Teak				

① Solid Surface Model #	② Edge Detail	③ Solid Surface	④ Electrical Cut Out	⑤ Metal Finish
Solid Surface (NSS)	S7 Reverse Bevel	Tier 1 ARM Armadillo BLP Black Pearl GRA Graphite Granite PEB Pebble Pearl PUR Pure White	N None CO_EC23 Cut out for EC23 CO_EC24 Cut out for EC24	BWH Bright White Feet & Post MBK Matte Black Feet & Post PEW Pewter Feet & Post ASLASL Arctic Silver Feet & Post ASLBWH Arctic Silver Feet & Bright White Post ASLMBK Arctic Silver Feet & Matte Black Post ASLPEW Arctic Silver Feet & Pewter Post

Description

Rectangular Counter Height Table with Square Disc Base

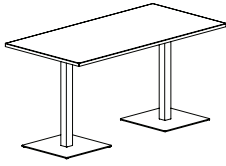

Laminate Tables "NST" Models

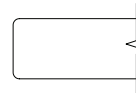

Eased Edge (R3)

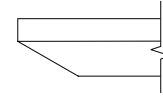

Reverse Bevel Edge (K9)

LAMINATE	D	W	H	CTN WT	CU FT	① Model	Eased Edge (R3)			Reverse Bevel Edge (K9)		
							Standard	Graded In		Standard	Graded In	
							Tier 1	Tier 2	Tier 3	Tier 1	Tier 2	Tier 3
	36	72	36	215	55	NST3672-36TTS	\$2,562	\$2,619	\$2,728	\$2,932	\$2,988	\$3,097
	36	66	36	207	54	NST3666-36TTS	\$2,433	\$2,497	\$2,597	\$2,803	\$2,866	\$2,966
	36	60	36	198	42	NST3660-36TTS	\$2,352	\$2,413	\$2,501	\$2,721	\$2,783	\$2,870
	30	72	36	169	55	NST3072-36TTS	\$2,354	\$2,414	\$2,502	\$2,723	\$2,784	\$2,871
	30	66	36	162	41	NST3066-36TTS	\$2,166	\$2,223	\$2,303	\$2,536	\$2,593	\$2,672
	30	60	36	155	36	NST3060-36TTS	\$2,103	\$2,157	\$2,227	\$2,472	\$2,527	\$2,597

Features:

- price reflects complete table - top and base
- ships KD in multiple cartons
- base has anti-rock glides
- top has option for cut out to receive electrical component, enter separately
- optional vertical wire manager for base, order separately
- width of base foot varies from 17" or 22"

HSON

To Order Specify

① Laminate Model #	② Edge Detail	③ Laminate Selection	③a PVC Edge Color	④ Electrical Cut Out	⑤ Metal Finish
Laminate (NST)	R3 Eased	<b>Standard Laminates (T1)</b> Solid Patterns: ALB Alabaster      DWH Designer White BLK Black          SHD Shadow BBL Bridal Blanco    SLG Slate Grey  Wood Grain Patterns: AGA Aged Ash      GRH Graphite ALL Ale Light      HGL High Line BLO Blonde Echo    OAT Oatmeal Cookie BOL Bourbon Light    PIN Pinnacle Walnut BZW Brazilwood      STU Studio Teak BGL Brighton Light    VIN Vintage CLL Collectors        WLH Walnut Heights FLO Florence Walnut    WEA Weathered Ash	Color: <b>Standard (T1) laminates have a matching PVC.</b> AGA Aged Ash ALB Alabaster ALL Ale Light BLK Black BLO Blonde Echo BOL Bourbon Light BZW Brazilwood BBL Bridal Blanco BGL Brighton Light CLL Collectors DWH Designer White FLO Florence Walnut GRH Graphite HGL High Line OAT Oatmeal Cookie PIN Pinnacle Walnut SHD Shadow SLG Slate Grey STU Studio Teak VIN Vintage WLH Walnut Heights WEA Weathered Ash	N None CO_EC23 Cut out for EC23 CO_EC24 Cut out for EC24	BWH Bright White Feet & Post MBK Matte Black Feet & Post PEW Pewter Feet & Post ASLASL Arctic Silver Feet & Post ASLBWH Arctic Silver Feet & Bright White Post ASLMBK Arctic Silver Feet & Matte Black Post ASLPEW Arctic Silver Feet & Pewter Post
	K9 Reverse Bevel				

Model Number Breakdown

NSV3672-36TTS					
NS	V	3672	36	TT	S
Nosh	Veneer	36" x 72"	Height	Rectangular Top Shape	Square Disc Base

Description

Rectangular Counter Height Table  
with Square Disc Base  
(continued)

Veneer Tables  
"NSV" Models

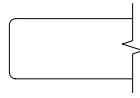

Eased Edge (R3)

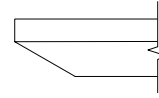

Reverse Bevel Edge (K9)

D	W	H	CTN WT	CU FT	1 Model	Flat Cut		Double Cut	
						Flat Cut	Double Cut	Flat Cut	Double Cut
36	72	36	215	55	NSV3672-36TTS	\$2,869	\$2,980	\$2,925	\$3,026
36	66	36	207	54	NSV3666-36TTS	\$2,786	\$2,888	\$2,850	\$2,940
36	60	36	198	42	NSV3660-36TTS	\$2,710	\$2,799	\$2,770	\$2,848
30	72	36	169	55	NSV3072-36TTS	\$2,683	\$2,844	\$2,739	\$2,890
30	66	36	162	41	NSV3066-36TTS	\$2,497	\$2,600	\$2,548	\$2,643
30	60	36	155	36	NSV3060-36TTS	\$2,436	\$2,531	\$2,486	\$2,572

VENEER

NOSH

To Order Specify

1 Veneer Model #	2 Edge Detail	3 Wood Species	4 Wood Finish	5 Electrical Cut Out	6 Metal Finish		
Veneer (NSV)	R3 Eased K9 Reverse Bevel	<b>Flat Cut</b> CH1 Cherry MA1 Maple WA1 Walnut	Cherry: BRL Barley BBM Bourbon Medium BRM Brighton Medium CLA Classic CLL Collectors* EAR Earthy HRV Harvest* LGC Legacy PRL Praline* SAF Saffron	Maple: ALM Ale Medium BUT Butterscotch CIN Cinnamon FLX Flax VEN Venetian	Walnut: AUB Auburn ESP Espresso MCH Mocha* NTO Night Owl* SIE Sienna* TOF Toffee TRF Truffle*	N None CO_EC23 Cut out for EC23 CO_EC24 Cut out for EC24	BWH Bright White Feet & Post MBK Matte Black Feet & Post PEW Pewter Feet & Post ASLASL Arctic Silver Feet & Post ASLBWH Arctic Silver Feet & Bright White Post ASLMBK Arctic Silver Feet & Matte Black Post ASLPEW Arctic Silver Feet & Pewter Post
	<b>Double Cut</b> DC2 Double Cut	<b>4 Wood Finish</b> Double Cut: COF Coffee FOS Fossil KHK Khaki CRM Cremello GRH Graphite STU Studio Teak					



Description

Rounded Rectangular Counter Height Table with Square Disc Base

Laminate Tables "NST" Models

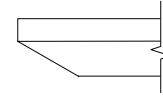
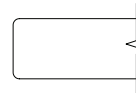
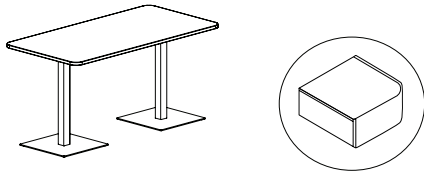

Eased Edge (R3)

Reverse Bevel (K9)

LAMINATE	D	W	H	CTN WT	CU FT	① Model	Standard			Graded In		
							Tier 1	Tier 2	Tier 3	Tier 1	Tier 2	Tier 3
							36	72	36	215	55	NST3672-36TTRS
36	66	36	207	54	NST3666-36TTRS	\$2,458	\$2,521	\$2,622	\$2,827	\$2,891	\$2,991	
36	60	36	198	42	NST3660-36TTRS	\$2,403	\$2,462	\$2,572	\$2,772	\$2,831	\$2,942	
30	72	36	169	55	NST3072-36TTRS	\$2,436	\$2,498	\$2,584	\$2,806	\$2,867	\$2,953	
30	66	36	162	41	NST3066-36TTRS	\$2,382	\$2,441	\$2,518	\$2,752	\$2,810	\$2,888	
30	60	36	155	36	NST3060-36TTRS	\$2,333	\$2,390	\$2,458	\$2,704	\$2,759	\$2,827	

Features:

- price reflects complete table - top and base
- ships KD in multiple cartons
- base has anti-rock glides
- top has option for cut out to receive electrical component, enter separately
- optional vertical wire manager for base, order separately
- width of base foot varies from 17" or 22"

HSON

To Order Specify

① Laminate Model #	② Edge Detail	③ Laminate Selection	③a PVC Edge Color	④ Electrical Cut Out	⑤ Metal Finish
Laminate (NST)	R3 Eased	<b>Standard Laminates (T1)</b> Solid Patterns: ALB Alabaster      DWH Designer White BLK Black          SHD Shadow BBL Bridal Blanco    SLG Slate Grey  Wood Grain Patterns: AGA Aged Ash      GRH Graphite ALL Ale Light      HGL High Line BLO Blonde Echo    OAT Oatmeal Cookie BOL Bourbon Light    PIN Pinnacle Walnut BZW Brazilwood      STU Studio Teak BGL Brighton Light    VIN Vintage CLL Collectors      WLH Walnut Heights FLO Florence Walnut    WEA Weathered Ash	Color: Standard (T1) laminates have a matching PVC. AGA Aged Ash ALB Alabaster ALL Ale Light BLK Black BLO Blonde Echo BOL Bourbon Light BZW Brazilwood BBL Bridal Blanco BGL Brighton Light CLL Collectors DWH Designer White FLO Florence Walnut GRH Graphite HGL High Line OAT Oatmeal Cookie PIN Pinnacle Walnut SHD Shadow SLG Slate Grey STU Studio Teak VIN Vintage WLH Walnut Heights WEA Weathered Ash	N None CO_EC23 Cut out for EC23 CO_EC24 Cut out for EC24	BWH Bright White Feet & Post MBK Matte Black Feet & Post PEW Pewter Feet & Post ASLASL Arctic Silver Feet & Post ASLBWH Arctic Silver Feet & Bright White Post ASLMBK Arctic Silver Feet & Matte Black Post ASLPEW Arctic Silver Feet & Pewter Post
	K9 Reverse Bevel				

Model Number Breakdown

NST3060-36TTRS						
NS	T	3060	36	TT	R	S
Nosh	Laminate	30" x 60"	Height	Rectangular Top Shape	Rounded Corner	Square Disc Base

Description

Rounded Rectangular Counter Height Table with Square Disc Base (continued)

Veneer Tables "NSV" Models Solid Surface Tables "NSS" Models

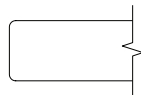

Eased Edge (R3)

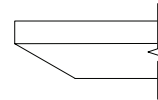

Reverse Bevel Edge (K9)

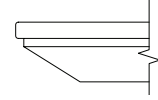

Reverse Bevel Edge (S7)

	D	W	H	CTN WT	CU FT	① Model	Eased Edge (R3)		Reverse Bevel Edge (K9)		Standard
							Flat Cut	Double Cut	Flat Cut	Double Cut	
VENEER	36	72	36	215	55	NSV3672-36TTRS	\$3,074	\$3,183	\$3,137	\$3,236	--
	36	66	36	207	54	NSV3666-36TTRS	\$2,805	\$2,905	\$2,864	\$2,954	--
	36	60	36	198	42	NSV3660-36TTRS	\$2,754	\$2,844	\$2,809	\$2,890	--
	30	72	36	169	55	NSV3072-36TTRS	\$2,757	\$2,869	\$2,821	\$2,921	--
	30	66	36	162	41	NSV3066-36TTRS	\$2,707	\$2,809	\$2,758	\$2,851	--
	30	60	36	155	36	NSV3060-36TTRS	\$2,662	\$2,755	\$2,717	\$2,802	--
SOLID SURFACE	36	72	36	252	55	NSS3672-36TTRS	--	--	--	--	\$5,708
	36	66	36	240	54	NSS3666-36TTRS	--	--	--	--	\$5,251
	36	60	36	229	42	NSS3660-36TTRS	--	--	--	--	\$5,013
	30	72	36	194	55	NSS3072-36TTRS	--	--	--	--	\$5,019
	30	66	36	185	41	NSS3066-36TTRS	--	--	--	--	\$4,810
	30	60	36	176	36	NSS3060-36TTRS	--	--	--	--	\$4,610

HSON

To Order Specify

Veneer Model #	② Edge Detail	③ Wood Species	④ Wood Finish			⑤ Electrical Cut Out	⑥ Metal Finish
Veneer (NSV)	R3 Eased K9 Reverse Bevel	Flat Cut CH1 Cherry MA1 Maple WA1 Walnut	Cherry: BRL Barley BBM Bourbon Medium BRM Brighton Medium CLA Classic CLL Collectors* EAR Earthy HRV Harvest* LGC Legacy PRL Praline* SAF Saffron	Maple: ALM Ale Medium BUT Butterscotch CIN Cinnamon FLX Flax VEN Venetian	Walnut: AUB Auburn ESP Espresso MCH Mocha* NTO Night Owl* SIE Sienna* TOF Toffee TRF Truffle*	N None CO_EC23 Cut out for EC23 CO_EC24 Cut out for EC24	BWH Bright White Feet & Post MBK Matte Black Feet & Post PEW Pewter Feet & Post ASLASL Arctic Silver Feet & Post ASLBWH Arctic Silver Feet & Bright White Post ASLMBK Arctic Silver Feet & Matte Black Post ASLPEW Arctic Silver Feet & Pewter Post
		Double Cut DC2 Double Cut	④ Wood Finish Double Cut: COF Coffee FOS Fossil KHK Khaki CRM Cremello GRH Graphite STU Studio Teak				

① Solid Surface Model #	② Edge Detail	③ Solid Surface	④ Electrical Cut Out	⑤ Metal Finish
Solid Surface (NSS)	S7 Reverse Bevel	Tier 1 ARM Armadillo BLP Black Pearl GRA Graphite Granite PEB Pebble Pearl PUR Pure White	N None CO_EC23 Cut out for EC23 CO_EC24 Cut out for EC24	BWH Bright White Feet & Post MBK Matte Black Feet & Post PEW Pewter Feet & Post ASLASL Arctic Silver Feet & Post ASLBWH Arctic Silver Feet & Bright White Post ASLMBK Arctic Silver Feet & Matte Black Post ASLPEW Arctic Silver Feet & Pewter Post

Description

Round Counter Height Table with X Base

Laminate Tables  
"NST" Models

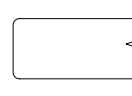
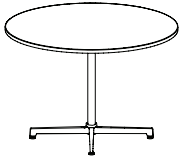

Eased Edge (R3)

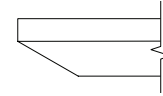

Reverse Bevel Edge (K9)

LAMINATE	D	W	H	CTN WT	CU FT	① Model	Eased Edge (R3)			Reverse Bevel Edge (K9)		
							Standard	Graded In		Standard	Graded In	
							Tier 1	Tier 2	Tier 3	Tier 1	Tier 2	Tier 3
	48	N/A	36	88	25	NST48-36RDX	\$1,366	\$1,462	\$1,568	\$1,735	\$1,831	\$1,939
	42	N/A	36	74	21	NST42-36RDX	\$1,254	\$1,350	\$1,429	\$1,625	\$1,720	\$1,798
	36	N/A	36	60	18	NST36-36RDX	\$1,218	\$1,252	\$1,309	\$1,587	\$1,621	\$1,678
	30	N/A	36	48	16	NST30-36RDX	\$1,176	\$1,203	\$1,237	\$1,545	\$1,572	\$1,606

Features:

- price reflects complete table - top and base
- ships KD in multiple cartons
- top has option for cutout to receive electrical component, ordered separately
- when electrical cut out selected, power accessible base is sent - add \$95
- optional vertical wire manager for base, order separately
- base has leveling glides
- width of base foot varies from 26" or 32"

HSON

To Order Specify

① Laminate Model #	② Edge Detail	③ Laminate Selection	③a PVC Edge Color	④ Electrical Cut Out	⑤ Metal Finish
Laminate (NST)	R3 Eased K9 Reverse Bevel	<b>Standard Laminates (T1)</b> Solid Patterns: ALB Alabaster      DWH Designer White BLK Black          SHD Shadow BBL Bridal Blanco    SLG Slate Grey  Wood Grain Patterns: AGA Aged Ash      GRH Graphite ALL Ale Light      HGL High Line BLO Blonde Echo    OAT Oatmeal Cookie BOL Bourbon Light    PIN Pinnacle Walnut BZW Brazilwood      STU Studio Teak BGL Brighton Light    VIN Vintage CLL Collectors        WLH Walnut Heights FLO Florence Walnut    WEA Weathered Ash	Color: <b>Standard (T1) laminates have a matching PVC.</b> AGA Aged Ash ALB Alabaster ALL Ale Light BLK Black BLO Blonde Echo BOL Bourbon Light BZW Brazilwood BBL Bridal Blanco BGL Brighton Light CLL Collectors DWH Designer White FLO Florence Walnut GRH Graphite HGL High Line OAT Oatmeal Cookie PIN Pinnacle Walnut SHD Shadow SLG Slate Grey STU Studio Teak VIN Vintage WLH Walnut Heights WEA Weathered Ash	N None COB_EC23 Cut out for EC23 COB_EC24 Cut out for EC24	BWH Bright White Feet & Post MBK Matte Black Feet & Post PEW Pewter Feet & Post ASLASL Arctic Silver Feet & Post ASLBWH Arctic Silver Feet & Bright White Post ASLMBK Arctic Silver Feet & Matte Black Post ASLPEW Arctic Silver Feet & Pewter Post PAMASL Polished Aluminum Feet & Arctic Silver Post PAMBWH Polished Aluminum Feet & Bright White Post PAMMBK Polished Aluminum Feet & Matte Black Post PAMPEW Polished Aluminum Feet & Pewter Post
			<b>Graded-In Laminates (T2) &amp; (T3)</b> see pages 156-161	PVC color must be selected with Graded-In Laminates (T2) & (T3)	

Model Number Breakdown

NST30-36RDX					
NS	T	30	36	RD	X
Nosh	Laminate	30" Diameter	Height	Round Top Shape	X base

Description

Round Counter Height Table with X Base  
(continued)

		Veneer Tables "NSV" Models				Solid Surface Tables "NSS" Models					
		Eased Edge (R3)		Reverse Bevel Edge (K9)		Reverse Bevel Edge (S7)					
		Flat Cut	Double Cut	Flat Cut	Double Cut	Standard					
	D	W	H	CTN WT	CU FT	① Model	Flat Cut	Double Cut	Flat Cut	Double Cut	Standard
VENEER	48	N/A	36	88	25	NSV48-36RDX	\$1,798	\$1,917	\$1,867	\$1,992	--
	42	N/A	36	74	21	NSV42-36RDX	\$1,651	\$1,760	\$1,714	\$1,827	--
	36	N/A	36	60	18	NSV36-36RDX	\$1,600	\$1,705	\$1,661	\$1,772	--
	30	N/A	36	48	16	NSV30-36RDX	\$1,544	\$1,646	\$1,603	\$1,707	--
SOLID SURFACE	48	N/A	36	118	25	NSS48-36RDX	--	--	--	--	\$4,186
	42	N/A	36	96	21	NSS42-36RDX	--	--	--	--	\$3,570
	36	N/A	36	76	18	NSS36-36RDX	--	--	--	--	\$3,113
	30	N/A	36	59	16	NSS30-36RDX	--	--	--	--	\$2,711

NOSH

To Order Specify

① Veneer Model #	② Edge Detail	③ Wood Species	④ Wood Finish	⑤ Electrical Cut Out	⑥ Metal Finish
Veneer (NSV)	R3 Eased K9 Reverse Bevel	<b>Flat Cut</b> CH1 Cherry MA1 Maple WA1 Walnut	Cherry: BRL Barley BBM Bourbon Medium BRM Brighton Medium CLA Classic CLL Collectors* EAR Earthy HRV Harvest* LGC Legacy PRL Praline* SAF Saffron  Maple: ALM Ale Medium BUT Butterscotch CIN Cinnamon FLX Flax VEN Venetian  Walnut: AUB Auburn ESP Espresso MCH Mocha* NTO Night Owl* SIE Sienna* TOF Toffee* TRF Truffle*  *finishes with coordinating laminate tops	N None COB_EC23 Cut out for EC23 COB_EC24 Cut out for EC24	BWH Bright White Feet & Post MBK Matte Black Feet & Post PEW Pewter Feet & Post ASLASL Arctic Silver Feet & Post ASLBWH Arctic Silver Feet & Bright White Post ASLMBK Arctic Silver Feet & Matte Black Post ASLPEW Arctic Silver Feet & Pewter Post PAMASL Polished Aluminum Feet & Arctic Silver Post PAMBWH Polished Aluminum Feet & Bright White Post PAMMBK Polished Aluminum Feet & Matte Black Post PAMPEW Polished Aluminum Feet & Pewter Post
		<b>Double Cut</b> DC2 Double Cut	<b>④ Wood Finish</b>  Double Cut: COF Coffee FOS Fossil KHK Khaki CRM Cremello GRH Graphite STU Studio Teak		

① Solid Surface Model #	② Edge Detail	③ Solid Surface	④ Electrical Cut Out	⑤ Metal Finish
Solid Surface (NSS)	S7 Reverse Bevel	<b>Tier 1</b> ARM Armadillo BLP Black Pearl GRA Graphite Granite PEB Pebble Pearl PUR Pure White	N None COB_EC23 Cut out for EC23 COB_EC24 Cut out for EC24	BWH Bright White Feet & Post MBK Matte Black Feet & Post PEW Pewter Feet & Post ASLASL Arctic Silver Feet & Post ASLBWH Arctic Silver Feet & Bright White Post ASLMBK Arctic Silver Feet & Matte Black Post ASLPEW Arctic Silver Feet & Pewter Post PAMASL Polished Aluminum Feet & Arctic Silver Post PAMBWH Polished Aluminum Feet & Bright White Post PAMMBK Polished Aluminum Feet & Matte Black Post PAMPEW Polished Aluminum Feet & Pewter Post

Description

Round Counter Height Table with X4 Base

Laminate Tables  
"NST" Models

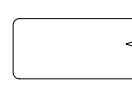
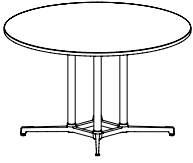

Eased Edge (R3)

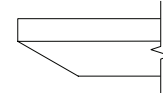

Reverse Bevel Edge (K9)

LAMINATE	D	W	H	CTN WT	CU FT	1 Model	Eased Edge (R3)			Reverse Bevel Edge (K9)		
							Standard	Graded In		Standard	Graded In	
							Tier 1	Tier 2	Tier 3	Tier 1	Tier 2	Tier 3
	60	N/A	36	154	48	NST60-36RDZ	\$2,276	\$2,352	\$2,521	\$2,645	\$2,721	\$2,891
	54	N/A	36	105	26	NST54-36RDZ	\$2,126	\$2,185	\$2,242	\$2,496	\$2,555	\$2,613

Features:

- price reflects complete table - top and base
- ships KD in multiple cartons
- base has leveling glides
- top has option for cut out to receive electrical component, enter separately
- optional vertical wire manager for base, order separately
- width of base foot is 38"

HSON

To Order Specify

1 Laminate Model #	2 Edge Detail	3 Laminate Selection	3a PVC Edge Color	4 Electrical Cut Out	5 Metal Finish
Laminate (NST)	R3 Eased K9 Reverse Bevel	<b>Standard Laminates (T1)</b> Solid Patterns: ALB Alabaster      DWH Designer White BLK Black          SHD Shadow BBL Bridal Blanco    SLG Slate Grey  Wood Grain Patterns: AGA Aged Ash      GRH Graphite ALL Ale Light      HGL High Line BLO Blonde Echo    OAT Oatmeal Cookie BOL Bourbon Light    PIN Pinnacle Walnut BZW Brazilwood      STU Studio Teak BGL Brighton Light    VIN Vintage CLL Collectors        WLH Walnut Heights FLO Florence Walnut    WEA Weathered Ash	Color: <b>Standard (T1) laminates have a matching PVC.</b> AGA Aged Ash ALB Alabaster ALL Ale Light BLK Black BLO Blonde Echo BOL Bourbon Light BZW Brazilwood BBL Bridal Blanco BGL Brighton Light CLL Collectors DWH Designer White FLO Florence Walnut GRH Graphite HGL High Line OAT Oatmeal Cookie PIN Pinnacle Walnut SHD Shadow SLG Slate Grey STU Studio Teak VIN Vintage WLH Walnut Heights WEA Weathered Ash	N None CO_EC23 Cut out for EC23 CO_EC24 Cut out for EC24	BWH Bright White Feet & Post MBK Matte Black Feet & Post PEW Pewter Feet & Post ASLASL Arctic Silver Feet & Post ASLBWH Arctic Silver Feet & Bright White Post ASLMBK Arctic Silver Feet & Matte Black Post ASLPEW Arctic Silver Feet & Pewter Post PAMASL Polished Aluminum Feet & Arctic Silver Post PAMBWH Polished Aluminum Feet & Bright White Post PAMMBK Polished Aluminum Feet & Matte Black Post PAMPEW Polished Aluminum Feet & Pewter Post
			<b>Graded-In Laminates (T2) &amp; (T3)</b> see pages 156-161	PVC color must be selected with Graded-In Laminates (T2) & (T3)	

Model Number Breakdown

NST54-36RDZ					
NS	T	54	36	RD	Z
Nosh	Laminate	54" Diameter	Height	Round Top Shape	X4 Base

Description

Round Counter Height Table with X4 Base  
(continued)

		Veneer Tables "NSV" Models				Solid Surface Tables "NSS" Models					
		Eased Edge (R3)		Reverse Bevel Edge (K9)		Reverse Bevel Edge (S7)					
		Flat Cut	Double Cut	Flat Cut	Double Cut	Standard					
	D	W	H	CTN WT	CU FT	1 Model	Flat Cut	Double Cut	Flat Cut	Double Cut	Standard
VENEER	60	N/A	36	154	48	NSV60-36RDZ	\$2,982	\$3,177	\$3,094	\$3,297	--
	54	N/A	36	105	26	NSV54-36RDZ	\$2,817	\$3,008	\$2,926	\$3,125	--
SOL SURF	60	N/A	36	202	48	NSS60-36RDZ	--	--	--	--	\$6,494
	54	N/A	36	146	23	NSS54-36RDZ	--	--	--	--	\$5,737

HSON

To Order Specify

Veneer Model #	2 Edge Detail	3 Wood Species	4 Wood Finish			5 Electrical Cut Out	6 Metal Finish
Veneer (NSV)	R3 Eased K9 Reverse Bevel	Flat Cut CH1 Cherry MA1 Maple WA1 Walnut	Cherry: BRL Barley BBM Bourbon Medium BRM Brighton Medium CLA Classic CLL Collectors* EAR Earthy HRV Harvest* LGC Legacy PRL Praline* SAF Saffron	Maple: ALM Ale Medium BUT Butterscotch CIN Cinnamon FLX Flax VEN Venetian	Walnut: AUB Auburn ESP Espresso MCH Mocha* NTO Night Owl* SIE Sienna* TOF Toffee* TRF Truffle*	N None CO_EC23 Cut out for EC23 CO_EC24 Cut out for EC24	BWH Bright White Feet & Post MBK Matte Black Feet & Post PEW Pewter Feet & Post ASLASL Arctic Silver Feet & Post ASLBWH Arctic Silver Feet & Bright White Post ASLMBK Arctic Silver Feet & Matte Black Post ASLPEW Arctic Silver Feet & Pewter Post PAMASL Polished Aluminum Feet & Arctic Silver Post PAMBWH Polished Aluminum Feet & Bright White Post PAMMBK Polished Aluminum Feet & Matte Black Post PAMPEW Polished Aluminum Feet & Pewter Post
		Double Cut DC2 Double Cut	4 Wood Finish Double Cut: COF Coffee FOS Fossil KHK Khaki CRM Cremello GRH Graphite STU Studio Teak				

1 Solid Surface Model #	2 Edge Detail	3 Solid Surface	4 Electrical Cut Out	5 Metal Finish
Solid Surface (NSS)	S7 Reverse Bevel	Tier 1 ARM Armadillo BLP Black Pearl GRA Graphite Granite PEB Pebble Pearl PUR Pure White	N None CO_EC23 Cut out for EC23 CO_EC24 Cut out for EC24	BWH Bright White Feet & Post MBK Matte Black Feet & Post PEW Pewter Feet & Post ASLASL Arctic Silver Feet & Post ASLBWH Arctic Silver Feet & Bright White Post ASLMBK Arctic Silver Feet & Matte Black Post ASLPEW Arctic Silver Feet & Pewter Post PAMASL Polished Aluminum Feet & Arctic Silver Post PAMBWH Polished Aluminum Feet & Bright White Post PAMMBK Polished Aluminum Feet & Matte Black Post PAMPEW Polished Aluminum Feet & Pewter Post

Description

Round Counter Height Table with Round Disc Base

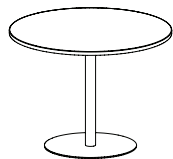

Laminate Tables "NST" Models

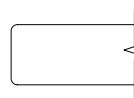

Eased Edge (R3)

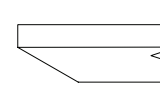

Reverse Bevel Edge (K9)

LAMINATE	D	W	H	CTN WT	CU FT	1 Model	Eased Edge (R3)			Reverse Bevel Edge (K9)		
							Standard	Graded In		Standard	Graded In	
							Tier 1	Tier 2	Tier 3	Tier 1	Tier 2	Tier 3
	48	N/A	36	132	25	NST48-36RDR	\$1,567	\$1,618	\$1,725	\$1,937	\$1,988	\$2,095
	42	N/A	36	117	20	NST42-36RDR	\$1,432	\$1,476	\$1,553	\$1,802	\$1,846	\$1,923
	36	N/A	36	86	17	NST36-36RDR	\$1,226	\$1,263	\$1,316	\$1,596	\$1,633	\$1,685
	30	N/A	36	64	15	NST30-36RDR	\$1,053	\$1,085	\$1,116	\$1,423	\$1,454	\$1,485

Features:

- price reflects complete table - top and base
- ships KD in multiple cartons
- base has anti-rock glides
- cut out for power is not available on these tables
- width of base foot varies from 22" or 27"

HSON

To Order Specify

1 Laminate Model #	2 Edge Detail	3 Laminate Selection	3a PVC Edge Color	4 Metal Finish
Laminate (NST)	R3 Eased K9 Reverse Bevel	<b>Standard Laminates (T1)</b> Solid Patterns: ALB Alabaster      DWH Designer White BLK Black          SHD Shadow BBL Bridal Blanco    SLG Slate Grey  Wood Grain Patterns: AGA Aged Ash      GRH Graphite ALL Ale Light      HGL High Line BLO Blonde Echo    OAT Oatmeal Cookie BOL Bourbon Light    PIN Pinnacle Walnut BZW Brazilwood      STU Studio Teak BGL Brighton Light    VIN Vintage CLL Collectors        WLH Walnut Heights FLO Florence Walnut    WEA Weathered Ash	Color: Standard (T1) laminates have a matching PVC. AGA Aged Ash ALB Alabaster ALL Ale Light BLK Black BLO Blonde Echo BOL Bourbon Light BZW Brazilwood BBL Bridal Blanco BGL Brighton Light CLL Collectors DWH Designer White FLO Florence Walnut GRH Graphite HGL High Line OAT Oatmeal Cookie PIN Pinnacle Walnut SHD Shadow SLG Slate Grey STU Studio Teak VIN Vintage WLH Walnut Heights WEA Weathered Ash	BWH Bright White Feet & Post MBK Matte Black Feet & Post PEW Pewter Feet & Post ASLASL Arctic Silver Feet & Post ASLBWH Arctic Silver Feet & Bright White Post ASLMBK Arctic Silver Feet & Matte Black Post ASLPEW Arctic Silver Feet & Pewter Post
		Graded-In Laminates (T2) & (T3) see pages 156-161	PVC color must be selected with Graded-In Laminates (T2) & (T3)	

Model Number Breakdown

NST30-36RDR					
NS	T	30	36	RD	R
Nosh	Laminate	30" Diameter	Height	Round Top Shape	R Disc Base

Description

Round Counter Height Table  
with Round Disc Base  
(continued)

		Veneer Tables "NSV" Models				Solid Surface Tables "NSS" Models					
		Eased Edge (R3)		Reverse Bevel Edge (K9)		Reverse Bevel Edge (S7)					
		Flat Cut	Double Cut	Flat Cut	Double Cut	Standard					
	D	W	H	CTN WT	CU FT	1 Model	Flat Cut	Double Cut	Flat Cut	Double Cut	Standard
VENEER	48	N/A	36	132	25	NSV48-36RDR	\$2,068	\$2,209	\$2,148	\$2,293	--
	42	N/A	36	117	20	NSV42-36RDR	\$1,888	\$2,014	\$1,961	\$2,093	--
	36	N/A	36	86	17	NSV36-36RDR	\$1,611	\$1,719	\$1,674	\$1,785	--
	30	N/A	36	64	15	NSV30-36RDR	\$1,380	\$1,472	\$1,433	\$1,527	--
SOLID SURFACE	48	N/A	36	162	25	NSS48-36RDR	--	--	--	--	\$4,457
	42	N/A	36	140	20	NSS42-36RDR	--	--	--	--	\$3,807
	36	N/A	36	103	17	NSS36-36RDR	--	--	--	--	\$3,124
	30	N/A	36	75	15	NSS30-36RDR	--	--	--	--	\$2,547

NOSH

To Order Specify

Veneer Model #	2 Edge Detail	3 Wood Species	4 Wood Finish	5 Metal Finish		
Veneer (NSV)	R3 Eased K9 Reverse Bevel	<b>Flat Cut</b> CH1 Cherry MA1 Maple WA1 Walnut	Cherry: BRL Barley BBM Bourbon Medium BRM Brighton Medium CLA Classic CLL Collectors* EAR Earthy HRV Harvest* LGC Legacy PRL Praline* SAF Saffron	Maple: ALM Ale Medium BUT Butterscotch CIN Cinnamon FLX Flax VEN Venetian	Walnut: AUB Auburn ESP Espresso MCH Mocha* NTO Night Owl* SIE Sienna* TOF Toffee TRF Truffle*	BWH Bright White Feet & Post MBK Matte Black Feet & Post PEW Pewter Feet & Post ASLASL Arctic Silver Feet & Post ASLBWH Arctic Silver Feet & Bright White Post ASLMBK Arctic Silver Feet & Matte Black Post ASLPEW Arctic Silver Feet & Pewter Post
		<b>Double Cut</b> DC2 Double Cut	<b>4 Wood Finish</b> Double Cut: COF Coffee FOS Fossil KHK Khaki CRM Cremello GRH Graphite STU Studio Teak			

1 Solid Surface Model #	2 Edge Detail	3 Solid Surface	4 Metal Finish
Solid Surface (NSS)	S7 Reverse Bevel	<b>Tier 1</b> ARM Armadillo BLP Black Pearl GRA Graphite Granite PEB Pebble Pearl PUR Pure White	BWH Bright White Feet & Post MBK Matte Black Feet & Post PEW Pewter Feet & Post ASLASL Arctic Silver Feet & Post ASLBWH Arctic Silver Feet & Bright White Post ASLMBK Arctic Silver Feet & Matte Black Post ASLPEW Arctic Silver Feet & Pewter Post



Description

Round Counter Height Table with Square Disc Base

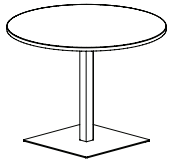

Laminate Tables "NST" Models

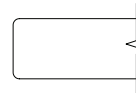

Eased Edge (R3)

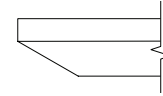

Reverse Bevel Edge (K9)

LAMINATE	D	W	H	CTN WT	CU FT	1 Model	Standard			Graded In		
	Tier 1	Tier 2	Tier 3	Tier 1	Tier 2	Tier 3	Tier 1	Tier 2	Tier 3	Tier 1	Tier 2	Tier 3
	48	N/A	36	147	25	<b>NST48-36RDS</b>	\$1,748	\$1,799	\$1,907	\$2,118	\$2,170	\$2,276
42	N/A	36	132	20	<b>NST42-36RDS</b>	\$1,613	\$1,657	\$1,735	\$1,983	\$2,026	\$2,104	
36	N/A	36	98	17	<b>NST36-36RDS</b>	\$1,351	\$1,388	\$1,441	\$1,721	\$1,758	\$1,811	
30	N/A	36	69	15	<b>NST30-36RDS</b>	\$1,179	\$1,208	\$1,241	\$1,548	\$1,579	\$1,610	

Features:

- price reflects complete table - top and base
- ships KD in multiple cartons
- top has option for cut out to receive electrical component, order separately
- optional vertical wire manage for base, order separately
- width of base foot varies from 17" to 27"
- base has anti-rock glides

HSON

To Order Specify

1 Laminate Model #	2 Edge Detail	3 Laminate Selection	3a PVC Edge Color	4 Metal Finish
Laminate (NST)	R3 Eased K9 Reverse Bevel	<b>Standard Laminates (T1)</b> Solid Patterns: ALB Alabaster      DWH Designer White BLK Black            SHD Shadow BBL Bridal Blanco    SLG Slate Grey  Wood Grain Patterns: AGA Aged Ash        GRH Graphite ALL Ale Light        HGL High Line BLO Blonde Echo     OAT Oatmeal Cookie BOL Bourbon Light    PIN Pinnacle Walnut BZW Brazilwood      STU Studio Teak BGL Brighton Light    VIN Vintage CLL Collectors        WLH Walnut Heights FLO Florence Walnut    WEA Weathered Ash	Color: Standard (T1) laminates have a matching PVC. AGA Aged Ash ALB Alabaster ALL Ale Light BLK Black BLO Blonde Echo BOL Bourbon Light BZW Brazilwood BBL Bridal Blanco BGL Brighton Light CLL Collectors DWH Designer White FLO Florence Walnut GRH Graphite HGL High Line OAT Oatmeal Cookie PIN Pinnacle Walnut SHD Shadow SLG Slate Grey STU Studio Teak VIN Vintage WLH Walnut Heights WEA Weathered Ash	BWH Bright White Feet & Post MBK Matte Black Feet & Post PEW Pewter Feet & Post ASLASL Arctic Silver Feet & Post ASLBWH Arctic Silver Feet & Bright White Post ASLMBK Arctic Silver Feet & Matte Black Post ASLPEW Arctic Silver Feet & Pewter Post
		Graded-In Laminates (T2) & (T3) see pages 156-161	PVC color must be selected with Graded-In Laminates (T2) & (T3)	

Model Number Breakdown

NST30-36RDS					
NS	T	30	36	RD	S
Nosh	Laminate	30" Diameter	Height	Round Top Shape	Square Disc Base

Description

Round Counter Height Table  
with Square Disc Base  
(continued)

Veneer Tables "NSV" Models      Solid Surface Tables "NSS" Models

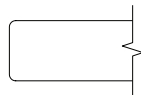

Eased Edge (R3)

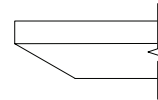

Reverse Bevel Edge (K9)

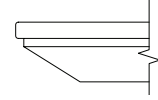

Reverse Bevel Edge (S7)

	D	W	H	CTN WT	CU FT	① Model	Eased Edge (R3)		Reverse Bevel Edge (K9)		Reverse Bevel Edge (S7) Standard
							Flat Cut	Double Cut	Flat Cut	Double Cut	
VENEER	48	N/A	36	147	25	NSV48-36RDS	\$2,312	\$2,468	\$2,403	\$2,564	--
	42	N/A	36	132	20	NSV42-36RDS	\$2,131	\$2,274	\$2,213	\$2,362	--
	36	N/A	36	98	17	NSV36-36RDS	\$1,780	\$1,898	\$1,849	\$1,972	--
	30	N/A	36	69	15	NSV30-36RDS	\$1,548	\$1,651	\$1,607	\$1,715	--
SOLID SURFACE	48	N/A	36	177	25	NSS48-36RDS	--	--	--	--	\$4,701
	42	N/A	36	155	20	NSS42-36RDS	--	--	--	--	\$4,049
	36	N/A	36	103	17	NSS36-36RDS	--	--	--	--	\$3,293
	30	N/A	36	80	15	NSS30-36RDS	--	--	--	--	\$2,715

NOSH

To Order Specify

Veneer Model #	② Edge Detail	③ Wood Species	④ Wood Finish			⑤ Metal Finish
Veneer (NSV)	R3 Eased K9 Reverse Bevel	Flat Cut CH1 Cherry MA1 Maple WA1 Walnut	Cherry: BRL Barley BBM Bourbon Medium BRM Brighton Medium CLA Classic CLL Collectors* EAR Earthy HRV Harvest* LGC Legacy PRL Praline* SAF Saffron	Maple: ALM Ale Medium BUT Butterscotch CIN Cinnamon FLX Flax VEN Venetian	Walnut: AUB Auburn ESP Espresso MCH Mocha* NTO Night Owl* SIE Sienna* TOF Toffee TRF Truffle*	BWH Bright White Feet & Post MBK Matte Black Feet & Post PEW Pewter Feet & Post ASLASL Arctic Silver Feet & Post ASLBWH Arctic Silver Feet & Bright White Post ASLMBK Arctic Silver Feet & Matte Black Post ASLPEW Arctic Silver Feet & Pewter Post
		Double Cut DC2 Double Cut	④ Wood Finish Double Cut: COF Coffee FOS Fossil KHK Khaki CRM Cremello GRH Graphite STU Studio Teak			

① Solid Surface Model #	② Edge Detail	③ Solid Surface	④ Metal Finish
Solid Surface (NSS)	S7 Reverse Bevel	Tier 1 ARM Armadillo BLP Black Pearl GRA Graphite Granite PEB Pebble Pearl PUR Pure White	BWH Bright White Feet & Post MBK Matte Black Feet & Post PEW Pewter Feet & Post ASLASL Arctic Silver Feet & Post ASLBWH Arctic Silver Feet & Bright White Post ASLMBK Arctic Silver Feet & Matte Black Post ASLPEW Arctic Silver Feet & Pewter Post

Description

Square Counter Height Table with X Base

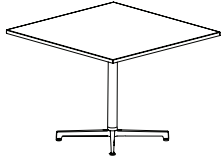

Laminate Tables  
"NST" Models

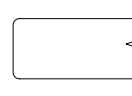

Eased Edge (R3)

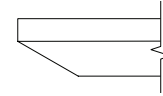

Reverse Bevel Edge (K9)

LAMINATE	D	W	H	CTN WT	CU FT	① Model	Eased Edge (R3)			Reverse Bevel Edge (K9)		
							Standard	Graded In		Standard	Graded In	
							Tier 1	Tier 2	Tier 3	Tier 1	Tier 2	Tier 3
	42	42	36	87	21	NST4242-36SQX	\$1,285	\$1,328	\$1,430	\$1,655	\$1,697	\$1,799
	36	36	36	55	18	NST3636-36SQX	\$1,143	\$1,178	\$1,201	\$1,512	\$1,547	\$1,570
	30	30	36	55	16	NST3030-36SQX	\$1,028	\$1,057	\$1,069	\$1,398	\$1,426	\$1,438

Features:

- price reflects complete table - top and base
- ships KD in multiple cartons
- top has option for cutout to receive electrical component, ordered separately
- when electrical cut out selected, power accessible base is sent - add \$95
- optional vertical wire manager for base, order separately
- base has leveling glides
- width of base foot varies from 26" to 38"

HSON

To Order Specify

① Laminate Model #	② Edge Detail	③ Laminate Selection	③a PVC Edge Color	④ Electrical Cut Out	⑤ Metal Finish
Laminate (NST)	R3 Eased K9 Reverse Bevel	<b>Standard Laminates (T1)</b> Solid Patterns: ALB Alabaster      DWH Designer White BLK Black          SHD Shadow BBL Bridal Blanco    SLG Slate Grey  Wood Grain Patterns: AGA Aged Ash      GRH Graphite ALL Ale Light      HGL High Line BLO Blonde Echo    OAT Oatmeal Cookie BOL Bourbon Light    PIN Pinnacle Walnut BZW Brazilwood      STU Studio Teak BGL Brighton Light    VIN Vintage CLL Collectors        WLH Walnut Heights FLO Florence Walnut    WEA Weathered Ash	Color: Standard (T1) laminates have a matching PVC. AGA Aged Ash ALB Alabaster ALL Ale Light BLK Black BLO Blonde Echo BOL Bourbon Light BZW Brazilwood BBL Bridal Blanco BGL Brighton Light CLL Collectors DWH Designer White FLO Florence Walnut GRH Graphite HGL High Line OAT Oatmeal Cookie PIN Pinnacle Walnut SHD Shadow SLG Slate Grey STU Studio Teak VIN Vintage WLH Walnut Heights WEA Weathered Ash	N None CO_EC23 Cut out for EC23 CO_EC24 Cut out for EC24	BWH Bright White Feet & Post MBK Matte Black Feet & Post PEW Pewter Feet & Post ASLASL Arctic Silver Feet & Post ASLBWH Arctic Silver Feet & Bright White Post ASLMBK Arctic Silver Feet & Matte Black Post ASLPEW Arctic Silver Feet & Pewter Post PAMASL Polished Aluminum Feet & Arctic Silver Post PAMBWH Polished Aluminum Feet & Bright White Post PAMMBK Polished Aluminum Feet & Matte Black Post PAMPEW Polished Aluminum Feet & Pewter Post
		Graded-In Laminates (T2) & (T3) see pages 156-161	PVC color must be selected with Graded-In Laminates (T2) & (T3)		

Model Number Breakdown

NSV4848-36SQX					
NS	V	4848	36	SQ	X
Nosh	Veneer	48" x 48"	Height	Square Top Shape	X Base

Description

Square Counter Height Table with X Base  
(continued)

Veneer Tables  
"NSV" Models

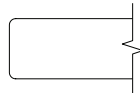

Eased Edge (R3)

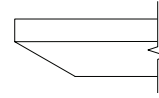

Reverse Bevel Edge (K9)

VENEER	D	W	H	CTN WT	CU FT	1 Model	Flat Cut	Double Cut	Flat Cut	Double Cut
	42	42	36	87	21	NSV4242-36SQX	\$1,668	\$1,778	\$1,732	\$1,846
36	36	36	55	18	NSV3636-36SQX	\$1,480	\$1,578	\$1,536	\$1,637	
30	30	36	55	16	NSV3030-36SQX	\$1,329	\$1,416	\$1,378	\$1,469	

NOSH

To Order Specify

1 Veneer Model #	2 Edge Detail	3 Wood Species	4 Wood Finish			5 Electrical Cut Out	6 Metal Finish
Veneer (NSV)	R3 Eased K9 Reverse Bevel	<b>Flat Cut</b> CH1 Cherry MA1 Maple WA1 Walnut	Cherry: BRL Barley BBM Bourbon Medium BRM Brighton Medium CLA Classic CLL Collectors* EAR Earthy HRV Harvest* LGC Legacy PRL Praline* SAF Saffron	Maple: ALM Ale Medium BUT Butterscotch CIN Cinnamon FLX Flax VEN Venetian	Walnut: AUB Auburn ESP Espresso MCH Mocha* NTO Night Owl* SIE Sienna* TOF Toffee TRF Truffle*	N None CO_EC23 Cut out for EC23 CO_EC24 Cut out for EC24	BWH Bright White Feet & Post MBK Matte Black Feet & Post PEW Pewter Feet & Post ASLASH Arctic Silver Feet & Post ASLBWH Arctic Silver Feet & Bright White Post ASLMBK Arctic Silver Feet & Matte Black Post ASLPEW Arctic Silver Feet & Pewter Post PAMASL Polished Aluminum Feet & Arctic Silver Post PAMBWH Polished Aluminum Feet & Bright White Post PAMMBK Polished Aluminum Feet & Matte Black Post PAMPPEW Polished Aluminum Feet & Pewter Post
			<b>Double Cut</b> DC2 Double Cut	<b>4 Wood Finish</b> Double Cut: COF Coffee FOS Fossil KHK Khaki CRM Cremello GRH Graphite STU Studio Teak			

Description

Rounded Square Counter Height Table with X Base

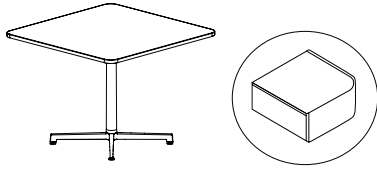

Laminate Tables "NST" Models

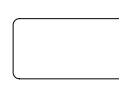

Eased Edge (R3)

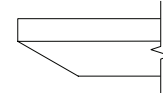

Reverse Bevel (K9)

LAMINATE	D	W	H	CTN WT	CU FT	① Model	Eased Edge (R3)			Reverse Bevel (K9)		
							Standard	Graded In		Standard	Graded In	
							Tier 1	Tier 2	Tier 3	Tier 1	Tier 2	Tier 3
	42	42	36	86	21	NST4242-36SQRX	\$1,574	\$1,617	\$1,761	\$1,944	\$1,987	\$2,131
	36	36	36	69	18	NST3636-36SQRX	\$1,224	\$1,259	\$1,313	\$1,594	\$1,629	\$1,682
	30	30	36	55	16	NST3030-36SQRX	\$1,088	\$1,117	\$1,150	\$1,457	\$1,486	\$1,520

Features:

- price reflects complete table - top and base
- ships KD in multiple cartons
- top has option for cutout to receive electrical component, ordered separately
- when electrical cut out selected, power accessible base is sent - add \$95
- optional vertical wire manager for base, order separately
- base has leveling glides
- width of base foot varies from 26" to 38"

HSON

To Order Specify

① Laminate Model #	② Edge Detail	③ Laminate Selection	③a PVC Edge Color	④ Electrical Cut Out	⑤ Metal Finish
Laminate (NST)	R3 Eased K9 Reverse Bevel	<b>Standard Laminates (T1)</b> Solid Patterns: ALB Alabaster      DWH Designer White BLK Black          SHD Shadow BBL Bridal Blanco    SLG Slate Grey  Wood Grain Patterns: AGA Aged Ash      GRH Graphite ALL Ale Light      HGL High Line BLO Blonde Echo    OAT Oatmeal Cookie BOL Bourbon Light    PIN Pinnacle Walnut BZW Brazilwood      STU Studio Teak BGL Brighton Light    VIN Vintage CLL Collectors        WLH Walnut Heights FLO Florence Walnut    WEA Weathered Ash	Color: Standard (T1) laminates have a matching PVC. AGA Aged Ash ALB Alabaster ALL Ale Light BLK Black BLO Blonde Echo BOL Bourbon Light BZW Brazilwood BBL Bridal Blanco BGL Brighton Light CLL Collectors DWH Designer White FLO Florence Walnut GRH Graphite HGL High Line OAT Oatmeal Cookie PIN Pinnacle Walnut SHD Shadow SLG Slate Grey STU Studio Teak VIN Vintage WLH Walnut Heights WEA Weathered Ash	N None CO_EC23 Cut out for EC23 CO_EC24 Cut out for EC24	BWH Bright White Feet & Post MBK Matte Black Feet & Post PEW Pewter Feet & Post ASLASL Arctic Silver Feet & Post ASLBWH Arctic Silver Feet & Bright White Post ASLMBK Arctic Silver Feet & Matte Black Post ASLPEW Arctic Silver Feet & Pewter Post PAMASL Polished Aluminum Feet & Arctic Silver Post PAMBWH Polished Aluminum Feet & Bright White Post PAMMBK Polished Aluminum Feet & Matte Black Post PAMPEW Polished Aluminum Feet & Pewter Post
		Graded-In Laminates (T2) & (T3) see pages 156-161	PVC color must be selected with Graded-In Laminates (T2) & (T3)		

Model Number Breakdown

NSV3030-36SQZ					
NS	V	3030	36	SQ	Z
Nosh	Veneer	30" x 30"	Height	Square Top Shape	X4 Base

Description

Rounded Square Counter Height Table with X Base (continued)

Veneer Tables "NSV" Models Solid Surface Tables "NSS" Models

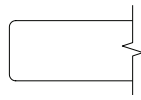

Eased Edge (R3)

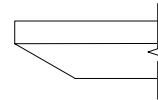

Reverse Bevel Edge (K9)

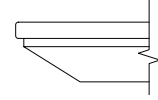

Reverse Bevel Edge (S7)

	D	W	H	CTN WT	CU FT	① Model	Eased Edge (R3)		Reverse Bevel Edge (K9)		Standard
							Flat Cut	Double Cut	Flat Cut	Double Cut	
VENEER	42	42	36	86	21	NSV4242-36SQRX	\$2,057	\$2,194	\$2,136	\$2,279	--
	36	36	36	69	18	NSV3636-36SQRX	\$1,705	\$1,820	\$1,771	\$1,889	--
	30	30	36	55	16	NSV3030-36SQRX	\$1,526	\$1,628	\$1,585	\$1,690	--
SOL SURF	42	42	36	115	21	NSS4242-36SQRX	--	--	--	--	\$4,066
	36	36	36	90	18	NSS3636-36SQRX	--	--	--	--	\$3,218
	30	30	36	69	13	NSS3030-36SQRX	--	--	--	--	\$2,693

NOSH

To Order Specify

① Veneer Model #	② Edge Detail	③ Wood Species	④ Wood Finish	⑤ Electrical Cut Out	⑥ Metal Finish
Veneer (NSV)	R3 Eased K9 Reverse Bevel	<b>Flat Cut</b> CH1 Cherry MA1 Maple WA1 Walnut	Cherry: BRL Barley BBM Bourbon Medium BRM Brighton Medium CLA Classic CLL Collectors* EAR Earthy HRV Harvest* LGC Legacy PRL Praline* SAF Saffron  Maple: ALM Ale Medium BUT Butterscotch CIN Cinnamon FLX Flax VEN Venetian  Walnut: AUB Auburn ESP Espresso MCH Mocha* NTO Night Owl* SIE Sienna* TOF Toffee* TRF Truffle*  *finishes with coordinating laminate tops	N None CO_EC23 Cut out for EC23 CO_EC24 Cut out for EC24	BWH Bright White Feet & Post MBK Matte Black Feet & Post PEW Pewter Feet & Post ASLASL Arctic Silver Feet & Post ASLBWH Arctic Silver Feet & Bright White Post ASLMBK Arctic Silver Feet & Matte Black Post ASLPEW Arctic Silver Feet & Pewter Post PAMASL Polished Aluminum Feet & Arctic Silver Post PAMBWH Polished Aluminum Feet & Bright White Post PAMMBK Polished Aluminum Feet & Matte Black Post PAMPEW Polished Aluminum Feet & Pewter Post
		<b>Double Cut</b> DC2 Double Cut	<b>④ Wood Finish</b>  Double Cut: COF Coffee FOS Fossil KHK Khaki CRM Cremello GRH Graphite STU Studio Teak		

① Solid Surface Model #	② Edge Detail	③ Solid Surface	④ Electrical Cut Out	⑤ Metal Finish
Solid Surface (NSS)	S7 Reverse Bevel	<b>Tier 1</b> ARM Armadillo BLP Black Pearl GRA Graphite Granite PEB Pebble Pearl PUR Pure White	N None CO_EC23 Cut out for EC23 CO_EC24 Cut out for EC24	BWH Bright White Feet & Post MBK Matte Black Feet & Post PEW Pewter Feet & Post ASLASL Arctic Silver Feet & Post ASLBWH Arctic Silver Feet & Bright White Post ASLMBK Arctic Silver Feet & Matte Black Post ASLPEW Arctic Silver Feet & Pewter Post PAMASL Polished Aluminum Feet & Arctic Silver Post PAMBWH Polished Aluminum Feet & Bright White Post PAMMBK Polished Aluminum Feet & Matte Black Post PAMPEW Polished Aluminum Feet & Pewter Post

Description

Square Counter Height Table with X4 Base

Laminate Tables  
"NST" Models

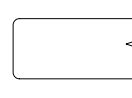
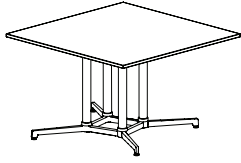

Eased Edge (R3)

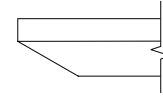

Reverse Bevel Edge (K9)

LAMINATE	D	W	H	CTN WT	CU FT	① Model	Eased Edge (R3)			Reverse Bevel Edge (K9)		
							Standard	Graded In		Standard	Graded In	
							Tier 1	Tier 2	Tier 3	Tier 1	Tier 2	Tier 3
	60	60	36	175	48	NST6060-36SQZ	\$2,584	\$2,659	\$2,829	\$2,953	\$3,029	\$3,199
	54	54	36	151	42	NST5454-36SQZ	\$2,461	\$2,527	\$2,661	\$2,830	\$2,896	\$3,030
	48	48	36	136	60	NST4848-36SQZ	\$2,047	\$2,093	\$2,203	\$2,416	\$2,462	\$2,575

Features:

- price reflects complete table - top and base
- ships KD in multiple cartons
- base has leveling glides
- top has option for cut out to receive electrical component, order separately
- optional vertical wire manager for base, order separately
- width of base foot is 38"

HSON

To Order Specify

① Laminate Model #	② Edge Detail	③ Laminate Selection	③a PVC Edge Color	④ Electrical Cut Out	⑤ Metal Finish
Laminate (NST)	R3 Eased K9 Reverse Bevel	<b>Standard Laminates (T1)</b> Solid Patterns: ALB Alabaster      DWH Designer White BLK Black          SHD Shadow BBL Bridal Blanco    SLG Slate Grey  Wood Grain Patterns: AGA Aged Ash      GRH Graphite ALL Ale Light      HGL High Line BLO Blonde Echo    OAT Oatmeal Cookie BOL Bourbon Light    PIN Pinnacle Walnut BZW Brazilwood      STU Studio Teak BGL Brighton Light    VIN Vintage CLL Collectors      WLH Walnut Heights FLO Florence Walnut    WEA Weathered Ash	CoColor: Standard (T1) laminates have a matching PVC. AGA Aged Ash ALB Alabaster ALL Ale Light BLK Black BLO Blonde Echo BOL Bourbon Light BZW Brazilwood BBL Bridal Blanco BGL Brighton Light CLL Collectors DWH Designer White FLO Florence Walnut GRH Graphite HGL High Line OAT Oatmeal Cookie PIN Pinnacle Walnut SHD Shadow SLG Slate Grey STU Studio Teak VIN Vintage WLH Walnut Heights WEA Weathered Ash	N None CO_EC23 Cut out for EC23 CO_EC24 Cut out for EC24	BWH Bright White Feet & Post MBK Matte Black Feet & Post PEW Pewter Feet & Post ASLASL Arctic Silver Feet & Post ASLBWH Arctic Silver Feet & Bright White Post ASLMBK Arctic Silver Feet & Matte Black Post ASLPEW Arctic Silver Feet & Pewter Post PAMASL Polished Aluminum Feet & Arctic Silver Post PAMBWH Polished Aluminum Feet & Bright White Post PAMMBK Polished Aluminum Feet & Matte Black Post PAMPEW Polished Aluminum Feet & Pewter Post
		Graded-In Laminates (T2) & (T3) see pages 156-161	PVC color must be selected with Graded-In Laminates (T2) & (T3)		

Model Number Breakdown

NSV5454-36SQZ					
NS	V	5454	36	SQ	Z
Nosh	Veneer	54" x 54"	Height	Square Top Shape	X4 Base

Description

Square Counter Height Table with X4 Base  
(continued)

Veneer Tables  
"NSV" Models

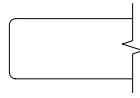

Eased Edge (R3)

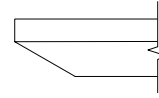

Reverse Bevel Edge (K9)

VENEER	D	W	H	CTN WT	CU FT	1 Model	Flat Cut	Double Cut	Flat Cut	Double Cut
	60	60	36	175	48	NSV6060-36SQZ	\$3,347	\$3,569	\$3,474	\$3,704
54	54	36	151	42	NSV5454-36SQZ	\$3,186	\$3,395	\$3,305	\$3,523	
48	48	36	136	60	NSV4848-36SQZ	\$2,464	\$2,585	\$2,535	\$2,661	

NOSH

To Order Specify

1 Veneer Model #	2 Edge Detail	3 Wood Species	4 Wood Finish			5 Electrical Cut Out	6 Metal Finish
Veneer (NSV)	R3 Eased K9 Reverse Bevel	<b>Flat Cut</b> CH1 Cherry MA1 Maple WA1 Walnut	Cherry: BRL Barley BBM Bourbon Medium BRM Brighton Medium CLA Classic CLL Collectors* EAR Earthy HRV Harvest* LGC Legacy PRL Praline* SAF Saffron	Maple: ALM Ale Medium BUT Butterscotch CIN Cinnamon FLX Flax VEN Venetian	Walnut: AUB Auburn ESP Espresso MCH Mocha* NTO Night Owl* SIE Sienna* TOF Toffee TRF Truffle*	N None CO_EC23 Cut out for EC23 CO_EC24 Cut out for EC24	BWH Bright White Feet & Post MBK Matte Black Feet & Post PEW Pewter Feet & Post ASLASL Arctic Silver Feet & Post ASLBWH Arctic Silver Feet & Bright White Post ASLMBK Arctic Silver Feet & Matte Black Post ASLPEW Arctic Silver Feet & Pewter Post PAMASL Polished Aluminum Feet & Arctic Silver Post PAMBWH Polished Aluminum Feet & Bright White Post PAMMBK Polished Aluminum Feet & Matte Black Post PAMPEW Polished Aluminum Feet & Pewter Post
		<b>Double Cut</b> DC2 Double Cut	<b>4 Wood Finish</b> Double Cut: COF Coffee FOS Fossil KHK Khaki CRM Cremello GRH Graphite STU Studio Teak				



Description

Rounded Square Counter Height Table with X4 Base

Laminate Tables "NST" Models

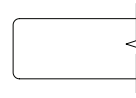
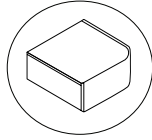
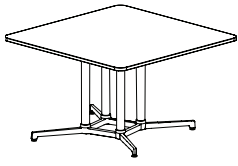

Eased Edge (R3)

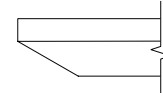

Reverse Bevel (K9)

LAMINATE	D	W	H	CTN WT	CU FT	① Model	Eased Edge (R3)			Reverse Bevel (K9)		
							Standard	Graded In		Standard	Graded In	
							Tier 1	Tier 2	Tier 3	Tier 1	Tier 2	Tier 3
	60	60	36	180	48	NST6060-36SQRZ	\$2,774	\$2,842	\$3,020	\$3,143	\$3,211	\$3,389
	54	54	36	157	42	NST5454-36SQRZ	\$2,301	\$2,368	\$2,500	\$2,671	\$2,737	\$2,869
	48	48	36	136	60	NST4848-36SQRZ	\$2,348	\$2,393	\$2,526	\$2,717	\$2,762	\$2,895

Features:

- price reflects complete table - top and base
- ships KD in multiple cartons
- base has leveling glides
- top has option for cut out to receive electrical component, order separately
- optional vertical wire manager for base, order separately
- width of base foot is 38"

HSON

To Order Specify

① Laminate Model #	② Edge Detail	③ Laminate Selection	③a PVC Edge Color	④ Electrical Cut Out	⑤ Metal Finish
Laminate (NST)	R3 Eased K9 Reverse Bevel	<b>Standard Laminates (T1)</b> Solid Patterns: ALB Alabaster      DWH Designer White BLK Black          SHD Shadow BBL Bridal Blanco    SLG Slate Grey  Wood Grain Patterns: AGA Aged Ash      GRH Graphite ALL Ale Light      HGL High Line BLO Blonde Echo    OAT Oatmeal Cookie BOL Bourbon Light    PIN Pinnacle Walnut BZW Brazilwood      STU Studio Teak BGL Brighton Light    VIN Vintage CLL Collectors      WLH Walnut Heights FLO Florence Walnut    WEA Weathered Ash	Color: Standard (T1) laminates have a matching PVC. AGA Aged Ash ALB Alabaster ALL Ale Light BLK Black BLO Blonde Echo BOL Bourbon Light BZW Brazilwood BBL Bridal Blanco BGL Brighton Light CLL Collectors DWH Designer White FLO Florence Walnut GRH Graphite HGL High Line OAT Oatmeal Cookie PIN Pinnacle Walnut SHD Shadow SLG Slate Grey STU Studio Teak VIN Vintage WLH Walnut Heights WEA Weathered Ash	N None CO_EC23 Cut out for EC23 CO_EC24 Cut out for EC24	BWH Bright White Feet & Post MBK Matte Black Feet & Post PEW Pewter Feet & Post ASLASL Arctic Silver Feet & Post ASLBWH Arctic Silver Feet & Bright White Post ASLMBK Arctic Silver Feet & Matte Black Post ASLPEW Arctic Silver Feet & Pewter Post PAMASL Polished Aluminum Feet & Arctic Silver Post PAMBWH Polished Aluminum Feet & Bright White Post PAMMBK Polished Aluminum Feet & Matte Black Post PAMPEW Polished Aluminum Feet & Pewter Post
		Graded-In Laminates (T2) & (T3) see pages 156-161	PVC color must be selected with Graded-In Laminates (T2) & (T3)		

Model Number Breakdown

NST6060-36SQRZ						
NS	T	6060	36	SQ	R	Z
Nosh	Laminate	60" x 60"	Height	Square Top Shape	Rounded Corner	X4 Base

Description

Rounded Square Counter Height Table with X4 Base (continued)

Veneer Tables "NSV" Models

Solid Surface Tables "NSS" Models

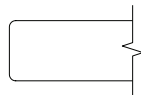

Eased Edge (R3)

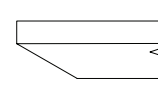

Reverse Bevel Edge (K9)

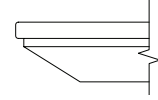

Reverse Bevel Edge (S7)

	D	W	H	CTN WT	CU FT	1 Model	Eased Edge (R3)		Reverse Bevel Edge (K9)		Standard
							Flat Cut	Double Cut	Flat Cut	Double Cut	
VENEER	60	60	36	180	48	NSV6060-36SQRZ	\$3,598	\$3,838	\$3,734	\$3,983	--
	54	54	36	157	42	NSV5454-36SQRZ	\$2,975	\$3,169	\$3,085	\$3,289	--
	48	48	36	136	60	NSV4848-36SQRZ	\$2,861	\$3,009	\$2,946	\$3,100	--
SOL SURF	60	60	36	242	48	NSS6060-36SQRZ	--	--	--	--	\$7,109
	54	54	36	206	42	NSS5454-36SQRZ	--	--	--	--	\$5,893
	48	48	36	136	60	NSS4848-36SQRZ	--	--	--	--	\$4,686

HSON

To Order Specify

1 Veneer Model #	2 Edge Detail	3 Wood Species	4 Wood Finish			5 Electrical Cut Out	6 Metal Finish
Veneer (NSV)	R3 Eased K9 Reverse Bevel	<b>Flat Cut</b> CH1 Cherry MA1 Maple WA1 Walnut	Cherry: BRL Barley BBM Bourbon Medium BRM Brighton Medium CLA Classic CLL Collectors* EAR Earthy HRV Harvest* LGC Legacy PRL Praline* SAF Saffron	Maple: ALM Ale Medium BUT Butterscotch CIN Cinnamon FLX Flax VEN Venetian	Walnut: AUB Auburn ESP Espresso MCH Mocha* NTO Night Owl* SIE Sienna* TOF Toffee TRF Truffle*	N None CO_EC23 Cut out for EC23 CO_EC24 Cut out for EC24	BWH Bright White Feet & Post MBK Matte Black Feet & Post PEW Pewter Feet & Post ASLASL Arctic Silver Feet & Post ASLBWH Arctic Silver Feet & Bright White Post ASLMBK Arctic Silver Feet & Matte Black Post ASLPEW Arctic Silver Feet & Pewter Post PAMASL Polished Aluminum Feet & Arctic Silver Post PAMBWH Polished Aluminum Feet & Bright White Post PAMMBK Polished Aluminum Feet & Matte Black Post PAMPPEW Polished Aluminum Feet & Pewter Post
			<b>Double Cut</b> DC2 Double Cut	<b>4 Wood Finish</b> Double Cut: COF Coffee FOS Fossil KHK Khaki CRM Cremello GRH Graphite STU Studio Teak			

Description

Square Counter Height Table with Round Disc Base

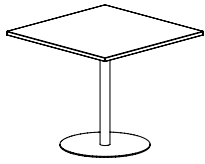

Laminate Tables "NST" Models

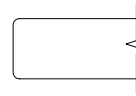

Eased Edge (R3)

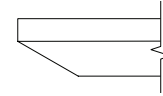

Reverse Bevel Edge (K9)

LAMINATE	D	W	H	CTN WT	CU FT	① Model	Eased Edge (R3)			Reverse Bevel Edge (K9)		
							Standard	Graded In		Standard	Graded In	
							Tier 1	Tier 2	Tier 3	Tier 1	Tier 2	Tier 3
	42	42	36	123	20	NST4242-36SQR	\$1,175	\$1,216	\$1,252	\$1,544	\$1,586	\$1,621
	36	36	36	90	17	NST3636-36SQR	\$1,076	\$1,111	\$1,135	\$1,446	\$1,481	\$1,504
	30	30	36	76	13	NST3030-36SQR	\$1,024	\$1,053	\$1,065	\$1,393	\$1,423	\$1,434

Features:

- price reflects complete table - top and base
- ships KD in multiple cartons
- cut out for power is not available on these tables
- base has anti-rock glides
- width of base foot varies from 22" or 27"

HSON

To Order Specify

① Laminate Model #	② Edge Detail	③ Laminate Selection	③a PVC Edge Color	④ Metal Finish
Laminate (NST)	R3 Eased	<b>Standard Laminates (T1)</b> Solid Patterns: ALB Alabaster      DWH Designer White BLK Black          SHD Shadow BBL Bridal Blanco    SLG Slate Grey  Wood Grain Patterns: AGA Aged Ash      GRH Graphite ALL Ale Light      HGL High Line BLO Blonde Echo    OAT Oatmeal Cookie BOL Bourbon Light    PIN Pinnacle Walnut BZW Brazilwood     STU Studio Teak BGL Brighton Light    VIN Vintage CLL Collectors      WLH Walnut Heights FLO Florence Walnut    WEA Weathered Ash	Color: Standard (T1) laminates have a matching PVC. AGA Aged Ash ALB Alabaster ALL Ale Light BLK Black BLO Blonde Echo BOL Bourbon Light BZW Brazilwood BBL Bridal Blanco BGL Brighton Light CLL Collectors DWH Designer White FLO Florence Walnut GRH Graphite HGL High Line OAT Oatmeal Cookie PIN Pinnacle Walnut SHD Shadow SLG Slate Grey STU Studio Teak VIN Vintage WLH Walnut Heights WEA Weathered Ash	BWH Bright White Feet & Post MBK Matte Black Feet & Post PEW Pewter Feet & Post ASLASL Arctic Silver Feet & Post ASLBWH Arctic Silver Feet & Bright White Post ASLMBK Arctic Silver Feet & Matte Black Post ASLPEW Arctic Silver Feet & Pewter Post
	K9 Reverse Bevel			

Model Number Breakdown

NSV4242-36SQR					
NS	V	4242	36	SQ	R
Nosh	Veneer	42" x 42"	Height	Square Top Shape	Round Disc Base

Description

Square Counter Height Table  
with Round Disc Base  
(continued)

Veneer Tables  
"NSV" Models

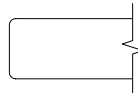

Eased Edge (R3)

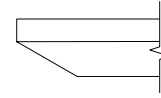

Reverse Bevel Edge (K9)

VENEER	D	W	H	CTN WT	CU FT	1 Model	Flat Cut	Double Cut	Flat Cut	Double Cut
		42	42	36	123	20	NSV4242-36SQR	\$1,485	\$1,584	\$1,542
	36	36	36	90	17	NSV3636-36SQR	\$1,357	\$1,446	\$1,409	\$1,501
	30	30	36	76	13	NSV3030-36SQR	\$1,288	\$1,372	\$1,336	\$1,424

NOSH

To Order Specify

1 Veneer Model #	2 Edge Detail	3 Wood Species	4 Wood Finish	5 Metal Finish		
Veneer (NSV)	R3 Eased	<b>Flat Cut</b> CH1 Cherry MA1 Maple WA1 Walnut	Cherry: BRL Barley BBM Bourbon Medium BRM Brighton Medium CLA Classic CLL Collectors* EAR Earthy HRV Harvest* LGC Legacy PRL Praline* SAF Saffron	Maple: ALM Ale Medium BUT Butterscotch CIN Cinnamon FLX Flax VEN Venetian *finishes with coordinating laminate tops	Walnut: AUB Auburn ESP Espresso MCH Mocha* NTO Night Owl* SIE Sienna* TOF Toffee TRF Truffle*	<b>BWH</b> Bright White Feet & Post <b>MBK</b> Matte Black Feet & Post <b>PEW</b> Pewter Feet & Post <b>ASLASL</b> Arctic Silver Feet & Post <b>ASLBWH</b> Arctic Silver Feet & Bright White Post <b>ASLMBK</b> Arctic Silver Feet & Matte Black Post <b>ASLPEW</b> Arctic Silver Feet & Pewter Post
	K9 Reverse Bevel		<b>Double Cut</b> DC2 Double Cut			

Description

Rounded Square Counter Height Table with Round Disc Base

Laminate Tables "NST" Models

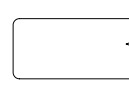
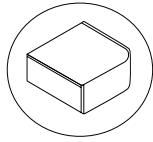
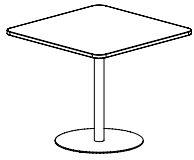

Eased Edge (R3)

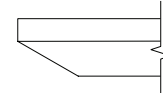

Reverse Bevel (K9)

LAMINATE	D	W	H	CTN WT	CU FT	① Model	Eased Edge (R3)			Reverse Bevel (K9)		
							Standard	Graded In		Standard	Graded In	
							Tier 1	Tier 2	Tier 3	Tier 1	Tier 2	Tier 3
	42	42	36	130	20	NST4242-36SQRR	\$1,463	\$1,506	\$1,584	\$1,832	\$1,875	\$1,953
	36	36	36	97	17	NST3636-36SQRR	\$1,248	\$1,284	\$1,336	\$1,617	\$1,654	\$1,705
	30	30	36	82	13	NST3030-36SQRR	\$1,175	\$1,204	\$1,237	\$1,544	\$1,574	\$1,606

Features:

- price reflects complete table - top and base
- ships KD in multiple cartons
- cut out for power is not available on these tables
- base has anti-rock glides
- width of base foot varies from 22" or 27"

HSON

To Order Specify

① Laminate Model #	② Edge Detail	③ Laminate Selection	③a PVC Edge Color	④ Metal Finish
Laminate (NST)	R3 Eased K9 Reverse Bevel	<b>Standard Laminates (T1)</b> Solid Patterns: ALB Alabaster      DWH Designer White BLK Black          SHD Shadow BBL Bridal Blanco    SLG Slate Grey  Wood Grain Patterns: AGA Aged Ash      GRH Graphite ALL Ale Light      HGL High Line BLO Blonde Echo    OAT Oatmeal Cookie BOL Bourbon Light    PIN Pinnacle Walnut BZW Brazilwood      STU Studio Teak BGL Brighton Light    VIN Vintage CLL Collectors        WLH Walnut Heights FLO Florence Walnut    WEA Weathered Ash	Color: Standard (T1) laminates have a matching PVC. AGA Aged Ash ALB Alabaster ALL Ale Light BLK Black BLO Blonde Echo BOL Bourbon Light BZW Brazilwood BBL Bridal Blanco BGL Brighton Light CLL Collectors DWH Designer White FLO Florence Walnut GRH Graphite HGL High Line OAT Oatmeal Cookie PIN Pinnacle Walnut SHD Shadow SLG Slate Grey STU Studio Teak VIN Vintage WLH Walnut Heights WEA Weathered Ash	BWH Bright White Feet & Post MBK Matte Black Feet & Post PEW Pewter Feet & Post ASLASL Arctic Silver Feet & Post ASLBWH Arctic Silver Feet & Bright White Post ASLMBK Arctic Silver Feet & Matte Black Post ASLPEW Arctic Silver Feet & Pewter Post
		Graded-In Laminates (T2) & (T3) see pages 156-161	PVC color must be selected with Graded-In Laminates (T2) & (T3)	

Model Number Breakdown

NST3030-36SQRR						
NS	T	3636	36	SQ	R	R
Nosh	Laminate	36" x 36"	Height	Square Top Shape	Rounded Corner	Round Disc Base

Description

Rounded Square Counter Height Table  
with Round Disc Base  
(continued)

Veneer Tables "NSV" Models      Solid Surface Tables "NSS" Models

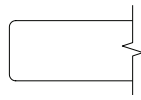

Eased Edge (R3)

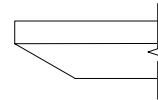

Reverse Bevel Edge (K9)

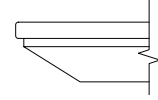

Reverse Bevel Edge (S7)

	D	W	H	CTN WT	CU FT	① Model	Eased Edge (R3)		Reverse Bevel Edge (K9)		Standard
							Flat Cut	Double Cut	Flat Cut	Double Cut	
VENEER	42	42	36	130	20	NSV4242-36SQRR	\$1,868	\$1,993	\$1,940	\$2,068	--
	36	36	36	97	17	NSV3636-36SQRR	\$1,584	\$1,688	\$1,643	\$1,753	--
SOL SURF	42	42	36	159	20	NSS4242-36SQRR	--	--	--	--	\$3,787
	36	36	36	117	17	NSS3636-36SQRR	--	--	--	--	\$3,096
	30	30	36	84	13	NSS3030-36SQRR	--	--	--	--	\$2,652

To Order Specify

① Veneer Model #	② Edge Detail	③ Wood Species	④ Wood Finish	⑤ Metal Finish		
Veneer (NSV)	R3 Eased K9 Reverse Bevel	<b>Flat Cut</b> CH1 Cherry MA1 Maple WA1 Walnut	Cherry: BRL Barley BBM Bourbon Medium BRM Brighton Medium CLA Classic CLL Collectors* EAR Earthy HRV Harvest* LGC Legacy PRL Praline* SAF Saffron	Maple: ALM Ale Medium BUT Butterscotch CIN Cinnamon FLX Flax VEN Venetian	Walnut: AUB Auburn ESP Espresso MCH Mocha* NTO Night Owl* SIE Sienna* TOF Toffee TRF Truffle*	BWH Bright White Feet & Post MBK Matte Black Feet & Post PEW Pewter Feet & Post ASLASL Arctic Silver Feet & Post ASLBWH Arctic Silver Feet & Bright White Post ASLMBK Arctic Silver Feet & Matte Black Post ASLPEW Arctic Silver Feet & Pewter Post
			<b>Double Cut</b> DC2 Double Cut	<b>④ Wood Finish</b> Double Cut: COF Coffee    FOS Fossil    KHK Khaki CRM Cremello    GRH Graphite    STU Studio Teak		

① Solid Surface Model #	② Edge Detail	③ Solid Surface	④ Metal Finish
Solid Surface (NSS)	S7 Reverse Bevel	<b>Tier 1</b> ARM Armadillo BLP Black Pearl GRA Graphite Granite PEB Pebble Pearl PUR Pure White	BWH Bright White Feet & Post MBK Matte Black Feet & Post PEW Pewter Feet & Post ASLASL Arctic Silver Feet & Post ASLBWH Arctic Silver Feet & Bright White Post ASLMBK Arctic Silver Feet & Matte Black Post ASLPEW Arctic Silver Feet & Pewter Post

NOSH

Description

Square Counter Height Table with Square Disc Base

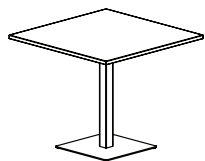

Laminate Tables "NST" Models

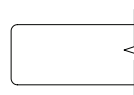

Eased Edge (R3)

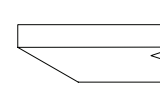

Reverse Bevel Edge (K9)

LAMINATE	D	W	H	CTN WT	CU FT	① Model	Eased Edge (R3)			Reverse Bevel Edge (K9)		
							Standard	Graded In		Standard	Graded In	
							Tier 1	Tier 2	Tier 3	Tier 1	Tier 2	Tier 3
	42	42	36	145	20	NST4242-36SQS	\$1,355	\$1,397	\$1,433	\$1,724	\$1,767	\$1,803
	36	36	36	107	17	NST3636-36SQS	\$1,201	\$1,237	\$1,259	\$1,570	\$1,606	\$1,629
	30	30	36	93	13	NST3030-36SQS	\$1,149	\$1,179	\$1,189	\$1,519	\$1,548	\$1,560

Features:

- price reflects complete table - top and base
- ships KD in multiple cartons
- cut out for power is not available on these tables
- width of base foot varies from 22" or 27"
- base has anti-rock glides

HSON

To Order Specify

① Laminate Model #	② Edge Detail	③ Laminate Selection	③a PVC Edge Color	④ Metal Finish
Laminate (NST)	R3 Eased	<b>Standard Laminates (T1)</b> Solid Patterns: ALB Alabaster      DWH Designer White BLK Black          SHD Shadow BBL Bridal Blanco    SLG Slate Grey  Wood Grain Patterns: AGA Aged Ash      GRH Graphite ALL Ale Light      HGL High Line BLO Blonde Echo    OAT Oatmeal Cookie BOL Bourbon Light    PIN Pinnacle Walnut BZW Brazilwood     STU Studio Teak BGL Brighton Light    VIN Vintage CLL Collectors      WLH Walnut Heights FLO Florence Walnut    WEA Weathered Ash	Color: Standard (T1) laminates have a matching PVC. AGA Aged Ash ALB Alabaster ALL Ale Light BLK Black BLO Blonde Echo BOL Bourbon Light BZW Brazilwood BBL Bridal Blanco BGL Brighton Light CLL Collectors DWH Designer White FLO Florence Walnut GRH Graphite HGL High Line OAT Oatmeal Cookie PIN Pinnacle Walnut SHD Shadow SLG Slate Grey STU Studio Teak VIN Vintage WLH Walnut Heights WEA Weathered Ash	BWH Bright White Feet & Post MBK Matte Black Feet & Post PEW Pewter Feet & Post ASLASL Arctic Silver Feet & Post ASLBWH Arctic Silver Feet & Bright White Post ASLMBK Arctic Silver Feet & Matte Black Post ASLPEW Arctic Silver Feet & Pewter Post
	K9 Reverse Bevel			

Model Number Breakdown

NST3636-36SQS					
NS	T	3636	36	SQ	S
Nosh	Laminate	36" x 36"	Height	Square Top Shape	Square Disc Base

Description

Square Counter Height Table  
with Square Disc Base  
(continued)

Veneer Tables  
"NSV" Models

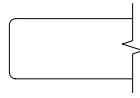

Eased Edge (R3)

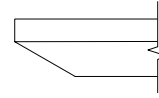

Reverse Bevel Edge (K9)

VENEER	D	W	H	CTN WT	CU FT	1 Model	Flat Cut	Double Cut	Flat Cut	Double Cut
	42	42	36	145	20	NSV4242-36SQS	\$1,724	\$1,909	\$1,790	\$1,910
36	36	36	107	17	NSV3636-36SQS	\$1,522	\$1,680	\$1,581	\$1,684	
30	30	36	93	13	NSV3030-36SQS	\$1,453	\$1,598	\$1,507	\$1,607	

NOSH

To Order Specify

1 Veneer Model #	2 Edge Detail	3 Wood Species	4 Wood Finish	5 Metal Finish		
Veneer (NSV)	R3 Eased K9 Reverse Bevel	<b>Flat Cut</b> CH1 Cherry MA1 Maple WA1 Walnut	Cherry: BRL Barley BBM Bourbon Medium BRM Brighton Medium CLA Classic CLL Collectors* EAR Earthy HRV Harvest* LGC Legacy PRL Praline* SAF Saffron	Maple: ALM Ale Medium BUT Butterscotch CIN Cinnamon FLX Flax VEN Venetian	Walnut: AUB Auburn ESP Espresso MCH Mocha* NTO Night Owl* SIE Sienna* TOF Toffee TRF Truffle*	BWH Bright White Feet & Post MBK Matte Black Feet & Post PEW Pewter Feet & Post ASLACL Arctic Silver Feet & Post ASLBWH Arctic Silver Feet & Bright White Post ASLMBK Arctic Silver Feet & Matte Black Post ASLPEW Arctic Silver Feet & Pewter Post
	DC2 Double Cut	<b>Double Cut</b> DC2 Double Cut	<b>4 Wood Finish</b> Double Cut: COF Coffee FOS Fossil KHK Khaki CRM Cremello GRH Graphite STU Studio Teak			



Description

Rounded Square Counter Height Table with Square Disc Base

Laminate Tables "NST" Models

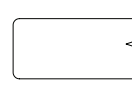
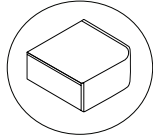
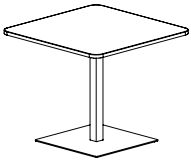

Eased Edge (R3)

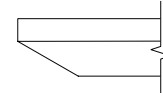

Reverse Bevel (K9)

LAMINATE	D	W	H	CTN WT	CU FT	① Model	Eased Edge (R3)			Reverse Bevel (K9)		
							Standard	Graded In		Standard	Graded In	
							Tier 1	Tier 2	Tier 3	Tier 1	Tier 2	Tier 3
	42	42	36	145	20	NST4242-36SQRS	\$1,643	\$1,686	\$1,764	\$2,013	\$2,057	\$2,134
	36	36	36	107	17	NST3636-36SQRS	\$1,373	\$1,410	\$1,462	\$1,742	\$1,779	\$1,831
	30	30	36	93	13	NST3030-36SQRS	\$1,299	\$1,330	\$1,361	\$1,670	\$1,699	\$1,732

Features:

- bases are cast aluminum feet with 2 5/8" - 14 gauge round
- ships KD in multiple cartons
- cut out for power is not available on these tables
- base has anti-rock glides
- width of base foot varies from 22" or 27"

HSON

To Order Specify

① Laminate Model #	② Edge Detail	③ Laminate Selection	③a PVC Edge Color	④ Metal Finish
Laminate (NST)	R3 Eased	<b>Standard Laminates (T1)</b> Solid Patterns: ALB Alabaster      DWH Designer White BLK Black          SHD Shadow BBL Bridal Blanco    SLG Slate Grey  Wood Grain Patterns: AGA Aged Ash      GRH Graphite ALL Ale Light      HGL High Line BLO Blonde Echo    OAT Oatmeal Cookie BOL Bourbon Light    PIN Pinnacle Walnut BZW Brazilwood     STU Studio Teak BGL Brighton Light    VIN Vintage CLL Collectors      WLH Walnut Heights FLO Florence Walnut    WEA Weathered Ash	Color: Standard (T1) laminates have a matching PVC. AGA Aged Ash ALB Alabaster ALL Ale Light BLK Black BLO Blonde Echo BOL Bourbon Light BZW Brazilwood BBL Bridal Blanco BGL Brighton Light CLL Collectors DWH Designer White FLO Florence Walnut GRH Graphite HGL High Line OAT Oatmeal Cookie PIN Pinnacle Walnut SHD Shadow SLG Slate Grey STU Studio Teak VIN Vintage WLH Walnut Heights WEA Weathered Ash	BWH Bright White Feet & Post MBK Matte Black Feet & Post PEW Pewter Feet & Post ASLASL Arctic Silver Feet & Post ASLBWH Arctic Silver Feet & Bright White Post ASLMBK Arctic Silver Feet & Matte Black Post ASLPEW Arctic Silver Feet & Pewter Post
	K9 Reverse Bevel			

Model Number Breakdown

NSS4242-36SQRS						
NS	S	4242	36	SQ	R	S
Nosh	Solid Surfaced	42" x 42"	Height	Square Top Shape	Rounded Corner	Square Disc Base

Description

Rounded Square Counter Height Table with Square Disc Base (continued)

Veneer Tables "NSV" Models      Solid Surface Tables "NSS" Models

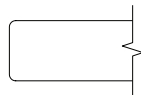

Eased Edge (R3)

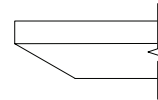

Reverse Bevel Edge (K9)

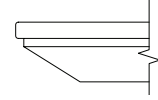

Reverse Bevel Edge (S7)

	D	W	H	CTN WT	CU FT	① Model	Eased Edge (R3)		Reverse Bevel Edge (K9)		Standard
							Flat Cut	Double Cut	Flat Cut	Double Cut	
VENEER	42	42	36	145	20	NSV4242-36SQRS	\$2,106	\$2,247	\$2,188	\$2,333	--
	36	36	36	107	17	NSV3636-36SQRS	\$1,914	\$2,043	\$1,988	\$2,122	--
	30	30	36	93	13	NSV3030-36SQRS	\$1,816	\$1,939	\$1,886	\$2,012	--
SOL SURF	42	42	36	174	20	NSS4242-36SQRS	--	--	--	--	\$4,025
	36	36	36	118	17	NSS3636-36SQRS	--	--	--	--	\$3,427
	30	30	36	90	13	NSS3030-36SQRS	--	--	--	--	\$2,983

NOSH

To Order Specify

① Veneer Model #	② Edge Detail	③ Wood Species	④ Wood Finish	⑤ Metal Finish	
Veneer (NSV)	R3 Eased K9 Reverse Bevel	<b>Flat Cut</b> CH1 Cherry MA1 Maple WA1 Walnut	Cherry: BRL Barley BBM Bourbon Medium BRM Brighton Medium CLA Classic CLL Collectors* EAR Earthy HRV Harvest* LGC Legacy PRL Praline* SAF Saffron	Maple: ALM Ale Medium BUT Butterscotch CIN Cinnamon FLX Flax VEN Venetian Walnut: AUB Auburn ESP Espresso MCH Mocha* NTO Night Owl* SIE Sienna* TOF Toffee TRF Truffle* *finishes with coordinating laminate tops	BWH Bright White Feet & Post MBK Matte Black Feet & Post PEW Pewter Feet & Post ASLASL Arctic Silver Feet & Post ASLBWH Arctic Silver Feet & Bright White Post ASLMBK Arctic Silver Feet & Matte Black Post ASLPEW Arctic Silver Feet & Pewter Post
	<b>Double Cut</b> DC2 Double Cut	<b>④ Wood Finish</b> Double Cut: COF Coffee    FOS Fossil    KHK Khaki CRM Cremello    GRH Graphite    STU Studio Teak			

① Solid Surface Model #	② Edge Detail	③ Solid Surface	④ Metal Finish
Solid Surface (NSS)	S7 Reverse Bevel	<b>Tier 1</b> ARM Armadillo BLP Black Pearl GRA Graphite Granite PEB Pebble Pearl PUR Pure White	BWH Bright White Feet & Post MBK Matte Black Feet & Post PEW Pewter Feet & Post ASLASL Arctic Silver Feet & Post ASLBWH Arctic Silver Feet & Bright White Post ASLMBK Arctic Silver Feet & Matte Black Post ASLPEW Arctic Silver Feet & Pewter Post

Description

Squiracle Counter Height Table with X Base



Laminate Tables  
"NST" Models

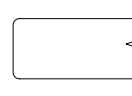

Eased Edge (R3)

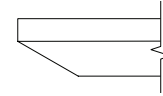

Reverse Bevel Edge (K9)

LAMINATE	D	W	H	CTN WT	CU FT	① Model	Eased Edge (R3)			Reverse Bevel Edge (K9)		
							Standard	Graded In		Standard	Graded In	
							Tier 1	Tier 2	Tier 3	Tier 1	Tier 2	Tier 3
	42	42	36	74	21	NST42-36SCX	\$1,272	\$1,368	\$1,446	\$1,642	\$1,738	\$1,816
	36	36	36	60	18	NST36-36SCX	\$1,233	\$1,269	\$1,325	\$1,604	\$1,639	\$1,695
	30	30	36	48	16	NST30-36SCX	\$1,192	\$1,220	\$1,252	\$1,562	\$1,590	\$1,624

Features:

- price reflects complete table - top and base
- ships KD in multiple cartons
- top has option for cutout to receive electrical component, ordered separately
- when electrical cut out selected, power accessible base is sent - add \$95
- base has leveling glides
- width of base foot varies from 26" or 32"

HSON

To Order Specify

① Laminate Model #	② Edge Detail	③ Laminate Selection	③a PVC Edge Color	④ Electrical Cut Out	⑤ Metal Finish
Laminate (NST)	R3 Eased	<b>Standard Laminates (T1)</b> Solid Patterns: ALB Alabaster      DWH Designer White BLK Black          SHD Shadow BBL Bridal Blanco    SLG Slate Grey  Wood Grain Patterns: AGA Aged Ash      GRH Graphite ALL Ale Light      HGL High Line BLO Blonde Echo    OAT Oatmeal Cookie BOL Bourbon Light    PIN Pinnacle Walnut BZW Brazilwood      STU Studio Teak BGL Brighton Light    VIN Vintage CLL Collectors        WLH Walnut Heights FLO Florence Walnut    WEA Weathered Ash	Color: <b>Standard (T1) laminates</b> have a matching PVC. AGA Aged Ash ALB Alabaster ALL Ale Light BLK Black BLO Blonde Echo BOL Bourbon Light BZW Brazilwood BBL Bridal Blanco BGL Brighton Light CLL Collectors DWH Designer White FLO Florence Walnut GRH Graphite HGL High Line OAT Oatmeal Cookie PIN Pinnacle Walnut SHD Shadow SLG Slate Grey STU Studio Teak VIN Vintage WLH Walnut Heights WEA Weathered Ash	N None COB_EC23 Cut out for EC23 COB_EC24 Cut out for EC24	BWH Bright White Feet & Post MBK Matte Black Feet & Post PEW Pewter Feet & Post ASLASL Arctic Silver Feet & Post ASLBWH Arctic Silver Feet & Bright White Post ASLMBK Arctic Silver Feet & Matte Black Post ASLPEW Arctic Silver Feet & Pewter Post PAMASL Polished Aluminum Feet & Arctic Silver Post PAMBWH Polished Aluminum Feet & Bright White Post PAMMBK Polished Aluminum Feet & Matte Black Post PAMPEW Polished Aluminum Feet & Pewter Post
	K9 Reverse Bevel				

Model Number Breakdown

NSS42-36SCX					
NS	S	42	36	SC	X
Nosh	Solid Surface	42"	Height	Squiracle Top Shape	X Base

Description

Squirrel Counter Height Table with X Base  
(continued)

		Veneer Tables "NSV" Models				Solid Surface Tables "NSS" Models					
		Eased Edge (R3)		Reverse Bevel Edge (K9)		Reverse Bevel Edge (S7)					
		Flat Cut	Double Cut	Flat Cut	Double Cut	Standard					
	D	W	H	CTN WT	CU FT	① Model	Flat Cut	Double Cut	Flat Cut	Double Cut	Standard
VENEER	42	42	36	74	21	NSV42-36SCX	\$1,668	\$1,777	\$1,732	\$1,845	--
	36	36	36	60	18	NSV36-36SCX	\$1,616	\$1,722	\$1,679	\$1,789	--
	30	30	36	48	16	NSV30-36SCX	\$1,560	\$1,661	\$1,619	\$1,725	--
SOL SURF	42	42	36	96	21	NSS42-36SCX	--	--	--	--	\$3,600
	36	36	36	76	18	NSS36-36SCX	--	--	--	--	\$3,144
	30	30	36	59	16	NSS30-36SCX	--	--	--	--	\$3,033

NOSH

To Order Specify

① Veneer Model #	② Edge Detail	③ Wood Species	④ Wood Finish	⑤ Electrical Cut Out	⑥ Metal Finish		
Veneer (NSV)	R3 Eased K9 Reverse Bevel	<b>Flat Cut</b> CH1 Cherry MA1 Maple WA1 Walnut	Cherry: BRL Barley BBM Bourbon Medium BRM Brighton Medium CLA Classic CLL Collectors* EAR Earthy HRV Harvest* LGC Legacy PRL Praline* SAF Saffron	Maple: ALM Ale Medium BUT Butterscotch CIN Cinnamon FLX Flax VEN Venetian	Walnut: AUB Auburn ESP Espresso MCH Mocha* NTO Night Owl* SIE Sienna* TOF Toffee TRF Truffle*	N None COB_EC23 Cut out for EC23 COB_EC24 Cut out for EC24	BWH Bright White Feet & Post MBK Matte Black Feet & Post PEW Pewter Feet & Post ASLASL Arctic Silver Feet & Post ASLBWH Arctic Silver Feet & Bright White Post ASLMBK Arctic Silver Feet & Matte Black Post ASLPEW Arctic Silver Feet & Pewter Post PAMASL Polished Aluminum Feet & Arctic Silver Post PAMBWH Polished Aluminum Feet & Bright White Post PAMMBK Polished Aluminum Feet & Matte Black Post PAMPEW Polished Aluminum Feet & Pewter Post
		<b>Double Cut</b> DC2 Double Cut	<b>④ Wood Finish</b> Double Cut: COF Coffee FOS Fossil KHK Khaki CRM Cremello GRH Graphite STU Studio Teak				

① Solid Surface Model #	② Edge Detail	③ Solid Surface	④ Electrical Cut Out	⑤ Metal Finish
Solid Surface (NSS)	S7 Reverse Bevel	<b>Tier 1</b> ARM Armadillo BLP Black Pearl GRA Graphite Granite PEB Pebble Pearl PUR Pure White	N None COB_EC23 Cut out for EC23 COB_EC24 Cut out for EC24	BWH Bright White Feet & Post MBK Matte Black Feet & Post PEW Pewter Feet & Post ASLASL Arctic Silver Feet & Post ASLBWH Arctic Silver Feet & Bright White Post ASLMBK Arctic Silver Feet & Matte Black Post ASLPEW Arctic Silver Feet & Pewter Post PAMASL Polished Aluminum Feet & Arctic Silver Post PAMBWH Polished Aluminum Feet & Bright White Post PAMMBK Polished Aluminum Feet & Matte Black Post PAMPEW Polished Aluminum Feet & Pewter Post

Description

Squircle Counter Height Table with X4 Base

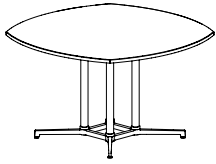

Laminate Tables  
"NST" Models

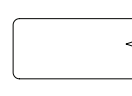

Eased Edge (R3)

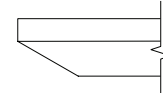

Reverse Bevel Edge (K9)

LAMINATE	D	W	H	CTN WT	CU FT	① Model	Standard			Graded In		
							Tier 1	Tier 2	Tier 3	Tier 1	Tier 2	Tier 3
	60	60	36	154	48	NST60-36SCZ	\$2,293	\$2,369	\$2,539	\$2,664	\$2,739	\$2,909
	54	54	36	105	26	NST54-36SCZ	\$2,143	\$2,201	\$2,260	\$2,514	\$2,573	\$2,631
	48	48	36	88	25	NST48-36SCZ	\$2,037	\$2,133	\$2,239	\$2,407	\$2,503	\$2,610

Features:

- price reflects complete table - top and base
- ships KD in multiple cartons
- base has leveling glides
- top has option for cut out to receive electrical component, order separately
- optional vertical wire manager for base, order separately
- width of base foot is 38"

HSON

To Order Specify

① Laminate Model #	② Edge Detail	③ Laminate Selection	③a PVC Edge Color	④ Electrical Cut Out	⑤ Metal Finish
Laminate (NST)	R3 Eased K9 Reverse Bevel	<b>Standard Laminates (T1)</b> Solid Patterns: ALB Alabaster      DWH Designer White BLK Black          SHD Shadow BBL Bridal Blanco    SLG Slate Grey  Wood Grain Patterns: AGA Aged Ash      GRH Graphite ALL Ale Light      HGL High Line BLO Blonde Echo    OAT Oatmeal Cookie BOL Bourbon Light    PIN Pinnacle Walnut BZW Brazilwood      STU Studio Teak BGL Brighton Light    VIN Vintage CLL Collectors        WLH Walnut Heights FLO Florence Walnut    WEA Weathered Ash	Color: Standard (T1) laminates have a matching PVC. AGA Aged Ash ALB Alabaster ALL Ale Light BLK Black BLO Blonde Echo BOL Bourbon Light BZW Brazilwood BBL Bridal Blanco BGL Brighton Light CLL Collectors DWH Designer White FLO Florence Walnut GRH Graphite HGL High Line OAT Oatmeal Cookie PIN Pinnacle Walnut SHD Shadow SLG Slate Grey STU Studio Teak VIN Vintage WLH Walnut Heights WEA Weathered Ash	N None CO_EC23 Cut out for EC23 CO_EC24 Cut out for EC24	BWH Bright White Feet & Post MBK Matte Black Feet & Post PEW Pewter Feet & Post ASLASL Arctic Silver Feet & Post ASLBWH Arctic Silver Feet & Bright White Post ASLMBK Arctic Silver Feet & Matte Black Post ASLPEW Arctic Silver Feet & Pewter Post PAMASL Polished Aluminum Feet & Arctic Silver Post PAMBWH Polished Aluminum Feet & Bright White Post PAMMBK Polished Aluminum Feet & Matte Black Post PAMPEW Polished Aluminum Feet & Pewter Post
		Graded-In Laminates (T2) & (T3) see pages 156-161	PVC color must be selected with Graded-In Laminates (T2) & (T3)		

Model Number Breakdown

NST54-36SCZ					
NS	T	54	36	SC	Z
Nosh	Laminate	54"	Height	Squircle Top Shape	X4 Base

Description

Squirrle Counter Height Table with X4 Base  
(continued)

Veneer Tables "NSV" Models      Solid Surface Tables "NSS" Models

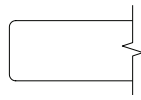

Eased Edge (R3)

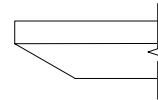

Reverse Bevel Edge (K9)

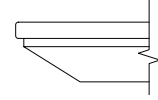

Reverse Bevel Edge (S7)

	D	W	H	CTN WT	CU FT	① Model	Eased Edge (R3)		Reverse Bevel Edge (K9)		Reverse Bevel Edge (S7) Standard
							Flat Cut	Double Cut	Flat Cut	Double Cut	
VENEER	60	60	36	154	48	NSV60-36SCZ	\$2,999	\$3,194	\$3,112	\$3,315	--
	54	54	36	105	26	NSV54-36SCZ	\$2,834	\$3,025	\$2,945	\$3,143	--
	48	48	36	88	25	NSV48-36SCZ	\$2,469	\$2,588	\$2,539	\$2,664	--
SOL SURF	60	60	36	202	48	NSS60-36SCZ	--	--	--	--	\$6,525
	54	54	36	143	26	NSS54-36SCZ	--	--	--	--	\$5,768
	48	48	36	118	25	NSS48-36SCZ	--	--	--	--	\$4,872

NOSH

To Order Specify

① Veneer Model #	② Edge Detail	③ Wood Species	④ Wood Finish	⑤ Electrical Cut Out	⑥ Metal Finish
Veneer (NSV)	R3 Eased K9 Reverse Bevel	<b>Flat Cut</b> CH1 Cherry MA1 Maple WA1 Walnut	Cherry: BRL Barley BBM Bourbon Medium BRM Brighton Medium CLA Classic CLL Collectors* EAR Earthy HRV Harvest* LGC Legacy PRL Praline* SAF Saffron  Maple: ALM Ale Medium BUT Butterscotch CIN Cinnamon FLX Flax VEN Venetian  Walnut: AUB Auburn ESP Espresso MCH Mocha* NTO Night Owl* SIE Sienna* TOF Toffee* TRF Truffle*  *finishes with coordinating laminate tops	N None CO_EC23 Cut out for EC23 CO_EC24 Cut out for EC24	BWH Bright White Feet & Post MBK Matte Black Feet & Post PEW Pewter Feet & Post ASLASL Arctic Silver Feet & Post ASLBWH Arctic Silver Feet & Bright White Post ASLMBK Arctic Silver Feet & Matte Black Post ASLPEW Arctic Silver Feet & Pewter Post PAMASL Polished Aluminum Feet & Arctic Silver Post PAMBWH Polished Aluminum Feet & Bright White Post PAMMBK Polished Aluminum Feet & Matte Black Post PAMPEW Polished Aluminum Feet & Pewter Post
		<b>Double Cut</b> DC2 Double Cut	<b>④ Wood Finish</b> Double Cut: COF Coffee FOS Fossil KHK Khaki CRM Cremello GRH Graphite STU Studio Teak		

① Solid Surface Model #	② Edge Detail	③ Solid Surface	④ Electrical Cut Out	⑤ Metal Finish
Solid Surface (NSS)	S7 Reverse Bevel	<b>Tier 1</b> ARM Armadillo BLP Black Pearl GRA Graphite Granite PEB Pebble Pearl PUR Pure White	N None CO_EC23 Cut out for EC23 CO_EC24 Cut out for EC24	BWH Bright White Feet & Post MBK Matte Black Feet & Post PEW Pewter Feet & Post ASLASL Arctic Silver Feet & Post ASLBWH Arctic Silver Feet & Bright White Post ASLMBK Arctic Silver Feet & Matte Black Post ASLPEW Arctic Silver Feet & Pewter Post PAMASL Polished Aluminum Feet & Arctic Silver Post PAMBWH Polished Aluminum Feet & Bright White Post PAMMBK Polished Aluminum Feet & Matte Black Post PAMPEW Polished Aluminum Feet & Pewter Post

Description

Squircle Counter Height Table with Round Disc Base

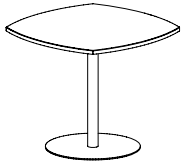

Laminate Tables  
"NST" Models

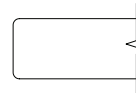

Eased Edge (R3)

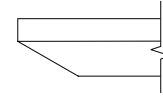

Reverse Bevel Edge (K9)

LAMINATE	D	W	H	CTN WT	CU FT	① Model	Eased Edge (R3)			Reverse Bevel Edge (K9)		
							Standard	Graded In		Standard	Graded In	
							Tier 1	Tier 2	Tier 3	Tier 1	Tier 2	Tier 3
	42	42	36	117	20	NST42-36SCR	\$1,449	\$1,494	\$1,570	\$1,820	\$1,865	\$1,942
	36	36	36	86	17	NST36-36SCR	\$1,242	\$1,279	\$1,332	\$1,611	\$1,648	\$1,701
	30	30	36	64	15	NST30-36SCR	\$1,069	\$1,100	\$1,133	\$1,440	\$1,470	\$1,503

Features:

- price reflects complete table - top and base
- ships KD in multiple cartons
- cut out for power is not available on these tables
- base has anti-rock glides
- width of base foot varies from 22" or 27"

HSON

To Order Specify

① Laminate Model #	② Edge Detail	③ Laminate Selection	③a PVC Edge Color	④ Metal Finish
Laminate (NST)	R3 Eased	<b>Standard Laminates (T1)</b> Solid Patterns: ALB Alabaster      DWH Designer White BLK Black          SHD Shadow BBL Bridal Blanco    SLG Slate Grey  Wood Grain Patterns: AGA Aged Ash      GRH Graphite ALL Ale Light      HGL High Line BLO Blonde Echo    OAT Oatmeal Cookie BOL Bourbon Light    PIN Pinnacle Walnut BZW Brazilwood      STU Studio Teak BGL Brighton Light    VIN Vintage CLL Collectors      WLH Walnut Heights FLO Florence Walnut    WEA Weathered Ash	Color: Standard (T1) laminates have a matching PVC. AGA Aged Ash ALB Alabaster ALL Ale Light BLK Black BLO Blonde Echo BOL Bourbon Light BZW Brazilwood BBL Bridal Blanco BGL Brighton Light CLL Collectors DWH Designer White FLO Florence Walnut GRH Graphite HGL High Line OAT Oatmeal Cookie PIN Pinnacle Walnut SHD Shadow SLG Slate Grey STU Studio Teak VIN Vintage WLH Walnut Heights WEA Weathered Ash	BWH Bright White Feet & Post MBK Matte Black Feet & Post PEW Pewter Feet & Post ASLASL Arctic Silver Feet & Post ASLBWH Arctic Silver Feet & Bright White Post ASLMBK Arctic Silver Feet & Matte Black Post ASLPEW Arctic Silver Feet & Pewter Post
	K9 Reverse Bevel			

Model Number Breakdown

NSV42-36SCR					
NS	V	42	36	SC	R
Nosh	Veneer	42"	Height	Squircle Top Shape	Round Disc Base

Description

Squirrel Counter Height Table with Round Disc Base (continued)

		Veneer Tables "NSV" Models				Solid Surface Tables "NSS" Models					
		Eased Edge (R3)		Reverse Bevel Edge (K9)		Reverse Bevel Edge (S7)					
		Flat Cut	Double Cut	Flat Cut	Double Cut	Standard					
	D	W	H	CTN WT	CU FT	1 Model	Flat Cut	Double Cut	Flat Cut	Double Cut	Standard
VENEER	42	42	36	117	20	NSV42-36SCR	\$1,906	\$2,031	\$1,979	\$2,110	--
	36	36	36	86	17	NSV36-36SCR	\$1,628	\$1,735	\$1,691	\$1,802	--
	30	30	36	64	15	NSV30-36SCR	\$1,397	\$1,488	\$1,451	\$1,545	--
SOL SURF	42	42	36	140	20	NSS42-36SCR	--	--	--	--	\$3,839
	36	36	36	103	17	NSS36-36SCR	--	--	--	--	\$3,156
	30	30	36	75	15	NSS30-36SCR	--	--	--	--	\$2,704

To Order Specify

1 Veneer Model #	2 Edge Detail	3 Wood Species	4 Wood Finish	5 Metal Finish		
Veneer (NSV)	R3 Eased K9 Reverse Bevel	<b>Flat Cut</b> CH1 Cherry MA1 Maple WA1 Walnut	Cherry: BRL Barley BBM Bourbon Medium BRM Brighton Medium CLA Classic CLL Collectors* EAR Earthy HRV Harvest* LGC Legacy PRL Praline* SAF Saffron	Maple: ALM Ale Medium BUT Butterscotch CIN Cinnamon FLX Flax VEN Venetian	Walnut: AUB Auburn ESP Espresso MCH Mocha* NTO Night Owl* SIE Sienna* TOF Toffee TRF Truffle*	BWH Bright White Feet & Post MBK Matte Black Feet & Post PEW Pewter Feet & Post ASLASL Arctic Silver Feet & Post ASLBWH Arctic Silver Feet & Bright White Post ASLMBK Arctic Silver Feet & Matte Black Post ASLPEW Arctic Silver Feet & Pewter Post
		<b>Double Cut</b> DC2 Double Cut	<b>4 Wood Finish</b> Double Cut: COF Coffee FOS Fossil KHK Khaki CRM Cremello GRH Graphite STU Studio Teak			

1 Solid Surface Model #	2 Edge Detail	3 Solid Surface	4 Metal Finish
Solid Surface (NSS)	S7 Reverse Bevel	<b>Tier 1</b> ARM Armadillo BLP Black Pearl GRA Graphite Granite PEB Pebble Pearl PUR Pure White	BWH Bright White Feet & Post MBK Matte Black Feet & Post PEW Pewter Feet & Post ASLASL Arctic Silver Feet & Post ASLBWH Arctic Silver Feet & Bright White Post ASLMBK Arctic Silver Feet & Matte Black Post ASLPEW Arctic Silver Feet & Pewter Post



Description

Squirle Counter Height Table with Square Disc Base

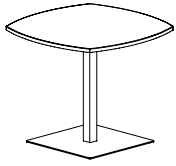

Laminate Tables  
"NST" Models

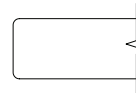

Eased Edge (R3)

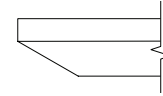

Reverse Bevel Edge (K9)

LAMINATE	D	W	H	CTN WT	CU FT	① Model	Eased Edge (R3)			Reverse Bevel Edge (K9)		
							Standard	Graded In		Standard	Graded In	
							Tier 1	Tier 2	Tier 3	Tier 1	Tier 2	Tier 3
	42	42	36	132	20	NST42-36SCS	\$1,630	\$1,675	\$1,751	\$2,001	\$2,045	\$2,123
	36	36	36	98	17	NST36-36SCS	\$1,368	\$1,404	\$1,457	\$1,737	\$1,773	\$1,827
	30	30	36	69	15	NST30-36SCS	\$1,195	\$1,225	\$1,257	\$1,565	\$1,596	\$1,628

Features:

- price reflects complete table - top and base
- ships KD in multiple cartons
- cut out for power is not available on these tables
- base has anti-rock glides
- width of base foot varies from 17" to 27"

HSON

To Order Specify

① Laminate Model #	② Edge Detail	③ Laminate Selection	③a PVC Edge Color	④ Metal Finish
Laminate (NST)	R3 Eased	<b>Standard Laminates (T1)</b> Solid Patterns: ALB Alabaster      DWH Designer White BLK Black          SHD Shadow BBL Bridal Blanco    SLG Slate Grey  Wood Grain Patterns: AGA Aged Ash      GRH Graphite ALL Ale Light      HGL High Line BLO Blonde Echo    OAT Oatmeal Cookie BOL Bourbon Light    PIN Pinnacle Walnut BZW Brazilwood      STU Studio Teak BGL Brighton Light    VIN Vintage CLL Collectors        WLH Walnut Heights FLO Florence Walnut    WEA Weathered Ash	Color: Standard (T1) laminates have a matching PVC. AGA Aged Ash ALB Alabaster ALL Ale Light BLK Black BLO Blonde Echo BOL Bourbon Light BZW Brazilwood BBL Bridal Blanco BGL Brighton Light CLL Collectors DWH Designer White FLO Florence Walnut GRH Graphite HGL High Line OAT Oatmeal Cookie PIN Pinnacle Walnut SHD Shadow SLG Slate Grey STU Studio Teak VIN Vintage WLH Walnut Heights WEA Weathered Ash	BWH Bright White Feet & Post MBK Matte Black Feet & Post PEW Pewter Feet & Post ASLASL Arctic Silver Feet & Post ASLBWH Arctic Silver Feet & Bright White Post ASLMBK Arctic Silver Feet & Matte Black Post ASLPEW Arctic Silver Feet & Pewter Post
	K9 Reverse Bevel			

Model Number Breakdown

NST36-36SCS					
NS	T	36	36	SC	S
Nosh	Laminate	36"	Height	Squirle Top Shape	Square Disc Base

Description

Squirrel Counter Height Table with Square Disc Base (continued)

Veneer Tables "NSV" Models      Solid Surface Tables "NSS" Models

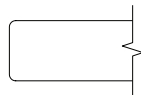

Eased Edge (R3)

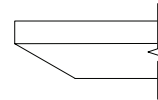

Reverse Bevel Edge (K9)

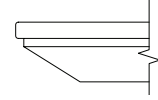

Reverse Bevel Edge (S7)

	D	W	H	CTN WT	CU FT	① Model	Eased Edge (R3)		Reverse Bevel Edge (K9)		Standard
							Flat Cut	Double Cut	Flat Cut	Double Cut	
VENEER	42	42	36	132	20	NSV42-36SCS	\$2,147	\$2,290	\$2,231	\$2,380	--
	36	36	36	98	17	NSV36-36SCS	\$1,796	\$1,914	\$1,866	\$1,989	--
	30	30	36	69	15	NSV30-36SCS	\$1,564	\$1,667	\$1,625	\$1,732	--
SOL SURF	42	42	36	155	20	NSS42-36SCS	--	--	--	--	\$4,080
	36	36	36	103	17	NSS36-36SCS	--	--	--	--	\$3,324
	30	30	36	80	15	NSS30-36SCS	--	--	--	--	\$3,041

NOSH

To Order Specify

① Veneer Model #	② Edge Detail	③ Wood Species	④ Wood Finish	⑤ Metal Finish		
Veneer (NSV)	R3 Eased K9 Reverse Bevel	<b>Flat Cut</b> CH1 Cherry MA1 Maple WA1 Walnut	Cherry: BRL Barley BBM Bourbon Medium BRM Brighton Medium CLA Classic CLL Collectors* EAR Earthy HRV Harvest* LGC Legacy PRL Praline* SAF Saffron	Maple: ALM Ale Medium BUT Butterscotch CIN Cinnamon FLX Flax VEN Venetian	Walnut: AUB Auburn ESP Espresso MCH Mocha* NTO Night Owl* SIE Sienna* TOF Toffee TRF Truffle*	BWH Bright White Feet & Post MBK Matte Black Feet & Post PEW Pewter Feet & Post ASLASL Arctic Silver Feet & Post ASLBWH Arctic Silver Feet & Bright White Post ASLMBK Arctic Silver Feet & Matte Black Post ASLPEW Arctic Silver Feet & Pewter Post
			<b>Double Cut</b> DC2 Double Cut	<b>④ Wood Finish</b> Double Cut: COF Coffee    FOS Fossil    KHK Khaki CRM Cremello    GRH Graphite    STU Studio Teak		

① Solid Surface Model #	② Edge Detail	③ Solid Surface	④ Metal Finish
Solid Surface (NSS)	S7 Reverse Bevel	<b>Tier 1</b> ARM Armadillo BLP Black Pearl GRA Graphite Granite PEB Pebble Pearl PUR Pure White	BWH Bright White Feet & Post MBK Matte Black Feet & Post PEW Pewter Feet & Post ASLASL Arctic Silver Feet & Post ASLBWH Arctic Silver Feet & Bright White Post ASLMBK Arctic Silver Feet & Matte Black Post ASLPEW Arctic Silver Feet & Pewter Post

Description

Rectangular Bar Height Table with T Base

Laminate Tables  
"NST" Models

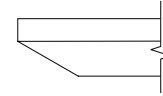
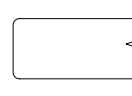
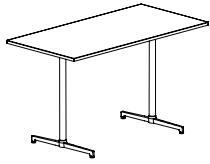

Eased Edge (R3)

Reverse Bevel Edge (K9)

LAMINATE	D	W	H	CTN WT	CU FT	① Model	Eased Edge (R3)			Reverse Bevel Edge (K9)		
							Standard	Graded In		Standard	Graded In	
							Tier 1	Tier 2	Tier 3	Tier 1	Tier 2	Tier 3
	36	72	42	135	63	NST3672-42TTT	\$1,597	\$1,653	\$1,775	\$1,966	\$2,022	\$2,144
	36	66	42	127	58	NST3666-42TTT	\$1,545	\$1,597	\$1,707	\$1,914	\$1,966	\$2,079
	36	60	42	119	46	NST3660-42TTT	\$1,482	\$1,530	\$1,630	\$1,852	\$1,901	\$2,000
	30	72	42	120	61	NST3072-42TTT	\$1,375	\$1,425	\$1,524	\$1,744	\$1,794	\$1,894
	30	66	42	113	35	NST3066-42TTT	\$1,323	\$1,370	\$1,460	\$1,693	\$1,739	\$1,829
	30	60	42	105	36	NST3060-42TTT	\$1,260	\$1,303	\$1,384	\$1,630	\$1,674	\$1,754

Features:

- price reflects complete table - top and base
- ships KD in multiple cartons
- top has option for cut out to receive electrical component, order separately
- optional vertical wire manager for base, order separately
- base has leveling glides
- width of base foot varies from 22" or 33"

HSON

To Order Specify

① Laminate Model #	② Edge Detail	③ Laminate Selection	③a PVC Edge Color	④ Electrical Cut Out	⑤ Metal Finish
Laminate (NST)	R3 Eased K9 Reverse Bevel	<b>Standard Laminates (T1)</b> Solid Patterns: ALB Alabaster      DWH Designer White BLK Black          SHD Shadow BBL Bridal Blanco    SLG Slate Grey  Wood Grain Patterns: AGA Aged Ash      GRH Graphite ALL Ale Light        HGL High Line BLO Blonde Echo    OAT Oatmeal Cookie BOL Bourbon Light    PIN Pinnacle Walnut BZW Brazilwood      STU Studio Teak BGL Brighton Light    VIN Vintage CLL Collectors        WLH Walnut Heights FLO Florence Walnut    WEA Weathered Ash	Color: <b>Standard (T1) laminates</b> have a matching PVC. AGA Aged Ash ALB Alabaster ALL Ale Light BLK Black BLO Blonde Echo BOL Bourbon Light BZW Brazilwood BBL Bridal Blanco BGL Brighton Light CLL Collectors DWH Designer White FLO Florence Walnut GRH Graphite HGL High Line OAT Oatmeal Cookie PIN Pinnacle Walnut SHD Shadow SLG Slate Grey STU Studio Teak VIN Vintage WLH Walnut Heights WEA Weathered Ash	N None CO_EC23 Cut out for EC23 CO_EC24 Cut out for EC24	BWH Bright White Feet & Post MBK Matte Black Feet & Post PEW Pewter Feet & Post ASLASL Arctic Silver Feet & Post ASLBWH Arctic Silver Feet & Bright White Post ASLMBK Arctic Silver Feet & Matte Black Post ASLPEW Arctic Silver Feet & Pewter Post PAMASL Polished Aluminum Feet & Arctic Silver Post PAMBWH Polished Aluminum Feet & Bright White Post PAMMBK Polished Aluminum Feet & Matte Black Post PAMPEW Polished Aluminum Feet & Pewter Post
		Graded-In Laminates (T2) & (T3) see pages 156-161	PVC color must be selected with Graded-In Laminates (T2) & (T3)		

Model Number Breakdown

NSV3672-42TTT					
NS	V	3672	42	TT	T
Nosh	Veneer	36" x 72"	Height	Rectangular Top Shape	T Base

Description

Rectangular Bar Height Table with T Base  
(continued)

Veneer Tables  
"NSV" Models

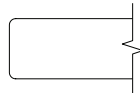

Eased Edge (R3)

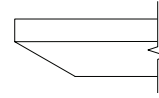

Reverse Bevel Edge (K9)

VENEER	D	W	H	CTN WT	CU FT	1 Model	Eased Edge (R3)		Reverse Bevel Edge (K9)	
							Flat Cut	Double Cut	Flat Cut	Double Cut
	36	72	42	135	63	NSV3672-42TTT	\$1,844	\$2,006	\$1,986	\$2,145
	36	66	42	127	58	NSV3666-42TTT	\$1,808	\$1,960	\$1,945	\$2,094
	36	60	42	119	46	NSV3660-42TTT	\$1,759	\$1,899	\$1,890	\$2,028
	30	72	42	120	61	NSV3072-42TTT	\$1,741	\$1,884	\$1,873	\$2,010
	30	66	42	113	35	NSV3066-42TTT	\$1,694	\$1,827	\$1,820	\$1,949
	30	60	42	105	36	NSV3060-42TTT	\$1,653	\$1,797	\$1,773	\$1,893

NOSH

To Order Specify

1 Veneer Model #	2 Edge Detail	3 Wood Species	4 Wood Finish			5 Electrical Cut Out	6 Metal Finish
Veneer (NSV)	R3 Eased K9 Reverse Bevel	<b>Flat Cut</b> CH1 Cherry MA1 Maple WA1 Walnut	Cherry: BRL Barley BBM Bourbon Medium BRM Brighton Medium CLA Classic CLL Collectors* EAR Earthy HRV Harvest* LGC Legacy PRL Praline* SAF Saffron	Maple: ALM Ale Medium BUT Butterscotch CIN Cinnamon FLX Flax VEN Venetian	Walnut: AUB Auburn ESP Espresso MCH Mocha* NTO Night Owl* SIE Sienna* TOF Toffee TRF Truffle*	N None CO_EC23 Cut out for EC23 CO_EC24 Cut out for EC24	BWH Bright White Feet & Post MBK Matte Black Feet & Post PEW Pewter Feet & Post ASLASL Arctic Silver Feet & Post ASLBWH Arctic Silver Feet & Bright White Post ASLMBK Arctic Silver Feet & Matte Black Post ASLPEW Arctic Silver Feet & Pewter Post PAMASL Polished Aluminum Feet & Arctic Silver Post PAMBWH Polished Aluminum Feet & Bright White Post PAMMBK Polished Aluminum Feet & Matte Black Post PAMPPEW Polished Aluminum Feet & Pewter Post
			<b>Double Cut</b> DC2 Double Cut	<b>4 Wood Finish</b> Double Cut: COF Coffee FOS Fossil KHK Khaki CRM Cremello GRH Graphite STU Studio Teak			

Description

Rounded Rectangular Bar Height Table with T Base

Laminate Tables "NST" Models

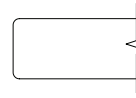
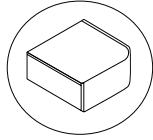
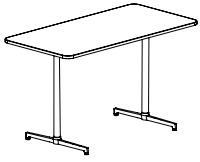

Eased Edge (R3)

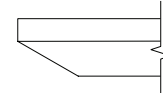

Reverse Bevel (K9)

LAMINATE	D	W	H	CTN WT	CU FT	① Model	Eased Edge (R3)			Reverse Bevel (K9)		
							Standard	Graded In		Standard	Graded In	
							Tier 1	Tier 2	Tier 3	Tier 1	Tier 2	Tier 3
	36	72	42	135	63	NST3672-42TTRT	\$1,572	\$1,624	\$1,721	\$1,943	\$1,993	\$2,090
	36	66	42	127	58	NST3666-42TTRT	\$1,380	\$1,425	\$1,513	\$1,750	\$1,794	\$1,884
	36	60	42	119	46	NST3660-42TTRT	\$1,338	\$1,380	\$1,459	\$1,707	\$1,750	\$1,828
	30	72	42	119	61	NST3072-42TTRT	\$1,536	\$1,586	\$1,683	\$1,906	\$1,955	\$2,052
	30	66	42	112	35	NST3066-42TTRT	\$1,481	\$1,527	\$1,617	\$1,851	\$1,897	\$1,987
	30	60	42	105	36	NST3060-42TTRT	\$1,433	\$1,477	\$1,557	\$1,803	\$1,848	\$1,927

Features:

- price reflects complete table - top and base
- ships KD in multiple cartons
- top has option for cut out to receive electrical component, order separately
- optional vertical wire manager for base, order separately
- base has leveling glides
- width of base foot varies from 22" or 33"

HSON

To Order Specify

① Laminate Model #	② Edge Detail	③ Laminate Selection	③a PVC Edge Color	④ Electrical Cut Out	⑤ Metal Finish
Laminate (NST)	R3 Eased	<b>Standard Laminates (T1)</b> Solid Patterns: ALB Alabaster      DWH Designer White BLK Black          SHD Shadow BBL Bridal Blanco    SLG Slate Grey  Wood Grain Patterns: AGA Aged Ash      GRH Graphite ALL Ale Light      HGL High Line BLO Blonde Echo    OAT Oatmeal Cookie BOL Bourbon Light    PIN Pinnacle Walnut BZW Brazilwood      STU Studio Teak BGL Brighton Light    VIN Vintage CLL Collectors        WLH Walnut Heights FLO Florence Walnut    WEA Weathered Ash	Color: Standard (T1) laminates have a matching PVC. AGA Aged Ash ALB Alabaster ALL Ale Light BLK Black BLO Blonde Echo BOL Bourbon Light BZW Brazilwood BBL Bridal Blanco BGL Brighton Light CLL Collectors DWH Designer White FLO Florence Walnut GRH Graphite HGL High Line OAT Oatmeal Cookie PIN Pinnacle Walnut SHD Shadow SLG Slate Grey STU Studio Teak VIN Vintage WLH Walnut Heights WEA Weathered Ash	N None CO_EC23 Cut out for EC23 CO_EC24 Cut out for EC24	BWH Bright White Feet & Post MBK Matte Black Feet & Post PEW Pewter Feet & Post ASLASL Arctic Silver Feet & Post ASLBWH Arctic Silver Feet & Bright White Post ASLMBK Arctic Silver Feet & Matte Black Post ASLPEW Arctic Silver Feet & Pewter Post PAMASL Polished Aluminum Feet & Arctic Silver Post PAMBWH Polished Aluminum Feet & Bright White Post PAMMBK Polished Aluminum Feet & Matte Black Post PAMPEW Polished Aluminum Feet & Pewter Post
	K9 Reverse Bevel				

Model Number Breakdown

NST3072-42TTRT						
NS	T	3072	42	TT	R	T
Nosh	Laminate	30" x 72"	Height	Rectangular Top Shape	Rounded Corner	T Base

Description

Rounded Rectangular Bar Height Table with T Base (continued)

Veneer Tables "NSV" Models Solid Surface Tables "NSS" Models

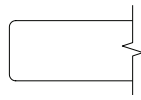

Eased Edge (R3)

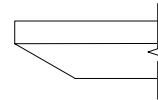

Reverse Bevel Edge (K9)

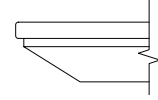

Reverse Bevel Edge (S7)

	D	W	H	CTN WT	CU FT	① Model	Eased Edge (R3)		Reverse Bevel Edge (K9)		Reverse Bevel Edge (S7)
							Flat Cut	Double Cut	Flat Cut	Double Cut	
VENEER	36	72	42	135	63	NSV3672-42TTRT	\$1,972	\$2,143	\$2,043	\$2,203	--
	36	66	42	127	58	NSV3666-42TTRT	\$1,933	\$2,094	\$2,002	\$2,151	--
	36	60	42	119	46	NSV3660-42TTRT	\$1,879	\$2,028	\$1,944	\$2,083	--
	30	72	42	119	61	NSV3072-42TTRT	\$1,856	\$2,006	\$1,920	\$2,059	--
	30	66	42	112	35	NSV3066-42TTRT	\$1,806	\$1,945	\$1,857	\$1,987	--
	30	60	42	105	36	NSV3060-42TTRT	\$1,761	\$1,889	\$1,816	\$1,937	--
SOLID SURFACE	36	72	42	176	63	NSS3672-42TTRT	--	--	--	--	\$4,682
	36	66	42	164	58	NSS3666-42TTRT	--	--	--	--	\$4,456
	36	60	42	145	46	NSS3660-42TTRT	--	--	--	--	\$4,214
	30	72	42	152	61	NSS3072-42TTRT	--	--	--	--	\$4,193
	30	66	42	142	35	NSS3066-42TTRT	--	--	--	--	\$3,985
	30	60	42	125	36	NSS3060-42TTRT	--	--	--	--	\$3,785

HSON

To Order Specify

① Veneer Model #	② Edge Detail	③ Wood Species	④ Wood Finish	⑤ Electrical Cut Out	⑥ Metal Finish		
Veneer (NSV)	R3 Eased K9 Reverse Bevel	<b>Flat Cut</b> CH1 Cherry MA1 Maple WA1 Walnut	Cherry: BRL Barley BBM Bourbon Medium BRM Brighton Medium CLA Classic CLL Collectors* EAR Earthy HRV Harvest* LGC Legacy PRL Praline* SAF Saffron  *finishes with coordinating laminate tops	Maple: ALM Ale Medium BUT Butterscotch CIN Cinnamon FLX Flax VEN Venetian	Walnut: AUB Auburn ESP Espresso MCH Mocha* NTO Night Owl* SIE Sienna* TOF Toffee* TRF Truffle*	N None CO_EC23 Cut out for EC23 CO_EC24 Cut out for EC24	BWH Bright White Feet & Post MBK Matte Black Feet & Post PEW Pewter Feet & Post ASLASL Arctic Silver Feet & Post ASLBWH Arctic Silver Feet & Bright White Post ASLMBK Arctic Silver Feet & Matte Black Post ASLPEW Arctic Silver Feet & Pewter Post PAMASL Polished Aluminum Feet & Arctic Silver Post PAMBWH Polished Aluminum Feet & Bright White Post PAMMBK Polished Aluminum Feet & Matte Black Post PAMPEW Polished Aluminum Feet & Pewter Post
		<b>Double Cut</b> DC2 Double Cut	<b>④ Wood Finish</b> Double Cut: COF Coffee FOS Fossil KHK Khaki CRM Cremello GRH Graphite STU Studio Teak				

① Solid Surface Model #	② Edge Detail	③ Solid Surface	④ Electrical Cut Out	⑤ Metal Finish
Solid Surface (NSS)	S7 Reverse Bevel	<b>Tier 1</b> ARM Armadillo BLP Black Pearl GRA Graphite Granite PEB Pebble Pearl PUR Pure White	N None CO_EC23 Cut out for EC23 CO_EC24 Cut out for EC24	BWH Bright White Feet & Post MBK Matte Black Feet & Post PEW Pewter Feet & Post ASLASL Arctic Silver Feet & Post ASLBWH Arctic Silver Feet & Bright White Post ASLMBK Arctic Silver Feet & Matte Black Post ASLPEW Arctic Silver Feet & Pewter Post PAMASL Polished Aluminum Feet & Arctic Silver Post PAMBWH Polished Aluminum Feet & Bright White Post PAMMBK Polished Aluminum Feet & Matte Black Post PAMPEW Polished Aluminum Feet & Pewter Post

Description

Rectangular Bar Height Table with X Base

Laminate Tables  
"NST" Models

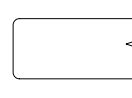
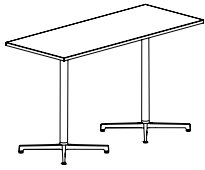

Eased Edge (R3)

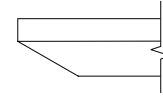

Reverse Bevel Edge (K9)

LAMINATE	D	W	H	CTN WT	CU FT	① Model	Eased Edge (R3)			Reverse Bevel Edge (K9)		
							Standard	Graded In		Standard	Graded In	
							Tier 1	Tier 2	Tier 3	Tier 1	Tier 2	Tier 3
	36	72	42	146	57	NST3672-42TTX	\$2,050	\$2,106	\$2,229	\$2,420	\$2,476	\$2,598
	30	72	42	130	33	NST3072-42TTX	\$1,857	\$1,908	\$2,006	\$2,227	\$2,277	\$2,375

Features:

- price reflects complete table - top and base
- ships KD in multiple cartons
- top has option for cut out to receive electrical component, order separately
- optional vertical wire manager for base, order separately
- base has leveling glides
- width of base foot varies from 26" or 32"

HSON

To Order Specify

① Laminate Model #	② Edge Detail	③ Laminate Selection	③a PVC Edge Color	④ Electrical Cut Out	⑤ Metal Finish
Laminate (NST)	R3 Eased K9 Reverse Bevel	<b>Standard Laminates (T1)</b> Solid Patterns: ALB Alabaster      DWH Designer White BLK Black          SHD Shadow BBL Bridal Blanco    SLG Slate Grey  Wood Grain Patterns: AGA Aged Ash      GRH Graphite ALL Ale Light      HGL High Line BLO Blonde Echo    OAT Oatmeal Cookie BOL Bourbon Light    PIN Pinnacle Walnut BZW Brazilwood      STU Studio Teak BGL Brighton Light    VIN Vintage CLL Collectors        WLH Walnut Heights FLO Florence Walnut    WEA Weathered Ash	Color: Standard (T1) laminates have a matching PVC. AGA Aged Ash ALB Alabaster ALL Ale Light BLK Black BLO Blonde Echo BOL Bourbon Light BZW Brazilwood BBL Bridal Blanco BGL Brighton Light CLL Collectors DWH Designer White FLO Florence Walnut GRH Graphite HGL High Line OAT Oatmeal Cookie PIN Pinnacle Walnut SHD Shadow SLG Slate Grey STU Studio Teak VIN Vintage WLH Walnut Heights WEA Weathered Ash	N None CO_EC23 Cut out for EC23 CO_EC24 Cut out for EC24	BWH Bright White Feet & Post MBK Matte Black Feet & Post PEW Pewter Feet & Post ASLASL Arctic Silver Feet & Post ASLBWH Arctic Silver Feet & Bright White Post ASLMBK Arctic Silver Feet & Matte Black Post ASLPEW Arctic Silver Feet & Pewter Post PAMASL Polished Aluminum Feet & Arctic Silver Post PAMBWH Polished Aluminum Feet & Bright White Post PAMMBK Polished Aluminum Feet & Matte Black Post PAMPEW Polished Aluminum Feet & Pewter Post
		Graded-In Laminates (T2) & (T3) see pages 156-161	PVC color must be selected with Graded-In Laminates (T2) & (T3)		

Model Number Breakdown

NST3060-42TTX					
NS	T	3060	42	TT	X
Nosh	Laminate	30" x 60"	Height	Rectangular Top Shape	X Base

Description

Rectangular Bar Height Table with X Base  
(continued)

Veneer Tables  
"NSV" Models

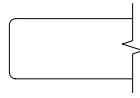

Eased Edge (R3)

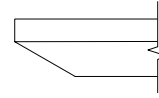

Reverse Bevel Edge (K9)

VENEER	D	W	H	CTN WT	CU FT	1 Model	Flat Cut	Double Cut	Flat Cut	Double Cut
	36	72	42	146	57	NSV3672-42TTX	\$2,298	\$2,460	\$2,440	\$2,599
30	72	42	130	33	NSV3072-42TTX	\$2,223	\$2,366	\$2,355	\$2,493	

NOSH

To Order Specify

1 Veneer Model #	2 Edge Detail	3 Wood Species	4 Wood Finish			5 Electrical Cut Out	6 Metal Finish
Veneer (NSV)	R3 Eased K9 Reverse Bevel	<b>Flat Cut</b> CH1 Cherry MA1 Maple WA1 Walnut	Cherry: BRL Barley BBM Bourbon Medium BRM Brighton Medium CLA Classic CLL Collectors* EAR Earthy HRV Harvest* LGC Legacy PRL Praline* SAF Saffron	Maple: ALM Ale Medium BUT Butterscotch CIN Cinnamon FLX Flax VEN Venetian	Walnut: AUB Auburn ESP Espresso MCH Mocha* NTO Night Owl* SIE Sienna* TOF Toffee TRF Truffle*	N None CO_EC23 Cut out for EC23 CO_EC24 Cut out for EC24	BWH Bright White Feet & Post MBK Matte Black Feet & Post PEW Pewter Feet & Post ASLASL Arctic Silver Feet & Post ASLBWH Arctic Silver Feet & Bright White Post ASLMBK Arctic Silver Feet & Matte Black Post ASLPEW Arctic Silver Feet & Pewter Post PAMASL Polished Aluminum Feet & Arctic Silver Post PAMBWH Polished Aluminum Feet & Bright White Post PAMMBK Polished Aluminum Feet & Matte Black Post PAMPEW Polished Aluminum Feet & Pewter Post
	DC2 Double Cut	<b>4 Wood Finish</b> Double Cut: COF Coffee FOS Fossil KHK Khaki CRM Cremello GRH Graphite STU Studio Teak	*finishes with coordinating laminate tops				



Description

Rounded Rectangular Bar Height Table with X Base

Laminate Tables "NST" Models

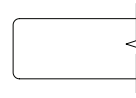
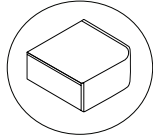
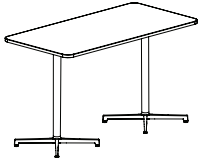

Eased Edge (R3)

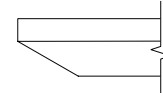

Reverse Bevel (K9)

LAMINATE	D	W	H	CTN WT	CU FT	① Model	Eased Edge (R3)			Reverse Bevel (K9)		
							Standard	Graded In		Standard	Graded In	
							Tier 1	Tier 2	Tier 3	Tier 1	Tier 2	Tier 3
	36	72	42	146	57	NST3672-42TTRX	\$2,132	\$2,189	\$2,309	\$2,501	\$2,558	\$2,678
	30	72	42	129	33	NST3072-42TTRX	\$2,018	\$2,067	\$2,166	\$2,388	\$2,438	\$2,536

Features:

- price reflects complete table - top and base
- ships KD in multiple cartons
- top has option for cut out to receive electrical component, order separately
- optional vertical wire manager for base, order separately
- base has leveling glides
- width of base foot varies from 26" or 32"

HSON

To Order Specify

① Laminate Model #	② Edge Detail	③ Laminate Selection	③a PVC Edge Color	④ Electrical Cut Out	⑤ Metal Finish
Laminate (NST)	R3 Eased K9 Reverse Bevel	<b>Standard Laminates (T1)</b> Solid Patterns: ALB Alabaster      DWH Designer White BLK Black          SHD Shadow BBL Bridal Blanco    SLG Slate Grey  Wood Grain Patterns: AGA Aged Ash      GRH Graphite ALL Ale Light      HGL High Line BLO Blonde Echo    OAT Oatmeal Cookie BOL Bourbon Light    PIN Pinnacle Walnut BZW Brazilwood      STU Studio Teak BGL Brighton Light    VIN Vintage CLL Collectors      WLH Walnut Heights FLO Florence Walnut    WEA Weathered Ash	Color: Standard (T1) laminates have a matching PVC. AGA Aged Ash ALB Alabaster ALL Ale Light BLK Black BLO Blonde Echo BOL Bourbon Light BZW Brazilwood BBL Bridal Blanco BGL Brighton Light CLL Collectors DWH Designer White FLO Florence Walnut GRH Graphite HGL High Line OAT Oatmeal Cookie PIN Pinnacle Walnut SHD Shadow SLG Slate Grey STU Studio Teak VIN Vintage WLH Walnut Heights WEA Weathered Ash	N None CO_EC23 Cut out for EC23 CO_EC24 Cut out for EC24	BWH Bright White Feet & Post MBK Matte Black Feet & Post PEW Pewter Feet & Post ASLASL Arctic Silver Feet & Post ASLBWH Arctic Silver Feet & Bright White Post ASLMBK Arctic Silver Feet & Matte Black Post ASLPEW Arctic Silver Feet & Pewter Post PAMASL Polished Aluminum Feet & Arctic Silver Post PAMBWH Polished Aluminum Feet & Bright White Post PAMMBK Polished Aluminum Feet & Matte Black Post PAMPEW Polished Aluminum Feet & Pewter Post
		Graded-In Laminates (T2) & (T3) see pages 156-161	PVC color must be selected with Graded-In Laminates (T2) & (T3)		

Model Number Breakdown

NST3066-42TTRX						
NS	T	3066	42	TT	R	X
Nosh	Laminate	30" x 66"	Height	Rectangular Top Shape	Rounded Corner	X Base

Description

Rounded Rectangular Bar Height Table  
with X Base  
(continued)

Veneer Tables "NSV" Models	Solid Surface Tables "NSS" Models
-------------------------------	--------------------------------------

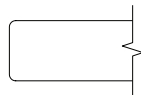

Eased Edge (R3)

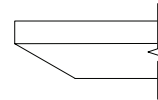

Reverse Bevel Edge (K9)

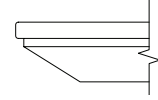

Reverse Bevel Edge (S7)

	D	W	H	CTN WT	CU FT	① Model	Eased Edge (R3)		Reverse Bevel Edge (K9)		Standard
							Flat Cut	Double Cut	Flat Cut	Double Cut	
VENEER	36	72	42	146	57	NSV3672-42TTRX	\$2,454	\$2,625	\$2,525	\$2,687	--
	30	72	42	129	33	NSV3072-42TTRX	\$2,310	\$2,460	\$2,373	\$2,512	--
SOL SURF	36	72	42	179	57	NSS3672-42TTRX	--	--	--	--	\$5,164
	30	72	42	155	33	NSS3072-42TTRX	--	--	--	--	\$4,647

NOSH

To Order Specify

① Veneer Model #	② Edge Detail	③ Wood Species	④ Wood Finish			⑤ Electrical Cut Out	⑥ Metal Finish
Veneer (NSV)	R3 Eased K9 Reverse Bevel	<b>Flat Cut</b> CH1 Cherry MA1 Maple WA1 Walnut	Cherry: BRL Barley BBM Bourbon Medium BRM Brighton Medium CLA Classic CLL Collectors* EAR Earthy HRV Harvest* LGC Legacy PRL Praline* SAF Saffron	Maple: ALM Ale Medium BUT Butterscotch CIN Cinnamon FLX Flax VEN Venetian	Walnut: AUB Auburn ESP Espresso MCH Mocha* NTO Night Owl* SIE Sienna* TOF Toffee* TRF Truffle*	N None CO_EC23 Cut out for EC23 CO_EC24 Cut out for EC24	BWH Bright White Feet & Post MBK Matte Black Feet & Post PEW Pewter Feet & Post ASLASL Arctic Silver Feet & Post ASLBWH Arctic Silver Feet & Bright White Post ASLMBK Arctic Silver Feet & Matte Black Post ASLPEW Arctic Silver Feet & Pewter Post PAMASL Polished Aluminum Feet & Arctic Silver Post PAMBWH Polished Aluminum Feet & Bright White Post PAMMBK Polished Aluminum Feet & Matte Black Post PAMPEW Polished Aluminum Feet & Pewter Post
		<b>Double Cut</b> DC2 Double Cut	<b>④ Wood Finish</b> Double Cut: COF Coffee FOS Fossil KHK Khaki CRM Cremello GRH Graphite STU Studio Teak				

① Solid Surface Model #	② Edge Detail	③ Solid Surface	④ Electrical Cut Out	⑤ Metal Finish
Solid Surface (NSS)	S7 Reverse Bevel	<b>Tier 1</b> ARM Armadillo BLP Black Pearl GRA Graphite Granite PEB Pebble Pearl PUR Pure White	N None CO_EC23 Cut out for EC23 CO_EC24 Cut out for EC24	BWH Bright White Feet & Post MBK Matte Black Feet & Post PEW Pewter Feet & Post ASLASL Arctic Silver Feet & Post ASLBWH Arctic Silver Feet & Bright White Post ASLMBK Arctic Silver Feet & Matte Black Post ASLPEW Arctic Silver Feet & Pewter Post PAMASL Polished Aluminum Feet & Arctic Silver Post PAMBWH Polished Aluminum Feet & Bright White Post PAMMBK Polished Aluminum Feet & Matte Black Post PAMPEW Polished Aluminum Feet & Pewter Post

Description

Rectangular Bar Height Table with Round Disc Base

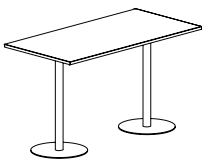

Laminate Tables "NST" Models

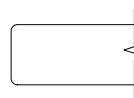

Eased Edge (R3)

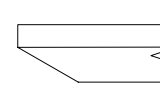

Reverse Bevel Edge (K9)

LAMINATE	D	W	H	CTN WT	CU FT	① Model	Eased Edge (R3)			Reverse Bevel Edge (K9)		
							Standard	Graded In		Standard	Graded In	
							Tier 1	Tier 2	Tier 3	Tier 1	Tier 2	Tier 3
	36	72	42	199	63	NST3672-42TTR	\$2,334	\$2,391	\$2,500	\$2,706	\$2,760	\$2,869
	36	66	42	1191	58	NST3666-42TTR	\$2,204	\$2,269	\$2,369	\$2,576	\$2,639	\$2,738
	36	60	42	182	46	NST3660-42TTR	\$2,125	\$2,186	\$2,274	\$2,495	\$2,556	\$2,643
	30	72	42	160	33	NST3072-42TTR	\$2,127	\$2,188	\$2,275	\$2,497	\$2,557	\$2,644
	30	66	42	153	41	NST3066-42TTR	\$1,939	\$1,997	\$2,075	\$2,308	\$2,366	\$2,445
	30	60	42	146	36	NST3060-42TTR	\$1,875	\$1,930	\$2,000	\$2,244	\$2,300	\$2,369

Features:

- price reflects complete table - top and base
- ships KD in multiple cartons
- top has option for cutout to receive electrical component, ordered separately
- optional vertical wire manager for base, order separately
- base has anti-rock glides
- width of base foot varies from 17" or 22"

HSON

To Order Specify

① Laminate Model #	② Edge Detail	③ Laminate Selection	③a PVC Edge Color	④ Electrical Cut Out	⑤ Metal Finish
Laminate (NST)	R3 Eased	<b>Standard Laminates (T1)</b> Solid Patterns: ALB Alabaster      DWH Designer White BLK Black          SHD Shadow BBL Bridal Blanco    SLG Slate Grey  Wood Grain Patterns: AGA Aged Ash      GRH Graphite ALL Ale Light      HGL High Line BLO Blonde Echo    OAT Oatmeal Cookie BOL Bourbon Light    PIN Pinnacle Walnut BZW Brazilwood      STU Studio Teak BGL Brighton Light    VIN Vintage CLL Collectors        WLH Walnut Heights FLO Florence Walnut    WEA Weathered Ash	Color: Standard (T1) laminates have a matching PVC. AGA Aged Ash ALB Alabaster ALL Ale Light BLK Black BLO Blonde Echo BOL Bourbon Light BZW Brazilwood BBL Bridal Blanco BGL Brighton Light CLL Collectors DWH Designer White FLO Florence Walnut GRH Graphite HGL High Line OAT Oatmeal Cookie PIN Pinnacle Walnut SHD Shadow SLG Slate Grey STU Studio Teak VIN Vintage WLH Walnut Heights WEA Weathered Ash	N None CO_EC23 Cut out for EC23 CO_EC24 Cut out for EC24	BWH Bright White Feet & Post MBK Matte Black Feet & Post PEW Pewter Feet & Post ASLASL Arctic Silver Feet & Post ASLBWH Arctic Silver Feet & Bright White Post ASLMBK Arctic Silver Feet & Matte Black Post ASLPEW Arctic Silver Feet & Pewter Post
	K9 Reverse Bevel				

Model Number Breakdown

NST3660-42TTR					
NS	T	3660	42	TT	R
Nosh	Laminate	36" x 60"	Height	Rectangular Top Shape	Round Disc Base

Description

Rectangular Bar Height Table  
with Round Disc Base  
(continued)

Veneer Tables  
"NSV" Models



Eased Edge (R3)

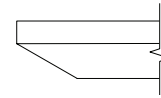

Reverse Bevel Edge (K9)

D	W	H	CTN WT	CU FT	1 Model	Eased Edge (R3)		Reverse Bevel Edge (K9)	
						Flat Cut	Double Cut	Flat Cut	Double Cut
36	72	42	199	63	NSV3672-42TTR	\$2,642	\$2,753	\$2,697	\$2,799
36	66	42	1191	58	NSV3666-42TTR	\$2,559	\$2,661	\$2,623	\$2,713
36	60	42	182	46	NSV3660-42TTR	\$2,482	\$2,572	\$2,542	\$2,621
30	72	42	160	33	NSV3072-42TTR	\$2,455	\$2,616	\$2,512	\$2,663
30	66	42	153	41	NSV3066-42TTR	\$2,269	\$2,372	\$2,321	\$2,415
30	60	42	146	36	NSV3060-42TTR	\$2,210	\$2,304	\$2,259	\$2,345

VENEER

NOSH

To Order Specify

1 Veneer Model #	2 Edge Detail	3 Wood Species	4 Wood Finish			5 Electrical Cut Out	6 Metal Finish
Veneer (NSV)	R3 Eased	Flat Cut CH1 Cherry MA1 Maple WA1 Walnut	Cherry:	Maple:	Walnut:	N None CO_EC23 Cut out for EC23 CO_EC24 Cut out for EC24	BWH Bright White Feet & Post MBK Matte Black Feet & Post PEW Pewter Feet & Post ASLASL Arctic Silver Feet & Post ASLBWH Arctic Silver Feet & Bright White Post ASLMBK Arctic Silver Feet & Matte Black Post ASLPEW Arctic Silver Feet & Pewter Post
	K9 Reverse Bevel		BRL Barley BBM Bourbon Medium BRM Brighton Medium CLA Classic CLL Collectors* EAR Earthy HRV Harvest* LGC Legacy PRL Praline* SAF Saffron	ALM Ale Medium BUT Butterscotch CIN Cinnamon FLX Flax VEN Venetian	AUB Auburn ESP Espresso MCH Mocha* NTO Night Owl* SIE Sienna* TOF Toffee TRF Truffle*		
		Double Cut DC2 Double Cut	4 Wood Finish Double Cut: COF Coffee FOS Fossil KHK Khaki CRM Cremello GRH Graphite STU Studio Teak				

Description

Rounded Rectangular Bar Height Table with Round Disc Base

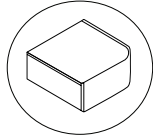
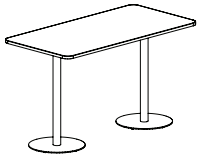

Laminate Tables "NST" Models

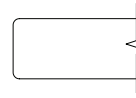

Eased Edge (R3)

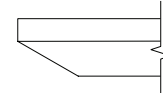

Reverse Bevel (K9)

LAMINATE	D	W	H	CTN WT	CU FT	① Model	Eased Edge (R3)			Reverse Bevel (K9)		
							Standard	Graded In		Standard	Graded In	
							Tier 1	Tier 2	Tier 3	Tier 1	Tier 2	Tier 3
	36	72	42	199	63	NST3672-42TTRR	\$2,539	\$2,611	\$2,717	\$2,908	\$2,981	\$3,086
	36	66	42	193	58	NST3666-42TTRR	\$2,231	\$2,294	\$2,394	\$2,600	\$2,664	\$2,764
	36	60	42	182	46	NST3660-42TTRR	\$2,175	\$2,235	\$2,345	\$2,544	\$2,604	\$2,714
	30	72	42	160	61	NST3072-42TTRR	\$2,210	\$2,270	\$2,356	\$2,579	\$2,640	\$2,727
	30	66	42	153	41	NST3066-42TTRR	\$2,154	\$2,214	\$2,290	\$2,524	\$2,583	\$2,661
	30	60	42	146	36	NST3060-42TTRR	\$2,106	\$2,161	\$2,231	\$2,476	\$2,532	\$2,600

Features:

- price reflects complete table - top and base
- ships KD in multiple cartons
- top has option for cutout to receive electrical component, ordered separately
- optional vertical wire manager for base, order separately
- base has anti-rock glides
- width of base foot varies from 17" or 22"

HSON

To Order Specify

① Laminate Model #	② Edge Detail	③ Laminate Selection	③a PVC Edge Color	④ Electrical Cut Out	⑤ Metal Finish
Laminate (NST)	R3 Eased K9 Reverse Bevel	<b>Standard Laminates (T1)</b> Solid Patterns: ALB Alabaster      DWH Designer White BLK Black          SHD Shadow BBL Bridal Blanco    SLG Slate Grey  Wood Grain Patterns: AGA Aged Ash      GRH Graphite ALL Ale Light      HGL High Line BLO Blonde Echo    OAT Oatmeal Cookie BOL Bourbon Light    PIN Pinnacle Walnut BZW Brazilwood      STU Studio Teak BGL Brighton Light    VIN Vintage CLL Collectors        WLH Walnut Heights FLO Florence Walnut    WEA Weathered Ash	Color: Standard (T1) laminates have a matching PVC. AGA Aged Ash ALB Alabaster ALL Ale Light BLK Black BLO Blonde Echo BOL Bourbon Light BZW Brazilwood BBL Bridal Blanco BGL Brighton Light CLL Collectors DWH Designer White FLO Florence Walnut GRH Graphite HGL High Line OAT Oatmeal Cookie PIN Pinnacle Walnut SHD Shadow SLG Slate Grey STU Studio Teak VIN Vintage WLH Walnut Heights WEA Weathered Ash	N None CO_EC23 Cut out for EC23 CO_EC24 Cut out for EC24	BWH Bright White Feet & Post MBK Matte Black Feet & Post PEW Pewter Feet & Post ASLASL Arctic Silver Feet & Post ASLBWH Arctic Silver Feet & Bright White Post ASLMBK Arctic Silver Feet & Matte Black Post ASLPEW Arctic Silver Feet & Pewter Post
		<b>Graded-In Laminates (T2) &amp; (T3)</b> see pages 156-161	PVC color must be selected with Graded-In Laminates (T2) & (T3)		

Model Number Breakdown

NST3666-42TTRR						
NS	T	3666	42	TT	R	R
Nosh	Laminate	36" x 66"	Height	Rectangular Top Shape	Rounded Corner	Round Disc Base

Description

Rounded Rectangular Bar Height Table  
with Round Disc Base  
(continued)

Veneer Tables "NSV" Models      Solid Surface Tables "NSS" Models

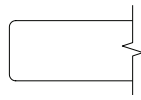

Eased Edge (R3)

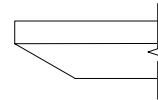

Reverse Bevel Edge (K9)

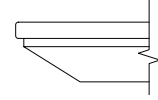

Reverse Bevel Edge (S7)

	D	W	H	CTN WT	CU FT	① Model	Eased Edge (R3)		Reverse Bevel Edge (K9)		Reverse Bevel Edge (S7)
							Flat Cut	Double Cut	Flat Cut	Double Cut	
VENEER	36	72	42	199	63	NSV3672-42TTRR	\$2,846	\$2,956	\$2,909	\$3,009	--
	36	66	42	193	58	NSV3666-42TTRR	\$2,578	\$2,677	\$2,636	\$2,728	--
	36	60	42	182	46	NSV3660-42TTRR	\$2,526	\$2,616	\$2,582	\$2,663	--
	30	72	42	160	61	NSV3072-42TTRR	\$2,529	\$2,642	\$2,593	\$2,693	--
	30	66	42	153	41	NSV3066-42TTRR	\$2,479	\$2,582	\$2,531	\$2,624	--
	30	60	42	146	36	NSV3060-42TTRR	\$2,434	\$2,527	\$2,490	\$2,575	--
SOLID SURFACE	36	72	42	232	63	NSS3672-42TTRR	--	--	--	--	\$5,480
	36	66	42	221	58	NSS3666-42TTRR	--	--	--	--	\$5,024
	36	60	42	210	46	NSS3660-42TTRR	--	--	--	--	\$4,786
	30	72	42	186	61	NSS3072-42TTRR	--	--	--	--	\$4,791
	30	66	42	175	41	NSS3066-42TTRR	--	--	--	--	\$4,583
	30	60	42	167	36	NSS3060-42TTRR	--	--	--	--	\$4,382

HSON

To Order Specify

① Veneer Model #	② Edge Detail	③ Wood Species	④ Wood Finish	⑤ Electrical Cut Out	⑥ Metal Finish
Veneer (NSV)	R3 Eased K9 Reverse Bevel	<b>Flat Cut</b> CH1 Cherry MA1 Maple WA1 Walnut	Cherry: BRL Barley BBM Bourbon Medium BRM Brighton Medium CLA Classic CLL Collectors* EAR Earthy HRV Harvest* LGC Legacy PRL Praline* SAF Saffron  Maple: ALM Ale Medium BUT Butterscotch CIN Cinnamon FLX Flax VEN Venetian  Walnut: AUB Auburn ESP Espresso MCH Mocha* NTO Night Owl* SIE Sienna* TOF Toffee TRF Truffle*  *finishes with coordinating laminate tops	N None CO_EC23 Cut out for EC23 CO_EC24 Cut out for EC24	BWH Bright White Feet & Post MBK Matte Black Feet & Post PEW Pewter Feet & Post ASLASL Arctic Silver Feet & Post ASLBWH Arctic Silver Feet & Bright White Post ASLMBK Arctic Silver Feet & Matte Black Post ASLPEW Arctic Silver Feet & Pewter Post
	<b>Double Cut</b> DC2 Double Cut	<b>④ Wood Finish</b> Double Cut: COF Coffee FOS Fossil KHK Khaki CRM Cremello GRH Graphite STU Studio Teak			

① Solid Surface Model #	② Edge Detail	③ Solid Surface	④ Electrical Cut Out	⑤ Metal Finish
Solid Surface (NSS)	S7 Reverse Bevel	<b>Tier 1</b> ARM Armadillo BLP Black Pearl GRA Graphite Granite PEB Pebble Pearl PUR Pure White	N None CO_EC23 Cut out for EC23 CO_EC24 Cut out for EC24	BWH Bright White Feet & Post MBK Matte Black Feet & Post PEW Pewter Feet & Post ASLASL Arctic Silver Feet & Post ASLBWH Arctic Silver Feet & Bright White Post ASLMBK Arctic Silver Feet & Matte Black Post ASLPEW Arctic Silver Feet & Pewter Post

Description

Rectangular Bar Height Table with Square Disc Base

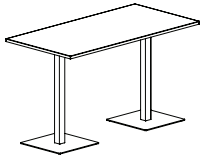

Laminate Tables "NST" Models

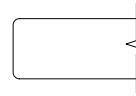

Eased Edge (R3)

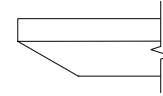

Reverse Bevel Edge (K9)

LAMINATE	D	W	H	CTN WT	CU FT	① Model	Eased Edge (R3)			Reverse Bevel Edge (K9)		
							Standard	Graded In		Standard	Graded In	
							Tier 1	Tier 2	Tier 3	Tier 1	Tier 2	Tier 3
	36	72	42	199	63	NST3672-42TTS	\$2,585	\$2,641	\$2,751	\$2,954	\$3,010	\$3,120
	36	66	42	191	58	NST3666-42TTS	\$2,455	\$2,519	\$2,620	\$2,825	\$2,889	\$2,989
	36	60	42	182	46	NST3660-42TTS	\$2,374	\$2,436	\$2,524	\$2,743	\$2,806	\$2,893
	30	72	42	159	61	NST3072-42TTS	\$2,376	\$2,438	\$2,525	\$2,748	\$2,807	\$2,894
	30	66	42	153	41	NST3066-42TTS	\$2,189	\$2,246	\$2,325	\$2,558	\$2,616	\$2,694
	30	60	42	146	36	NST3060-42TTS	\$2,126	\$2,180	\$2,250	\$2,496	\$2,549	\$2,620

Features:

- price reflects complete table - top and base
- ships KD in multiple cartons
- top has option for cut out to receive electrical component, order separately
- optional vertical wire manager for base, order separately
- base has anti-rock glides
- width of base foot varies from 17" or 22"

HSON

To Order Specify

① Laminate Model #	② Edge Detail	③ Laminate Selection	③a PVC Edge Color	④ Electrical Cut Out	⑤ Metal Finish
Laminate (NST)	R3 Eased	<b>Standard Laminates (T1)</b> Solid Patterns: ALB Alabaster      DWH Designer White BLK Black          SHD Shadow BBL Bridal Blanco    SLG Slate Grey  Wood Grain Patterns: AGA Aged Ash      GRH Graphite ALL Ale Light        HGL High Line BLO Blonde Echo    OAT Oatmeal Cookie BOL Bourbon Light    PIN Pinnacle Walnut BZW Brazilwood      STU Studio Teak BGL Brighton Light    VIN Vintage CLL Collectors        WLH Walnut Heights FLO Florence Walnut    WEA Weathered Ash	Color: Standard (T1) laminates have a matching PVC. AGA Aged Ash ALB Alabaster ALL Ale Light BLK Black BLO Blonde Echo BOL Bourbon Light BZW Brazilwood BBL Bridal Blanco BGL Brighton Light CLL Collectors DWH Designer White FLO Florence Walnut GRH Graphite HGL High Line OAT Oatmeal Cookie PIN Pinnacle Walnut SHD Shadow SLG Slate Grey STU Studio Teak VIN Vintage WLH Walnut Heights WEA Weathered Ash	N None CO_EC23 Cut out for EC23 CO_EC24 Cut out for EC24	BWH Bright White Feet & Post MBK Matte Black Feet & Post PEW Pewter Feet & Post ASLASL Arctic Silver Feet & Post ASLBWH Arctic Silver Feet & Bright White Post ASLMBK Arctic Silver Feet & Matte Black Post ASLPEW Arctic Silver Feet & Pewter Post
	K9 Reverse Bevel				

Model Number Breakdown

NST3066-42TTS					
NS	T	3066	42	TT	S
Nosh	Laminate	30" x 66"	Height	Rectangular Top Shape	Square Disc Base

Description

Rectangular Bar Height Table  
with Square Disc Base  
(continued)

Veneer Tables  
"NSV" Models

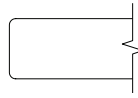

Eased Edge (R3)

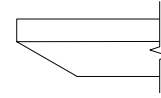

Reverse Bevel Edge (K9)

D	W	H	CTN WT	CU FT	① Model	Eased Edge (R3)		Reverse Bevel Edge (K9)	
						Flat Cut	Double Cut	Flat Cut	Double Cut
36	72	42	199	63	NSV3672-42TTS	\$2,892	\$3,002	\$2,948	\$3,049
36	66	42	191	58	NSV3666-42TTS	\$2,809	\$2,910	\$2,872	\$2,963
36	60	42	182	46	NSV3660-42TTS	\$2,732	\$2,822	\$2,793	\$2,870
30	72	42	159	61	NSV3072-42TTS	\$2,707	\$2,866	\$2,762	\$2,912
30	66	42	153	41	NSV3066-42TTS	\$2,519	\$2,623	\$2,572	\$2,666
30	60	42	146	36	NSV3060-42TTS	\$2,459	\$2,554	\$2,509	\$2,594

VENEER

NOSH

To Order Specify

① Veneer Model #	② Edge Detail	③ Wood Species	④ Wood Finish			⑤ Electrical Cut Out	⑥ Metal Finish
Veneer (NSV)	R3 Eased	<b>Flat Cut</b> CH1 Cherry MA1 Maple WA1 Walnut	Cherry:	Maple:	Walnut:	N None CO_EC23 Cut out for EC23 CO_EC24 Cut out for EC24	BWH Bright White Feet & Post MBK Matte Black Feet & Post PEW Pewter Feet & Post ASLASL Arctic Silver Feet & Post ASLBWH Arctic Silver Feet & Bright White Post ASLMBK Arctic Silver Feet & Matte Black Post ASLPEW Arctic Silver Feet & Pewter Post
	K9 Reverse Bevel		BRL Barley BBM Bourbon Medium BRM Brighton Medium CLA Classic CLL Collectors* EAR Earthy HRV Harvest* LGC Legacy PRL Praline* SAF Saffron	ALM Ale Medium BUT Butterscotch CIN Cinnamon FLX Flax VEN Venetian	AUB Auburn ESP Espresso MCH Mocha* NTO Night Owl* SIE Sienna* TOF Toffee TRF Truffle*		
		<b>Double Cut</b> DC2 Double Cut	<b>④ Wood Finish</b> Double Cut: COF Coffee FOS Fossil KHK Khaki CRM Cremello GRH Graphite STU Studio Teak				



Description

Rounded Rectangular Bar Height Table with Square Disc Base

Laminate Tables "NST" Models

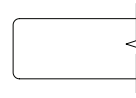
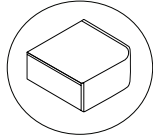
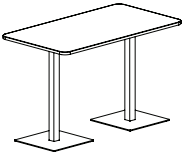

Eased Edge (R3)

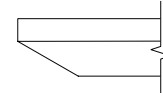

Reverse Bevel (K9)

LAMINATE	D	W	H	CTN WT	CU FT	① Model	Standard			Graded In		
							Tier 1	Tier 2	Tier 3	Tier 1	Tier 2	Tier 3
	36	72	42	221	63	NST3672-42TTRS	\$2,788	\$2,862	\$2,967	\$3,159	\$3,231	\$3,337
36	66	42	213	58	NST3666-42TTRS	\$2,481	\$2,544	\$2,644	\$2,850	\$2,913	\$3,014	
36	60	42	205	46	NST3660-42TTRS	\$2,425	\$2,485	\$2,594	\$2,795	\$2,855	\$2,964	
30	72	42	172	61	NST3072-42TTRS	\$2,459	\$2,520	\$2,606	\$2,828	\$2,890	\$2,977	
30	66	42	165	41	NST3066-42TTRS	\$2,405	\$2,463	\$2,541	\$2,774	\$2,833	\$2,910	
30	60	42	158	36	NST3060-42TTRS	\$2,356	\$2,412	\$2,481	\$2,727	\$2,781	\$2,850	

Features:

- price reflects complete table - top and base
- ships KD in multiple cartons
- top has option for cut out to receive electrical component, order separately
- optional vertical wire manager for base, order separately
- base has anti-rock glides
- width of base foot varies from 17" or 22"

HSON

To Order Specify

① Laminate Model #	② Edge Detail	③ Laminate Selection	③a PVC Edge Color	④ Electrical Cut Out	⑤ Metal Finish
Laminate (NST)	R3 Eased	<b>Standard Laminates (T1)</b> Solid Patterns: ALB Alabaster      DWH Designer White BLK Black          SHD Shadow BBL Bridal Blanco    SLG Slate Grey  Wood Grain Patterns: AGA Aged Ash      GRH Graphite ALL Ale Light      HGL High Line BLO Blonde Echo    OAT Oatmeal Cookie BOL Bourbon Light    PIN Pinnacle Walnut BZW Brazilwood      STU Studio Teak BGL Brighton Light    VIN Vintage CLL Collectors        WLH Walnut Heights FLO Florence Walnut    WEA Weathered Ash	Color: Standard (T1) laminates have a matching PVC. AGA Aged Ash ALB Alabaster ALL Ale Light BLK Black BLO Blonde Echo BOL Bourbon Light BZW Brazilwood BBL Bridal Blanco BGL Brighton Light CLL Collectors DWH Designer White FLO Florence Walnut GRH Graphite HGL High Line OAT Oatmeal Cookie PIN Pinnacle Walnut SHD Shadow SLG Slate Grey STU Studio Teak VIN Vintage WLH Walnut Heights WEA Weathered Ash	N None CO_EC23 Cut out for EC23 CO_EC24 Cut out for EC24	BWH Bright White Feet & Post MBK Matte Black Feet & Post PEW Pewter Feet & Post ASLASL Arctic Silver Feet & Post ASLBWH Arctic Silver Feet & Bright White Post ASLMBK Arctic Silver Feet & Matte Black Post ASLPEW Arctic Silver Feet & Pewter Post
	K9 Reverse Bevel				

Model Number Breakdown

NST3060-42TTRS						
NS	T	3060	42	TT	R	S
Nosh	Laminate	30" x 60"	Height	Rectangular Top Shape	Rounded Corner	Sqaure Disc Base

Description

Rounded Rectangular Bar Height Table  
with Square Disc Base  
(continued)

Veneer Tables  
"NSV" Models

Solid Surface Tables  
"NSS" Models

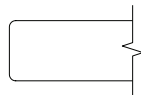

Eased Edge (R3)

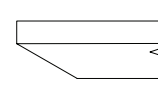

Reverse Bevel Edge (K9)

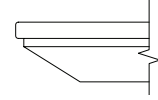

Reverse Bevel Edge (S7)

	D	W	H	CTN WT	CU FT	① Model	Eased Edge (R3)		Reverse Bevel Edge (K9)		Standard
							Flat Cut	Double Cut	Flat Cut	Double Cut	
VENEER	36	72	42	221	63	NSV3672-42TTRS	\$3,096	\$3,207	\$3,160	\$3,259	--
	36	66	42	213	58	NSV3666-42TTRS	\$2,827	\$2,928	\$2,887	\$2,978	--
	36	60	42	205	46	NSV3660-42TTRS	\$2,776	\$2,866	\$2,831	\$2,912	--
	30	72	42	172	61	NSV3072-42TTRS	\$2,779	\$2,892	\$2,844	\$2,944	--
	30	66	42	165	41	NSV3066-42TTRS	\$2,729	\$2,831	\$2,780	\$2,873	--
	30	60	42	158	36	NSV3060-42TTRS	\$2,684	\$2,777	\$2,739	\$2,824	--
SOLID SURFACE	36	72	42	255	63	NSS3672-42TTRS	--	--	--	--	\$5,731
	36	66	42	243	58	NSS3666-42TTRS	--	--	--	--	\$5,275
	36	60	42	132	46	NSS3660-42TTRS	--	--	--	--	\$5,035
	30	72	42	197	61	NSS3072-42TTRS	--	--	--	--	\$5,041
	30	66	42	188	41	NSS3066-42TTRS	--	--	--	--	\$4,833
	30	60	42	179	36	NSS3060-42TTRS	--	--	--	--	\$4,632

To Order Specify

① Veneer Model #	② Edge Detail	③ Wood Species	④ Wood Finish	⑤ Electrical Cut Out	⑥ Metal Finish
Veneer (NSV)	R3 Eased K9 Reverse Bevel	<b>Flat Cut</b> CH1 Cherry MA1 Maple WA1 Walnut	Cherry: BRL Barley BBM Bourbon Medium BRM Brighton Medium CLA Classic CLL Collectors* EAR Earthy HRV Harvest* LGC Legacy PRL Praline* SAF Saffron  Maple: ALM Ale Medium BUT Butterscotch CIN Cinnamon FLX Flax VEN Venetian  Walnut: AUB Auburn ESP Espresso MCH Mocha* NTO Night Owl* SIE Sienna* TOF Toffee TRF Truffle*  *finishes with coordinating laminate tops	N None CO_EC23 Cut out for EC23 CO_EC24 Cut out for EC24	BWH Bright White Feet & Post MBK Matte Black Feet & Post PEW Pewter Feet & Post ASLASL Arctic Silver Feet & Post ASLBWH Arctic Silver Feet & Bright White Post ASLMBK Arctic Silver Feet & Matte Black Post ASLPEW Arctic Silver Feet & Pewter Post
	<b>Double Cut</b> DC2 Double Cut	<b>④ Wood Finish</b> Double Cut: COF Coffee FOS Fossil KHK Khaki CRM Cremello GRH Graphite STU Studio Teak			

① Solid Surface Model #	② Edge Detail	③ Solid Surface	④ Electrical Cut Out	⑤ Metal Finish
Solid Surface (NSS)	S7 Reverse Bevel	<b>Tier 1</b> ARM Armadillo BLP Black Pearl GRA Graphite Granite PEB Pebble Pearl PUR Pure White	N None CO_EC23 Cut out for EC23 CO_EC24 Cut out for EC24	BWH Bright White Feet & Post MBK Matte Black Feet & Post PEW Pewter Feet & Post ASLASL Arctic Silver Feet & Post ASLBWH Arctic Silver Feet & Bright White Post ASLMBK Arctic Silver Feet & Matte Black Post ASLPEW Arctic Silver Feet & Pewter Post

Description

Round Bar Height Table with X Base

Laminate Tables  
"NST" Models

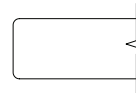

Eased Edge (R3)

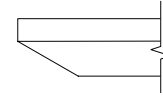

Reverse Bevel Edge (K9)

LAMINATE	D	W	H	CTN WT	CU FT	① Model	Standard			Graded In		
							Tier 1	Tier 2	Tier 3	Tier 1	Tier 2	Tier 3
	48	N/A	42	90	28	<b>NST48-42RDX</b>	\$1,376	\$1,473	\$1,581	\$1,745	\$1,843	\$1,950
42	N/A	42	75	23	<b>NST42-42RDX</b>	\$1,266	\$1,361	\$1,440	\$1,636	\$1,732	\$1,810	
36	N/A	42	61	19	<b>NST36-42RDX</b>	\$1,229	\$1,264	\$1,319	\$1,598	\$1,634	\$1,690	
30	N/A	42	50	21	<b>NST30-42RDX</b>	\$1,186	\$1,215	\$1,248	\$1,556	\$1,585	\$1,617	

Features:

- price reflects complete table - top and base
- ships KD in multiple cartons
- top has option for cutout to receive electrical component, ordered separately
- when electrical cut out selected, power accessible base is sent - add \$95
- optional vertical wire manager for base, order separately
- base has leveling glides
- width of base foot varies from 32" to 38"

HSON

To Order Specify

① Laminate Model #	② Edge Detail	③ Laminate Selection	③a PVC Edge Color	④ Electrical Cut Out	⑤ Metal Finish
Laminate (NST)	R3 Eased K9 Reverse Bevel	<b>Standard Laminates (T1)</b> Solid Patterns: ALB Alabaster      DWH Designer White BLK Black          SHD Shadow BBL Bridal Blanco    SLG Slate Grey  Wood Grain Patterns: AGA Aged Ash      GRH Graphite ALL Ale Light      HGL High Line BLO Blonde Echo    OAT Oatmeal Cookie BOL Bourbon Light    PIN Pinnacle Walnut BZW Brazilwood      STU Studio Teak BGL Brighton Light    VIN Vintage CLL Collectors        WLH Walnut Heights FLO Florence Walnut    WEA Weathered Ash	Color: Standard (T1) laminates have a matching PVC. AGA Aged Ash ALB Alabaster ALL Ale Light BLK Black BLO Blonde Echo BOL Bourbon Light BZW Brazilwood BBL Bridal Blanco BGL Brighton Light CLL Collectors DWH Designer White FLO Florence Walnut GRH Graphite HGL High Line OAT Oatmeal Cookie PIN Pinnacle Walnut SHD Shadow SLG Slate Grey STU Studio Teak VIN Vintage WLH Walnut Heights WEA Weathered Ash	N None CO_EC23 Cut out for EC23 CO_EC24 Cut out for EC24	BWH Bright White Feet & Post MBK Matte Black Feet & Post PEW Pewter Feet & Post ASLASL Arctic Silver Feet & Post ASLBWH Arctic Silver Feet & Bright White Post ASLMBK Arctic Silver Feet & Matte Black Post ASLPEW Arctic Silver Feet & Pewter Post PAMASL Polished Aluminum Feet & Arctic Silver Post PAMBWH Polished Aluminum Feet & Bright White Post PAMMBK Polished Aluminum Feet & Matte Black Post PAMPEW Polished Aluminum Feet & Pewter Post
			Graded-In Laminates (T2) & (T3) see pages 156-161	PVC color must be selected with Graded-In Laminates (T2) & (T3)	

Model Number Breakdown

NST48-42RDX					
NS	T	48	42	RD	X
Nosh	Laminate	48" Diameter	Height	Round Top Shape	X base

Description

Round Bar Height Table with X Base  
(continued)

Veneer Tables  
"NSV" Models

Solid Surface Tables  
"NSS" Models

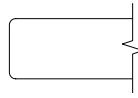

Eased Edge (R3)

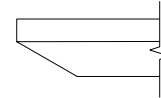

Reverse Bevel Edge (K9)

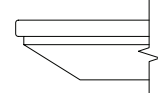

Reverse Bevel Edge (S7)

	D	W	H	CTN WT	CU FT	① Model	Eased Edge (R3)		Reverse Bevel Edge (K9)		Reverse Bevel Edge (S7)
							Flat Cut	Double Cut	Flat Cut	Double Cut	
VENEER	48	N/A	42	90	28	NSV48-42RDX	\$1,810	\$1,929	\$1,877	\$2,003	--
	42	N/A	42	75	23	NSV42-42RDX	\$1,661	\$1,771	\$1,724	\$1,837	--
	36	N/A	42	61	19	NSV36-42RDX	\$1,611	\$1,718	\$1,674	\$1,783	--
	30	N/A	42	50	21	NSV30-42RDX	\$1,555	\$1,657	\$1,614	\$1,720	--
SOLID SURFACE	48	N/A	42	120	28	NSS48-42RDX	--	--	--	--	\$4,198
	42	N/A	42	98	23	NSS42-42RDX	--	--	--	--	\$3,580
	36	N/A	42	78	19	NSS36-42RDX	--	--	--	--	\$3,124
	30	N/A	42	61	21	NSS30-42RDX	--	--	--	--	\$2,721

NOSH

To Order Specify

① Veneer Model #	② Edge Detail	③ Wood Species	④ Wood Finish	⑤ Electrical Cut Out	⑥ Metal Finish		
Veneer (NSV)	R3 Eased K9 Reverse Bevel	<b>Flat Cut</b> CH1 Cherry MA1 Maple WA1 Walnut	Cherry: BRL Barley BBM Bourbon Medium BRM Brighton Medium CLA Classic CLL Collectors* EAR Earthy HRV Harvest* LGC Legacy PRL Praline* SAF Saffron	Maple: ALM Ale Medium BUT Butterscotch CIN Cinnamon FLX Flax VEN Venetian	Walnut: AUB Auburn ESP Espresso MCH Mocha* NTO Night Owl* SIE Sienna* TOF Toffee* TRF Truffle*	N None CO_EC23 Cut out for EC23 CO_EC24 Cut out for EC24	BWH Bright White Feet & Post MBK Matte Black Feet & Post PEW Pewter Feet & Post ASLASL Arctic Silver Feet & Post ASLBWH Arctic Silver Feet & Bright White Post ASLMBK Arctic Silver Feet & Matte Black Post ASLPEW Arctic Silver Feet & Pewter Post PAMASL Polished Aluminum Feet & Arctic Silver Post PAMBWH Polished Aluminum Feet & Bright White Post PAMMBK Polished Aluminum Feet & Matte Black Post PAMPEW Polished Aluminum Feet & Pewter Post
		<b>Double Cut</b> DC2 Double Cut	<b>④ Wood Finish</b> Double Cut: COF Coffee FOS Fossil KHK Khaki CRM Cremello GRH Graphite STU Studio Teak				

① Solid Surface Model #	② Edge Detail	③ Solid Surface	④ Electrical Cut Out	⑤ Metal Finish
Solid Surface (NSS)	S7 Reverse Bevel	<b>Tier 1</b> ARM Armadillo BLP Black Pearl GRA Graphite Granite PEB Pebble Pearl PUR Pure White	N None CO_EC23 Cut out for EC23 CO_EC24 Cut out for EC24	BWH Bright White Feet & Post MBK Matte Black Feet & Post PEW Pewter Feet & Post ASLASL Arctic Silver Feet & Post ASLBWH Arctic Silver Feet & Bright White Post ASLMBK Arctic Silver Feet & Matte Black Post ASLPEW Arctic Silver Feet & Pewter Post PAMASL Polished Aluminum Feet & Arctic Silver Post PAMBWH Polished Aluminum Feet & Bright White Post PAMMBK Polished Aluminum Feet & Matte Black Post PAMPEW Polished Aluminum Feet & Pewter Post

Description

Round Bar Height Table with X4 Base

Laminate Tables  
"NST" Models

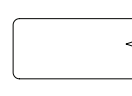

Eased Edge (R3)

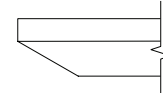

Reverse Bevel Edge (K9)

LAMINATE	D	W	H	CTN WT	CU FT	① Model	Eased Edge (R3)			Reverse Bevel Edge (K9)		
							Standard	Graded In		Standard	Graded In	
							Tier 1	Tier 2	Tier 3	Tier 1	Tier 2	Tier 3
	60	N/A	42	154	50	NST60-42RDZ	\$2,282	\$2,359	\$2,528	\$2,652	\$2,729	\$2,899
	54	N/A	42	71	15	NST54-42RDZ	\$2,137	\$2,196	\$2,255	\$2,506	\$2,565	\$2,624

Features:

- price reflects complete table - top and base
- ships KD in multiple cartons
- top has option for cut out to receive electrical component, order separately
- optional vertical wire manager for base, order separately
- base has leveling glides
- width of base foot is 38"

HSON

To Order Specify

① Laminate Model #	② Edge Detail	③ Laminate Selection	③a PVC Edge Color	④ Electrical Cut Out	⑤ Metal Finish
Laminate (NST)	R3 Eased K9 Reverse Bevel	<b>Standard Laminates (T1)</b> Solid Patterns: ALB Alabaster      DWH Designer White BLK Black          SHD Shadow BBL Bridal Blanco    SLG Slate Grey  Wood Grain Patterns: AGA Aged Ash      GRH Graphite ALL Ale Light      HGL High Line BLO Blonde Echo    OAT Oatmeal Cookie BOL Bourbon Light    PIN Pinnacle Walnut BZW Brazilwood      STU Studio Teak BGL Brighton Light    VIN Vintage CLL Collectors        WLH Walnut Heights FLO Florence Walnut    WEA Weathered Ash	Color: Standard (T1) laminates have a matching PVC. AGA Aged Ash ALB Alabaster ALL Ale Light BLK Black BLO Blonde Echo BOL Bourbon Light BZW Brazilwood BBL Bridal Blanco BGL Brighton Light CLL Collectors DWH Designer White FLO Florence Walnut GRH Graphite HGL High Line OAT Oatmeal Cookie PIN Pinnacle Walnut SHD Shadow SLG Slate Grey STU Studio Teak VIN Vintage WLH Walnut Heights WEA Weathered Ash	N None CO_EC23 Cut out for EC23 CO_EC24 Cut out for EC24	BWH Bright White Feet & Post MBK Matte Black Feet & Post PEW Pewter Feet & Post ASLASL Arctic Silver Feet & Post ASLBWH Arctic Silver Feet & Bright White Post ASLMBK Arctic Silver Feet & Matte Black Post ASLPEW Arctic Silver Feet & Pewter Post PAMASL Polished Aluminum Feet & Arctic Silver Post PAMBWH Polished Aluminum Feet & Bright White Post PAMMBK Polished Aluminum Feet & Matte Black Post PAMPEW Polished Aluminum Feet & Pewter Post
			Graded-In Laminates (T2) & (T3) see pages 156-161	PVC color must be selected with Graded-In Laminates (T2) & (T3)	

Model Number Breakdown

NSV54-42RDZ					
NS	V	54	42	RD	Z
Nosh	Veneer	54" Diameter	Height	Round Top Shape	X4 Base

Description

Round Bar Height Table with X4 Base  
(continued)

		Veneer Tables "NSV" Models				Solid Surface Tables "NSS" Models					
		Eased Edge (R3)		Reverse Bevel Edge (K9)		Reverse Bevel Edge (S7)					
		Flat Cut	Double Cut	Flat Cut	Double Cut	Standard					
	D	W	H	CTN WT	CU FT	① Model	Flat Cut	Double Cut	Flat Cut	Double Cut	Standard
VENEER	60	N/A	42	154	50	NSV60-42RDZ	\$2,989	\$3,184	\$3,100	\$3,304	--
	54	N/A	42	106	28	NSV54-42RDZ	\$2,828	\$3,020	\$2,938	\$3,137	--
SOL SURF	60	N/A	42	208	50	NSS60-42RDZ	--	--	--	--	\$6,500
	54	N/A	42	145	28	NSS54-42RDZ	--	--	--	--	\$5,747

NOSH

To Order Specify

① Veneer Model #	② Edge Detail	③ Wood Species	④ Wood Finish			⑤ Electrical Cut Out	⑥ Metal Finish
Veneer (NSV)	R3 Eased K9 Reverse Bevel	Flat Cut CH1 Cherry MA1 Maple WA1 Walnut	Cherry: BRL Barley BBM Bourbon Medium BRM Brighton Medium CLA Classic CLL Collectors* EAR Earthy HRV Harvest* LGC Legacy PRL Praline* SAF Saffron	Maple: ALM Ale Medium BUT Butterscotch CIN Cinnamon FLX Flax VEN Venetian	Walnut: AUB Auburn ESP Espresso MCH Mocha* NTO Night Owl* SIE Sienna* TOF Toffee* TRF Truffle*	N None CO_EC23 Cut out for EC23 CO_EC24 Cut out for EC24	BWH Bright White Feet & Post MBK Matte Black Feet & Post PEW Pewter Feet & Post ASLASL Arctic Silver Feet & Post ASLBWH Arctic Silver Feet & Bright White Post ASLMBK Arctic Silver Feet & Matte Black Post ASLPEW Arctic Silver Feet & Pewter Post PAMASL Polished Aluminum Feet & Arctic Silver Post PAMBWH Polished Aluminum Feet & Bright White Post PAMMBK Polished Aluminum Feet & Matte Black Post PAMPEW Polished Aluminum Feet & Pewter Post
			Double Cut DC2 Double Cut	④ Wood Finish Double Cut: COF Coffee FOS Fossil KHK Khaki CRM Cremello GRH Graphite STU Studio Teak			

① Solid Surface Model #	② Edge Detail	③ Solid Surface	④ Electrical Cut Out	⑤ Metal Finish
Solid Surface (NSS)	S7 Reverse Bevel	Tier 1 ARM Armadillo BLP Black Pearl GRA Graphite Granite PEB Pebble Pearl PUR Pure White	N None CO_EC23 Cut out for EC23 CO_EC24 Cut out for EC24	BWH Bright White Feet & Post MBK Matte Black Feet & Post PEW Pewter Feet & Post ASLASL Arctic Silver Feet & Post ASLBWH Arctic Silver Feet & Bright White Post ASLMBK Arctic Silver Feet & Matte Black Post ASLPEW Arctic Silver Feet & Pewter Post PAMASL Polished Aluminum Feet & Arctic Silver Post PAMBWH Polished Aluminum Feet & Bright White Post PAMMBK Polished Aluminum Feet & Matte Black Post PAMPEW Polished Aluminum Feet & Pewter Post

Description

Round Bar Height Table with Round Disc Base

Laminate Tables  
"NST" Models

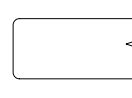

Eased Edge (R3)

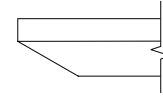

Reverse Bevel Edge (K9)

LAMINATE	D	W	H	CTN WT	CU FT	① Model	Standard			Graded In		
							Tier 1	Tier 2	Tier 3	Tier 1	Tier 2	Tier 3
	48	N/A	42	133	28	NST48-42RDR	\$1,586	\$1,637	\$1,743	\$1,955	\$2,006	\$2,113
	42	N/A	42	118	21	NST42-42RDR	\$1,451	\$1,495	\$1,571	\$1,820	\$1,865	\$1,942
	36	N/A	42	88	20	NST36-42RDR	\$1,244	\$1,281	\$1,334	\$1,614	\$1,651	\$1,703
	30	N/A	42	65	15	NST30-42RDR	\$1,071	\$1,102	\$1,135	\$1,441	\$1,472	\$1,504

Features:

- price reflects complete table - top and base
- ships KD in multiple cartons
- cut out for power is not available on these tables
- base has anti-rock glides
- width of base foot varies from 22" or 27"

HSON

To Order Specify

① Laminate Model #	② Edge Detail	③ Laminate Selection	③a PVC Edge Color	④ Metal Finish
Laminate (NST)	R3 Eased	<b>Standard Laminates (T1)</b> Solid Patterns: ALB Alabaster      DWH Designer White BLK Black          SHD Shadow BBL Bridal Blanco    SLG Slate Grey  Wood Grain Patterns: AGA Aged Ash      GRH Graphite ALL Ale Light      HGL High Line BLO Blonde Echo    OAT Oatmeal Cookie BOL Bourbon Light    PIN Pinnacle Walnut BZW Brazilwood      STU Studio Teak BGL Brighton Light    VIN Vintage CLL Collectors        WLH Walnut Heights FLO Florence Walnut    WEA Weathered Ash	Color: Standard (T1) laminates have a matching PVC. AGA Aged Ash ALB Alabaster ALL Ale Light BLK Black BLO Blonde Echo BOL Bourbon Light BZW Brazilwood BBL Bridal Blanco BGL Brighton Light CLL Collectors DWH Designer White FLO Florence Walnut GRH Graphite HGL High Line OAT Oatmeal Cookie PIN Pinnacle Walnut SHD Shadow SLG Slate Grey STU Studio Teak VIN Vintage WLH Walnut Heights WEA Weathered Ash	BWH Bright White Feet & Post MBK Matte Black Feet & Post PEW Pewter Feet & Post ASLASL Arctic Silver Feet & Post ASLBWH Arctic Silver Feet & Bright White Post ASLMBK Arctic Silver Feet & Matte Black Post ASLPEW Arctic Silver Feet & Pewter Post
	K9 Reverse Bevel			

Model Number Breakdown

NST30-42RDR					
NS	V	30	42	RD	R
Nosh	Veneer	30" Diameter	Height	Round Top Shape	Round Disc Base

Description

Round Bar Height Table with Round Disc Base  
(continued)

Veneer Tables  
"NSV" Models

Solid Surface Tables  
"NSS" Models

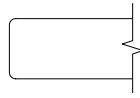

Eased Edge (R3)

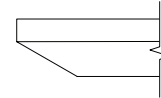

Reverse Bevel Edge (K9)

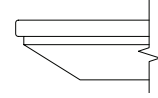

Reverse Bevel Edge (S7)

	D	W	H	CTN WT	CU FT	① Model	Eased Edge (R3)		Reverse Bevel Edge (K9)		Standard
							Flat Cut	Double Cut	Flat Cut	Double Cut	
VENEER	48	N/A	42	133	28	NSV48-42RDR	\$1,978	\$2,116	\$2,058	\$2,201	--
	42	N/A	42	118	21	NSV42-42RDR	\$1,797	\$1,923	\$1,870	\$2,002	--
	36	N/A	42	88	20	NSV36-42RDR	\$1,521	\$1,628	\$1,583	\$1,694	--
	30	N/A	42	65	15	NSV30-42RDR	\$1,290	\$1,380	\$1,342	\$1,436	--
SOLID SURFACE	48	N/A	42	163	28	NSS48-42RDR	--	--	--	--	\$4,468
	42	N/A	42	141	21	NSS42-42RDR	--	--	--	--	\$3,817
	36	N/A	42	104	20	NSS36-42RDR	--	--	--	--	\$3,136
	30	N/A	42	76	15	NSS30-42RDR	--	--	--	--	\$2,559

NOSH

To Order Specify

① Veneer Model #	② Edge Detail	③ Wood Species	④ Wood Finish	⑤ Metal Finish
Veneer (NSV)	R3 Eased K9 Reverse Bevel	<b>Flat Cut</b> CH1 Cherry MA1 Maple WA1 Walnut  <b>Double Cut</b> DC2 Double Cut	Cherry: BRL Barley BBM Bourbon Medium BRM Brighton Medium CLA Classic CLL Collectors* EAR Earthy HRV Harvest* LGC Legacy PRL Praline* SAF Saffron  Maple: ALM Ale Medium BUT Butterscotch CIN Cinnamon FLX Flax VEN Venetian  Walnut: AUB Auburn ESP Espresso MCH Mocha* NTO Night Owl* SIE Sienna* TOF Toffee TRF Truffle*  *finishes with coordinating laminate tops	BWH Bright White Feet & Post MBK Matte Black Feet & Post PEW Pewter Feet & Post ASLASL Arctic Silver Feet & Post ASLBWH Arctic Silver Feet & Bright White Post ASLMBK Arctic Silver Feet & Matte Black Post ASLPEW Arctic Silver Feet & Pewter Post
			<b>④ Wood Finish</b> Double Cut: COF Coffee FOS Fossil KHK Khaki CRM Cremello GRH Graphite STU Studio Teak	

① Solid Surface Model #	② Edge Detail	③ Solid Surface	④ Metal Finish
Solid Surface (NSS)	S7 Reverse Bevel	<b>Tier 1</b> ARM Armadillo BLP Black Pearl GRA Graphite Granite PEB Pebble Pearl PUR Pure White	BWH Bright White Feet & Post MBK Matte Black Feet & Post PEW Pewter Feet & Post ASLASL Arctic Silver Feet & Post ASLBWH Arctic Silver Feet & Bright White Post ASLMBK Arctic Silver Feet & Matte Black Post ASLPEW Arctic Silver Feet & Pewter Post



Description

Round Bar Height Table with Square Disc Base

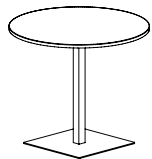

Laminate Tables "NST" Models

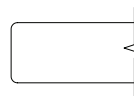

Eased Edge (R3)

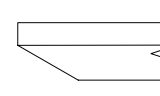

Reverse Bevel (K9)

LAMINATE	D	W	H	CTN WT	CU FT	1 Model	Standard			Graded In		
							Tier 1	Tier 2	Tier 3	Tier 1	Tier 2	Tier 3
	48	N/A	42	149	28	<b>NST48-42RDS</b>	\$1,767	\$1,818	\$1,924	\$2,136	\$2,188	\$2,294
42	N/A	42	134	21	<b>NST42-42RDS</b>	\$1,632	\$1,676	\$1,753	\$2,001	\$2,045	\$2,123	
36	N/A	42	99	20	<b>NST36-42RDS</b>	\$1,370	\$1,406	\$1,460	\$1,739	\$1,776	\$1,829	
30	N/A	42	71	15	<b>NST30-42RDS</b>	\$1,197	\$1,227	\$1,259	\$1,566	\$1,597	\$1,629	

Features:

- price reflects complete table - top and base
- ships KD in multiple cartons
- cut out for power is not available on these tables
- width of base foot varies from 17" to 27"

HSON

To Order Specify

1 Laminate Model #	2 Edge Detail	3 Laminate Selection	3a PVC Edge Color	4 Metal Finish
Laminate (NST)	R3 Eased K9 Reverse Bevel	<b>Standard Laminates (T1)</b> Solid Patterns: ALB Alabaster      DWH Designer White BLK Black          SHD Shadow BBL Bridal Blanco    SLG Slate Grey  Wood Grain Patterns: AGA Aged Ash      GRH Graphite ALL Ale Light      HGL High Line BLO Blonde Echo    OAT Oatmeal Cookie BOL Bourbon Light    PIN Pinnacle Walnut BZW Brazilwood      STU Studio Teak BGL Brighton Light    VIN Vintage CLL Collectors        WLH Walnut Heights FLO Florence Walnut    WEA Weathered Ash	Color: Standard (T1) laminates have a matching PVC. AGA Aged Ash ALB Alabaster ALL Ale Light BLK Black BLO Blonde Echo BOL Bourbon Light BZW Brazilwood BBL Bridal Blanco BGL Brighton Light CLL Collectors DWH Designer White FLO Florence Walnut GRH Graphite HGL High Line OAT Oatmeal Cookie PIN Pinnacle Walnut SHD Shadow SLG Slate Grey STU Studio Teak VIN Vintage WLH Walnut Heights WEA Weathered Ash	BWH Bright White Feet & Post MBK Matte Black Feet & Post PEW Pewter Feet & Post ASLASL Arctic Silver Feet & Post ASLBWH Arctic Silver Feet & Bright White Post ASLMBK Arctic Silver Feet & Matte Black Post ASLPEW Arctic Silver Feet & Pewter Post
		<b>Graded-In Laminates (T2) &amp; (T3)</b> see pages 156-161	PVC color must be selected with Graded-In Laminates (T2) & (T3)	

NST48-42RDS					
NS	T	48	42	RD	S
Nosh	Laminate	48" Diameter	Height	Round Top Shape	Square Disc Base

Description

Round Bar Height Table  
with Square Disc Base  
(continued)

Veneer Tables  
"NSV" Models

Solid Surface Tables  
"NSS" Models

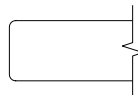

Eased Edge (R3)

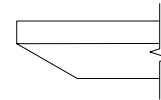

Reverse Bevel Edge (K9)

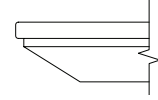

Reverse Bevel Edge (S7)

	D	W	H	CTN WT	CU FT	① Model	Eased Edge (R3)		Reverse Bevel Edge (K9)		Standard
							Flat Cut	Double Cut	Flat Cut	Double Cut	
VENEER	48	N/A	42	149	28	NSV48-42RDS	\$2,324	\$2,480	\$2,413	\$2,577	--
	42	N/A	42	134	21	NSV42-42RDS	\$2,142	\$2,285	\$2,223	\$2,372	--
	36	N/A	42	99	20	NSV36-42RDS	\$1,791	\$1,910	\$1,859	\$1,984	--
	30	N/A	42	71	15	NSV30-42RDS	\$1,560	\$1,661	\$1,618	\$1,725	--
SOLID SURFACE	48	N/A	42	178	28	NSS48-42RDS	--	--	--	--	\$4,711
	42	N/A	42	156	21	NSS42-42RDS	--	--	--	--	\$4,060
	36	N/A	42	115	20	NSS36-42RDS	--	--	--	--	\$3,304
	30	N/A	42	82	15	NSS30-42RDS	--	--	--	--	\$2,727

NOSH

To Order Specify

① Veneer Model #	② Edge Detail	③ Wood Species	④ Wood Finish	⑤ Metal Finish		
Veneer (NSV)	R3 Eased K9 Reverse Bevel	<b>Flat Cut</b> CH1 Cherry MA1 Maple WA1 Walnut	Cherry: BRL Barley BBM Bourbon Medium BRM Brighton Medium CLA Classic CLL Collectors* EAR Earthy HRV Harvest* LGC Legacy PRL Praline* SAF Saffron	Maple: ALM Ale Medium BUT Butterscotch CIN Cinnamon FLX Flax VEN Venetian	Walnut: AUB Auburn ESP Espresso MCH Mocha* NTO Night Owl* SIE Sienna* TOF Toffee TRF Truffle*	BWH Bright White Feet & Post MBK Matte Black Feet & Post PEW Pewter Feet & Post ASLASL Arctic Silver Feet & Post ASLBWH Arctic Silver Feet & Bright White Post ASLMBK Arctic Silver Feet & Matte Black Post ASLPEW Arctic Silver Feet & Pewter Post
			<b>Double Cut</b> DC2 Double Cut	<b>④ Wood Finish</b> Double Cut: COF Coffee FOS Fossil KHK Khaki CRM Cremello GRH Graphite STU Studio Teak		

① Solid Surface Model #	② Edge Detail	③ Solid Surface	④ Metal Finish
Solid Surface (NSS)	S7 Reverse Bevel	<b>Tier 1</b> ARM Armadillo BLP Black Pearl GRA Graphite Granite PEB Pebble Pearl PUR Pure White	BWH Bright White Feet & Post MBK Matte Black Feet & Post PEW Pewter Feet & Post ASLASL Arctic Silver Feet & Post ASLBWH Arctic Silver Feet & Bright White Post ASLMBK Arctic Silver Feet & Matte Black Post ASLPEW Arctic Silver Feet & Pewter Post

Description

Square Bar Height Table with X Base

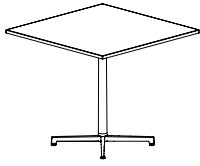

Laminate Tables  
"NST" Models

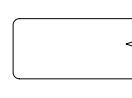

Eased Edge (R3)

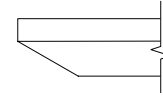

Reverse Bevel Edge (K9)

LAMINATE	D	W	H	CTN WT	CU FT	① Model	Eased Edge (R3)			Reverse Bevel Edge (K9)		
							Standard	Graded In		Standard	Graded In	
							Tier 1	Tier 2	Tier 3	Tier 1	Tier 2	Tier 3
	42	42	42	88	23	NST4242-42SQX	\$1,296	\$1,338	\$1,441	\$1,667	\$1,707	\$1,811
	36	36	42	72	18	NST3636-42SQX	\$1,155	\$1,188	\$1,213	\$1,524	\$1,559	\$1,583
	30	30	42	58	18	NST3030-42SQX	\$1,041	\$1,068	\$1,080	\$1,410	\$1,437	\$1,451

Features:

- price reflects complete table - top and base
- ships KD in multiple cartons
- top has option for cutout to receive electrical component, ordered separately
- when electrical cut out selected, power accessible base is sent - add \$95
- base has leveling glides
- width of base foot varies from 26" to 38"

HSON

To Order Specify

① Laminate Model #	② Edge Detail	③ Laminate Selection	③a PVC Edge Color	④ Electrical Cut Out	⑤ Metal Finish
Laminate (NST)	R3 Eased K9 Reverse Bevel	<b>Standard Laminates (T1)</b> Solid Patterns: ALB Alabaster      DWH Designer White BLK Black          SHD Shadow BBL Bridal Blanco    SLG Slate Grey  Wood Grain Patterns: AGA Aged Ash      GRH Graphite ALL Ale Light      HGL High Line BLO Blonde Echo    OAT Oatmeal Cookie BOL Bourbon Light    PIN Pinnacle Walnut BZW Brazilwood      STU Studio Teak BGL Brighton Light    VIN Vintage CLL Collectors        WLH Walnut Heights FLO Florence Walnut    WEA Weathered Ash	Color: Standard (T1) laminates have a matching PVC. AGA Aged Ash ALB Alabaster ALL Ale Light BLK Black BLO Blonde Echo BOL Bourbon Light BZW Brazilwood BBL Bridal Blanco BGL Brighton Light CLL Collectors DWH Designer White FLO Florence Walnut GRH Graphite HGL High Line OAT Oatmeal Cookie PIN Pinnacle Walnut SHD Shadow SLG Slate Grey STU Studio Teak VIN Vintage WLH Walnut Heights WEA Weathered Ash	N None CO_EC23 Cut out for EC23 CO_EC24 Cut out for EC24	BWH Bright White Feet & Post MBK Matte Black Feet & Post PEW Pewter Feet & Post ASLASL Arctic Silver Feet & Post ASLBWH Arctic Silver Feet & Bright White Post ASLMBK Arctic Silver Feet & Matte Black Post ASLPEW Arctic Silver Feet & Pewter Post PAMASL Polished Aluminum Feet & Arctic Silver Post PAMBWH Polished Aluminum Feet & Bright White Post PAMMBK Polished Aluminum Feet & Matte Black Post PAMPEW Polished Aluminum Feet & Pewter Post
		Graded-In Laminates (T2) & (T3) see pages 156-161	PVC color must be selected with Graded-In Laminates (T2) & (T3)		

Model Number Breakdown

NST4242-42SQX					
NS	T	4242	42	SQ	X
Nosh	Laminate	42" x 42"	Height	Square Top Shape	X Base

Description

Square Bar Height Table with X Base  
(continued)

Veneer Tables  
"NSV" Models

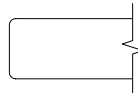

Eased Edge (R3)

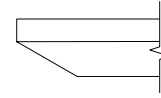

Reverse Bevel Edge (K9)

VENEER	D	W	H	CTN WT	CU FT	1 Model	Flat Cut	Double Cut	Flat Cut	Double Cut
	42	42	42	88	23	NSV4242-42SQX	\$1,679	\$1,789	\$1,742	\$1,857
36	36	42	72	18	NSV3636-42SQX	\$1,491	\$1,589	\$1,547	\$1,648	
30	30	42	58	18	NSV3030-42SQX	\$1,339	\$1,427	\$1,390	\$1,481	

NOSH

To Order Specify

1 Veneer Model #	2 Edge Detail	3 Wood Species	4 Wood Finish			5 Electrical Cut Out	6 Metal Finish
Veneer (NSV)	R3 Eased K9 Reverse Bevel	<b>Flat Cut</b> CH1 Cherry MA1 Maple WA1 Walnut	Cherry: BRL Barley BBM Bourbon Medium BRM Brighton Medium CLA Classic CLL Collectors* EAR Earthy HRV Harvest* LGC Legacy PRL Praline* SAF Saffron	Maple: ALM Ale Medium BUT Butterscotch CIN Cinnamon FLX Flax VEN Venetian	Walnut: AUB Auburn ESP Espresso MCH Mocha* NTO Night Owl* SIE Sienna* TOF Toffee TRF Truffle*	N None CO_EC23 Cut out for EC23 CO_EC24 Cut out for EC24	BWH Bright White Feet & Post MBK Matte Black Feet & Post PEW Pewter Feet & Post ASLASL Arctic Silver Feet & Post ASLBWH Arctic Silver Feet & Bright White Post ASLMBK Arctic Silver Feet & Matte Black Post ASLPEW Arctic Silver Feet & Pewter Post PAMASL Polished Aluminum Feet & Arctic Silver Post PAMBWH Polished Aluminum Feet & Bright White Post PAMMBK Polished Aluminum Feet & Matte Black Post PAMPPEW Polished Aluminum Feet & Pewter Post
			<b>Double Cut</b> DC2 Double Cut	<b>4 Wood Finish</b> Double Cut: COF Coffee FOS Fossil KHK Khaki CRM Cremello GRH Graphite STU Studio Teak			

Description

Rounded Square Bar Height Table with X Base

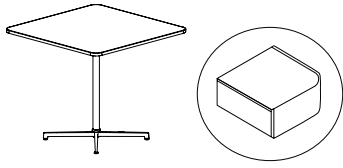

Laminate Tables "NST" Models

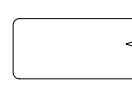

Eased Edge (R3)

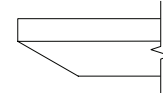

Reverse Bevel (K9)

LAMINATE	D	W	H	CTN WT	CU FT	① Model	Eased Edge (R3)			Reverse Bevel (K9)		
							Standard	Graded In		Standard	Graded In	
							Tier 1	Tier 2	Tier 3	Tier 1	Tier 2	Tier 3
	42	42	42	88	23	NST4242-42SQRX	\$1,586	\$1,629	\$1,772	\$1,955	\$1,999	\$2,142
	36	36	42	71	18	NST3636-42SQRX	\$1,327	\$1,361	\$1,415	\$1,696	\$1,732	\$1,785
	30	30	42	56	18	NST3030-42SQRX	\$1,189	\$1,220	\$1,252	\$1,560	\$1,589	\$1,621

Features:

- price reflects complete table - top and base
- ships KD in multiple cartons
- top has option for cutout to receive electrical component, ordered separately
- when electrical cut out selected, power accessible base is sent - add \$95
- base has leveling glides
- width of base foot varies from 26" to 38"

HSON

To Order Specify

① Laminate Model #	② Edge Detail	③ Laminate Selection	③a PVC Edge Color	④ Electrical Cut Out	⑤ Metal Finish
Laminate (NST)	R3 Eased	<b>Standard Laminates (T1)</b> Solid Patterns: ALB Alabaster      DWH Designer White BLK Black          SHD Shadow BBL Bridal Blanco    SLG Slate Grey  Wood Grain Patterns: AGA Aged Ash      GRH Graphite ALL Ale Light      HGL High Line BLO Blonde Echo    OAT Oatmeal Cookie BOL Bourbon Light    PIN Pinnacle Walnut BZW Brazilwood      STU Studio Teak BGL Brighton Light    VIN Vintage CLL Collectors      WLH Walnut Heights FLO Florence Walnut    WEA Weathered Ash	Color: Standard (T1) laminates have a matching PVC. AGA Aged Ash ALB Alabaster ALL Ale Light BLK Black BLO Blonde Echo BOL Bourbon Light BZW Brazilwood BBL Bridal Blanco BGL Brighton Light CLL Collectors DWH Designer White FLO Florence Walnut GRH Graphite HGL High Line OAT Oatmeal Cookie PIN Pinnacle Walnut SHD Shadow SLG Slate Grey STU Studio Teak VIN Vintage WLH Walnut Heights WEA Weathered Ash	N None CO_EC23 Cut out for EC23 CO_EC24 Cut out for EC24	BWH Bright White Feet & Post MBK Matte Black Feet & Post PEW Pewter Feet & Post ASLASL Arctic Silver Feet & Post ASLBWH Arctic Silver Feet & Bright White Post ASLMBK Arctic Silver Feet & Matte Black Post ASLPEW Arctic Silver Feet & Pewter Post PAMASL Polished Aluminum Feet & Arctic Silver Post PAMBWH Polished Aluminum Feet & Bright White Post PAMMBK Polished Aluminum Feet & Matte Black Post PAMPEW Polished Aluminum Feet & Pewter Post
	K9 Reverse Bevel				

Model Number Breakdown

NST4242-42SQRX						
NS	T	4242	42	SQ	R	X
Nosh	Laminate	42" x 42"	Height	Square Top Shape	Rounded Corner	X base

Description

Rounded Square Bar Height Table  
with X Base  
(continued)

Veneer Tables  
"NSV" Models

Solid Surface Tables  
"NSS" Models

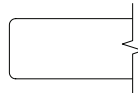

Eased Edge (R3)

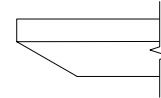

Reverse Bevel Edge (K9)

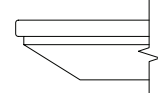

Reverse Bevel Edge (S7)

	D	W	H	CTN WT	CU FT	① Model	Eased Edge (R3)		Reverse Bevel Edge (K9)		Standard
							Flat Cut	Double Cut	Flat Cut	Double Cut	
VENEER	42	42	42	88	23	NSV4242-42SQRX	\$2,067	\$2,204	\$2,147	\$2,290	--
	36	36	42	71	18	NSV3636-42SQRX	\$1,718	\$1,831	\$1,782	\$1,901	--
	30	30	42	56	18	NSV3030-42SQRX	\$1,539	\$1,639	\$1,596	\$1,700	--
SOL SURF	42	42	42	117	23	NSS4242-42SQRX	--	--	--	--	\$3,986
	36	36	42	93	18	NSS3636-42SQRX	--	--	--	--	\$3,230
	30	30	42	70	18	NSS3030-42SQRX	--	--	--	--	\$2,706

NOSH

To Order Specify

① Veneer Model #	② Edge Detail	③ Wood Species	④ Wood Finish	⑤ Electrical Cut Out	⑥ Metal Finish
Veneer (NSV)	R3 Eased K9 Reverse Bevel	<b>Flat Cut</b> CH1 Cherry MA1 Maple WA1 Walnut	<p>Cherry: BRL Barley BBM Bourbon Medium BRM Brighton Medium CLA Classic CLL Collectors* EAR Earthy HRV Harvest* LGC Legacy PRL Praline* SAF Saffron</p> <p>Maple: ALM Ale Medium BUT Butterscotch CIN Cinnamon FLX Flax VEN Venetian</p> <p>Walnut: AUB Auburn ESP Espresso MCH Mocha* NTO Night Owl* SIE Sienna* TOF Toffee* TRF Truffle*</p> <p>*finishes with coordinating laminate tops</p>	N None CO_EC23 Cut out for EC23 CO_EC24 Cut out for EC24	<p>BWH Bright White Feet &amp; Post MBK Matte Black Feet &amp; Post PEW Pewter Feet &amp; Post ASLASL Arctic Silver Feet &amp; Post ASLBWH Arctic Silver Feet &amp; Bright White Post ASLMBK Arctic Silver Feet &amp; Matte Black Post ASLPEW Arctic Silver Feet &amp; Pewter Post PAMASL Polished Aluminum Feet &amp; Arctic Silver Post PAMBWH Polished Aluminum Feet &amp; Bright White Post PAMMBK Polished Aluminum Feet &amp; Matte Black Post PAMPEW Polished Aluminum Feet &amp; Pewter Post</p>
		<b>Double Cut</b> DC2 Double Cut	<b>④ Wood Finish</b> Double Cut: COF Coffee FOS Fossil KHK Khaki CRM Cremello GRH Graphite STU Studio Teak		

① Solid Surface Model #	② Edge Detail	③ Solid Surface	④ Electrical Cut Out	⑤ Metal Finish
Solid Surface (NSS)	S7 Reverse Bevel	<b>Tier 1</b> ARM Armadillo BLP Black Pearl GRA Graphite Granite PEB Pebble Pearl PUR Pure White	N None CO_EC23 Cut out for EC23 CO_EC24 Cut out for EC24	<p>BWH Bright White Feet &amp; Post MBK Matte Black Feet &amp; Post PEW Pewter Feet &amp; Post ASLASL Arctic Silver Feet &amp; Post ASLBWH Arctic Silver Feet &amp; Bright White Post ASLMBK Arctic Silver Feet &amp; Matte Black Post ASLPEW Arctic Silver Feet &amp; Pewter Post PAMASL Polished Aluminum Feet &amp; Arctic Silver Post PAMBWH Polished Aluminum Feet &amp; Bright White Post PAMMBK Polished Aluminum Feet &amp; Matte Black Post PAMPEW Polished Aluminum Feet &amp; Pewter Post</p>

Description

Square Bar Height Table with X4 Base

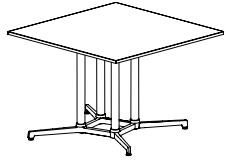

Laminate Tables  
"NST" Models

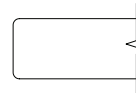

Eased Edge (R3)

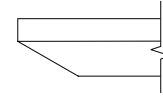

Reverse Bevel Edge (K9)

LAMINATE	D	W	H	CTN WT	CU FT	① Model	Eased Edge (R3)			Reverse Bevel Edge (K9)		
							Standard	Graded In		Standard	Graded In	
							Tier 1	Tier 2	Tier 3	Tier 1	Tier 2	Tier 3
	60	60	42	163	50	NST6060-42SQZ	\$2,591	\$2,666	\$2,836	\$2,960	\$3,036	\$3,207
	54	54	42	186	43	NST5454-42SQZ	\$2,468	\$2,535	\$2,668	\$2,838	\$2,904	\$3,037
	48	48	42	142	68	NST4848-42SQZ	\$2,059	\$2,104	\$2,216	\$2,428	\$2,473	\$2,585

Features:

- price reflects complete table - top and base
- ships KD in multiple cartons
- top has option for cut out to receive electrical component, order separately
- optional vertical wire manager for base, order separately
- base has leveling glides
- width of base foot is 38"

HSON

To Order Specify

① Laminate Model #	② Edge Detail	③ Laminate Selection	③a PVC Edge Color	④ Electrical Cut Out	⑤ Metal Finish
Laminate (NST)	R3 Eased K9 Reverse Bevel	<b>Standard Laminates (T1)</b> Solid Patterns: ALB Alabaster      DWH Designer White BLK Black          SHD Shadow BBL Bridal Blanco    SLG Slate Grey  Wood Grain Patterns: AGA Aged Ash      GRH Graphite ALL Ale Light      HGL High Line BLO Blonde Echo    OAT Oatmeal Cookie BOL Bourbon Light    PIN Pinnacle Walnut BZW Brazilwood      STU Studio Teak BGL Brighton Light    VIN Vintage CLL Collectors        WLH Walnut Heights FLO Florence Walnut    WEA Weathered Ash	Color: Standard (T1) laminates have a matching PVC. AGA Aged Ash ALB Alabaster ALL Ale Light BLK Black BLO Blonde Echo BOL Bourbon Light BZW Brazilwood BBL Bridal Blanco BGL Brighton Light CLL Collectors DWH Designer White FLO Florence Walnut GRH Graphite HGL High Line OAT Oatmeal Cookie PIN Pinnacle Walnut SHD Shadow SLG Slate Grey STU Studio Teak VIN Vintage WLH Walnut Heights WEA Weathered Ash	N None CO_EC23 Cut out for EC23 CO_EC24 Cut out for EC24	BWH Bright White Feet & Post MBK Matte Black Feet & Post PEW Pewter Feet & Post ASLASL Arctic Silver Feet & Post ASLBWH Arctic Silver Feet & Bright White Post ASLMBK Arctic Silver Feet & Matte Black Post ASLPEW Arctic Silver Feet & Pewter Post PAMASL Polished Aluminum Feet & Arctic Silver Post PAMBWH Polished Aluminum Feet & Bright White Post PAMMBK Polished Aluminum Feet & Matte Black Post PAMPEW Polished Aluminum Feet & Pewter Post
		Graded-In Laminates (T2) & (T3) see pages 156-161	PVC color must be selected with Graded-In Laminates (T2) & (T3)		

Model Number Breakdown

NST6060-42SQZ					
NS	T	6060	42	SQ	Z
Nosh	Laminate	60" x 60"	Height	Square Top Shape	X4 base

Description

Square Bar Height Table with X4 Base  
(continued)

Veneer Tables  
"NSV" Models

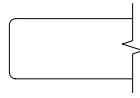

Eased Edge (R3)

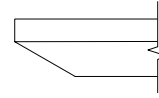

Reverse Bevel Edge (K9)

VENEER	D	W	H	CTN WT	CU FT	1 Model	Flat Cut	Double Cut	Flat Cut	Double Cut
	60	60	42	163	50	NSV6060-42SQZ	\$3,354	\$3,575	\$3,480	\$3,710
54	54	42	186	43	NSV5454-42SQZ	\$3,192	\$3,402	\$3,312	\$3,531	
48	48	42	142	68	NSV4848-42SQZ	\$2,476	\$2,597	\$2,545	\$2,672	

To Order Specify

1 Veneer Model #	2 Edge Detail	3 Wood Species	4 Wood Finish			5 Electrical Cut Out	6 Metal Finish
Veneer (NSV)	R3 Eased K9 Reverse Bevel	<b>Flat Cut</b> CH1 Cherry MA1 Maple WA1 Walnut	Cherry: BRL Barley BBM Bourbon Medium BRM Brighton Medium CLA Classic CLL Collectors* EAR Earthy HRV Harvest* LGC Legacy PRL Praline* SAF Saffron	Maple: ALM Ale Medium BUT Butterscotch CIN Cinnamon FLX Flax VEN Venetian	Walnut: AUB Auburn ESP Espresso MCH Mocha* NTO Night Owl* SIE Sienna* TOF Toffee TRF Truffle*	N None CO_EC23 Cut out for EC23 CO_EC24 Cut out for EC24	BWH Bright White Feet & Post MBK Matte Black Feet & Post PEW Pewter Feet & Post ASLASL Arctic Silver Feet & Post ASLBWH Arctic Silver Feet & Bright White Post ASLMBK Arctic Silver Feet & Matte Black Post ASLPEW Arctic Silver Feet & Pewter Post PAMASL Polished Aluminum Feet & Arctic Silver Post PAMBWH Polished Aluminum Feet & Bright White Post PAMMBK Polished Aluminum Feet & Matte Black Post PAMPPEW Polished Aluminum Feet & Pewter Post
	<b>Double Cut</b> DC2 Double Cut	<b>4 Wood Finish</b> Double Cut: COF Coffee FOS Fossil KHK Khaki CRM Cremello GRH Graphite STU Studio Teak	*finishes with coordinating laminate tops				

NOSH



Description

Rounded Square Bar Height Table with X4 Base

Laminate Tables "NST" Models

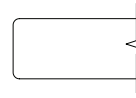
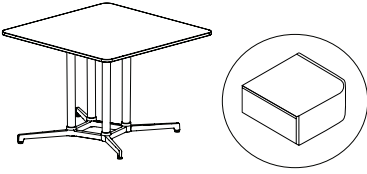

Eased Edge (R3)

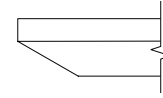

Reverse Bevel (K9)

LAMINATE	D	W	H	CTN WT	CU FT	① Model	Standard			Graded In		
							Tier 1	Tier 2	Tier 3	Tier 1	Tier 2	Tier 3
							60	60	42	180	50	<b>NST6060-42SQRZ</b>
54	54	42	157	43	<b>NST5454-42SQRZ</b>	\$2,308	\$2,374	\$2,506	\$2,677	\$2,743	\$2,876	
48	48	42	142	68	<b>NST4848-42SQRZ</b>	\$2,359	\$2,405	\$2,538	\$2,729	\$2,774	\$2,907	

Features:

- price reflects complete table - top and base
- ships KD in multiple cartons
- top has option for cut out to receive electrical component, order separately
- optional vertical wire manager for base, order separately
- base has leveling glides
- width of base foot is 38"

HSON

To Order Specify

① Laminate Model #	② Edge Detail	③ Laminate Selection	③a PVC Edge Color	④ Electrical Cut Out	⑤ Metal Finish
Laminate (NST)	R3 Eased	<b>Standard Laminates (T1)</b> Solid Patterns: ALB Alabaster      DWH Designer White BLK Black          SHD Shadow BBL Bridal Blanco    SLG Slate Grey  Wood Grain Patterns: AGA Aged Ash      GRH Graphite ALL Ale Light        HGL High Line BLO Blonde Echo    OAT Oatmeal Cookie BOL Bourbon Light    PIN Pinnacle Walnut BZW Brazilwood      STU Studio Teak BGL Brighton Light    VIN Vintage CLL Collectors        WLH Walnut Heights FLO Florence Walnut    WEA Weathered Ash	Color: <b>Standard (T1) laminates have a matching PVC.</b> AGA Aged Ash ALB Alabaster ALL Ale Light BLK Black BLO Blonde Echo BOL Bourbon Light BZW Brazilwood BBL Bridal Blanco BGL Brighton Light CLL Collectors DWH Designer White FLO Florence Walnut GRH Graphite HGL High Line OAT Oatmeal Cookie PIN Pinnacle Walnut SHD Shadow SLG Slate Grey STU Studio Teak VIN Vintage WLH Walnut Heights WEA Weathered Ash	N None CO_EC23 Cut out for EC23 CO_EC24 Cut out for EC24	BWH Bright White Feet & Post MBK Matte Black Feet & Post PEW Pewter Feet & Post ASLASL Arctic Silver Feet & Post ASLBWH Arctic Silver Feet & Bright White Post ASLMBK Arctic Silver Feet & Matte Black Post ASLPEW Arctic Silver Feet & Pewter Post PAMASL Polished Aluminum Feet & Arctic Silver Post PAMBWH Polished Aluminum Feet & Bright White Post PAMMBK Polished Aluminum Feet & Matte Black Post PAMPEW Polished Aluminum Feet & Pewter Post
	K9 Reverse Bevel				

Model Number Breakdown

NST6060-42SQRZ						
NS	T	6060	42	SQ	R	Z
Nosh	Laminate	60" x 60"	Height	Square Top Shape	Rounded Corner	X4 base

Description

Rounded Square Bar Height Table  
with X4 Base  
(continued)

Veneer Tables  
"NSV" Models

Solid Surface Tables  
"NSS" Models

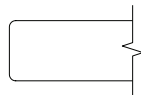

Eased Edge (R3)

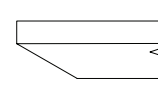

Reverse Bevel Edge (K9)

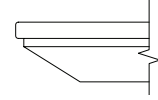

Reverse Bevel Edge (S7)

	D	W	H	CTN WT	CU FT	① Model	Eased Edge (R3)		Reverse Bevel Edge (K9)		Reverse Bevel Edge (S7)
							Flat Cut	Double Cut	Flat Cut	Double Cut	
VENEER	60	60	42	180	50	NSV6060-42SQRZ	\$3,605	\$3,844	\$3,743	\$3,989	--
	54	54	42	157	43	NSV5454-42SQRZ	\$2,981	\$3,175	\$3,093	\$3,295	--
	48	48	42	142	68	NSV4848-42SQRZ	\$2,871	\$3,021	\$2,957	\$3,112	--
SOL SURF	60	60	42	247	50	NSS6060-42SQRZ	--	--	--	--	\$7,118
	54	54	42	212	43	NSS5454-42SQRZ	--	--	--	--	\$5,900
	48	48	42	142	68	NSS4848-42SQRZ	--	--	--	--	\$4,607

NOSH

To Order Specify

① Veneer Model #	② Edge Detail	③ Wood Species	④ Wood Finish	⑤ Electrical Cut Out	⑥ Metal Finish
Veneer (NSV)	R3 Eased K9 Reverse Bevel	<b>Flat Cut</b> CH1 Cherry MA1 Maple WA1 Walnut	Cherry: BRL Barley BBM Bourbon Medium BRM Brighton Medium CLA Classic CLL Collectors* EAR Earthy HRV Harvest* LGC Legacy PRL Praline* SAF Saffron  Maple: ALM Ale Medium BUT Butterscotch CIN Cinnamon FLX Flax VEN Venetian  Walnut: AUB Auburn ESP Espresso MCH Mocha* NTO Night Owl* SIE Sienna* TOF Toffee* TRF Truffle*  *finishes with coordinating laminate tops	N None CO_EC23 Cut out for EC23 CO_EC24 Cut out for EC24	BWH Bright White Feet & Post MBK Matte Black Feet & Post PEW Pewter Feet & Post ASLASL Arctic Silver Feet & Post ASLBWH Arctic Silver Feet & Bright White Post ASLMBK Arctic Silver Feet & Matte Black Post ASLPEW Arctic Silver Feet & Pewter Post PAMASL Polished Aluminum Feet & Arctic Silver Post PAMBWH Polished Aluminum Feet & Bright White Post PAMMBK Polished Aluminum Feet & Matte Black Post PAMPEW Polished Aluminum Feet & Pewter Post
		<b>Double Cut</b> DC2 Double Cut	<b>④ Wood Finish</b>  Double Cut: COF Coffee FOS Fossil KHK Khaki CRM Cremello GRH Graphite STU Studio Teak		

① Solid Surface Model #	② Edge Detail	③ Solid Surface	④ Electrical Cut Out	⑤ Metal Finish
Solid Surface (NSS)	S7 Reverse Bevel	<b>Tier 1</b> ARM Armadillo BLP Black Pearl GRA Graphite Granite PEB Pebble Pearl PUR Pure White	N None CO_EC23 Cut out for EC23 CO_EC24 Cut out for EC24	BWH Bright White Feet & Post MBK Matte Black Feet & Post PEW Pewter Feet & Post ASLASL Arctic Silver Feet & Post ASLBWH Arctic Silver Feet & Bright White Post ASLMBK Arctic Silver Feet & Matte Black Post ASLPEW Arctic Silver Feet & Pewter Post PAMASL Polished Aluminum Feet & Arctic Silver Post PAMBWH Polished Aluminum Feet & Bright White Post PAMMBK Polished Aluminum Feet & Matte Black Post PAMPEW Polished Aluminum Feet & Pewter Post

Description

Square Bar Height Table with Round Disc Base

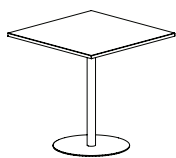

Laminate Tables  
"NST" Models

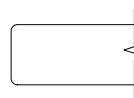

Eased Edge (R3)

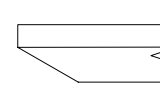

Reverse Bevel Edge (K9)

LAMINATE	D	W	H	CTN WT	CU FT	① Model	Eased Edge (R3)			Reverse Bevel Edge (K9)		
							Standard	Graded In		Standard	Graded In	
							Tier 1	Tier 2	Tier 3	Tier 1	Tier 2	Tier 3
	42	42	42	131	21	NST4242-42SQR	\$1,186	\$1,229	\$1,265	\$1,556	\$1,598	\$1,635
	36	36	42	97	20	NST3636-42SQR	\$1,089	\$1,123	\$1,146	\$1,459	\$1,494	\$1,517
	30	30	42	84	16	NST3030-42SQR	\$1,035	\$1,066	\$1,077	\$1,406	\$1,435	\$1,447

Features:

- price reflects complete table - top and base
- ships KD in multiple cartons
- cut out for power is not available on these tables
- base has anti-rock glides
- width of base foot varies from 22" or 27"

HSON

To Order Specify

① Laminate Model #	② Edge Detail	③ Laminate Selection	③a PVC Edge Color	④ Metal Finish
Laminate (NST)	R3 Eased K9 Reverse Bevel	<b>Standard Laminates (T1)</b> Solid Patterns: ALB Alabaster      DWH Designer White BLK Black          SHD Shadow BBL Bridal Blanco    SLG Slate Grey  Wood Grain Patterns: AGA Aged Ash      GRH Graphite ALL Ale Light      HGL High Line BLO Blonde Echo    OAT Oatmeal Cookie BOL Bourbon Light    PIN Pinnacle Walnut BZW Brazilwood      STU Studio Teak BGL Brighton Light    VIN Vintage CLL Collectors        WLH Walnut Heights FLO Florence Walnut    WEA Weathered Ash	Color: Standard (T1) laminates have a matching PVC. AGA Aged Ash ALB Alabaster ALL Ale Light BLK Black BLO Blonde Echo BOL Bourbon Light BZW Brazilwood BBL Bridal Blanco BGL Brighton Light CLL Collectors DWH Designer White FLO Florence Walnut GRH Graphite HGL High Line OAT Oatmeal Cookie PIN Pinnacle Walnut SHD Shadow SLG Slate Grey STU Studio Teak VIN Vintage WLH Walnut Heights WEA Weathered Ash	BWH Bright White Feet & Post MBK Matte Black Feet & Post PEW Pewter Feet & Post ASLASL Arctic Silver Feet & Post ASLBWH Arctic Silver Feet & Bright White Post ASLMBK Arctic Silver Feet & Matte Black Post ASLPEW Arctic Silver Feet & Pewter Post
		Graded-In Laminates (T2) & (T3) see pages 156-161	PVC color must be selected with Graded-In Laminates (T2) & (T3)	

Model Number Breakdown

NST4242-42SQR					
NS	T	4242	42	SQ	R
Nosh	Laminate	42" x 42"	Height	Square Top Shape	Round Disc Base

Description

Square Bar Height Table with Round Disc Base (continued)

Veneer Tables "NSV" Models

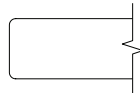

Eased Edge (R3)

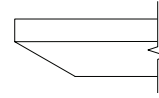

Reverse Bevel Edge (K9)

VENEER	D	W	H	CTN WT	CU FT	1 Model	Eased Edge (R3)		Reverse Bevel Edge (K9)	
							Flat Cut	Double Cut	Flat Cut	Double Cut
	42	42	42	131	21	NSV4242-42SQR	\$1,498	\$1,595	\$1,552	\$1,655
	36	36	42	97	20	NSV3636-42SQR	\$1,369	\$1,457	\$1,419	\$1,511
	30	30	42	84	16	NSV3030-42SQR	\$1,299	\$1,383	\$1,348	\$1,435

To Order Specify

1 Veneer Model #	2 Edge Detail	3 Wood Species	4 Wood Finish			5 Metal Finish
Veneer (NSV)	R3 Eased	<b>Flat Cut</b> CH1 Cherry MA1 Maple WA1 Walnut	Cherry:	Maple:	Walnut:	<b>BWH</b> Bright White Feet & Post <b>MBK</b> Matte Black Feet & Post <b>PEW</b> Pewter Feet & Post <b>ASLASL</b> Arctic Silver Feet & Post <b>ASLBWH</b> Arctic Silver Feet & Bright White Post <b>ASLMBK</b> Arctic Silver Feet & Matte Black Post <b>ASLPEW</b> Arctic Silver Feet & Pewter Post
	K9 Reverse Bevel		BRL Barley BBM Bourbon Medium BRM Brighton Medium CLA Classic CLL Collectors* EAR Earthy HRV Harvest* LGC Legacy PRL Praline* SAF Saffron	ALM Ale Medium BUT Butterscotch CIN Cinnamon FLX Flax VEN Venetian	AUB Auburn ESP Espresso MCH Mocha* NTO Night Owl* SIE Sienna* TOF Toffee TRF Truffle*	
		<b>Double Cut</b> DC2 Double Cut	<b>4 Wood Finish</b> Double Cut: COF Coffee    FOS Fossil    KHK Khaki CRM Cremello    GRH Graphite    STU Studio Teak			

NOSH

Description

Rounded Square Bar Height Table with Round Disc Base

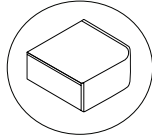
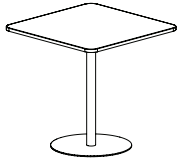

Laminate Tables "NST" Models

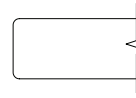

Eased Edge (R3)

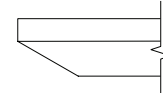

Reverse Bevel (K9)

LAMINATE	D	W	H	CTN WT	CU FT	① Model	Eased Edge (R3)			Reverse Bevel (K9)		
							Standard	Graded In		Standard	Graded In	
							Tier 1	Tier 2	Tier 3	Tier 1	Tier 2	Tier 3
	42	42	42	131	21	NST4242-42SQRR	\$1,475	\$1,519	\$1,596	\$1,845	\$1,888	\$1,965
	36	36	42	97	20	NST3636-42SQRR	\$1,260	\$1,296	\$1,349	\$1,630	\$1,667	\$1,719
	30	30	42	83	16	NST3030-42SQRR	\$1,186	\$1,218	\$1,249	\$1,556	\$1,587	\$1,618

Features:

- price reflects complete table - top and base
- ships KD in multiple cartons
- cut out for power is not available on these tables
- base has anti-rock glides
- width of base foot varies from 22" or 27"

HSON

To Order Specify

① Laminate Model #	② Edge Detail	③ Laminate Selection	③a PVC Edge Color	④ Metal Finish
Laminate (NST)	R3 Eased K9 Reverse Bevel	<b>Standard Laminates (T1)</b> Solid Patterns: ALB Alabaster      DWH Designer White BLK Black          SHD Shadow BBL Bridal Blanco    SLG Slate Grey  Wood Grain Patterns: AGA Aged Ash      GRH Graphite ALL Ale Light      HGL High Line BLO Blonde Echo    OAT Oatmeal Cookie BOL Bourbon Light    PIN Pinnacle Walnut BZW Brazilwood      STU Studio Teak BGL Brighton Light    VIN Vintage CLL Collectors        WLH Walnut Heights FLO Florence Walnut    WEA Weathered Ash	Color: Standard (T1) laminates have a matching PVC. AGA Aged Ash ALB Alabaster ALL Ale Light BLK Black BLO Blonde Echo BOL Bourbon Light BZW Brazilwood BBL Bridal Blanco BGL Brighton Light CLL Collectors DWH Designer White FLO Florence Walnut GRH Graphite HGL High Line OAT Oatmeal Cookie PIN Pinnacle Walnut SHD Shadow SLG Slate Grey STU Studio Teak VIN Vintage WLH Walnut Heights WEA Weathered Ash	BWH Bright White Feet & Post MBK Matte Black Feet & Post PEW Pewter Feet & Post ASLASL Arctic Silver Feet & Post ASLBWH Arctic Silver Feet & Bright White Post ASLMBK Arctic Silver Feet & Matte Black Post ASLPEW Arctic Silver Feet & Pewter Post
		Graded-In Laminates (T2) & (T3) see pages 156-161	PVC color must be selected with Graded-In Laminates (T2) & (T3)	

Model Number Breakdown

NST4242-42SQRR						
NS	T	4242	42	SQ	R	R
Nosh	Laminate	42" x 42"	Height	Square Top Shape	Rounded Corner	Round Disc Base

Description

Rounded Square Bar Height Table with Round Disc Base  
(continued)

		Veneer Tables "NSV" Models				Solid Surface Tables "NSS" Models					
		Eased Edge (R3)		Reverse Bevel Edge (K9)		Reverse Bevel Edge (S7)					
		Flat Cut	Double Cut	Flat Cut	Double Cut	Standard					
	D	W	H	CTN WT	CU FT	① Model	Flat Cut	Double Cut	Flat Cut	Double Cut	Standard
VENEER	42	42	42	131	21	NSV4242-42SQRR	\$1,878	\$2,004	\$1,951	\$2,081	--
	36	36	42	97	20	NSV3636-42SQRR	\$1,595	\$1,699	\$1,655	\$1,764	--
	30	30	42	83	16	NSV3030-42SQRR	\$1,498	\$1,595	\$1,552	\$1,655	--
SOL SURF	42	42	42	160	21	NSS4242-42SQRR	--	--	--	--	\$3,797
	36	36	42	118	20	NSS3636-42SQRR	--	--	--	--	\$3,106
	30	30	42	86	16	NSS3030-42SQRR	--	--	--	--	\$2,664

To Order Specify

① Veneer Model #	② Edge Detail	③ Wood Species	④ Wood Finish	⑤ Metal Finish		
Veneer (NSV)	R3 Eased K9 Reverse Bevel	<b>Flat Cut</b> CH1 Cherry MA1 Maple WA1 Walnut	Cherry: BRL Barley BBM Bourbon Medium BRM Brighton Medium CLA Classic CLL Collectors* EAR Earthy HRV Harvest* LGC Legacy PRL Praline* SAF Saffron	Maple: ALM Ale Medium BUT Butterscotch CIN Cinnamon FLX Flax VEN Venetian	Walnut: AUB Auburn ESP Espresso MCH Mocha* NTO Night Owl* SIE Sienna* TOF Toffee TRF Truffle*	BWH Bright White Feet & Post MBK Matte Black Feet & Post PEW Pewter Feet & Post ASLASL Arctic Silver Feet & Post ASLBWH Arctic Silver Feet & Bright White Post ASLMBK Arctic Silver Feet & Matte Black Post ASLPEW Arctic Silver Feet & Pewter Post
		<b>Double Cut</b> DC2 Double Cut	<b>④ Wood Finish</b> Double Cut: COF Coffee FOS Fossil KHK Khaki CRM Cremello GRH Graphite STU Studio Teak	*finishes with coordinating laminate tops		

① Solid Surface Model #	② Edge Detail	③ Solid Surface	④ Metal Finish
Solid Surface (NSS)	S7 Reverse Bevel	<b>Tier 1</b> ARM Armadillo BLP Black Pearl GRA Graphite Granite PEB Pebble Pearl PUR Pure White	BWH Bright White Feet & Post MBK Matte Black Feet & Post PEW Pewter Feet & Post ASLASL Arctic Silver Feet & Post ASLBWH Arctic Silver Feet & Bright White Post ASLMBK Arctic Silver Feet & Matte Black Post ASLPEW Arctic Silver Feet & Pewter Post

Description

Square Bar Height Table with Square Disc Base

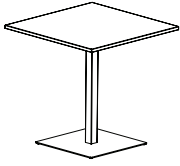

Laminate Tables  
"NST" Models

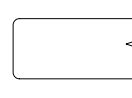

Eased Edge (R3)

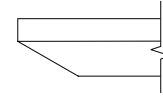

Reverse Bevel Edge (K9)

LAMINATE	D	W	H	CTN WT	CU FT	① Model	Eased Edge (R3)			Reverse Bevel Edge (K9)		
							Standard	Graded In		Standard	Graded In	
							Tier 1	Tier 2	Tier 3	Tier 1	Tier 2	Tier 3
	42	42	42	131	21	NST4242-42SQS	\$1,368	\$1,410	\$1,446	\$1,737	\$1,779	\$1,815
	36	36	42	97	20	NST3636-42SQS	\$1,214	\$1,249	\$1,272	\$1,584	\$1,618	\$1,641
	30	30	42	84	16	NST3030-42SQS	\$1,161	\$1,192	\$1,202	\$1,530	\$1,561	\$1,571

Features:

- price reflects complete table - top and base
- ships KD in multiple cartons
- cut out for power is not available on these tables
- width of base foot varies from 22" or 27"

HSON

To Order Specify

① Laminate Model #	② Edge Detail	③ Laminate Selection	③a PVC Edge Color	④ Metal Finish
Laminate (NST)	R3 Eased K9 Reverse Bevel	<b>Standard Laminates (T1)</b> Solid Patterns: ALB Alabaster      DWH Designer White BLK Black          SHD Shadow BBL Bridal Blanco    SLG Slate Grey  Wood Grain Patterns: AGA Aged Ash      GRH Graphite ALL Ale Light      HGL High Line BLO Blonde Echo    OAT Oatmeal Cookie BOL Bourbon Light    PIN Pinnacle Walnut BZW Brazilwood      STU Studio Teak BGL Brighton Light    VIN Vintage CLL Collectors        WLH Walnut Heights FLO Florence Walnut    WEA Weathered Ash	Color: Standard (T1) laminates have a matching PVC. AGA Aged Ash ALB Alabaster ALL Ale Light BLK Black BLO Blonde Echo BOL Bourbon Light BZW Brazilwood BBL Bridal Blanco BGL Brighton Light CLL Collectors DWH Designer White FLO Florence Walnut GRH Graphite HGL High Line OAT Oatmeal Cookie PIN Pinnacle Walnut SHD Shadow SLG Slate Grey STU Studio Teak VIN Vintage WLH Walnut Heights WEA Weathered Ash	BWH Bright White Feet & Post MBK Matte Black Feet & Post PEW Pewter Feet & Post ASLASL Arctic Silver Feet & Post ASLBWH Arctic Silver Feet & Bright White Post ASLMBK Arctic Silver Feet & Matte Black Post ASLPEW Arctic Silver Feet & Pewter Post
		Graded-In Laminates (T2) & (T3) see pages 156-161	PVC color must be selected with Graded-In Laminates (T2) & (T3)	

Model Number Breakdown

NST4242-42SQS					
NS	T	4242	42	SQ	S
Nosh	Laminate	42" x 42"	Height	Square Top Shape	Square Disc Base

Description

Square Bar Height Table with Square Disc Base  
(continued)

Veneer Tables  
"NSV" Models

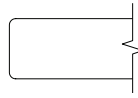

Eased Edge (R3)

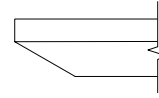

Reverse Bevel Edge (K9)

VENEER	D	W	H	CTN WT	CU FT	1 Model	Flat Cut	Double Cut	Flat Cut	Double Cut
	42	42	42	131	21	NSV4242-42SQS	\$1,736	\$1,920	\$1,802	\$1,921
36	36	42	97	20	NSV3636-42SQS	\$1,533	\$1,692	\$1,591	\$1,696	
30	30	42	84	16	NSV3030-42SQS	\$1,464	\$1,609	\$1,519	\$1,618	

To Order Specify

1 Veneer Model #	2 Edge Detail	3 Wood Species	4 Wood Finish	5 Metal Finish		
Veneer (NSV)	R3 Eased K9 Reverse Bevel	<b>Flat Cut</b> CH1 Cherry MA1 Maple WA1 Walnut	Cherry: BRL Barley BBM Bourbon Medium BRM Brighton Medium CLA Classic CLL Collectors* EAR Earthy HRV Harvest* LGC Legacy PRL Praline* SAF Saffron	Maple: ALM Ale Medium BUT Butterscotch CIN Cinnamon FLX Flax VEN Venetian *finishes with coordinating laminate tops	Walnut: AUB Auburn ESP Espresso MCH Mocha* NTO Night Owl* SIE Sienna* TOF Toffee TRF Truffle*	BWH Bright White Feet & Post MBK Matte Black Feet & Post PEW Pewter Feet & Post ASLASL Arctic Silver Feet & Post ASLBWH Arctic Silver Feet & Bright White Post ASLMBK Arctic Silver Feet & Matte Black Post ASLPEW Arctic Silver Feet & Pewter Post
	<b>Double Cut</b> DC2 Double Cut	<b>4 Wood Finish</b> Double Cut: COF Coffee FOS Fossil KHK Khaki CRM Cremello GRH Graphite STU Studio Teak				

NOSH



Description

Rounded Square Bar Height Table with Square Disc Base

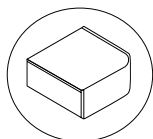
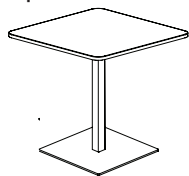

Laminate Tables "NST" Models



Eased Edge (R3)

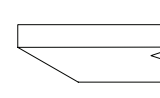

Reverse Bevel (K9)

LAMINATE	D	W	H	CTN WT	CU FT	① Model	Eased Edge (R3)			Reverse Bevel (K9)		
							Standard	Graded In		Standard	Graded In	
							Tier 1	Tier 2	Tier 3	Tier 1	Tier 2	Tier 3
	42	42	42	146	21	NST4242-42SQRS	\$1,656	\$1,699	\$1,777	\$2,025	\$2,068	\$2,146
	36	36	42	108	20	NST3636-42SQRS	\$1,386	\$1,422	\$1,474	\$1,755	\$1,791	\$1,844
	30	30	42	95	16	NST3030-42SQRS	\$1,312	\$1,342	\$1,374	\$1,681	\$1,713	\$1,743

Features:

- price reflects complete table - top and base
- ships KD in multiple cartons
- cut out for power is not available on these tables
- width of base foot varies from 22" or 27"

HSON

To Order Specify

① Laminate Model #	② Edge Detail	③ Laminate Selection	③a PVC Edge Color	④ Metal Finish
Laminate (NST)	R3 Eased K9 Reverse Bevel	<b>Standard Laminates (T1)</b> Solid Patterns: ALB Alabaster      DWH Designer White BLK Black          SHD Shadow BBL Bridal Blanco    SLG Slate Grey  Wood Grain Patterns: AGA Aged Ash      GRH Graphite ALL Ale Light      HGL High Line BLO Blonde Echo    OAT Oatmeal Cookie BOL Bourbon Light    PIN Pinnacle Walnut BZW Brazilwood      STU Studio Teak BGL Brighton Light    VIN Vintage CLL Collectors        WLH Walnut Heights FLO Florence Walnut    WEA Weathered Ash	Color: Standard (T1) laminates have a matching PVC. AGA Aged Ash ALB Alabaster ALL Ale Light BLK Black BLO Blonde Echo BOL Bourbon Light BZW Brazilwood BBL Bridal Blanco BGL Brighton Light CLL Collectors DWH Designer White FLO Florence Walnut GRH Graphite HGL High Line OAT Oatmeal Cookie PIN Pinnacle Walnut SHD Shadow SLG Slate Grey STU Studio Teak VIN Vintage WLH Walnut Heights WEA Weathered Ash	BWH Bright White Feet & Post MBK Matte Black Feet & Post PEW Pewter Feet & Post ASLASL Arctic Silver Feet & Post ASLBWH Arctic Silver Feet & Bright White Post ASLMBK Arctic Silver Feet & Matte Black Post ASLPEW Arctic Silver Feet & Pewter Post
		Graded-In Laminates (T2) & (T3) see pages 156-161	PVC color must be selected with Graded-In Laminates (T2) & (T3)	

Model Number Breakdown

NST4242-42SQRS						
NS	T	4242	42	SQ	R	S
Nosh	Laminate	42" x 42"	Height	Square Top Shape	Rounded Corner	Square Disc Base

Description

Rounded Square Bar Height Table with Square Disc Base (continued)

Veneer Tables "NSV" Models      Solid Surface Tables "NSS" Models

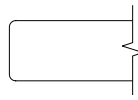

Eased Edge (R3)

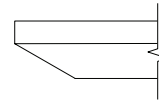

Reverse Bevel Edge (K9)

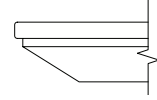

Reverse Bevel Edge (S7)

	D	W	H	CTN WT	CU FT	① Model	Eased Edge (R3)		Reverse Bevel Edge (K9)		Standard
							Flat Cut	Double Cut	Flat Cut	Double Cut	
VENEER	42	42	42	146	21	NSV4242-42SQRS	\$2,118	\$2,259	\$2,198	\$2,346	--
	36	36	42	108	20	NSV3636-42SQRS	\$1,926	\$2,054	\$2,000	\$2,133	--
	30	30	42	95	16	NSV3030-42SQRS	\$1,828	\$1,950	\$1,897	\$2,023	--
SOL SURF	42	42	42	175	21	NSS4242-42SQRS	--	--	--	--	\$4,036
	36	36	42	129	20	NSS3636-42SQRS	--	--	--	--	\$3,439
	30	30	42	93	16	NSS3030-42SQRS	--	--	--	--	\$2,995

NOSH

To Order Specify

Veneer Model #	② Edge Detail	③ Wood Species	④ Wood Finish	⑤ Metal Finish		
Veneer (NSV)	R3 Eased K9 Reverse Bevel	<b>Flat Cut</b> CH1 Cherry MA1 Maple WA1 Walnut	Cherry: BRL Barley BBM Bourbon Medium BRM Brighton Medium CLA Classic CLL Collectors* EAR Earthy HRV Harvest* LGC Legacy PRL Praline* SAF Saffron	Maple: ALM Ale Medium BUT Butterscotch CIN Cinnamon FLX Flax VEN Venetian	Walnut: AUB Auburn ESP Espresso MCH Mocha* NTO Night Owl* SIE Sienna* TOF Toffee TRF Truffle*	BWH Bright White Feet & Post MBK Matte Black Feet & Post PEW Pewter Feet & Post ASLASL Arctic Silver Feet & Post ASLBWH Arctic Silver Feet & Bright White Post ASLMBK Arctic Silver Feet & Matte Black Post ASLPEW Arctic Silver Feet & Pewter Post
		<b>Double Cut</b> DC2 Double Cut	<b>④ Wood Finish</b> Double Cut: COF Coffee    FOS Fossil    KHK Khaki CRM Cremello    GRH Graphite    STU Studio Teak	*finishes with coordinating laminate tops		

① Solid Surface Model #	② Edge Detail	③ Solid Surface	④ Metal Finish
Solid Surface (NSS)	S7 Reverse Bevel	<b>Tier 1</b> ARM Armadillo BLP Black Pearl GRA Graphite Granite PEB Pebble Pearl PUR Pure White	BWH Bright White Feet & Post MBK Matte Black Feet & Post PEW Pewter Feet & Post ASLASL Arctic Silver Feet & Post ASLBWH Arctic Silver Feet & Bright White Post ASLMBK Arctic Silver Feet & Matte Black Post ASLPEW Arctic Silver Feet & Pewter Post

Description

Squircle Bar Height Table with X Base



Laminate Tables  
"NST" Models

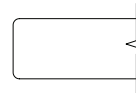

Eased Edge (R3)

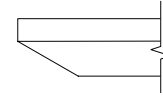

Reverse Bevel Edge (K9)

LAMINATE	D	W	H	CTN WT	CU FT	① Model	Eased Edge (R3)			Reverse Bevel Edge (K9)		
							Standard	Graded In		Standard	Graded In	
							Tier 1	Tier 2	Tier 3	Tier 1	Tier 2	Tier 3
	42	42	42	75	23	NST42-42SCX	\$1,283	\$1,378	\$1,457	\$1,654	\$1,749	\$1,828
	36	36	42	61	19	NST36-42SCX	\$1,244	\$1,280	\$1,335	\$1,614	\$1,649	\$1,704
	30	30	42	50	21	NST30-42SCX	\$1,202	\$1,231	\$1,264	\$1,572	\$1,602	\$1,635

Features:

- price reflects complete table - top and base
- ships KD in multiple cartons
- top has option for cutout to receive electrical component, ordered separately
- when electrical cut out selected, power accessible base is sent - add \$95
- base has leveling glides
- width of base foot varies from 26" to 38"

HSON

To Order Specify

① Laminate Model #	② Edge Detail	③ Laminate Selection	③a PVC Edge Color	④ Electrical Cut Out	⑤ Metal Finish
Laminate (NST)	R3 Eased K9 Reverse Bevel	<b>Standard Laminates (T1)</b> Solid Patterns: ALB Alabaster      DWH Designer White BLK Black          SHD Shadow BBL Bridal Blanco    SLG Slate Grey  Wood Grain Patterns: AGA Aged Ash      GRH Graphite ALL Ale Light      HGL High Line BLO Blonde Echo    OAT Oatmeal Cookie BOL Bourbon Light    PIN Pinnacle Walnut BZW Brazilwood      STU Studio Teak BGL Brighton Light    VIN Vintage CLL Collectors      WLH Walnut Heights FLO Florence Walnut    WEA Weathered Ash	Color: Standard (T1) laminates have a matching PVC. AGA Aged Ash ALB Alabaster ALL Ale Light BLK Black BLO Blonde Echo BOL Bourbon Light BZW Brazilwood BBL Bridal Blanco BGL Brighton Light CLL Collectors DWH Designer White FLO Florence Walnut GRH Graphite HGL High Line OAT Oatmeal Cookie PIN Pinnacle Walnut SHD Shadow SLG Slate Grey STU Studio Teak VIN Vintage WLH Walnut Heights WEA Weathered Ash	N None COB_EC23 Cut out for EC23 COB_EC24 Cut out for EC24	BWH Bright White Feet & Post MBK Matte Black Feet & Post PEW Pewter Feet & Post ASLASL Arctic Silver Feet & Post ASLBWH Arctic Silver Feet & Bright White Post ASLMBK Arctic Silver Feet & Matte Black Post ASLPEW Arctic Silver Feet & Pewter Post PAMASL Polished Aluminum Feet & Arctic Silver Post PAMBWH Polished Aluminum Feet & Bright White Post PAMMBK Polished Aluminum Feet & Matte Black Post PAMPEW Polished Aluminum Feet & Pewter Post
		Graded-In Laminates (T2) & (T3) see pages 156-161	PVC color must be selected with Graded-In Laminates (T2) & (T3)		

Model Number Breakdown

NST36-42SCX					
NS	T	36	42	SC	X
Nosh	Laminate	36"	Height	Squircle Top Shape	X Base

Description

Squirrel Bar Height Table with X Base  
(continued)

		Veneer Tables "NSV" Models				Solid Surface Tables "NSS" Models					
		Eased Edge (R3)		Reverse Bevel Edge (K9)		Reverse Bevel Edge (S7)					
		Flat Cut	Double Cut	Flat Cut	Double Cut	Standard					
	D	W	H	CTN WT	CU FT	① Model	Flat Cut	Double Cut	Flat Cut	Double Cut	Standard
VENEER	42	42	42	75	23	NSV42-42SCX	\$1,679	\$1,788	\$1,742	\$1,856	--
	36	36	42	61	19	NSV36-42SCX	\$1,628	\$1,734	\$1,691	\$1,800	--
	30	30	42	50	21	NSV30-42SCX	\$1,570	\$1,674	\$1,632	\$1,737	--
SOL SURF	42	42	42	98	23	NSS42-42SCX	--	--	--	--	\$3,613
	36	36	42	78	19	NSS36-42SCX	--	--	--	--	\$3,156
	30	30	42	61	21	NSS30-42SCX	--	--	--	--	\$3,043

NOSH

To Order Specify

① Veneer Model #	② Edge Detail	③ Wood Species	④ Wood Finish	⑤ Electrical Cut Out	⑥ Metal Finish		
Veneer (NSV)	R3 Eased K9 Reverse Bevel	<b>Flat Cut</b> CH1 Cherry MA1 Maple WA1 Walnut	Cherry: BRL Barley BBM Bourbon Medium BRM Brighton Medium CLA Classic CLL Collectors* EAR Earthy HRV Harvest* LGC Legacy PRL Praline* SAF Saffron	Maple: ALM Ale Medium BUT Butterscotch CIN Cinnamon FLX Flax VEN Venetian	Walnut: AUB Auburn ESP Espresso MCH Mocha* NTO Night Owl* SIE Sienna* TOF Toffee* TRF Truffle*	N None COB_EC23 Cut out for EC23 COB_EC24 Cut out for EC24	BWH Bright White Feet & Post MBK Matte Black Feet & Post PEW Pewter Feet & Post ASLASL Arctic Silver Feet & Post ASLBWH Arctic Silver Feet & Bright White Post ASLMBK Arctic Silver Feet & Matte Black Post ASLPEW Arctic Silver Feet & Pewter Post PAMASL Polished Aluminum Feet & Arctic Silver Post PAMBWH Polished Aluminum Feet & Bright White Post PAMMBK Polished Aluminum Feet & Matte Black Post PAMPEW Polished Aluminum Feet & Pewter Post
		<b>Double Cut</b> DC2 Double Cut	<b>④ Wood Finish</b> Double Cut: COF Coffee FOS Fossil KHK Khaki CRM Cremello GRH Graphite STU Studio Teak	*finishes with coordinating laminate tops			

① Solid Surface Model #	② Edge Detail	③ Solid Surface	④ Electrical Cut Out	⑤ Metal Finish
Solid Surface (NSS)	S7 Reverse Bevel	<b>Tier 1</b> ARM Armadillo BLP Black Pearl GRA Graphite Granite PEB Pebble Pearl PUR Pure White	N None COB_EC23 Cut out for EC23 COB_EC24 Cut out for EC24	BWH Bright White Feet & Post MBK Matte Black Feet & Post PEW Pewter Feet & Post ASLASL Arctic Silver Feet & Post ASLBWH Arctic Silver Feet & Bright White Post ASLMBK Arctic Silver Feet & Matte Black Post ASLPEW Arctic Silver Feet & Pewter Post PAMASL Polished Aluminum Feet & Arctic Silver Post PAMBWH Polished Aluminum Feet & Bright White Post PAMMBK Polished Aluminum Feet & Matte Black Post PAMPEW Polished Aluminum Feet & Pewter Post

Description

Squircle Bar Height Table with X4 Base

Laminate Tables  
"NST" Models

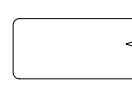
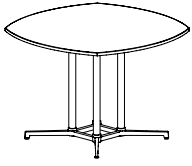

Eased Edge (R3)

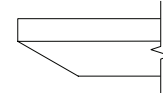

Reverse Bevel Edge (K9)

LAMINATE	D	W	H	CTN WT	CU FT	① Model	Eased Edge (R3)			Reverse Bevel Edge (K9)		
							Standard	Graded In		Standard	Graded In	
							Tier 1	Tier 2	Tier 3	Tier 1	Tier 2	Tier 3
	60	60	42	154	50	<b>NST60-42SCZ</b>	\$2,300	\$2,375	\$2,545	\$2,671	\$2,748	\$2,915
	54	54	42	106	28	<b>NST54-42SCZ</b>	\$2,154	\$2,214	\$2,272	\$2,525	\$2,584	\$2,642
	48	48	42	90	28	<b>NST48-42SCZ</b>	\$2,047	\$2,144	\$2,251	\$2,418	\$2,515	\$2,622

Features:

- price reflects complete table - top and base
- ships KD in multiple cartons
- top has option for cut out to receive electrical component, order separately
- optional vertical wire manager for base, order separately
- base has leveling glides
- width of base foot is 38"

HSON

To Order Specify

① Laminate Model #	② Edge Detail	③ Laminate Selection	③a PVC Edge Color	④ Electrical Cut Out	⑤ Metal Finish
Laminate (NST)	R3 Eased K9 Reverse Bevel	<b>Standard Laminates (T1)</b> Solid Patterns: ALB Alabaster      DWH Designer White BLK Black          SHD Shadow BBL Bridal Blanco    SLG Slate Grey  Wood Grain Patterns: AGA Aged Ash      GRH Graphite ALL Ale              HGL High Line BLO Blonde Echo    OAT Oatmeal Cookie BOL Bourbon Light    PIN Pinnacle Walnut BZW Brazilwood      STU Studio Teak BGL Brighton Light    VIN Vintage CLL Collectors        WLH Walnut Heights FLO Florence Walnut    WEA Weathered Ash	Color: <b>Standard (T1) laminates have a matching PVC.</b> AGA Aged Ash ALB Alabaster ALL Ale Light BLK Black BLO Blonde Echo BOL Bourbon Light BZW Brazilwood BBL Bridal Blanco BGL Brighton Light CLL Collectors DWH Designer White FLO Florence Walnut GRH Graphite HGL High Line OAT Oatmeal Cookie PIN Pinnacle Walnut SHD Shadow SLG Slate Grey STU Studio Teak VIN Vintage WLH Walnut Heights WEA Weathered Ash	N None CO_EC23 Cut out for EC23 CO_EC24 Cut out for EC24	BWH Bright White Feet & Post MBK Matte Black Feet & Post PEW Pewter Feet & Post ASLASL Arctic Silver Feet & Post ASLBWH Arctic Silver Feet & Bright White Post ASLMBK Arctic Silver Feet & Matte Black Post ASLPEW Arctic Silver Feet & Pewter Post PAMASL Polished Aluminum Feet & Arctic Silver Post PAMBWH Polished Aluminum Feet & Bright White Post PAMMBK Polished Aluminum Feet & Matte Black Post PAMPEW Polished Aluminum Feet & Pewter Post
		Graded-In Laminates (T2) & (T3) see pages 156-161	PVC color must be selected with Graded-In Laminates (T2) & (T3)		

Model Number Breakdown

NST54-42SCZ					
NS	T	54	42	SC	Z
Nosh	Laminate	54"	Height	Squircle Top Shape	X4 Base

Description

Squirrel Bar Height Table with X4 Base  
(continued)

		Veneer Tables "NSV" Models				Solid Surface Tables "NSS" Models					
		Eased Edge (R3)		Reverse Bevel Edge (K9)		Reverse Bevel Edge (S7)					
		Flat Cut	Double Cut	Flat Cut	Double Cut	Standard					
	D	W	H	CTN WT	CU FT	① Model	Flat Cut	Double Cut	Flat Cut	Double Cut	Standard
VENEER	60	60	42	154	50	NSV60-42SCZ	\$3,006	\$3,202	\$3,119	\$3,322	--
	54	54	42	106	28	NSV54-42SCZ	\$2,846	\$3,037	\$2,956	\$3,155	--
	48	48	42	90	28	NSV48-42SCZ	\$2,481	\$2,600	\$2,549	\$2,675	--
SOL SURF	60	60	42	208	50	NSS60-42SCZ	--	--	--	--	\$6,533
	54	54	42	145	28	NSS54-42SCZ	--	--	--	--	\$5,780
	48	48	42	120	28	NSS48-42SCZ	--	--	--	--	\$4,883

NOSH

To Order Specify

① Veneer Model #	② Edge Detail	③ Wood Species	④ Wood Finish	⑤ Electrical Cut Out	⑥ Metal Finish		
Veneer (NSV)	R3 Eased K9 Reverse Bevel	<b>Flat Cut</b> CH1 Cherry MA1 Maple WA1 Walnut	Cherry: BRL Barley BBM Bourbon Medium BRM Brighton Medium CLA Classic CLL Collectors* EAR Earthy HRV Harvest* LGC Legacy PRL Praline* SAF Saffron	Maple: ALM Ale Medium BUT Butterscotch CIN Cinnamon FLX Flax VEN Venetian	Walnut: AUB Auburn ESP Espresso MCH Mocha* NTO Night Owl* SIE Sienna* TOF Toffee* TRF Truffle*	N None CO_EC23 Cut out for EC23 CO_EC24 Cut out for EC24	BWH Bright White Feet & Post MBK Matte Black Feet & Post PEW Pewter Feet & Post ASLASL Arctic Silver Feet & Post ASLBWH Arctic Silver Feet & Bright White Post ASLMBK Arctic Silver Feet & Matte Black Post ASLPEW Arctic Silver Feet & Pewter Post PAMASL Polished Aluminum Feet & Arctic Silver Post PAMBWH Polished Aluminum Feet & Bright White Post PAMMBK Polished Aluminum Feet & Matte Black Post PAMPEW Polished Aluminum Feet & Pewter Post
			<b>Double Cut</b> DC2 Double Cut	<b>④ Wood Finish</b> Double Cut: COF Coffee FOS Fossil KHK Khaki CRM Cremello GRH Graphite STU Studio Teak			

① Solid Surface Model #	② Edge Detail	③ Solid Surface	④ Electrical Cut Out	⑤ Metal Finish
Solid Surface (NSS)	S7 Reverse Bevel	<b>Tier 1</b> ARM Armadillo BLP Black Pearl GRA Graphite Granite PEB Pebble Pearl PUR Pure White	N None CO_EC23 Cut out for EC23 CO_EC24 Cut out for EC24	BWH Bright White Feet & Post MBK Matte Black Feet & Post PEW Pewter Feet & Post ASLASL Arctic Silver Feet & Post ASLBWH Arctic Silver Feet & Bright White Post ASLMBK Arctic Silver Feet & Matte Black Post ASLPEW Arctic Silver Feet & Pewter Post PAMASL Polished Aluminum Feet & Arctic Silver Post PAMBWH Polished Aluminum Feet & Bright White Post PAMMBK Polished Aluminum Feet & Matte Black Post PAMPEW Polished Aluminum Feet & Pewter Post

Description

Squirle Bar Height Table with Round Disc Base



Laminate Tables  
"NST" Models

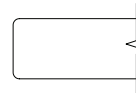

Eased Edge (R3)

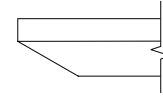

Reverse Bevel Edge (K9)

LAMINATE	D	W	H	CTN WT	CU FT	① Model	Eased Edge (R3)			Reverse Bevel Edge (K9)		
							Standard	Graded In		Standard	Graded In	
							Tier 1	Tier 2	Tier 3	Tier 1	Tier 2	Tier 3
	42	42	42	118	21	NST42-42SCR	\$1,467	\$1,511	\$1,589	\$1,837	\$1,883	\$1,960
	36	36	42	88	20	NST36-42SCR	\$1,260	\$1,296	\$1,350	\$1,630	\$1,667	\$1,720
	30	30	42	65	15	NST30-42SCR	\$1,088	\$1,118	\$1,150	\$1,459	\$1,489	\$1,521

Features:

- price reflects complete table - top and base
- ships KD in multiple cartons
- cut out for power is not available on these tables
- base has anti-rock glides
- width of base foot varies from 22" or 27"

HSON

To Order Specify

① Laminate Model #	② Edge Detail	③ Laminate Selection	③a PVC Edge Color	④ Metal Finish
Laminate (NST)	R3 Eased K9 Reverse Bevel	<b>Standard Laminates (T1)</b> Solid Patterns: ALB Alabaster      DWH Designer White BLK Black            SHD Shadow BBL Bridal Blanco    SLG Slate Grey  Wood Grain Patterns: AGA Aged Ash        GRH Graphite ALL Ale Light        HGL High Line BLO Blonde Echo     OAT Oatmeal Cookie BOL Bourbon Light    PIN Pinnacle Walnut BZW Brazilwood      STU Studio Teak BGL Brighton Light    VIN Vintage CLL Collectors        WLH Walnut Heights FLO Florence Walnut    WEA Weathered Ash	Color: Standard (T1) laminates have a matching PVC. AGA Aged Ash ALB Alabaster ALL Ale Light BLK Black BLO Blonde Echo BOL Bourbon Light BZW Brazilwood BBL Bridal Blanco BGL Brighton Light CLL Collectors DWH Designer White FLO Florence Walnut GRH Graphite HGL High Line OAT Oatmeal Cookie PIN Pinnacle Walnut SHD Shadow SLG Slate Grey STU Studio Teak VIN Vintage WLH Walnut Heights WEA Weathered Ash	BWH Bright White Feet & Post MBK Matte Black Feet & Post PEW Pewter Feet & Post ASLASL Arctic Silver Feet & Post ASLBWH Arctic Silver Feet & Bright White Post ASLMBK Arctic Silver Feet & Matte Black Post ASLPEW Arctic Silver Feet & Pewter Post
		Graded-In Laminates (T2) & (T3) see pages 156-161	PVC color must be selected with Graded-In Laminates (T2) & (T3)	

Model Number Breakdown

NST30-42SCR					
NS	T	30	42	SC	R
Nosh	Laminate	30"	Height	Squirle Top Shape	Round Disc Base

Description

Squirrel Bar Height Table with Round Disc Base (continued)

		Veneer Tables "NSV" Models				Solid Surface Tables "NSS" Models					
		Eased Edge (R3)		Reverse Bevel Edge (K9)		Reverse Bevel Edge (S7)					
		Flat Cut	Double Cut	Flat Cut	Double Cut	Standard					
	D	W	H	CTN WT	CU FT	1 Model	Flat Cut	Double Cut	Flat Cut	Double Cut	Standard
VENEER	42	42	42	118	21	NSV42-42SCR	\$1,814	\$1,941	\$1,888	\$2,020	--
	36	36	42	88	20	NSV36-42SCR	\$1,538	\$1,643	\$1,599	\$1,711	--
	30	30	42	65	15	NSV30-42SCR	\$1,306	\$1,397	\$1,359	\$1,454	--
SOL SURF	42	42	42	141	21	NSS42-42SCR	--	--	--	--	\$3,850
	36	36	42	104	20	NSS36-42SCR	--	--	--	--	\$3,168
	30	30	42	76	15	NSS30-42SCR	--	--	--	--	\$2,715

To Order Specify

1 Veneer Model #	2 Edge Detail	3 Wood Species	4 Wood Finish	5 Metal Finish		
Veneer (NSV)	R3 Eased K9 Reverse Bevel	<b>Flat Cut</b> CH1 Cherry MA1 Maple WA1 Walnut	Cherry: BRL Barley BBM Bourbon Medium BRM Brighton Medium CLA Classic CLL Collectors* EAR Earthy HRV Harvest* LGC Legacy PRL Praline* SAF Saffron	Maple: ALM Ale Medium BUT Butterscotch CIN Cinnamon FLX Flax VEN Venetian	Walnut: AUB Auburn ESP Espresso MCH Mocha* NTO Night Owl* SIE Sienna* TOF Toffee TRF Truffle*	BWH Bright White Feet & Post MBK Matte Black Feet & Post PEW Pewter Feet & Post ASLASL Arctic Silver Feet & Post ASLBWH Arctic Silver Feet & Bright White Post ASLMBK Arctic Silver Feet & Matte Black Post ASLPEW Arctic Silver Feet & Pewter Post
		<b>Double Cut</b> DC2 Double Cut	<b>4 Wood Finish</b> Double Cut: COF Coffee FOS Fossil KHK Khaki CRM Cremello GRH Graphite STU Studio Teak			

1 Solid Surface Model #	2 Edge Detail	3 Solid Surface	4 Metal Finish
Solid Surface (NSS)	S7 Reverse Bevel	<b>Tier 1</b> ARM Armadillo BLP Black Pearl GRA Graphite Granite PEB Pebble Pearl PUR Pure White	BWH Bright White Feet & Post MBK Matte Black Feet & Post PEW Pewter Feet & Post ASLASL Arctic Silver Feet & Post ASLBWH Arctic Silver Feet & Bright White Post ASLMBK Arctic Silver Feet & Matte Black Post ASLPEW Arctic Silver Feet & Pewter Post



Description

Squircle Bar Height Table with Square Disc Base

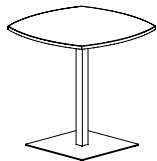

Laminate Tables  
"NST" Models

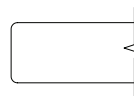

Eased Edge (R3)

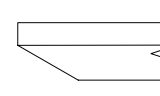

Reverse Bevel Edge (K9)

LAMINATE	D	W	H	CTN WT	CU FT	① Model	Eased Edge (R3)			Reverse Bevel Edge (K9)		
							Standard	Graded In		Standard	Graded In	
							Tier 1	Tier 2	Tier 3	Tier 1	Tier 2	Tier 3
	42	42	42	134	21	NST42-42SCS	\$1,648	\$1,693	\$1,770	\$2,019	\$2,063	\$2,140
	36	36	42	99	20	NST36-42SCS	\$1,386	\$1,422	\$1,475	\$1,755	\$1,791	\$1,845
	30	30	42	71	15	NST30-42SCS	\$1,213	\$1,243	\$1,275	\$1,584	\$1,614	\$1,646

Features:

- price reflects complete table - top and base
- ships KD in multiple cartons
- cut out for power is not available on these tables
- base has anti-rock glides
- width of base foot varies from 22" or 27"

HSON

To Order Specify

① Laminate Model #	② Edge Detail	③ Laminate Selection	③a PVC Edge Color	④ Metal Finish
Laminate (NST)	R3 Eased	<b>Standard Laminates (T1)</b> Solid Patterns: ALB Alabaster      DWH Designer White BLK Black          SHD Shadow BBL Bridal Blanco    SLG Slate Grey  Wood Grain Patterns: AGA Aged Ash      GRH Graphite ALL Ale Light      HGL High Line BLO Blonde Echo    OAT Oatmeal Cookie BOL Bourbon Light    PIN Pinnacle Walnut BZW Brazilwood      STU Studio Teak BGL Brighton Light    VIN Vintage CLL Collectors        WLH Walnut Heights FLO Florence Walnut    WEA Weathered Ash	Color: Standard (T1) laminates have a matching PVC. AGA Aged Ash ALB Alabaster ALL Ale Light BLK Black BLO Blonde Echo BOL Bourbon Light BZW Brazilwood BBL Bridal Blanco BGL Brighton Light CLL Collectors DWH Designer White FLO Florence Walnut GRH Graphite HGL High Line OAT Oatmeal Cookie PIN Pinnacle Walnut SHD Shadow SLG Slate Grey STU Studio Teak VIN Vintage WLH Walnut Heights WEA Weathered Ash	BWH Bright White Feet & Post MBK Matte Black Feet & Post PEW Pewter Feet & Post ASLASL Arctic Silver Feet & Post ASLBWH Arctic Silver Feet & Bright White Post ASLMBK Arctic Silver Feet & Matte Black Post ASLPEW Arctic Silver Feet & Pewter Post
	K9 Reverse Bevel			

Model Number Breakdown

NST30-42SCS				
NS	T	30	42	SC
Nosh	Laminate	30"	Height	Squircle Top Shape
				Square Disc Base

Description

Squirrel Bar Height Table with Square Disc Base (continued)

Veneer Tables "NSV" Models      Solid Surface Tables "NSS" Models

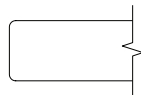

Eased Edge (R3)

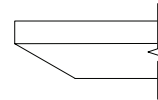

Reverse Bevel Edge (K9)

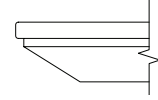

Reverse Bevel Edge (S7)

	D	W	H	CTN WT	CU FT	① Model	Eased Edge (R3)		Reverse Bevel Edge (K9)		Standard
							Flat Cut	Double Cut	Flat Cut	Double Cut	
VENEER	42	42	42	134	21	NSV42-42SCS	\$2,158	\$2,303	\$2,241	\$2,391	--
	36	36	42	99	20	NSV36-42SCS	\$1,808	\$1,926	\$1,876	\$2,001	--
	30	30	42	71	15	NSV30-42SCS	\$1,575	\$1,678	\$1,636	\$1,742	--
SOL SURF	42	42	29	156	21	NSS42-42SCS	--	--	--	--	\$4,092
	36	36	29	115	20	NSS36-42SCS	--	--	--	--	\$3,336
	30	30	29	82	15	NSS30-42SCS	--	--	--	--	\$3,053

NOSH

To Order Specify

Veneer Model #	② Edge Detail	③ Wood Species	④ Wood Finish	⑤ Metal Finish		
Veneer (NSV)	R3 Eased K9 Reverse Bevel	<b>Flat Cut</b> CH1 Cherry MA1 Maple WA1 Walnut	Cherry: BRL Barley BBM Bourbon Medium BRM Brighton Medium CLA Classic CLL Collectors* EAR Earthy HRV Harvest* LGC Legacy PRL Praline* SAF Saffron	Maple: ALM Ale Medium BUT Butterscotch CIN Cinnamon FLX Flax VEN Venetian	Walnut: AUB Auburn ESP Espresso MCH Mocha* NTO Night Owl* SIE Sienna* TOF Toffee TRF Truffle*	BWH Bright White Feet & Post MBK Matte Black Feet & Post PEW Pewter Feet & Post ASLASL Arctic Silver Feet & Post ASLBWH Arctic Silver Feet & Bright White Post ASLMBK Arctic Silver Feet & Matte Black Post ASLPEW Arctic Silver Feet & Pewter Post
		<b>Double Cut</b> DC2 Double Cut	④ Wood Finish Double Cut: COF Coffee    FOS Fossil    KHK Khaki CRM Cremello    GRH Graphite    STU Studio Teak			

① Solid Surface Model #	② Edge Detail	③ Solid Surface	④ Metal Finish
Solid Surface (NSS)	S7 Reverse Bevel	<b>Tier 1</b> ARM Armadillo BLP Black Pearl GRA Graphite Granite PEB Pebble Pearl PUR Pure White	BWH Bright White Feet & Post MBK Matte Black Feet & Post PEW Pewter Feet & Post ASLASL Arctic Silver Feet & Post ASLBWH Arctic Silver Feet & Bright White Post ASLMBK Arctic Silver Feet & Matte Black Post ASLPEW Arctic Silver Feet & Pewter Post

Description	D	W	H	CTN WT	CU FT	① Model	List Price
Corner Electrical Jumper Cable	3 3/8	3 3/8	2	5	1	EC23	\$559

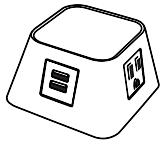

- 3 power & 1 Dual USB, 72" cord
- color: black or white

Node Power Unit	3 3/8	3 3/8	3/8	5	1	EC24	\$464
-----------------	-------	-------	-----	---	---	------	-------

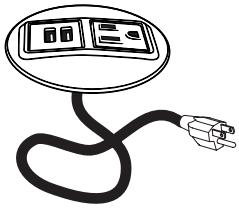

- 1 power & 1 Dual USB, 72" cord
- color: black or white

Vertical Wire Management	1/2	1/2	0	1	1	AVL20	\$73
--------------------------	-----	-----	---	---	---	-------	------

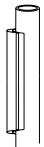

- field installed
- color: black or silver

**To Order Specify**

① Model #	
-----------	--



Top Sizes and Shapes . . . . .	154	Tables - 29"h . . . . .	166
Laminate Tops . . . . .	155	Tables - 36"h . . . . .	218
Veneer Tops . . . . .	162	Tables - 42"h . . . . .	266
Solid Surface Tops . . . . .	163	Power & Wire Management. . . . .	314
Base Styles . . . . .	164		
Power Options . . . . .	165		

## Prep Multi-Purpose Tables - Overview



### Rectangular Top

24 x 42  
24 x 48  
24 x 60  
24 x 72  
  
30 x 42  
30 x 48  
30 x 60  
30 x 72

Page 320



### Square Top

30 x 30  
36 x 36  
42 x 42  
48 x 48

Page 320

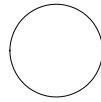

### Round Top

30 dia.  
36 dia.  
42 dia.  
48 dia.  
60 dia.

Page 320

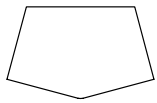

### AV Top

24 x 48  
30 x 60

Page 321



### Trapezoid Top

24 x 48  
24 x 72  
30 x 60

Page 321

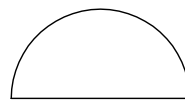

### Half Round Top

24 x 48  
30 x 60

Page 321



### T Base

2 1/2 x 27 3/4 (20 base spread)  
2 1/2 x 27 3/4 (26 base spread)

Page 322, 326-329

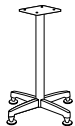

### X Base

20 x 27 3/4 (20 base spread)  
26 x 27 3/4 (26 base spread)  
34 x 27 3/4 (34 base spread)  
38 x 27 3/4 (38 base spread)

Page 322-323, 330



### X4 Base

38 x 27 3/4 (38 base spread)

Page 323



### Counter Height X Base

26 x 34 3/4 (26 base spread)  
34 x 34 3/4 (34 base spread)

Page 324



### Bar Height X Base

26 x 40 3/4 (26 base spread)  
34 x 40 3/4 (34 base spread)

Page 325



### Fabric Modesty Panel

48 x 10 1/4  
60 x 10 1/4  
72 x 10 1/4

Page 331

## Prep Multi-Purpose Tables Product Information

Prep Multi-Purpose Collection has a flexible offering of shapes and sizes. The tops and bases are specified separately.

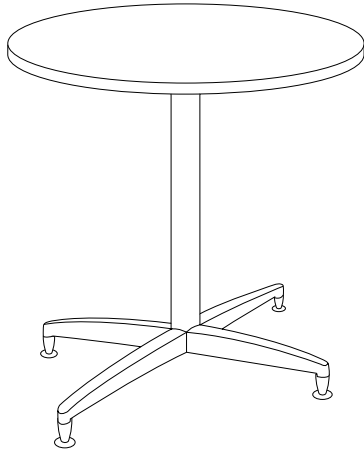

### Tops

- 6 top shapes: Rectangular, Square, Round, Half Round, Trapezoid and AV
- Single user paddle release for tilting models
- Power kits available

### Base

- Available in T or X styles in standard, counter and bar heights with base rail lengths matched to top size
- Two color options - Black Sandtex (BSX) or Stardust Silver (STS)

### Glides or Casters

- Interchangeable in the field
- Casters or glides offer same table heights
- Dual-wheel locking casters
- Color: Black

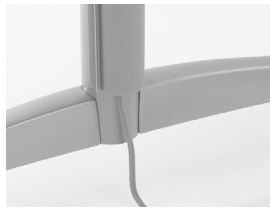

### Vertical Wire Management (AVL20)

Optional vertical wire management helps control and guide cords from the floor to the table top. Available in black or silver and field installed. Sold separately on page 351

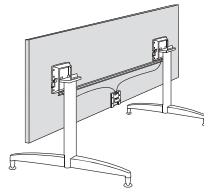

### Tilting Mechanism

Tables are tilted with a release handle centrally located under the table top. Pull the handle to activate the cable release mechanism and easily raise the top into the tilted position for storage or transport. To return, just tilt the top back to the work position until the mechanism locks.

## Standard Laminates

JSI Standard Laminate program consists of 24 solid and wood grain patterns, and establish our Tier 1 laminate pricing. Each has a coordinating PVC edge color that is automatically used with the Standard Laminates.

### Wood Grain Laminate

<b>AGA</b>	Aged Ash	<b>GRH</b>	Graphite
<b>ALL</b>	Ale Light	<b>HGL</b>	High Line
<b>BLO</b>	Blonde Echo	<b>OAT</b>	Oatmeal Cookie
<b>BOL</b>	Bourbon Light	<b>PIN</b>	Pinnacle Walnut
<b>BZW</b>	Brazilwood	<b>STU</b>	Studio Teak
<b>BGL</b>	Brighton Light	<b>VIN</b>	Vintage
<b>CLL</b>	Collectors	<b>WLH</b>	Walnut Heights
<b>FLO</b>	Florence Walnut	<b>WEA</b>	Weathered Ash

### Solid Laminate

<b>ALB</b>	Alabaster
<b>BLK</b>	Black
<b>BBL</b>	Bridal Blanco
<b>DWH</b>	Designer White
<b>DOV</b>	Dove Grey
<b>FWH</b>	Frosty White
<b>PLT</b>	Platinum
<b>SHD</b>	Shadow
<b>SLG</b>	Slate Grey

## Wilsonart Laminate Tier 2

JSI offers an extensive program for laminates beyond our Standard Program. Always reference our website for the most current listing when using a [Graded-In Laminate](#), on page 319 select the color of the PVC edge color.

Laminate	Pattern #	Tier	Laminate	Pattern #	Tier	Laminate	Pattern #	Tier
Almond Leather	2932-60	2	Kingswood Walnut	8218-38	2	Silicon EV	4811-60	2
Antique White	1572-60	2	Lapis Blue	D417-60	2	Soft Gold Mesh	4911-38	2
Atlantis	D25-60	2	Light Beige	1531-60	2	Solar Oak	7816-60	2
Bannister Oak	7806-60	2	Limber Maple	10734-60	2	Sprout	4918-60	2
Beige	1530-60	2	Linen	D427-60	2	Steel Mesh	4879-38	2
Beige Pampus	4170-60	2	Loden Zephyr	4844-60	2	Sterling Ash	7995-38	2
Beigewood	7850-60	2	Lowell Ash	7994-38	2	Tailored Linen	4992-38	2
Black	1595-60	2	Mangalore Mango	7984-38	2	Tan Soapstone	4887-38	2
Blue Agave	4919-60	2	Manitoba Maple	7911-60	2	Tangerine	4915-60	2
Boardwalk Oak	7983-38	2	Maroochy Brush	4745-60	2	Tawny Legacy	4663-60	2
Brittany Blue	D321-60	2	Midnight	D505-60	2	Titanium EV	4810-60	2
Bronze Legacy	4656-60	2	Mission Maple	7990-38	2	Tungsten EV	4814-60	2
Buka Bark	7982-38	2	Misted Zephyr	4843-60	2	Tuscan Walnut	7921-38	2
Burnished Chestnut	4796-60	2	Monticello Maple	7925-38	2	Twilight Zephyr	4845-60	2
Canyon Zephyr	4842-60	2	Morelia Mango	7985-38	2	Wallaby	D439-60	2
Carbon EV	4820-60	2	Morro Zephyr	4846-60	2	Washi Crystal	5017-38	2
Carbon Mesh	4880-38	2	Natural Almond	D30-60	2	Washi Gold	5019-38	2
Castle Oak	7928-38	2	Natural Cotton	4946-38	2	Washi Pewter	5018-38	2
Casual Linen	4944-38	2	Natural Nebula	4633-60	2	White Carrara	4924-38	2
Cement	D503-60	2	Natural Pear	7061-60	2	White Cascade	5003-38	2
Classic Linen	4943-38	2	Natural Recon	7996-38	2	White Nebula	4621-60	2
Cloud Nebula	4630-60	2	Natural Rift	7954-38	2	White Sand	D403-60	2
Cloud Zephyr	4856-60	2	Natural Tigris	4669-60	2	White Tigris	4783-60	2
Coffee Bean	D495-60	2	Navy Legacy	4651-60	2	White-Matte	1570-60	2
Crisp Linen	4942-38	2	NeoWalnut	7991-38	2	Wild Cherry	7054-60	2
Crystal	D388-60	2	Neutral Glace	4143-60	2	Windswept Bronze	4794-38	2
Desert Zephyr	4841-60	2	New Age Oak	7938-38	2	Windswept Pewter	4795-60	2
Dove Grey	D92-60	2	Nickel EV	4813-60	2	Woolamai Brush	4746-60	2
Ebony Recon	7997-38	2	Nordic Linen	5015-38	2			
Eggplant	4913-60	2	North Sea	D90-60	2			
Evening Tigris	4674-60	2	Oiled Soapstone	4882-38	2			
Fashion Grey	D381-60	2	Orange Grove	D501-60	2			
Fired Steel	4994-60	2	Organic Cotton	4945-38	2			
Flax Linen	4990-38	2	Oxide	1787-60	2			
Fonthill Pear	10745-60	2	Palisades Oak	7987-38	2			
Forged Steel	4995-60	2	Pampus	4166-60	2			
Fossil Shale	D504-60	2	Pasadena Oak	7986-38	2			
French Linen	5016-38	2	Pearl Soapstone	4886-38	2			
French Pear	8220-38	2	Pepperdust	D327-60	2			
Frosty White	1573-60	2	Pewter	D73-60	2			
Fusion Maple	7909-60	2	Pewter Brush	4779-60	2			
Gesso Tracery	4962-38	2	Pewter Mesh	4878-38	2			
Glided Mesh	4912-38	2	Pinball	4937-38	2			
Graphite Nebula	4623-60	2	Platinum	D315-60	2			
Green Soapstone	4885-38	2	Port	D14-60	2			
Green Tigris	4667-60	2	Pressed Linen	4991-38	2			
Grey	1500-60	2	Putty	1503-60	2			
Grey Glace	4142-60	2	Raw Cotton	4947-38	2			
Grey Mesh	4877-38	2	River Cherry	7937-38	2			
Grey Nebula	4622-60	2	Rugged Linen	4989-38	2			
Grey Pampas	4168-60	2	Rustic Slate	4888-38	2			
Harvest Maple	7953-38	2	Sable Soapstone	4883-38	2			
High Rise	4996-38	2	Sap Walnut	8221-38	2			
Hollyberry	D307-60	2	Shadow Zephyr	4857-60	2			
Huntington Maple	7929-38	2	Sap Walnut	8221-38	2			
Indigo	D379-60	2	Shadow Zephyr	4857-60	2			
Irish Linen	4993-38	2	Sheer Mesh	4876-38	2			
Khaki Brown	D50-60	2	Sierra Cascade	5005-38	2			

PREP

## Prep Multi-Purpose Order Check List:

**Specify:**

- 1. Model Number
- 2. Base Color - Black Sandtex (BSX) or Stardust Silver (STS)
- 3. Top Laminate Color
- 4. Edge Color

**Example:**

<b>PR2472CTT</b> (model #)	<b>STS</b> (base/modesty)	<b>4622-60</b> (top laminate color)	<b>BLK</b> (edge color)
-------------------------------	------------------------------	----------------------------------------	----------------------------

**1. Model Number**
**2. Base Color - Black Sandtex (BSX) or Stardust Silver (STS)**
**3. Top Laminate Color**
**JSI Standard Laminates - Tier 1**
**Wood Grain Laminate**

<b>AGA</b> Aged Ash	<b>GRH</b> Graphite
<b>ALL</b> Ale Light	<b>HGL</b> High Line
<b>BLO</b> Blonde Echo	<b>OAT</b> Oatmeal Cookie
<b>BOL</b> Bourbon Light	<b>PIN</b> Pinnacle Walnut
<b>BZW</b> Brazilwood	<b>STU</b> Studio Teak
<b>BGL</b> Brighton Light	<b>VIN</b> Vintage
<b>CLL</b> Collectors	<b>WLH</b> Walnut Heights
<b>FLO</b> Florence Walnut	<b>WEA</b> Weathered Ash

**Solid Laminate**

<b>ALB</b> Alabaster
<b>BLK</b> Black
<b>BBL</b> Bridal Blanco
<b>DWH</b> Designer White
<b>DOV</b> Dove Grey
<b>FWH</b> Frosty White
<b>PLT</b> Platinum
<b>SHD</b> Shadow
<b>SLG</b> Slate Grey

**4. Edge Color:**

<b>AGA</b> Aged Ash	<b>FWH</b> Frosty White
<b>ALB</b> Alabaster	<b>GRH</b> Graphite
<b>ALL</b> Ale Light	<b>HGL</b> High Line
<b>BLK</b> Black	<b>OAT</b> Oatmeal Cookie
<b>BLO</b> Blonde Echo	<b>PIN</b> Pinnacle Walnut
<b>BOL</b> Bourbon Light	<b>PLT</b> Platinum
<b>BZW</b> Brazilwood	<b>SHD</b> Shadow
<b>BBL</b> Bridal Blanco	<b>SLG</b> Slate Grey
<b>BGL</b> Brighton Light	<b>STU</b> Studio Teak
<b>CLL</b> Collectors	<b>VIN</b> Vintage
<b>DWH</b> Designer White	<b>WLH</b> Walnut Heights
<b>DOV</b> Dove Grey	<b>WEA</b> Weathered Ash
<b>FLO</b> Florence Walnut	

see page 318 for Tier 2, Graded-In Laminate



Description	D	W	H	CTN WT	CU FT	① Model	Standard Tier 1	Graded In Tier 2
			(LS/LP)					
Rectangular Top 	24	42	1 3/16	38	3	PR2442TT	\$400	\$428
	24	48	1 3/16	43	4	PR2448TT	\$463	\$497
	24	60	1 3/16	52	5	PR2460TT	\$529	\$564
	24	72	1 3/16	62	5	PR2472TT	\$590	\$632
	30	42	1 3/16	44	4	PR3042TT	\$456	\$489
	30	48	1 3/16	49	5	PR3048TT	\$520	\$558
	30	60	1 3/16	59	6	PR3060TT	\$631	\$676
	30	72	1 3/16	71	7	PR3072TT	\$702	\$752

Rectangular Conference Top 	36	60	1 3/16	71	6	PR3660TT	\$763	\$817
	36	72	1 3/16	85	7	PR3672TT	\$843	\$906

Square Top 	30	30	1 3/16	32	3	PR3030ST	\$362	\$388
	36	36	1 3/16	52	4	PR3636ST	\$431	\$460
	42	42	1 3/16	59	5	PR4242ST	\$624	\$667
	48	48	1 3/16	76	7	PR4848ST	\$656	\$702

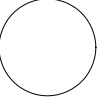
Round Top 	30	N/A	1 3/16	32	3	PR30RT	\$410	\$443
	36	N/A	1 3/16	52	4	PR36RT	\$511	\$546
	42	N/A	1 3/16	67	5	PR42RT	\$770	\$804
	48	N/A	1 3/16	76	7	PR48RT	\$785	\$841
	60	N/A	1 3/16	115	10	PR60RT	\$1,004	\$1,074

PREP

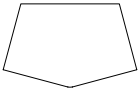
Description	D	W	H	CTN WT	CU FT	① Model	Standard Tier 1	Graded In Tier 2
			(LS/LP)					
AV Top 	24	48	1 3/16	43	4	PR2448AT	\$798	\$854
	30	60	1 3/16	58	6	PR3060AT	\$1,029	\$1,103

Trapezoid Top 	24	48	1 3/16	43	4	PR2448ZT	\$601	\$642
	24	72	1 3/16	62	5	PR2472ZT	\$748	\$800
	30	60	1 3/16	58	6	PR3060ZT	\$679	\$728

Half Round Top 	24	48	1 3/16	43	4	PR2448HT	\$491	\$527
	30	60	1 3/16	58	6	PR3060HT	\$678	\$727

**To Order, Specify:**

- ① Model Number
- ② Top Laminate Color
- ③ Edge Color
- ④ Other Product Modifications

**Specifications**

- Top construction is 1 1/8" thick particle board. The laminate face is horizontal grade high pressure laminate (HPL). A backer is bonded to the bottom side to ensure balanced construction.
- Welded powder coated bases are produced in a cantilever configuration to standard height with base rail lengths matched with top sizes.

Description	D	H	Base Spread	CTN WT	CU FT	① Model	List Price
T Base	2½	27¾	20	12	3	PR20TF	\$371
	2½	27¾	20	12	3	PR20TC	\$343



- sold as single unit
- fixed base with glides
- PR20TF and PR20TC for 24" depth top
- specify Black Sandtex (BSX) or Stardust Silver (STS)

**T base with casters**  
 · bases sold as single units

T Base	2½	27¾	26	12	3	PR26TF	\$387
	2½	27¾	26	12	3	PR26TC	\$359

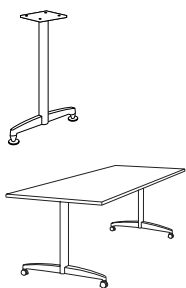

- sold as single unit
- fixed base with glides
- PR26TF and PR26TC for 30" or 36" depth top
- specify Black Sandtex (BSX) or Stardust Silver (STS)

**T base with casters**  
 · bases sold as single units

X Base	20	27¾	20	19	4	PR20XF	\$564
--------	----	-----	----	----	---	--------	-------

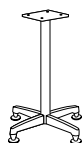

- sold as single unit
- glides
- for 24" round or square
- specify Black Sandtex (BSX) or Stardust Silver (STS)

X Base	26	27¾	26	21	4	PR26XF	\$592
--------	----	-----	----	----	---	--------	-------

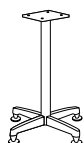

- sold as single unit
- glides
- for 30" square
- for 30" or 36" round
- specify Black Sandtex (BSX) or Stardust Silver (STS)

PREP

Description	D	H	Base Spread	CTN WT	CU FT	① Model	List Price
X Base	34	27 ¾	34	24	4	PR34XF	\$623

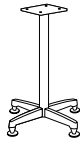

- sold as single unit
- glides
- for 36" square
- for 42" round
- specify Black Sandtex (BSX) or Stardust Silver (STS)

X Base	38	27 ¾	38	29	4	PR38XF	\$655
--------	----	------	----	----	---	--------	-------

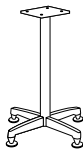

- sold as single unit
- glides
- for 42" square
- for 48" round or square
- specify Black Sandtex (BSX) or Stardust Silver (STS)

X4 Base	38	27 ¾	38	32	3	PR38X4F	\$1,133
---------	----	------	----	----	---	---------	---------

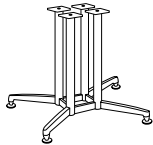

- sold as single unit
- glides
- for 60" round
- specify Black Sandtex (BSX) or Stardust Silver (STS)

**To Order, Specify:**

- ① Model Number
- ② Base Color
- ③ Other Product Modifications

PREP

Description	D	H	Base Spread	CTN WT	CU FT	① Model	List Price
Counter Height X Base	26	34 ¾	26	24	5	PR26-CHXF	\$662

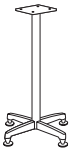

- sold as single unit
- fixed base with glides
- for 30" square
- for 30" or 36" round
- specify Black Sandtex (BSX) or Stardust Silver (STS)

Counter Height X Base	34	34 ¾	34	28	5	PR34-CHXF	\$692
-----------------------	----	------	----	----	---	-----------	-------

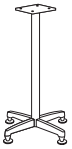

- sold as single unit
- fixed base with glides
- for 36" square
- for 42" round
- specify Black Sandtex (BSX) or Stardust Silver (STS)

PREP

Description	D	H	Base Spread	CTN WT	CU FT	① Model	List Price
Bar Height X Base	26	40 ¾	26	25	5	PR26-BHXF	\$662

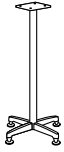

- sold as single unit
- fixed base with glides
- for 30" square
- for 30" or 36" round
- specify Black Sandtex (BSX) or Stardust Silver (STS)

Bar Height X Base	34	40 ¾	34	29	5	PR34-BHXF	\$692
-------------------	----	------	----	----	---	-----------	-------

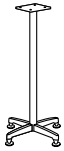

- sold as single unit
- fixed base with glides
- for 36" square
- for 42" round
- specify Black Sandtex (BSX) or Stardust Silver (STS)

PREP

**To Order, Specify:**

- ① Model Number
- ② Base Color
- ③ Other Product Modifications

Description	D	H	Base Spread	CTN WT	CU FT	① Model	List Price
T Base	2½	27¾	20	15	3	PR20TCT-42	\$1,138

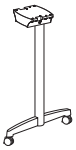

- sold as set of 2
- tilt base with casters
- for 24" x 42" top
- specify Black Sandtex (BSX) or Stardust Silver (STS)

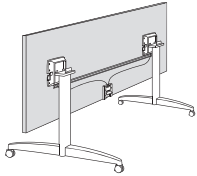

\* Due to tilt mechanism these bases are sold as sets.

T Base	2½	27¾	20	15	3	PR20TCT-48	\$1,138
--------	----	-----	----	----	---	------------	---------



- sold as set of 2
- tilt base with casters
- for 24" x 48" top
- specify Black Sandtex (BSX) or Stardust Silver (STS)

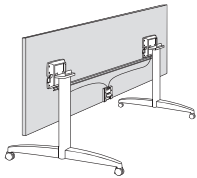

\* Due to tilt mechanism these bases are sold as sets.

PREP

Description	D	H	Base Spread	CTN WT	CU FT	1 Model	List Price
T Base	2 1/2	27 3/4	20	15	3	PR20TCT-60	\$1,138

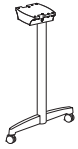

- sold as set of 2
- tilt base with casters
- for 24" x 60" top
- specify Black Sandtex (BSX) or Stardust Silver (STS)

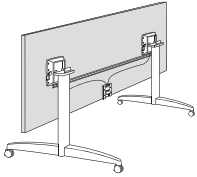

\* Due to tilt mechanism these bases are sold as sets.

T Base	2 1/2	27 3/4	20	15	3	PR20TCT-72	\$1,138
--------	-------	--------	----	----	---	------------	---------

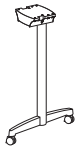

- sold as set of 2
- tilt base with casters
- for 24" x 72" top
- specify Black Sandtex (BSX) or Stardust Silver (STS)

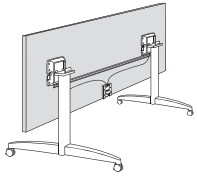

\* Due to tilt mechanism these bases are sold as sets.

**To Order, Specify:**

- 1 Model Number
- 2 Base Color
- 3 Other Product Modifications

**Specifications**

- Assembled powder coated bases are produced in a cantilever configuration to standard height with base rail lengths matched with top sizes.



Description	D	H	Base Spread	CTN WT	CU FT	① Model	List Price
T Base	2½	27¾	26	15	3	PR26TCT-42	\$1,161

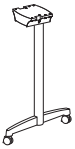

- sold as set of 2
- tilt base with casters
- for 30" x 42" top
- specify Black Sandtex (BSX) or Stardust Silver (STS)

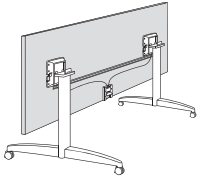

\* Due to tilt mechanism these bases are sold as sets.

T Base	2½	27¾	26	15	3	PR26TCT-48	\$1,161
--------	----	-----	----	----	---	------------	---------

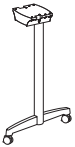

- sold as set of 2
- tilt base with casters
- for 30" x 48" top
- specify Black Sandtex (BSX) or Stardust Silver (STS)

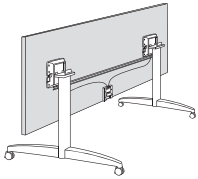

\* Due to tilt mechanism these bases are sold as sets.

T Base	2½	27¾	26	15	3	PR26TCT-60	\$1,161
--------	----	-----	----	----	---	------------	---------



- sold as set of 2
- tilt base with casters
- for 30" x 60" top
- specify Black Sandtex (BSX) or Stardust Silver (STS)

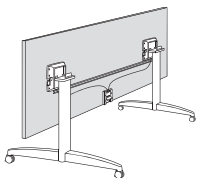

\* Due to tilt mechanism these bases are sold as sets.

PREP

Description	D	H	Base Spread	CTN WT	CU FT	1 Model	List Price
T Base	2 1/2	27 3/4	26	15	3	PR26TCT-72	\$1,161

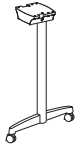

- sold as set of 2
- tilt base with casters
- for 30" x 72" top
- specify Black Sandtex (BSX) or Stardust Silver (STS)

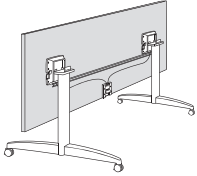

\* Due to tilt mechanism these bases are sold as sets.

**To Order, Specify:**

- 1 Model Number
- 2 Base Color
- 3 Other Product Modifications

**Specifications**

- Assembled powder coated bases are produced in a cantilever configuration to standard height with base rail lengths matched with top sizes.

Description	D	H	Base Spread	CTN WT	CU FT	① Model	List Price
X Base	2½	27¾	20	26	5	PR20XCT	\$668

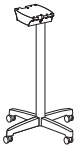

- sold as single unit
- tilt base with casters
- for 24" round or square
- specify Black Sandtex (BSX) or Stardust Silver (STS)

X Base	2½	27¾	26	26	5	PR26XCT	\$698
--------	----	-----	----	----	---	---------	-------

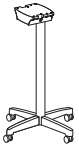

- sold as single unit
- tilt base with casters
- for 30" round or square
- for 36" round
- specify Black Sandtex (BSX) or Stardust Silver (STS)

X Base	2½	27¾	34	28	4	PR34XCT	\$726
--------	----	-----	----	----	---	---------	-------

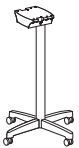

- sold as single unit
- tilt base with casters
- for 36" square
- for 42" round or square
- specify Black Sandtex (BSX) or Stardust Silver (STS)

X Base	2½	27¾	38	28	5	PR38XCT	\$807
--------	----	-----	----	----	---	---------	-------



- sold as single unit
- tilt base with casters
- for 48" round or square
- specify Black Sandtex (BSX) or Stardust Silver (STS)

PREP

Description	W	H	CTN WT	CU FT	① Model	List Price
Fabric Modesty Panel	48	10 ¼	8	2	PR48MP	\$322



- for 48" width top
- for 24" and 30" depth rectangle tops
- black mesh fabric with liner and wire management pockets

Fabric Modesty Panel	60	10 ¼	9	2	PR60MP	\$375
----------------------	----	------	---	---	--------	-------



- for 60" width top
- for 24" and 30" depth rectangle tops
- black mesh fabric with liner and wire management pockets

Fabric Modesty Panel	72	10 ¼	12	2	PR72MP	\$391
----------------------	----	------	----	---	--------	-------



- for 72" width top
- for 24" and 30" depth rectangle tops
- black mesh fabric with liner and wire management pockets

**To Order, Specify:**

- ① Model Number
- ② Base Color
- ③ Other Product Modifications

**Specifications**

- Assembled powder coated bases are produced in a cantilever configuration to standard height with base rail lengths matched with top sizes.

## Prep Conference Tables - Overview

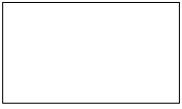

**Rectangular Conference Top**

36 x 60

36 x 72

Page 333

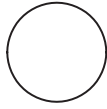

**Round Top**

60 dia.

Page 333

Description	D	W	CTN WT	CU FT	① Model	Standard Tier 1	Graded In Tier 2	
Rectangular Conference Top	36	60	71	6	PR3660TT	\$763	\$817	
	36	72	85	7	PR3672TT	\$843	\$906	
	<b>Coordinating T Bases (must be ordered separately):</b>							
	<b>Fixed Base with glides</b>							<b>List Price</b>
	26 single unit			12	3	PR26TF		\$387
	26 single unit			12	3	PR26TC		\$359
26 set of 2			15	3	PR26TCT-60		\$1,161	
26 set of 2			15	3	PR26TCT-72		\$1,161	

- fixed base with glides
- for 30" or 36" depth top
- specify Black Sandtex (BSX) or Stardust Silver (STS)

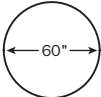
Round Top	60		115	10	PR60RT	\$1,004	\$1,074	
	<b>Coordinating X Base (must be ordered separately):</b>							
	<b>X4 Base</b>							<b>List Price</b>
	38			32	3	PR38X4F		\$1,133



- sold as single unit
- glides
- for 60" round
- specify Black Sandtex (BSX) or Stardust Silver (STS)

**To Order, Specify:**

- ① Model Number
- ② Top Laminate Color
- ③ Base Color
- ④ Edge Color
- ⑤ Other Product Modifications

**Specifications**

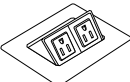
- Top construction is 1 1/8" thick particle board. The laminate face is horizontal grade high pressure laminate (HPL). A backer is bonded to the bottom side to ensure balanced construction.
- Assembled powder coated bases are produced in a cantilever configuration to standard height with base rail lengths matched with top sizes.

Description	D	W	CTN WT	CU FT	① Model	List Price
<b>Mini Grommet Power and Data Tilt Up</b>  <ul style="list-style-type: none"> <li>· fluid one touch tilt up access</li> <li>· one power receptacle - 120 volt; 15 amp with one voice/data port adapter to accept most jack manufacturers</li> <li>· 72" power cord with molded plug</li> <li>· drop in field installation required</li> <li>· UL listed component</li> <li>· specify Black (B) or Silver (S)</li> <li>· location cannot be over base mounting plate</li> </ul>	4 ¼	5 ½	6		<b>EC10</b>	<b>\$428</b>
<b>Mini Power Tilt Up</b>  <ul style="list-style-type: none"> <li>· fluid one touch tilt up access</li> <li>· two power receptacles - 120 volt; 15 amp</li> <li>· 72" power cord with molded plug</li> <li>· drop in field installation required</li> <li>· UL listed component</li> <li>· specify Black (B) or Silver (S)</li> <li>· location cannot be over base mounting plate</li> </ul>	4 ¼	5 ½	6		<b>EC11</b>	<b>\$446</b>
<b>Mini Power and USB Tilt Up</b>  <ul style="list-style-type: none"> <li>· fluid one touch tilt up access</li> <li>· one power receptacle - 120 volt; 15 amp dual powered USB</li> <li>· 72" power cord with molded plug</li> <li>· drop in field installation required</li> <li>· UL listed component</li> <li>· Black or Silver finish</li> <li>· location cannot be over base mounting plate</li> </ul>	4 ¼	5 ½	6	1	<b>EC12</b>	<b>\$555</b>
<b>Dual Power and Data Tilt Up</b>  <ul style="list-style-type: none"> <li>· for use with PR3660TT and PR3672TT only</li> <li>· fluid one touch tilt up access</li> <li>· back to back tilt sections</li> <li>· four power receptacles (2 per side) - 120 volt; 15 amp with four openings for voice/data jacks (2 per side)</li> <li>· adapter kit provided to accept jacks from most port manufacturers</li> <li>· accepts up to four type 3 telecom jacks</li> <li>· two 72" power cord with molded plug</li> <li>· drop in field installation required</li> <li>· UL listed component</li> <li>· Silver finish</li> <li>· location cannot be over base mounting plate</li> </ul>	8	8 ¾	16		<b>EC13</b>	<b>\$1,130</b>

PREP

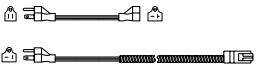
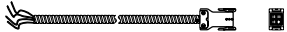
Description	CTN WT	CU FT	1 Model	List Price
<b>Corner Electrical Jumper Cable</b>  <ul style="list-style-type: none"> <li>• 12" corner jumper cable</li> <li>• use for wedges, 90 degree corners and half round tables</li> </ul>			<b>EJK-12</b>	<b>\$143</b>
<b>3 Prong Power Infeed</b>  <ul style="list-style-type: none"> <li>• 72" plug power infeed</li> <li>• 20 amps/110 volts max</li> <li>• 3 prong plug - 15 amp adapter plug</li> <li>• single circuit use only</li> </ul>			<b>AP72</b>	<b>\$280</b>
<b>Hardwire Power Infeed</b>  <ul style="list-style-type: none"> <li>• 72" hardwire power infeed</li> <li>• 20 amps/120 volts max</li> <li>• single or two circuit</li> <li>• electrical contractor responsible for connection to building power source</li> </ul>			<b>HP72</b>	<b>\$227</b>

**To Order, Specify:**

1 Model Number



Description	CTN WT	CU FT	① Model	List Price
Quick Disconnect Power Infeed			MP72	\$209

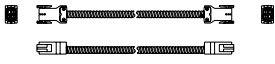

- must be used with QD1
- 72" modular power infeed
- 20 amps/120 volts max
- single or two circuit

Quick Disconnect Wall Outlet			MP72	\$209
------------------------------	--	--	------	-------

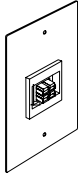

- must be used with MP72
- single or two circuit
- 20 amps/120 volts max
- electrical contractor responsible for connection to building power source

Data Port	1	1	DJ-45	\$94
-----------	---	---	-------	------



- CAT6-RJ45
- 2 data port cut outs per power box
- single unit price

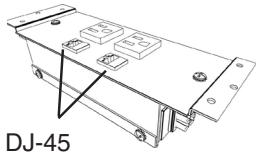

DJ-45  
Locations

Vertical Wire Management	1	1	AVL20	\$73
--------------------------	---	---	-------	------



- available in Black (B) or Silver (S)
- field installed

**To Order, Specify:**

- ① Model Number

## Prep Training Tables - Overview



**Rectangular Table**

24 x 48  
24 x 60  
24 x 72

Page 348

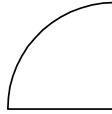

**Quarter Round Linking Top**

24 x 24  
30 x 30

Page 349

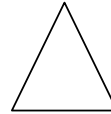

**Wedge Linking Top**

24 - 30 degree  
24 - 45 degree  
24 - 60 degree  
24 - 90 degree

30 - 30 degree  
30 - 45 degree  
30 - 60 degree  
30 - 90 degree

Page 349

### Common Configurations

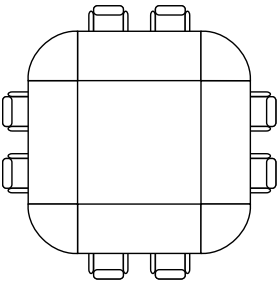
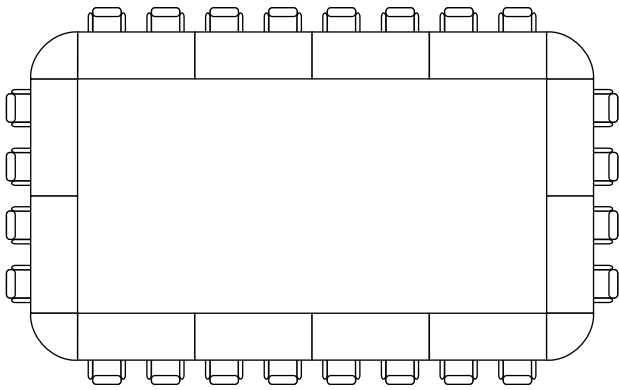
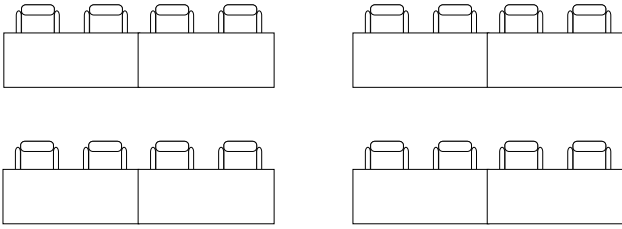

PREP

## Prep Training Tables Product Information

The Prep Training Tables Collection offers rectangular tops with cantilevered tilt bases and fixed metal modesty panels. To help complete your configuration quarter round and wedge linking tops are available.

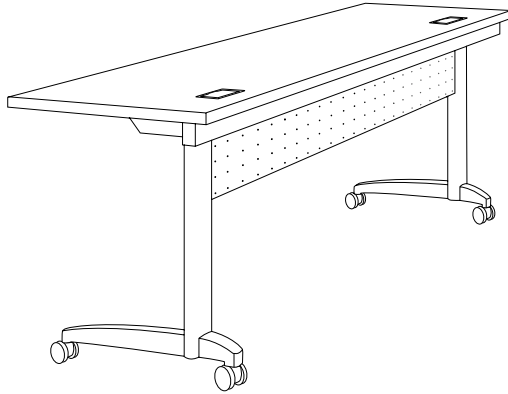

### Tops

- Top shapes available in rectangular and linking quarter round or linking wedges
- Eased edge profile
- Power kits available

### Cantilever Base

- Provides one hand tilt function for easy nesting storage
- Two color options - Black Sandtex (BSX) or Stardust Silver (STS)

### Glides or Casters

- Standard with casters
- Dual-wheel locking
- Color: Black



### Vertical Wire Management (AVL20)

Optional vertical wire management helps control and guide cords from the floor to the table top. Available in black or silver and field installed. Sold separately on page 351.

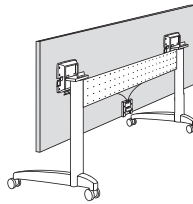

### Tilting Mechanism

Tables are tilted with a release handle centrally located under the table top. Pull the handle to activate the cable release mechanism and easily raise the top into the tilted position for storage or transport. To return, just tilt the top back to the work position until the mechanism locks.

### Leveling Linking Kit

- Easy to install, no tools required when re-configuring tables
- All table tops are pre-bored with inserts to accept field installed linking kit
- 4 black low profile knobs (2 for each table) with quick release flat plate
- 11 gauge steel
- Included on Wedge and Quarter Round table tops

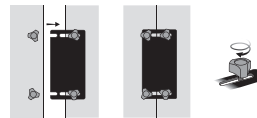

Wedge and Quarter Rounds linking tops are available in ten sizes. (See page 349) All linking tables include linking kits.

## Power Kits

Power kits include power boxes with grommets, connecting cables, wire clamps and safety linking plates. Data ports for internet and network connections are available. Tables can be reconfigured, tilted, nested and stored with power kits installed.

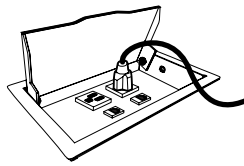

- 2 - electrical receptacles (1 duplex)
- 2 - data cut outs with plastic caps  
data jacks available  
(DJ-45 see page 351)

Prep's electrical package (EP) offers a single and double circuit capability. Data ports for easy internet access and equipment charging are also available.

Included in the power kit:

- Power box with grommet
  - One box for 42" & 48" rectangular tops, trapezoid, half round and AV
  - Two boxes for the 60" & 72" rectangular tops.
- Cables
  - One power kit - Two cables are included; one for each end of the power box
  - Two power kits - Three cables are included; one for each end of the table and one to connect the two boxes
- Wire Cable Clamps - to secure your wires to the underside of the table top



- Safety linking plate - screws to the underside of the table top to secure the tables from being pulled apart accidentally and damaging electrical cables

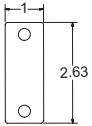

\* Note: If tables are frequently going to be re-configured you may want to order the Leveling Linking Kit.

# Non-Directional & Non-Sequential Single or Double Circuit Electrical System

A non-directional, non-sequential electrical package allows for power in virtually any configuration. Simply disconnect each table, change the configuration, and reconnect the tables no matter the order no matter the direction. Power in-feed cables can be attached to whichever end of a configuration is closest to your power source.

## Non-Directional

### Example 1

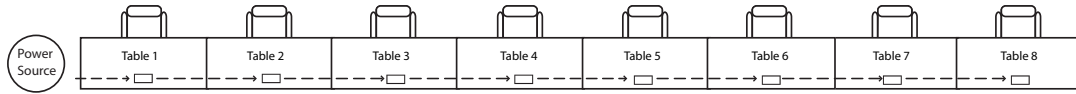

### Example 2

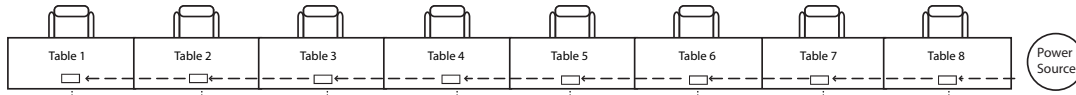

**Note:** Power in-feed cables can be attached to either end of the table configuration

## Non-Sequential

Table order is not a concern with the Prep's electrical system. Never connect more than one power source to a table configuration.

### Example 1

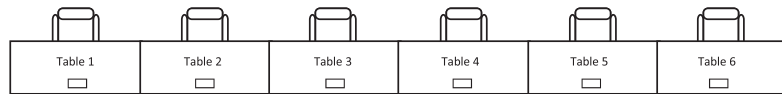

### Example 2



## Identifying Circuits

### Single Circuit

USA/CSA label on power kit under table surface identifies Circuit 1.

LISTED 2554 DISTRIBUTION KUX VILLA 42 LR65415 ELECTRI-CABLE A SSEMBLIES SHELTON, CT 06484 CAT# VIL-4-1-DKO-S INSP BY: _____ DATE: _____ SPECS: 20A 125V DESC: SYS 42 / CIRCUIT 1 WARNING: Risk of fire or electric shock. Always determine that this wiring assembly is electrically connected to one and only one source of supply. AVERTISSEMENT: Risque de feu ou de décharge électrique. Déterminez toujours que le lambris n'est électriquement raccordé qu'à une source unique d'alimentation électrique.	SPECS: 20A 125V DESC: SYS 42/ <b>CIRCUIT 1</b>
--------------------------------------------------------------------------------------------------------------------------------------------------------------------------------------------------------------------------------------------------------------------------------------------------------------------------------------------------------------------------------------------------------------------------------------------------------------------------------------------------------------------------------------------------	---------------------------------------------------

### Double Circuit

USA/CSA label on power kit under table surface identifies Circuit 1 or Circuit 2.

LISTED 2554 DISTRIBUTION KUX VILLA 42 LR65415 ELECTRI-CABLE A SSEMBLIES SHELTON, CT 06484 CAT# VIL-4-1-DKO-S INSP BY: _____ DATE: _____ SPECS: 20A 125V DESC: SYS 42 / CIRCUIT 1 WARNING: Risk of fire or electric shock. Always determine that this wiring assembly is electrically connected to one and only one source of supply. AVERTISSEMENT: Risque de feu ou de décharge électrique. Déterminez toujours que le lambris n'est électriquement raccordé qu'à une source unique d'alimentation électrique.	SPECS: 20A 125V DESC: SYS 42/ <b>CIRCUIT 1</b>
--------------------------------------------------------------------------------------------------------------------------------------------------------------------------------------------------------------------------------------------------------------------------------------------------------------------------------------------------------------------------------------------------------------------------------------------------------------------------------------------------------------------------------------------------	---------------------------------------------------

LISTED 2554 DISTRIBUTION KUX VILLA 42 LR65415 ELECTRI-CABLE A SSEMBLIES SHELTON, CT 06484 CAT# VIL-4-2-DKO-S INSP BY: _____ DATE: _____ SPECS: 20A 125V DESC: SYS 42 / CIRCUIT 2 WARNING: Risk of fire or electric shock. Always determine that this wiring assembly is electrically connected to one and only one source of supply. AVERTISSEMENT: Risque de feu ou de décharge électrique. Déterminez toujours que le lambris n'est électriquement raccordé qu'à une source unique d'alimentation électrique.	SPECS: 20A 125V DESC: SYS 42/ <b>CIRCUIT 2</b>
--------------------------------------------------------------------------------------------------------------------------------------------------------------------------------------------------------------------------------------------------------------------------------------------------------------------------------------------------------------------------------------------------------------------------------------------------------------------------------------------------------------------------------------------------	---------------------------------------------------

PREP

## Single Circuit Guide

- Use for simple, quick connection electrical needs
- Up to 8 power kits can be linked on a single circuit grid
- Each table's electrical components can be connected with cables and secured with safety linking brackets (linking brackets included, field installation required).

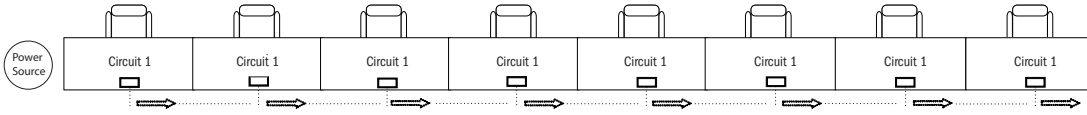

### When connecting your powered tables to building power source you have three options:

**Option 1:** 72" long, 3 prong, 20 amp with 15 amp adapter/110 volt maximum conventional plug (model AP72), see page 292 for ordering information. Many new construction and Canadian facilities will have 20 amp outlets for direct plug in, but power infeed includes 20 amp to 15 amp adapter.

#### AP72

Includes 20 amp infeed and 15 amp adapter

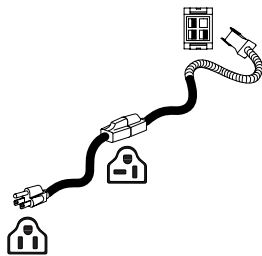

#### 20 amp Infeed

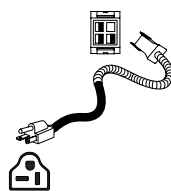

#### 15 amp Adapter

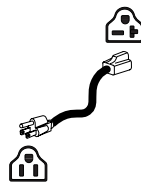

**Option 2:** Quick disconnect hardwired wall outlet (model QD1). 72" long modular power infeed 20amp/120 volts maximum (model MP72), see page 351 for ordering information. Four wire system with two individual circuits.

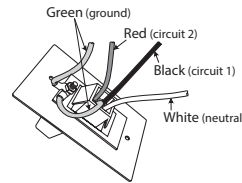
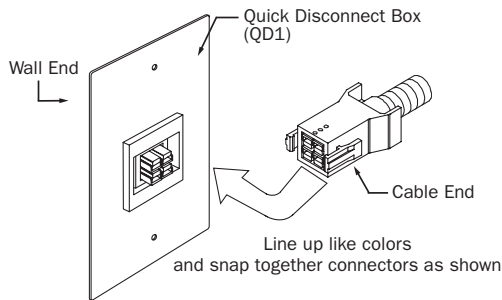

**Option 3:** Hardwired 4-wire power infeed, 72" long, 20 amp/120 volts maximum (model HP72), see page 351 for ordering information. Four wire system with two individual circuits.

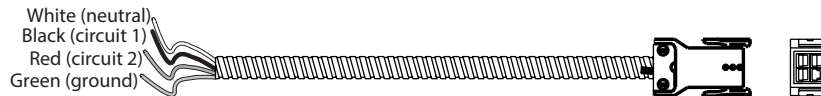

**Note:** Termination of quick disconnect and hardwire power infeed connection to building power source must be completed by a certified licensed electrical contractor. Building and local code appliance is the responsibility of end user.

**WARNING DO NOT ELECTRICALLY CONNECT TO MORE THAN ONE BUILDING POWER SUPPLY SOURCE.**

## Double Circuit Guide

- Double circuit building power source must be wired to support four wire double circuit configurations
- Use for rooms with greater electrical needs
- Up to 16 power kits can be linked on a double circuit grid
- Double circuit hardwire provides 20 amp/120 volt power to each circuit
- Allowing more tables powered from one building power infeed

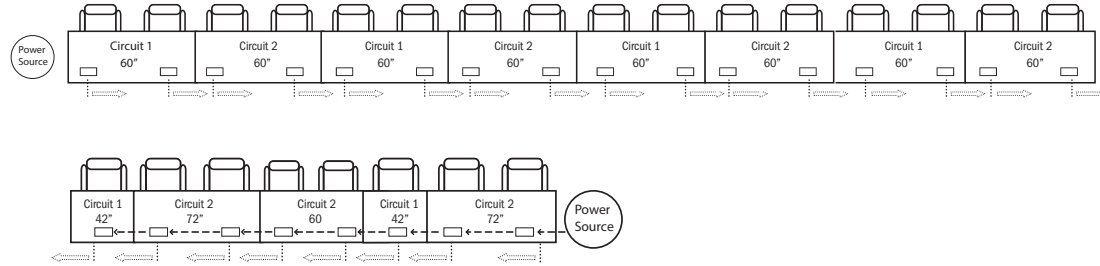

**When connecting your powered tables to building power source you have two options:**

**Option 1:** Quick disconnect hardwired wall outlet (model QD1). 72" long modular power infeed, 20amp/120 volt (model MP72), see page 351 for ordering information

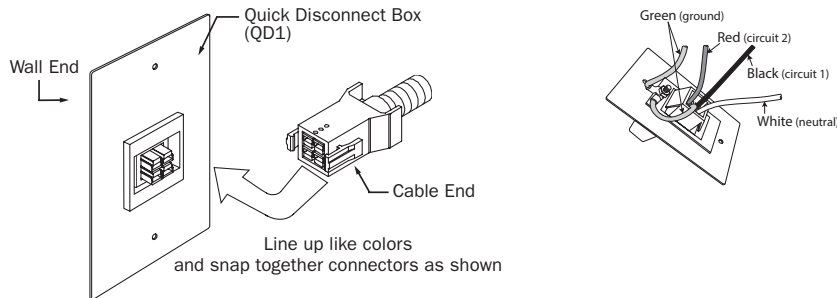

**Option 2:** Hardwired 4-wire power infeed, 72" long, 20 amp/120 volts maximum (model HP72), see page 351 for ordering information. Four wire system with two individual circuits.

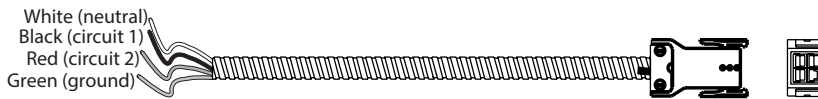

**Note:** Termination of quick disconnect and hardwire power infeed connection to building power source must be completed by a certified licensed electrical contractor. Building and local code appliance is the responsibility of end user.

**WARNING DO NOT ELECTRICALLY CONNECT TO MORE THAN ONE BUILDING POWER SUPPLY SOURCE.**

PREP



# Top Shapes and Sizes with Corresponding Power Kit Locations

## Rectangular

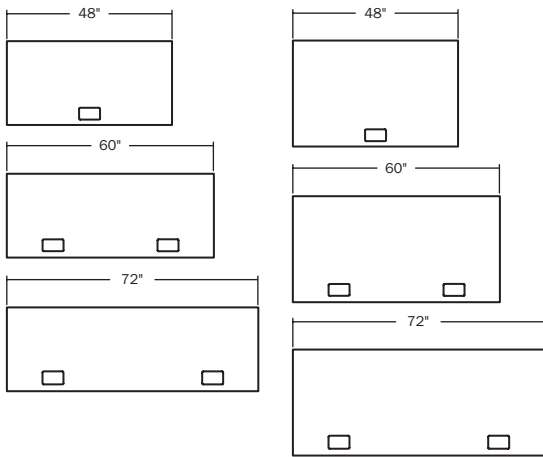

## Wedge Linking Top\*

(includes leveling linking kit)

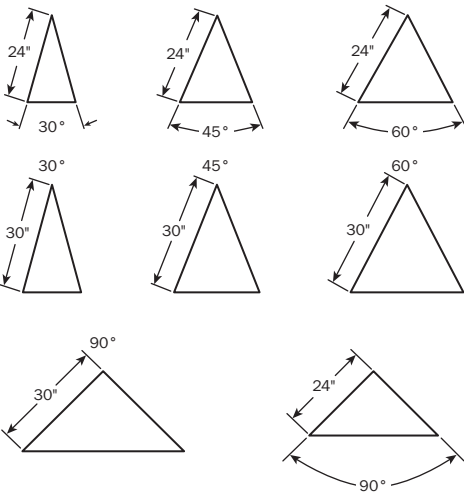

## Quarter Round Linking Top\*

(includes leveling linking kit)

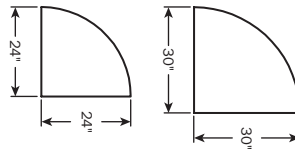

\* Note: Wedge and quarter round linking tops require jumper cables (EKJ-12) ordered separately. (U brackets included, field installation required).

PREP

# How to Specify Prep Training Tables

Follow these easy steps to create an adaptable, mobile learning environment.

## 1. The first step, initial requirements

- A) Determine room configuration which will best fit your needs
- B) Determine seating capacity requirements
- C) Determine your power and data needs
- D) Determine power infeed source
  - power infeed source must be within 6' of first powered table

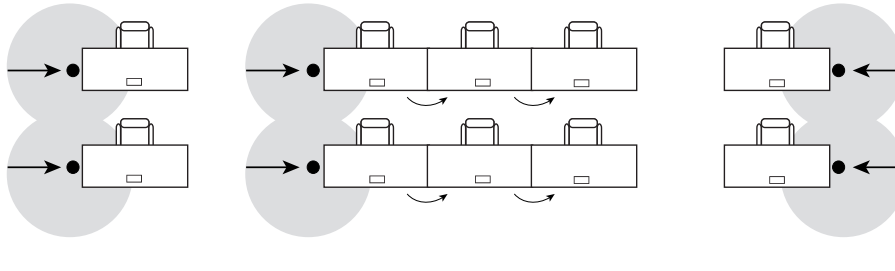

### Power

The black center references the power source location.

The shaded sphere has a 42" radius to indicate the length of the power cord at floor level.

## 2. Determine the Top Shapes and Sizes, as well as the number of tops needed for the chosen table configuration. (See page 296 for seating capacity options.)

### A) Table Placement Guidelines

- 24" - 30" per person
- 48" for aisles
- 48" from side walls
- 96" - 120" for presenter between front wall and first row
- 48" between rows
- 84" from back wall

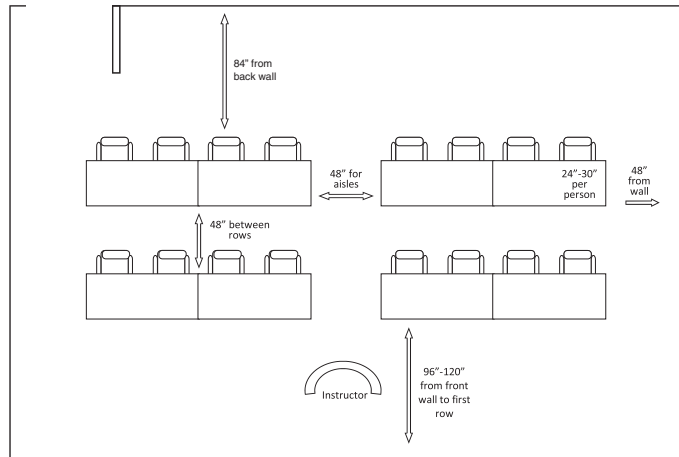

### B) ADA Guidelines

- 34" - 36" per wheelchair table space
- 24" minimum table depth
- 60" - 72" between rows for wheelchairs to be placed back-to-back
- 36" minimum for wheelchair single passage
- 60" minimum for wheelchair double passage
- 60" minimum diameter to turn wheelchair
- 29" height accommodates newer wheelchairs; however, some wheelchairs require 32" height.

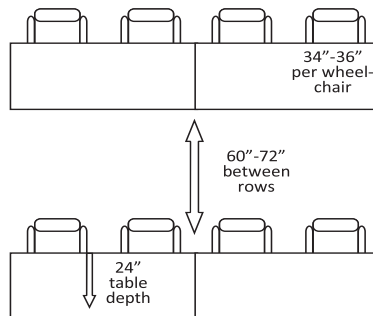

## Wilsonart Laminate Tier 2

JSI offers an extensive program for laminates beyond our Standard Program. Always reference our website for the most current listing when using a [Graded-In Laminate](#), on page 347 select the color of the PVC edge color.

Laminate	Pattern #	Tier	Laminate	Pattern #	Tier	Laminate	Pattern #	Tier
Almond Leather	2932-60	2	Kingswood Walnut	8218-38	2	Silicon EV	4811-60	2
Antique White	1572-60	2	Lapis Blue	D417-60	2	Soft Gold Mesh	4911-38	2
Atlantis	D25-60	2	Light Beige	1531-60	2	Solar Oak	7816-60	2
Bannister Oak	7806-60	2	Limber Maple	10734-60	2	Sprout	4918-60	2
Beige	1530-60	2	Linen	D427-60	2	Steel Mesh	4879-38	2
Beige Pampus	4170-60	2	Loden Zephyr	4844-60	2	Sterling Ash	7995-38	2
Beigewood	7850-60	2	Lowell Ash	7994-38	2	Tailored Linen	4992-38	2
Black	1595-60	2	Mangalore Mango	7984-38	2	Tan Soapstone	4887-38	2
Blue Agave	4919-60	2	Manitoba Maple	7911-60	2	Tangerine	4915-60	2
Boardwalk Oak	7983-38	2	Maroochy Brush	4745-60	2	Tawny Legacy	4663-60	2
Brittany Blue	D321-60	2	Midnight	D505-60	2	Titanium EV	4810-60	2
Bronze Legacy	4656-60	2	Mission Maple	7990-38	2	Tungsten EV	4814-60	2
Buka Bark	7982-38	2	Misted Zephyr	4843-60	2	Tuscan Walnut	7921-38	2
Burnished Chestnut	4796-60	2	Monticello Maple	7925-38	2	Twilight Zephyr	4845-60	2
Canyon Zephyr	4842-60	2	Morelia Mango	7985-38	2	Wallaby	D439-60	2
Carbon EV	4820-60	2	Morro Zephyr	4846-60	2	Washi Crystal	5017-38	2
Carbon Mesh	4880-38	2	Natural Almond	D30-60	2	Washi Gold	5019-38	2
Castle Oak	7928-38	2	Natural Cotton	4946-38	2	Washi Pewter	5018-38	2
Casual Linen	4944-38	2	Natural Nebula	4633-60	2	White Carrara	4924-38	2
Cement	D503-60	2	Natural Pear	7061-60	2	White Cascade	5003-38	2
Classic Linen	4943-38	2	Natural Recon	7996-38	2	White Nebula	4621-60	2
Cloud Nebula	4630-60	2	Natural Rift	7954-38	2	White Sand	D403-60	2
Cloud Zephyr	4856-60	2	Natural Tigris	4669-60	2	White Tigris	4783-60	2
Coffee Bean	D495-60	2	Navy Legacy	4651-60	2	White-Matte	1570-60	2
Crisp Linen	4942-38	2	NeoWalnut	7991-38	2	Wild Cherry	7054-60	2
Crystal	D388-60	2	Neutral Glace	4143-60	2	Windswept Bronze	4794-38	2
Desert Zephyr	4841-60	2	New Age Oak	7938-38	2	Windswept Pewter	4795-60	2
Dove Grey	D92-60	2	Nickel EV	4813-60	2	Woolamai Brush	4746-60	2
Ebony Recon	7997-38	2	Nordic Linen	5015-38	2			
Eggplant	4913-60	2	North Sea	D90-60	2			
Evening Tigris	4674-60	2	Oiled Soapstone	4882-38	2			
Fashion Grey	D381-60	2	Orange Grove	D501-60	2			
Fired Steel	4994-60	2	Organic Cotton	4945-38	2			
Flax Linen	4990-38	2	Oxide	1787-60	2			
Fonthill Pear	10745-60	2	Palisades Oak	7987-38	2			
Forged Steel	4995-60	2	Pampus	4166-60	2			
Fossil Shale	D504-60	2	Pasadena Oak	7986-38	2			
French Linen	5016-38	2	Pearl Soapstone	4886-38	2			
French Pear	8220-38	2	Pepperdust	D327-60	2			
Frosty White	1573-60	2	Pewter	D73-60	2			
Fusion Maple	7909-60	2	Pewter Brush	4779-60	2			
Gesso Tracery	4962-38	2	Pewter Mesh	4878-38	2			
Glided Mesh	4912-38	2	Pinball	4937-38	2			
Graphite Nebula	4623-60	2	Platinum	D315-60	2			
Green Soapstone	4885-38	2	Port	D14-60	2			
Green Tigris	4667-60	2	Pressed Linen	4991-38	2			
Grey	1500-60	2	Putty	1503-60	2			
Grey Glace	4142-60	2	Raw Cotton	4947-38	2			
Grey Mesh	4877-38	2	River Cherry	7937-38	2			
Grey Nebula	4622-60	2	Rugged Linen	4989-38	2			
Grey Pampas	4168-60	2	Rustic Slate	4888-38	2			
Harvest Maple	7953-38	2	Sable Soapstone	4883-38	2			
High Rise	4996-38	2	Sap Walnut	8221-38	2			
Hollyberry	D307-60	2	Shadow Zephyr	4857-60	2			
Huntington Maple	7929-38	2	Sap Walnut	8221-38	2			
Indigo	D379-60	2	Shadow Zephyr	4857-60	2			
Irish Linen	4993-38	2	Sheer Mesh	4876-38	2			
Khaki Brown	D50-60	2	Sierra Cascade	5005-38	2			

# Prep Training Tables Order Check List:



**Specify:**

- 1. Model Number
- 2. Base Color - Black Sandtex (BSX) or Stardust Silver (STS)
- 3. Top Laminate Color
- 4. Edge Color
- 5. Optional Leveling Linking Kit
- 6. Optional Electrical Package

**Example:**

<b>PR2472CTT</b> (model #)	<b>STS</b> (base/modesty)	<b>4622-60</b> (top laminate color)	<b>BLK</b> (edge color)		
-------------------------------	------------------------------	----------------------------------------	----------------------------	--	--

**1. Model Number**

**2. Base Color - Black Sandtex (BSX) or Stardust Silver (STS)**

**3. Top Laminate Color**

**JSI Standard Laminates - Tier 1**

**Wood Grain Laminate**

<b>AGA</b> Aged Ash	<b>GRH</b> Graphite
<b>ALL</b> Ale Light	<b>HGL</b> High Line
<b>BLO</b> Blonde Echo	<b>OAT</b> Oatmeal Cookie
<b>BOL</b> Bourbon Light	<b>PIN</b> Pinnacle Walnut
<b>BZW</b> Brazilwood	<b>STU</b> Studio Teak
<b>BGL</b> Brighton Light	<b>VIN</b> Vintage
<b>CLL</b> Collectors	<b>WLH</b> Walnut Heights
<b>FLO</b> Florence Walnut	<b>WEA</b> Weathered Ash

**Solid Laminate**

<b>ALB</b> Alabaster	<b>FWH</b> Frosty White
<b>BLK</b> Black	<b>PLT</b> Platinum
<b>BBL</b> Bridal Blanco	<b>SHD</b> Shadow
<b>DWH</b> Designer White	<b>SLG</b> Slate Grey
<b>DOV</b> Dove Grey	<b>STU</b> Studio Teak

see page 346 for Tier 2, Graded-In Laminate

**4. Edge Color:**

<b>AGA</b> Aged Ash	<b>FWH</b> Frosty White
<b>ALB</b> Alabaster	<b>GRH</b> Graphite
<b>ALL</b> Ale Light	<b>HGL</b> High Line
<b>BLK</b> Black	<b>OAT</b> Oatmeal Cookie
<b>BLO</b> Blonde Echo	<b>PIN</b> Pinnacle Walnut
<b>BOL</b> Bourbon Light	<b>PLT</b> Platinum
<b>BZW</b> Brazilwood	<b>SHD</b> Shadow
<b>BBL</b> Bridal Blanco	<b>SLG</b> Slate Grey
<b>BGL</b> Brighton Light	<b>STU</b> Studio Teak
<b>CLL</b> Collectors	<b>VIN</b> Vintage
<b>DWH</b> Designer White	<b>WLH</b> Walnut Heights

**5. Optional Leveling Linking Kit (L) - add \$66 list**

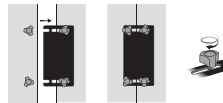

**6. Optional Power Kit Package\***

**\*Grommet color option - Black (B) or Silver (S)**

**Rectangular 42" & 48", AV, Trapezoid, Half Round - add \$394 list (1 power kit per table)**

- PREP-EPIC (single circuit)
- PREP-EP2C-1 (double circuit) (circuit 1)
- PREP-EP2C-2 (double circuit) (circuit 2)

**Rectangular 60" & 72" - add \$606 list (2 power kits per table)**

- PREP-EPID (single circuit)
- PREP-EP2D-1 (double circuit) (circuit 1)
- PREP-EP2D-2 (double circuit) (circuit 2)

**7. Power Infeed Cables; see page 351 for power specifications**

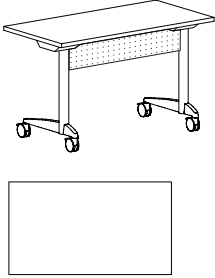
Description	D	W	H (LS/LP)	CTN WT	CU FT	① Model	Standard Tier 1	Graded In Tier 2
Rectangular Table 	24	48	29	65	9	PR2448CTT	\$1,902	\$1,932
	30	48	29	71	10	PR3048CTT	\$1,979	\$2,016
	24	60	29	75	10	PR2460CTT	\$1,997	\$2,030
	24	72	29	85	11	PR2472CTT	\$2,092	\$2,136
	30	60	29	82	11	PR3060CTT	\$2,115	\$2,161
	30	72	29	94	13	PR3072CTT	\$2,224	\$2,273

Description	D	W	H (LS/LP)	CTN WT	CU FT	① Model	Standard Tier 1	Graded In Tier 2
Quarter Round Linking Top	24	24	1 3/16	21	2	PR24QT	\$388	\$415
	30	30	1 3/16	30	3	PR30QT	\$468	\$502

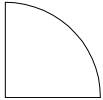

- linking brackets included
- when jumper is used in configurations with power kits an EJK-12 corner electrical jumper cable must be specified; see page 350

Description	D	W	H (LS/LP)	CTN WT	CU FT	① Model	Standard Tier 1	Graded In Tier 2
Wedge Linking Top	24	N/A	1 3/16	11	1	PR24-30WT 30 degree	\$388	\$415
	24	N/A	1 3/16	16	1	PR24-45WT 45 degree	\$396	\$422
	24	N/A	1 3/16	20	2	PR24-60WT 60 degree	\$399	\$425
	24	N/A	1 3/16	28	2	PR24-90WT 90 degree	\$430	\$459



30	N/A	1 3/16	16	1	PR30-30WT 30 degree	\$391	\$417
30	N/A	1 3/16	24	2	PR30-45WT 45 degree	\$430	\$459
30	N/A	1 3/16	30	2	PR30-60WT 60 degree	\$449	\$483
30	N/A	1 3/16	42	3	PR30-90WT 90 degree	\$516	\$553



- linking brackets included
- when jumper is used in configurations with power kits an EJK-12 corner electrical jumper cable must be specified; see page 350

**To Order, Specify:**

- ① Model Number
- ② Base/Modesty Color
- ③ Top Laminate Color
- ④ Edge Color
- ⑤ Other Product Modifications

**Specifications**

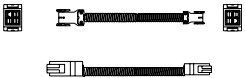
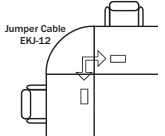
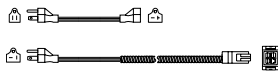
- Top construction is 1 1/8" thick particle board. The laminate face is horizontal grade high pressure laminate (HPL). A backer is bonded to the bottom side to ensure balanced construction.
- Assembled powder coated bases are produced in a cantilever configuration to standard height with base rail lengths matched with top sizes.

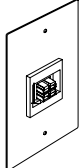
Description	D	W	H	CTN WT	CU FT	① Model	List Price
<b>Corner Electrical Jumper Cable</b>  						<b>EJK-12</b>	<b>\$143</b>
<ul style="list-style-type: none"> <li>· 12" corner jumper cable</li> <li>· use for wedges, 90 degree corners and half round tables</li> </ul>							
<b>3 Prong Power Infeed</b> 						<b>AP72</b>	<b>\$280</b>
<ul style="list-style-type: none"> <li>· 72" plug power infeed</li> <li>· 20 amps/110 volts max</li> <li>· 3 prong plug - 15 amp adapter plug</li> <li>· single circuit use only</li> </ul>							
<b>Hardwire Power Infeed</b> 						<b>HP72</b>	<b>\$227</b>
<ul style="list-style-type: none"> <li>· 72" hardwire power infeed</li> <li>· 20 amps/120 volts max</li> <li>· single or two circuit</li> <li>· electrical contractor responsible for connection to building power source</li> </ul>							
<b>Quick Disconnect Power Infeed</b> 						<b>MP72</b>	<b>\$209</b>
<ul style="list-style-type: none"> <li>· must be used with QD1</li> <li>· 72" modular power infeed</li> <li>· 20 amps/120 volts max</li> <li>· single or two circuit</li> </ul>							
<b>Quick Disconnect Wall Outlet</b> 						<b>QD1</b>	<b>\$107</b>
<ul style="list-style-type: none"> <li>· must be used with MP72</li> <li>· single or two circuit</li> <li>· 20 amps/120 volts max</li> <li>· electrical contractor responsible for connection to building power source</li> </ul>							

PREP

Description	CTN WT	CU FT	❶ Model	List Price
Data Port	1	1	DJ-45	\$94



- CAT6-RJ45
- 2 data port cut outs per power box
- single unit price

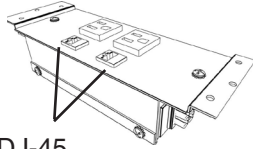

DJ-45  
Locations

Vertical Wire Management	1	1	AVL20	\$73
--------------------------	---	---	-------	------



- available in Black (B) or Silver (S)
- field installed

**To Order, Specify:**

- ❶ Model Number
- ❷ Color (EC10 & EC11)

PREP



# Prost Occasional Tables Order Check List:



**Specify:**

- 1. Model Number
- 2. Material Selection
  - a.) Laminate
    - 1.) Laminate Color - See list below
  - b.) Veneer
    - 1.) Wood Species - Cherry (CH1), Maple (MA1), Walnut (WA1) or Double Cut (DC1)
    - 2.) Wood Finish - See list below
- 3. Metal Leg Color - Arctic Silver (ASL), Bright White (BWH), Matte Black (MBK), Pewter (PEW), or Soft Nickel (SNK)
- 4. Optional Top Overlay
  - a.) White Back Painted Glass - add \$1,328 list for 18" dia., \$1,622 list for 24" dia., \$1,870 list for 36" dia.
  - b.) Solid Surface - add \$832 list for 18" dia., \$1,040 list for 24" dia., \$1,786 list for 36" dia.
    - 1.) Solid Surface Color - Armadillo (ARM), Black Pearl (BLP), Pebble Pearl (PEB) or Pure White (PUR)
- 5. Optional Power Center (leg models only) - Node (EC24) - Black (B) or White (W); order separately \$464 list each

**Example:**

<b>PSV24-18RDC</b> (model #)	<b>WA1</b> (veneer species)	<b>MCH</b> (wood finish)	<b>BWH</b> (metal frame)	<b>PUR</b> (top overlay)
---------------------------------	--------------------------------	-----------------------------	-----------------------------	-----------------------------

**1. Model Number**

**2. Material Selection:**

**Laminate**

Solid Laminates

ALB Alabaster	SHD Shadow
BBL Bridal Blanco	SLG Slate Grey
DWH Designer White	

Veneer Grain Pattern Laminates

AGA Aged Ash	GRH Graphite
ALE Ale Light	HGL High Line
BLO Blonde Echo	OAT Oatmeal Cookie
BOL Bourbon Light	PIN Pinnacle Walnut
BZW Brazilwood	STU Studio Teak
BGL Brighton Light	VIN Vintage
CLL Collectors	WLH Walnut Heights
FLO Florence Walnut	WEA Weathered Ash

**Veneer**

**Flat Cut**

Cherry (CH1)	Maple (MA1)	Walnut (WA1)
BRL Barley	ALE Ale	AUB Auburn
BBM Bourbon Medium	BUT Butterscotch	ESP Espresso
BRM Brighton Medium	CIN Cinnamon	MCH Mocha
CLA Classic	FLX Flax	NTO Night Owl
CLL Collectors	VEN Venetian	SIE Sienna
EAR Earthy		TOF Toffee
HRV Harvest		TRF Truffle
LGC Legacy		
PRL Praline		
SAF Saffron		

**Double Cut (DC1)**

COF Coffee	GRH Graphite
CRM Cremello	KHK Khaki
FOS Fossil	STU Studio Teak

**3. Metal Leg Color:**

ASL Arctic Silver	PEW Pewter
BWH Bright White	SNK Soft Nickel
MBK Matte Black	

**4. Optional Top Overlay**

**White Back Painted Glass** - add \$1,328 list for 18" dia. tables, \$1,622 list for 24" dia. tables, \$1,870 list for 36" dia. tables



**Solid Surface** - add \$832 list for 18" dia. tables, \$1,040 list for 24" dia. tables, \$1,786 list for 36" dia. tables

**Color Selection:**

ARM Armadillo	PEB Pebble Pearl
BLP Black Pearl	PUR Pure White

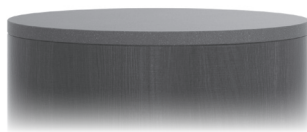

**5. Optional Power Center (EC24) - order separately \$464 list**

Specify color: Black (B) or White (W)

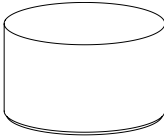

**Note:** Power only available on leg models. Cannot be used in conjunction with glass and solid surface tops. (Only with laminate and veneer tops.)

Description	D	W	H	CTN WT	CU FT	① Model	Laminate	Flat Cut Veneer	Double Cut Veneer
15" h Cylinder Column Table with 3/4" Plinth	36	36	15	80	15	PST36-15RDA	\$1,614		
	36	36	15	80	15	PSV36-15RDA		\$1,852	\$2,333
	24	24	15	50	7	PST24-15RDA	\$1,192		
	24	24	15	50	7	PSV24-15RDA		\$1,326	\$1,602
	18	18	15	40	4	PST18-15RDA	\$1,040		
	18	18	15	40	4	PSV18-15RDA		\$1,128	\$1,338

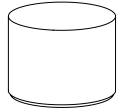

**Features:**

- 3/4" black laminate plinth
- nylon tack glides

**Options:**

- white back painted glass top overlay available; add \$1,328 list for 18" dia. tables, \$1,622 list for 24" dia. tables, \$1,870 list for 36" dia. tables
- solid surface top overlay available; add \$832 list for 18" dia. tables, \$1,040 list for 24" dia. tables, \$1,786 list for 36" dia. tables

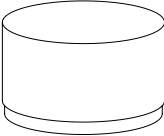
15" h Cylinder Column Table with 3" Plinth	36	36	15	80	15	PST36-15RDB	\$1,794		
	36	36	15	80	15	PSV36-15RDB		\$1,978	\$2,458
	24	24	15	50	7	PST24-15RDB	\$1,356		
	24	24	15	50	7	PSV24-15RDB		\$1,482	\$1,756
	18	18	15	40	4	PST18-15RDB	\$1,104		
	18	18	15	40	4	PSV18-15RDB		\$1,193	\$1,403

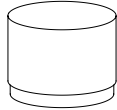

**Features:**

- 3" black laminate plinth
- nylon tack glides

**Options:**

- white back painted glass top overlay available; add \$1,328 list for 18" dia. tables, \$1,622 list for 24" dia. tables, \$1,870 list for 36" dia. tables
- solid surface top overlay available; add \$832 list for 18" dia. tables, \$1,040 list for 24" dia. tables, \$1,786 list for 36" dia. tables

**To Order, Specify:**

- ① Model Number
- ② Material Selection:
  - a.) Laminate
    - 1.) Laminate Color
  - b.) Veneer
    - 1.) Wood Species - Cherry (CH1), Maple (MA1), Walnut (WA1) or Double Cut (DC1)
      - a.) Finish Color
- ③ Metal Leg Color - Arctic Silver (ASL), Bright White (BWH), Matte Black (MBK), Pewter (PEW) or Soft Nickel (SNK)
- ④ Optional Top Overlay: see page 352 for upcharge
  - a.) White Back Painted Glass
  - b.) Solid Surface - Armadillo (ARM), Black Pearl (BLP), Pebble Pearl (PEB) or Pure White (PUR)
- ⑤ Optional Power Center (EC24) - add \$464 list
  - a.) Color: Black (B) or White (W)

**②a) Laminate Top Options:**

Solid Laminates

ALB	Alabaster	SHD	Shadow
BBL	Bridal Blanco	SLG	Slate Grey
DWH	Designer White		

Veneer Grain Pattern Laminates

AGA	Aged Ash	CLL	Collectors	STU	Studio Teak
ALL	Ale Light	FLO	Florence Walnut	VIN	Vintage
BLO	Blonde Echo	GRH	Graphite	WLH	Walnut Heights
BOL	Bourbon Light	HGL	High Line	WEA	Weathered Ash
BZW	Brazilwood	OAT	Oatmeal Cookie		
BGL	Brighton Light	PIN	Pinnacle Walnut		

**②b) Veneer Top Finish Options:**

<u>Cherry</u>		<u>Maple</u>		<u>Walnut</u>	
BRL	Barley	ALM	Ale Medium	AUB	Auburn
BBN	Bourbon Medium	BUT	Butterscotch	ESP	Espresso
BRG	Brighton Medium	CIN	Cinnamon	MCH	Mocha
CLA	Classic	FLX	Flax	NTO	Night Owl
CLL	Collectors	VEN	Venetian	SIE	Sienna
EAR	Earthy			TOF	Toffee
HRV	Harvest			TRF	Truffle
LGC	Legacy				
PRL	Praline				
SAF	Saffron				

Double Cut

COF	Coffee	GRH	Graphite
CRM	Cremello	KHK	Khaki
FOS	Fossil	STU	Studio Teak

**Specifications**

**Tops:**

- Optional glass or solid surface tops are 1/2" thick and sit on cylinder via attached non skid glides
- Glass is back painted white and a tempered satin surface

**Plinths:**



- Plinth base models have tack in button glides.
- Plinth is always black.

**Legs:**

- Leg models have non adjustable knock in glides.
- Leg models come with 5 legs for all sizes.

**Power:**

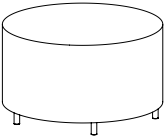
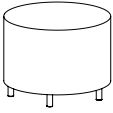
- Power only available on leg models. Cannot be used in conjunction with glass and solid surface tops. (Only with laminate and veneer tops)



Description	D	W	H	CTN WT	CU FT	① Model	Laminate	Flat Cut Veneer	Double Cut Veneer
<b>15"h Cylinder Column Table with Legs</b>   	36	36	15	80	15	PST36-15RDC	\$1,716		
	36	36	15	80	15	PSV36-15RDC		\$1,934	\$2,364
	24	24	15	50	7	PST24-15RDC	\$1,368		
	24	24	15	50	7	PSV24-15RDC		\$1,442	\$1,682
	18	18	15	40	4	PST18-15RDC	\$1,186		
	18	18	15	40	4	PSV18-15RDC		\$1,275	\$1,486

**Features:**

- 3" metal leg
- black nylon glides

**Options:**

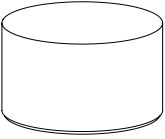
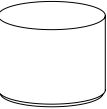
- white back painted glass top overlay available; add \$1,328 list for 18" dia. tables, \$1,622 list for 24" dia. tables, \$1,870 list for 36" dia. tables
- solid surface top overlay available; add \$832 list for 18" dia. tables, \$1,040 list for 24" dia. tables, \$1,786 list for 36" dia. tables
- power center (EC24) - order as separate item, not available on glass or solid surface



<b>18"h Cylinder Column Table with 3/4" Plinth</b>   	36	36	18	80	18	PST36-18RDA	\$1,806		
	36	36	18	80	18	PSV36-18RDA		\$2,237	\$2,563
	24	24	18	50	9	PST24-18RDA	\$1,265		
	24	24	18	50	9	PSV24-18RDA		\$1,396	\$1,706
	18	18	18	40	5	PST18-18RDA	\$1,071		
	18	18	18	40	5	PSV18-18RDA		\$1,226	\$1,433

**Features:**

- 3/4" black laminate plinth
- nylon tack glides

**Options:**

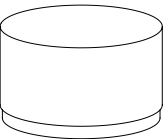
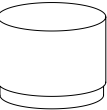
- white back painted glass top overlay available; add \$1,328 list for 18" dia. tables, \$1,622 list for 24" dia. tables, \$1,870 list for 36" dia. tables
- solid surface top overlay available; add \$832 list for 18" dia. tables, \$1,040 list for 24" dia. tables, \$1,786 list for 36" dia. tables

<b>18"h Cylinder Column Table with 3" Plinth</b>   	36	36	18	80	18	PST36-18RDB	\$1,901		
	36	36	18	80	18	PSV36-18RDB		\$2,154	\$2,683
	24	24	18	50	9	PST24-18RDB	\$1,431		
	24	24	18	50	9	PSV24-18RDB		\$1,514	\$1,860
	18	18	18	40	5	PST18-18RDB	\$1,136		
	18	18	18	40	5	PSV18-18RDB		\$1,287	\$1,498



**Features:**

- 3" black laminate plinth
- nylon tack glides

**Options:**

- white back painted glass top overlay available; add \$1,328 list for 18" dia. tables, \$1,622 list for 24" dia. tables, \$1,870 list for 36" dia. tables
- solid surface top overlay available; add \$832 list for 18" dia. tables, \$1,040 list for 24" dia. tables, \$1,786 list for 36" dia. tables

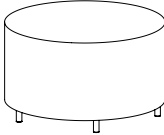
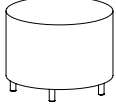
PROST



Description	D	W	H	CTN WT	CU FT	① Model	Laminate	Flat Cut Veneer	Double Cut Veneer
<b>18" h Cylinder Column Table with Legs</b>   	36	36	18	80	18	PST36-18RDC	\$1,920		
	36	36	18	80	18	PSV36-18RDC		\$2,061	\$2,541
	24	24	18	50	9	PST24-18RDC	\$1,441		
	24	24	18	50	9	PSV24-18RDC		\$1,513	\$1,788
	18	18	18	40	5	PST18-18RDC	\$1,281		
	18	18	18	40	5	PSV18-18RDC		\$1,335	\$1,577

**Features:**

- 3" metal leg
- black nylon glides

**Options:**

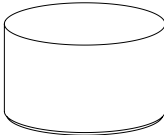
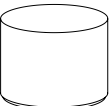
- white back painted glass top overlay available; add \$1,328 list for 18" dia. tables, \$1,622 list for 24" dia. tables, \$1,870 list for 36" dia. tables
- solid surface top overlay available; add \$832 list for 18" dia. tables, \$1,040 list for 24" dia. tables, \$1,786 list for 36" dia. tables
- power center (EC24) - order as separate item. Not Available on Glass or Solid Surface

<b>21" h Cylinder Column Table with 3/4" Plinth</b>   	36	36	21	80	20	PST36-21RDA	\$1,907		
	36	36	21	80	20	PSV36-21RDA		\$2,127	\$2,708
	24	24	21	50	9	PST24-21RDA	\$1,331		
	24	24	21	50	9	PSV24-21RDA		\$1,487	\$1,832
	18	18	21	40	6	PST18-21RDA	\$1,104		
	18	18	21	40	6	PSV18-21RDA		\$1,296	\$1,565

**Features:**

- 3/4" black laminate plinth
- nylon tack glides

**Options:**

- white back painted glass top overlay available; add \$1,328 list for 18" dia. tables, \$1,622 list for 24" dia. tables, \$1,870 list for 36" dia. tables
- solid surface top overlay available; add \$832 list for 18" dia. tables, \$1,040 list for 24" dia. tables, \$1,786 list for 36" dia. tables

**To Order, Specify:**

- ① Model Number
- ② Material Selection:
  - a.) Laminate
    - 1.) Laminate Color
  - b.) Veneer
    - 1.) Wood Species - Cherry (CH1), Maple (MA1), Walnut (WA1) or Double Cut (DC1)
      - a.) Finish Color
- ③ Metal Leg Color - Arctic Silver (ASL), Bright White (BWH), Matte Black (MBK), Pewter (PEW) or Soft Nickel (SNK)
- ④ Optional Top Overlay: see page 352 for upcharge
  - a.) White Back Painted Glass
  - b.) Solid Surface - Armadillo (ARM), Black Pearl (BLP), Pebble Pearl (PEB) or Pure White (PUR)
- ⑤ Optional Power Center (EC24) - add \$464 list
  - a.) Color: Black (B) or White (W)

**②a) Laminate Top Options:**

Solid Laminates

ALB	Alabaster	SHD	Shadow
BBL	Bridal Blanco	SLG	Slate Grey
DWH	Designer White		

Veneer Grain Pattern Laminates

AGA	Aged Ash	CLL	Collectors	STU	Studio Teak
ALL	Ale Light	FLO	Florence Walnut	VIN	Vintage
BLO	Blonde Echo	GRH	Graphite	WLH	Walnut Heights
BOL	Bourbon Light	HGL	High Line	WEA	Weathered Ash
BZW	Brazilwood	OAT	Oatmeal Cookie		
BGL	Brighton Light	PIN	Pinnacle Walnut		

**②b) Veneer Top Finish Options:**

<u>Cherry</u>	<u>Maple</u>	<u>Walnut</u>			
BRL	Barley	ALM	Ale Medium	AUB	Auburn
BBN	Bourbon Medium	BUT	Butterscotch	ESP	Espresso
BRG	Brighton Medium	CIN	Cinnamon	MCH	Mocha
CLA	Classic	FLX	Flax	NTO	Night Owl
CLL	Collectors	VEN	Venetian	SIE	Sienna
EAR	Earthy			TOF	Toffee
HRV	Harvest			TRF	Truffle
LGC	Legacy				
PRL	Praline				
SAF	Saffron				

Double Cut

COF	Coffee	GRH	Graphite
CRM	Cremello	KHK	Khaki
FOS	Fossil	STU	Studio Teak

**Specifications**

**Tops:**

- Optional glass or solid surface tops are 1/2" thick and sit on cylinder via attached non skid glides
- Glass is back painted white and a tempered satin surface

**Plinths:**

- Plinth base models have tack in button glides.
- Plinth is always black.

**Legs:**

- Leg models have non adjustable knock in glides.
- Leg models come with 5 legs for all sizes.

**Power:**

- Power only available on leg models. Cannot be used in conjunction with glass and solid surface tops. (Only with laminate and veneer tops)

When ordering Quickship products, place a "Q" in front of model number. Example: QV3072DD



Description	D	W	H	CTN WT	CU FT	① Model	Laminate	Flat Cut Veneer	Double Cut Veneer
21" h Cylinder Column Table with 3" Plinth	36	36	21	80	20	PST36-21RDB	\$2,088		
	36	36	21	80	20	PSV36-21RDB		\$2,222	\$2,847
	24	24	21	50	9	PST24-21RDB	\$1,494		
	24	24	21	50	9	PSV24-21RDB		\$1,666	\$2,011
	18	18	21	40	6	PST18-21RDB	\$1,167		
	18	18	21	40	6	PSV18-21RDB		\$1,576	\$1,845

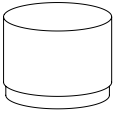
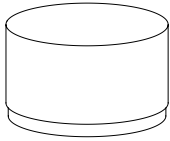

**Features:**

- 3" black laminate plinth
- nylon tack glides

**Options:**

- white back painted glass top overlay available; add \$1,328 list for 18" dia. tables, \$1,622 list for 24" dia. tables, \$1,870 list for 36" dia. tables
- solid surface top overlay available; add \$832 list for 18" dia. tables, \$1,040 list for 24" dia. tables, \$1,786 list for 36" dia. tables

Description	D	W	H	CTN WT	CU FT	① Model	Laminate	Flat Cut Veneer	Double Cut Veneer
21" h Cylinder Column Table with Legs	36	36	21	80	20	PST36-21RDC	\$2,020		
	36	36	21	80	20	PSV36-21RDC		\$2,124	\$2,653
	24	24	21	50	9	PST24-21RDC	\$1,510		
	24	24	21	50	9	PSV24-21RDC		\$1,579	\$1,888
	18	18	21	40	6	PST18-21RDC	\$1,325		
	18	18	21	40	6	PSV18-21RDC		\$1,611	\$1,851

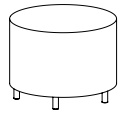
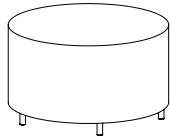

**Features:**

- 3" metal leg
- black nylon glides

**Options:**

- white back painted glass top overlay available; add \$1,328 list for 18" dia. tables, \$1,622 list for 24" dia. tables, \$1,870 list for 36" dia. tables
- solid surface top overlay available; add \$832 list for 18" dia. tables, \$1,040 list for 24" dia. tables, \$1,786 list for 36" dia. tables
- power center (EC24) - order as separate item. Not Available on Glass or Solid Surface

<b>Node Power Unit</b>	3 3/8	3 3/8	3/8	5	1	<b>EC24</b>			<b>\$464</b>
------------------------	-------	-------	-----	---	---	-------------	--	--	--------------



- black or white
- one power and one dual USB, 72" cord

**To Order, Specify:**

- ① Model Number
- ② Material Selection:
  - a.) Laminate
    - 1.) Laminate Color
  - b.) Veneer
    - 1.) Wood Species - Cherry (CH1), Maple (MA1), Walnut (WA1) or Double Cut (DC1)
    - a.) Finish Color
- ③ Metal Leg Color - Arctic Silver (ASL), Bright White (BWH), Matte Black (MBK), Pewter (PEW) or Soft Nickel (SNK)
- ④ Optional Top Overlay: see page 352 for upcharge
  - a.) White Back Painted Glass
  - b.) Solid Surface - Armadillo (ARM), Black Pearl (BLP), Pebble Pearl (PEB) or Pure White (PUR)
- ⑤ Optional Power Center (EC24) - add \$464 list
  - a.) Color: Black (B) or White (W)

**②a Laminates Top Options:**

<u>Solid Laminates</u>			
ALB	Alabaster	SHD	Shadow
BBL	Bridal Blanco	SLG	Slate Grey
DWH	Designer White		

Veneer Grain Pattern Laminates

AGA	Aged Ash	CLL	Collectors	STU	Studio Teak
ALL	Ale Light	FLO	Florence Walnut	VIN	Vintage
BLO	Blonde Echo	GRH	Graphite	WLH	Walnut Heights
BOL	Bourbon Light	HGL	High Line	WEA	Weathered Ash
BZW	Brazilwood	OAT	Oatmeal Cookie		
BGL	Brighton Light	PIN	Pinnacle Walnut		

**②b Veneer Top Finish Options:**

<u>Cherry</u>		<u>Maple</u>		<u>Walnut</u>	
BRL	Barley	ALM	Ale Medium	AUB	Auburn
BBN	Bourbon Medium	BUT	Butterscotch	ESP	Espresso
BRG	Brighton Medium	CIN	Cinnamon	MCH	Mocha
CLA	Classic	FLX	Flax	NTO	Night Owl
CLL	Collectors	VEN	Venetian	SIE	Sienna
EAR	Earthy			TOF	Toffee
HRV	Harvest			TRF	Truffle
LGC	Legacy				
PRL	Praline				
SAF	Saffron				

<u>Double Cut</u>			
COF	Coffee	GRH	Graphite
CRM	Cremello	KHK	Khaki
FOS	Fossil	STU	Studio Teak

**Specifications**

- Tops:**
- Optional glass or solid surface tops are 1/2" thick and sit on cylinder via attached non skid glides
  - Glass is back painted white and a tempered satin surface
- Plinths:**
- Plinth base models have tack in button glides.
  - Plinth is always black.
- Legs:**
- Leg models have non adjustable knock in glides.
  - Leg models come with 5 legs for all sizes.
- Power:**
- Power only available on leg models. Cannot be used in conjunction with glass and solid surface tops. (Only with laminate and veneer tops)

Reef Product Information



REEF

Material Offering . . . . .	358	Panel Tables . . . . .	366
Overview . . . . .	360	Wall Dependant Panel Tables. . . . .	369
General Options . . . . .	361	Layered Tables . . . . .	370
Vertical Wire Manager Chart . . . . .	362	Wall Dependant Layered Tables. . . . .	373
Worksurface Power. . . . .	364	Layered Tables w/Bookshelf . . . . .	374
Applied Materials . . . . .	365	Wall Dependant Layered Tables w/B'shelf. . . . .	377
		Layered Tables w/ Full Bookshelf . . . . .	380
		Vertical Wire Manager . . . . .	381
		Worksurface Power. . . . .	382

# Reef Product Information

## Reef Veneer

### Exterior Wood Materials

Exterior surfaces are made from the finest selected veneers to achieve clarity and consistency in the Reef Veneer product line. To attain a pleasing, symmetrical pattern, all cherry, maple and walnut veneers are book-matched.

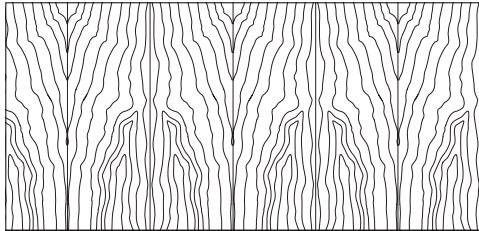

Book-Matched Example

Alternating pieces of veneer are flipped over so they face each other like the pages within a book.

Reef Veneer is available in flat cut cherry, maple and walnut. A wide range of wood stains have been formulated to enhance the beauty of the veneer.

Double Cut veneer is another choice on Reef Veneer product. This veneer is a processed product that has at least two cuttings to create the final veneers. These cuts of veneer strands are dyed and layered into a block to create variation of patterns from a very tight grain pattern to an exotic figure grain pattern.

The diagram below shows the tight pattern used on Reef Double Cut Veneer.

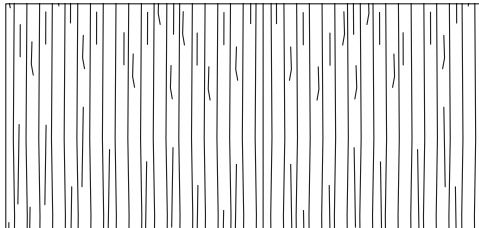

### Worksurface Construction

Worksurfaces are 1 3/16" thick and are manufactured with 3-ply balanced construction. Surfaces are available in wood veneer or high pressure laminate. No additional charge for HPL worksurface when using the JSI standard coordinating HPL match to a standard wood finish. Veneer tops feature 3mm thick matching veneer edgebands. HPL tops are constructed with internal solid hardwood lumber edgebands.

### Case Construction

Reef Veneer end panels are produced using a 1 3/16" thick substrate with veneer surfaces and matching veneer bands on exposed edges. Stretcher panels are 1 3/16" thick for layered tables and 3/4" thick on panel tables. Stretcher panels feature heavy duty metal brackets that bolt to metal insert nuts in end panels. Reef 36", 42" and 48" deep tables feature dual stretcher panels that are sized to provide proper support for worksurfaces. Reef 20" deep wall dependent tables incorporate rear stretcher and metal support rails for worksurface support. Worksurfaces are joined to end assemblies and stretcher panels by metal brackets and wood screws. Upper shelves on layered tables are 1 3/16" thick and attach with Modeez connectors and metal brackets with wood screws. Bookcase sections are constructed from 3/4" thick veneer panels with matching veneer edgebanding. Narrow bookcase and full bookcase joinery includes wood cleats, wood screws and metal fasteners. All tables have adjustable leveling glides. Reef tables require field assembly.

### JSI Quickship Program

Laminates available on the **NOW!** quickship program include the following: Aged Ash (AGA), Ale Light(ALL), Bourbon Light (BOL), Brighton Light (BGL), Collectors (CLL), Designer White (DWH), Florence Walnut (FLO), Graphite (GRH), Pinnacle Walnut (PIN), Slate Grey (SLG), Studio Teak (STU), Vintage (VIN) and Walnut Heights (WLH).

Reef Veneer species available on the quickship program include Cherry, Maple, Walnut and the following Double Cut veneers: Graphite (GRH), Khaki (KHK) and Studio Teak (STU).

### Foot Rails

Optional metal foot rails are constructed with 14-gauge 1 3/4" square tubing with powder coated finish. Rails attach to end panels using 1/4-20 machine screws into metal inserts in end panels. Foot rails not available on quickship.

### Finish - Stain/Colors

We offer a variety of wood stains and paint colors on Reef. Please see the chart below. Samples are available upon request. Finishes with asterisk (\*) have coordinating laminate tops.

<b>CH1 Cherry</b> <i>Flat Cut Veneer</i>	
BRL Barley	EAR Earthy
BBM Bourbon Medium	HRV Harvest*
BRM Brighton Medium	LGC Legacy
CLA Classic	PRL Praline*
CLL Collectors*	SAF Saffron
<b>MA1 Maple</b> <i>Flat Cut Veneer</i>	
ALM Ale Medium	FLX Flax
BUT Butterscotch	VEN Venetian
CIN Cinnamon	
<b>WA1 Walnut</b> <i>Flat Cut Veneer</i>	
AUB Auburn	SIE Sienna*
ESP Espresso	TOF Toffee
MCH Mocha*	TRF Truffle*
NTO Night Owl*	

### DC1 Double Cut Veneer

COF Coffee	GRH Graphite
CRM Cremello	KHK Khaki
FOS Fossil	STU Studio Teak

### PNT Paint

BKD Backdrop	GRV Greek Villa
BFX Black Fox	NET Network Gray
BWH Bright White	NWH Nonchalant White
CGP Cargo Pants	STM Storm
CHT Chatroom	TRC Tricorn Black
FRR French Roast	

### Protective Top Coat

DuraTex™ offers exceptional hardness along with abrasion and impact resistance, it has been formulated to eliminate hazardous and harmful gases that are normally associated with wood finish.

### DuraTex™ Features

Safety - Significantly reduces hazardous formaldehyde emissions which help improve the quality of the indoor air we breathe. Quality - Developed to be tough and durable with special attention to appearance. The DuraTex™ finish preserves the natural beauty of wood. Durability - Designed to meet a wide range of demanding performance and environmental standards to withstand even the highest wear and tear.

## Reef Product Information

### Custom/Special Finishes

JSI, upon request, will accommodate special finishes. A written request is required to proceed with custom finish orders. A sample reference is required for first time matches and must be included with the written request.

There is a one time charge of \$332 list per order for any non-standard wood finish.

Orders will be entered noting the special finish. A sample match will be provided to the customer. Written approval is needed before the finish process can be started. Delays in approval may have an impact on lead times.

Every effort will be made to create the requested match; however, an acceptable match may not be possible because of natural variations of wood. These natural variations can also cause minor differences in the final finish product.

### Species Change

For species changes contact customer service for a quote.

### Laminate Tops

Work surface only, no additional upcharge if Reef's coordinating wood grain laminate is specified. Contact Customer Service for any other laminate request. Listed below are finishes that have coordinating wood grain HPL laminates.

#### Cherry Finishes

Collectors  
Harvest  
Praline

#### Walnut Finishes

Mocha  
Night Owl  
Sienna  
Truffle

### Reef Laminate

Reef Laminate features TFL (thermally fused laminate) chassis components. Worksurfaces are available in HPL (high pressure laminate).

#### TFL - HPL Wood Grain Pattern Laminates

AGA Aged Ash	GRH Graphite
ALL Ale Light	HGL High Line
BLO Blonde Echo	OAT Oatmeal Cookie
BOL Bourbon Light	PIN Pinnacle Walnut
BZW Brazilwood	STU Studio Teak
BGL Brighton Light	VIN Vintage
CLL Collectors	WLH Walnut Heights
FLO Florence Walnut	WEA Weathered Ash

#### TFL - HPL Solid Laminates

ALB Alabaster	SHD Shadow
BBL Bridal Blanco	SLG Slate Grey
DWH Designer White	

Edges of the worksurface are banded with impact resistant (PVC) on HPL tops. The laminate is offered in 16 wood grain patterns and 5 solid colors. Wood grain laminates feature an embossed grain that adds texture and helps to hide finger prints and light scratches. The solid color laminates are smooth to the touch with a semi-matte finish. All Reef Laminate products are indoor-air certified by GreenGuard.

The chart below lists the laminates available on the Reef product.

### Worksurfaces

Worksurfaces are manufactured with 3-ply balanced construction. Tops are 1 3/16" thick with coordinating PVC edges. Worksurfaces feature 3mm PVC edges on user sides. Edge detail is flat with eased edge on top and bottom. Worksurface ends are banded with 1mm PVC.

### Case Construction

Reef Laminate end panels are produced using 1 3/16" thick substrate with TFL surfaces and matching PVC bands on exposed edges. Stretcher panels are 1 3/16" thick for layered tables and 3/4" thick on panel tables. Stretcher Panels feature heavy duty metal brackets that bolt to metal insert nuts in end panels. Reef 36", 42" and 48" deep tables feature dual stretcher panels that are sized to provide proper support for worksurfaces. Reef 20" deep wall dependent tables incorporate rear stretcher and metal support rails for work surface support. Worksurfaces are joined to end assemblies and stretcher panels by metal brackets and wood screws. Upper shelves on layered tables are 1 1/8" thick and attach with Modeez connectors and metal brackets. Bookcase sections are constructed from 3/4" thick TFL panels with 1mm edgebanding. Narrow bookcase and full bookcase assembly joinery include wood cleats, wood screws and metal fasteners. All tables have adjustable leveling glides. Reef tables require field assembly.

### Foot Rails

Optional metal foot rails are constructed with 14-gauge 1 3/4" square tubing with powder coated finish. Rails attach to end panels using 1/4-20 machine screws into metal inserts in end panels.



# Reef - Overview

REEF

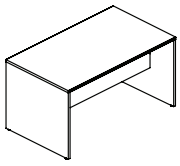

Panel Table

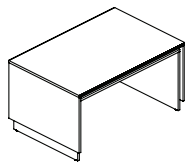

Layered Table

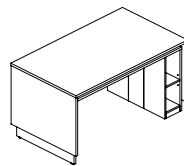

Layered Table with Asymmetric Bookshelf

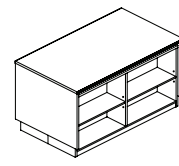

Layered Table with Full Width Bookcases

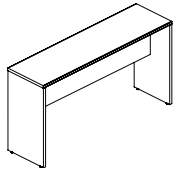

Wall Dependent Panel Table

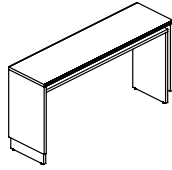

Wall Dependent Layered Table

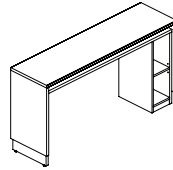

Wall Dependent Layered Table with Asymmetric Bookshelf

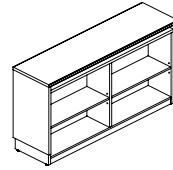

Wall Dependent Layered Table with Full Width Bookcases

## Reef Product Information

### Optional Foot Rail

Optional foot rail in the Arctic Silver, Black Sandtex Pewter, or Soft Nickel powder coat finish is available on the 42" h tables.

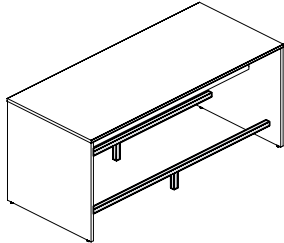

96" wide

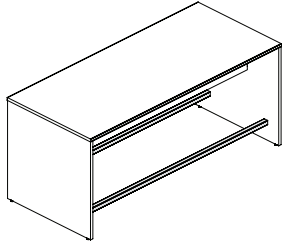

54", 60", 72", & 84" wide

Double Sided Table - Two Rails - add \$903 list

Single Sided Table - One Rail - add \$505 list

### Optional Coat Hook

Optional satin stainless steel coat hook is available on the 42" h and 37" h tables.

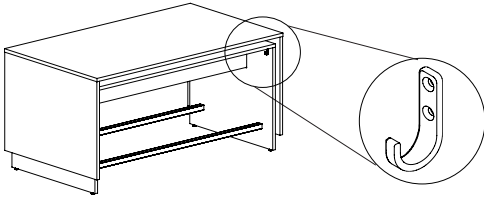

Double Sided Table - Four Hooks - add \$172 list

Single Sided Table - Two Hooks - add \$105 list

### Vertical Wire Manager

Vertical Wire Manager is optional on the 48", 42" and 36" d units, select veneer or laminate.

Bookcases feature integrated vertical wire management with a removable access panel. Vertical wire managers are not available on bookcase sides.

Note: Not available on 20" d units.

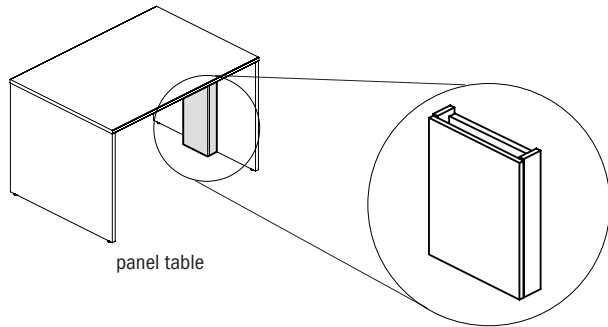

panel table

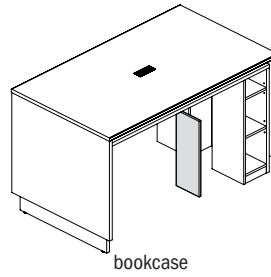

bookcase

## Reef Product Information

Chart below should be used when determining appropriate Vertical Wire Manager for Panel Tables.

REEF

Depth	Table		Vertical Wire Manager	
	Width	Height	Veneer	Laminate
48	96	42	REV1617WMA	RET1617WMA
48	84	42	REV1617WMA	RET1617WMA
48	72	42	REV1617WMA	RET1617WMA
48	60	42	REV1617WMA	RET1617WMA
48	54	42	REV1617WMA	RET1617WMA
42	96	42	REV1017WMA	RET1017WMA
42	84	42	REV1017WMA	RET1017WMA
42	72	42	REV1017WMA	RET1017WMA
42	60	42	REV1017WMA	RET1017WMA
42	54	42	REV1017WMA	RET1017WMA
36	96	42	REV1017WMA	RET1017WMA
36	84	42	REV1017WMA	RET1017WMA
36	72	42	REV1017WMA	RET1017WMA
36	60	42	REV1017WMA	RET1017WMA
36	54	42	REV1017WMA	RET1017WMA
48	96	37	REV1617WMA	RET1617WMA
48	84	37	REV1617WMA	RET1617WMA
48	72	37	REV1617WMA	RET1617WMA
48	60	37	REV1617WMA	RET1617WMA
48	54	37	REV1617WMA	RET1617WMA
42	96	37	REV1017WMA	RET1017WMA
42	84	37	REV1017WMA	RET1017WMA
42	72	37	REV1017WMA	RET1017WMA
42	60	37	REV1017WMA	RET1017WMA
42	54	37	REV1017WMA	RET1017WMA
36	96	37	REV1017WMA	RET1017WMA
36	84	37	REV1017WMA	RET1017WMA
36	72	37	REV1017WMA	RET1017WMA
36	60	37	REV1017WMA	RET1017WMA
36	54	37	REV1017WMA	RET1017WMA

Depth	Table		Vertical Wire Manager	
	Width	Height	Veneer	Laminate
48	96	30	REV1617WMA	RET1617WMA
48	84	30	REV1617WMA	RET1617WMA
48	72	30	REV1617WMA	RET1617WMA
48	60	30	REV1617WMA	RET1617WMA
48	54	30	REV1617WMA	RET1617WMA
42	96	30	REV1017WMA	RET1017WMA
42	84	30	REV1017WMA	RET1017WMA
42	72	30	REV1017WMA	RET1017WMA
42	60	30	REV1017WMA	RET1017WMA
42	54	30	REV1017WMA	RET1017WMA
36	96	30	REV1017WMA	RET1017WMA
36	84	30	REV1017WMA	RET1017WMA
36	72	30	REV1017WMA	RET1017WMA
36	60	30	REV1017WMA	RET1017WMA
36	54	30	REV1017WMA	RET1017WMA

## Reef Product Information

Chart below should be used when determining appropriate Vertical Wire Manager for Layered Tables and Layered Tables with Asymmetric Bookshelf.

Table			Vertical Wire Manager	
Depth	Width	Height	Veneer	Laminate
48	96	42	REV1626WMA	RET1626WMA
48	84	42	REV1626WMA	RET1626WMA
48	72	42	REV1626WMA	RET1626WMA
48	60	42	REV1626WMA	RET1626WMA
48	54	42	REV1626WMA	RET1626WMA
42	96	42	REV1026WMA	RET1026WMA
42	84	42	REV1026WMA	RET1026WMA
42	72	42	REV1026WMA	RET1026WMA
42	60	42	REV1026WMA	RET1026WMA
42	54	42	REV1026WMA	RET1026WMA
36	96	42	REV1026WMA	RET1026WMA
36	84	42	REV1026WMA	RET1026WMA
36	72	42	REV1026WMA	RET1026WMA
36	60	42	REV1026WMA	RET1026WMA
36	54	42	REV1026WMA	RET1026WMA
48	96	37	REV1626WMA	RET1626WMA
48	84	37	REV1626WMA	RET1626WMA
48	72	37	REV1626WMA	RET1626WMA
48	60	37	REV1626WMA	RET1626WMA
48	54	37	REV1626WMA	RET1626WMA
42	96	37	REV1026WMA	RET1026WMA
42	84	37	REV1026WMA	RET1026WMA
42	72	37	REV1026WMA	RET1026WMA
42	60	37	REV1026WMA	RET1026WMA
42	54	37	REV1026WMA	RET1026WMA
36	96	37	REV1026WMA	RET1026WMA
36	84	37	REV1026WMA	RET1026WMA
36	72	37	REV1026WMA	RET1026WMA
36	60	37	REV1026WMA	RET1026WMA
36	54	37	REV1026WMA	RET1026WMA

Table			Vertical Wire Manager	
Depth	Width	Height	Veneer	Laminate
48	96	30	REV1620WMA	RET1620WMA
48	84	30	REV1620WMA	RET1620WMA
48	72	30	REV1620WMA	RET1620WMA
48	60	30	REV1620WMA	RET1620WMA
48	54	30	REV1620WMA	RET1620WMA
42	96	30	REV1020WMA	RET1020WMA
42	84	30	REV1020WMA	RET1020WMA
42	72	30	REV1020WMA	RET1020WMA
42	60	30	REV1020WMA	RET1020WMA
42	54	30	REV1020WMA	RET1020WMA
36	96	30	REV1020WMA	RET1020WMA
36	84	30	REV1020WMA	RET1020WMA
36	72	30	REV1020WMA	RET1020WMA
36	60	30	REV1020WMA	RET1020WMA
36	54	30	REV1020WMA	RET1020WMA

## Reef Product Information

### Optional Worksurface Power

Optional Worksurface Power (EC26) is available on 48", 42" and 36" deep units. Indicate "to accommodate Worksurface Power" on your purchase order. When this option is specified the worksurface will have one cut out in the center. One EC26 Worksurface Power unit must be ordered separately, see page 382. Length of cord is 10 feet.

Note: Not available on wall dependent tables or tables with full width bookcases.

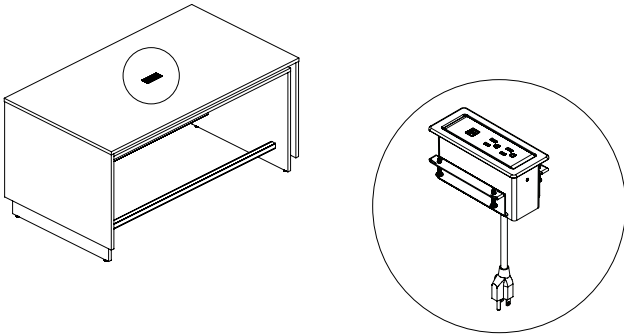

### Under Surface Power

Under Surface Power (EC27) may be ordered for 48", 42", 36" and 20" deep units. The 48", 42" and 36" deep units can accommodate power unit on each side of the table. The 20" deep units can accommodate power units on the non-wall side. The EC27 Under Surface Power Unit(s) must be ordered separately, see page 382. This unit is field installed. Length of cord is 10 feet.

Note: Not available on tables with full width bookcases.

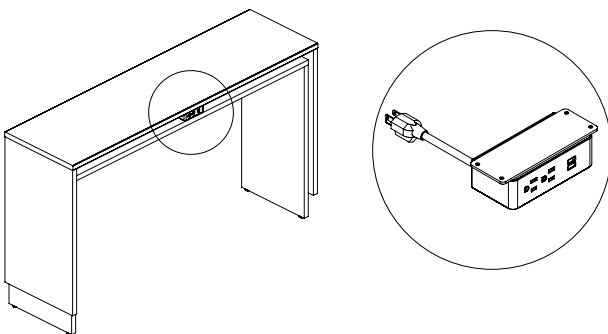

### Edge Mount Power

Edge Mount Power (EC28) may be ordered for 20" deep units. This unit is field installed. Ordering information can be found on page 382. Length of power cord is 6 feet.

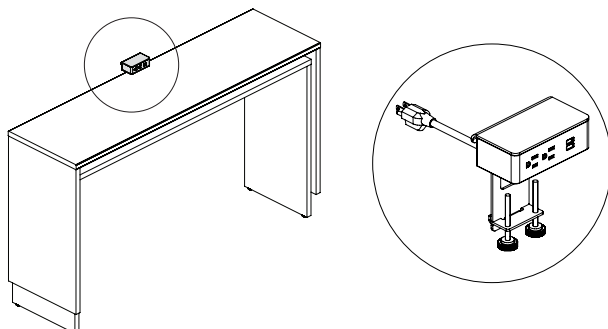

# Reef Product Information

## Material Options

**Note:** Only one veneer can be specified.

### Panel Table

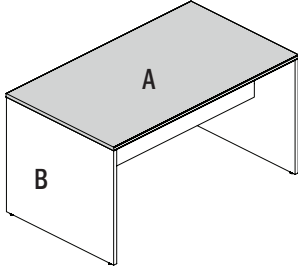

- REV - Veneer**  
**A Worksurface**  
 Veneer  
**B Panels**  
 Veneer  
 Paint

**Note:** Stretcher matches "B"

- RET - Laminate**  
**A Worksurface**  
 Laminate  
**B Panels**  
 Laminate

**Note:** Stretcher matches "B"

### Layered Table

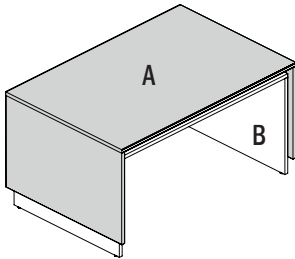

- REV - Veneer**  
**A Worksurface/Outer Panels**  
 Veneer  
**B Inner Panels**  
 Veneer  
 Paint

**Note:** Stretcher matches "B"

- RET - Laminate**  
**A Worksurface/Outer Panels**  
 Laminate  
**B Inner Panels**  
 Laminate

**Note:** Stretcher matches "B"

### Layered Table with Asymmetric Bookshelf

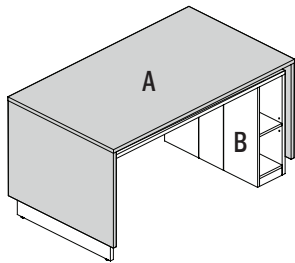

- REV - Veneer**  
**A Worksurface/Outer Panels**  
 Veneer  
**B Bookcase/Inner Panels**  
 Veneer  
 Paint

**Note:** Stretcher matches "B"

- RET - Laminate**  
**A Worksurface/Outer Panels**  
 Laminate  
**B Bookcase/Inner Panels**  
 Laminate

**Note:** Stretcher matches "B"

### Layered Table with Full Width Bookcase

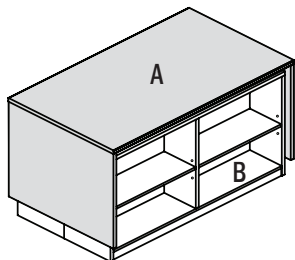

- REV - Veneer**  
**A Worksurface/Outer Panels**  
 Veneer  
**B Bookcase/Inner Panels**  
 Veneer  
 Paint

**Note:** Stretcher matches "B"

- RET - Laminate**  
**A Worksurface/Outer Panels**  
 Laminate  
**B Bookcase/Inner Panels**  
 Laminate

**Note:** Stretcher matches "B"

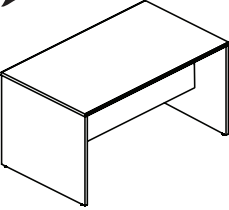
Description	D	W	H	CTN WT	CU FT	① Model	TFL Laminate List Price	HPL Laminate List Price	Veneer Flat Cut and Double Cut List Price
42" h Panel Table  	48	96	42	317	34	RET4896-42PT	\$1,792	\$2,435	
	48	96	42	317	34	REV4896-42PT			\$4,116
	48	84	42	292	31	RET4884-42PT	\$1,690	\$2,298	
	48	84	42	292	31	REV4884-42PT			\$3,882
	48	72	42	267	28	RET4872-42PT	\$1,588	\$2,139	
	48	72	42	267	28	REV4872-42PT			\$3,657
	48	60	42	241	25	RET4860-42PT	\$1,496	\$1,999	
	48	60	42	241	25	REV4860-42PT			\$3,455
	48	54	42	229	24	RET4854-42PT	\$1,457	\$1,935	
	48	54	42	229	24	REV4854-42PT			\$3,364
	42	96	42	288	31	RET4296-42PT	\$1,688	\$2,278	
	42	96	42	288	31	REV4296-42PT			\$3,880
	42	84	42	264	28	RET4284-42PT	\$1,592	\$2,150	
	42	84	42	264	28	REV4284-42PT			\$3,661
	42	72	42	241	26	RET4272-42PT	\$1,496	\$2,002	
	42	72	42	241	26	REV4272-42PT			\$3,448
	42	60	42	218	23	RET4260-42PT	\$1,411	\$1,869	
	42	60	42	218	23	REV4260-42PT			\$3,258
	42	54	42	206	22	RET4254-42PT	\$1,375	\$1,811	
	42	54	42	206	22	REV4254-42PT			\$3,173
	36	96	42	258	28	RET3696-42PT	\$1,555	\$2,098	
	36	96	42	258	28	REV3696-42PT			\$3,572
	36	84	42	237	25	RET3684-42PT	\$1,466	\$1,979	
	36	84	42	237	25	REV3684-42PT			\$3,368
	36	72	42	216	23	RET3672-42PT	\$1,378	\$1,841	
	36	72	42	216	23	REV3672-42PT			\$3,173
	36	60	42	194	20	RET3660-42PT	\$1,300	\$1,720	
	36	60	42	194	20	REV3660-42PT			\$3,000
	36	54	42	184	19	RET3654-42PT	\$1,264	\$1,666	
	36	54	42	184	19	REV3654-42PT			\$2,920

- ships KD
- vertical kneespace clearance 40 3/4"
- EC26 worksurface power available, specify "to accommodate worksurface power" on your purchase order; one EC26 unit must be ordered separately, see page 382
- EC27 undersurface power available, see page 382
- wire manager available, see page 381
- optional foot rail (two rails), specify and add \$903 list; not available on JSI Quickship
- optional coat hooks (four hooks), specify and add \$172 list

Description	D	W	H	CTN WT	CU FT	① Model	TFL Laminate List Price	HPL Laminate List Price	Veneer Flat Cut and Double Cut List Price
37" h Panel Table 	48	96	37	286	32	RET4896-37PT	\$1,668	\$2,288	
	48	96	37	286	32	REV4896-37PT			\$3,874
	48	84	37	263	29	RET4884-37PT	\$1,575	\$2,158	
	48	84	37	263	29	REV4884-37PT			\$3,655
	48	72	37	240	26	RET4872-37PT	\$1,471	\$2,001	
	48	72	37	240	26	REV4872-37PT			\$3,445
	48	60	37	218	23	RET4860-37PT	\$1,381	\$1,859	
	48	60	37	218	23	REV4860-37PT			\$3,256
	48	54	37	206	22	RET4854-37PT	\$1,339	\$1,797	
	48	54	37	206	22	REV4854-37PT			\$3,173
	42	96	37	258	29	RET4296-37PT	\$1,561	\$2,126	
	42	96	37	258	29	REV4296-37PT			\$3,647
	42	84	37	237	26	RET4284-37PT	\$1,471	\$2,005	
	42	84	37	237	26	REV4284-37PT			\$3,441
	42	72	37	216	24	RET4272-37PT	\$1,377	\$1,860	
	42	72	37	216	24	REV4272-37PT			\$3,245
	42	60	37	196	21	RET4260-37PT	\$1,293	\$1,731	
	42	60	37	196	21	REV4260-37PT			\$3,068
	42	54	37	185	20	RET4254-37PT	\$1,256	\$1,675	
	42	54	37	185	20	REV4254-37PT			\$2,992
	36	96	37	229	25	RET3696-37PT	\$1,436	\$1,956	
	36	96	37	229	25	REV3696-37PT			\$3,358
	36	84	37	211	23	RET3684-37PT	\$1,355	\$1,847	
	36	84	37	211	23	REV3684-37PT			\$3,165
	36	72	37	192	21	RET3672-37PT	\$1,268	\$1,713	
	36	72	37	192	21	REV3672-37PT			\$2,986
	36	60	37	173	19	RET3660-37PT	\$1,191	\$1,594	
	36	60	37	173	19	REV3660-37PT			\$2,826
	36	54	37	164	18	RET3654-37PT	\$1,157	\$1,544	
	36	54	37	164	18	REV3654-37PT			\$2,753

- ships KD
- vertical kneespace clearance 35 3/4"
- EC26 worksurface power available, specify "to accommodate worksurface power" on your purchase order; one EC26 unit must be ordered separately, see page 382
- EC27 undersurface power available, see page 382
- wire manager available, see page 381
- optional coat hooks (four hooks), specify and add \$172 list

**To Order, Specify:**

**Veneer**

- ① Model Number
- ② Worksurface Wood Species - Cherry (CH1), Maple (MA1), Walnut (WA1) or Double Cut (DC1) (see page 358)
- ③ Finish Color (see page 358)

- ④ Panels Species & Finish
  - a.) Same as Worksurface
  - b.) Paint (see page 358)
- ⑤ Other Product Options

**Laminate**

- ① Model Number
- ② Worksurface Material (see page 359)
  - a.) TFL
  - b.) HPL
- ③ Worksurface Laminate Color (see page 359)
- ④ Panels Laminate Color
  - a.) Same as Worksurface
  - b.) Other Laminate (see page 359)
- ⑤ Other Product Options

When ordering Quickship products, place a "Q" in front of model number.  
Example: QRET-3672-42PT



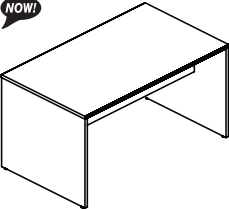

Description	D	W	H	CTN WT	CU FT	① Model	TFL Laminate List Price	HPL Laminate List Price	Veneer Flat Cut and Double Cut List Price
30" h Panel Table  	48	96	30	254	29	RET4896-30PT	\$1,556	\$2,155	
	48	96	30	254	29	REV4896-30PT			\$3,637
	48	84	30	233	26	RET4884-30PT	\$1,467	\$2,032	
	48	84	30	233	26	REV4884-30PT			\$3,430
	48	72	30	211	24	RET4872-30PT	\$1,364	\$1,870	
	48	72	30	211	24	REV4872-30PT			\$3,230
	48	60	30	190	21	RET4860-30PT	\$1,271	\$1,725	
	48	60	30	190	21	REV4860-30PT			\$3,052
	48	54	30	179	20	RET4854-30PT	\$1,231	\$1,662	
	48	54	30	179	20	REV4854-30PT			\$2,970
	42	96	30	229	26	RET4296-30PT	\$1,472	\$2,020	
	42	96	30	229	26	REV4296-30PT			\$3,428
	42	84	30	209	24	RET4284-30PT	\$1,391	\$1,906	
	42	84	30	209	24	REV4284-30PT			\$3,234
	42	72	30	190	21	RET4272-30PT	\$1,292	\$1,756	
	42	72	30	190	21	REV4272-30PT			\$3,044
	42	60	30	171	19	RET4260-30PT	\$1,203	\$1,621	
	42	60	30	171	19	REV4260-30PT			\$2,876
	42	54	30	161	18	RET4254-30PT	\$1,165	\$1,560	
	42	54	30	161	18	REV4254-30PT			\$2,803
	36	96	30	203	23	RET3696-30PT	\$1,356	\$1,860	
	36	96	30	203	23	REV3696-30PT			\$3,156
	36	84	30	186	21	RET3684-30PT	\$1,279	\$1,755	
	36	84	30	186	21	REV3684-30PT			\$2,976
	36	72	30	168	19	RET3672-30PT	\$1,189	\$1,618	
	36	72	30	168	19	REV3672-30PT			\$2,803
	36	60	30	151	17	RET3660-30PT	\$1,109	\$1,493	
	36	60	30	151	17	REV3660-30PT			\$2,647
	36	54	30	142	16	RET3654-30PT	\$1,074	\$1,435	
	36	54	30	142	16	REV3654-30PT			\$2,581

- ships KD
- vertical kneespace clearance 28 3/4"
- EC26 worksurface power available, specify "to accommodate worksurface power" on your purchase order; one EC26 unit must be ordered separately, see page 382
- EC27 undersurface power available, see page 382
- wire manager available, see page 381

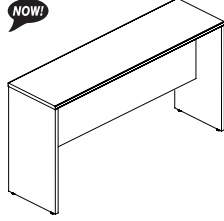
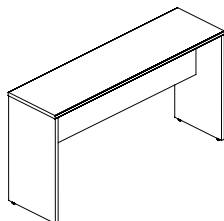
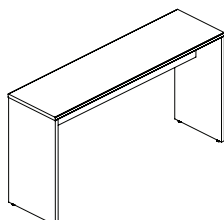
Description	D	W	H	CTN WT	CU FT	① Model	TFL Laminate List Price	HPL Laminate List Price	Veneer Flat Cut and Double Cut List Price	
<b>20" d Wall Dependent Panel Table</b> 	20	84	42	105	14	RET2084-42PT	\$970	\$1,283		
	20	84	42	105	14	REV2084-42PT			\$2,310	
	20	72	42	94	13	RET2072-42PT	\$918	\$1,204		
	20	72	42	94	13	REV2072-42PT			\$2,192	
	20	60	42	83	12	RET2060-42PT	\$873	\$1,136		
	20	60	42	83	12	REV2060-42PT			\$2,071	
	20	54	42	77	11	RET2054-42PT	\$854	\$1,104		
	20	54	42	77	11	REV2054-42PT			\$2,018	
		20	84	37	94	13	RET2084-37PT	\$895	\$1,201	
		20	84	37	94	13	REV2084-37PT			\$2,189
20		72	37	84	12	RET2072-37PT	\$837	\$1,115		
20		72	37	84	12	REV2072-37PT			\$2,063	
20		60	37	74	11	RET2060-37PT	\$788	\$1,038		
20		60	37	74	11	REV2060-37PT			\$1,950	
20		54	37	69	10	RET2054-37PT	\$764	\$1,004		
20		54	37	69	10	REV2054-37PT			\$1,902	
	20	84	30	85	12	RET2084-30PT	\$846	\$1,143		
	20	84	30	85	12	REV2084-30PT			\$2,057	
	20	72	30	76	11	RET2072-30PT	\$785	\$1,053		
	20	72	30	76	11	REV2072-30PT			\$1,936	
	20	60	30	66	10	RET2060-30PT	\$733	\$974		
	20	60	30	66	10	REV2060-30PT			\$1,829	
	20	54	30	62	9	RET2054-30PT	\$712	\$934		
	20	54	30	62	9	REV2054-30PT			\$1,783	

- ships KD
- intended for use against a wall, does not attach to the wall
- exposed hardware on back side
- EC27 undersurface power available, see page 382
- EC28 edge mount power available, see page 382
- optional foot rail available on 42" h table, specify and add \$505 list; not available on JSI Quickship
- optional coat hooks (two hooks) available on 42" h and 37" h tables, specify and add \$105 list
- vertical kneespace clearance for 42" h panel table - 40 3/4"
- vertical kneespace clearance for 37" h panel table - 35 3/4"
- vertical kneespace clearance for 30" h panel table - 28 3/4"

**To Order, Specify:**

**Veneer**

- ① Model Number
- ② Worksurface Wood Species - Cherry (CH1), Maple (MA1), Walnut (WA1) or Double Cut (DC1) (see page 358)
- ③ Finish Color (see page 358)

- ④ Panels Species & Finish
  - a.) Same as Worksurface
  - b.) Paint (see page 358)
- ⑤ Other Product Options

**Laminate**

- ① Model Number
- ② Worksurface Material (see page 359)
  - a.) TFL
  - b.) HPL
- ③ Worksurface Laminate Color (see page 359)
- ④ Panels Laminate Color
  - a.) Same as Worksurface
  - b.) Other Laminate (see page 359)
- ⑤ Other Product Options

When ordering Quickship products, place a "Q" in front of model number.  
 Example: QRET-3672-42PT



Description

42" h Layered Table

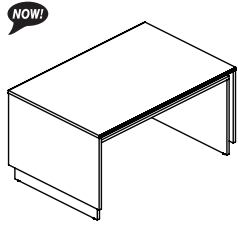

REEF

D	W	H	CTN WT	CU FT	① Model	TFL Laminate List Price	HPL Laminate List Price	Veneer Flat Cut and Double Cut List Price
48	96	42	443	44	RET4896-42LT	\$2,529	\$3,333	
48	96	42	443	44	REV4896-42LT			\$5,638
48	84	42	409	40	RET4884-42LT	\$2,388	\$3,144	
48	84	42	409	40	REV4884-42LT			\$5,319
48	72	42	375	37	RET4872-42LT	\$2,241	\$2,928	
48	72	42	375	37	REV4872-42LT			\$5,009
48	60	42	340	33	RET4860-42LT	\$2,115	\$2,735	
48	60	42	340	33	REV4860-42LT			\$4,732
48	54	42	323	31	RET4854-42LT	\$2,058	\$2,647	
48	54	42	323	31	REV4854-42LT			\$4,607
42	96	42	407	41	RET4296-42LT	\$2,406	\$3,130	
42	96	42	407	41	REV4296-42LT			\$5,382
42	84	42	375	37	RET4284-42LT	\$2,271	\$2,953	
42	84	42	375	37	REV4284-42LT			\$5,078
42	72	42	342	33	RET4272-42LT	\$2,135	\$2,751	
42	72	42	342	33	REV4272-42LT			\$4,783
42	60	42	310	30	RET4260-42LT	\$2,011	\$2,569	
42	60	42	310	30	REV4260-42LT			\$4,519
42	54	42	294	28	RET4254-42LT	\$1,958	\$2,488	
42	54	42	294	28	REV4254-42LT			\$4,403
36	96	42	355	36	RET3696-42LT	\$2,217	\$2,883	
36	96	42	355	36	REV3696-42LT			\$4,954
36	84	42	327	33	RET3684-42LT	\$2,090	\$2,719	
36	84	42	327	33	REV3684-42LT			\$4,672
36	72	42	299	29	RET3672-42LT	\$1,965	\$2,530	
36	72	42	299	29	REV3672-42LT			\$4,403
36	60	42	270	26	RET3660-42LT	\$1,852	\$2,364	
36	60	42	270	26	REV3660-42LT			\$4,160
36	54	42	256	25	RET3654-42LT	\$1,802	\$2,290	
36	54	42	256	25	REV3654-42LT			\$4,050

- ships KD
- vertical kneespace clearance 36 5/8"
- vertical shelf clearance 2 15/16"
- EC26 worksurface power available, specify "to accommodate worksurface power" on your purchase order; one EC26 unit must be ordered separately, see page 382
- EC27 undersurface power available, see page 382
- wire manager available, see page 381
- optional foot rail (two rails), specify and add \$903 list; not available on JSI Quickship
- optional coat hooks (four hooks), specify and add \$172 list

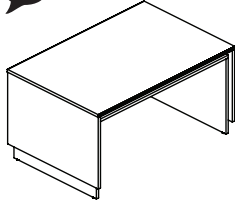
Description	D	W	H	CTN WT	CU FT	① Model	TFL Laminate List Price	HPL Laminate List Price	Veneer Flat Cut and Double Cut List Price
37" h Layered Table	48	96	37	407	41	RET4896-37LT	\$2,363	\$3,133	
	48	96	37	407	41	REV4896-37LT			\$5,331
 	48	84	37	375	38	RET4884-37LT	\$2,957	\$2,957	
	48	84	37	375	38	REV4884-37LT			\$5,029
	48	72	37	343	34	RET4872-37LT	\$2,087	\$2,741	
	48	72	37	343	34	REV4872-37LT			\$4,741
	48	60	37	312	30	RET4860-37LT	\$2,550	\$2,550	
	48	60	37	312	30	REV4860-37LT			\$4,482
	48	54	37	296	29	RET4854-37LT	\$1,898	\$2,464	
	48	54	37	296	29	REV4854-37LT			\$4,367
	42	96	37	372	38	RET4296-37LT	\$2,225	\$2,922	
	42	96	37	372	38	REV4296-37LT			\$5,060
	42	84	37	343	34	RET4284-37LT	\$2,099	\$2,756	
	42	84	37	343	34	REV4284-37LT			\$4,773
	42	72	37	313	31	RET4272-37LT	\$1,963	\$2,557	
	42	72	37	313	31	REV4272-37LT			\$4,501
	42	60	37	283	28	RET4260-37LT	\$1,841	\$2,380	
	42	60	37	283	28	REV4260-37LT			\$4,255
	42	54	37	268	26	RET4254-37LT	\$1,790	\$2,303	
	42	54	37	268	26	REV4254-37LT			\$4,148
	36	96	37	322	33	RET3696-37LT	\$2,046	\$2,689	
	36	96	37	322	33	REV3696-37LT			\$4,657
	36	84	37	297	30	RET3684-37LT	\$1,930	\$2,535	
	36	84	37	297	30	REV3684-37LT			\$4,392
	36	72	37	271	27	RET3672-37LT	\$1,807	\$2,353	
	36	72	37	271	27	REV3672-37LT			\$4,139
	36	60	37	245	24	RET3660-37LT	\$1,697	\$2,191	
	36	60	37	245	24	REV3660-37LT			\$3,919
	36	54	37	233	23	RET3654-37LT	\$1,648	\$2,120	
	36	54	37	233	23	REV3654-37LT			\$3,815

- ships KD
- vertical kneespace clearance 31 5/8"
- vertical shelf clearance 2 1/4"
- EC26 worksurface power available, specify "to accommodate worksurface power" on your purchase order; one EC26 unit must be ordered separately, see page 382
- EC27 undersurface power available, see page 382
- wire manager available, see page 381
- optional coat hooks (four hooks), specify and add \$172 list

**To Order, Specify:**

**Veneer**

- ① Model Number
- ② Worksurface Wood Species - Cherry (CH1), Maple (MA1), Walnut (WA1) or Double Cut (DC1) (see page 358)
- ③ Finish Color (see page 358)

- ④ Panels Species & Finish
  - a.) Same as Worksurface
  - b.) Paint (see page 358)
- ⑤ Other Product Options

**Laminate**

- ① Model Number
- ② Worksurface Material (see page 359)
  - a.) TFL
  - b.) HPL
- ③ Worksurface/Outer Panels Laminate Color (see page 359)
- ④ Inner Panels Laminate Color
  - a.) Same as Worksurface/Outer Panels
  - b.) Other Laminate (see page 359)
- ⑤ Other Product Options

When ordering Quickship products, place a "Q" in front of model number.  
Example: QRET-3672-42PT

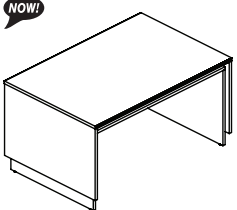

Description	D	W	H	CTN WT	CU FT	① Model	TFL Laminate List Price	HPL Laminate List Price	Veneer Flat Cut and Double Cut List Price
30" h Layered Table	48	96	30	364	38	RET4896-30LT	\$2,218	\$2,959	
	48	96	30	364	38	REV4896-30LT			\$5,044
	48	84	30	334	34	RET4884-30LT	\$2,092	\$2,791	
	48	84	30	334	34	REV4884-30LT			\$4,759
	48	72	30	303	31	RET4872-30LT	\$1,945	\$2,570	
	48	72	30	303	31	REV4872-30LT			\$4,480
	48	60	30	273	27	RET4860-30LT	\$1,811	\$2,371	
	48	60	30	273	27	REV4860-30LT			\$4,231
	48	54	30	258	26	RET4854-30LT	\$1,755	\$2,284	
	48	54	30	258	26	REV4854-30LT			\$4,121
	42	96	30	334	35	RET4296-30LT	\$2,101	\$2,776	
	42	96	30	334	35	REV4296-30LT			\$4,753
	42	84	30	306	31	RET4284-30LT	\$1,982	\$2,620	
	42	84	30	306	31	REV4284-30LT			\$4,483
	42	72	30	277	28	RET4272-30LT	\$1,840	\$2,411	
	42	72	30	277	28	REV4272-30LT			\$4,223
	42	60	30	249	25	RET4260-30LT	\$1,717	\$2,228	
	42	60	30	249	25	REV4260-30LT			\$3,992
	42	54	30	235	23	RET4254-30LT	\$1,663	\$2,145	
	42	54	30	235	23	REV4254-30LT			\$3,887
	36	96	30	288	30	RET3696-30LT	\$1,932	\$2,556	
	36	96	30	288	30	REV3696-30LT			\$4,376
	36	84	30	264	27	RET3684-30LT	\$1,824	\$2,410	
	36	84	30	264	27	REV3684-30LT			\$4,128
	36	72	30	239	25	RET3672-30LT	\$1,695	\$2,223	
	36	72	30	239	25	REV3672-30LT			\$3,887
	36	60	30	215	22	RET3660-30LT	\$1,582	\$2,049	
	36	60	30	215	22	REV3660-30LT			\$3,672
	36	54	30	203	20	RET3654-30LT	\$1,529	\$1,971	
	36	54	30	203	20	REV3654-30LT			\$3,578

- ships KD
- vertical kneespace clearance 24 5/8"
- vertical shelf clearance 2 15/16"
- EC26 worksurface power available, specify "to accommodate worksurface power" on your purchase order; one EC26 unit must be ordered separately, see page 382
- EC27 undersurface power available, see page 382
- wire manager available, see page 381

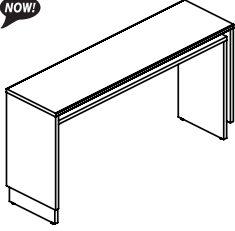
Description	D	W	H	CTN WT	CU FT	① Model	TFL Laminate List Price	HPL Laminate List Price	Veneer Flat Cut and Double Cut List Price
20"d Wall Dependent Layered Table	20	84	42	148	19	RET2084-42LT	\$1,381	\$1,763	
	20	84	42	148	19	REV2084-42LT			\$3,205
	20	72	42	132	17	RET2072-42LT	\$1,309	\$1,657	
	20	72	42	132	17	REV2072-42LT			\$3,038
	20	60	42	116	15	RET2060-42LT	\$1,244	\$1,560	
	20	60	42	116	15	REV2060-42LT			\$2,873
	20	54	42	109	14	RET2054-42LT	\$1,216	\$1,519	
	20	54	42	109	14	REV2054-42LT			\$2,797
	20	84	37	136	17	RET2084-37LT	\$1,276	\$1,653	
	20	84	37	136	17	REV2084-37LT			\$3,035
	20	72	37	121	16	RET2072-37LT	\$1,195	\$1,532	
	20	72	37	121	16	REV2072-37LT			\$2,862
	20	60	37	107	14	RET2060-37LT	\$1,122	\$1,427	
	20	60	37	107	14	REV2060-37LT			\$2,706
	20	54	37	100	13	RET2054-37LT	\$1,090	\$1,381	
	20	54	37	100	13	REV2054-37LT			\$2,637
	20	84	30	125	16	RET2084-30LT	\$1,204	\$1,568	
	20	84	30	125	16	REV2084-30LT			\$2,850
	20	72	30	111	14	RET2072-30LT	\$1,120	\$1,447	
	20	72	30	111	14	REV2072-30LT			\$2,684
	20	60	30	97	13	RET2060-30LT	\$1,045	\$1,336	
	20	60	30	97	13	REV2060-30LT			\$2,535
	20	54	30	86	12	RET2054-30LT	\$1,013	\$1,282	
	20	54	30	86	12	REV2054-30LT			\$2,470

- ships KD
- intended for use against a wall, does not attach to the wall
- exposed hardware on back side
- vertical shelf clearance 2 1/8"
- EC27 undersurface power available, see page 382
- EC28 edge mount power available, see page 382
- optional foot rail available on 42"h table, specify and add \$505 list; not available on JSI Quickship
- optional coat hooks (two hooks) available on 42"h and 37"h tables, specify and add \$105 list
- vertical kneespace clearance for 42"h layered table - 36 5/8"
- vertical kneespace clearance for 37"h layered table - 31 5/8"
- vertical kneespace clearance for 30"h layered table - 24 5/8"

**To Order, Specify:**

**Veneer**

- ① Model Number
- ② Worksurface/Outer Panels Wood Species - Cherry (CH1), Maple (MA1), Walnut (WA1) or Double Cut (DC1) (see page 358)
- ③ Finish Color (see page 358)

- ④ Inner Panels Species & Finish
  - a.) Same as Worksurface/Outer Panels
  - b.) Paint (see page 358)
- ⑤ Other Product Options

**Laminate**

- ① Model Number
- ② Worksurface Material (see page 359)
  - a.) TFL
  - b.) HPL
- ③ Worksurface/Outer Panels Laminate Color (see page 359)
- ④ Inner Panels Laminate Color
  - a.) Same as Worksurface/Outer Panels
  - b.) Other Laminate (see page 359)
- ⑤ Other Product Options

When ordering Quickship products, place a "Q" in front of model number.  
Example: QRET-3672-42PT

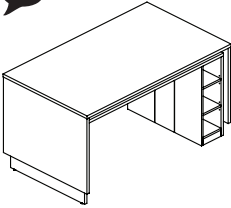

REEF

Description	D	W	H	CTN WT	CU FT	① Model	TFL Laminate List Price	HPL Laminate List Price	Veneer Flat Cut and Double Cut List Price
42" h Layered Table with Asymmetric Bookshelf	48	96	42	579	55	RET4896-42LTNB	\$2,941	\$3,796	
	48	96	42	579	55	REV4896-42LTNB			\$6,468
 	48	84	42	545	51	RET4884-42LTNB	\$2,773	\$3,580	
	48	84	42	545	51	REV4884-42LTNB			\$6,102
	48	72	42	511	47	RET4872-42LTNB	\$2,630	\$3,365	
	48	72	42	511	47	REV4872-42LTNB			\$5,789
	48	60	42	476	43	RET4860-42LTNB	\$2,501	\$3,172	
	48	60	42	476	43	REV4860-42LTNB			\$5,514
	48	54	42	459	42	RET4854-42LTNB	\$2,443	\$3,085	
	48	54	42	459	42	REV4854-42LTNB			\$5,387
	42	96	42	530	50	RET4296-42LTNB	\$2,781	\$3,574	
	42	96	42	530	50	REV4296-42LTNB			\$6,123
	42	84	42	498	46	RET4284-42LTNB	\$2,622	\$3,371	
	42	84	42	498	46	REV4284-42LTNB			\$5,294
	42	72	42	466	43	RET4272-42LTNB	\$2,485	\$3,168	
	42	72	42	466	43	REV4272-42LTNB			\$5,481
	42	60	42	433	39	RET4260-42LTNB	\$2,363	\$2,987	
	42	60	42	433	39	REV4260-42LTNB			\$5,217
	42	54	42	417	38	RET4254-42LTNB	\$2,309	\$2,906	
	42	54	42	417	38	REV4254-42LTNB			\$5,100
	36	96	42	466	44	RET3696-42LTNB	\$2,572	\$3,292	
	36	96	42	466	44	REV3696-42LTNB			\$5,689
	36	84	42	437	41	RET3684-42LTNB	\$2,426	\$3,104	
	36	84	42	437	41	REV3684-42LTNB			\$5,367
	36	72	42	409	38	RET3672-42LTNB	\$2,300	\$2,918	
	36	72	42	409	38	REV3672-42LTNB			\$5,097
	36	60	42	381	34	RET3660-42LTNB	\$2,189	\$2,751	
	36	60	42	381	34	REV3660-42LTNB			\$4,856
	36	54	42	367	33	RET3654-42LTNB	\$2,138	\$2,676	
	36	54	42	367	33	REV3654-42LTNB			\$4,744

- ships KD
- vertical kneespace clearance 36 5/8"
- vertical shelf clearance 2 15/16"
- adjustable shelves
- removable wire access panel on bookcase side
- EC26 worksurface power available, specify "to accommodate worksurface power" on your purchase order; one EC26 unit must be ordered separately, see page 382
- EC27 undersurface power available, see page 382
- wire manager available on non-bookcase side, see page 301
- optional foot rail (two rails), specify and add \$903 list; not available on JSI Quickship
- optional coat hooks (four hooks), specify and add \$172 list

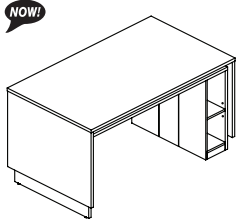
Description	D	W	H	CTN WT	CU FT	① Model	TFL Laminate List Price	HPL Laminate List Price	Veneer Flat Cut and Double Cut List Price
37" h Layered Table with Asymmetric Bookshelf	48	96	37	531	51	RET4896-37LTNB	\$2,765	\$3,532	
	48	96	37	531	51	REV4896-37LTNB			\$6,080
	48	84	37	499	47	RET4884-37LTNB	\$2,607	\$3,331	
	48	84	37	499	47	REV4884-37LTNB			\$5,734
	48	72	37	467	44	RET4872-37LTNB	\$2,472	\$3,163	
	48	72	37	467	44	REV4872-37LTNB			\$5,445
	48	60	37	436	40	RET4860-37LTNB	\$2,352	\$2,983	
	48	60	37	436	40	REV4860-37LTNB			\$5,184
	48	54	37	420	38	RET4854-37LTNB	\$2,298	\$2,902	
	48	54	37	420	38	REV4854-37LTNB			\$5,066
	42	96	37	485	46	RET4296-37LTNB	\$2,614	\$3,325	
	42	96	37	485	46	REV4296-37LTNB			\$5,757
	42	84	37	455	43	RET4284-37LTNB	\$2,465	\$3,135	
	42	84	37	455	43	REV4284-37LTNB			\$5,431
	42	72	37	425	40	RET4272-37LTNB	\$2,336	\$2,979	
	42	72	37	425	40	REV4272-37LTNB			\$5,153
	42	60	37	396	36	RET4260-37LTNB	\$2,222	\$2,808	
	42	60	37	396	36	REV4260-37LTNB			\$4,906
	42	54	37	381	35	RET4254-37LTNB	\$2,171	\$2,733	
	42	54	37	381	35	REV4254-37LTNB			\$4,795
	36	96	37	423	40	RET3696-37LTNB	\$2,366	\$3,029	
	36	96	37	423	40	REV3696-37LTNB			\$5,236
	36	84	37	398	37	RET3684-37LTNB	\$2,232	\$2,857	
	36	84	37	398	37	REV3684-37LTNB			\$4,938
	36	72	37	372	35	RET3672-37LTNB	\$2,118	\$2,685	
	36	72	37	372	35	REV3672-37LTNB			\$4,691
	36	60	37	346	32	RET3660-37LTNB	\$2,014	\$2,530	
	36	60	37	346	32	REV3660-37LTNB			\$4,469
	36	54	37	334	30	RET3654-37LTNB	\$1,967	\$2,463	
	36	54	37	334	30	REV3654-37LTNB			\$4,367

- ships KD
- vertical kneespace clearance 31 5/8"
- vertical shelf clearance 2 15/16"
- adjustable shelf
- removable wire access panel on bookcase side
- EC26 worksurface power available, specify "to accommodate worksurface power" on your purchase order; one EC26 unit must be ordered separately, see page 382
- EC27 undersurface power available, see page 382
- wire manager available on non-bookcase side, see page 381
- optional coat hooks (four hooks), specify and add \$172 list

**To Order, Specify:**

**Veneer**

- ① Model Number
- ② Worksurface/Outer Panels Wood Species - Cherry (CH1), Maple (MA1), Walnut (WA1) or Double Cut (DC1) (see page 358)
- ③ Finish Color (see page 358)

- ④ Bookcase /Inner Panels Species & Finish
  - a.) Same as Worksurface/Outer Panels
  - b.) Paint (see page 358)
- ⑤ Other Product Options

**Laminate**

- ① Model Number
- ② Worksurface Material (see page 359)
  - a.) TFL
  - b.) HPL
- ③ Worksurface/Outer Panels Laminate Color (see page 359)
- ④ Bookcase/Inner Panels Laminate Color
  - a.) Same as Worksurface/Outer Panels
  - b.) Other Laminate (see page 359)
- ⑤ Other Product Options

When ordering Quickship products, place a "Q" in front of model number.  
Example: QRET-3672-42PT



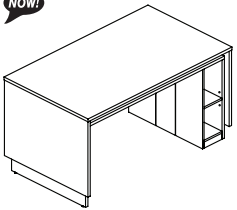

Description	D	W	H	CTN WT	CU FT	① Model	TFL Laminate List Price	HPL Laminate List Price	Veneer Flat Cut and Double Cut List Price
30" h Layered Table with Asymmetric Bookshelf	48	96	30	462	46	RET4896-30LTNB	\$2,599	\$3,321	
	48	96	30	462	46	REV4896-30LTNB			\$5,715
	48	84	30	432	42	RET4884-30LTNB	\$2,452	\$3,132	
	48	84	30	432	42	REV4884-30LTNB			\$5,389
	48	72	30	401	39	RET4872-30LTNB	\$2,325	\$2,973	
	48	72	30	401	39	REV4872-30LTNB			\$5,119
	48	60	30	371	35	RET4860-30LTNB	\$2,212	\$2,804	
	48	60	30	371	35	REV4860-30LTNB			\$4,875
	48	54	30	356	33	RET4854-30LTNB	\$2,160	\$2,727	
	48	54	30	356	33	REV4854-30LTNB			\$4,765
	42	96	30	423	42	RET4296-30LTNB	\$2,459	\$3,125	
	42	96	30	423	42	REV4296-30LTNB			\$5,413
	42	84	30	394	38	RET4284-30LTNB	\$2,318	\$2,948	
	42	84	30	394	38	REV4284-30LTNB			\$5,107
	42	72	30	366	35	RET4272-30LTNB	\$2,196	\$2,800	
	42	72	30	366	35	REV4272-30LTNB			\$4,845
	42	60	30	338	32	RET4260-30LTNB	\$2,089	\$2,641	
	42	60	30	338	32	REV4260-30LTNB			\$4,613
	42	54	30	324	30	RET4254-30LTNB	\$2,041	\$2,569	
	42	54	30	324	30	REV4254-30LTNB			\$4,510
	36	96	30	368	36	RET3696-30LTNB	\$2,177	\$2,789	
	36	96	30	368	36	REV3696-30LTNB			\$4,817
	36	84	30	344	33	RET3684-30LTNB	\$2,052	\$2,631	
	36	84	30	344	33	REV3684-30LTNB			\$4,543
	36	72	30	319	31	RET3672-30LTNB	\$1,949	\$2,472	
	36	72	30	319	31	REV3672-30LTNB			\$4,315
	36	60	30	295	28	RET3660-30LTNB	\$1,854	\$2,330	
	36	60	30	295	28	REV3660-30LTNB			\$4,112
	36	54	30	283	26	RET3654-30LTNB	\$1,810	\$2,267	
	36	54	30	283	26	REV3654-30LTNB			\$4,020

- ships KD
- vertical kneespace clearance 24 5/8"
- vertical shelf clearance 2 15/16"
- adjustable shelf
- removable wire access panel on bookcase side
- EC26 worksurface power available, specify "to accommodate worksurface power" on your purchase order; one EC26 unit must be ordered separately, see page 382
- EC27 undersurface power available, see page 382
- wire manager available on non-bookcase side, see page 381

Description	D	W	H	CTN WT	CU FT	① Model	TFL Laminate List Price	HPL Laminate List Price	Veneer Flat Cut and Double Cut List Price
42" h Wall Dependent Layered Table with Asymmetric Bookshelf	20	84	42	209	23	RET2084-42LTNBR	\$1,714	\$2,166	
	20	84	42	209	23	REV2084-42LTNBR			\$3,737
	20	84	42	209	23	RET2084-42LTNBL	\$1,714	\$2,166	
	20	84	42	209	23	REV2084-42LTNBL			\$3,737
	20	72	42	193	22	RET2072-42LTNBR	\$1,641	\$2,061	
	20	72	42	193	22	REV2072-42LTNBR			\$3,572
	20	72	42	193	22	RET2072-42LTNBL	\$1,641	\$2,061	
	20	72	42	193	22	REV2072-42LTNBL			\$3,572
	20	60	42	177	20	RET2060-42LTNBR	\$1,579	\$1,962	
	20	60	42	177	20	REV2060-42LTNBR			\$3,407
	20	60	42	177	20	RET2060-42LTNBL	\$1,579	\$1,962	
	20	60	42	177	20	REV2060-42LTNBL			\$3,407
	20	54	42	169	19	RET2054-42LTNBR	\$1,549	\$1,921	
	20	54	42	169	19	REV2054-42LTNBR			\$3,331
	20	54	42	169	19	RET2054-42LTNBL	\$1,549	\$1,921	
	20	54	42	169	19	REV2054-42LTNBL			\$3,331

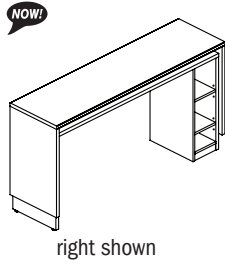

- ships KD
- intended for use against a wall, does not attach to the wall
- exposed hardware on back side
- vertical kneespace clearance 36 5/8"
- vertical shelf clearance 2 15/16"
- adjustable shelves
- EC27 undersurface power available, see page 382
- EC28 edge mount power available, see page 382
- optional foot rail, specify and add \$505 list; not available on JSI Quickship
- optional coat hooks (two hooks), specify and add \$105 list

**To Order, Specify:**

**Veneer**

- ① Model Number
- ② Worksurface/Outer Panels Wood Species - Cherry (CH1), Maple (MA1), Walnut (WA1) or Double Cut (DC1) (see page 358)
- ③ Finish Color (see page 358)

- ④ Bookcase /Inner Panels Species & Finish
  - a.) Same as Worksurface/Outer Panels
  - b.) Paint (see page 358)
- ⑤ Other Product Options

**Laminate**

- ① Model Number
- ② Worksurface Material (see page 359)
  - a.) TFL
  - b.) HPL
- ③ Worksurface/Outer Panels Laminate Color (see page 359)
- ④ Bookcase/Inner Panels Laminate Color
  - a.) Same as Worksurface/Outer Panels
  - b.) Other Laminate (see page 359)
- ⑤ Other Product Options

When ordering Quickship products, place a "Q" in front of model number.  
Example: QRET-3672-42PT



Description	D	W	H	CTN WT	CU FT	① Model	TFL Laminate List Price	HPL Laminate List Price	Veneer Flat Cut and Double Cut List Price
37" h Wall Dependent Layered Table with Asymmetric Bookshelf	20	84	37	191	22	RET2084-37LTNBR	\$1,614	\$2,037	
	20	84	37	191	22	REV2084-37LTNBR			\$3,516
	20	84	37	191	22	RET2084-37LTNBL	\$1,614	\$2,037	
	20	84	37	191	22	REV2084-37LTNBL			\$3,516
	20	72	37	177	20	RET2072-37LTNBR	\$1,529	\$1,918	
	20	72	37	177	20	REV2072-37LTNBR			\$3,343
	20	72	37	177	20	RET2072-37LTNBL	\$1,529	\$1,918	
	20	72	37	177	20	REV2072-37LTNBL			\$3,343
	20	60	37	162	18	RET2060-37LTNBR	\$1,460	\$1,811	
	20	60	37	162	18	REV2060-37LTNBR			\$3,188
	20	60	37	162	18	RET2060-37LTNBL	\$1,460	\$1,811	
	20	60	37	162	18	REV2060-37LTNBL			\$3,188
	20	54	37	155	18	RET2054-37LTNBR	\$1,427	\$1,764	
	20	54	37	155	18	REV2054-37LTNBR			\$3,119
	20	54	37	155	18	RET2054-37LTNBL	\$1,427	\$1,764	
	20	54	37	155	18	REV2054-37LTNBL			\$3,119

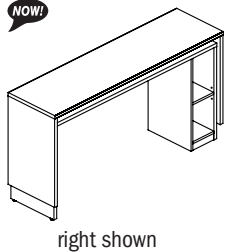

REEF

- ships KD
- intended for use against a wall, does not attach to the wall
- exposed hardware on back side
- vertical kneespace clearance 31 5/8"
- vertical shelf clearance 2 15/16"
- adjustable shelf
- EC27 undersurface power available, see page 382
- EC28 edge mount power available, see page 382
- optional coat hooks (two hooks), specify and add \$105 list

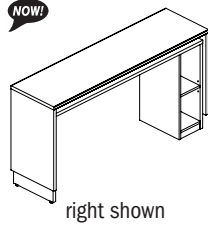
Description	D	W	H	CTN WT	CU FT	① Model	TFL Laminate List Price	HPL Laminate List Price	Veneer Flat Cut and Double Cut List Price
30" h Wall Dependent Layered Table with Asymmetric Bookshelf	20	84	30	169	19	RET2084-30LTNBR	\$1,517	\$1,915	
	20	84	30	169	19	REV2084-30LTNBR			\$3,307
 <p>right shown</p>	20	84	30	169	19	RET2084-30LTNBL	\$1,517	\$1,915	
	20	84	30	169	19	REV2084-30LTNBL			\$3,307
	20	72	30	155	18	RET2072-30LTNBR	\$1,430	\$1,792	
	20	72	30	155	18	REV2072-30LTNBR			\$3,141
	20	72	30	155	18	RET2072-30LTNBL	\$1,430	\$1,792	
	20	72	30	155	18	REV2072-30LTNBL			\$3,141
	20	60	30	141	16	RET2060-30LTNBR	\$1,355	\$1,682	
	20	60	30	141	16	REV2060-30LTNBR			\$2,994
	20	60	30	141	16	RET2060-30LTNBL	\$1,355	\$1,682	
	20	60	30	141	16	REV2060-30LTNBL			\$2,994
	20	54	30	134	15	RET2054-30LTNBR	\$1,322	\$1,628	
	20	54	30	134	15	REV2054-30LTNBR			\$2,927
	20	54	30	134	15	RET2054-30LTNBL	\$1,322	\$1,628	
	20	54	30	134	15	REV2054-30LTNBL			\$2,927

- ships KD
- intended for use against a wall, does not attach to the wall
- exposed hardware on back side
- vertical kneespace clearance 24 5/8"
- vertical shelf clearance 2 15/16"
- adjustable shelf
- EC27 undersurface power available, see page 382
- EC28 edge mount power available, see page 382

**To Order, Specify:**

**Veneer**

- ① Model Number
- ② Worksurface/Outer Panels Wood Species - Cherry (CH1), Maple (MA1), Walnut (WA1) or Double Cut (DC1) (see page 358)
- ③ Finish Color (see page 358)

- ④ Bookcase /Inner Panels Species & Finish
  - a.) Same as Worksurface/Outer Panels
  - b.) Paint (see page 358)
- ⑤ Other Product Options

**Laminate**

- ① Model Number
- ② Worksurface Material (see page 359)
  - a.) TFL
  - b.) HPL
- ③ Worksurface/Outer Panels Laminate Color (see page 359)
- ④ Bookcase/Inner Panels Laminate Color
  - a.) Same as Worksurface/Outer Panels
  - b.) Other Laminate (see page 359)
- ⑤ Other Product Options

When ordering Quickship products, place a "Q" in front of model number.  
Example: QRET-3672-42PT

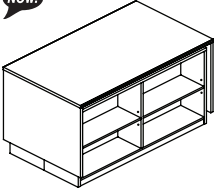
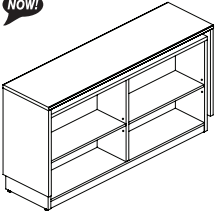

Description	D	W	H	CTN WT	CU FT	① Model	TFL Laminate List Price	HPL Laminate List Price	Veneer Flat Cut and Double Cut List Price
<b>37" h Layered Table with Full Width Bookcases</b> 	48	72	37	485	86	RET4872-37LTFB	\$2,647	\$3,424	
	48	72	37	485	86	REV4872-37LTFB			\$6,195
	42	72	37	450	76	RET4272-37LTFB	\$2,489	\$3,219	
	42	72	37	450	76	REV4272-37LTFB			\$5,822
<ul style="list-style-type: none"> <li>· ships KD</li> <li>· adjustable shelves</li> <li>· vertical shelf clearance 2 15/16"</li> </ul>									
<b>37" h Wall Dependent Layered Table with Full Width Bookcases</b> 	20	72	37	232	38	RET2072-37LTFB	\$1,525	\$1,943	
	20	72	37	232	38	REV2072-37LTFB			\$3,553
<ul style="list-style-type: none"> <li>· ships KD</li> <li>· intended for use against a wall, does not attach to the wall</li> <li>· exposed hardware on back side</li> <li>· adjustable shelves</li> <li>· vertical shelf clearance 2 15/16"</li> </ul>									

**To Order, Specify:**

**Veneer**

- ① Model Number
- ② Worksurface/Outer Panels Wood Species - Cherry (CH1), Maple (MA1), Walnut (WA1) or Double Cut (DC1) (see page 358)
- ③ Finish Color (see page 358)

- ④ Bookcase/Inner Panels Species & Finish
  - a.) Same as Worksurface/Outer Panels
  - b.) Paint (see page 358)
- ⑤ Other Product Options

**Laminate**

- ① Model Number
- ② Worksurface Laminate Color (see page 359)
- ③ Worksurface/Outer Panels Laminate Color (see page 359)
- ④ Bookcase/Inner Panels Laminate Color
  - a.) Same as Worksurface/Outer Panels
  - b.) Other Laminate (see page 359)
- ⑤ Other Product Options

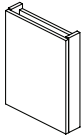
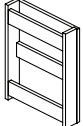
Description	D	W	H	CTN WT	CU FT	① Model	Laminate List Price	Veneer Flat Cut and Double Cut List Price
Vertical Wire Manager	3 3/4	16	26 1/2	18	2	RET1626WMA	\$347	
 	3 3/4	16	26 1/2	18	2	REV1626WMA		\$792
	3 3/4	10	26 1/2	15	2	RET1026WMA	\$333	
	3 3/4	10	26 1/2	15	2	REV1026WMA		\$765
	3 3/4	16	20 1/2	15	2	RET1620WMA	\$297	
	3 3/4	16	20 1/2	15	2	REV1620WMA		\$679
	3 3/4	10	20 1/2	12	1	RET1020WMA	\$283	
	3 3/4	10	20 1/2	12	1	REV1020WMA		\$657
	3 3/4	16	17 1/2	13	2	RET1617WMA	\$275	
	3 3/4	16	17 1/2	13	2	REV1617WMA		\$644
	3 3/4	10	17 1/2	11	1	RET1017WMA	\$265	
	3 3/4	10	17 1/2	11	1	REV1017WMA		\$629

- attaches to non-bookcase end panels
- sold as individual unit (not in pairs)
- see page 359 to determine appropriate vertical wire manager

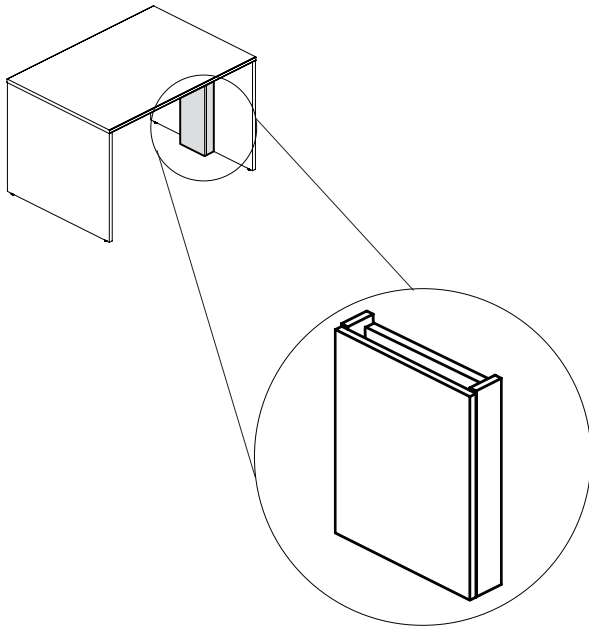

**To Order, Specify:**

**Veneer**

- ① Model Number
- ② Wood Species - Cherry (CH1), Maple (MA1), Walnut (WA1), Double Cut (DC1) or Paint (PNT) (see page 358)
- ③ Finish Color (see page 358)

**Laminate**

- ① Model Number
- ② Laminate Color (see page 359)

When ordering Quickship products, place a "Q" in front of model number.  
Example: QRET-3672-42PT



Description	D	W	H	CTN WT	CU FT	① Model	List Price
Worksurface Power	2 5/8	6 3/8	3	3	1	EC26	\$606

**NOW!**

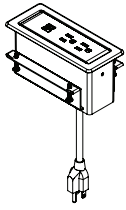

- two power receptacles - 120 volt; 15 amp dual powered USB
- 120" power cord with molded plug
- White (W) or Black (B) finish available, specify when ordering
- UL recognized
- meets UL spill requirements

Under Surface Power	3	6 1/2	1 13/16	2	1	EC27	\$577
---------------------	---	-------	---------	---	---	------	-------

**NOW!**

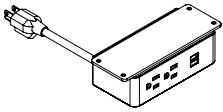

- two power receptacles - 120 volt; 15 amp dual powered USB
- 120" power cord with molded plug
- White (W) or Black (B) finish available, specify when ordering
- UL recognized

Edge Mount Power	3 1/2	5 1/2	7 1/2	3	1	EC28	\$577
------------------	-------	-------	-------	---	---	------	-------

**NOW!**

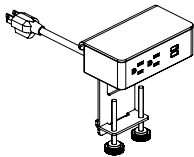

- two power receptacles - 120 volt; 15 amp dual powered USB
- 72" power cord with molded plug
- White (W) or Black (B) finish available, specify when ordering
- UL recognized

**To Order, Specify:**

① Model Number

When ordering Quickship products, place a "Q" in front of model number.

Example: QRET-3672-42PT

**NOW!**  
*Need it.*  
JSI Quickship

## Romy Tables Order Check List: For Tops



**Specify:**

**Top**

1. Model Number

2. Top Material

**A. Veneer (W)**

1. Wood Species - Cherry (CH1), Maple (MA1), Oak (OK1) or Walnut (WA1)

2. Wood Finish

**B. Laminate (L)**

1. Laminate Color

**Example:**

**Top**

RM54SQCL | L | DWH  
(model #) | (top material) | (laminate color)

**Top Wood Species/Finish:**

**Cherry (CH1)**

BRL Barley	EAR Earthy
BBM Bourbon Medium	HRV Harvest
BRM Brighton Medium	LGC Legacy
CLA Classic	PRL Praline
CLL Collectors	SAF Saffron

**Maple (MA1)**

ALM Ale Medium	FLX Flax
BUT Butterscotch	VEN Venetian
CIN Cinnamon	

**Oak (OK1)**

BRW Brownie	HEN Henna
CAN Canyon	HNY Honey
CIT Citron	NUT Nut Brown
DES Desert	

**Walnut (WA1)**

AUB Auburn	SIE Sienna
ESP Espresso	TOF Toffee
MCH Mocha	TRF Truffle
NTO Night Owl	

**Top Material Selection (continued):**

Laminate

Veneer Grain Pattern Laminates

AGA Aged Ash	CLL Collectors
ALL Ale Light	FLO Florence Walnut
BLO Blonde Echo	GRH Graphite
BOL Bourbon Light	HGL High Line
BZW Brazilwood	OAT Oatmeal Cookie
BGL Brighton Light	PIN Pinnacle Walnut
CLL Collectors	STU Studio Teak
FLO Florence Walnut	VIN Vintage
GRH Graphite	WLH Walnut Heights
HGL High Line	WEA Weathered Ash

Solid Laminates

ALB Alabaster	SHD Shadow
BBL Bridal Blanco	SLG Slate Grey
DWH Designer White	

Laminate Match to Veneer

CLL Collectors	PRL Praline
HRV Harvest	SIE Sienna
MCH Mocha	TRF Truffle
NTO Night Owl	

Solid Surface

ARM Armadillo	PUR Pure White
BLP Black Pearl	PEB Pebble Pearl



## Romy Tables Order Check List: For Base



### Specify:

#### Base

- 1. Model Number
- 2. Wood Finish/Paint Color
- 3. Optional Rubber Cushion Nylon Glides - no upcharge

### Example:

#### Base

RM3535-TBB | FLX  
(model #) | (wood finish)

#### Base Wood Finish:

CAG	Aged Ash Coordinate	CGR	Graphite Coordinate
ALM	Ale Medium	HRV	Harvest
AUB	Auburn	HEN	Henna
BRL	Barley	CHL	High Line Coordinate
CBE	Blonde Echo Coordinate	HNY	Honey
BBM	Bourbon Medium	LGC	Legacy
CBZ	Brazilwood Coordinate	MCH	Mocha
BRM	Brighton Medium	NTO	Night Owl
BRW	Brownie	NUT	Nut Brown
BUT	Butterscotch	COA	Oatmeal Cookie Coordinate
CAN	Canyon	CPI	Pinnacle Walnut Coordinate
CIN	Cinnamon	PRL	Praline
CIT	Citronn	SAF	Saffron
CLA	Classic	SIE	Sienna
CLL	Collectors	CST	Studio Teak Coordinate
DES	Desert	TOF	Toffee
EAR	Earthy	TRF	Truffle
ESP	Espresso	VEN	Venetian
FLX	Flax	CVI	Vintage Coordinate
CFL	Florence Walnut Coordinate	CWH	Walnut Heights Coordinate
CFO	Fossil Coordinate	CWE	Weathered Ash Coordinate

#### Base Paint Color - Add \$38 list per item:

PAB	Alabaster	GRV	Greek Villa
BKD	Backdrop	GLF	Gulf Stream
BFX	Black Fox	HTB	Heartthrob
PBB	Bridal Blanco	NET	Network Gray
BWH	Bright White	NWH	Nonchalant White
CGP	Cargo Pants	PAR	Paradise
CHT	Chatroom	QXP	Quixotic Plum
DSY	Daisy	RBZ	Relic Bronze
DRG	Daring	SNB	Sandbank
PDW	Designer White	PSD	Shadow
DYN	Dynamo	PSG	Slate Grey
ENG	Enigma	STM	Storm
FRR	French Roast	TRC	Tricorn Black
GBY	Georgian Bay		

Description	D	W	H	CTN WT	CU FT	① Model	List Price
Squirle Top	54	54	1 ¼	109	8	RM54SQCL	\$1,097
	48	48	1 ¼	86	7	RM48SQCL	\$1,015

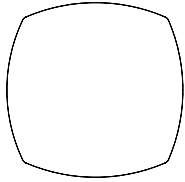

Round Top	54	54	1 ¼	92	8	RM54ROUN	\$1,097
	48	48	1 ¼	73	7	RM48ROUN	\$1,015

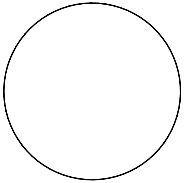

Base	35	35	28 ½	25	5	RM3535-TBB	\$1,211
------	----	----	------	----	---	------------	---------



Base	35	35	28 ½	25	5	RM3535-TBM	\$1,211
------	----	----	------	----	---	------------	---------



**Tops**

**To Order, Specify:**

- ① Model Number
- ② Top Material - Veneer (W) or Laminate (L)
- ③ Wood Species - Cherry (CH1), Maple (MA1), Oak (OK1) or Walnut (WA1)
- ④ Wood Finish/Laminate Color

**Specifications**

- Wood species - Cherry, Maple Oak or Walnut.
- Core material is 1 ½" MDF.
- Face is wood veneer or horizontal grade HPL.
- Backer is bonded to bottom side to ensure balanced construction.
- Bevel MDF edge.

**Bases**

**To Order, Specify:**

- ① Model Number
- ② Wood Finish/Paint Color
- ③ Optional Rubber Cushion Nylon Glides - no upcharge

**Specifications**

- Wood species - Beech or Maple.
- Standard with rubber cushion metal glides.

## Traditional Occasional Tables Order Check List:



**Specify:**

- 1. Model Number
- 2. Wood Species - Cherry (CH1) or Walnut (WA1)
- 3. Wood Finish
- 4. Product Options

**Example:**

ST8028 | CH1 | AUT |  
 (model #) | (wood species) | (finish) |

**1. Model Number**

---

**2. Wood Species - Cherry (CH1) or Walnut (WA1)**

---

**3. Wood Finish Options:**

Cherry		Walnut	
BRL	Barley	AUB	Auburn
BBM	Bourbon Medium	ESP	Espresso
BRM	Brighton Medium	MCH	Mocha*
CLL	Collectors*	NTO	Night Owl*
CLA	Classic	SIE	Sienna*
EAR	Earthy	TOF	Toffee
HRV	Harvest*	TRF	Truffle*
LGC	Legacy		
PRL	Praline*		
SAF	Saffron		

**4. Product Options:**

- Optional Coordinating Wood Grain Laminate Table Top: No upcharge. Finishes with an asterisk (\*) have a coordinating laminate available.

**NOTE:** Any specials or modifications must be accompanied by quote and approved drawing.

Description	D	W	H	CTN WT	CU FT	① Model	List Price
Rectangular Coffee Table	20	48	16	65	12	COFTQS8048	\$1,745



· compliment Walden and Wellington series

Square End Table	28	28	23	35	13	STQS8028	\$1,486
------------------	----	----	----	----	----	----------	---------

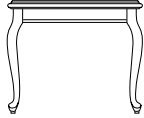

· compliment Walden and Wellington series

Rectangular End Table	18	28	23	25	9	ETQS8028	\$1,354
-----------------------	----	----	----	----	---	----------	---------

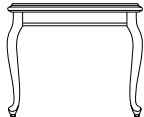

· compliment Walden and Wellington series

Rectangular Coffee Table	20	48	16	65	12	COFT8048	\$1,594
--------------------------	----	----	----	----	----	----------	---------

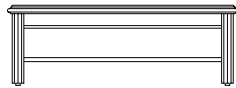

shown with  
optional shelf

· compliment Walden and Wellington series  
· optional shelf available, specify and add \$261 list

Square End Table	28	28	23	35	13	ST8028	\$1,356
------------------	----	----	----	----	----	--------	---------

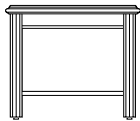

shown with  
optional shelf

· compliment Walden and Wellington series  
· optional shelf available, specify and add \$241 list

Rectangular End Table	18	28	23	25	9	ET8028	\$1,272
-----------------------	----	----	----	----	---	--------	---------

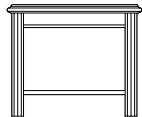

shown with  
optional shelf

· compliment Walden and Wellington series  
· optional shelf available, specify and add \$195 list

**To Order, Specify:**

- ① Model Number
- ② Wood Species - Cherry (CH1) or Walnut (WA1)
- ③ Wood Finish
- ④ Product Options

**③ Wood Finish Options:**

Cherry		Walnut	
BRL	Barley	AUB	Auburn
BBM	Bourbon Medium	ESP	Espresso
BRM	Brighton Medium	MCH	Mocha*
CLA	Classic	NTO	Night Owl*
CLL	Collectors*	SIE	Sienna*
EAR	Earthy	TOF	Toffee
HRV	Harvest*	TRF	Truffle*
LGC	Legacy		
PRL	Praline*		
SAF	Saffron		

**Specifications**

- Wood species - Cherry or Walnut.
- Top is 1 1/4" thick.
- Veneer is reverse slip-matched.
- Shipped KD.

When ordering Quickship products, place a "Q" in front of model number.  
Example: QV3072DD



# Trail Occasional Tables Order Check List:



**Specify:**

- 1. Model Number
- 2. Top Material
  - a.) Laminate
    - 1.) Laminate Color - See list below
  - a.) Veneer
    - 1.) Wood Species - Cherry (CH1), Maple (MA1), Walnut (WA1) or Double Cut (DC1)
    - 2.) Wood Finish - See list below
  - c.) Solid Surface
    - 1.) Solid Surface Color - Armadillo (ARM), Black Pearl (BLP), Pebble Pearl (PEB) or Pure White (PUR)
- 3. Metal Frame Color - Arctic Silver (ASL), Bright White (BWH), Matte Black (MBK), Pewter (PEW), or Soft Nickel (SNK)

**Example:**

<b>TNV18-18RD</b> (model #)	<b>WA1</b> (veneer species)	<b>MCH</b> (wood finish)	<b>BWH</b> (metal frame)
--------------------------------	--------------------------------	-----------------------------	-----------------------------

**1. Model Number**

**2. Top Material Selection:**

**Laminate**

Solid Laminates

ALB Alabaster	SHD Shadow
BBL Bridal Blanco	SLG Slate Grey
DWH Designer White	

Veneer Grain Pattern Laminates

AGA Aged Ash	GRH Graphite
ALL Ale Light	HGL High Line
BLO Blonde Echo	OAT Oatmeal Cookie
BOL Bourbon Light	PIN Pinnacle Walnut
BZW Brazilwood	STU Studio Teak
BGL Brighton Light	VIN Vintage
CLL Collectors	WLH Walnut Heights
FLO Florence Walnut	WEA Weathered Ash

**Top Material Selection (continued):**

Veneer

**Flat Cut**

<b>Cherry (CH1)</b>	<b>Maple (MA1)</b>	<b>Walnut (WA1)</b>
BRL Barley	ALM Ale Medium	AUB Auburn
BBM Bourbon Medium	BUT Butterscotch	ESP Espresso
BRM Brighton Medium	CIN Cinnamon	MCH Mocha*
CLA Classic	FLX Flax	NTO Night Owl*
CLL Collectors*	VEN Venetian	SIE Sienna*
EAR Earthy		TOF Toffee
HRV Harvest*		TRF Truffle*
LGC Legacy		
PRL Praline*		
SAF Saffron		

**Double Cut (DC1)**

COF Coffee
CRM Cremello
FOS Fossil
GRH Graphite
KHK Khaki
STU Studio Teak

Solid Surface

ARM Armadillo
BLP Black Pearl
PEB Pebble Pearl
PUR Pure White

**3. Metal Frame Color:**

ASL Arctic Silver
BWH Bright White
MBK Matte Black
PEW Pewter
SNK Soft Nickel

## Trail Product Information

### Product Overview

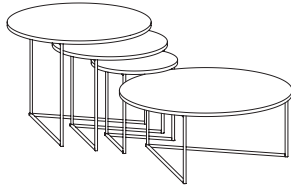

Round Nesting Occasional Tables

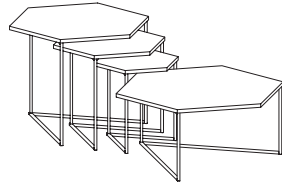

Hexagon Nesting Occasional Tables

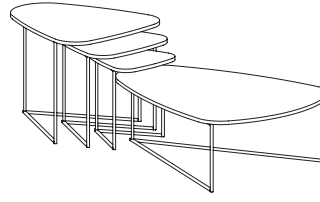

Guitar Pick Nesting Occasional Tables

### Table Heights

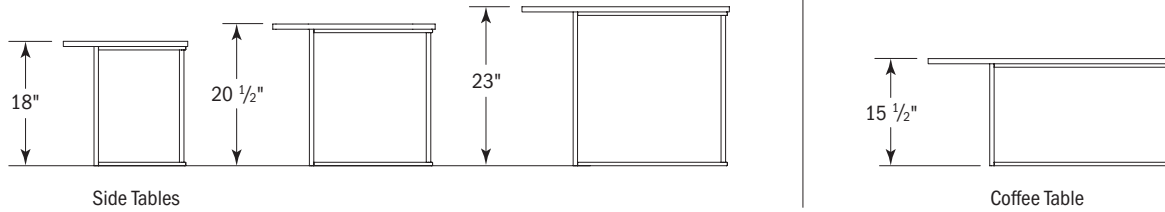

Side Tables

Coffee Table

### Table Shapes

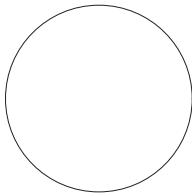

#### round

sizes available:  
 18" dia. - side table  
 24" dia. - side table  
 30" dia. - side table  
 36" dia. - coffee table

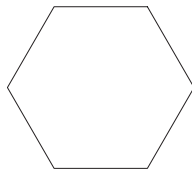

#### hexagon

sizes available:  
 15 5/8" x 18" - side table  
 20 3/4" x 24" - side table  
 26" x 30" - side table  
 31 1/4" x 36" - coffee table

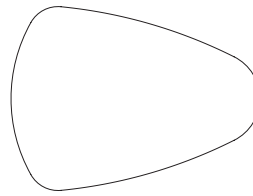

#### guitar pick

sizes available:  
 16 1/4" x 18" - side table  
 21 1/8" x 23 3/8" - side table  
 27 1/2" x 30 1/2" - side table  
 35 1/2" x 48" - coffee table

### Metal Frame Construction



#### Top Options

Veneer: 3/4" thick with .5mm veneer edge  
 Laminate: 3/4" thick with 1mm PVC edge  
 Solid Surface: 1/2" thick with 1/16" radius

#### Frame

Frame constructed of 1/2" square, 16 gage fabricated steel tube. It is powdercoated with your choice of the following colors: Arctic Silver, Bright White, Matte Black, Pewter or Soft Nickel. Additional JSI powdercoat program colors available, upon request, Contact Customer Service for specific quote.

Description	D	W	H	CTN WT	CU FT	① Model	Laminate	Flat Cut Veneer	Double Cut Veneer	Solid Surface	
	30	30	23	24	15	TNT30-23RD	\$1,357				
	30	30	23	24	15	TNV30-23RD		\$1,357	\$1,426		
	30	30	23	24	15	TNS30-23RD				\$1,973	
	24	24	20½	17	9	TNT24-21RD	\$1,301				
	24	24	20½	17	9	TNV24-21RD		\$1,301	\$1,367		
	24	24	20½	17	9	TNS24-21RD				\$1,688	
	18	18	18	12	5	TNT18-18RD	\$1,254				
	18	18	18	12	5	TNV18-18RD		\$1,254	\$1,317		
	18	18	18	12	5	TNS18-18RD				\$1,460	
	· ships assembled										

Description	D	W	H	CTN WT	CU FT	① Model	Laminate	Flat Cut Veneer	Double Cut Veneer	Solid Surface	
	26	30	23	24	15	TNT2630-23HX	\$1,332				
	26	30	23	24	15	TNV2630-23HX		\$1,332	\$1,398		
	26	30	23	24	15	TNS2630-23HX				\$1,826	
	20¾	24	20½	17	9	TNT2124-21HX	\$1,282				
	20¾	24	20½	17	9	TNV2124-21HX		\$1,282	\$1,347		
	20¾	24	20½	17	9	TNS2124-21HX				\$1,585	
	15⅝	18	18	12	5	TNT1618-18HX	\$1,242				
	15⅝	18	18	12	5	TNV1618-18HX		\$1,242	\$1,304		
	15⅝	18	18	12	5	TNS1618-18HX				\$1,395	
	· ships assembled										

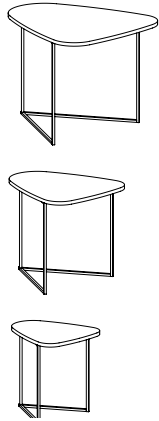
Description	D	W	H	CTN WT	CU FT	① Model	Laminate	Flat Cut Veneer	Double Cut Veneer	Solid Surface
	27 1/2	30 1/2	23	24	15	TNT2831-23PK	\$1,352			
	27 1/2	30 1/2	23	24	15	TNV2831-23PK		\$1,352	\$1,419	
	27 1/2	30 1/2	23	24	15	TNS2831-23PK				\$1,921
	21 1/8	23 3/8	20 1/2	17	9	TNT2124-21PK	\$1,289			
	21 1/8	23 3/8	20 1/2	17	9	TNV2124-21PK		\$1,289	\$1,353	
	21 1/8	23 3/8	20 1/2	17	9	TNS2124-21PK				\$1,630
	16 1/4	18	18	12	5	TNT1618-18PK	\$1,249			
	16 1/4	18	18	12	5	TNV1618-18PK		\$1,249	\$1,312	
	16 1/4	18	18	12	5	TNS1618-18PK				\$1,432

· ships assembled

**To Order, Specify:**

- ① Model Number
- ② Top Material:
  - a.) Laminate
    - 1.) Laminate Color
  - b.) Veneer
    - 1.) Wood Species - Cherry (CH1), Maple (MA1), Walnut (WA1) or Double Cut (DC1)
      - a.) Finish Color
  - c.) Solid Surface - Armadillo (ARM), Black Pearl (BLP), Pebble Pearl (PEB), or Pure White (PUR)
- ③ Metal Frame Color - Arctic Silver (ASL), Bright White (BWH), Matte Black (MBK), Pewter (PEW) or Soft Nickel (SNK)

**②a) Laminate Top Options:**

<u>Solid Laminates</u>			
ALB	Alabaster	SHD	Shadow
BBL	Bridal Bianco	SLG	Slate Grey
DWH	Designer White		
<u>Veneer Grain Pattern Laminates</u>			
AGA	Aged Ash	CLL	Collectors
ALL	Ale Light	FLO	Florence Walnut
BLO	Blonde Echo	GRH	Graphite
BOL	Bourbon Light	HGL	High Line
BZW	Brazilwood	OAT	Oatmeal Cookie
BGL	Brighton Light	PIN	Pinnacle Walnut
STU	Studio Teak	VIN	Vintage
WLH	Walnut Heights	WEA	Weathered Ash

**②b) Veneer Top Finish Options:**

<u>Cherry</u>		<u>Maple</u>		<u>Walnut</u>	
BRL	Barley	ALM	Ale Medium	AUB	Auburn
BBM	Bourbon Medium	BUT	Butterscotch	ESP	Espresso
BRM	Brighton Medium	CIN	Cinnamon	MCH	Mocha
CLA	Classic	FLX	Flax	NTO	Night Owl
CLL	Collectors*	VEN	Venetian	SIE	Sienna
EAR	Earthy			TOF	Toffee
HRV	Harvest*			TRF	Truffle
LGC	Legacy				
PRL	Praline*				
SAF	Saffron				

\*finishes with coordinating laminate tops

<u>Double Cut</u>			
COF	Coffee	GRH	Graphite
CRM	Cremello	KHK	Khaki
FOS	Fossil	STU	Studio Teak

**Specifications**

- Tops:**
- 3/4" thick veneer top with .5mm veneer edge
  - 3/4" thick laminate top with 1mm pvc edge
  - 1/2" solid surface top with 1/16" radius
- Frame:**
- Frame constructed of 1/2" square, 16 gauge fabricated steel tube

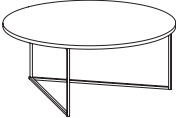

Description	D	W	H	CTN WT	CU FT	① Model	Laminate	Flat Cut Veneer	Double Cut Veneer	Solid Surface
	36	36	15½	31	16	TNT36-16RD	\$1,448			
	36	36	15½	31	16	TNV36-16RD		\$1,448	\$1,521	
	36	36	15½	31	16	TNS36-16RD				\$2,769

· ships assembled

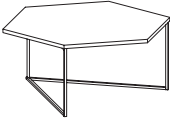
Description	D	W	H	CTN WT	CU FT	① Model	Laminate	Flat Cut Veneer	Double Cut Veneer	Solid Surface
	31¾	36	15½	31	16	TNT3236-16HX	\$1,416			
	31¾	36	15½	31	16	TNV3236-16HX		\$1,416	\$1,488	
	31¾	36	15½	31	16	TNS3236-16HX				\$2,583

· ships assembled

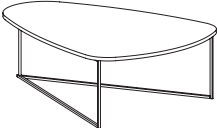
Description	D	W	H	CTN WT	CU FT	① Model	Laminate	Flat Cut Veneer	Double Cut Veneer	Solid Surface
	35½	48	15½	38	21	TNT3648-16PK	\$1,519			
	35½	48	15½	38	21	TNV3648-16PK		\$1,519	\$1,594	
	35½	48	15½	38	21	TNS3648-16PK				\$3,263

· ships assembled

TRAIL

**To Order, Specify:**

- ① Model Number
- ② Top Material:
  - a.) Laminate
    - 1.) Laminate Color
  - b.) Veneer
    - 1.) Wood Species - Cherry (CH1), Maple (MA1), Walnut (WA1) or Double Cut (DC1)
    - a.) Finish Color
  - c.) Solid Surface - Armadillo (ARM), Black Pearl (BLP), Pebble Pearl (PEB), or Pure White (PUR)
- ③ Metal Frame Color - Arctic Silver (ASL), Bright White (BWH), Matte Black (MBK), Pewter (PEW) or Soft Nickel (SNK)

**④ Laminate Top Options:**

Solid Laminates

ALB Alabaster	SHD Shadow
BBL Bridal Blanco	SLG Slate Grey
DWH Designer White	

Veneer Grain Pattern Laminates

AGA Aged Ash	CLL Collectors	STU Studio Teak
ALL Ale Light	FLO Florence Walnut	VIN Vintage
BLO Blonde Echo	GRH Graphite	WLH Walnut Heights
BOL Bourbon Light	HGL High Line	WEA Weathered Ash
BZW Brazilwood	OAT Oatmeal Cookie	
BGL Brighton Light	PIN Pinnacle Walnut	

**④ Veneer Top Finish Options:**

Cherry	Maple	Walnut
BRL Barley	ALM Ale Medium	AUB Auburn
BBM Bourbon Medium	BUT Butterscotch	ESP Espresso
BRM Brighton Medium	CIN Cinnamon	MCH Mocha
CLA Classic	FLX Flax	NTO Night Owl
CLL Collectors*	VEN Venetian	SIE Sienna
EAR Earthy		TOF Toffee
HRV Harvest*		TRF Truffle
LGK Legacy		
PRL Praline*		
SAF Saffron		

\*finishes with coordinating laminate tops

Double Cut

COF Coffee	GRH Graphite
CRM Cremello	KHK Khaki
FOS Fossil	STU Studio Teak

**Specifications**

**Tops:**

- ¾" thick veneer top with .5mm veneer edge
- ¾" thick laminate top with 1mm pvc edge
- ½" solid surface top with 1/16" radius

**Frame:**

- Frame constructed of ½" square, 16 gauge fabricated steel tube

## Accessories, Power and Data



ACCESSORIES

## Accessories - Overview

### Power Accessories

Pages 395-398

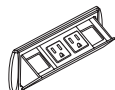

Power and Data Tilt Out



15" Power and Data Unit



Dual Sided Power and Data Unit



Single Sided Power and Data Unit

### Telecom Jacks

Pages 402-405

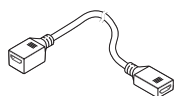

HDMI Connector

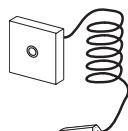

Mini Stereo Jack

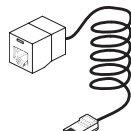

Network Jack

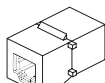

Voice Coupler

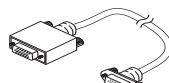

Data Jack

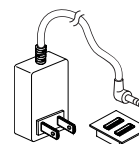

Dual Powered Charging USB

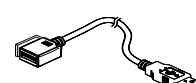

3.0 USB Connector

### Wire Management Accessories

Page 399



Vertical Wire Manager



Wire Management Channel

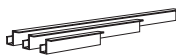

Wire Management Trough



Wire Management Channel



Cable Management Clip



Velcro Straps

### Task Lights

Pages 406-407



48" w Task Light



24" w Task Light



31" w LED Starter Task Light



31" w LED Linking Adder Task Light



17" w LED Starter Task Light



17" w LED Linking Adder Task Light



Motion Sensor for Task Lights

### Keyboard Accessories

Pages 408

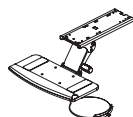

Articulating Keyboard Tray

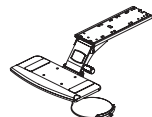

Articulating Keyboard Tray



Articulating Keyboard Tray

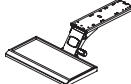

Articulating Keyboard Tray



Keyboard Tray Mouse Pad

### Monitor Support Arm

Page 409



For Use with Desk Bookcases

Description	D	W	H	CTN WT	CU FT	① Model	List Price
Power and Data Tilt Out	3	7		3		EC3	\$372

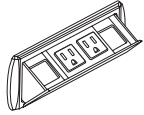

(standard location)

- spring assist tilt up access
- two power receptacles 120 volt, 15amp and two openings for voice/data jacks
- data adapter kit provided to accept jacks from most port manufacturers (see page 400)
- accepts up to two Type 3 Telecom Jacks (see page 405)
- 72" power cord with molded plug
- drop in field installation required
- cut out provided in center of back panel of storage cabinet below tackboard
- UL listed component
- Black or Silver finish

For Use with Desk and Conference Tables

Description	D	W	H	CTN WT	CU FT	① Model	List Price
Mini Power and Data Tilt Up	4 1/4	5 1/2		6	1	EC10	\$428



- fluid one touch tilt up access
- one power receptacle - 120 volt; 15 amp and one opening for voice/data port
- data adapter kit provided to accept jacks from most port manufacturers (see page 401)
- accepts one Type 3 Telecom Jack (see page 405)
- 72" power cord with molded plug
- drop in field installation required
- cut out provided in top at specified location (see page 400)
- UL listed component
- Black or Silver finish

Mini Power Tilt Up	4 1/4	5 1/2		6	1	EC11	\$446
--------------------	-------	-------	--	---	---	------	-------



- fluid one touch tilt up access
- two power receptacles - 120 volt; 15 amp
- 72" power cord with molded plug
- drop in field installation required
- cut out provided in top at specified location (see page 398)
- UL listed component
- Black or Silver finish

Mini Power and USB Tilt Up	4 1/4	5 1/2		6	1	EC12	\$555
----------------------------	-------	-------	--	---	---	------	-------



- fluid one touch tilt up access
- two power receptacles - 120 volt; 15 amp dual powered USB
- 72" power cord with molded plug
- drop in field installation required
- cut out provided in top at specified location (see page 400)
- UL listed component
- Black or Silver finish

To Order, Specify:

- ① Model number
- ② Finish

For Use with Desk Bookcases

Description	D	W	H	CTN WT	CU FT	① Model	List Price
Power and Data Tilt Out	30	9		7	6	EC4	\$4,411

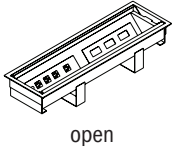
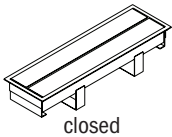

- 30" power and data unit
- retractable doors
- standard in silver pearl powder coat
- brush aluminum doors available; specify and add \$1,753 list
- door design allows cords/cables to exit while doors are in closed position
- seven power receptacles
- one dual powered USB
- accepts up to six (6) Type 1 Telecom Plates; additional plate configurations sold separately, see see pages 402-403
- unit ships standard with six (6) TCP101, three (3) TCP110 Telecom Plates and three (3) data adapter kits
- power inserts are UL or ETL listed
- two 108" power cords with molded plugs
- cannot be positioned over table support base

Description	D	W	H	CTN WT	CU FT	① Model	List Price
15" Power and Data Unit	15	9		4	2	EC5	\$2,821

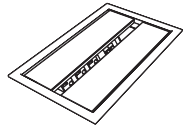

closed

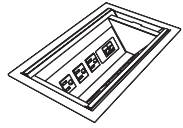

open

- retractable doors
- available in silver pearl powder coat
- brush aluminum doors available; specify and add \$877 list
- door design allows cords/cables to exit while doors are in closed position
- three power receptacles
- one dual powered USB
- accepts up to three (3) Type 1 Telecom Plates; additional plate configurations sold separately, see pages 402-403
- unit ships standard with three (3) TCP101, two (2) TCP110 Telecom Plates and two (2) data adapter kits
- power inserts are UL or ETL listed
- 108" power cord with molded plug

Dual Sided Power and Data Unit	11 1/2	14 3/4		7	2	EC6	\$1,968
--------------------------------	--------	--------	--	---	---	-----	---------

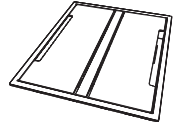

closed

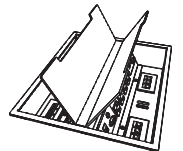

open

- door design allows cords/cables to exit while doors are in closed position
- eight power receptacles, four per side
- accepts up to eight (8) Type 1 Telecom Plates; additional plate configurations sold separately, see pages 402-403
- unit ships standard with four (4) TCP101, four (4) TCP110 Telecom Plates and two (2) data adapter kits
- lids lift to open and contain an access slot to allow cords to exit while in use
- available in silver pearl and black texture powder coat
- units are UL listed and CSA certified
- 108" power cord with molded plug

Single Sided Power and Data Unit	5 3/8	9		4	1	EC7	\$750
----------------------------------	-------	---	--	---	---	-----	-------



- two power receptacles
- accepts one (1) Type 1 Telecom Plates; additional plate configurations sold separately, see pages 402-403
- unit ships standard with one (1) TCP101, one (1) TCP110 Telecom Plate and one (1) data adapter kit
- additionally accepts up to (4) Type 2 Telecom Jacks
- lid lifts to open and contain an access slot to allow cords to exit while in use
- available in silver pearl or black textured powder coat finish
- units are UL listed and CSA certified
- 108" power cord with molded plug
- one under surface power receptacle

**To Order, Specify:**

- ① Model number

When ordering Quickship products, place a "Q" in front of model number.  
Example: QAK1



Description	D	W	H	CTN WT	CU FT	① Model	List Price
<b>Single Sided Power and Data Unit</b>	8 3/8	4		3	1	<b>EC9</b>	<b>\$875</b>

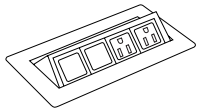

- two power receptacles - 120 volt, 15 amp and two openings for voice/data jacks
- data adapter kit provided to accept jacks from most port manufacturers (see page 400)
- accepts up to two Type 3 Telecom Jacks (see page 405)
- push to open pop up door
- clear anodized aluminum
- 72" power cord with molded plug
- UL listed

<b>Dual Power and Data Tilt Up</b>	8	8 3/8		16	1	<b>EC13</b>	<b>\$1,130</b>
------------------------------------	---	-------	--	----	---	-------------	----------------

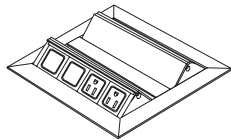

- fluid one touch tilt up access
- back to back tilt sections
- four power receptacles (2 per side) - 120 volt; 15 amp with four openings for voice/data jacks (2 per side)
- data adapter kit provided to accept jacks from most port manufacturers
- accepts up to four Type 3 Telecom Jacks (see page 405)
- two 72" power cord with molded plug
- drop in field installation required
- cut out provided in top at specified location (see page 398)
- UL listed component
- available in Silver (S)

<b>Edge Mount Electrical</b>	3	10		16	1	<b>EC15</b>	<b>\$503</b>
------------------------------	---	----	--	----	---	-------------	--------------

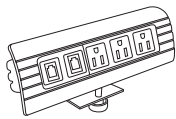

- clamp mounts to the edge of the worksurface - requiring minimum 2" surface overhang
- three power receptacles - 120 volt; 15 amp with two voice/data ports
- data adapter kit provided to accept jacks from most port manufacturers
- accepts up to two Type 3 Telecom Jacks (see page 405)
- 72" power cord with molded plug - exits back of unit
- UL listed component
- clear anodized aluminum

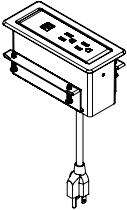
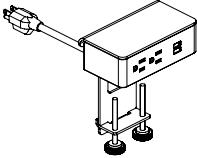
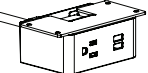
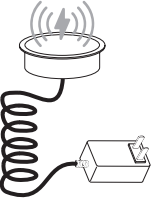
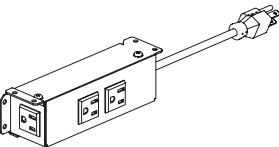
Description	D	W	H	CTN WT	CU FT	1 Model	List Price
<b>Worksurface Power</b>  <ul style="list-style-type: none"> <li>• two power receptacles - 120 volt; 15 amp dual powered USB</li> <li>• 120" power cord with molded plug</li> <li>• White (W) or Black (B) finish available, specify when ordering</li> <li>• UL recognized</li> <li>• meets UL spill requirements</li> </ul>	2 7/8	6 3/8	3	3	1	EC26	\$606
<b>Edge Mount Power</b>  <ul style="list-style-type: none"> <li>• two power receptacles - 120 volt; 15 amp dual powered USB</li> <li>• 72" power cord with molded plug</li> <li>• White (W) or Black (B) finish available, specify when ordering</li> <li>• UL recognized</li> </ul>	3 1/2	5 1/2	7 1/2	3	1	EC28	\$577
<b>Power Center - Under Mount</b>  <ul style="list-style-type: none"> <li>• 10' cord</li> <li>• frame mounted simplex receptacle and two USB/10' - three prong plug power cord</li> <li>• specify black or white - cord color will match unit</li> <li>• optional graphite fabric cord available, specify and add \$196 list</li> <li>• overall mounting bracket tabs: 5"w</li> </ul>	2 3/4	4	2 5/8			EC30	\$471
<b>Wireless Charging Unit</b>  <ul style="list-style-type: none"> <li>• wireless charging for use with Qi enabled devices</li> <li>• 72" power cord</li> <li>• black</li> <li>• UL Listed</li> <li>• CE/FCC certified</li> </ul>	3 1/2	3 1/2	1	3	1	EC33	\$369
<b>Under Surface Convenience Power Unit</b>  <ul style="list-style-type: none"> <li>• three outlets</li> <li>• 120" power cord</li> <li>• black</li> <li>• ETL Listed for US</li> </ul>	3 1/8	7 1/8	2 1/8	3	1	EC34	\$382

**To Order, Specify:**



1 Model number

When ordering Quickship products, place a "Q" in front of model number.  
 Example: QAK1



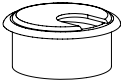
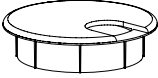
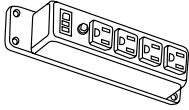
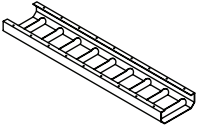

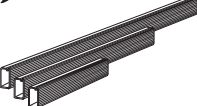
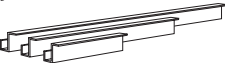
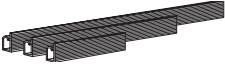
Description	D	W	H	CTN WT	CU FT	① Model	List Price
<b>2"dia. Grommet</b>  <ul style="list-style-type: none"> <li>· use in panels 3/4" thick or greater</li> <li>· plastic sleeve and removable lid</li> <li>· matte black (MBK)</li> <li>· interior 1 1/2" dia.</li> <li>· recommended 1 3/4" dia. cut out for installation in field</li> </ul>	2	2	7/8			GP02FIG	\$28
<b>3"dia. Grommet</b>  <ul style="list-style-type: none"> <li>· use in panels 3/4" thick or greater</li> <li>· plastic sleeve and removable lid</li> <li>· matte black (MBK)</li> <li>· interior 2 1/4" dia.</li> <li>· recommended 2 5/8" dia. cut out for installation in field</li> </ul>	3	3	3/4			GP03FIG	\$28
<b>Power Strip</b>  <ul style="list-style-type: none"> <li>· includes switch</li> <li>· power surge with 10' cord</li> <li>· four electrical outlets</li> </ul>	1 1/2	1 7/8	8			GP9ACP1-0212	\$81
<b>Wire Management Trays</b>  <ul style="list-style-type: none"> <li>· silver powder-coated finish</li> <li>· four hanging brackets (C12C00)</li> </ul>	7 1/2	45				GP9WMT1-0845	\$234
	7 1/2	35				GP9WMT1-0835	\$198
	7 1/2	25				GP9WMT1-0825	\$160

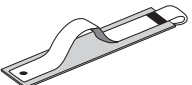
Description	D	W	H	CTN WT	CU FT	① Model	List Price
Vertical Wire Manager 	1 1/2	1 1/2	45	4	1	45VWM	\$113
<ul style="list-style-type: none"> <li>flexible, vertebrae-style construction</li> <li>field installed to bottom of worksurface with screws provided</li> <li>length can be adjusted by removing individual discs as required</li> <li>wire manager is 1 1/2" diameter</li> <li>weighted base is 4" diameter</li> <li>black plastic</li> </ul>							
Wire Management Channel 	1/2	36	1	4		36WC	\$68
	1/2	24	1	3		24WC	\$61
	1/2	12	1	2		12WC	\$53
<ul style="list-style-type: none"> <li>available in 12", 24" and 36" increments</li> <li>field installed with adhesive tape provided</li> <li>black</li> </ul>							
Wire Management Trough 	2 1/2	36	2 1/2	3		36WCT	\$132
	2 1/2	24	2 1/2	3		24WCT	\$119
	2 1/2	12	2 1/2	2		12WCT	\$103
<ul style="list-style-type: none"> <li>available in 12", 24" and 36" increments</li> <li>field installed with screws provided</li> <li>black</li> </ul>							
Wire Management Trough 	1 1/8	36	2 3/8	1		36WJC	\$56
	1 1/8	24	2 3/8	1		24WJC	\$40
	1 1/8	12	2 3/8	1		12WJC	\$21
<ul style="list-style-type: none"> <li>available in 12", 24" and 36" increments</li> <li>field installed with adhesive tape provided</li> <li>mounts to edge of surface top</li> <li>black</li> </ul>							
Cable Management Clip 	2 5/8	3 3/4	1 5/8	1		0304CMC	\$46
<ul style="list-style-type: none"> <li>four retention loops</li> <li>field installed with screws provided</li> <li>mounts under surface</li> <li>black</li> </ul>							
Wire Management Velcro Straps 	1 3/4	3 1/2	1/8	1		04WVS	\$48
<ul style="list-style-type: none"> <li>set of four</li> <li>field installed with adhesive tape provided</li> <li>mounts under surface or on vertical panels</li> <li>black</li> </ul>							

**To Order, Specify:**

① Model number

When ordering Quickship products, place a "Q" in front of model number.  
 Example: QAK1

**NOW!**  
 Need it.  
 JSI Quickship

Description	D	W	H	CTN WT	CU FT	① Model	List Price
		144		4	1	ECT4T-144JK	\$218
		138		4	1	ECT4T-138JK	\$213
		132		4	1	ECT4T-132JK	\$208
		126		4	1	ECT4T-126JK	\$204
		120		4	1	ECT4T-120JK	\$200
		114		4	1	ECT4T-114JK	\$196
		108		4	1	ECT4T-108JK	\$193
		102		4	1	ECT4T-102JK	\$187
		96		3	1	ECT4T-96JK	\$178
		90		3	1	ECT4T-90JK	\$178
		84		3	1	ECT4T-84JK	\$174
		78		3	1	ECT4T-78JK	\$168
		72		3	1	ECT4T-72JK	\$165
		66		3	1	ECT4T-66JK	\$157
		60		3	1	ECT4T-60JK	\$147
		54		3	1	ECT4T-54JK	\$143
		48		2	1	ECT4T-48JK	\$130
		42		2	1	ECT4T-42JK	\$130
		36		2	1	ECT4T-36JK	\$126
		30		2	1	ECT4T-30JK	\$122
	24		2	1	ECT4T-24JK	\$118	
	18		2	1	ECT4T-18JK	\$117	

		120		4	1	ECT4T-120APE	\$331
		108		4	1	ECT4T-108APE	\$323
		96		3	1	ECT4T-96APE	\$315
		84		3	1	ECT4T-84APE	\$312
		72		3	1	ECT4T-72APE	\$264
		60		3	1	ECT4T-60APE	\$225
		48		2	1	ECT4T-48APE	\$218

- single circuit infeed
- two foot rubber cord transitions to metal conduit

		144		4	1	ECT4T-144HPE	\$204
		132		4	1	ECT4T-132HPE	\$195
		120		4	1	ECT4T-120HPE	\$189
		108		4	1	ECT4T-108HPE	\$183
		96		3	1	ECT4T-96HPE	\$172
		84		3	1	ECT4T-84HPE	\$163
		72		3	1	ECT4T-72HPE	\$155

- single or double circuit infeed
- 4 wire 2 circuit system
- 13 duplexes available per each circuit

ACCESSORIES

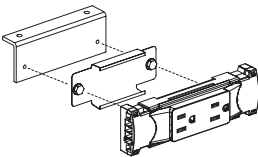
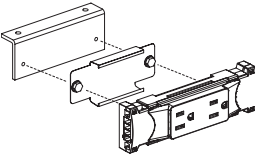
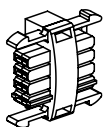
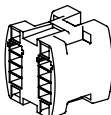
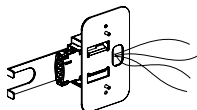
Description	D	W	H	CTN WT	CU FT	① Model	List Price
<b>Conduit Clamp</b>  <ul style="list-style-type: none"> <li>· includes screw</li> </ul>				1	1	ECT4T-CLAMP	\$10
<b>Duplex Receptacle Kit Circuit 1</b>  <ul style="list-style-type: none"> <li>· used in single circuit and multi-circuit applications</li> <li>· vertical and horizontal mounting brackets included</li> </ul>				1	1	ECT4T-DUP1K	\$112
<b>Duplex Receptacle Kit Circuit 2</b>  <ul style="list-style-type: none"> <li>· used in multi-circuit applications</li> <li>· vertical and horizontal mounting brackets included</li> </ul>				1	1	ECT4T-DUP2K	\$112
<b>Receptacle to Receptacle Connector</b> 				1	1	ECT4T-R2R	\$67
<b>H Block Connector Kit</b>  <ul style="list-style-type: none"> <li>· accepts one power infeed and connects up to three jumpers</li> <li>· mounting bracket included</li> </ul>				1	1	ECT4T-4HCON	\$74
<b>Quick Disconnect</b>  <ul style="list-style-type: none"> <li>· hardwire connection (4 wire), mounts to wall</li> <li>· accommodates single or multi-circuit</li> <li>· connects directly to jumper in place of power infeed</li> </ul>	1	2 3/4	4 5/8	1	1	ECT4T-4QD	\$148

To Order, Specify:  
 ① Model number

**Standard Power and Data Locations for Casegoods:**

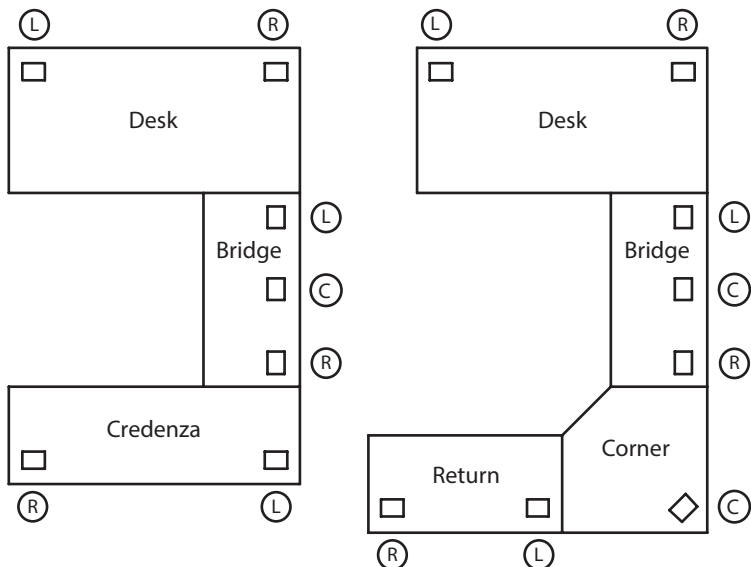

- Specify - Location when ordering on desk, return, computer corner, bridge and credenza - please provide drawing.
- Computer corner units - power/data replaces grommet.
- Standard power and data unit locations are indicated from user side of desk, return, computer corner bridge or credenza.

**NOTE:** Verify fit of data jack in adapter before ordering large quantities as manufacturer designs may change without notice

**Standard Power and Data Locations for Tables and Conference Units:**

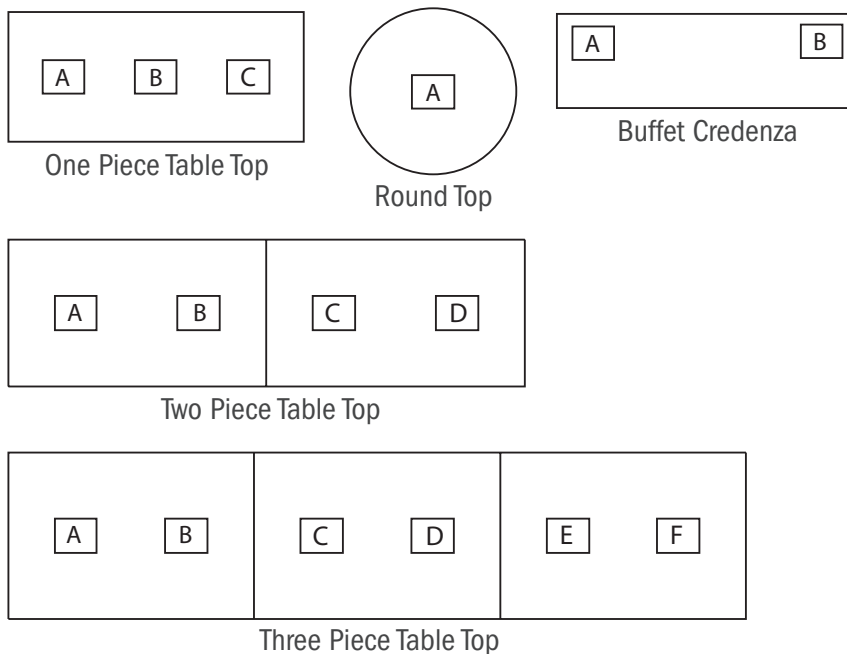

- Verify fit of jack in adapter before ordering large quantities as manufacturer designs may change without notice.
- Installation of Power and Data units on a seam of multi piece tops should be avoided when possible.
- Specify location when ordering conference tops or buffet credenza.
- Standard power and data units are indicated from the side of conference tops and user side of buffet credenza.

## Data Adapter Applications

Data adapter kits ship with each power and data unit.

Adapter plates are marked on the back with letter designators to indicate the data jack manufacturer, series and style. Websites are listed below for quick reference to verify data jack series or style.

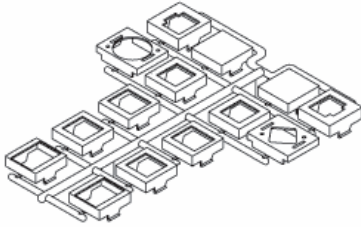





*Included with EC9, EC10, EC13, EC15, TCP110 and CC9CNE1-0708.*

**NOTE:** Verify fit of data jack in adapter before ordering large quantities as manufacturer designs may change without notice.

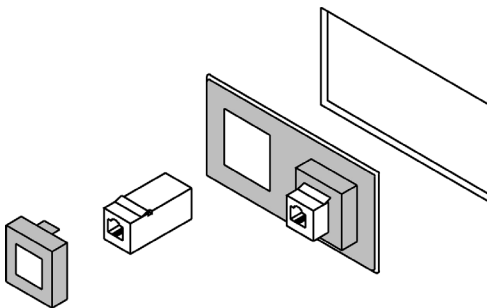
Adapter	Manufacturer	Website
AA	Uniprise/Systimax/Avaya	<a href="http://www.unipriseresolutions.com">www.unipriseresolutions.com</a>
BB	Tyco SL and 100 Connect Series Modular Jacks	<a href="http://www.ampconnect.com">www.ampconnect.com</a>
BB	Siemon Keystone Style	<a href="http://www.siemon.com">www.siemon.com</a>
BB	Allen Tel Versa Tap Series	<a href="http://www.allentel.com">www.allentel.com</a>
BB	Leviton Quick Port® Series	<a href="http://www.leviton.com">www.leviton.com</a>
BB	Nordx Keystone Style	<a href="http://www.nordx.com">www.nordx.com</a>
CC	Tyco SL Coupler Series	<a href="http://www.ampconnect.com">www.ampconnect.com</a>
CC	Krone 6000 Series	<a href="http://www.adc.com">www.adc.com</a>
CC	Hubbell Xcelerator™ Keystone Series	<a href="http://www.hubbell.com">www.hubbell.com</a>
DD	Blank (no coupler/jack)	
EE	Ortronics TracJack Series	<a href="http://www.ortronics.com">www.ortronics.com</a>
FF	Panduit Mini-Com Series	<a href="http://www.panduit.com">www.panduit.com</a>
GG	Microphone jack/3-pin XLR, solder type only	
HH	Video Monitor jack/DB-15, panel mount solder style	

The TCP110 Type 1 Data plate comes with the adapter kit to allow installation of data jacks listed above. The TCP110 can be installed in the EC4, EC5, EC6, EC7.

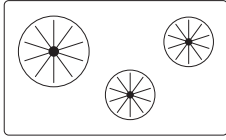
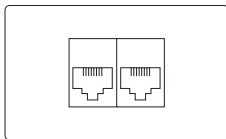
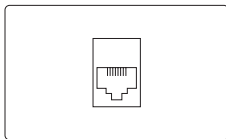
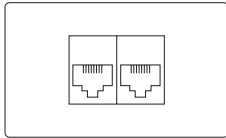
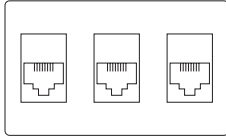

Description	D	W	H	CTN WT	CU FT	① Model	List Price
<b>Data Plate - Blank Cap</b>  <ul style="list-style-type: none"> <li>· for use in EC4, EC5, EC6, EC7</li> </ul>		1 3/4	3 1/8			<b>TCP101</b>	<b>\$13</b>
<b>Data Plate - Three Cord Bushings</b>  <ul style="list-style-type: none"> <li>· for use in EC4, EC5, EC6, EC7</li> </ul>		1 3/4	3 1/8			<b>TCP102</b>	<b>\$52</b>
<b>Data Plate - Two Jacks</b>  <ul style="list-style-type: none"> <li>· one RJ11 Cat3 Jack</li> <li>· one RJ-45 Cat6 Jack</li> <li>· for use in EC4, EC5, EC6, EC7</li> </ul>		1 3/4	3 1/8			<b>TCP103</b>	<b>\$128</b>
<b>Data Plate - One Jack</b>  <ul style="list-style-type: none"> <li>· one RJ-45 Cat6 jack</li> <li>· for use in EC4, EC5, EC6, EC7</li> </ul>		1 3/4	3 1/8			<b>TCP104</b>	<b>\$90</b>
<b>Data Plate - Two Jacks</b>  <ul style="list-style-type: none"> <li>· two RJ-45 Cat6 jacks</li> <li>· for use in EC4, EC5, EC6, EC7</li> </ul>		1 3/4	3 1/8			<b>TCP105</b>	<b>\$171</b>
<b>Data Plate - Three Jacks</b>  <ul style="list-style-type: none"> <li>· three RJ-45 Cat6 jacks</li> <li>· for use in EC4, EC5, EC6, EC7</li> </ul>		1 3/4	3 1/8			<b>TCP106</b>	<b>\$248</b>
<b>Data Plate - HDMI</b>  <ul style="list-style-type: none"> <li>· one HDMI female to female with 36" cord</li> <li>· for use in EC4, EC5, EC6, EC7</li> </ul>		1 3/4	3 1/8			<b>TCP107</b>	<b>\$198</b>

ACCESSORIES

Description	D	W	H	CTN WT	CU FT	① Model	List Price
<b>Data Plate - VGA and Mini-Stereo</b>		1 ¾	3 ⅞			<b>TCP108</b>	<b>\$205</b>

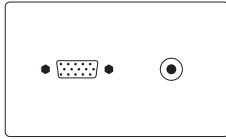

- one VGA female to female with 72" cord
- one Mini-Stereo Inline
- for use in EC4, EC5, EC6, EC7

<b>Data Plate - VGA, HDMI and Mini-Stereo</b>		1 ¾	3 ⅞			<b>TCP109</b>	<b>\$385</b>
-----------------------------------------------	--	-----	-----	--	--	---------------	--------------

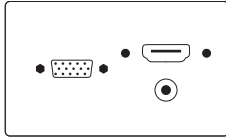

- one VGA female to female with 72" cord
- one HDMI female to female with 36" cord
- one Mini-Stereo Inline
- for use in EC4, EC5, EC6, EC7

<b>Data Plate - Two Open Data Ports</b>		1 ¾	3 ⅞			<b>TCP110</b>	<b>\$17</b>
-----------------------------------------	--	-----	-----	--	--	---------------	-------------

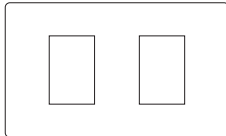

- used with two Type 3 Telecom Jacks; see page 405
- for use in EC4, EC5, EC6, EC7

<b>Data Plate - USB 3.0</b>		1 ¾	3 ⅞			<b>TCP111</b>	<b>\$228</b>
-----------------------------	--	-----	-----	--	--	---------------	--------------

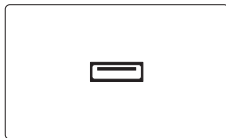

- one USB 3.0 Type A/A with 36" patch cord with male end
- for use in EC4, EC5, EC6, EC7
- data transfer port
- can become powered USB charging port with addition of TCP111-POW power supply

<b>USB Charging - Power Supply</b>						<b>TCP111-POW</b>	<b>\$140</b>
------------------------------------	--	--	--	--	--	-------------------	--------------

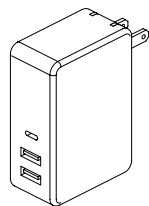

- USB power supply
- for use with TCP111
- converts TCP111 into USB charging port
- power source under table or from building required to power unit

**To Order, Specify:**

- ① Model number

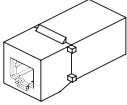
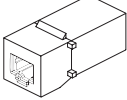

Description	D	W	H	CTN WT	CU FT	① Model	List Price
<b>Phone Jack</b>  <ul style="list-style-type: none"> <li>· RJ-11 phone jack</li> <li>· for use in EC7</li> </ul>						<b>TCP201</b>	<b>\$95</b>
<b>Data Jack</b>  <ul style="list-style-type: none"> <li>· CAT6-RJ45 data jack</li> <li>· for use in EC7</li> </ul>						<b>TCP202</b>	<b>\$95</b>

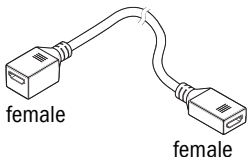
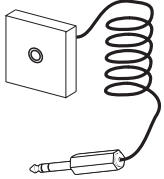
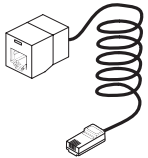
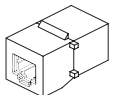
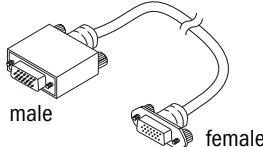
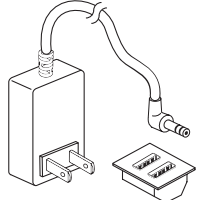
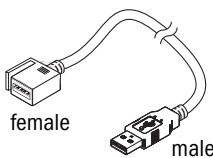
Description	D	W	H	CTN WT	CU FT	① Model	List Price
<b>HDMI Connector</b>  <ul style="list-style-type: none"> <li>· HDMI coupler</li> <li>· 18" cord</li> <li>· female to female connection</li> <li>· for use in EC9, EC10, EC13, EC15</li> <li>· uses data adapter kit BB adapter plate</li> </ul>						<b>TCP301</b>	<b>\$104</b>
<b>Mini Stereo Jack</b>  <ul style="list-style-type: none"> <li>· 3.5 mm Mini Stereo Jack</li> <li>· 10 foot cord</li> <li>· female to male connection</li> <li>· for use in EC9, EC10, EC13, EC15</li> <li>· installs directly into unit without need of data adapter kit</li> </ul>						<b>TCP302</b>	<b>\$29</b>
<b>Network Jack</b>  <ul style="list-style-type: none"> <li>· Cat5e RJ-45 Panduit Jack</li> <li>· Pre-terminated</li> <li>· 9 foot cord</li> <li>· 8-Pin</li> <li>· for use in EC9, EC10, EC13, EC15</li> <li>· uses data adapter kit FF adapter plate</li> </ul>						<b>TCP303</b>	<b>\$93</b>
<b>Voice Coupler</b>  <ul style="list-style-type: none"> <li>· AMP Category 3, RJ-11</li> <li>· 6-Pin</li> <li>· connects to standard phone cord</li> <li>· for use in EC9, EC10, EC13, EC15</li> <li>· uses data adapter kit CC adapter plate</li> </ul>						<b>TCP304</b>	<b>\$93</b>
<b>Data Jack - VGA 15 Pin</b>  <ul style="list-style-type: none"> <li>· 120" M/F cable - female-to-male connection</li> <li>· 15 pin connections</li> <li>· provides electronic device to remove display connection</li> <li>· uses data adapter kit HH adapter plate</li> </ul>						<b>TCP305</b>	<b>\$128</b>
<b>Dual Powered USB Charging</b>  <ul style="list-style-type: none"> <li>· two (2) USB-A connections for USB powered devices or charging mobile electronics</li> <li>· 2000mA (2 amp) charging power per USB port</li> <li>· black or white option</li> <li>· for use in EC9, EC10, EC13, EC15</li> <li>· installs directly into unit without need of data adapter kit</li> <li>· 27" cord</li> </ul>						<b>TCP306</b>	<b>\$171</b>
<b>Data Jack - USB 3.0</b>  <ul style="list-style-type: none"> <li>· USB 3.0 data jack with 10' cord and male plug</li> <li>· for use in EC9, EC10, EC13, EC15</li> <li>· data transfer port - no USB charging capability</li> <li>· data transfer speed up to 5gbs/sec</li> <li>· uses data adapter kit HH adapter plate</li> </ul>						<b>TCP307</b>	<b>\$93</b>

To Order, Specify:

① Model number

Description	D	W	H	CTN WT	CU FT	① Model	List Price
48" w Task Light	4 1/2	48	1 1/2	6	1	48T5L	\$449

**NOW!**

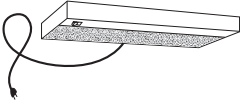

- use with overhead cabinets 60" wide and larger
- uses slim energy-efficient T5 - 3500k lamp (included)
- two position on - off switch
- prismatic lens with electronic ballast
- ETL listed component
- factory installation optional (no additional charge); please specify unit where light is to be installed

24" w Task Light	4 1/2	24	1 1/2	4	1	24T5L	\$312
------------------	-------	----	-------	---	---	-------	-------

**NOW!**

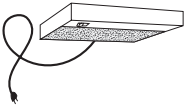

- use with overhead cabinets 30" wide and larger
- uses slim energy-efficient T5 - 3500k lamp (included)
- two position on - off switch
- prismatic lens with electronic ballast
- ETL listed component
- factory installation optional (no additional charge); please specify unit where light is to be installed

31" w LED Starter Task Light	2	31	1/2	4	1	TL31LED-S	\$713
------------------------------	---	----	-----	---	---	-----------	-------

**NOW!**



- use with overhead cabinets 42" wide and larger
- slim energy-efficient stand alone or starter LED lamp
- soft touch switching with instant on to fade way off
- infinite dimming with last state memory (dimming range 100% to 15%)
- automatic time off after 10 hours
- includes power supply
- ETL listed component
- GSA compliant
- factory installation optional (no additional charge); please specify unit where light is to be installed



31" w LED Linking Adder Task Light	2	31	1/2	4	1	TL31LED-A	\$628
------------------------------------	---	----	-----	---	---	-----------	-------

**NOW!**

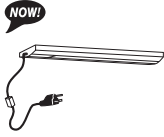

- use with overhead cabinets 42" wide and larger
- slim energy-efficient LED lamp for linking to a starter task light
- string may contain 1 starter with up to five adders
- soft touch switching with instant on to fade way off
- infinite dimming with last state memory (dimming range 100% to 15%)
- automatic time off after 10 hours
- ETL listed component
- GSA compliant
- factory installation optional (no additional charge); please specify unit where light is to be installed

ACCESSORIES



Description	D	W	H	CTN WT	CU FT	1 Model	List Price
<b>17" w LED Starter Task Light</b> 	2	17	1/2	2	1	TL17LED-S	\$580
<ul style="list-style-type: none"> <li>· use with overhead cabinets 30" wide and larger</li> <li>· slim energy-efficient stand alone or starter LED lamp</li> <li>· soft touch switching with instant on to fade way off</li> <li>· infinite dimming with last state memory (dimming range 100% to 15%)</li> <li>· automatic time off after 10 hours</li> <li>· includes power supply</li> <li>· ETL listed component</li> <li>· GSA compliant</li> <li>· factory installation optional (no additional charge); please specify unit where light is to be installed</li> </ul>							
<b>17" w LED Linking Adder Task Light</b> 	2	17	1/2	2	1	TL17LED-A	\$397
<ul style="list-style-type: none"> <li>· use with overhead cabinets 30" wide and larger</li> <li>· slim energy-efficient LED lamp for linking to a starter task light</li> <li>· string may contain 1 starter with up to five adders</li> <li>· soft touch switching with instant on to fade way off</li> <li>· infinite dimming with last state memory (dimming range 100% to 15%)</li> <li>· automatic time off after 10 hours</li> <li>· ETL listed component</li> <li>· GSA compliant</li> <li>· factory installation optional (no additional charge); please specify unit where light is to be installed</li> </ul>							
<b>Motion Sensor for Task Lights</b> 	2	3	1/2	1	1	TL03-OCPS	\$390
<ul style="list-style-type: none"> <li>· occupancy sensor for LED task lights</li> <li>· integrates with TL31LED or TL17LED</li> <li>· shuts off after 30 minutes of inactivity</li> <li>· connects to end of light fixture (adds 3" to length of fixture)</li> <li>· one sensor controls starter and connected adders</li> </ul>							

**To Order, Specify:**

1 Model number

When ordering Quickship products, place a "Q" in front of model number.  
 Example: QAK1

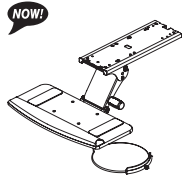
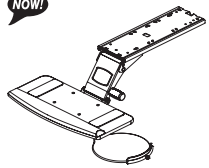
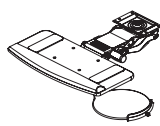
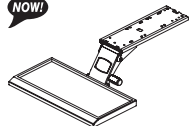
**NOW!**  
 Need it.  
 JSI Quickship.

Description	D	W	H	CTN WT	CU FT	① Model	List Price
 <p>Articulating Keyboard Tray</p>	13	24	7	14	2	AK2	\$540
<ul style="list-style-type: none"> <li>· articulating keyboard tray - black color</li> <li>· mouse tray included</li> <li>· 16" glide track</li> <li>· easy one-handed adjustment; vertical range of motion of 5.1" below glide track</li> <li>· tray tilt range +10 degree to -20 degree</li> <li>· unit swivels side-to-side</li> <li>· tray size is 19.4" wide x 9.4" deep</li> <li>· tray includes palm rest</li> <li>· tray is made with recyclable high density polyethylene</li> </ul>							
 <p>Articulating Keyboard Tray</p>	13	24	7	12	2	AK3	\$597
<ul style="list-style-type: none"> <li>· articulating keyboard tray - black color</li> <li>· mouse tray included</li> <li>· 17" glide track</li> <li>· easy one-handed adjustment; vertical range of motion of 8.9"; (6.5" below the glide track and an additional 2.38" above)</li> <li>· tray tilt range +10 degree to -20 degree</li> <li>· unit swivels side-to-side</li> <li>· tray size is 19.4" wide x 9.4" deep</li> <li>· tray includes palm rest</li> <li>· tray is made with recyclable high density polyethylene</li> </ul>							
 <p>Articulating Keyboard Tray</p>	11	23	3	11	2	AK5	\$558
<ul style="list-style-type: none"> <li>· trackless articulating keyboard tray - black color</li> <li>· mouse tray included</li> <li>· use when depth under work surface for mounting is limited; minimum of 9.38" depth recommended</li> <li>· easy one-handed adjustment; vertical range of motion of 5.73</li> <li>· tray tilt range +10 degree to -15 degree</li> <li>· unit swivels side-to-side</li> <li>· tray size is 19.4" wide x 9.4" deep</li> <li>· tray includes palm rest</li> <li>· tray is made with recyclable high density polyethylene</li> </ul>							
 <p>Articulating Keyboard Tray</p>	14	23	7	15	2	AK4	\$640
<ul style="list-style-type: none"> <li>· articulating keyboard tray - wood finish tray with black mechanism</li> <li>· recommended for spaces with 24" clearance side to side</li> <li>· mouse tray purchased separately - specify MT4</li> <li>· 17" glide track</li> <li>· easy one-handed adjustment; vertical range of motion of 8.9"; (6.5" below the glide track and an additional 2.38" above)</li> <li>· tray tilt range +10 degree to -20 degree</li> <li>· unit swivels side-to-side</li> <li>· tray size is 21.75" wide x 11" deep</li> <li>· wood tray requires finish selection; see component finishes for the selection</li> </ul>							
 <p>Keyboard Tray Mouse Pad</p>	8	8	1/4	2		MT4	\$186
<ul style="list-style-type: none"> <li>· adjusts for user comfort</li> <li>· 8" x 8"</li> <li>· for left or right hand operation</li> <li>· compatible with AK4 Keyboard Drawer only</li> </ul>							

ACCESSORIES

Description	D	W	H	CTN WT	CU FT	① Model	List Price
Center Drawer	16	22	1 1/2	8	3	1622CD	\$275

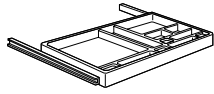

· non-locking

Wide Pencil Drawer	19 1/4	22	1 7/8	5	1	GP2219CD	\$144
--------------------	--------	----	-------	---	---	----------	-------

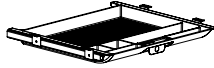

· plastic

Pencil Drawer	19 1/4	16 1/8	2 3/8	4	1	GP1619CD	\$136
---------------	--------	--------	-------	---	---	----------	-------



· plastic

Center Nook Drawer	8 1/4	15 1/4	2	2	1	GP1509CD	\$131
--------------------	-------	--------	---	---	---	----------	-------

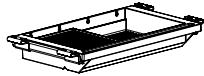

· plastic

**To Order, Specify:**

① Model number

When ordering Quickship products, place a "Q" in front of model number.  
Example: QAK1



Description	D	W	H	CTN WT	CU FT	① Model	List Price
Monitor Support Arm	12	6	17	9		AMA3B	\$562

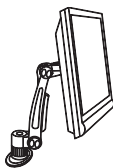

- 360 degree swivel
- adjusts height, tilt and distance of monitor screen to user
- integrated cable management
- grommet and edge clamp mount included
- black finish
- monitor not included
- will fit monitors made to the VESA standard of 75 mm or 100 mm hole spacing in a square configuration

## Conference

### Flat Screen Mount - Universal Bracket (standard with TV, DTV and FSTV model)

Peerless® ST650 universal tilting flat screen mount is supplied with the FSTV Flat Screen Mounting Frame.

- For use with 32"-50" screens
- Maximum weight 175 lbs. (79kg)
- Tilt 15° forward and -5° backward angles
- Mounting pattern allows up to 6" of vertical adjustment

NOTE: To verify TV interface to universal bracket

1. Access website - [www.peerlessmounts.com](http://www.peerlessmounts.com)
2. Locate "Mount Finder™" on home page side navigation bar
3. Enter make and/or model of your flat screen
4. Verify model: ST650 is listed as available model

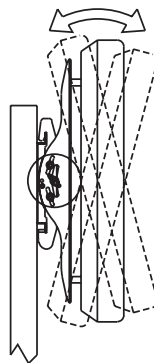

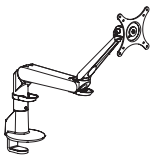
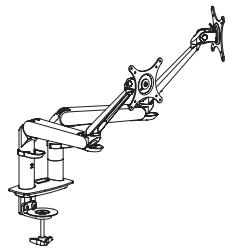
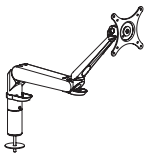
Description	D	W	H	CTN WT	CU FT	① Model	List Price
<b>Monitor Arm - Edge Mount</b>  <ul style="list-style-type: none"> <li>· mounts to edge of worksurface</li> <li>· silver or black</li> </ul>				9	1	GP5901MA	\$599
<b>Dual Monitor Arm - Edge Mount</b>  <ul style="list-style-type: none"> <li>· mounts to edge of worksurface</li> <li>· supports two monitors</li> <li>· silver or black</li> </ul>				18	2	GP5902MA	\$1,078
<b>Monitor Arm</b>  <ul style="list-style-type: none"> <li>· mounts through hole in worksurface</li> <li>· field drilled and field installed</li> <li>· supports up to 12 lbs and/or 27" monitor</li> <li>· silver or black</li> </ul>				9	1	GP5905MA	\$667

**To Order, Specify:**

① Model number

When ordering Quickship products, place a "Q" in front of model number.  
 Example: QAK1

