

Casegoods Price List | Flux Series

General Information

Environmental Mission	II	Custom Options	VIII
Warranty.	III	Care and Maintenance.	IX
Laminate and Veneer Characteristics	III	Specification Tools	X
Samples.	IV	GSA Terms and Conditions	XI
Order Procedures	IV		
Quickship Program.	IV		
Delivery	IV		
Freight Damage	V		
Repairs and Returns	V		
Fire Retardancy / CAL 133	V		
Textile Information / COM and COL Policy.	VI		

Flux - Private Office

Product Information

Overview	2-3
--------------------	-----

General Options

Material Offerings	5
Desk Pedestal Configurations	6
File Drawer Configurations	7
Top Edge Details.	8
Pull Options/Details	9
Casters	10
Modesty Panels	10

Applied Materials

Laminate Grain Directions	11
Veneer Grain Directions	12-13
Color Scheme	14

Product Details

Pedestal Desks	15
Peninsula Desks w/Secondary Creds.	16-18
Run-off Desks	19
Adjustable Height Desks & Tables	20-21
Credenza Options	22
Credenza Compartment Dimensions	24-25
Overhead Cabinet & Wall Panel Stack-ups	26
Wall Panel Installation	27

Product Details (cont.)

Overhead Cabinet Stack-ups	28-30
Overhead Cabinet Door Options	31
Tasklight Size Chart	31
Monitor Cabinets	32-33
Vertical Storage	34-36
Modular Components	37

Technology

Power and Data Wiring Examples.	38-39
Grommets and Power Units	40
Grommet and Power Unit Locations	41-47
Wire Manager Size Chart	48-49

Pricing Pages

Tables	50
Pedestal Desks	54
Peninsula Desks	86
Run-off Desks	110
Returns & Bridges	120
Primary Height Credenzas	126
Modular Credenzas/Pedestals	148
Kneespace Credenzas	152
Peninsula Credenzas.	162

Pricing Pages (cont.)

Primary Height Credenzas	166
Secondary Height Credenzas.	188
Cushions	212
Adjustable Height Units	214
Modular Units	252
Primary Height Overhead Cabinets	270
Primary Height Panels/Markerboards.	292
Secondary Height Overhead Cabinets	296
Secondary Height Panels/Markerboards.	306
Wall Mount Overhead Cabinets.	310
Wall Mount Cubbies	330
Wall Mount Panels/Tackboards.	336
Workwall Panels	352
Storage Towers.	362
Monitor Cabinets	368
Bookcases.	376
Lateral Filing.	378
Wardrobes/Vertical Cabinets	380
Wardrobes/Vertical Cabinets with Legs	414
Pantries	442
Lockers	446

Accessories

Keyboard Accessories	454
Monitor Arms	455
Task Lights.	455
Drawers	456
Power and Data	456
Wire Management	458
Portable Slide on Screen.	459

Flux Overview

Tables [Page 50-53](#)

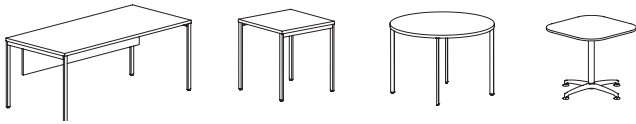

Pedestal Desks [Page 54-85](#)

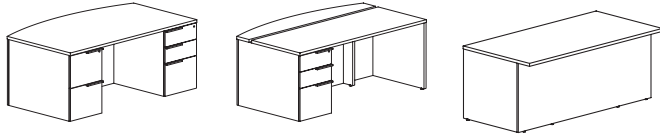

Peninsula Desks [Page 86-109](#)

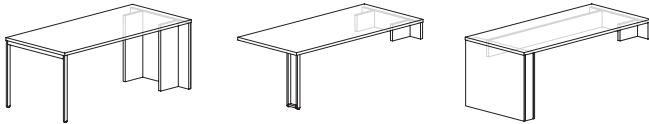

Run-off Desks [Page 110-119](#)

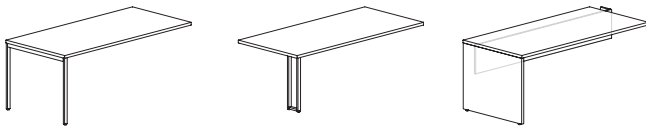

Returns & Bridges [Page 120-125](#)

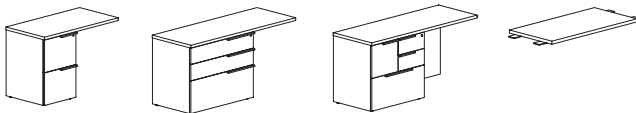

Primary Height Credenzas (to floor) [Page 126-147](#)

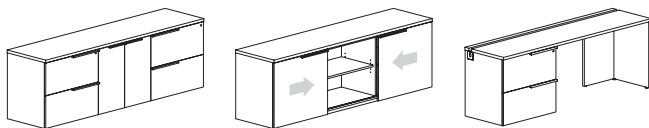

Modular Credenzas/Pedestals [Page 148-151](#)

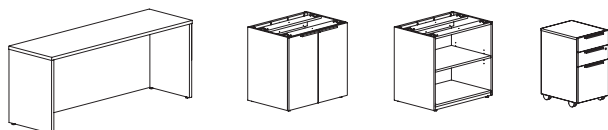

Kneespace Credenzas (on legs) [Page 152-161](#)

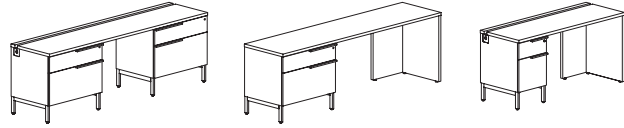

Peninsula Credenzas [Page 162-165](#)

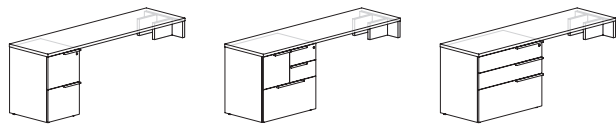

Primary Height Credenzas (on legs) [Page 166-187](#)

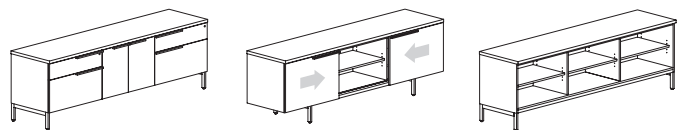

Secondary Height Credenzas [Page 188-211](#)

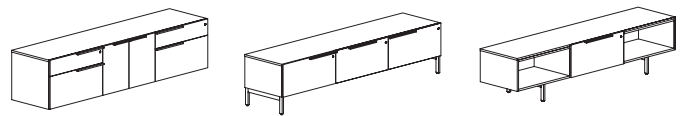

Cushions [Page 212-213](#)

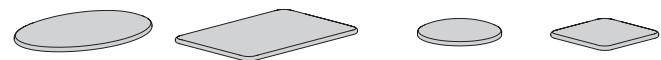

Adjustable Height Units [Page 214-251](#)

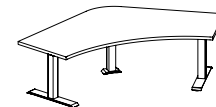

Flux Overview

Modular Units [Page 252-269](#)

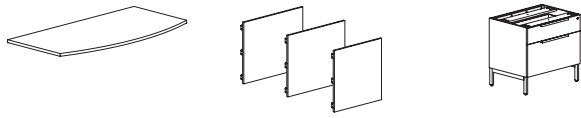

Overhead Cabinets/Panels (Primary Ht.) [Page 270-295](#)

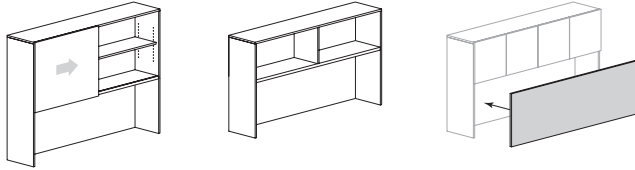

Overhead Cabinets/Panels (Secondary Ht.) [Page 296-309](#)

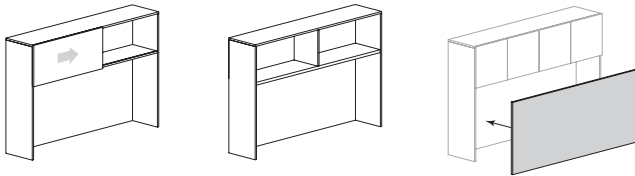

Wall Mount Overhead Cabinets [Page 310-329](#)

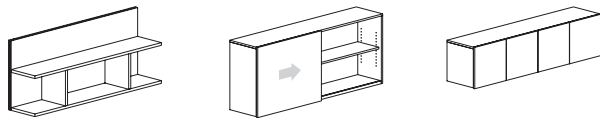

Wall Mount Cubbies [Page 330-335](#)

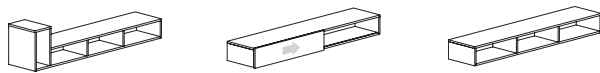

Wall Mount Panels/Accessories [Page 336-361](#)



Storage Towers [Page 362-367](#)

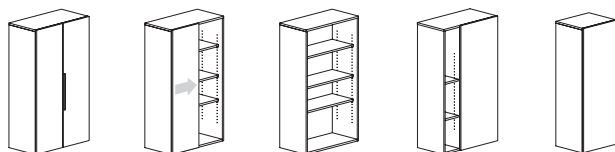

Monitor Cabinets [Page 368-375](#)

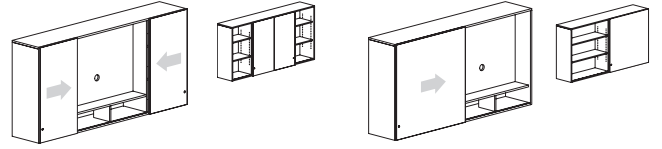

Bookcases/Vertical Filing [Page 376-379](#)

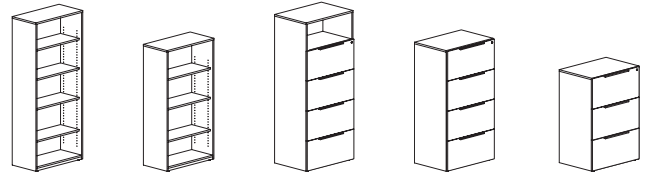

Wardrobes/Vertical Cabinets (to floor) [Page 380-413](#)

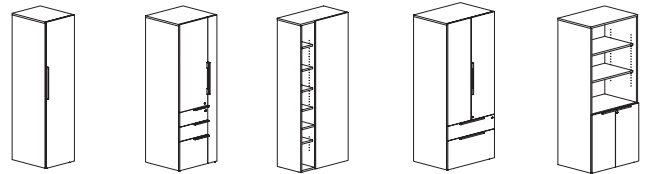

Wardrobes/Vertical Cabinets (on legs) [Page 414-441](#)



Pantries [Page 442-444](#)

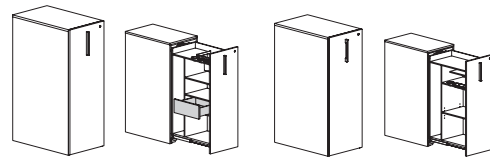

Lockers [Page 446-453](#)

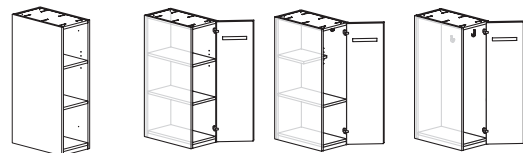

Accessories [Page 454-459](#)

Flux General Options

Laminate Products

Flux Laminate features TFL (thermally fused laminate) chassis and components. Main worksurfaces* are available in a HPL (high pressure laminate).

Eased edges of the worksurface are impact resistant (PVC) on HPL tops. The laminate is offered in wood grain patterns and solid colors. The wood grain laminate features an embossed grain to hide finger prints and light scratches. The solid laminate is smooth to the touch with a semi-matte finish. All Flux Laminate products are indoor-air certified by GreenGuard.

Laminate Worksurface Construction

Worksurfaces have a 3-ply balanced construction. Tops are 1 3/16" thick with coordinating PVC edges. Primary worksurfaces feature 3mm PVC edges on the approach and user sides. Main worksurfaces are offered in HPL. Desk, bridge, return, and primary height credenza worksurfaces are profiled with a 3mm PVC edge on the user side only. Remaining edges are banded with 1mm PVC which creates a seamless appearance when units are mated end-to-end or back-to-back.

HPL Features on Main Worksurfaces*

- fusion of multiple layers create a higher impact resistant surface
- tops are 3-ply balanced construction
- matched to the TFL wood grain and solid patterns

Case Construction

Panels for chassis consist of a 3/4" thick substrate with TFL surfaces and PVC bands on exposed edges. Pedestal and cabinets are constructed with dowels reinforced with screw and interior plates for increased stability. Leveling glides are set into metal housing corner plate to allow for maximum leveling.

*Main Worksurfaces include tops on desks, primary height credenzas, returns, bridges and transaction tops. Refer to pricing pages to confirm availability.

Veneer Products

Exterior wood surfaces are made from the finest selected veneers to achieve clarity and consistency in the Flux Veneer product line. To attain a pleasing, symmetrical pattern, all cherry, maple, and walnut veneers in Flux Veneer are book-matched. All exterior solid lumber is matched to coordinate with the veneer.

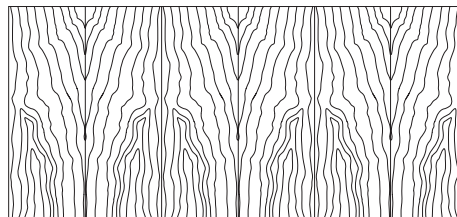

Veneer Book-Matched Example

Alternating pieces of veneer are flipped over so they face each other like the pages within a book.

Flux Veneer is available in flat cut cherry, maple and walnut veneer. A wide range of wood stains have been formulated to enhance the beauty of the veneer.

Double Cut veneer is another choice on Flux Veneer product. This veneer is a processed product that has at least two cuttings to create the final veneers. These cuts of veneer strands are dyed and layered into a block to create a wide variety of patterns, from a very tight grain pattern to an exotic figure grain pattern. Double Cut veneer can be run vertical or horizontal. Please specify the grain direction.

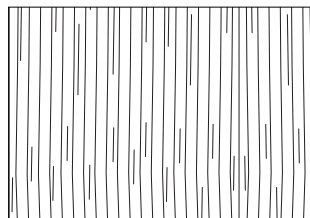

Double Cut Veneer - Tight Grain Pattern

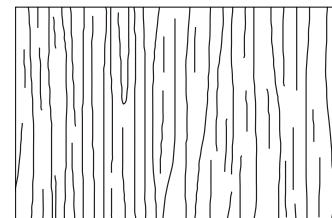

Double Cut Veneer - Natural Grain Example

Veneer Worksurface Construction

Tops are 5-ply balanced construction, 1 3/16" thick with solid matching hardwood edges. Surfaces are available in wood veneer or high pressure laminate. No additional charge for using our coordinating high pressure laminate with a veneer grain pattern with finish wood edges.

Protective Top Coat

DuraTex™ offers exceptional hardness along with abrasion and impact resistance. It has been formulated to eliminate hazardous and harmful gases that are normally associated with wood finish.

DuraTex™ Features

- Safety - Significantly reduces hazardous formaldehyde emissions which help improve the quality of the of the indoor air we breathe.
- Quality - Developed to be tough and durable with special attention to appearance. The DuraTex™ finish preserves the natural beauty of wood.
- Durability - Designed to meet a wide range of demanding performance and environmental standards to withstand even the highest wear and tear.

Special Finishes

Special finishes can be requested by following the instruction in the general introduction section, page V. There is a one-time charge of \$372 list per order.

Finish Sheen

Finish sheen can be modified on the worksurface tops. There is a 15% upcharge added to the list price of each item.

Flux General Options

Flux Standard Laminate Offering

The chart below lists the laminates available on Flux.

Laminate Options

TFL - HPL Wood Grain Pattern Laminates

ALL Ale Light	MIN Mineral
BOL Bourbon Light	OAT Oatmeal Cookie
BZW Brazilwood	PIN Pinnacle Walnut
BGL Brighton Light	STU Studio Teak
CLL Collectors	UMB Umber
FAW Fawn	VAL Valley
FLO Florence Walnut	VIN Vintage
GRH Graphite	WEA Weathered Ash

TFL - HPL Solid Laminates

ALB Alabaster	DWH Designer White
BLK Black	SHD Shadow
BBL Bridal Blanco	SLG Slate Grey

Flux Color Scheme – Accent Colors

Metal Accents

ABZ Aged Bronze	PEW Pewter
ASL Arctic Silver	SBZ Soft Bronze
GLD Gold	SNK Soft Nickel
MBK Matte Black	

Items below are available in any of the seven color schemes listed above:

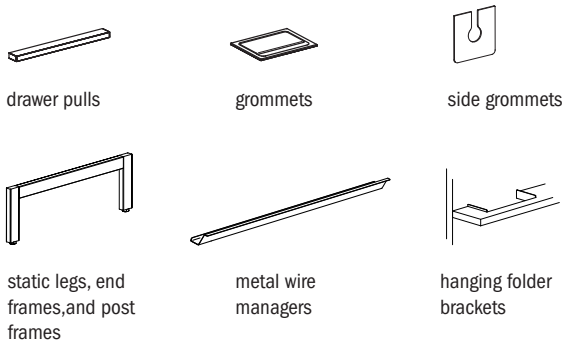

* Note: Height adjustable legs are not offered in all seven color schemes

Black Accents

MLK	Matte Black
-----	-------------

Items below are standard as matte black:

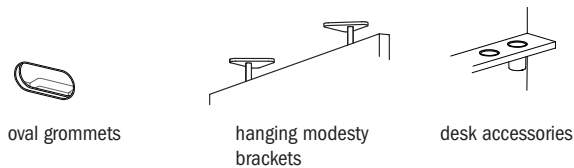

Flux Standard Veneer Finish Offering

The charts below list the veneer stains and paints available on Flux.

Finish/Stain Colors

CH1 Cherry	<i>Flat Cut Veneer</i>
BBM Bourbon Medium	CLL Collectors
BRM Brighton Medium	HRV Harvest
CLA Classic	PRL Praline

MA1 Maple	<i>Flat Cut Veneer</i>
ALM Ale Medium	FLX Flax
BUT Butterscotch	VEN Venetian

WA1 Walnut	<i>Flat Cut Veneer</i>
ESP Espresso	TRF Truffle
MCH Mocha	UMB Umber
SIE Sienna	

BO1 Black Oak	<i>Flat Cut Veneer</i>
RAV Raven	

DC1 Double Cut Veneer	<i>Eased Edge Only</i>
BAR Barrel - Oak Pattern	KHK Khaki
BUF Buff - Oak Pattern	MIN Mineral - Oak Pattern
CIN Cinder - Oak Pattern	RYE Rye - Oak Pattern
COF Coffee	SAB Sable - Oak Pattern
EGR Egret - Oak Pattern	SAD Saddle - Oak Pattern
FAW Fawn	STU Studio Teak
GRH Graphite	VAL Valley

PNT Paint	<i>Maple Flat Cut Veneer</i>
BKD Backdrop	GRV Greek Villa
BFX Black Fox	NET Network Gray
BWH Bright White	NWH Nonchalant White
CGP Cargo Pants	STM Storm
CHT Chatroom	TRC Tricorn Black
FRR French Roast	

Contact Customer Service for any additional veneer species. Samples available upon request.

Veneer Chassis with Laminate Tops

Worksurface only, no additional upcharge if Flux's coordinating wood grain laminate is specified. Contact Customer Service for any other laminate request. Listed below are finishes with coordinating wood grain HPL laminates.

CH1 Cherry	<i>Flat Cut Veneer</i>
CLL Collectors	
HRV Harvest	
PRL Praline	

WA1 Walnut	<i>Flat Cut Veneer</i>
MCH Mocha	TRF Truffle
SIE Sienna	UMB Umber

DC1 Double Cut Veneer	
FAW Fawn	VAL Valley
MIN Mineral - Oak Pattern	

Flux General Options

Desk Pedestal Configuration

The following are standard configurations for Flux pedestal desks.

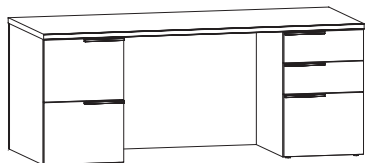

Double Pedestal Desk

Left side: file/file
Right side: box/box/file

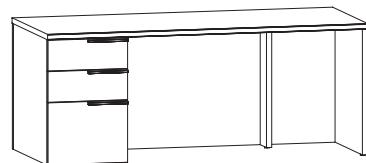

Single Pedestal Desk

box/box/file

The 18" w and 15- 5/8" w pedestal configuration can be switched from box/box/file to file/file or from file/file to box/box/file. This configuration change applies to desks, open corner credenzas and kneespace credenzas at primary height without legs. This must be specified on the order, with an upcharge of \$189 list per pedestal.

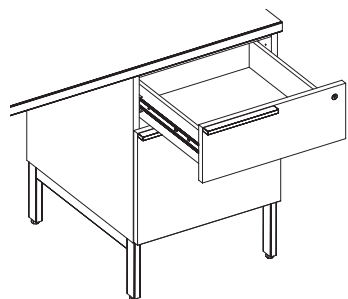

Drawer Information

Flux is standard with a unidirectional V-fold drawer box interior. The box is a durable, miter-fold drawer structure which is glued and doweled. The 1/2"-thick drawer sides are wrapped in a high-grade maple vinyl, with an attached front. The drawer front is attached to the four sided box.

Wood Drawer Boxes

Optional four corner dovetailed wood drawers are available. Specify and add 10% per unit.

Drawer Suspension

High quality black drawer suspension carries a lifetime warranty. File and box drawers have 100% full extension with over travel. Slides feature steel ball bearings for longer wear and positive, cushioned in/out stops.

Filing Hardware

All file drawers are constructed with a custom design for hanging folders. See filing diagram on next page.

Locking

All desks, credenzas, returns and mobile pedestals feature pedestal front locking to provide maximum security and flexibility in configuration. Units are shipped randomly keyed as standard. Key-alike units are available upon request for no additional charges. Removable cores for in-field re-keying are standard.

Lock face color is controlled by the metal color of the unit.

Matte Black = Black Lock Face

Pewter = Black Lock Face

Soft Nickel and Arctic Silver = Silver Lock Face

Interior compartment

Interior compartment sizes and specification matrix on pages 24-25 and 35.

Special Construction

Flux has an extensive product offering to create many types of configurations. Contact Customer Service if you are having trouble with finding the right units to complete the desired configuration. Requests for special construction need to be approved by JSI engineering.

Flux General Options

Filing Drawer Details

Desk and credenza pedestal filing drawers come with hardware to accommodate letter or legal files. File orientation options vary by pedestal size, as shown below. Legal and letter files may be arranged side-to-side in any pedestal, or front-to-back in larger pedestals. Select only one orientation for each filing drawer. Reference the following plan views for available options.

File Orientation Variations (top view)

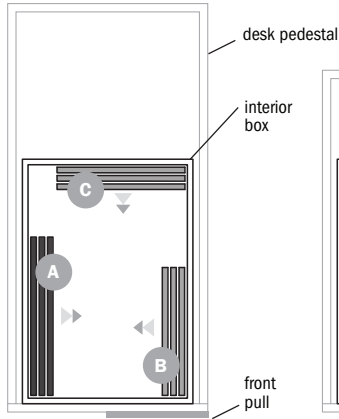

Overall Desk - 84" w through 72" w
 Desk Pedestal - 36" d x 18" w
 Interior Box - 22" d x 15 7/16" w

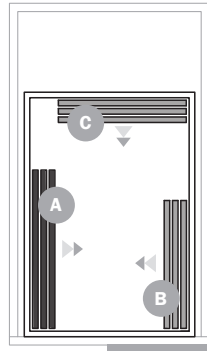

Overall Desk - 84" w through 72" w
 Desk Pedestal - 30" d x 18" w
 Interior Box - 22" d x 15 7/16" w

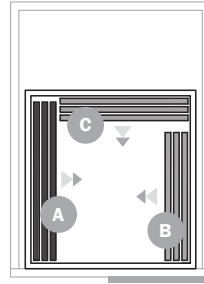

Overall Desk - 84" w through 72" w
 Desk Pedestal - 24" d x 18" w
 Interior Box - 16" d x 15 7/16" w

- A Legal - Side-to-Side
- B Letter - Side-to-Side
- C Letter - Front-to-Back
- D Legal - Front-to-Back

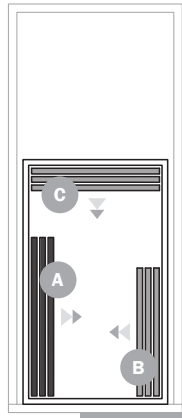

Overall Desk - 66" w through 60" w
 Desk Pedestal - 36" d x 15 7/16" w
 Interior Box - 22" d x 13" w

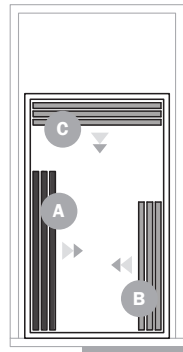

Overall Desk - 66" w through 60" w
 Desk Pedestal - 30" d x 15 7/16" w
 Interior Box - 22" d x 13" w

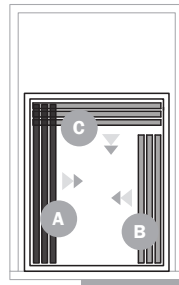

Overall Desk - 66" w through 60" w
 Desk Pedestal - 24" d x 15 7/16" w
 Interior Box - 16" d x 13" w

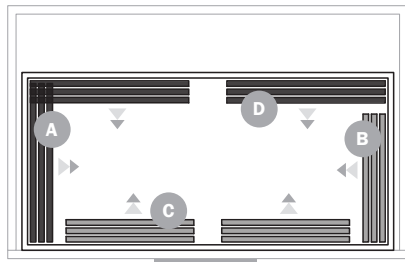

Overall Credenza - 72" w or 36" w
 Credenza Pedestal - 22" d x 36" w
 Interior Box - 16" d x 33 7/16" w

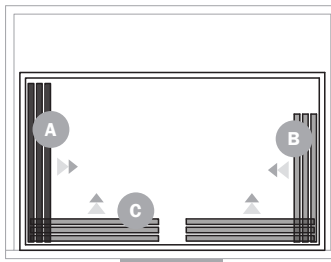

Overall Credenza - 96" w, 90" w, 84" w, 78" w,
 66" w, 60" w, 54" w, 48" w, 42" w or 30" w
 Credenza Pedestal - 22" d x 30" w
 Interior Box - 16" d x 27 7/16" w

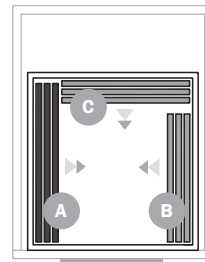

Overall Credenza - 96" w, 90" w,
 84" w, 78" w or 72" w
 Credenza Pedestal - 22" d x 18" w
 Interior Box - 16" d x 15 7/16" w

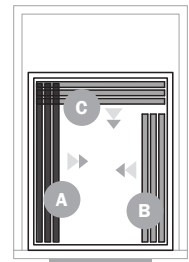

Overall Credenza - 66" w, 60" w,
 54" w, 48" w or 42" w
 Credenza Pedestal - 22" d x 15 7/16" w
 Interior Box - 16" d x 13" w

Flux General Options

Top Edge Profiles

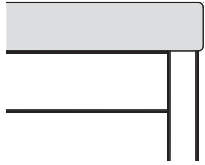

Eased Edge

Standard on worksurface tops

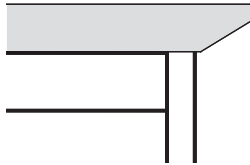

Reverse Bevel Edge

Optional on selected worksurfaces (see below)

Reverse Bevel Edge Location

Peninsula and Run-off Desks

The reverse bevel edge appears on three sides of the worksurface top, as shown to the right, and increases the depth of the top by 2½".

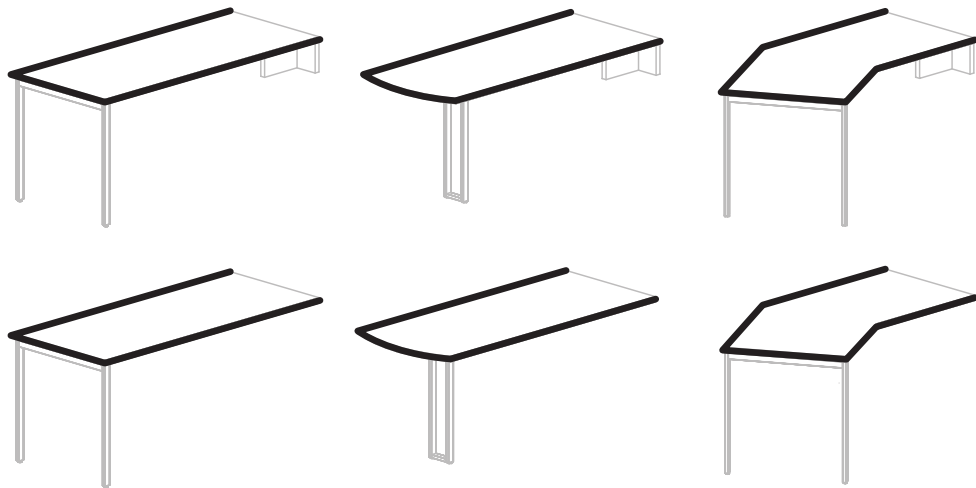

Adjustable Height Desks

The reverse bevel edge location varies according to its worksurface. When it appears on two sides, the depth of the worksurface increases by 2½". When the bevel appears on one side only, it increases the depth by 1¼". Dimension changes only happen when there is no overhang.

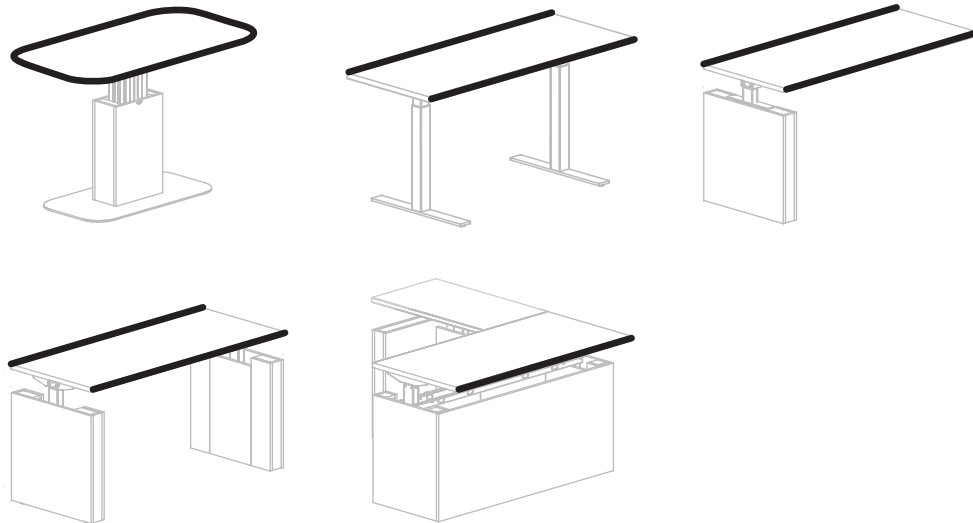

Tables

The reverse bevel edge location varies, as shown to the right, and increases the depth of the top by 2½" on the rectangle table.

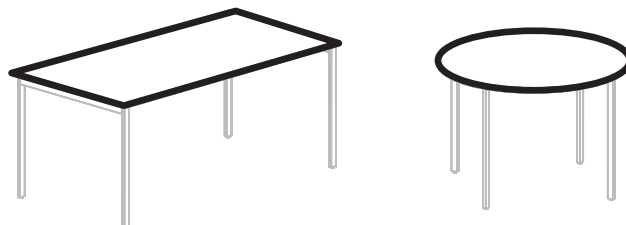

Flux General Options

Pulls and Pull Orientation

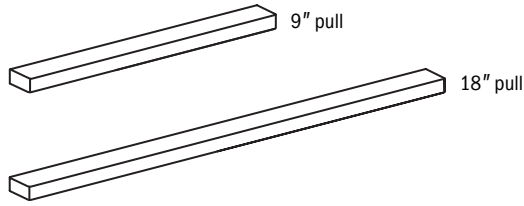

Ledge Pull

- Standard on all Flux products
- Available in Arctic Silver, Matte Black, Soft Nickel or Pewter
- Ledge pull is considered part of the aesthetic of Flux and has unique orientation on the product. See chart below for these locations.
- Ledge pull length is determined by drawer/door width as follows:

9" pull	drawers/doors 18" wide or less
18" pull	drawers/doors wider than 18"

Prism Pull

- Optional – must be specified at the time of order placement
- Available in Arctic Silver, Matte Black, Soft Nickel or Pewter
- Prism pull is mounted in the center of drawers on all drawer and lower doors widths. Upper pulls on worksurface towers or wardrobes are mounted on the right door only.

Lower Drawer/Door Ledge Pull Location



Tower/Wardrobe Ledge Pull Location

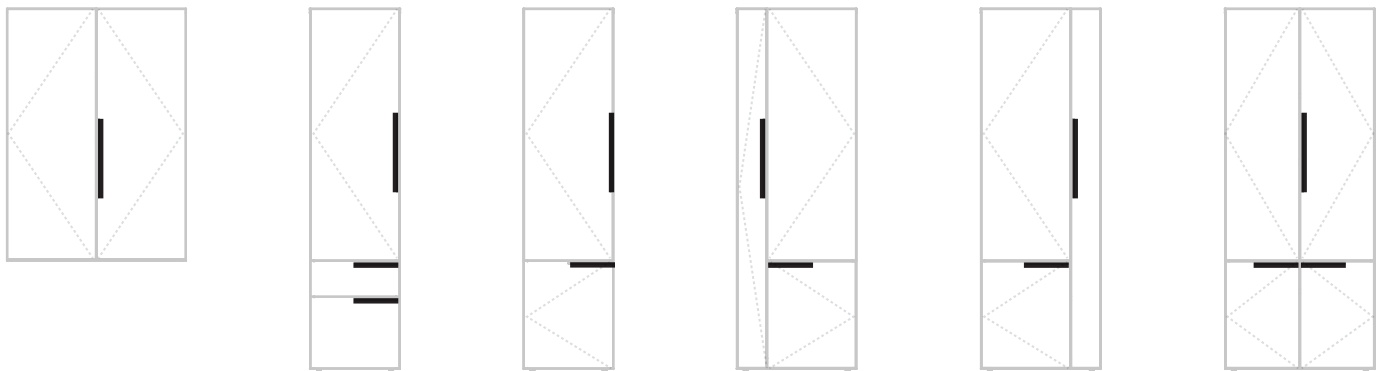

Flux General Options

Caster Option

Flux offers a dual wheel caster option with freestanding and four-star base tables, in place of standard feet. Casters are gray when paired with Arctic Silver or Soft Nickel metal legs, or black with Matte Black or Pewter metal legs.

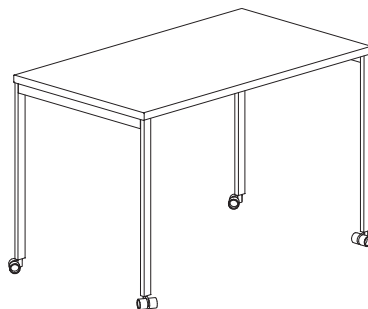
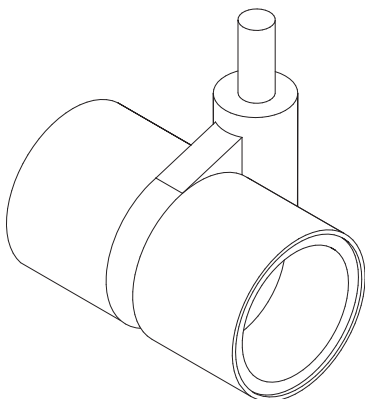

Freestanding tables with legs
Available with 2 locking and 2 non-locking casters



4-star base tables
Available with 4 locking casters

PRODUCT INFORMATION

Modesty Panel Options

Flux offers optional modesty panels for table desks, adjustable height desks, returns, bridges and credenzas. Reference the diagrams below for the modesty panel location on each unit.

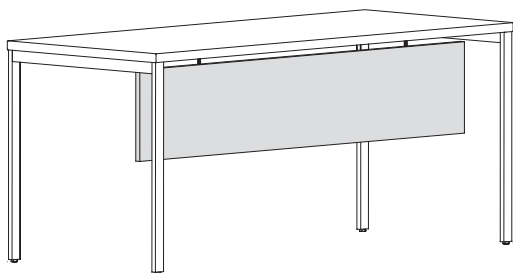
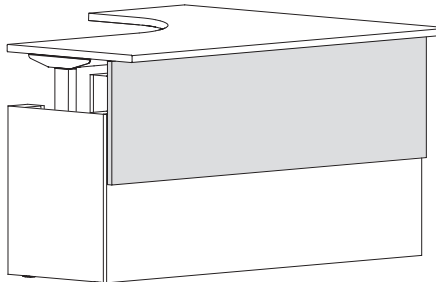
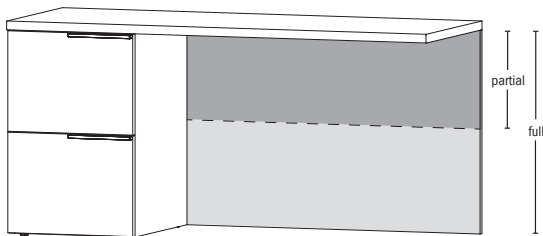

Table Desks
12" suspended modesty panels are available on table desks, peninsula desks, and run-off desks.



Adjustable Height Desks
Modesty panels are available on adjustable height desk shells. The modesty panel mounts in front of the desk and moves with the top.



Returns and Bridges
Partial or full modesty panels are available on return and bridge units.

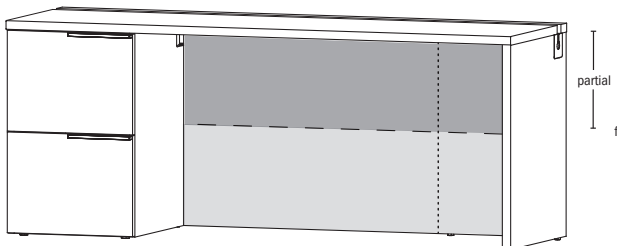

Credenzas
Partial, full or removable modesty panels are available on credenzas.

Flux Applied Materials

Laminate Grain Direction

Laminate grain runs vertical as standard on all vertical surfaces except back panels, wall panels, kneespace access panels, and desk fronts wider than 60", which run horizontal. Worksurfaces run long grain except for bridges, returns, and peninsula and run-off tops 60" and shorter, which run short grain. Below are typical examples of laminate grain direction.

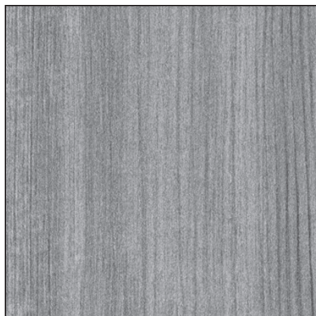
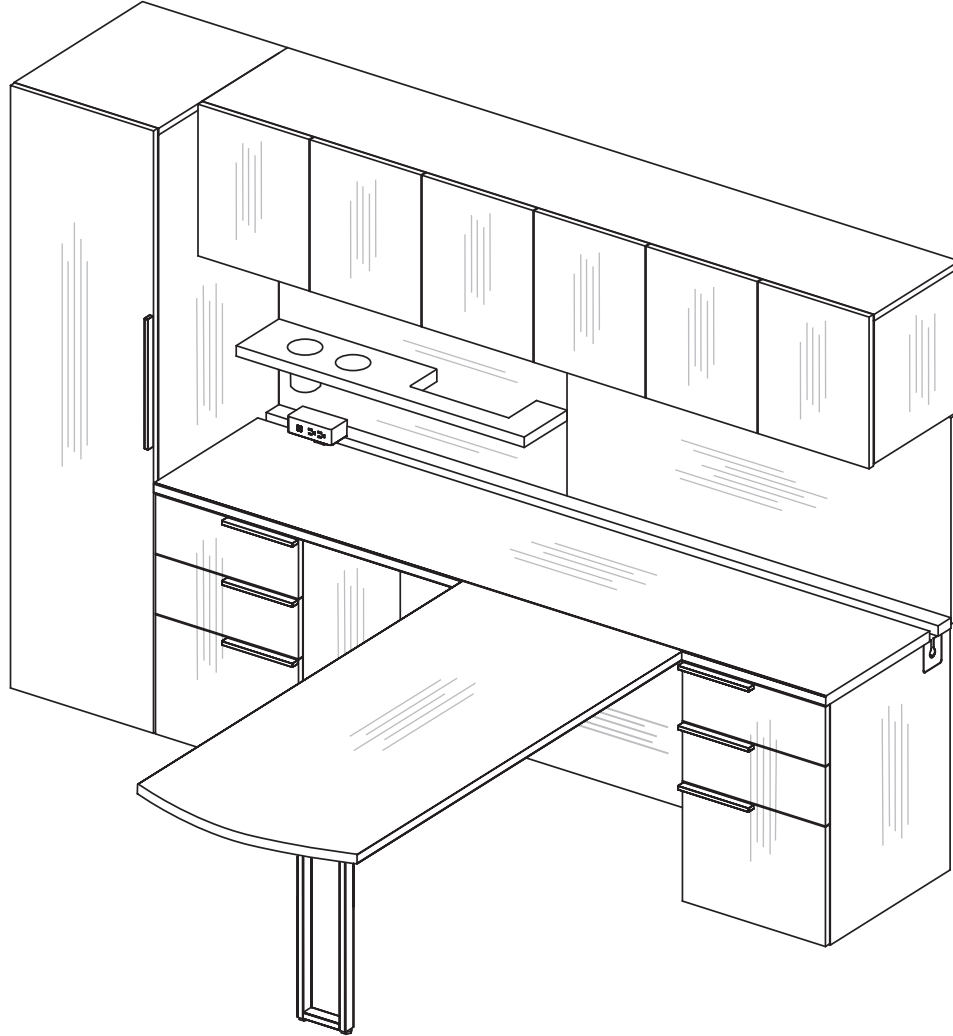

Laminate Grain

Laminate grain direction varies according to its casegood surface. Refer to the diagrams on this page for examples of standard direction.

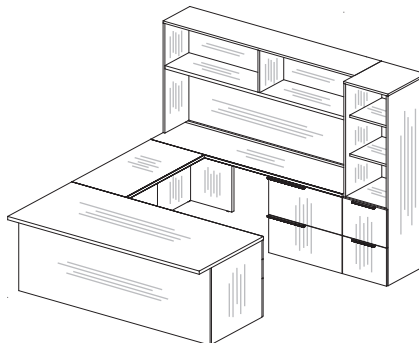

Flush Front Desk U Unit with Open Storage

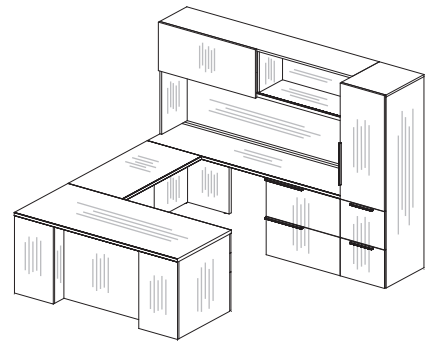

Breakfront Desk U Unit with Closed Storage

Flux Applied Materials

Flat Cut Veneer/Double Cut Veneer Grain Direction

Flat Cut and Double Cut veneer grain runs vertical on all vertical surfaces. Worksurfaces run long grain except for bridges, returns, peninsula and run-off tops, which run short grain. Below are typical examples of vertical veneer grain direction.

PRODUCT INFORMATION

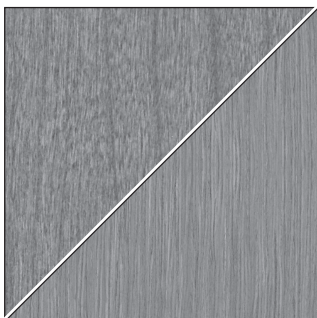
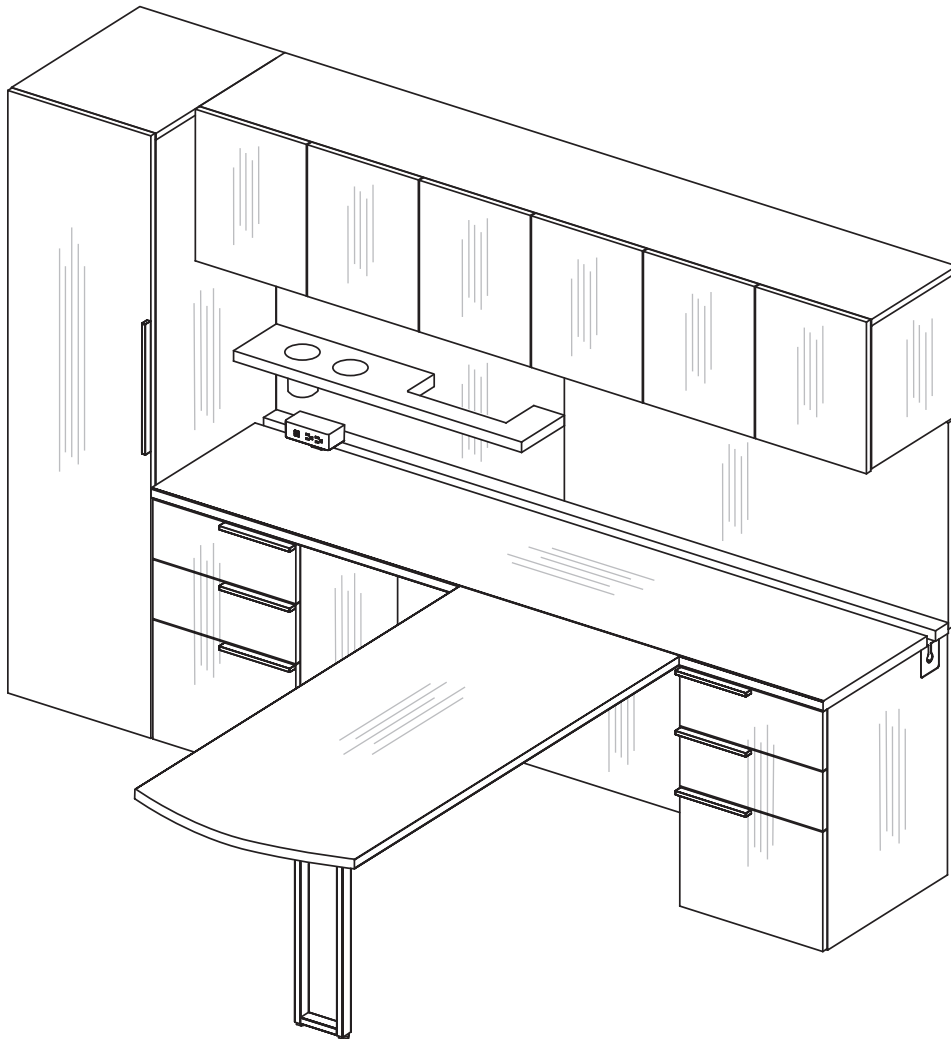

Flat Cut/ Double Cut Grain

Flat Cut grain runs vertical as standard. Double Cut grain may be specified to run vertical; specify at the time of order placement. See diagrams on this page for examples and exceptions.

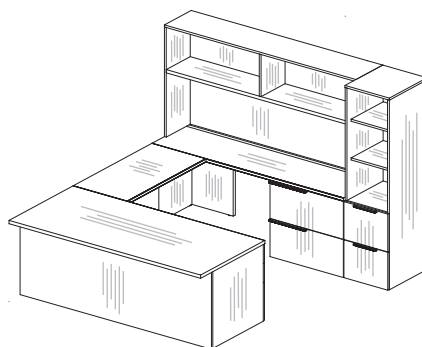

Flush Front Desk U Unit with Open Storage

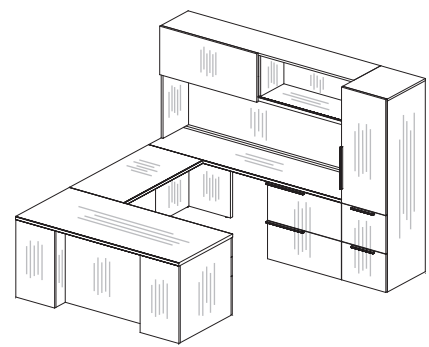

Breakfront Desk U Unit with Closed Storage

Flux Applied Materials

Double Cut Horizontal Grain Direction

Double Cut veneers may be specified with a horizontal grain direction on all surfaces. Worksurfaces run long grain except for bridges, returns, peninsula and run-off tops, which run short grain. Below are typical examples of horizontal Double Cut veneer grain direction.

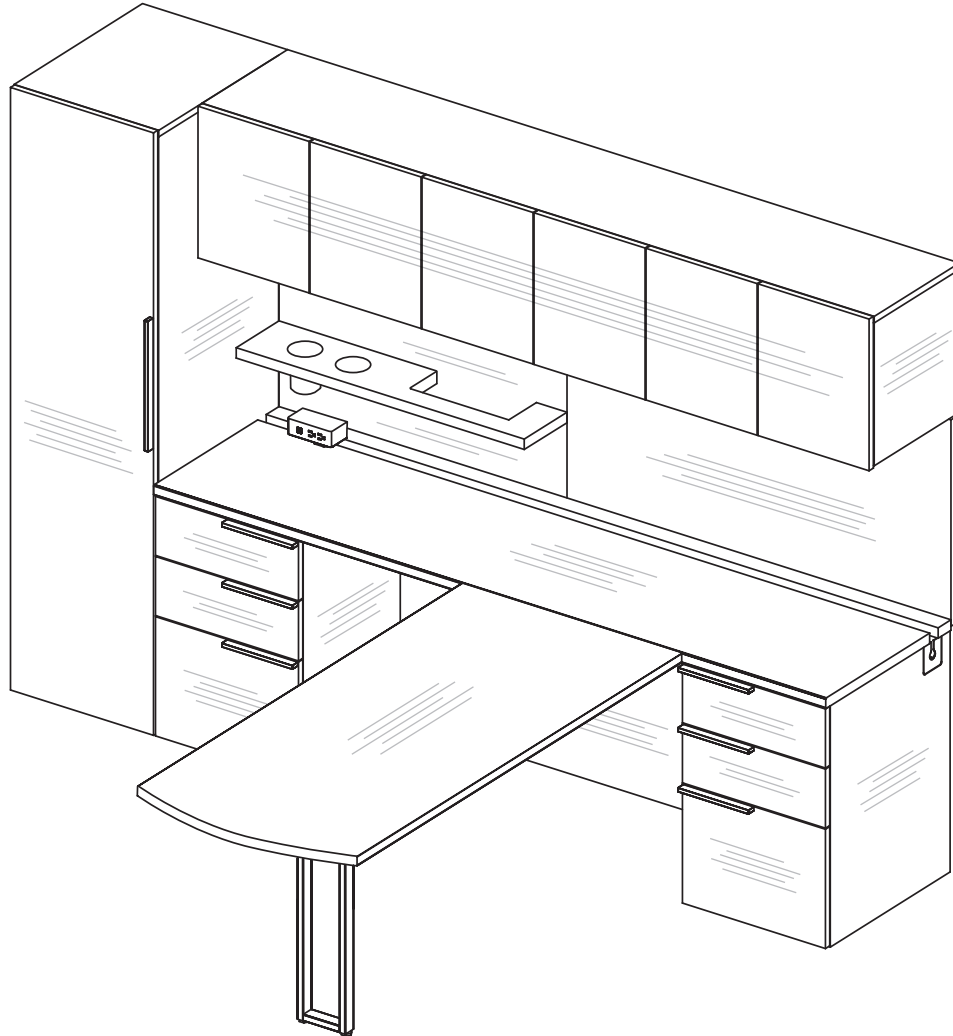

Double Cut Horizontal Grain

Double Cut grain may be specified to run horizontal; specify at the time of order placement. Refer to the diagrams on this page for examples.

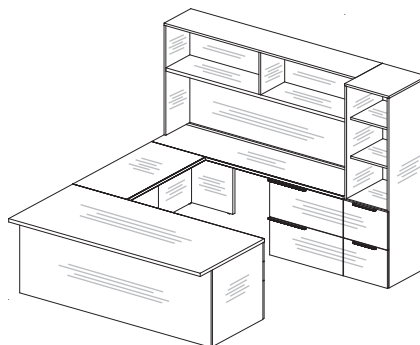

Flush Front Desk U Unit with Open Storage

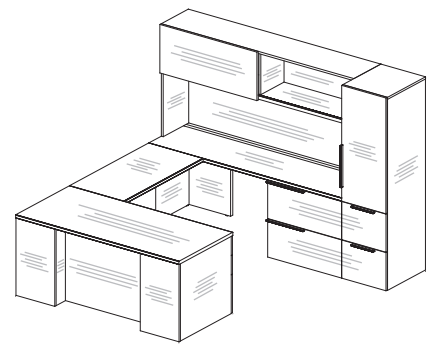

Breakfront Desk U Unit with Closed Storage

**Double Cuts with Oak Pattern are an exception to this and can not be specified to run horizontal.

Flux Applied Materials

Flux Color Scheme

Flux offers the flexibility to specify contrasting drawer and door fronts, or a contrasting worksurface for laminates, separate from the standard chassis selection. See the options available below, depending on whether laminate or veneer is specified for the chassis.

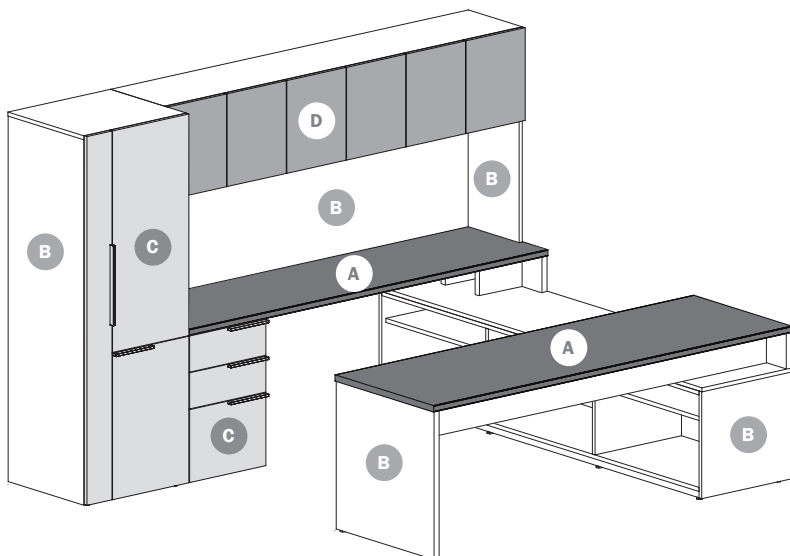

Laminate Surface Options

- A = Worksurface**
Laminate – see page 5 for selection
- B = Chassis**
Laminate – see page 5 for selection
- C = Drawer and Door Fronts**
 1. standard – same as chassis selection
 2. optional – contrasting laminate from standard selection
- D = Overhead and Worksurface Storage Doors**
 1. standard – same as chassis selection
 2. optional
 - a. contrasting laminate from standard selection
 - b. white back painted glass doors in an aluminum frame – see page 31
 - c. markerboard laminate with silver PVC edge see page 31

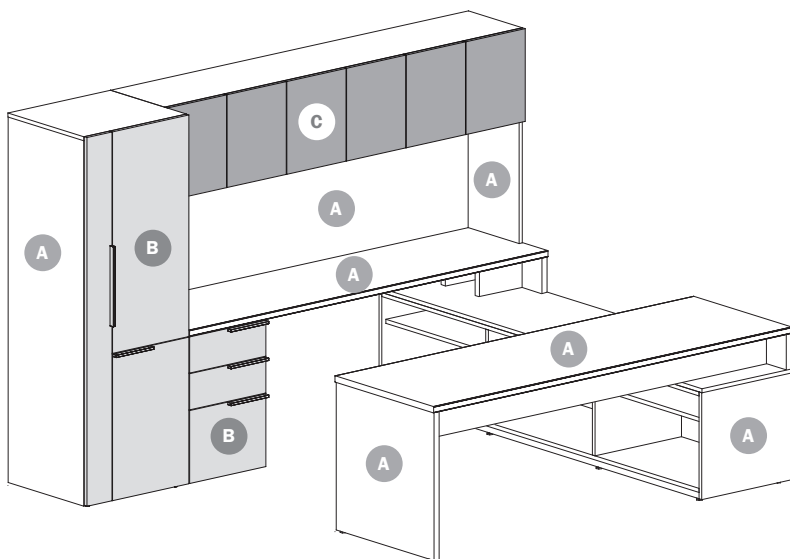

Veneer Surface Options

- A = Worksurface and Chassis**
Veneer – see page 5 for selection
- B = Drawer and Door Fronts**
 1. standard – same as chassis selection
 2. optional – paint color (vertical maple veneer substrate) – see page 5 for color selection
- C = Overhead and Worksurface Storage Doors**
 1. standard – same as chassis selection
 2. optional
 - a. paint color (vertical maple veneer substrate) see page 5 for color selection
 - b. white back painted glass doors in an aluminum frame – see page 31
 - c. markerboard laminate with silver PVC edge see page 31

Flux Desk Details

Pedestal Desks

Product Overview

The Flux pedestal desk is available with a break front or flush front. Options for wire management vary depending on the selected desk.

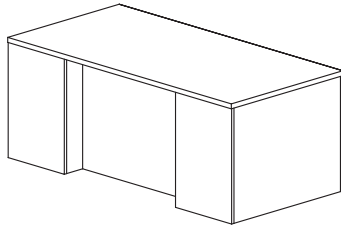

Break Front Desk

Pedestal access door optional

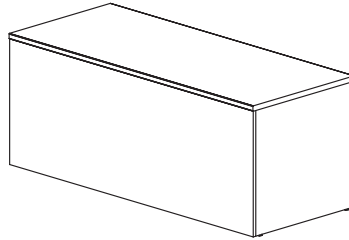

Flush Front Desk

Wire Manager Tray

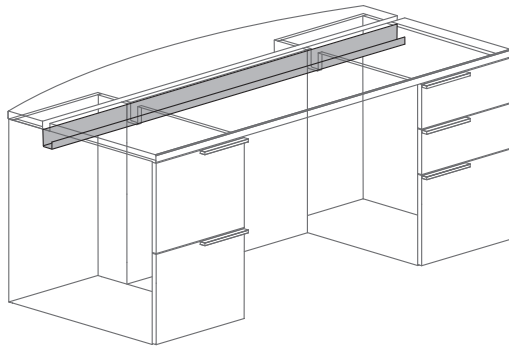

Desks with a split top have a continuous wire manager tray as a standard feature.

Note: desks do not have side end panel grommets.

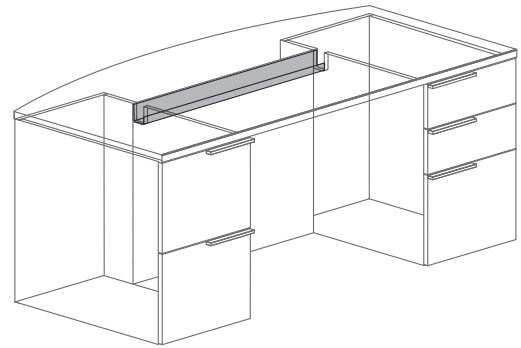

A wire manager tray can be ordered on desks with solid tops by optioning in the pedestal access door (available on break front desks) or by ordering a continuous wire manager tray.

Note: it is recommended that with either of these options, a top grommet be specified.

Pedestal Access Doors

Available on the front of break front desks to conceal cords.

Both right and left pedestals of desk will have the access door with this option.

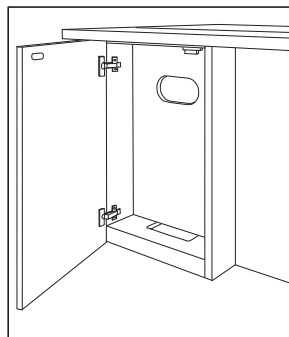

Flux Desk Details

Peninsula Desk with Secondary Credenza Support

Product Overview – Peninsula Desk

The Flux peninsula desk, which mounts to the top of a secondary height credenza for support, is available in a variety of top shapes and base styles. Edge profile and modesty panel options vary according to the style selected. Below are a few examples of top and base combinations.

PRODUCT INFORMATION

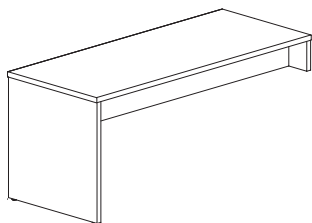

Rectangle Peninsula Table Desk with End Panel Support

Eased Edge only
Partial Modesty Panel standard

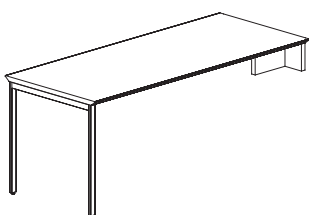

Rectangle Peninsula Table Desk with End Leg Assembly

Reverse Bevel Edge optional
Partial Modesty Panel optional

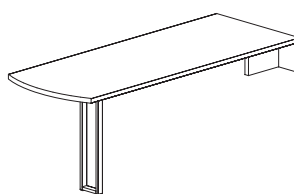

Arc End Peninsula Table Desk with Frame Base

Reverse Bevel Edge optional
Partial Modesty Panel optional

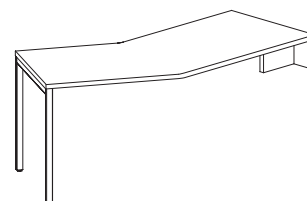

Boomerang Peninsula Table Desk with End Leg Assembly

Reverse Bevel Edge optional
Partial Modesty Panel optional

Product Overview – Secondary Height Credenza

The peninsula desk mounts to – and must be specified with – a secondary height credenza with an open compartment or sliding door compartment. See secondary height credenzas on pages 188-211 for pricing.

Secondary Credenza Examples

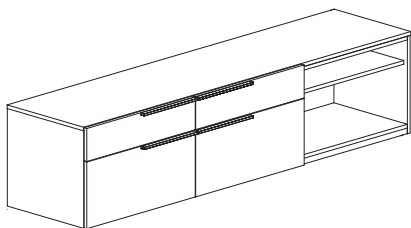

open compartment

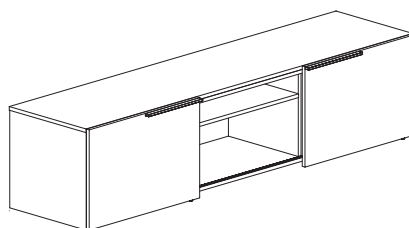

sliding door compartment

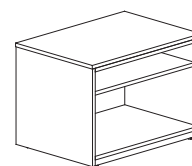

open compartment

Layout Requirements

27 1/2" desk can pair with any open compartment. 33 1/2" desk pairs with an open compartment 32" or greater in width.

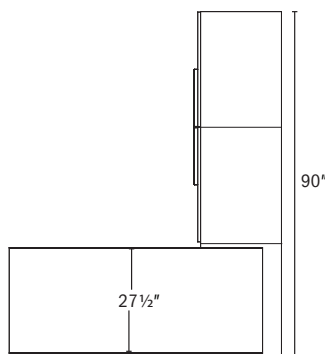

90" w credenza:
use 27 1/2" d desk

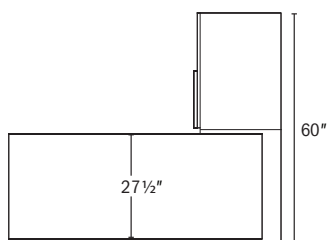

60" w credenza:
use 27 1/2" d desk

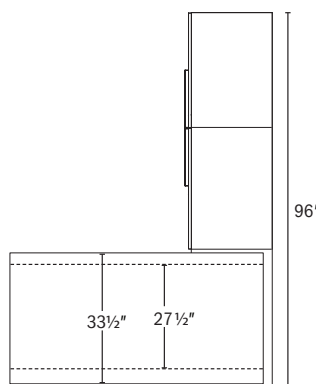

96" credenza:
use 27 1/2" d or 33 1/2" d desk

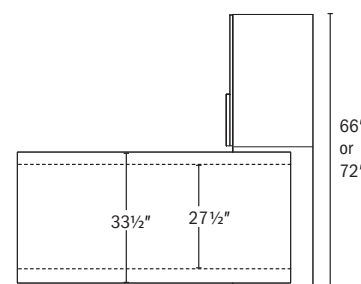

66" or 72" credenza:
use 27 1/2" d or 33 1/2" d desk

Flux Desk Details

Ordering the Secondary Height Credenza

When ordering the credenza, the mounting location for the peninsula desk must be specified as Left (L), Center (C) or Right (R), and the peninsula depth must be specified (22", 27 1/2" or 33 1/2"). A cut out for a power module in the credenza top may be specified by adding the letter E to the order code.

Mounting Code Table

Peninsula Depth	Left Mount	Center Mount	Right Mount	Left Mount with Power	Center Mount with Power	Right Mount with Power
22"	L22	C22	R22	L22E	C22E	R22E
27 1/2"	L28	C28	R28	L28E	C28E	R28E
33 1/2"	L34	C34	R34	L34E	C34E	R34E

Mounting Code Examples

L 28 = mounts **Left**, with a **27 1/2"-deep** peninsula desk

C 28 = mounts **Center**, with a **27 1/2"-deep** peninsula desk

R 28 = mounts **Right**, with a **27 1/2"-deep** peninsula desk

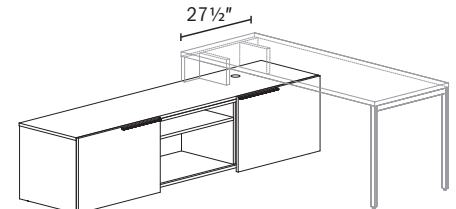
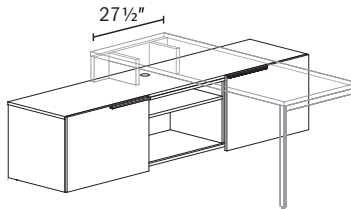
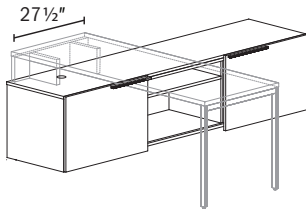

Technology Integration

Each mounting location comes with a 2 1/2"-diameter grommet for wire management. An EC26 power module cut out may also be added, and must be specified when ordering by adding the letter E to the mounting code. The power module must be ordered separately. See page 444.

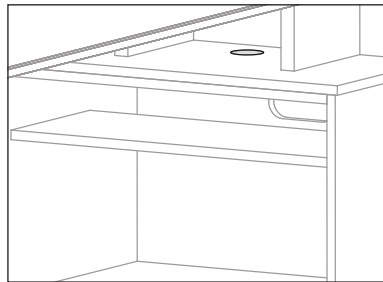

2 1/2"-diameter grommet

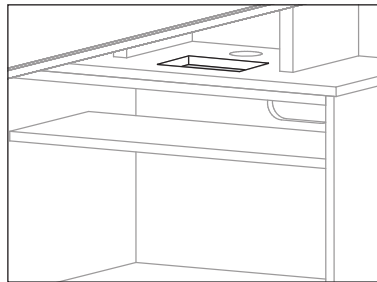

EC26 power module cut out

Power Module Cut Out Code

L 28 E

The grommet and EC26 power module locations are predetermined when selecting the peninsula mounting options; additional grommets or EC26 power modules can be specified at other locations on the secondary credenza. See page 45.

Flux Desk Details

Placement Locations

The peninsula desk may mount flush to the back panel of the credenza, or offset 5" to allow for an overhead hutch. Placement locations can be selected during field installation.

PRODUCT INFORMATION

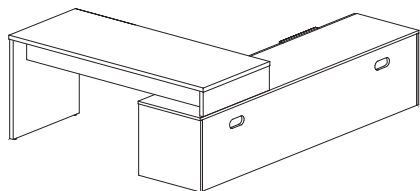

Placement 1 - Flush with Credenza Back

Can be used when no overhead storage is specified in the layout.

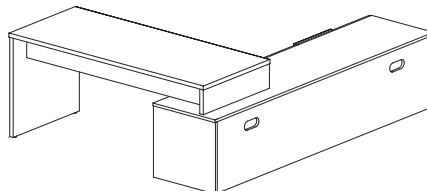

Placement 2 - Offset 5" from Back Panel

Must be used when placing an overhead on the secondary credenza.

Note: the overall foot print grows by 5"

Reverse Bevel Edge Rules

A reverse bevel edge adds 1 1/4" to the front of the desk top. Overheads that mount on the secondary credenza cannot be used with peninsula desks with reverse bevel edges. For more on edge profiles, see page 8.

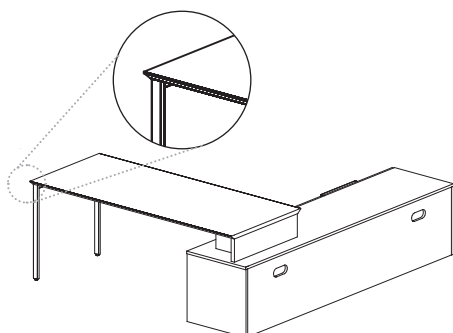

Peninsula desk with reverse bevel edge

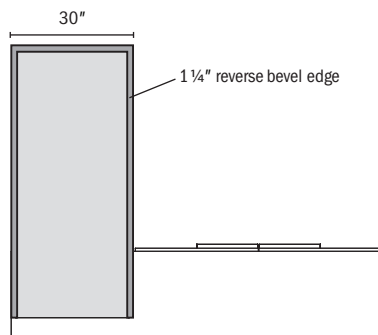

Plan view of peninsula with reverse bevel edge

Note: lacks required space for overhead mounting

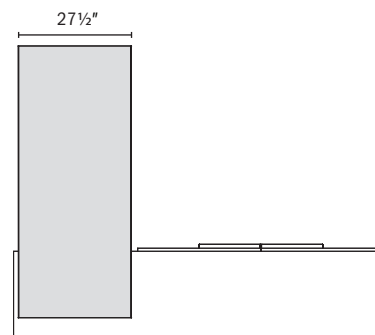

Plan view of peninsula with standard eased edge

Note: allows room for overhead mounting

Flux Desk Details

Run-off Desks

Product Overview

The Flux run-off desk, which mounts perpendicular to primary height credenzas, is available in a variety of top shapes and base styles. Edge profile and modesty panel options vary according to the style selected. Below are a few examples of top and base combinations.

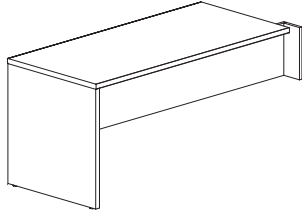

Rectangle Run-off Desk with End Panel Support

Eased Edge only
Partial Modesty Panel standard

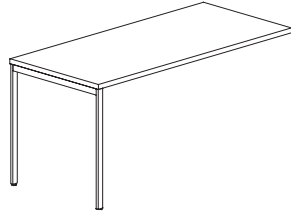

Rectangle Run-off Desk with End Leg Assembly

Reverse Bevel Edge optional
Partial Modesty Panel optional

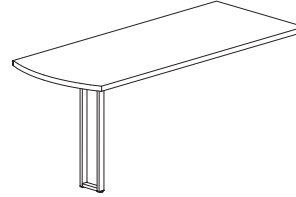

Arc End Run-off Desk with Frame Base

Reverse Bevel Edge optional
Partial Modesty Panel optional

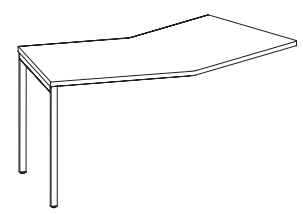

Boomerang Run-off Desk with End Leg Assembly

Reverse Bevel Edge optional
Partial Modesty Panel optional

Run-off Desk Attachment

The run-off desk mounts perpendicular to primary height units, and ships with two sets of brackets, for two types of credenzas attachments:

(1) Open Compartment Credenza

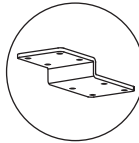
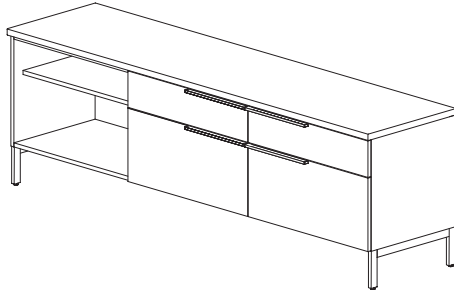

"Z" brackets

The run-off desk can be mounted to a credenza with open compartments. It attaches to the underside of the credenza with **"Z" brackets**. Run-off desks can not be mounted in sliding door compartments.

(2) Open Corner, Shell or Modular Credenza

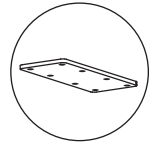
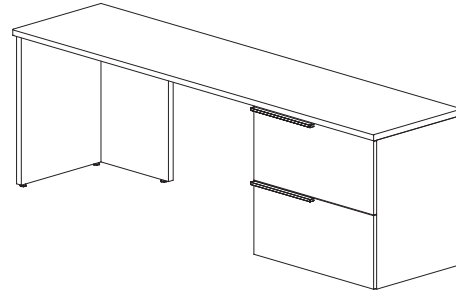

Flat brackets

The run-off desk can be mounted to an open corner credenza, credenza shell, or modular credenza. It attaches to the underside of the credenza with **flat brackets**. Use this type of credenza with run-off desks that have End Panel Supports with standard modesty panels.

Grain Direction

Grain direction runs "short" on run-off tops, though laminate tops longer than 60" run long grain. For more details, please reference grain direction on pages 11-13

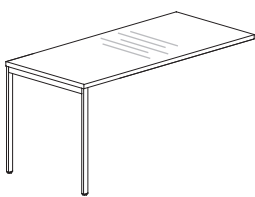

Short Grain

All veneer run-off tops
Laminate tops 60" or shorter

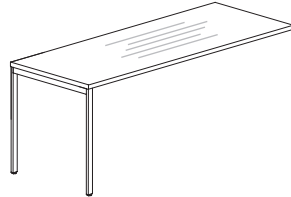

Long Grain

Laminate tops longer than 60"

Modesty Panels

13 1/2"-high hanging modesty panels are available for desks with End Leg Assembly or Frame Base. Desks with an End Panel Support come standard with an integrated modesty panel.

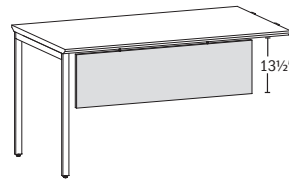

Hanging Modesty Panel

Optional for desks with metal bases

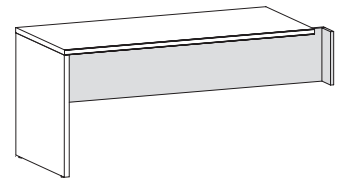

Integrated Modesty Panel

Standard with End Panel Support desks

Flux Desk Details

Adjustable Height Desks and Tables

Product Overview

Flux adjustable height desks and tables are available in a variety of top shapes and base styles, with pneumatic or electrical lift mechanisms. Metal finishes, wire management and modesty panel options vary according to the style selected. Below are various styles with adjustable height ranges.

PRODUCT INFORMATION

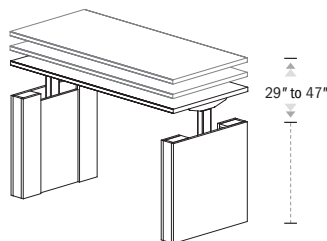

Adjustable Height Desks, Credenzas and Returns

Electrical lift mechanism
Adjustable range of 18"

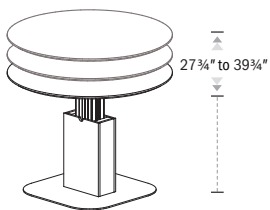

Adjustable Height Table Desks (meeting tables)

Electrical lift mechanism
Adjustable range of 18"
Round, square or rectangle shapes

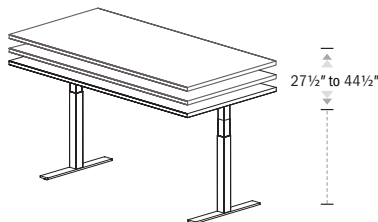

Adjustable Height Tables

Electrical or pneumatic lift mechanism
Adjustable range of 17"



Side Tables

Pneumatic lift mechanism
Adjustable range of 12"
Round, square or rectangle shapes
Nest with primary worksurfaces

Color Scheme

The finish on the adjustable lift column **A** will automatically be silver if you select Arctic Sliver or Soft Nickel metal. If Matte Black or Pewter metal is selected, the lift column **A** will be black.

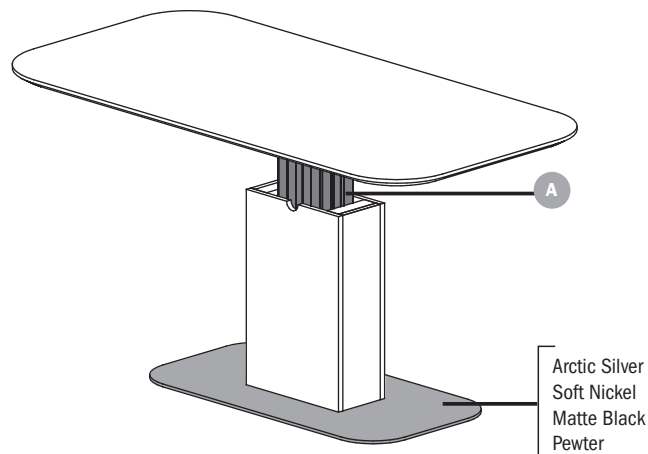
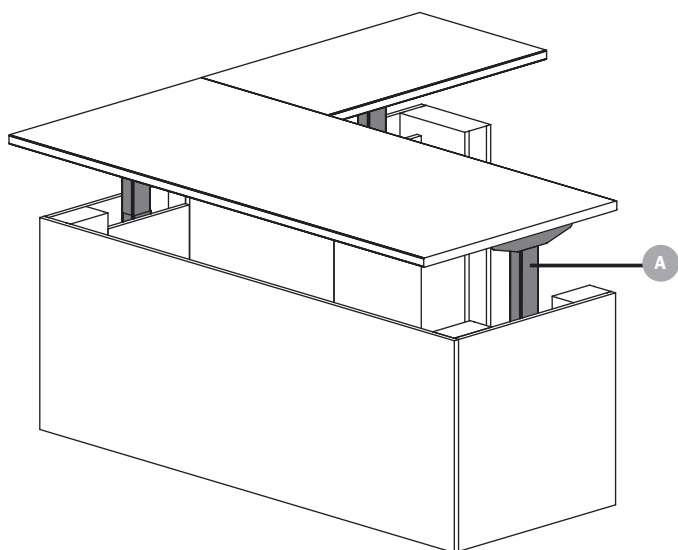

*Metal finishes on electric adjustable height tables available in Alloy or Matte Black.
Metal finishes on pneumatic adjustable height tables available in Stardust Silver or Black Sandtex.*

Flux Desk Details

Wire Management

Removable panels allow access to the lift columns and also provide wire management.

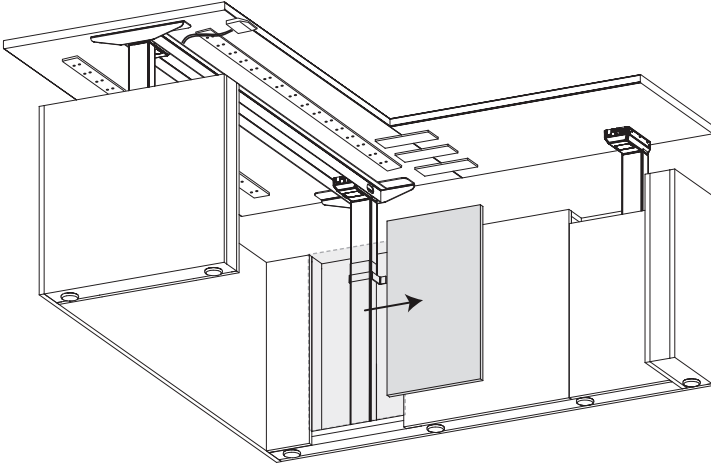

Removable panel shown from underside of adjustable height desk.

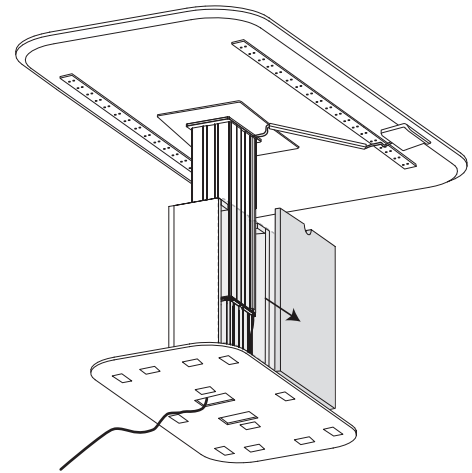

Electrical cord exits through the bottom side of the plate. Neoprene leveling pads allow the cord to lay flat.

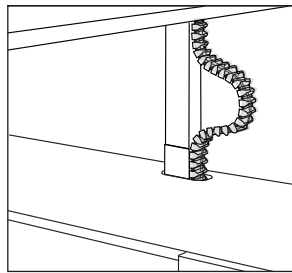

A flexible wire manager is included on adjustable desks, returns and credenzas.

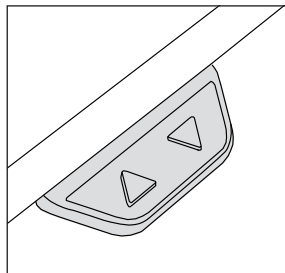

Controller can be mounted anywhere along top perimeter.

Optional Modesty Panel

An optional modesty panel can be added to an adjustable height desk or table desk.

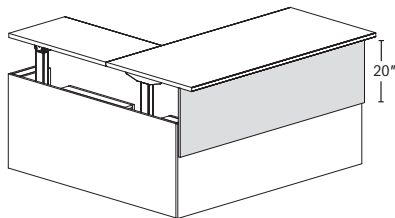

Adjustable Height Desk
Modesty panel mounts to the front of desk with overhang.

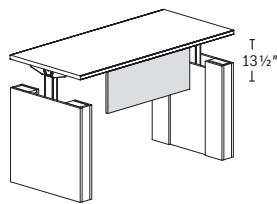

Adjustable Height Table Desk
Modesty panel mounts in between the end panels.

Nesting Side Table

Adjustable height side tables are designed to nest with primary height worksurfaces.

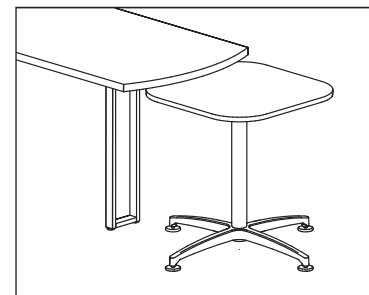

Flux Product Details

Credenzas

Product Overview

The Flux credenza is available as a 29 1/4" primary height credenza, or as a shorter, 21 1/4" secondary height credenza. Both heights come in three base styles as shown below.

PRODUCT INFORMATION

Primary Height

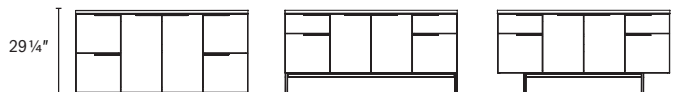

29F

Primary height
Extends to the floor

29L

Primary height
Elevated on legs

29S

Primary height
Elevated on inset legs

Secondary Height



21F

Secondary height
Extends to the floor

21L

Secondary height
Elevated on legs

21S

Secondary height
Elevated on inset legs

Drawer Alignment

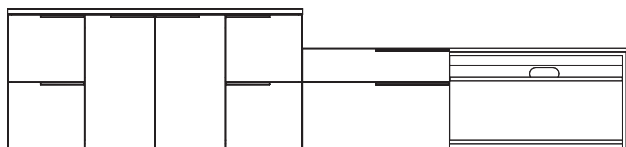

Drawers align between primary and secondary heights.

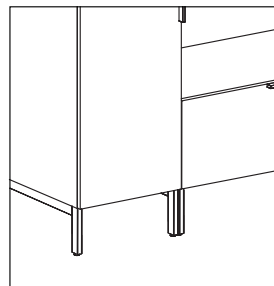

Legs pair up with adjacent units.

Credenza Oval Grommet Rules

Oval grommets for wire management are standard in all storage credenzas. Oval grommets in back panels can be eliminated upon request at no upcharge. Oval grommets are not offered in kneespace credenzas, open corner credenzas, modular pedestals, and pedestals under 18"w.

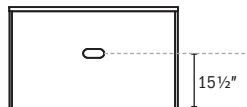
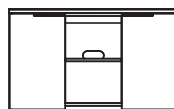
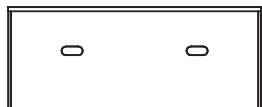
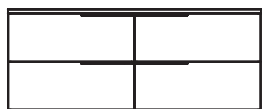
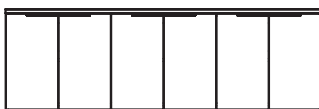

2 Grommets

Credenzas 60"w or greater with multiple storage compartments or drawer stacks have 2 grommets

1 Grommet

Credenzas under 60"w have 1 grommet

Flux Product Details

Credenza Options

Modesty Panel

A modesty panel can be added as an option to Kneespace and Open Corner Credenzas. A partial modesty panel, full modesty panel or removable modesty panel are available.

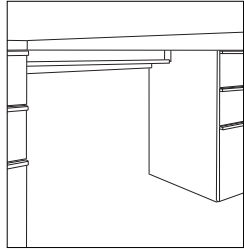

Standard without modesty panel

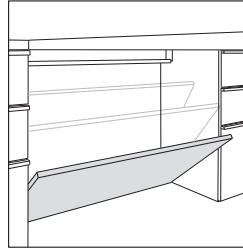

Removable modesty panel

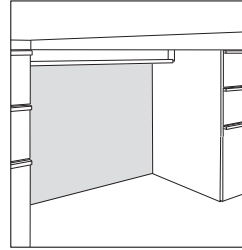

Fixed full height modesty panel

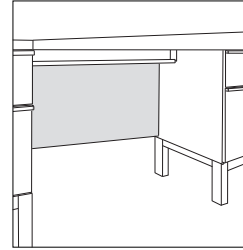

Fixed full height modesty panel with legs

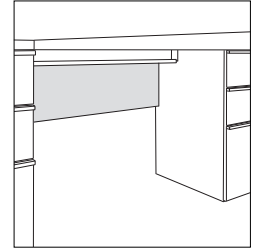

Fixed partial modesty panel

Concealed Drawers

Concealed drawers are available on credenzas with box/lateral file drawer configurations. This offers one continuous front.

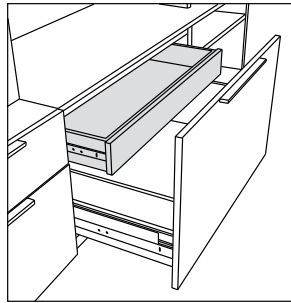

Trash Cans

Primary height credenzas with 18" wide hinge door storage can be outfitted with a trash can.

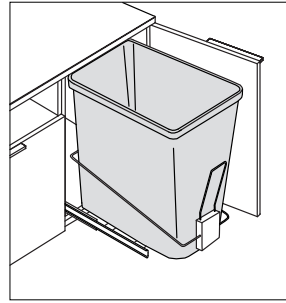

Seat Cushions

Seat Cushions are available in Rectangle, Oval, Square and Round and can be ordered separately for use on secondary credenzas.

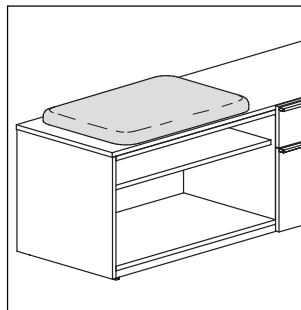

Rectangle seat cushion

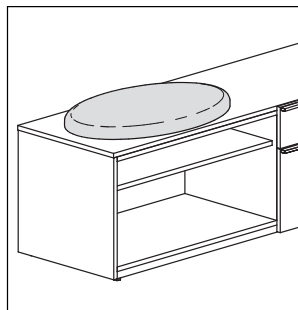

Oval seat cushion

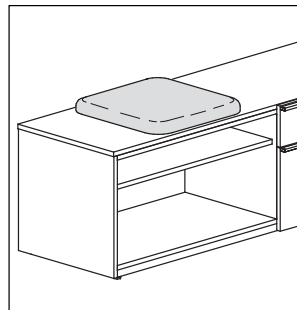

Square seat cushion

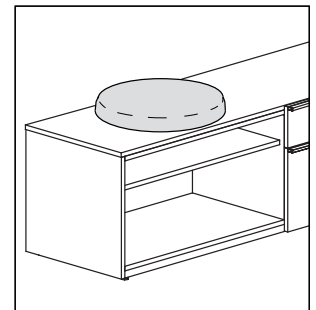

Round seat cushion

Flux General Options

Credenza Interior Compartment Heights

Primary height credenzas (29 1/4" h)

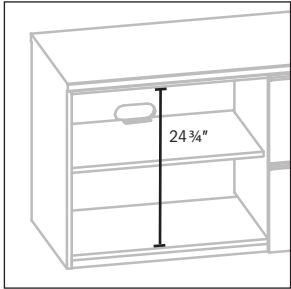

29F side compartment

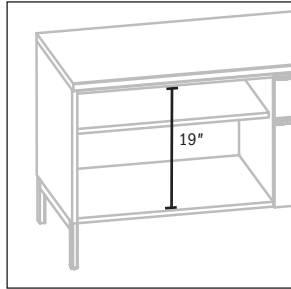

29L & 29S side compartment

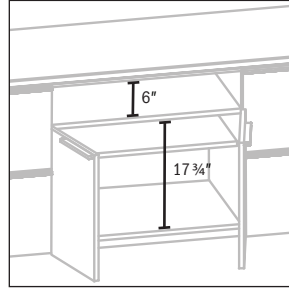

29F middle compartments

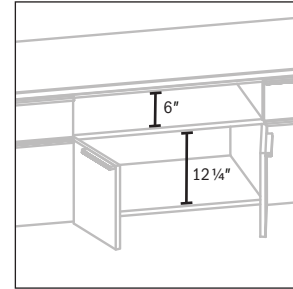

29L & 29S middle compartments

Secondary height credenzas (21 1/4" h)

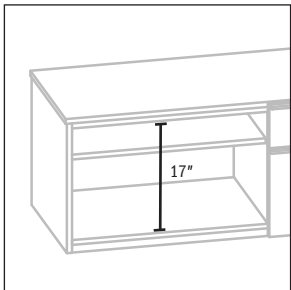

21F side compartment

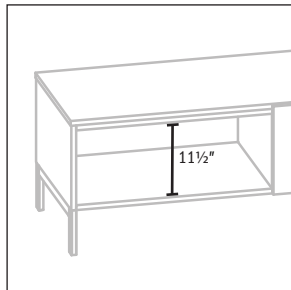

21L & 21S side compartment

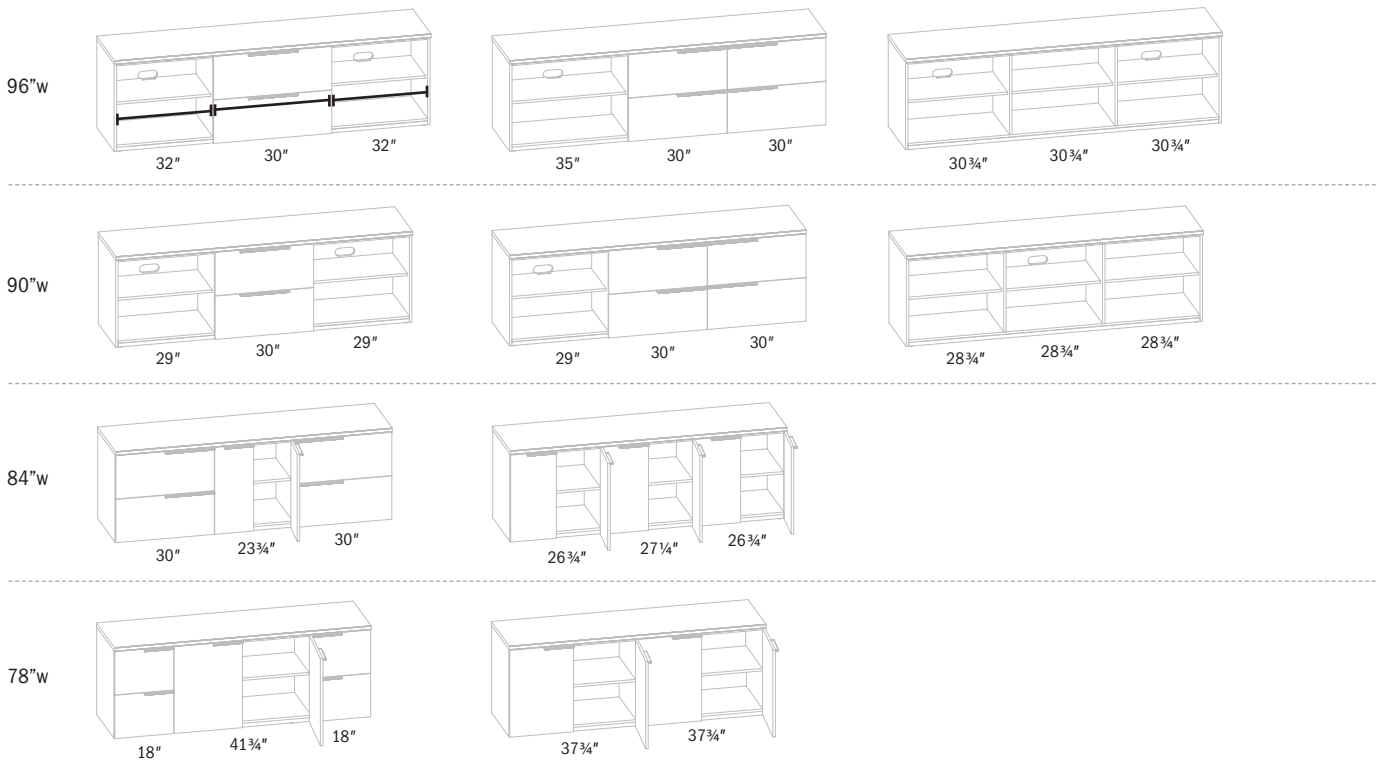

Credenza Interior Compartment Widths



PRODUCT INFORMATION

Flux General Options

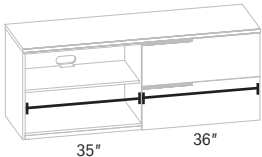
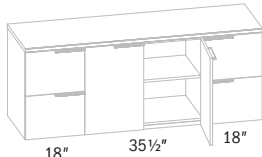
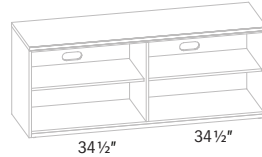
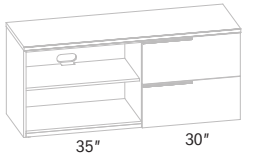
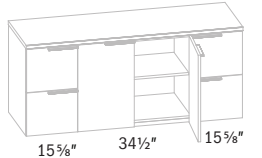
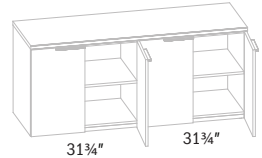
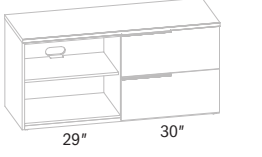
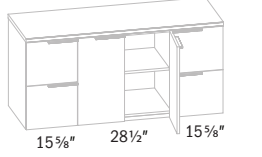
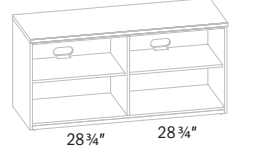
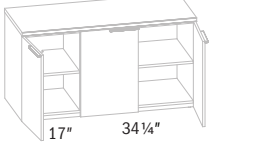
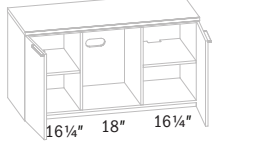
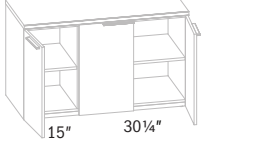
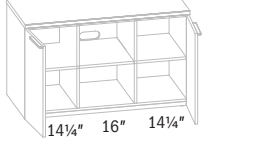
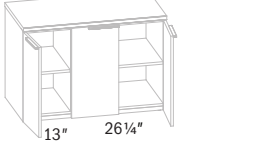
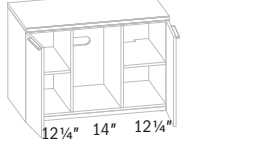
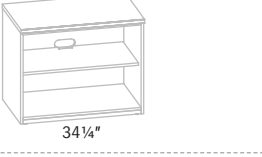
Credenza Interior Compartment Widths (continued)

72"w			
66"w			
60"w			
54"w			
48"w			
42"w			
36"w			
30"w			

Credenza Interior Depths
 Standard shelf depth = 18"
 Interior cabinet depth = 20 1/4"

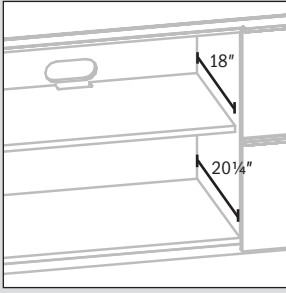

PRODUCT INFORMATION

All dimensions are rounded down to the nearest quarter inch. Call Customer Service if exact dimensions are needed.

Flux Product Details

Overhead Cabinets, Wall Mount Overheads and Wall Panel Stack-ups

Product Overview

Flux overhead cabinets, wall mount overheads and wall panels, when combined with lower storage, create an overall height of 69 ¼" or 81 ¼". Overhead cabinets are available in three heights: 40", 48" or 52". Wall mount overheads are available in two heights: 17" or 29" (add ¼" to overall height for self-pull). Wall panels are available in four heights to accommodate various combinations of use to create the overall height of 69 ¼" or 81 ¼". Wall panels include laminate, veneer, tackboard, markerboard, magnetic glass, and workwall panels.

PRODUCT INFORMATION

Overhead Cabinets (side view)

Wall Mount Overheads (side view)

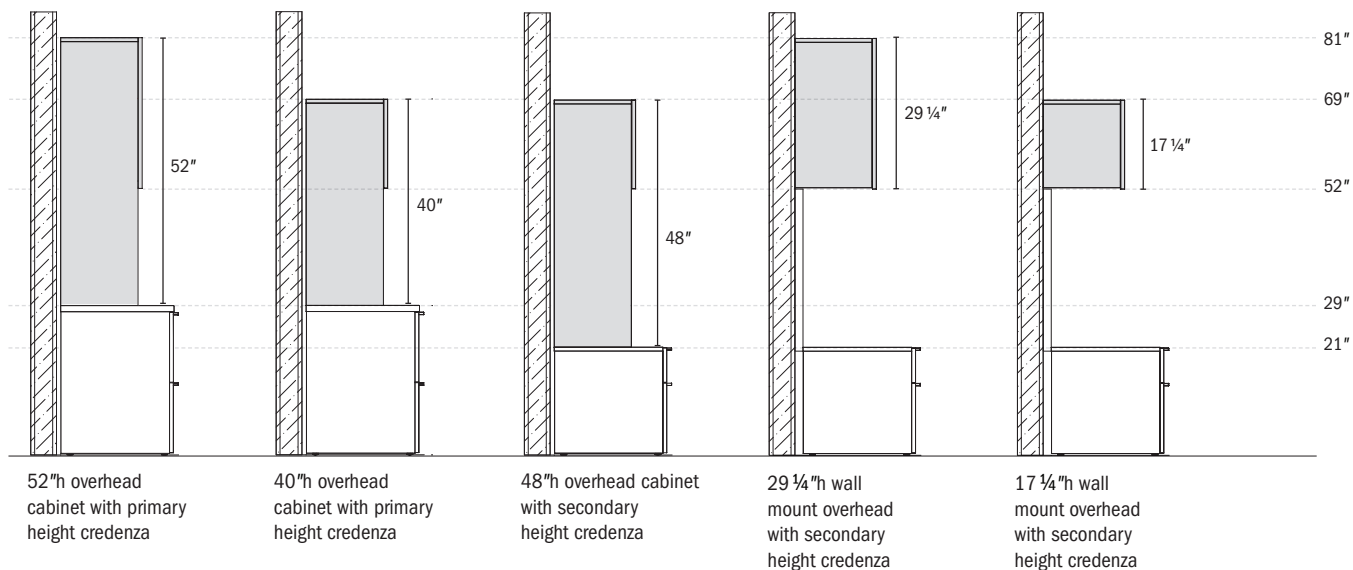

Wall Panels (side view)

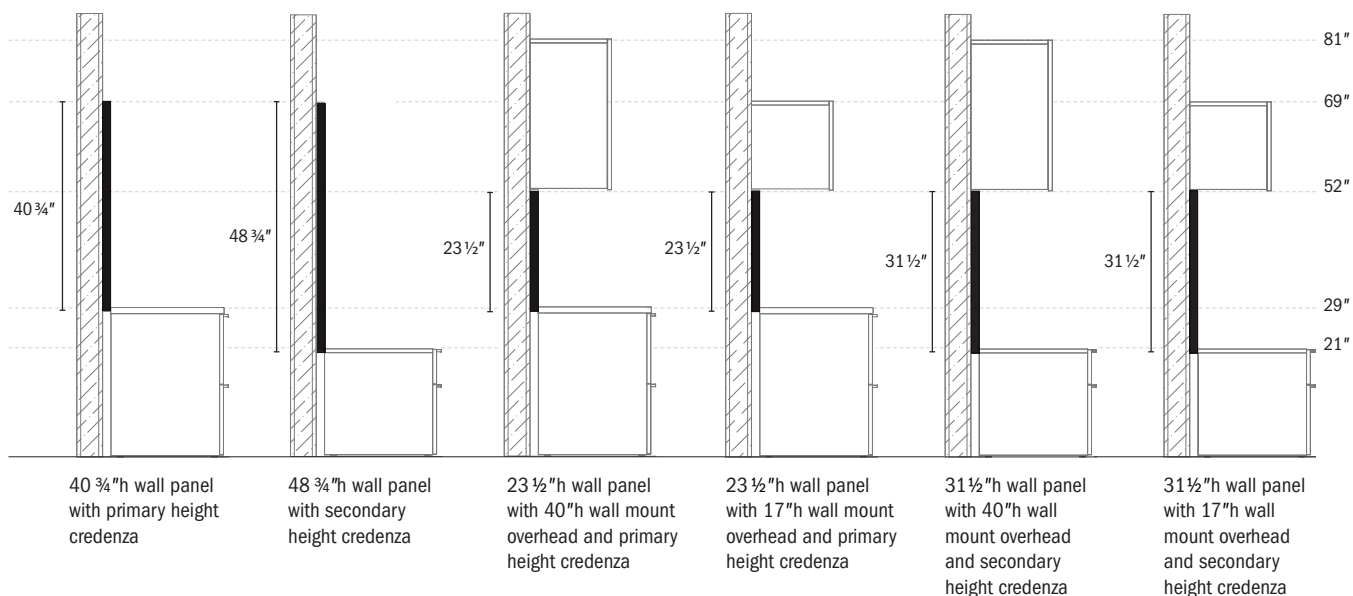

Flux Product Details

Wall Panel Installation

Proper installation when using wall panels will result in proper alignment.

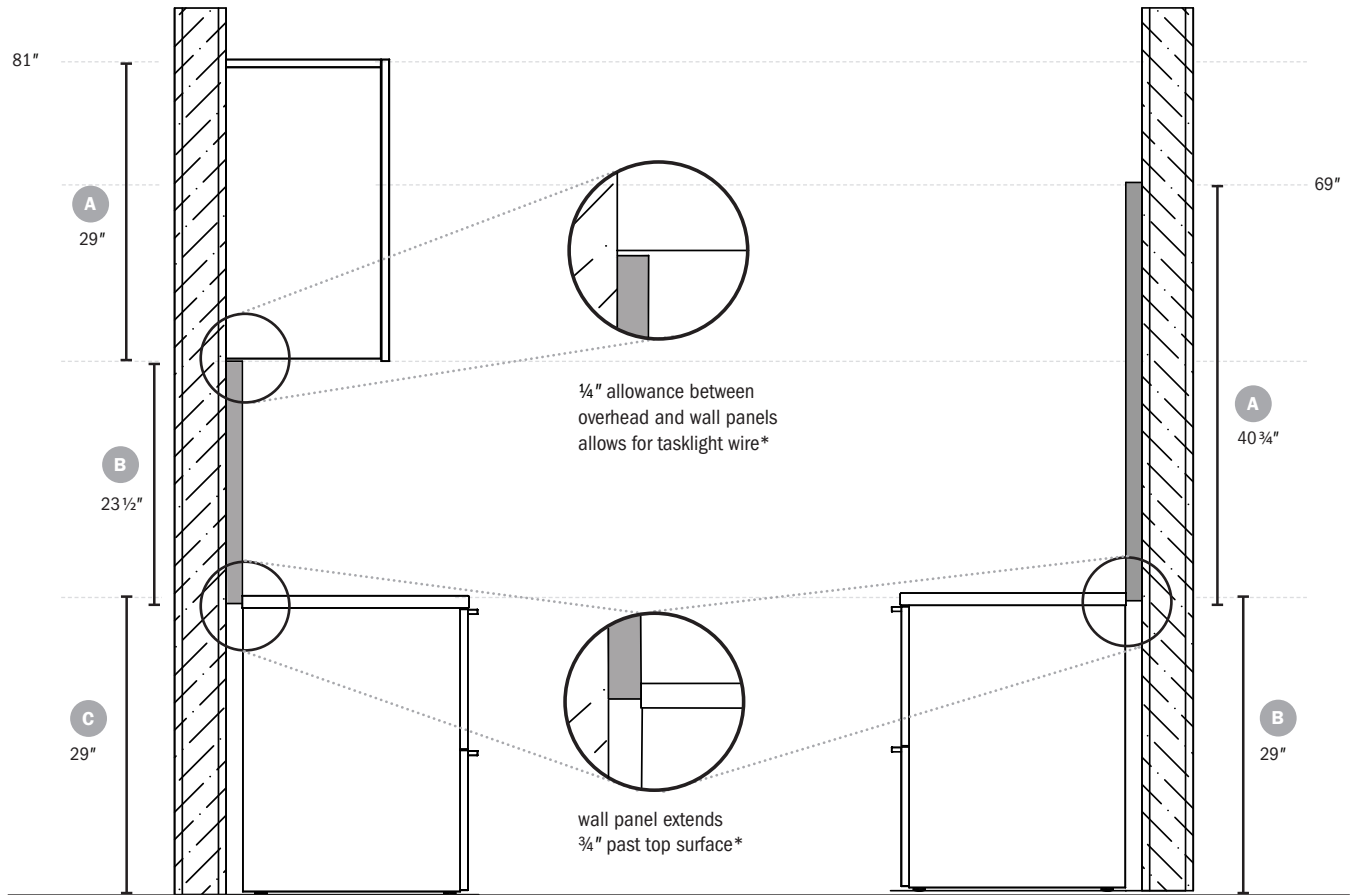

PRODUCT INFORMATION

	Height	Notes
A	29.00" wall side	29.25" overall with extended door for self pull
B	23.50" overall	0.75" of panel extends past the credenza
C	29.00" overall	
	81.50"	
	+ .25" between overhead and wall panel	
	- .75" extended panel	
	81.00" finished height	

	Height	Notes
	40.75" overall	0.75" of panel extends past the credenza
	29.00" overall	
	69.75"	
	- .75" extended panel	
	69.00" finished height	

*For correct alignment with other Flux components, these allowances must be factored into mounting of the overheads and wall panels during installation (instructions included).

Flux Product Details

40" Overhead Stack-up Options (with Primary Height Credenza)

A 40" overhead may be composed of: **A** storage cabinets/towers, **B** wall mount overheads paired with wall panels or **C** tall wall panels, creating an overall unit height of 69" when added to a primary height credenza.

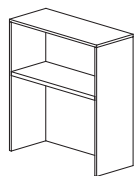
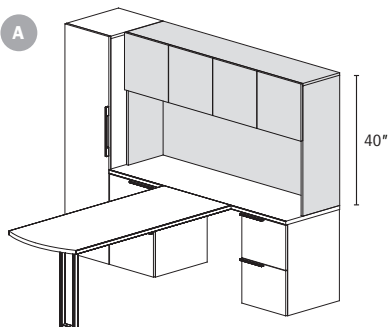

Open Storage Cabinet

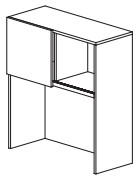

Sliding Door Cabinet

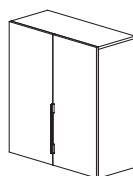

Hinged Door Storage Tower

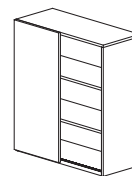

Sliding Door Storage Tower

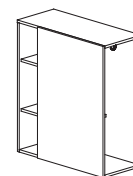

Side Wardrobe with Open Shelf

See pages 314-323 and 396-399 for additional storage cabinet and tower options.

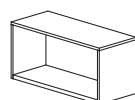
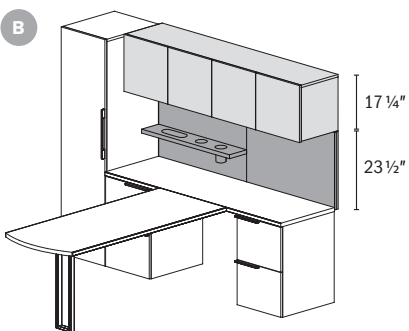

Open Storage

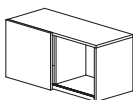

Sliding Door

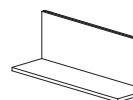

Shelf

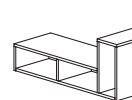

Cubby

See pages 321-335 for additional wall mount overhead options.

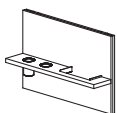

Panel with Accessory File Shelf

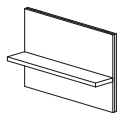

Panel with Mini Shelf

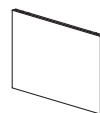

Wall Panel (laminite, veneer, tack panel, markerboard or glass)

See pages 340-343 and 352-355 for additional wall mount wall panel options.

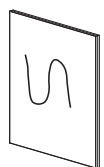
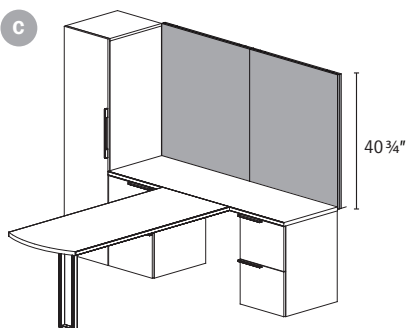

Markerboard



Glass Markerboard



Tack Panel

See pages 336-339 for additional wall mount wall panel options.

Flux Product Details

Double Height Overhead Stack-up Options (with Primary and Secondary Credenza)

A 52" overhead may be composed of: **A** double height storage cabinets/towers, or **B** double height wall mount overheads and wall panels, creating an overall unit height of 81" when added to a primary height credenza. A 60" overhead composed of **C** double height wall mount overheads and wall panels can create an overall unit height of 81" when added to a secondary height credenza.

A

52"

Open Storage Cabinet Sliding Door Cabinet Hinged Door Storage Tower Sliding Door Storage Tower Side Wardrobe with Open Shelf

See pages 270-281 and 350-351 for additional double height storage cabinet and tower options.

B

29 1/4"

23 1/2"

Open Storage Sliding Door Shelf

Panel with Accessory File Shelf Panel with Mini Shelf Wall Panel (laminated, veneer, tack panel, markerboard or glass)

See pages 310-321 for additional wall mount overhead options.

See pages 340-343 and 352-355 for additional wall mount overhead options.

C

29 1/4"

31 1/2"

Open Storage Sliding Door Shelf

Panel with Accessory File Shelf Panel with Mini Shelf Wall Panel (laminated, veneer, tack panel, markerboard or glass)

See pages 310-321 for additional wall mount overhead options.

See pages 344-347 and 356-359 for additional wall mount wall panel options.

Flux Product Details

48" Overhead Stack-up Options (with Secondary Height Credenza)

A 48" overhead may be composed of: **A** storage cabinets/towers, **B** wall mount overheads paired with wall panels or **C** tall wall panels, creating an overall unit height of 69" when added to a secondary height credenza.

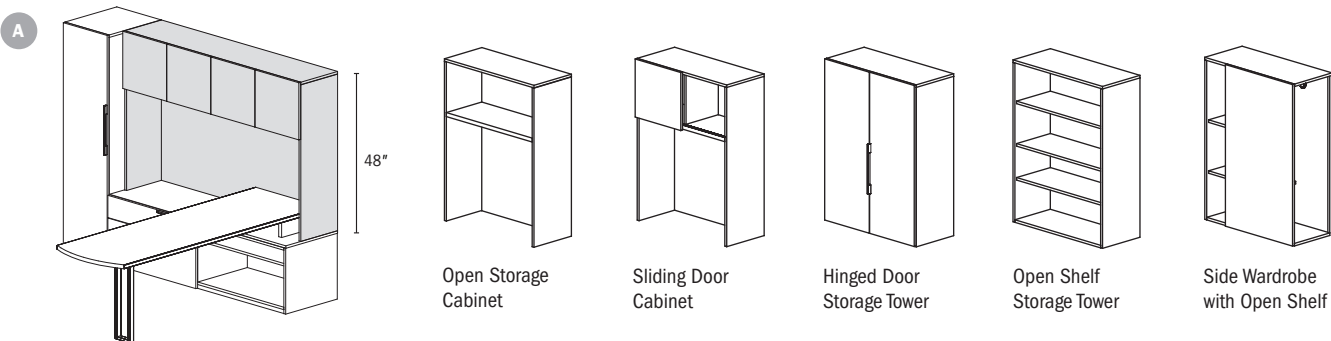

See pages 296-305 and 366-367 for additional storage cabinet and tower options.

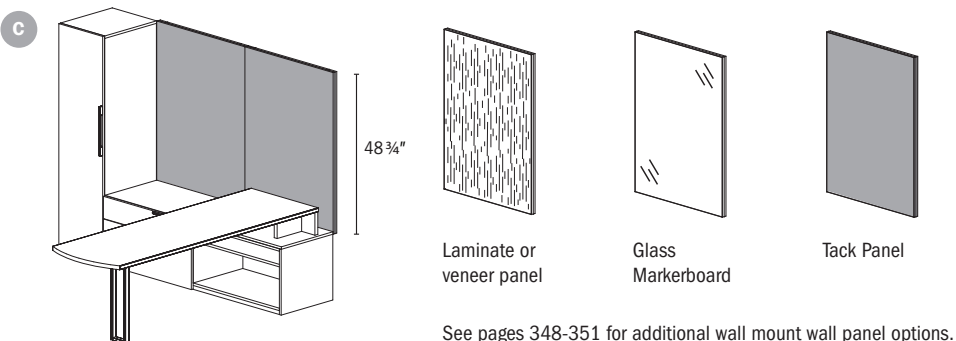
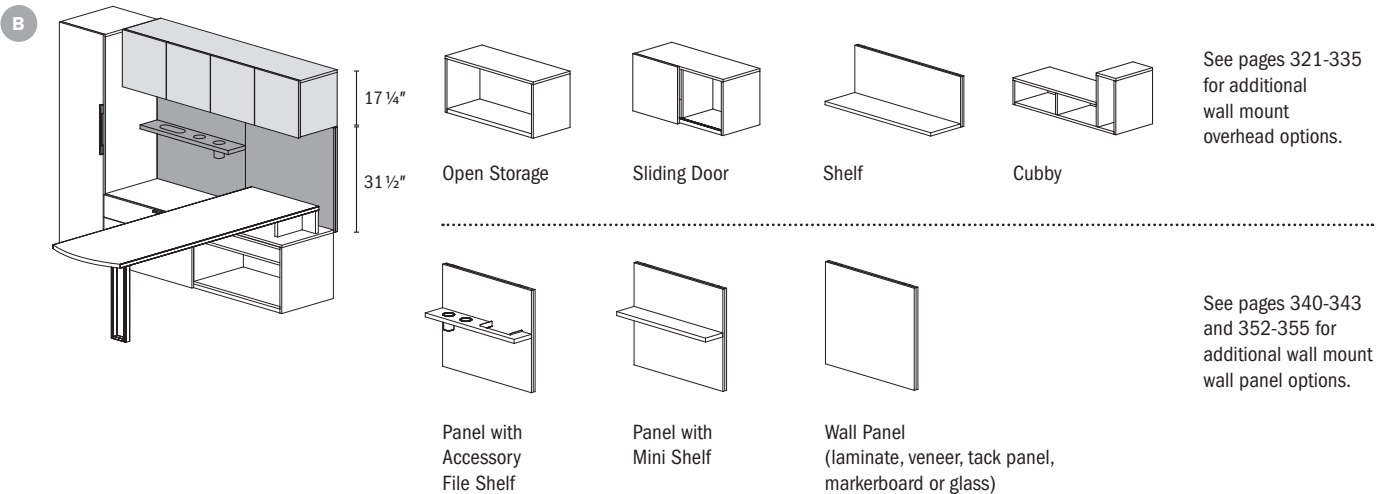

Flux Product Details

Overhead Options

Overhead Cabinet Doors

Contrasting door fronts, markerboard laminate fronts and white back painted glass fronts are available on overhead doors.

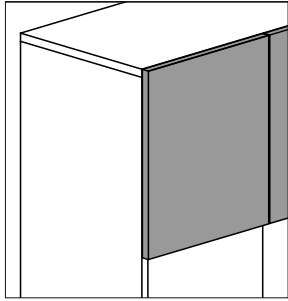

Contrasting laminate door fronts with any JSI standard laminate, or painted veneer fronts in JSI standard painted finishes.

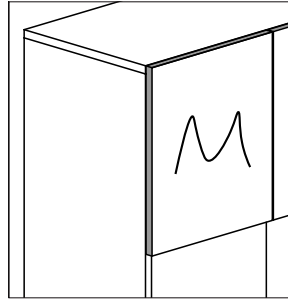

White markerboard laminate with silver vinyl wrapped door edges

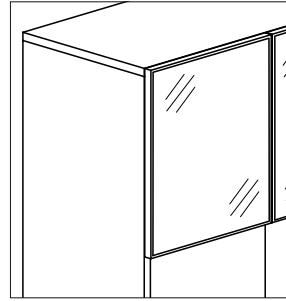

White back painted glass in a thin aluminum frame, with markerboard surface (locking not available on overhead with glass doors)

Overhead Cabinet Panels

Tackboard or laminate markerboard panels are available in overhead cabinets. Specify separately. Panels attach with dual lock fasteners.

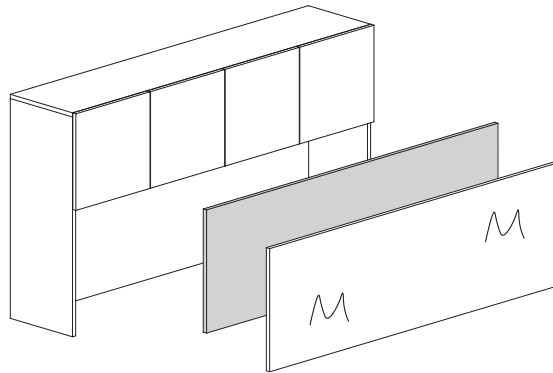

Tasklights

Flux tasklights are available for overhead cabinets. Specify separately. Grommet holes for wire management are $\frac{5}{8}$ " diameter for the Flux tasklight. Refer to the chart to the right for the recommended tasklight length according to overhead cabinet width.

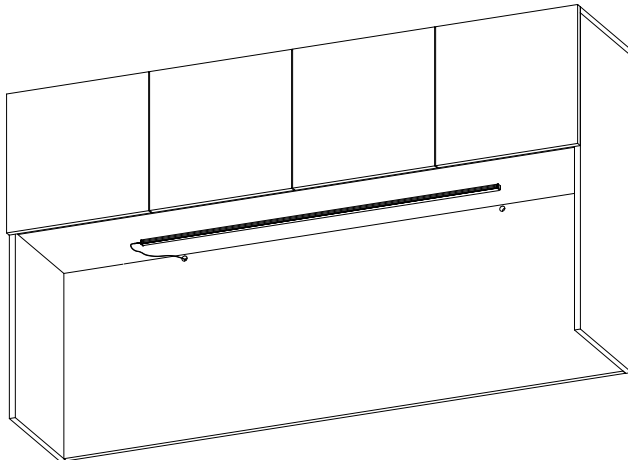

Overhead Width	Tasklight Model Number	Tasklight Length
96"	TL60LEDF	60"
90"	TL60LEDF	60"
84"	TL45LEDF	45"
78"	TL45LEDF	45"
72"	TL45LEDF	45"
66"	TL45LEDF	45"
60"	TL39LEDF	39"
54"	TL27LEDF	27"
48"	TL27LEDF	27"
42"	TL27LEDF	27"
36"	TL27LEDF	27"
30"	TL27LEDF	27"

Flux Product Details

Monitor Cabinets

Monitor cabinets allow a dual purpose layout: personal storage compartment and media compartment are available in various widths (96", 90", 84", 78", 72", 66", and 60") and configurations. Monitor cabinets should be used with primary height credenzas.

PRODUCT INFORMATION

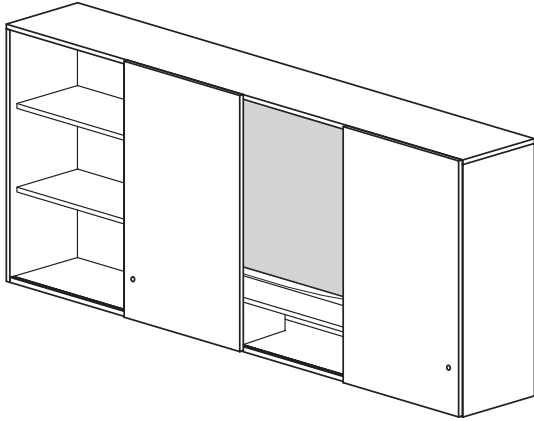

Center Monitor Cabinet

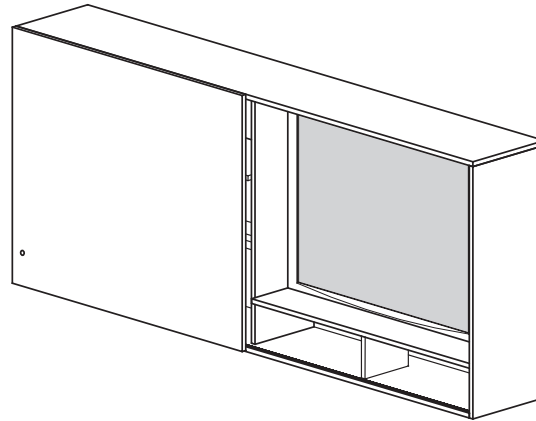

Right Monitor Cabinet

Center Monitor Cabinet Options

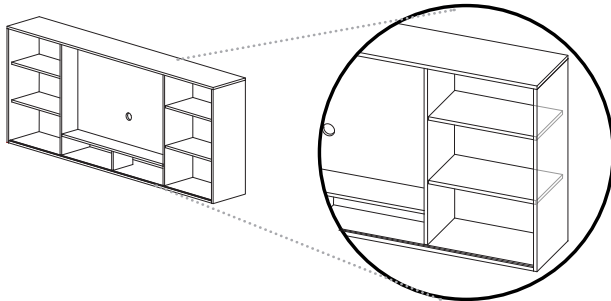

Center monitor with dual side shelf storage

Note: doors removed to show interior configurations

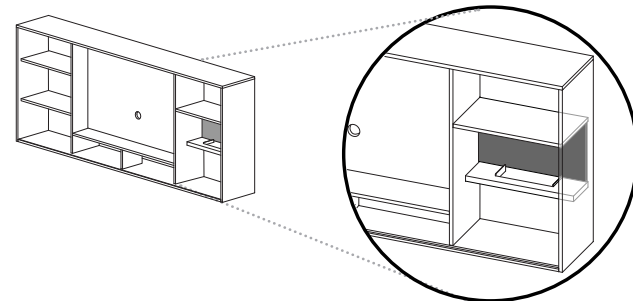

Center monitor with one side shelf storage and other side work-in-process storage (right or left), tackboard above filing shelf

Note: doors removed to show interior configurations

Flux Product Details

Right or Left Monitor Cabinet Options

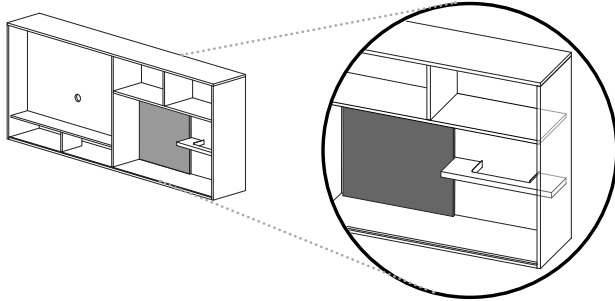

Right or left monitor with side work-in-process storage and side tackboard
Available only on 96", 90", and 84" cabinet widths

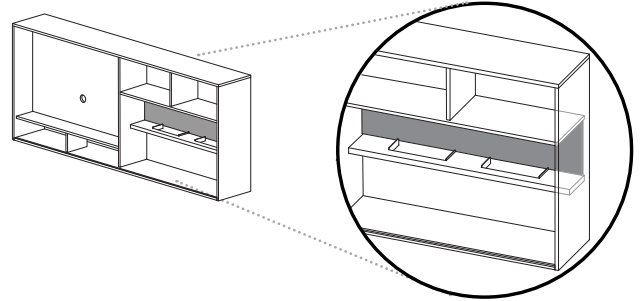

Right or left monitor with work-in-process storage and tackboard above filing shelf

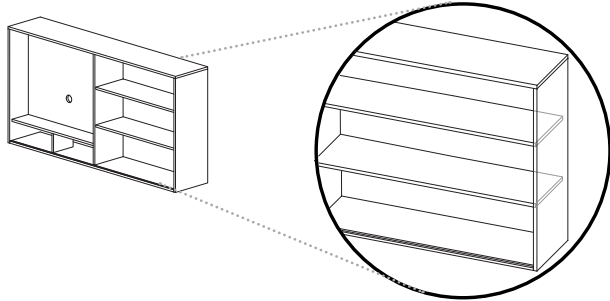

Right or left monitor with side shelf storage
Available only on 78", 72", 66" and 60" cabinet widths

Locking

Locks are standard on all sliding doors on monitor cabinets. Only the personal storage locations lock; monitor sections do not lock.

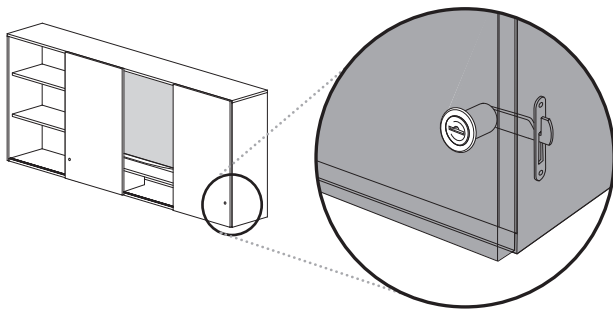

Compartment Sizes

Use the chart below to determine the maximum monitor size allowed.

Cabinet Width	Monitor Section Interior Width	Maximum Monitor Size
95 7/8"	48"	45"w x 29"h
89 7/8"	45"	42"w x 29"h
83 7/8"	42"	39"w x 29"h
77 7/8"	39"	36"w x 29"h
71 7/8"	36"	33"w x 29"h
65 7/8"	33"	30"w x 29"h
59 7/8"	30"	27"w x 29"h

Flux Product Details

Storage Cabinets and Wardrobes

Flux offers a large range of storage cabinets to align with primary height credenzas (18", 24", 30" and 36" widths; with 81 1/4" and 69 1/4" heights).

PRODUCT INFORMATION



Flux offers a large range of storage cabinets to align with secondary height credenzas (18", 24", 30" and 36" widths; with 81 1/4" and 69 1/4" heights).

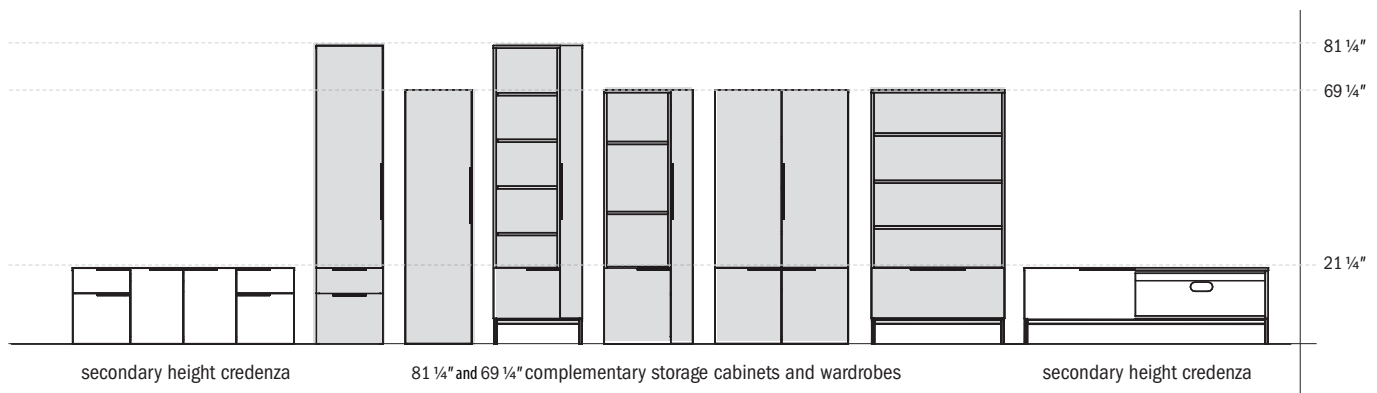

Fixed Shelf

All wardrobe cabinets with doors have a fixed shelf. All other shelves are adjustable.

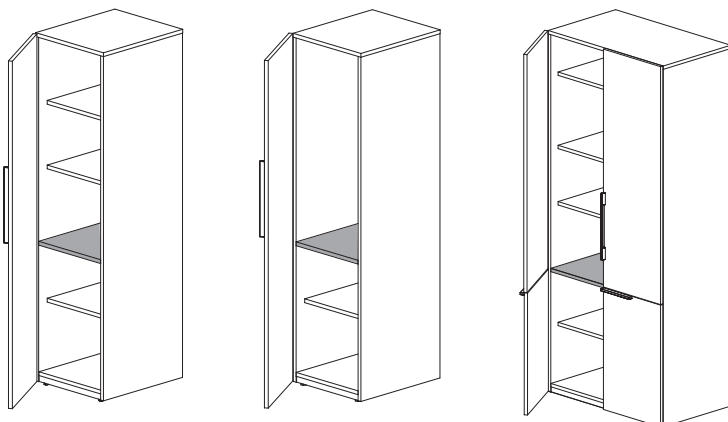

Flux Product Details

Vertical Storage Interior Dimensions

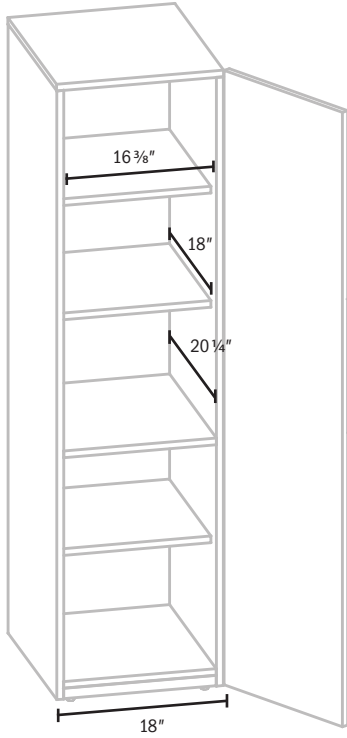

18" w full door storage cabinet

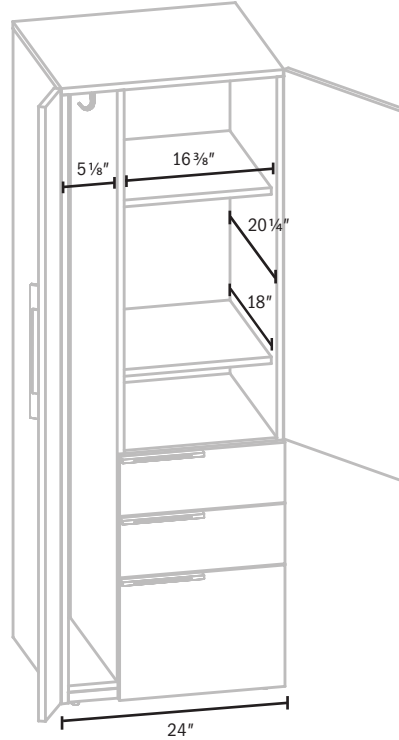

24" w side wardrobe with upper storage compartment

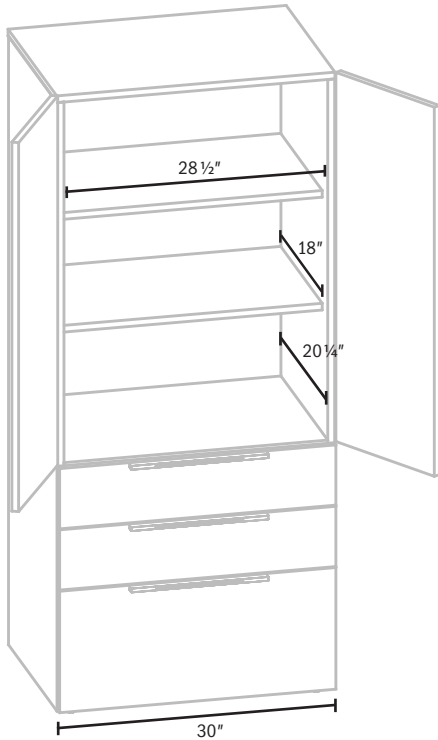

30" w upper storage compartment cabinet

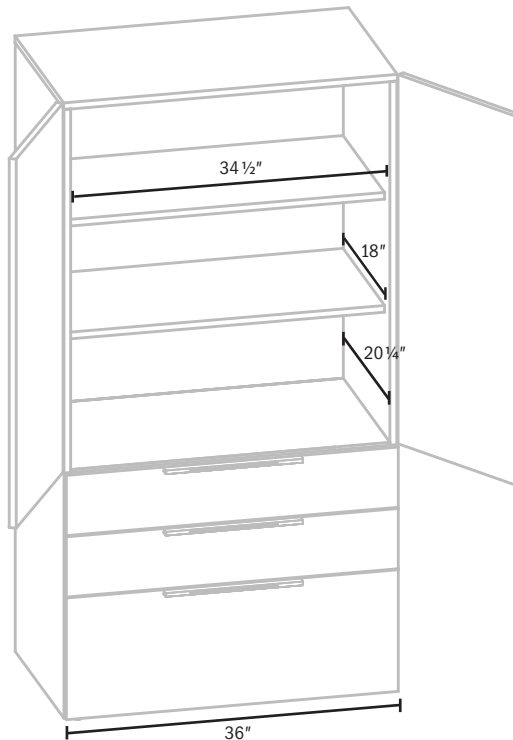

36" w upper storage compartment cabinet

Flux Product Details

Storage Cabinet and Wardrobe Options

Pantry Drawer

A pantry pull out drawer is a standard offering in storage cabinets and wardrobes without legs. Drawers are equipped with a support caster on the front underside of the drawer.

PRODUCT INFORMATION

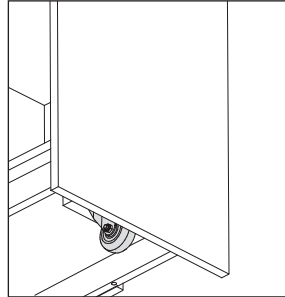
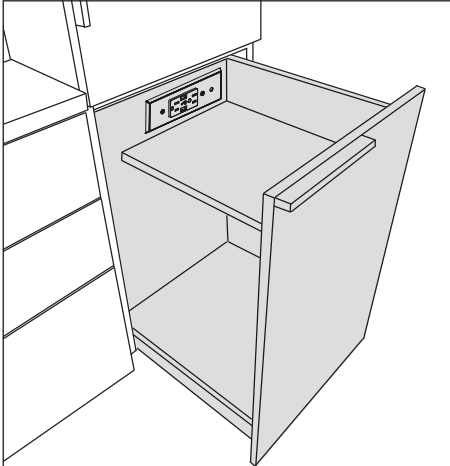

Underside of pantry pull out drawer highlighting support caster.

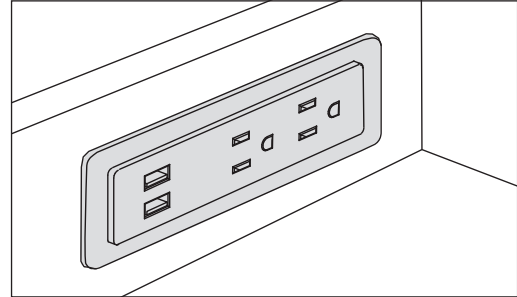

Optional electrical is available in the inside drawer and must be specified. Includes 2 grounded duplex and 2 USB charging outlets. Specify color.

Trash Cans

Storage Cabinets that work with primary height credenzas without legs, with lower hinge door storage, can be outfitted with a pull out trash can. Trash can is included.

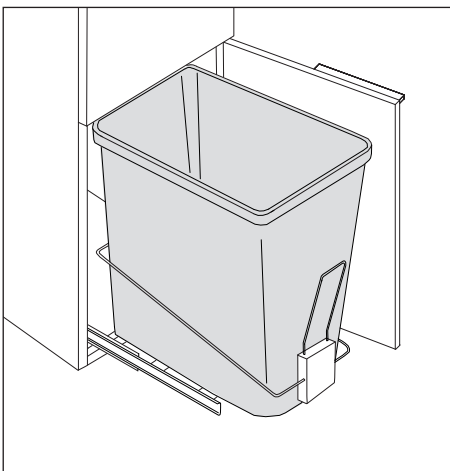

Flux Product Details

Modular Components

Modular items can be created by **(1)** adding tops to modular units or **(2)** using a credenza shell with a modular credenza shell pedestal. Hardware is included.

(1) Modular Top Construction

Example 1.1 - Open Corner Credenza

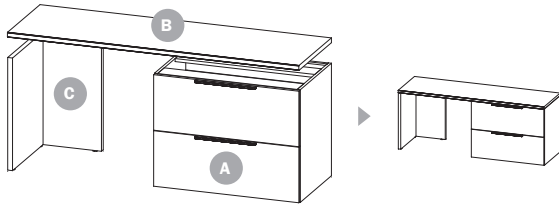

- A** = 36" w x 22" d modular lateral file
- B** = 72" w x 22" d modular primary height credenza top
- C** = 18" w x 22" d modular credenza wing end (left)
(Open spans over 48" require special consideration, consult with Customer Service)

Example 2.1 - Kneespace Credenza

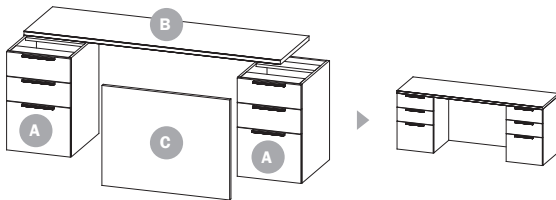

- A** = (qty 2) 18" w x 22" d modular pedestal
- B** = 72" w x 22" d modular primary height credenza top
- C** = 28" h x 36" w modular credenza modesty panel
(Open spans over 48" require special consideration, consult with Customer Service)

Example 3.1 - Storage Credenza

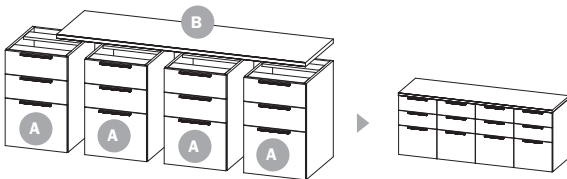

- A** = (qty 4) 18" w x 22" d modular pedestal
- B** = 72" w x 22" d modular primary height credenza top

Example 4.1 - Secondary Height Credenza

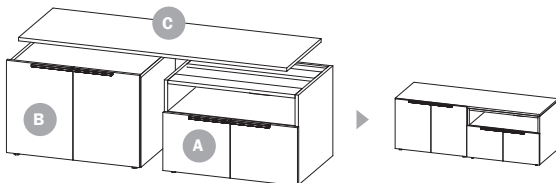

- A** = 30" w x 22" d modular hinged door storage with open shelf
- B** = 30" w x 22" d modular hinged door storage
- C** = 60" w x 21" d modular secondary height credenza top

(2) Credenza Shell Construction

Example 1.2 - Open Corner Credenza

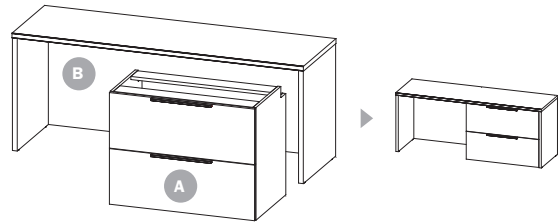

- A** = 36" w x 21" d modular credenza shell lateral file
- B** = 72" w x 22" d credenza shell
(Requires attachment to back of credenza and to underside of top)

Example 2.2 - Kneespace Credenza

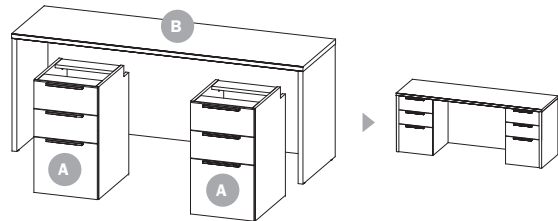

- A** = (qty 2) 18" w x 21" d modular credenza shell pedestal
- B** = 72" w x 22" d credenza shell
(Requires attachment to back of credenza and to underside of top)

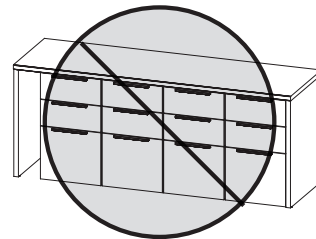

There is no combination of modular components that will allow a credenza shell to be filled between end panels; kneespace or open corner is required.

Flux Technology

Power Access and Wire Management

Breakfront Pedestal Desk U Unit

PRODUCT INFORMATION

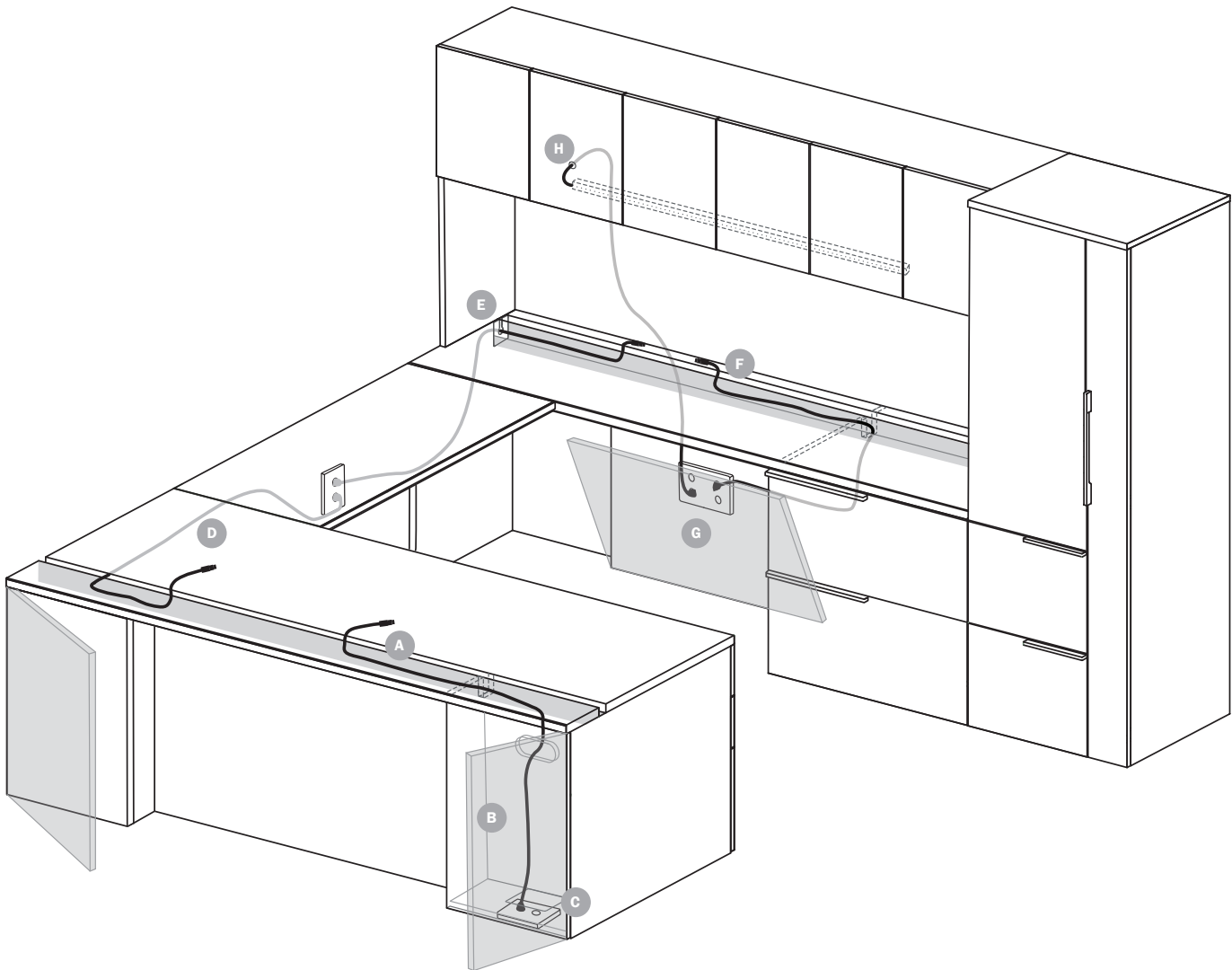

Wiring Paths

- A** = Split top allows wires to fall off at any location on the desk top
- B** = Pedestal access doors allow access to wiring or power supply
- C** = Hole in cabinet bottom allows for floor monument access
- D** = Wiring can be routed through the desk, under bridge and back to the credenza
- E** = End panel grommet in credenza allows wiring to exit the layout
- F** = Split top allows wires to fall off at any location on the credenza top
- G** = Optional removable modesty panel allows for access to wall electrical outlet
- H** = $\frac{5}{8}$ " holes in back panel allow TL-LED tasklight wires to be routed down the exterior of overhead back

Flux Technology

Power Access and Wire Management

Peninsula Desk with Secondary Storage

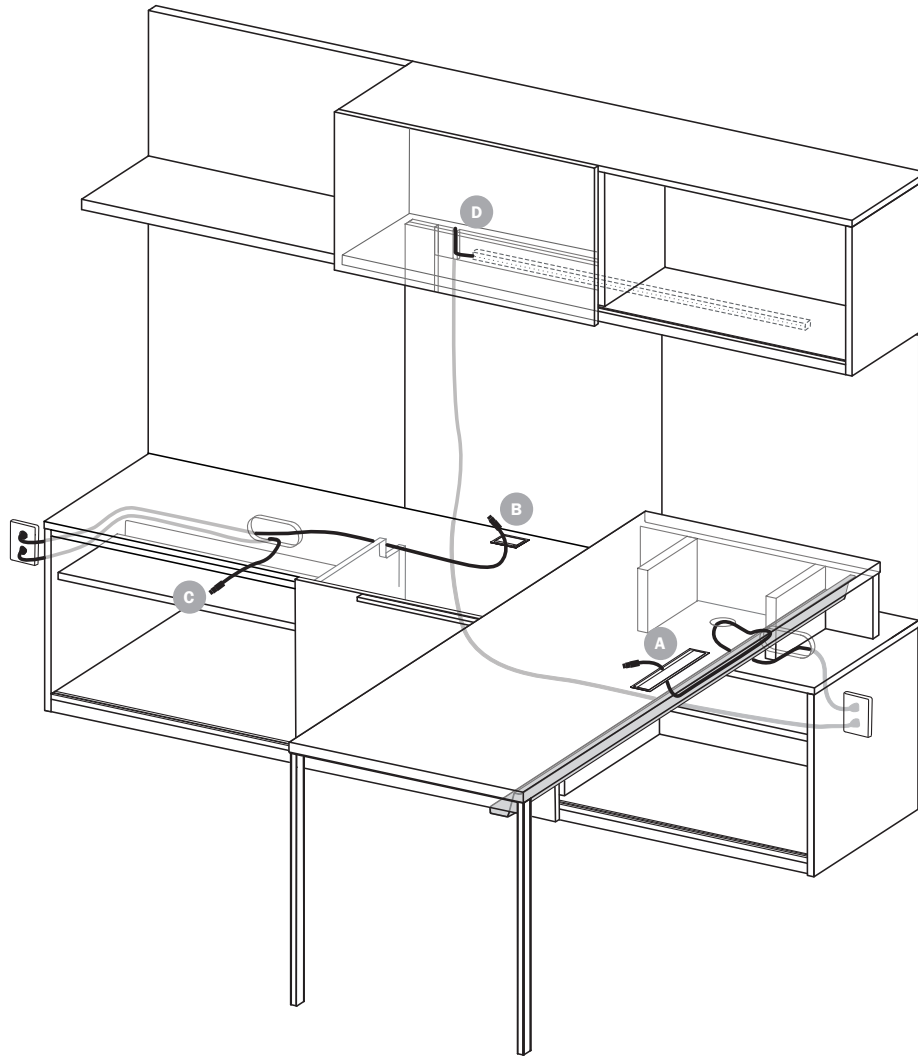

Adjustable Height Peninsula Desk with Secondary Storage

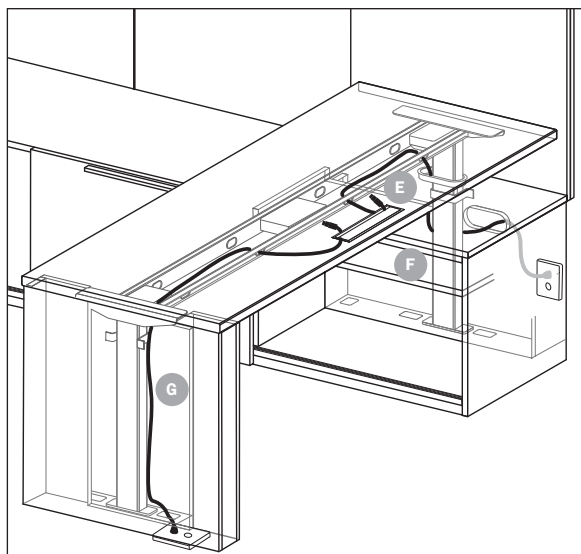

Wiring Paths

- A** = Optional 12" grommet allows wiring to run into optional wire channel, through the standard top credenza grommet and out the back panel's oval grommet
- B** = Optional 3" grommet allows wiring to enter the credenza compartment, move through the notched inside panels and out the back panel's oval grommet
- C** = Wiring for equipment can exit out the oval back grommet
- D** = Tasklight wiring can exit back side of the wall panels
- E** = Optional 12" grommet allows wiring to run into the adjustable height support rails then to a standard flexible wire manager into the lift mechanism compartment and out the back panel's oval grommet
- F** = Snap-on panel allows access to the lift mechanism compartment for access to the back oval grommet
- G** = Snap-on panel on the inside peninsula desk end allows access to the interior of the lift mechanism compartment to route wiring to floor monuments

Flux Technology

Grommets and Worksurface Power

PRODUCT INFORMATION

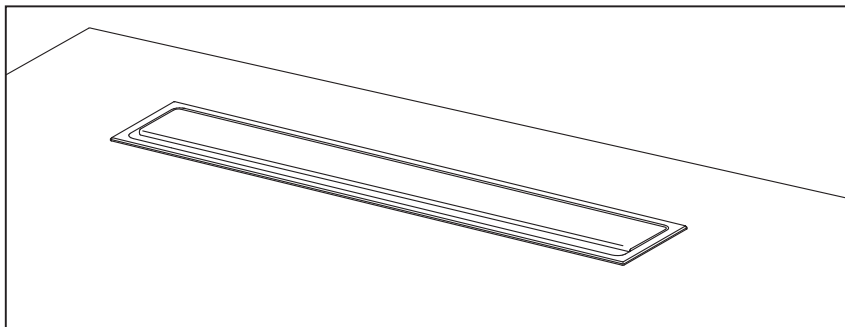
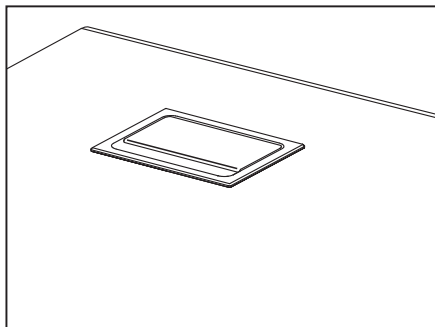

Optional Grommets

Flux offers two sizes of optional grommets: 3" (2½") and 12" (11½") grommets, available in arctic silver, soft nickel, matte black or pewter. Grommet locations are predetermined with a code; see the grommet and electrical locations in this section.

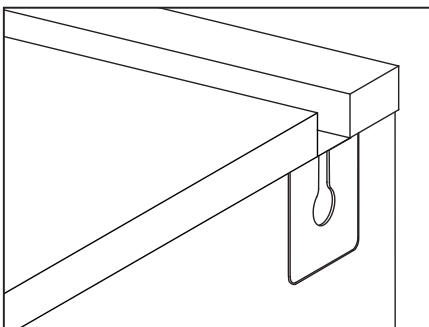
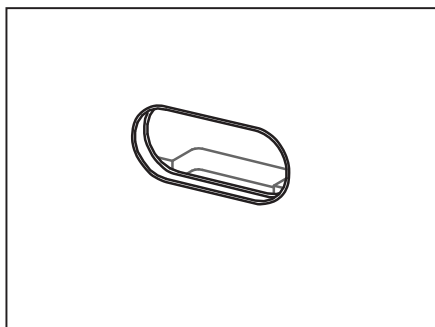

Oval Grommets

Oval grommets with a black trim ring are standard on the back of credenzas. See page 44 for actual location rules for the credenzas. These grommets can be eliminated at no charge. Must specify at the time of order entry.

Side Grommets

Magnetic side grommets are standard on credenza with split tops, and include an interior wire channel.

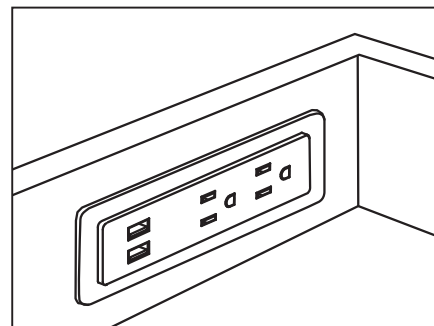
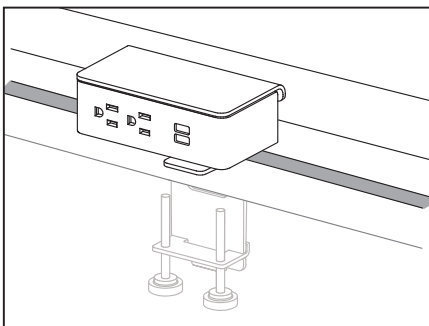
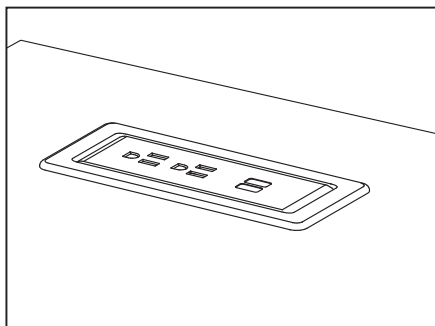

Optional EC26 Power Unit

Optional EC26 power unit can be located on tops, available in black or white; two power receptacles—120 volts and 15 amp dual powered USB. Locations are predetermined with a code; see the grommet and electrical locations in this section.

Optional EC28 Power Unit

Optional EC28 power unit can be clamped on desk or credenza with split tops, available in black or white; two power receptacles—120 volts and 15 amp dual power USB; 10 ft. cord.

Optional EC26 Pantry Power Unit

Optional EC26 power unit can be specified in the pantry drawer, available in black or white; two power receptacles—120 volts and 15 amp dual power USB.

Flux Technology

Dimensional Location of Grommets

The grommet locations below show standard dimensions for most products. If exact dimensional information is needed, contact Customer Service.

Desk (top view)

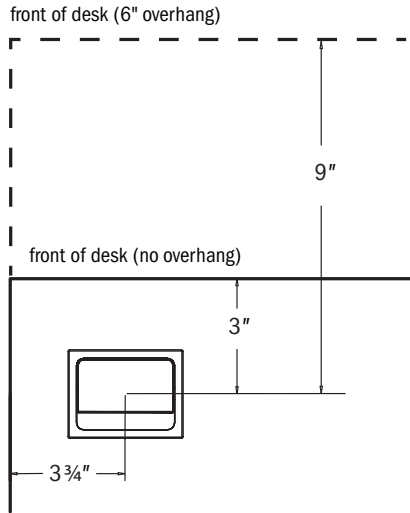

Grommet dimensions
 A and C positions on desk

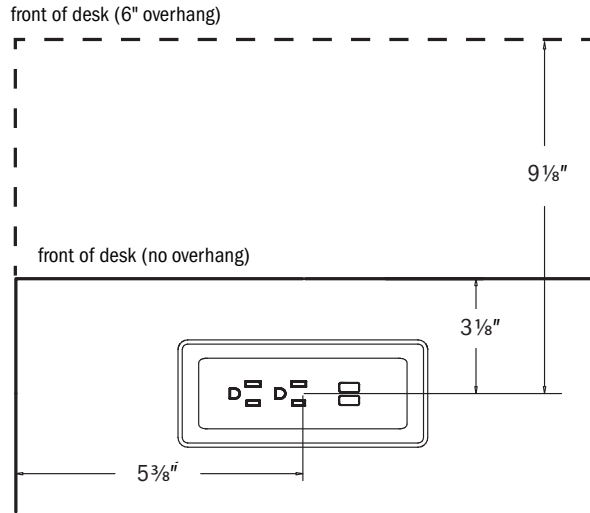

EC26 dimensions
 A and C positions on desk

Grommets or EC26 D position runs parallel to the side of the desk.

Credenza (top view)

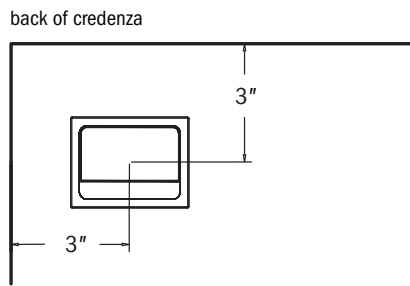

Grommet dimensions
 A and C positions on desk

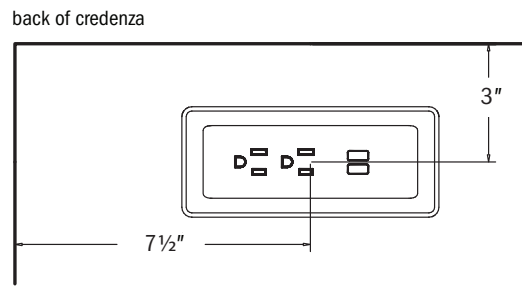

EC26 dimensions
 A and C positions on desk

PRODUCT INFORMATION

Flux Technology

Location of Grommets and Worksurface Electrical

Reference the diagrams below to determine the letter code for specifying a desired grommet or power unit location. Available locations apply to all options listed within each category.

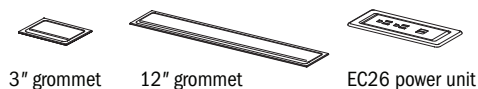

Double Pedestal Desks

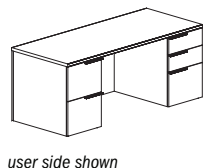

user side shown

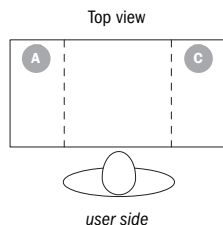

user side

Available options:

- 3" grommet
- EC26 power unit

Available location codes:

- A or C
- Grommets are inset on desks with overhang tops

Single Pedestal Desks

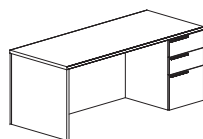

right side, user side shown

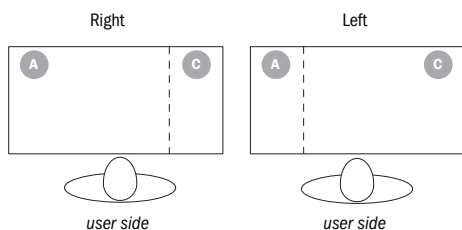

user side

user side

Available options:

- 3" grommet
- EC26 power unit

Available location codes:

- A or C
- Grommets are inset on desks with overhang tops

Peninsula Desks with End Panels

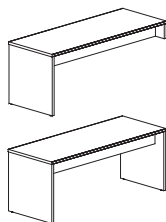

right side, approach view

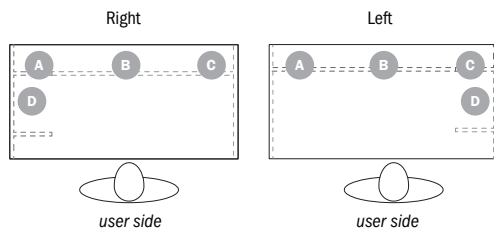

user side

user side

Available options:

- 3" grommet
- 12" grommet
- EC26 power unit

Available location codes:

- A B C or D

Peninsula Desks with End Frames or Post Frames

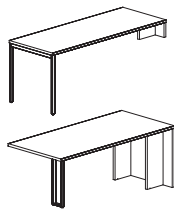

non-handed product - grommets hand units

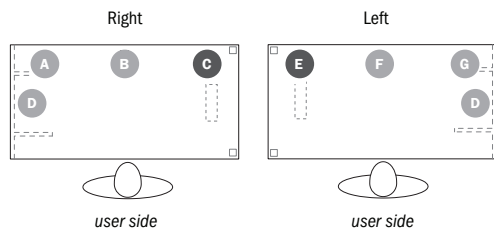

user side

user side

Dark gray locations (C & E) are not available on peninsula desks with frame post

Available options:

- 3" grommet
- 12" grommet
- EC26 power unit

Available location codes:

- A B C or D (right)
- E F G or D (left)
- Locations apply to rectangular and arc shape tops with end frames

Boomerang Peninsula Desks with End Frames

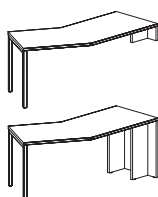

right side, approach view

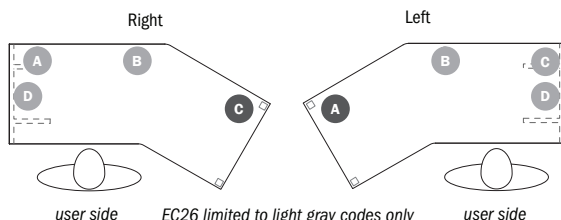

user side

EC26 limited to light gray codes only

user side

Available options:

- 3" grommet
- 12" grommet
- EC26 power unit (limited to 3 locations)

Available location codes:

- A B C or D
- EC26 power unit may not be located at outer end of bend

Flux Technology

Location of Grommets and Worksurface Electrical (continued)

Available locations apply to all options listed within each category.

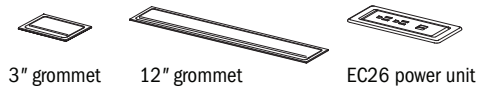

Rectangle Run-off Desks with End Panels

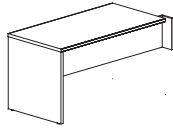

left side, approach view

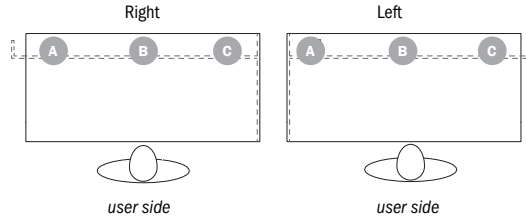

Available options:

- 3" grommet
- 12" grommet
- EC26 power unit

Available location codes:

- A B or C

Run-off Desks with End Frames or Post Frames

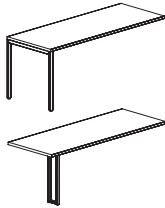

(frame post)

non-handed product – grommets hand units

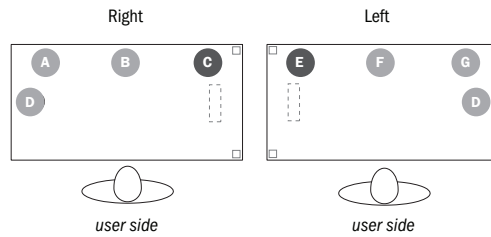

Dark gray locations (C & E) are not available on peninsula desks with frame post

Available options:

- 3" grommet
- 12" grommet
- EC26 power unit

Available location codes:

- A B C or D (right)
- E F G or D (left)
- Locations apply to rectangular and arc shape tops with end frames

Boomerang Run-off Desks with End Frames

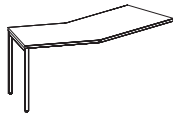

right side, approach view

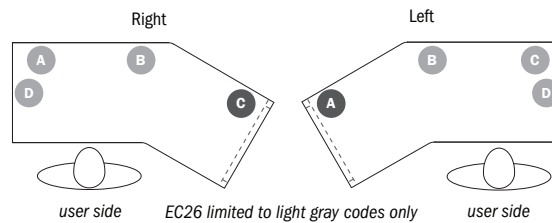

Available options:

- 3" grommet
- 12" grommet
- EC26 power unit (limited to 3 locations)

Available location codes:

- A B C or D
- EC26 power unit may not be located at outer end of bend

Bridge Tops

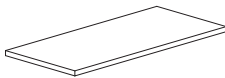

non-handed product

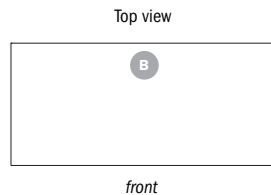

Available options:

- 3" grommet
- EC26 power unit

Available location codes:

- B

Returns

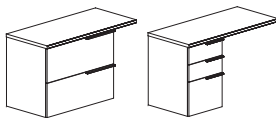

left side, user view

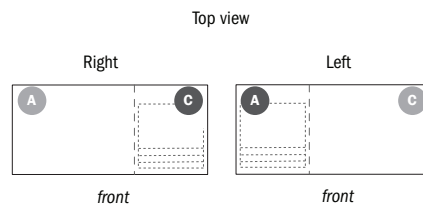

EC26 limited to light gray codes only

Available options:

- 3" grommet
- EC26 power unit (one location only)

Available location codes:

- A or C
- EC26 power unit may not be located above drawers

Flux Technology

Location of Grommets and Worksurface Electrical (continued)

Available locations apply to all credenza widths listed (primary or secondary height). EC26 power units may not be located above drawers.

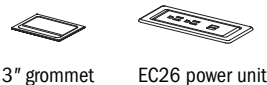

3" grommet

EC26 power unit

Lateral File Credenzas and Lateral File Pedestals

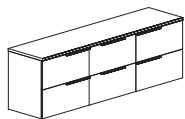

credenza with 3 file compartments, 90" w

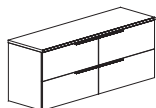
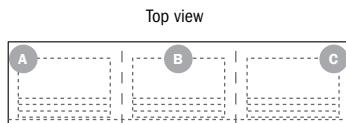

credenza with 2 file compartments, 72" w or 60" w

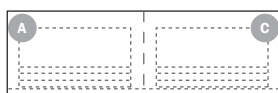

lateral file pedestal, 36" w or 30" w

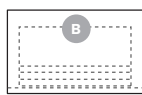

Available option:

- 3" grommet

Available location codes:

- A B or C (3 compartments)
- A or C (2 compartments)
- B (lateral file pedestal)
- Note: Grommets cannot be specified on secondary credenza at same location as the credenza mounts for a peninsula desk. See page 17 for additional information.

Storage Credenzas with Open Center Compartments

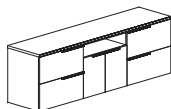

credenza with center storage/open compartment
96" w, 90" w, 84" w, 78" w, 72" w, 66" w or 60" w

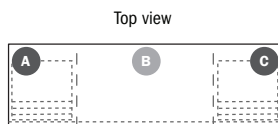

EC26 limited to center location B only

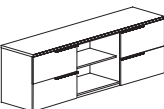

credenza with open center compartment
96" w or 90" w



Available options:

- 3" grommet
- EC26 power unit (one location only)

Available location codes:

- A B or C
- EC26 power unit may not be located above drawers; limited to center location B only
- Note: Grommets or EC26 power units cannot be specified on secondary credenza at same location as the credenza mounts for a peninsula desk. See page 17 for additional information.

Credenzas with Open, Sliding or Hinge Door Compartments

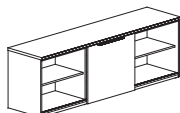

credenza without drawers, 96" w or 90" w

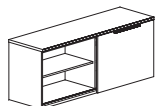
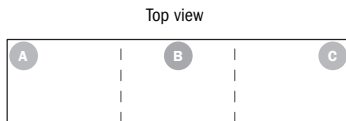

credenza without drawers, 72" w or 60" w

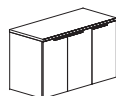

credenza without drawers, 54" w, 48" w or 42" w

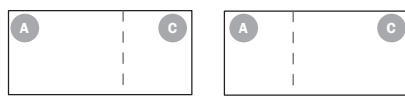

storage unit without drawers, 36" w or 30" w



Available options:

- 3" grommet
- EC26 power unit

Available location codes:

- A B or C (3 compartments)
- A or C (2 compartments)
- B (1 compartment)
- Note: Grommets or EC26 power units cannot be specified on secondary credenza at same location as the credenza mounts for a peninsula desk. See page 17 for additional information.

Flux Technology

Location of Grommets and Worksurface Electrical (continued)

Available locations apply to all credenza widths listed (primary or secondary height). EC26 power units may not be located above drawers.

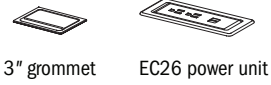

Lateral Storage Credenzas with End Open Compartment(s)

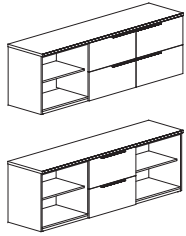

credenza with end open compartment(s)
96"w or 90"w

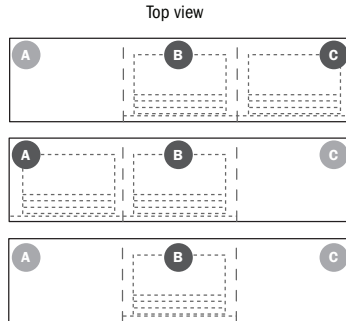

EC26 limited to open compartments only (light gray codes)

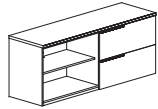

credenza with end open compartment
72"w, 66"w or 60"w

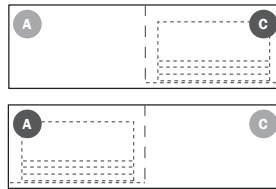

Kneespace Credenzas

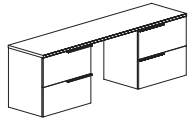

lateral drawer kneespace credenza
96"w or 90"w

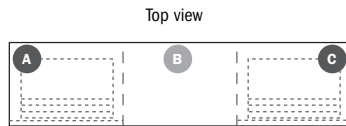

EC26 limited to center location **B** only

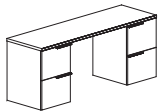

file drawer kneespace credenza
84"w, 78"w, 72"w, 66"w or 60"w



Available options:

- 3" grommet
- EC26 power unit (limited locations)

Available location codes:

- **A** **B** or **C** (3 compartments)
- **A** or **C** (2 compartments)
- EC26 power unit may not be located above drawers

Available options:

- 3" grommet
- EC26 power unit (one location only)

Available location codes:

- **A** **B** or **C**
- EC26 power unit may not be located above drawers; limited to center location **B** only

Lateral and File Credenzas

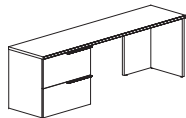

lateral drawer kneespace credenza
96"w, 90"w, 84"w, 78"w or 72"w

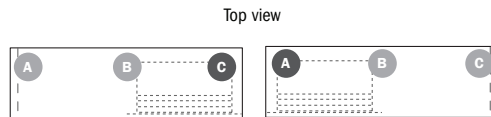

EC26 limited to open compartments only (light gray codes)

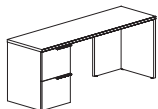

file drawer kneespace credenza
84"w, 78"w, 72"w, 66"w or 60"w

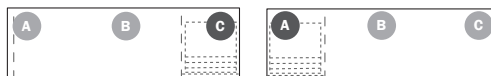

Available options:

- 3" grommet
- EC26 power unit (limited locations)

Available location codes:

- **A** **B** or **C**
- EC26 power unit may not be located above drawers

Flux Technology

Location of Grommets and Worksurface Electrical (continued)

Available locations apply to all options listed within each category.
EC26 power units may not be located above drawers.

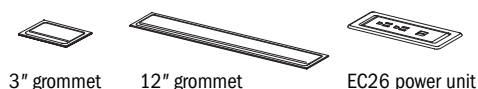

Peninsula Credenzas

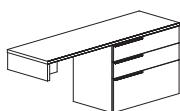

peninsula credenza , user view
96"w, 90"w, 84"w, 78"w or 72"w

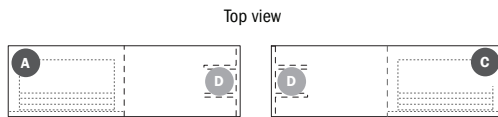

EC26 limited to location **D** only

Available options:

- 3" grommet
- EC26 power unit (one location only)

Available location codes:

- **A**, **C** or **D**
- EC26 power unit may not be located above drawers; limited to center location **D** only

Credenza Shells and Return Shells

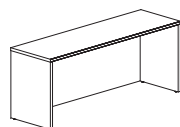

credenza shell and return
72"w or 66"w

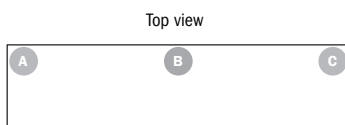

Available option:

- 3" grommet

Available location codes:

- **A**, **B** or **C** (72"w or 66"w units)
- **A** or **C** (units 60"w or less)

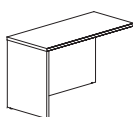

credenza shell and return
60"w, 54"w, 48"w or 42"w

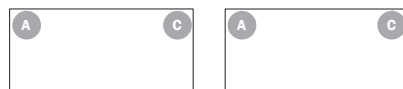

Adjustable Height Credenza Extensions and Return Shells

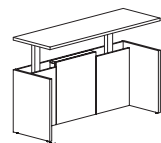

adjustable height credenza extension
72"w, 66"w, 60"w, 54"w or 48"w

Top view



Available option:

- 3" grommet

Available location codes:

- Codes apply only to adjustable height credenza extensions and adjustable height return shells.

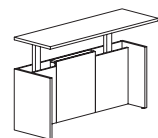

adjustable height return shell
72"w, 66"w, 60"w, 54"w or 48"w

Adjustable Height Credenza

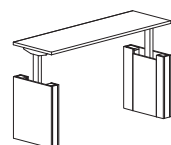

adjustable height credenza
72"w, 66"w, 60"w, 54"w or 48"w

Top view



Available option:

- 3" grommet

Available location codes:

- Codes apply only to adjustable height credenza.

Flux Technology

Location of Grommets and Worksurface Electrical (continued)

Available locations apply to all options listed within each category.



Adjustable Height Table Desks with End Panels

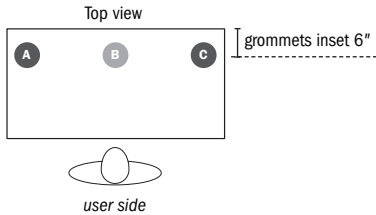
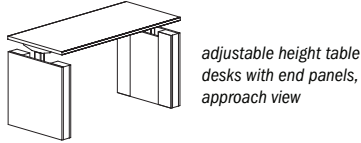

12" grommet limited to location B only

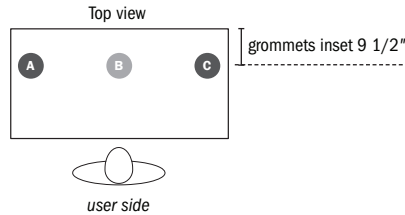
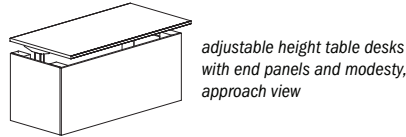

12" grommet limited to location B only

Available option:

- 3" grommet
- 12" grommet (one location only)

Available location codes:

- A, B or C
- 12" grommet limited to location B only
- Grommets are inset 6" to accommodate desk overhang
- Codes apply only to adjustable height table desks with end panels

Adjustable Height Peninsula Desk

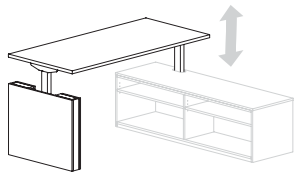

non-handed product - grommets hand units

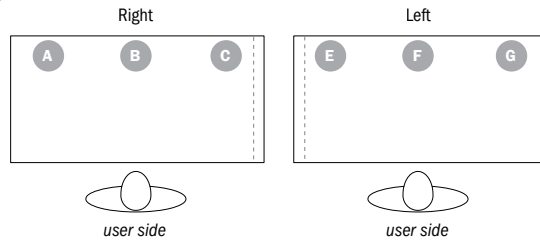

Available option:

- 3" grommet

Available location codes:

- A, B or C (right)
- E, F or G (left)
- Locations apply to rectangular adjustable height peninsula desk

Adjustable Height L Configuration Desks and Returns

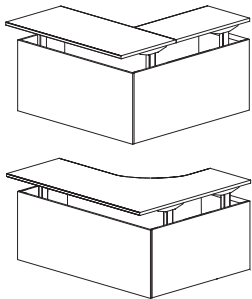

adjustable height L desks, left unit, approach view

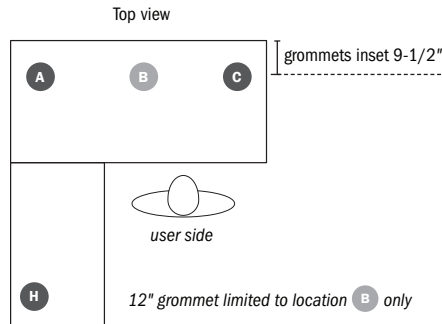

Available option:

- 3" grommet
- 12" grommet (one location only)

Available location codes:

- A, B or C (desk)
- H (return)
- 12" grommet limited to location B only
- Grommets are inset 6" to accommodate desk overhang

Adjustable Height Table Desks with Center Columns

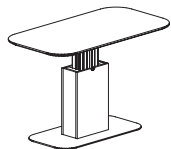

adjustable height rectangular table desk with center column

Meeting table, center mount

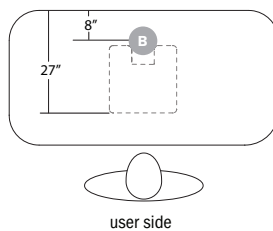

Desk, offset mount

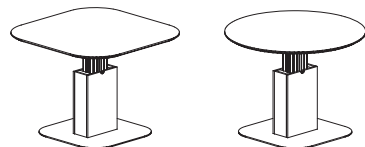
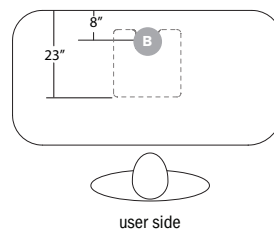

adjustable height square and round table desks with center column

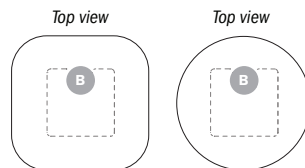

Available option:

- 3" grommet (grommets are off-center)

Available location codes:

- B
- Dimensional information for rectangular table desk is for a unit with a 36"d x 72"w top. Base can be mounted for a meeting table or a desk; grommet location remains the same on both mounting locations.

Flux Technology

Metal Wire Manager for Peninsula Desks and Run-off Desks

The wire manager is available in multiple lengths and four finishes: matte black, pewter, arctic silver and soft nickel. Use the charts on the following two pages to determine the appropriate wire manager model number for the selected peninsula or run-off desk.

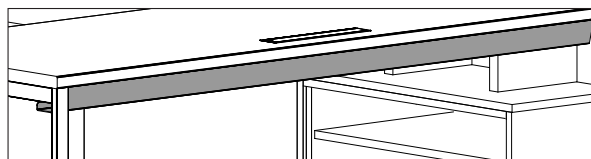

Recommend Size with Peninsula or Run-off Desk

Laminate/Veneer Model Number	Wire Manager Model Number	
	Eased Edge	Knife Edge
FLT/FLV2848ARCTP	FLB0438MWM	FLB0438MWM
FLT/FLV2848RRTN	FLB0444MWM	FLB0444MWM
FLT/FLV2848RRTP	FLB0444MWM	FLB0444MWM
FLT/FLV2848TD	FLB0444MWM	FLB0438MWM
FLT/FLV2854ARCTP	FLB0444MWM	FLB0444MWM
FLT/FLV2854RDEPL/R	FLB0450MWM	NA
FLT/FLV2854RRTN	FLB0450MWM	FLB0450MWM
FLT/FLV2854RRTP	FLB0450MWM	FLB0450MWM
FLT/FLV2854TD	FLB0450MWM	FLB0444MWM
FLT/FLV2860ARCTP	FLB0450MWM	FLB0450MWM
FLT/FLV2860BMTNL/R	FLB0432MWM	FLB0432MWM
FLT/FLV2860RDEPL/R	FLB0456MWM	NA
FLT/FLV2860RRTN	FLB0456MWM	FLB0456MWM
FLT/FLV2860RRTP	FLB0456MWM	FLB0456MWM
FLT/FLV2860TD	FLB0456MWM	FLB0450MWM
FLT/FLV2866ARCTP	FLB0456MWM	FLB0456MWM
FLT/FLV2866BMTNL/R	FLB0432MWM	FLB0432MWM
FLT/FLV2866DTEPL/R	FLB0456MWM	NA
FLT/FLV2866PARCP	FLB0456MWM	FLB0456MWM
FLT/FLV2866PARCPEP	FLB0456MWM	NA
FLT/FLV2866PBMNEPL/R	FLB0432MWM	NA
FLT/FLV2866PBMNL/R	FLB0432MWM	FLB0432MWM
FLT/FLV2866PDEPL	FLB0462MWM	NA
FLT/FLV2866PDEPPL/R	FLB0462MWM	NA
FLT/FLV2866PDEPR	FLB0462MWM	NA
FLT/FLV2866PDN	FLB0462MWM	FLB0456MWM
FLT/FLV2866PDNEP	FLB0462MWM	NA
FLT/FLV2866PDP	FLB0462MWM	FLB0456MWM
FLT/FLV2866PDPEP	FLB0462MWM	NA
FLT/FLV2866PDTEPL/R	FLB0456MWM	NA
FLT/FLV2866RDEPL/R	FLB0462MWM	NA
FLT/FLV2866RRTN	FLB0462MWM	FLB0462MWM
FLT/FLV2866RRTP	FLB0462MWM	FLB0462MWM
FLT/FLV2866TD	FLB0462MWM	FLB0456MWM
FLT/FLV2872ARCTP	FLB0462MWM	FLB0462MWM
FLT/FLV2872BMTNL/R	FLB0438MWM	FLB0438MWM
FLT/FLV2872DTEPL/R	FLB0462MWM	NA

Laminate/Veneer Model Number	Wire Manager Model Number	
	Eased Edge	Knife Edge
FLT/FLV2872PARCP	FLB0462MWM	FLB0462MWM
FLT/FLV2872PARCPEP	FLB0462MWM	NA
FLT/FLV2872PBMNEPL/R	FLB0438MWM	NA
FLT/FLV2872PBMNL/R	FLB0438MWM	FLB0438MWM
FLT/FLV2872PDEPL	FLB0468MWM	NA
FLT/FLV2872PDEPPL/R	FLB0468MWM	NA
FLT/FLV2872PDEPR	FLB0468MWM	NA
FLT/FLV2872PDN	FLB0468MWM	FLB0462MWM
FLT/FLV2872PDNEP	FLB0468MWM	NA
FLT/FLV2872PDP	FLB0468MWM	FLB0462MWM
FLT/FLV2872PDPEP	FLB0468MWM	NA
FLT/FLV2872PDTEPL/R	FLB0462MWM	NA
FLT/FLV2872RDEPL/R	FLB0468MWM	NA
FLT/FLV2872RRTN	FLB0468MWM	FLB0468MWM
FLT/FLV2872RRTP	FLB0468MWM	FLB0468MWM
FLT/FLV2872TD	FLB0468MWM	FLB0462MWM
FLT/FLV2878DTEPL/R	FLB0468MWM	NA
FLT/FLV2878PARCP	FLB0468MWM	FLB0468MWM
FLT/FLV2878PARCPEP	FLB0468MWM	NA
FLT/FLV2878PBMNEPL/R	FLB0444MWM	NA
FLT/FLV2878PBMNL/R	FLB0444MWM	FLB0444MWM
FLT/FLV2878PDEPL	FLB0474MWM	NA
FLT/FLV2878PDEPPR	FLB0474MWM	NA
FLT/FLV2878PDEPR	FLB0474MWM	NA
FLT/FLV2878PDN	FLB0474MWM	FLB0468MWM
FLT/FLV2878PDNEP	FLB0474MWM	NA
FLT/FLV2878PDP	FLB0474MWM	FLB0468MWM
FLT/FLV2878PDPEP	FLB0474MWM	NA
FLT/FLV2878PDTEPL/R	FLB0468MWM	NA
FLT/FLV2884DTEPL/R	FLB0474MWM	NA
FLT/FLV2884PARCP	FLB0474MWM	FLB0474MWM
FLT/FLV2884PARCPEP	FLB0474MWM	NA
FLT/FLV2884PBMNEPL/R	FLB0450MWM	NA
FLT/FLV2884PBMNL/R	FLB0450MWM	FLB0450MWM
FLT/FLV2884PDEPL	FLB0480MWM	NA
FLT/FLV2884PDEPPL/R	FLB0480MWM	NA
FLT/FLV2884PDEPR	FLB0480MWM	NA

Flux Technology

Recommend Size with Peninsula or Run-off Desk (continued)

Laminate/Veneer Model Number	Wire Manager Model Number	
	Eased Edge	Knife Edge
FLT/FLV2884PDN	FLB0480MWM	FLB0474MWM
FLT/FLV2884PDNEP	FLB0480MWM	NA
FLT/FLV2884PDP	FLB0480MWM	FLB0474MWM
FLT/FLV2884PDPEP	FLB0480MWM	NA
FLT/FLV2884PDTEPL/R	FLB0474MWM	NA
FLT/FLV3448ARCTP	FLB0438MWM	FLB0438MWM
FLT/FLV3448RRTN	FLB0444MWM	FLB0444MWM
FLT/FLV3448RRTP	FLB0444MWM	FLB0444MWM
FLT/FLV3454ARCTP	FLB0444MWM	FLB0444MWM
FLT/FLV3454RDEPL/R	FLB0450MWM	NA
FLT/FLV3454RRTN	FLB0450MWM	FLB0450MWM
FLT/FLV3454RRTP	FLB0450MWM	FLB0450MWM
FLT/FLV3460ARCTP	FLB0450MWM	FLB0450MWM
FLT/FLV3460BMTNL/R	FLB0432MWM	FLB0432MWM
FLT/FLV3460RDEPL/R	FLB0456MWM	NA
FLT/FLV3460RRTN	FLB0456MWM	FLB0456MWM
FLT/FLV3460RRTP	FLB0456MWM	FLB0456MWM
FLT/FLV3466ARCTP	FLB0456MWM	FLB0456MWM
FLT/FLV3466BMTNL/R	FLB0432MWM	FLB0432MWM
FLT/FLV3466DTEPL/R	FLB0456MWM	NA
FLT/FLV3466PARCP	FLB0456MWM	FLB0456MWM
FLT/FLV3466PARCPEP	FLB0456MWM	NA
FLT/FLV3466PBMNEPL/R	FLB0432MWM	NA
FLT/FLV3466PBMNL/R	FLB0432MWM	FLB0432MWM
FLT/FLV3466PDEPL	FLB0462MWM	NA
FLT/FLV3466PDEPPL/R	FLB0462MWM	NA
FLT/FLV3466PDEPR	FLB0462MWM	NA
FLT/FLV3466PDN	FLB0462MWM	FLB0456MWM
FLT/FLV3466PDNEP	FLB0462MWM	NA
FLT/FLV3466PDP	FLB0462MWM	FLB0456MWM
FLT/FLV3466PDPEP	FLB0462MWM	NA
FLT/FLV3466PDTEPL/R	FLB0456MWM	NA
FLT/FLV3466RDEPL/R	FLB0462MWM	NA
FLT/FLV3466RRTN	FLB0462MWM	FLB0462MWM
FLT/FLV3466RRTP	FLB0462MWM	FLB0462MWM
FLT/FLV3466TD	FLB0462MWM	FLB0456MWM
FLT/FLV3472ARCTP	FLB0462MWM	FLB0462MWM
FLT/FLV3472BMTNL/R	FLB0438MWM	FLB0438MWM
FLT/FLV3472DTEPL/R	FLB0462MWM	NA
FLT/FLV3472PARCP	FLB0462MWM	FLB0462MWM
FLT/FLV3472PARCPEP	FLB0462MWM	NA

Laminate/Veneer Model Number	Wire Manager Model Number	
	Eased Edge	Knife Edge
FLT/FLV3472PBMNEPL/R	FLB0438MWM	NA
FLT/FLV3472PBMNL/R	FLB0438MWM	FLB0438MWM
FLT/FLV3472PDEPL	FLB0468MWM	NA
FLT/FLV3472PDEPPL/R	FLB0468MWM	NA
FLT/FLV3472PDEPR	FLB0468MWM	NA
FLT/FLV3472PDN	FLB0468MWM	FLB0462MWM
FLT/FLV3472PDNEP	FLB0468MWM	NA
FLT/FLV3472PDP	FLB0468MWM	FLB0462MWM
FLT/FLV3472PDPEP	FLB0468MWM	NA
FLT/FLV3472PDTEPL/R	FLB0462MWM	NA
FLT/FLV3472RDEPL/R	FLB0468MWM	NA
FLT/FLV3472RRTN	FLB0468MWM	FLB0468MWM
FLT/FLV3472RRTP	FLB0468MWM	FLB0468MWM
FLT/FLV3472TD	FLB0468MWM	FLB0462MWM
FLT/FLV3478DTEPL/R	FLB0468MWM	NA
FLT/FLV3478PARCP	FLB0468MWM	FLB0468MWM
FLT/FLV3478PARCPEP	FLB0468MWM	NA
FLT/FLV3478PBMNEPL/R	FLB0444MWM	NA
FLT/FLV3478PBMNL/R	FLB0444MWM	FLB0444MWM
FLT/FLV3478PDEPL	FLB0474MWM	NA
FLT/FLV3478PDEPPL/R	FLB0474MWM	NA
FLT/FLV3478PDEPR	FLB0474MWM	NA
FLT/FLV3478PDN	FLB0474MWM	FLB0468MWM
FLT/FLV3478PDNEP	FLB0474MWM	NA
FLT/FLV3478PDP	FLB0474MWM	FLB0468MWM
FLT/FLV3478PDPEP	FLB0474MWM	NA
FLT/FLV3478PDTEPL/R	FLB0468MWM	NA
FLT/FLV3484DTEPL/R	FLB0474MWM	NA
FLT/FLV3484PARCP	FLB0474MWM	FLB0474MWM
FLT/FLV3484PARCPEP	FLB0474MWM	NA
FLT/FLV3484PBMNEPL/R	FLB0450MWM	NA
FLT/FLV3484PBMNL/R	FLB0450MWM	FLB0450MWM
FLT/FLV3484PDEPL	FLB0480MWM	NA
FLT/FLV3484PDEPPL/R	FLB0480MWM	NA
FLT/FLV3484PDEPR	FLB0480MWM	NA
FLT/FLV3484PDN	FLB0480MWM	FLB0474MWM
FLT/FLV3484PDNEP	FLB0480MWM	NA
FLT/FLV3484PDP	FLB0480MWM	FLB0474MWM
FLT/FLV3484PDPEP	FLB0480MWM	NA
FLT/FLV3484PDTEPL/R	FLB0474MWM	NA

PRODUCT INFORMATION

Description	D	W	H	CTN WT	CU FT	① Model	HPL Laminate	Fiat Cut Veneer	Double Cut Veneer
Table Desk	33½	72	29	139	22	FLT3472TD	\$1,981		
	33½	72	29	139	22	FLV3472TD		\$2,419	\$2,662
	33½	66	29	130	20	FLT3466TD	\$1,958		
	33½	66	29	130	20	FLV3466TD		\$2,390	\$2,632

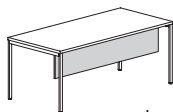
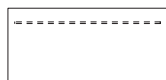
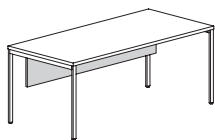

approach

Features:

- eased edge profile on approach and user sides

Options:

- reverse bevel edge available on approach and user sides, specify; add \$429 list for laminate or \$168 list for veneer; see page 8 for details
- casters available, two locking and two non-locking, specify and add \$98 list
- 13½”h modesty panel available, specify; add \$427 list for laminate or \$594 list for veneer; see page 19 for details
- 3” top grommet available, specify A or C location; add \$128 list each



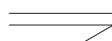

eased

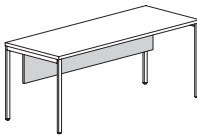
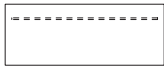
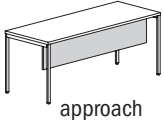

reverse bevel

edges

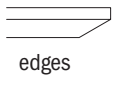
Description	D	W	H	CTN WT	CU FT	① Model	HPL Laminate	Flat Cut Veneer	Double Cut Veneer
    eased  reverse bevel edges	27 1/2	72	29	112	18	FLT2872TD	\$1,891		
	27 1/2	72	29	112	18	FLV2872TD		\$2,322	\$2,554
	27 1/2	66	29	105	17	FLT2866TD	\$1,876		
	27 1/2	66	29	105	17	FLV2866TD		\$2,303	\$2,531
	27 1/2	60	29	99	15	FLT2860TD	\$1,859		
	27 1/2	60	29	99	15	FLV2860TD		\$2,280	\$2,508
	27 1/2	54	29	93	14	FLT2854TD	\$1,843		
	27 1/2	54	29	93	14	FLV2854TD		\$2,260	\$2,487
	27 1/2	48	29	87	12	FLT2848TD	\$1,820		
	27 1/2	48	29	87	12	FLV2848TD		\$2,234	\$2,341

Features:

- eased edge profile on approach and user sides

Options:

- reverse bevel edge available on approach and user sides, specify; add \$429 list for laminate or \$168 list for veneer; see page 8 for details
- casters available, two locking and two non-locking, specify and add \$98 list
- 13 1/2" h modesty panel available, specify; add \$427 list for laminate or \$594 list for veneer; see page 19 for details
- 3" top grommet available, specify A or C location; add \$128 list each

To Order, Specify:

① Laminate Model #	② Laminate Type	③ Laminate Selection	④ Metal Color	⑤ Other Product Options
Laminate (FLT)	HPL	See Laminate Selection	See Metal Finish Color Options	See list of options for each specific unit; Specify and add accordingly.

① Veneer Model #	② Wood Species	③ Wood Finish	④ Metal Color	⑤ Other Product Options
Veneer (FLV)	Flat Cut CH1 Cherry MA1 Maple WA1 Walnut BO1 Black Oak	See Flat Cut Wood Finish Options	See Metal Finish Color Options	See list of options for each specific unit; Specify and add accordingly.
		<table border="1"> <thead> <tr> <th>③a Wood Finish</th> <th>③b Chassis Grain Direction</th> </tr> </thead> <tbody> <tr> <td>See Double Cut Wood Finish Options</td> <td>For Double Cut Only: Vertical Horizontal</td> </tr> </tbody> </table>		
③a Wood Finish	③b Chassis Grain Direction			
See Double Cut Wood Finish Options	For Double Cut Only: Vertical Horizontal			

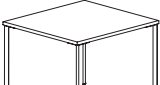
Description	D	W	H	CTN WT	CU FT	① Model	HPL Laminate	Flat Cut Veneer	Double Cut Veneer
	48	48	29	94	14	FLT4848T	\$1,665		
	48	48	29	94	14	FLV4848T		\$2,190	\$2,409
	42	42	29	75	12	FLT4242T	\$1,415		
	42	42	29	75	12	FLV4242T		\$1,861	\$2,047

Features

- eased edge profile all sides

Options:

- reverse bevel edge available on top perimeter, specify; add \$429 list for laminate or \$168 list for veneer; see page 8 for details
- casters available, two locking and two non-locking, specify and add \$98 list

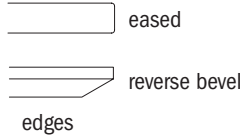

	33½	33½	29	69	10	FLT3434T	\$1,344		
	33½	33½	29	69	10	FLV3434T		\$1,768	\$1,945
	27½	27½	29	51	9	FLT2828T	\$1,279		
	27½	27½	29	51	9	FLV2828T		\$1,679	\$1,849

Features:

- eased edge profile all sides

Options:

- reverse bevel edge available on top perimeter, specify; add \$429 list for laminate or \$168 list for veneer; see page 8 for details
- casters available, two locking and two non-locking, specify and add \$98 list

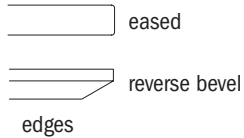

	48	48	29	301	46	FLT4848RT	\$1,745		
	48	48	29	77	14	FLV4848RT		\$2,296	\$2,526
	42	42	29	62	12	FLT4242RT	\$1,482		
	42	42	29	62	12	FLV4242RT		\$1,949	\$2,145

Features:

- eased edge profile

Options:

- reverse bevel edge available on top perimeter, specify; add \$429 list for laminate or \$168 list for veneer; see page 8 for details
- casters available, two locking and two non-locking, specify and add \$98 list

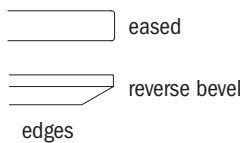

FLUX - PRIVATE OFFICE

Description	D	W	H	CTN WT	CU FT	① Model	HPL Laminate	Flat Cut Veneer	Double Cut Veneer
Square Stationary Height Table with Eased Edge Profile - Four Star Base 	30	30	29	39	19	FLT3030ST4B	\$1,479		
	30	30	29	39	19	FLV3030ST4B		\$1,942	\$2,136
	24	24	29	31	13	FLT2424ST4B	\$1,440		
	24	24	29	31	13	FLV2424ST4B		\$1,893	\$2,084

Features:

- ¾" top with flat edge
- 4-star cast aluminum base

Options:

- casters available, two locking and two non-locking, specify and add \$98 list

Description	D	W	H	CTN WT	CU FT	① Model	HPL Laminate	Flat Cut Veneer	Double Cut Veneer
Round Stationary Height Table 	36	36	29	43	27	FLT3636R4B	\$1,516		
	36	36	29	43	27	FLV3636R4B		\$1,993	\$2,191
	30	30	29	36	19	FLT3030R4B	\$1,479		
	30	30	29	36	19	FLV3030R4B		\$1,942	\$2,136

Features:

- ¾" top with flat edge
- 4-star cast aluminum base

Options:

- casters available, two locking and two non-locking, specify and add \$98 list

Description	D	W	H	CTN WT	CU FT	① Model	HPL Laminate	Flat Cut Veneer	Double Cut Veneer
Oval Stationary Height Table 	26	36	29	39	20	FLT2636O4B	\$1,557		
	26	36	29	39	20	FLV2636O4B		\$2,043	\$2,247

Features:

- ¾" top with flat edge
- 4-star cast aluminum base

Options:

- casters available, two locking and two non-locking, specify and add \$98 list

To Order, Specify:

① Laminate Model #	② Laminate Type	③ Laminate Selection	④ Metal Color	⑤ Other Product Options
Laminate (FLT)	HPL	See Laminate Selection	See Metal Finish Color Options	See list of options for each specific unit; Specify and add accordingly.

① Veneer Model #	② Wood Species	③ Wood Finish	④ Metal Color	⑤ Other Product Options
Veneer (FLV)	Flat Cut CH1 Cherry MA1 Maple WA1 Walnut BO1 Black Oak	See Flat Cut Wood Finish Options	See Metal Finish Color Options	See list of options for each specific unit; Specify and add accordingly.
	Double Cut DC1 Double Cut	3a Wood Finish See Double Cut Wood Finish Options		

Description	D	W	H	CTN WT	CU FT	① Model	HPL Laminate	Fiat Cut Veneer	Double Cut Veneer
Bow Front Double Pedestal Desk with Break Front Modesty Continuous Wire Channel - Split Top	42	84	29	359	69	FLT4284BDST	\$3,550		
	42	84	29	359	69	FLV4284BDST		\$4,876	\$5,363
	42	78	29	348	64	FLT4278BDST	\$3,467		
	42	78	29	348	64	FLV4278BDST		\$4,764	\$5,238
	42	72	29	337	59	FLT4272BDST	\$3,388		
	42	72	29	337	59	FLV4272BDST		\$4,652	\$5,116

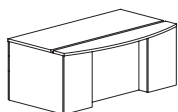
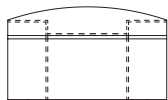
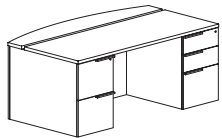

approach

Features:

- eased edge profile on approach and user sides
- built in horizontal wire channel
- 6" overhang on approach side
- pedestal front locking
- FLT4284BDST or FLV4284BDST - chassis 36" x 84"
- FLT4278BDST or FLV4278BDST - chassis 36" x 78"
- FLT4272BDST or FLV4272BDST - chassis 36" x 72"
- FLT4284BDST or FLV4284BDST - kneespace 48"
- FLT4278BDST or FLV4278BDST - kneespace 42"
- FLT4272BDST or FLV4272BDST - kneespace 36"

Options:

- must specify chassis grain direction on double cut veneer, see pages 11-13 for details
- veneer drawer fronts in paint available, specify paint color; add \$337 list; see page 14 for details
- on laminate units, contrasting worksurface tops and drawer fronts available, no upcharge; specify color, see page 14 for details
- ledge pulls standard ; prism pulls available, specify and see page 9
- pedestal access doors available, specify; add \$283 list for laminate or \$337 list for veneer; see page 15 for details

Description	D	W	H	CTN WT	CU FT	① Model	HPL Laminate	Flat Cut Veneer	Double Cut Veneer
Bow Front Double Pedestal Desk with Break Front Modesty - Continuous Wire Channel - Split Top	36	84	29	341	60	FLT3684BDST	\$3,441		
	36	84	29	341	60	FLV3684BDST		\$4,647	\$5,111
	36	78	29	331	55	FLT3678BDST	\$3,369		
	36	78	29	331	55	FLV3678BDST		\$4,543	\$4,995
	36	72	29	320	51	FLT3672BDST	\$3,296		
	36	72	29	320	51	FLV3672BDST		\$4,442	\$4,886
	36	66	29	309	47	FLT3666BDST	\$3,239		
	36	66	29	309	47	FLV3666BDST		\$4,361	\$4,797
	36	60	29	298	43	FLT3660BDST	\$3,181		
	36	60	29	298	43	FLV3660BDST		\$4,284	\$4,710

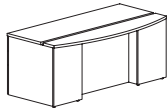
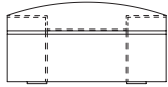
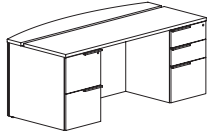

approach

Features:

- eased edge profile on approach and user sides
- built in horizontal wire channel
- 6" overhang on approach side
- pedestal front locking
- FLT3684BDST or FLV3684BDST - chassis 30" x 84"
- FLT3678BDST or FLV3678BDST - chassis 30" x 78"
- FLT3672BDST or FLV3672BDST - chassis 30" x 72"
- FLT3666BDST or FLV3666BDST - chassis 30" x 66"
- FLT3660BDST or FLV3660BDST - chassis 30" x 60"
- FLT3684BDST or FLV3684BDST - kneespace 48"
- FLT3678BDST or FLV3678BDST - kneespace 42"
- FLT3672BDST or FLV3672BDST - kneespace 36"
- FLT3666BDST or FLV3666BDST - kneespace 34 3/4"
- FLT3660BDST or FLV3660BDST - kneespace 28 3/4"

Options:

- veneer drawer fronts in paint available, specify paint color; add \$337 list; see page 14 for details
- on laminate units, contrasting worksurface tops and drawer fronts available, no upcharge; specify color, see page 14 for details
- ledge pulls standard; prism pulls available, specify and see page 9
- pedestal access doors available, specify; add \$283 list for laminate or \$337 list for veneer; see page 15 for details

To Order, Specify:

① Laminate Model #	② Laminate Type	③ Laminate Selection	④ Metal Color	⑤ Other Product Options
Laminate (FLT)	HPL	See Laminate Selection	See Metal Finish Color Options	See list of options for each specific unit; Specify and add accordingly.

① Veneer Model #	② Wood Species	③ Wood Finish	④ Metal Color	⑤ Other Product Options
Veneer (FLV)	Flat Cut CH1 Cherry MA1 Maple WA1 Walnut BO1 Black Oak	See Flat Cut Wood Finish Options	See Metal Finish Color Options	See list of options for each specific unit; Specify and add accordingly.
		<table border="1"> <thead> <tr> <th>ⓐ Wood Finish</th> <th>ⓑ Chassis Grain Direction</th> </tr> </thead> <tbody> <tr> <td>See Double Cut Wood Finish Options</td> <td>For Double Cut Only: Vertical Horizontal</td> </tr> </tbody> </table>		
ⓐ Wood Finish	ⓑ Chassis Grain Direction			
See Double Cut Wood Finish Options	For Double Cut Only: Vertical Horizontal			

Description	D	W	H	CTN WT	CU FT	① Model	HPL Laminate	Flat Cut Veneer	Double Cut Veneer
Bow Front Double Pedestal Desk with Break Front Modesty	42	84	29	359	69	FLT4284BD	\$3,351		
	42	84	29	359	69	FLV4284BD		\$4,680	\$5,147
	42	78	29	348	64	FLT4278BD	\$3,271		
	42	78	29	348	64	FLV4278BD		\$4,567	\$5,024
	42	72	29	337	59	FLT4272BD	\$3,192		
	42	72	29	337	59	FLV4272BD		\$4,453	\$4,900

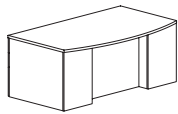
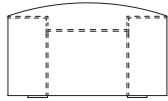
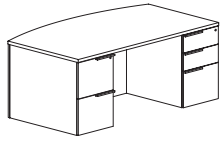

approach

Features:

- eased edge profile on approach and user sides
- 6" overhang on approach side
- pedestal front locking
- FLT4284BD or FLV4284BD - chassis 36" x 84"
- FLT4278BD or FLV4278BD - chassis 36" x 78"
- FLT4272BD or FLV4272BD - chassis 36" x 72"
- FLT4284BD or FLV4284BD - kneespace 48"
- FLT4278BD or FLV4278BD - kneespace 42"
- FLT4272BD or FLV4272BD - kneespace 36"

Options:

- must specify chassis grain direction on double cut veneer, see pages 11-13 for details
- veneer drawer fronts in paint available, specify paint color; add \$337 list; see page 14 for details
- on laminate units, contrasting worksurface tops and drawer fronts available, no upcharge; specify color, see page 14 for details
- ledge pulls standard; prism pulls available, specify and see page 9
- top grommet available, specify location; add \$128 list each; see page 42 for details
- worksurface power available, specify "to accommodate EC26" on your purchase order; EC26 unit must be ordered separately, see page 42
- pedestal access door with wire manager available, use with top grommet, specify; add \$337 list for laminate or \$390 list for veneer; see page 15 for details
- interior kneespace wire manager available, use with top grommet or power unit, specify and add \$114 list; see page 15 for details

Description	D	W	H	CTN WT	CU FT	① Model	HPL Laminate	Flat Cut Veneer	Double Cut Veneer
Bow Front Double Pedestal Desk with Break Front Modesty	36	84	29	341	60	FLT3684BD	\$3,245		
	36	84	29	341	60	FLV3684BD		\$4,448	\$4,896
	36	78	29	331	55	FLT3678BD	\$3,172		
	36	78	29	331	55	FLV3678BD		\$4,343	\$4,779
	36	72	29	320	51	FLT3672BD	\$3,098		
	36	72	29	320	51	FLV3672BD		\$4,246	\$4,668
	36	66	29	309	47	FLT3666BD	\$3,044		
	36	66	29	309	47	FLV3666BD		\$4,165	\$4,581
	36	60	29	298	43	FLT3660BD	\$2,984		
	36	60	29	298	43	FLV3660BD		\$4,087	\$4,494

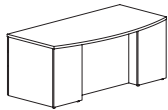
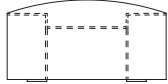
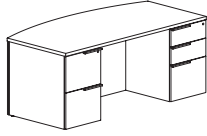

approach

Features:

- eased edge profile on approach and user sides
- 6" overhang on approach side
- pedestal front locking
- FLT3684BD or FLV3684BD - chassis 30" x 84"
- FLT3678BD or FLV3678BD - chassis 30" x 78"
- FLT3672BD or FLV3672BD - chassis 30" x 72"
- FLT3666BD or FLV3666BD - chassis 30" x 66"
- FLT3660BD or FLV3660BD - chassis 30" x 60"
- FLT3684BD or FLV3684BD - kneespace 48"
- FLT3678BD or FLV3678BD - kneespace 42"
- FLT3672BD or FLV3672BD - kneespace 36"
- FLT3666BD or FLV3666BD - kneespace 34 3/4"
- FLT3660BD or FLV3660BD - kneespace 28 3/4"

Options:

- must specify chassis grain direction on double cut veneer, see pages 11-13 for details
- veneer drawer fronts in paint available, specify paint color; add \$337 list; see page 14 for details
- on laminate units, contrasting worksurface tops and drawer fronts available, no upcharge; specify laminate color, see page 14 for details
- ledge pulls standard; prism pulls available, specify and see page 9
- top grommet available, specify location; add \$128 list each; see page 42 for details
- worksurface power available, specify "to accommodate EC26" on your purchase order; EC26 unit must be ordered separately, see page 42
- pedestal access door with wire manager available, use with top grommet, specify; add \$337 list for laminate or \$390 list for veneer; see page 15 for details

To Order, Specify:

① Laminate Model #	② Laminate Type	③ Laminate Selection	④ Metal Color	⑤ Other Product Options
Laminate (FLT)	HPL	See Laminate Selection	See Metal Finish Color Options	See list of options for each specific unit; Specify and add accordingly.

① Veneer Model #	② Wood Species	③ Wood Finish	④ Metal Color	⑤ Other Product Options	
Veneer (FLV)	Flat Cut CH1 Cherry MA1 Maple WA1 Walnut BO1 Black Oak	See Flat Cut Wood Finish Options	See Metal Finish Color Options	See list of options for each specific unit; Specify and add accordingly.	
	Double Cut DC1 Double Cut	<table border="1"> <thead> <tr> <th>Ⓐ Wood Finish</th> <th>Ⓑ Chassis Grain Direction</th> </tr> </thead> <tbody> <tr> <td>See Double Cut Wood Finish Options</td> <td>For Double Cut Only: Vertical Horizontal</td> </tr> </tbody> </table>			Ⓐ Wood Finish
Ⓐ Wood Finish	Ⓑ Chassis Grain Direction				
See Double Cut Wood Finish Options	For Double Cut Only: Vertical Horizontal				

Description	D	W	H	CTN WT	CU FT	① Model	HPL Laminate	Fiat Cut Veneer	Double Cut Veneer
Double Pedestal Desk with Break	42	84	29	370	69	FLT4284EDST	\$3,394		
Front Modesty Modesty Continuous Wire Channel - Split Top	42	84	29	370	69	FLV4284EDST		\$4,661	\$5,127
	42	78	29	357	64	FLT4278EDST	\$3,315		
	42	78	29	357	64	FLV4278EDST		\$4,550	\$5,009
	42	72	29	359	59	FLT4272EDST	\$3,241		
	42	72	29	359	59	FLV4272EDST		\$4,445	\$4,889

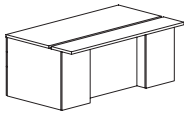
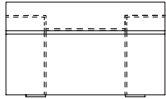
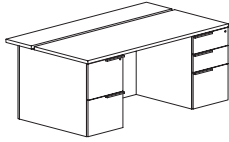

approach

Features:

- eased edge profile on approach and user sides
- built in horizontal wire channel
- 6" overhang on approach side
- pedestal front locking
- FLT4284EDST or FLV4284EDST - chassis 36" x 84"
- FLT4278EDST or FLV4278EDST - chassis 36" x 78"
- FLT4272EDST or FLV4272EDST - chassis 36" x 72"
- FLT4284EDST or FLV4284EDST - kneespace 48"
- FLT4278EDST or FLV4278EDST - kneespace 42"
- FLT4272EDST or FLV4272EDST - kneespace 36"

Options:

- must specify chassis grain direction on double cut veneer, see pages 11-13 for details
- veneer drawer fronts in paint available, specify paint color; add \$337 list; see page 14 for details
- on laminate units, contrasting worksurface tops and drawer fronts available, no upcharge; specify color, see page 14 for details
- ledge pulls standard; prism pulls available, specify and see page 9
- pedestal access doors available, specify; add \$283 list for laminate or \$337 list for veneer; see page 15 for details

Description	D	W	H	CTN WT	CU FT	① Model	HPL Laminate	Flat Cut Veneer	Double Cut Veneer
Double Pedestal Desk with Break	36	84	29	325	60	FLT3684EDST	\$3,236		
Front Modesty - Continuous Wire Channel - Split Top	36	84	29	325	60	FLV3684EDST		\$4,441	\$4,885
	36	78	29	314	55	FLT3678EDST	\$3,162		
	36	78	29	314	55	FLV3678EDST		\$4,336	\$4,771
	36	72	29	303	51	FLT3672EDST	\$3,090		
	36	72	29	303	51	FLV3672EDST		\$4,235	\$4,659
	36	66	29	315	47	FLT3666EDST	\$3,030		
	36	66	29	315	47	FLV3666EDST		\$4,155	\$4,572
	36	60	29	304	43	FLT3660EDST	\$2,975		
	36	60	29	304	43	FLV3660EDST		\$4,077	\$4,484

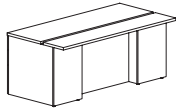
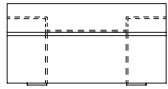
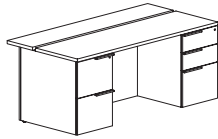

approach

Features:

- eased edge profile on approach and user sides
- built in horizontal wire channel
- 6" overhang on approach side
- pedestal front locking
- FLT3684EDST or FLV3684EDST - chassis 30" x 84"
- FLT3678EDST or FLV3678EDST - chassis 30" x 78"
- FLT3672EDST or FLV3672EDST - chassis 30" x 72"
- FLT3666EDST or FLV3666EDST - chassis 30" x 66"
- FLT3660EDST or FLV3660EDST - chassis 30" x 60"
- FLT3684EDST or FLV3684EDST - kneespace 48"
- FLT3678EDST or FLV3678EDST - kneespace 42"
- FLT3672EDST or FLV3672EDST - kneespace 36"
- FLT3666EDST or FLV3666EDST - kneespace 34 3/4"
- FLT3660EDST or FLV3660EDST - kneespace 28 3/4"

Options:

- must specify chassis grain direction on double cut veneer, see pages 11-13 for details
- veneer drawer fronts in paint available, specify paint color; add \$337 list; see page 14 for details
- on laminate units, contrasting worksurface tops and drawer fronts available, no upcharge; specify laminate color, see page 14 for details
- ledge pulls standard; prism pulls available, specify and see page 9
- pedestal access doors available, specify; add \$283 list for laminate or \$337 list for veneer; see page 15 for details

To Order, Specify:

① Laminate Model #	② Laminate Type	③ Laminate Selection	④ Metal Color	⑤ Other Product Options
Laminate (FLT)	HPL	See Laminate Selection	See Metal Finish Color Options	See list of options for each specific unit; Specify and add accordingly.

① Veneer Model #	② Wood Species	③ Wood Finish	④ Metal Color	⑤ Other Product Options	
Veneer (FLV)	Flat Cut CH1 Cherry MA1 Maple WA1 Walnut BO1 Black Oak	See Flat Cut Wood Finish Options	See Metal Finish Color Options	See list of options for each specific unit; Specify and add accordingly.	
	Double Cut DC1 Double Cut	<table border="1"> <thead> <tr> <th>ⓐ Wood Finish</th> <th>ⓑ Chassis Grain Direction</th> </tr> </thead> <tbody> <tr> <td>See Double Cut Wood Finish Options</td> <td>For Double Cut Only: Vertical Horizontal</td> </tr> </tbody> </table>			ⓐ Wood Finish
ⓐ Wood Finish	ⓑ Chassis Grain Direction				
See Double Cut Wood Finish Options	For Double Cut Only: Vertical Horizontal				

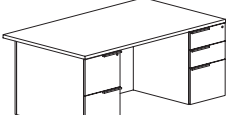
Description	D	W	H	CTN WT	CU FT	① Model	HPL Laminate	Flat Cut Veneer	Double Cut Veneer
	42	84	29	357	69	FLT4284ED	\$3,198		
	42	84	29	357	69	FLV4284ED		\$4,465	\$4,912
	42	78	29	359	64	FLT4278ED	\$3,120		
	42	78	29	359	64	FLV4278ED		\$4,355	\$4,791
	42	72	29	349	59	FLT4272ED	\$3,045		
	42	72	29	349	59	FLV4272ED		\$4,249	\$4,672

Features:

- eased edge profile on approach and user sides
- 6" overhang on approach side
- pedestal front locking
- FLT4284ED or FLV4284ED - chassis 36" x 84"
- FLT4278ED or FLV4278ED - chassis 36" x 78"
- FLT4272ED or FLV4272ED - chassis 36" x 72"
- FLT4284ED or FLV4284ED - kneespace 48"
- FLT4278ED or FLV4278ED - kneespace 42"
- FLT4272ED or FLV4272ED - kneespace 36"

Options:

- must specify chassis grain direction on double cut veneer, see pages 11-13 for details
- veneer drawer fronts in paint available, specify paint color; add \$337 list; see page 14 for details
- on laminate units, contrasting worksurface tops and drawer fronts available, no upcharge; specify color, see page 14 for details
- ledge pulls standard; prism pulls available, specify and see page 9
- top grommet available, specify location; add \$128 list each; see page 42 for details
- worksurface power available, specify "to accommodate EC26" on your purchase order; EC26 unit must be ordered separately, see page 42
- pedestal access door with wire manager available, use with top grommet, specify; add \$337 list for laminate or \$390 list for veneer; see page 15 for details
- interior kneespace wire manager available, use with top grommet or power unit, specify and add \$114 list; see page 15 for details

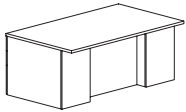
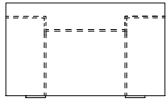

approach

Description	D	W	H	CTN WT	CU FT	① Model	HPL Laminate	Flat Cut Veneer	Double Cut Veneer
Double Pedestal Desk with Break Front Modesty	36	84	29	325	60	FLT3684ED	\$3,040		
	36	84	29	325	60	FLV3684ED		\$4,244	\$4,667
	36	78	29	314	55	FLT3678ED	\$2,966		
	36	78	29	314	55	FLV3678ED		\$4,140	\$4,554
	36	72	29	303	51	FLT3672ED	\$2,894		
	36	72	29	303	51	FLV3672ED		\$4,038	\$4,443
	36	66	29	315	47	FLT3666ED	\$2,836		
	36	66	29	315	47	FLV3666ED		\$3,959	\$4,355
	36	60	29	304	43	FLT3660ED	\$2,779		
	36	60	29	304	43	FLV3660ED		\$3,881	\$4,268

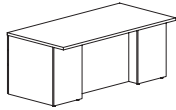
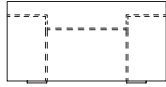
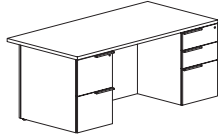

approach

Features:

- eased edge profile on approach and user sides
- 6" overhang on approach side
- pedestal front locking
- FLT3684ED or FLV3684ED - chassis 30" x 84"
- FLT3678ED or FLV3678ED - chassis 30" x 78"
- FLT3672ED or FLV3672ED - chassis 30" x 72"
- FLT3666ED or FLV3666ED - chassis 30" x 66"
- FLT3660ED or FLV3660ED - chassis 30" x 72"
- FLT3684ED or FLV3684ED - kneespace 48"
- FLT3678ED or FLV3678ED - kneespace 42"
- FLT3672ED or FLV3672ED - kneespace 36"
- FLT3666ED or FLV3666ED - kneespace 28 3/4"
- FLT3660ED or FLV3660ED - kneespace 28 3/4"

Options:

- must specify chassis grain direction on double cut veneer, see pages 11-13 for details
- veneer drawer fronts in paint available, specify paint color; add \$337 list; see page 14 for details
- on laminate units, contrasting worksurface tops and drawer fronts available, no upcharge; specify laminate color, see page 14 for details
- ledge pulls standard; prism pulls available, specify and see page 9
- top grommet available, specify location; add \$128 list each; see page 42 for details
- worksurface power available, specify "to accommodate EC26" on your purchase order; EC26 unit must be ordered separately, see page 42
- pedestal access door with wire manager available, use with top grommet, specify; add \$337 list for laminate or \$390 list for veneer; see page 15 for details

To Order, Specify:

① Laminate Model #	② Laminate Type	③ Laminate Selection	④ Metal Color	⑤ Other Product Options
Laminate (FLT)	HPL	See Laminate Selection	See Metal Finish Color Options	See list of options for each specific unit; Specify and add accordingly.

① Veneer Model #	② Wood Species	③ Wood Finish	④ Metal Color	⑤ Other Product Options	
Veneer (FLV)	Flat Cut CH1 Cherry MA1 Maple WA1 Walnut BO1 Black Oak	See Flat Cut Wood Finish Options	See Metal Finish Color Options	See list of options for each specific unit; Specify and add accordingly.	
	Double Cut DC1 Double Cut	<table border="1"> <thead> <tr> <th>ⓐ Wood Finish</th> <th>ⓑ Chassis Grain Direction</th> </tr> </thead> <tbody> <tr> <td>See Double Cut Wood Finish Options</td> <td>For Double Cut Only: Vertical Horizontal</td> </tr> </tbody> </table>			ⓐ Wood Finish
ⓐ Wood Finish	ⓑ Chassis Grain Direction				
See Double Cut Wood Finish Options	For Double Cut Only: Vertical Horizontal				

Description	D	W	H	CTN WT	CU FT	① Model	HPL Laminate	Fiat Cut Veneer	Double Cut Veneer
Double Pedestal Desk with Break	36	84	29	352	60	FLT3684DDST	\$3,330		
Front Modesty Continuous Wire Channel - Split Top	36	84	29	352	60	FLV3684DDST		\$4,572	\$5,029
	36	78	29	342	55	FLT3678DDST	\$3,255		
	36	78	29	342	55	FLV3678DDST		\$4,465	\$4,912
	36	72	29	331	51	FLT3672DDST	\$3,180		
	36	72	29	331	51	FLV3672DDST		\$4,360	\$4,796

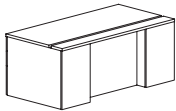
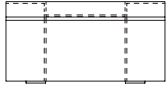
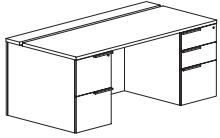

approach

Features:

- eased edge profile on approach and user sides
- built in horizontal wire channel
- pedestal front locking
- FLT3684DDST or FLV3684DDST - chassis 36" x 84"
- FLT3678DDST or FLV3678DDST - chassis 36" x 78"
- FLT3672DDST or FLV3672DDST - chassis 36" x 72"
- FLT3684DDST or FLV3684DDST - kneespace - 48"
- FLT3678DDST or FLV3678DDST - kneespace - 42"
- FLT3672DDST or FLV3672DDST - kneespace - 36"

Options:

- must specify chassis grain direction on double cut veneer, see pages 11-13 for details
- veneer drawer fronts in paint available, specify paint color; add \$337 list; see page 14 for details
- on laminate units, contrasting worksurface tops and drawer fronts available, no upcharge; specify color, see page 14 for details
- ledge pulls standard; prism pulls available, specify and see page 9
- pedestal access doors available, specify; add \$283 list for laminate or \$337 list for veneer; see page 15 for details

Description	D	W	H	CTN WT	CU FT	① Model	HPL Laminate	Flat Cut Veneer	Double Cut Veneer
Double Pedestal Desk with Break	30	84	29	307	50	FLT3084DDST	\$3,203		
Front Modesty - Continuous Wire Channel - Split Top	30	84	29	307	50	FLV3084DDST		\$4,394	\$4,832
	30	78	29	297	47	FLT3078DDST	\$3,130		
	30	78	29	297	47	FLV3078DDST		\$4,290	\$4,721
	30	72	29	287	43	FLT3072DDST	\$3,058		
	30	72	29	287	43	FLV3072DDST		\$4,191	\$4,611
	30	66	29	278	40	FLT3066DDST	\$2,987		
	30	66	29	278	40	FLV3066DDST		\$4,094	\$4,505
	30	60	29	269	36	FLT3060DDST	\$2,920		
	30	60	29	269	36	FLV3060DDST		\$4,000	\$4,400

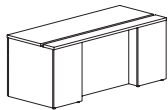
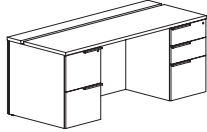

approach

Features:

- eased edge profile on approach and user sides
- built in horizontal wire channel
- pedestal front locking
- FLT3084DDST or FLV3084DDST - chassis 30" x 84"
- FLT3078DDST or FLV3078DDST - chassis 30" x 78"
- FLT3072DDST or FLV3072DDST - chassis 30" x 72"
- FLT3066DDST or FLV3066DDST - chassis 30" x 66"
- FLT3060DDST or FLV3060DDST - chassis 30" x 60"
- FLT3084DDST or FLV3084DDST - kneespace - 48"
- FLT3078DDST or FLV3078DDST - kneespace - 42"
- FLT3072DDST or FLV3072DDST - kneespace - 36"
- FLT3066DDST or FLV3066DDST - kneespace 34 3/4"
- FLT3060DDST or FLV3060DDST - kneespace 28 3/4"

Options:

- must specify chassis grain direction on double cut veneer, see pages 11-13 for details
- veneer drawer fronts in paint available, specify paint color; add \$337 list; see page 14 for details
- on laminate units, contrasting worksurface tops and drawer fronts available, no upcharge; specify laminate color, see page 14 for details
- pedestal access doors available, specify; add \$283 list for laminate or \$337 list for veneer; see page 15 for details

To Order, Specify:

① Laminate Model #	② Laminate Type	③ Laminate Selection	④ Metal Color	⑤ Other Product Options
Laminate (FLT)	HPL	See Laminate Selection	See Metal Finish Color Options	See list of options for each specific unit; Specify and add accordingly.

① Veneer Model #	② Wood Species	③ Wood Finish	④ Metal Color	⑤ Other Product Options	
Veneer (FLV)	Flat Cut CH1 Cherry MA1 Maple WA1 Walnut BO1 Black Oak	See Flat Cut Wood Finish Options	See Metal Finish Color Options	See list of options for each specific unit; Specify and add accordingly.	
	Double Cut DC1 Double Cut	<table border="1"> <thead> <tr> <th>ⓐ Wood Finish</th> <th>ⓑ Chassis Grain Direction</th> </tr> </thead> <tbody> <tr> <td>See Double Cut Wood Finish Options</td> <td>For Double Cut Only: Vertical Horizontal</td> </tr> </tbody> </table>			ⓐ Wood Finish
ⓐ Wood Finish	ⓑ Chassis Grain Direction				
See Double Cut Wood Finish Options	For Double Cut Only: Vertical Horizontal				

Description	D	W	H	CTN WT	CU FT	① Model	HPL Laminate	Fiat Cut Veneer	Double Cut Veneer
Double Pedestal Desk with Break Front Modesty	36	84	29	352	60	FLT3684DD	\$3,133		
	36	84	29	352	60	FLV3684DD		\$4,374	\$4,812
	36	78	29	342	55	FLT3678DD	\$3,058		
	36	78	29	342	55	FLV3678DD		\$4,268	\$4,696
	36	72	29	331	51	FLT3672DD	\$2,983		
	36	72	29	331	51	FLV3672DD		\$4,164	\$4,580

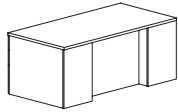
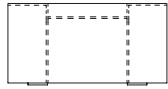
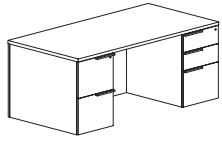

approach

Features:

- eased edge profile on approach and user sides
- pedestal front locking
- FLT3684DD or FLV3684DD - chassis 36" x 84"
- FLT3678DD or FLV3678DD - chassis 36" x 78"
- FLT3672DD or FLV3672DD - chassis 36" x 72"
- FLT3684DD or FLV3684DD - kneespace 48"
- FLT3678DD or FLV3678DD - kneespace 42"
- FLT3672DD or FLV3672DD - kneespace 36"

Options:

- must specify chassis grain direction on double cut veneer, see pages 11-13 for details
- veneer drawer fronts in paint available, specify paint color; add \$337 list; see page 14 for details
- on laminate units, contrasting worksurface tops and drawer fronts available, no upcharge; specify color, see page 14 for details
- ledge pulls standard; prism pulls available, specify and see page 9
- top grommet available, specify location; add \$128 list each; see page 42 for details
- worksurface power available, specify "to accommodate EC26" on your purchase order; EC26 unit must be ordered separately, see page 42
- pedestal access door with wire manager available, use with top grommet, specify; add \$337 list for laminate or \$390 list for veneer; see page 15 for details
- interior kneespace wire manager available, use with top grommet or power unit, specify and add \$114 list; see page 15 for details

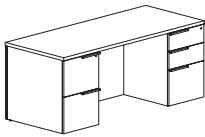
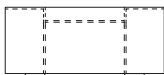
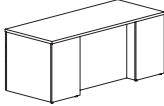
Description	D	W	H	CTN WT	CU FT	① Model	HPL Laminate	Flat Cut Veneer	Double Cut Veneer
   approach	30	84	29	307	50	FLT3084DD	\$3,007		
	30	84	29	307	50	FLV3084DD		\$4,196	\$4,616
	30	78	29	297	47	FLT3078DD	\$2,934		
	30	78	29	297	47	FLV3078DD		\$4,094	\$4,505
	30	72	29	287	43	FLT3072DD	\$2,862		
	30	72	29	287	43	FLV3072DD		\$3,995	\$4,395
	30	66	29	278	40	FLT3066DD	\$2,792		
	30	66	29	278	40	FLV3066DD		\$3,898	\$4,288
	30	60	29	269	36	FLT3060DD	\$2,723		
	30	60	29	269	36	FLV3060DD		\$3,804	\$4,184

Features:

- eased edge profile on approach and user sides
- pedestal front locking
- FLT3084DD or FLV3084DD - chassis 30" x 84"
- FLT3078DD or FLV3078DD - chassis 30" x 78"
- FLT3072DD or FLV3072DD - chassis 30" x 72"
- FLT3066DD or FLV3066DD - chassis 30" x 66"
- FLT3060DD or FLV3060DD - chassis 30" x 60"
- FLT3084DD or FLV3084DD - kneespace 48"
- FLT3078DD or FLV3078DD - kneespace 42"
- FLT3072DD or FLV3072DD - kneespace 36"
- FLT3066DD or FLV3066DD - kneespace 34 3/4"
- FLT3060DD or FLV3060DD - kneespace 28 3/4"

Options:

- must specify chassis grain direction on double cut veneer, see pages 11-13 for details
- veneer drawer fronts in paint available, specify paint color; add \$337 list; see page 14 for details
- on laminate units, contrasting worksurface tops and drawer fronts available, no upcharge; specify laminate color, see page 14 for details
- ledge pulls standard; prism pulls available, specify and see page 9
- top grommet available, specify location; add \$128 list each; see page 42 for details
- worksurface power available, specify "to accommodate EC26" on your purchase order; EC26 unit must be ordered separately, see page 42
- pedestal access door with wire manager available, use with top grommet, specify; add \$337 list for laminate or \$390 list for veneer; see page 15 for details

To Order, Specify:

① Laminate Model #	② Laminate Type	③ Laminate Selection	④ Metal Color	⑤ Other Product Options
Laminate (FLT)	HPL	See Laminate Selection	See Metal Finish Color Options	See list of options for each specific unit; Specify and add accordingly.

① Veneer Model #	② Wood Species	③ Wood Finish	④ Metal Color	⑤ Other Product Options
Veneer (FLV)	Flat Cut CH1 Cherry MA1 Maple WA1 Walnut BO1 Black Oak	See Flat Cut Wood Finish Options	See Metal Finish Color Options	See list of options for each specific unit; Specify and add accordingly.
		<table border="1"> <thead> <tr> <th>③a Wood Finish</th> <th>③b Chassis Grain Direction</th> </tr> </thead> <tbody> <tr> <td>See Double Cut Wood Finish Options</td> <td>For Double Cut Only: Vertical Horizontal</td> </tr> </tbody> </table>		
③a Wood Finish	③b Chassis Grain Direction			
See Double Cut Wood Finish Options	For Double Cut Only: Vertical Horizontal			

Description	D	W	H	CTN WT	CU FT	① Model	HPL Laminate	Fiat Cut Veneer	Double Cut Veneer
Double Pedestal Desk with Flush Modesty	36	84	29	333	60	FLT3684EDF	\$3,160		
	36	84	29	333	60	FLV3684EDF		\$4,141	\$4,555
	36	78	29	322	55	FLT3678EDF	\$3,083		
	36	78	29	322	55	FLV3678EDF		\$4,040	\$4,445
	36	72	29	312	51	FLT3672EDF	\$3,007		
	36	72	29	312	51	FLV3672EDF		\$3,941	\$4,334

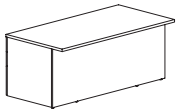
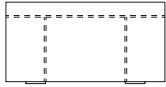
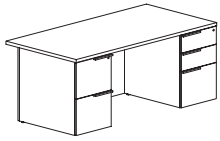

approach

Features:

- eased edge profile on approach and user sides
- 6" overhang on approach side
- pedestal front locking
- FLT3684EDF or FLV3684EDF - chassis 30" x 84"
- FLT3678EDF or FLV3678EDF - chassis 30" x 78"
- FLT3672EDF or FLV3672EDF - chassis 30" x 72"
- FLT3684EDF or FLV3684EDF - kneespace 48"
- FLT3678EDF or FLV3678EDF - kneespace 42"
- FLT3672EDF or FLV3672EDF - kneespace 36"

Options:

- must specify chassis grain direction on double cut veneer, see pages 11-13 for details
- veneer drawer fronts in paint available, specify paint color; add \$337 list; see page 14 for details
- on laminate units, contrasting worksurface tops and drawer fronts available, no upcharge; specify laminate color, see page 14 for details
- ledge pulls standard; prism pulls available, specify and see page 9
- top grommet available, specify location; add \$128 list each; see page 42 for details
- worksurface power available, specify "to accommodate EC26" on your purchase order; EC26 unit must be ordered separately, see page 42
- interior kneespace wire manager available, use with top grommet or power unit, specify and add \$114 list; see page 15 for details

Description	D	W	H	CTN WT	CU FT	① Model	HPL Laminate	Flat Cut Veneer	Double Cut Veneer
Double Pedestal Desk with Flush Modesty	30	72	29	268	43	FLT3072EDF	\$2,722		
	30	72	29	268	43	FLV3072EDF		\$3,800	\$4,178
	30	66	29	261	40	FLT3066EDF	\$2,669		
	30	66	29	261	40	FLV3066EDF		\$3,723	\$4,096
	30	60	29	254	36	FLT3060EDF	\$2,614		
	30	60	29	254	36	FLV3060EDF		\$3,649	\$4,015

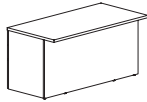
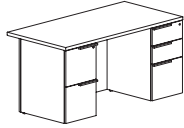

approach

Features:

- eased edge profile on approach and user sides
- 6" overhang on approach side
- pedestal front locking
- FLT3072EDF or FLV3072EDF - chassis 24" x 72"
- FLT3066EDF or FLV3066EDF - chassis 24" x 66"
- FLT3060EDF or FLV3060EDF - chassis 24" x 60"
- FLT3072EDF or FLV3072EDF - kneespace 36"
- FLT3066EDF or FLV3066EDF - kneespace 34 3/4"
- FLT3060EDF or FLV3060EDF - kneespace 28 3/4"

Options:

- must specify chassis grain direction on double cut veneer, see pages 11-13 for details
- veneer drawer fronts in paint available, specify paint color; add \$337 list; see page 14 for details
- on laminate units, contrasting worksurface tops and drawer fronts available, no upcharge; specify laminate color, see page 14 for details
- ledge pulls standard; prism pulls available, specify and see page 9
- top grommet available, specify location; add \$128 list each; see page 42 for details
- worksurface power available, specify "to accommodate EC26" on your purchase order; EC26 unit must be ordered separately, see page 42
- interior kneespace wire manager available, use with top grommet or power unit, specify and add \$114 list; see page 15 for details

To Order, Specify:

① Laminate Model #	② Laminate Type	③ Laminate Selection	④ Metal Color	⑤ Other Product Options
Laminate (FLT)	HPL	See Laminate Selection	See Metal Finish Color Options	See list of options for each specific unit; Specify and add accordingly.

① Veneer Model #	② Wood Species	③ Wood Finish	④ Metal Color	⑤ Other Product Options
Veneer (FLV)	Flat Cut CH1 Cherry MA1 Maple WA1 Walnut BO1 Black Oak	See Flat Cut Wood Finish Options	See Metal Finish Color Options	See list of options for each specific unit; Specify and add accordingly.
		<table border="1"> <thead> <tr> <th>③a Wood Finish</th> <th>③b Chassis Grain Direction</th> </tr> </thead> <tbody> <tr> <td>See Double Cut Wood Finish Options</td> <td>For Double Cut Only: Vertical Horizontal</td> </tr> </tbody> </table>		
③a Wood Finish	③b Chassis Grain Direction			
See Double Cut Wood Finish Options	For Double Cut Only: Vertical Horizontal			

Description	D	W	H	CTN WT	CU FT	① Model	HPL Laminate	Fiat Cut Veneer	Double Cut Veneer
Double Pedestal Desk with Flush Modesty - Continuous Wire Channel - Split Top	30	84	29	307	50	FLT3084DDSTF	\$3,109		
	30	84	29	307	50	FLV3084DDSTF		\$4,463	\$4,909
	30	78	29	297	47	FLT3078DDSTF	\$3,039		
	30	78	29	297	47	FLV3078DDSTF		\$4,259	\$4,685
	30	72	29	287	43	FLT3072DDSTF	\$2,968		
	30	72	29	287	43	FLV3072DDSTF		\$4,067	\$4,472
	30	66	29	278	40	FLT3066DDSTF	\$2,911		
	30	66	29	278	40	FLV3066DDSTF		\$3,988	\$4,390
	30	60	29	269	36	FLT3060DDSTF	\$2,859		
	30	60	29	269	36	FLV3060DDSTF		\$3,914	\$4,304

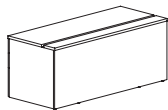
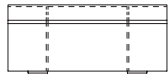
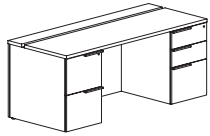

approach

Features:

- eased edge profile on approach and user sides
- built in horizontal wire channel
- pedestal front locking
- FLT3084DDSTF or FLV3084DDSTF - chassis 30" x 84"
- FLT3078DDSTF or FLV3078DDSTF - chassis 30" x 78"
- FLT3072DDSTF or FLV3072DDSTF - chassis 30" x 72"
- FLT3066DDSTF or FLV3066DDSTF - chassis 30" x 66"
- FLT3060DDSTF or FLV3060DDSTF - chassis 30" x 60"
- FLT3084DDSTF or FLV3084DDSTF - kneespace 48"
- FLT3078DDSTF or FLV3078DDSTF - kneespace 42"
- FLT3072DDSTF or FLV3072DDSTF - kneespace 36"
- FLT3066DDSTF or FLV3066DDSTF - kneespace 34 3/4"
- FLT3060DDSTF or FLV3060DDSTF - kneespace 28 3/4"

Options:

- must specify chassis grain direction on double cut veneer, see pages 11-13 for details
- veneer drawer fronts in paint available, specify paint color; add \$337 list; see page 14 for details
- on laminate units, contrasting worksurface tops and drawer fronts available, no upcharge; specify laminate color, see page 14 for details
- ledge pulls standard; prism pulls available, specify and see page 9

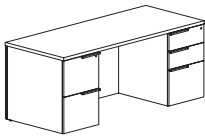
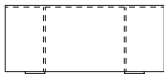
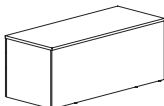
Description	D	W	H	CTN WT	CU FT	① Model	HPL Laminate	Flat Cut Veneer	Double Cut Veneer
   approach	30	84	29	307	50	FLT3084DDF	\$2,911		
	30	84	29	307	50	FLV3084DDF		\$4,266	\$4,693
	30	78	29	297	47	FLT3078DDF	\$2,841		
	30	78	29	297	47	FLV3078DDF		\$4,064	\$4,468
	30	72	29	287	43	FLT3072DDF	\$2,770		
	30	72	29	287	43	FLV3072DDF		\$3,869	\$4,255
	30	66	29	278	40	FLT3066DDF	\$2,716		
	30	66	29	278	40	FLV3066DDF		\$3,791	\$4,172
	30	60	29	269	36	FLT3060DDF	\$2,662		
	30	60	29	269	36	FLV3060DDF		\$3,717	\$4,089

Features:

- eased edge profile on approach and user sides
- pedestal front locking
- FLT3084DDF or FLV3084DDF - chassis 30" x 84"
- FLT3078DDF or FLV3078DDF - chassis 30" x 78"
- FLT3072DDF or FLV3072DDF - chassis 30" x 72"
- FLT3066DDF or FLV3066DDF - chassis 30" x 60"
- FLT3060DDF or FLV3060DDF - chassis 30" x 60"
- FLT3084DDF or FLV3084DDF - kneespace 48"
- FLT3078DDF or FLV3078DDF - kneespace 42"
- FLT3072DDF or FLV3072DDF - kneespace 36"
- FLT3066DDF or FLV3066DDF - kneespace 34 3/4"
- FLT3060DDF or FLV3060DDF - kneespace 28 3/4"

Options:

- must specify chassis grain direction on double cut veneer, see pages 11-13 for details
- veneer drawer fronts in paint available, specify paint color; add \$337 list; see page 14 for details
- on laminate units, contrasting worksurface tops and drawer fronts available, no upcharge; specify laminate color, see page 14 for details
- ledge pulls standard; prism pulls available, specify and see page 9
- top grommet available, specify location; add \$128 list each; see page 42 for details
- worksurface power available, specify "to accommodate EC26" on your purchase order; EC26 unit must be ordered separately, see page 42

To Order, Specify:

① Laminate Model #	② Laminate Type	③ Laminate Selection	④ Metal Color	⑤ Other Product Options
Laminate (FLT)	HPL	See Laminate Selection	See Metal Finish Color Options	See list of options for each specific unit; Specify and add accordingly.

① Veneer Model #	② Wood Species	③ Wood Finish	④ Metal Color	⑤ Other Product Options
Veneer (FLV)	Flat Cut CH1 Cherry MA1 Maple WA1 Walnut BO1 Black Oak	See Flat Cut Wood Finish Options	See Metal Finish Color Options	See list of options for each specific unit; Specify and add accordingly.
		<table border="1"> <thead> <tr> <th>③a Wood Finish</th> <th>③b Chassis Grain Direction</th> </tr> </thead> <tbody> <tr> <td>See Double Cut Wood Finish Options</td> <td>For Double Cut Only: Vertical Horizontal</td> </tr> </tbody> </table>		
③a Wood Finish	③b Chassis Grain Direction			
See Double Cut Wood Finish Options	For Double Cut Only: Vertical Horizontal			

Description	D	W	H	CTN WT	CU FT	① Model	HPL Laminate	Flat Cut Veneer	Double Cut Veneer
Bow Front Single Pedestal Desk with Break Front Modesty Continuous Wire Channel - Split Top	42	84	29	318	69	FLT4284RBDST	\$3,097		
	42	84	29	318	69	FLV4284RBDST		\$4,166	\$4,582
	42	84	29	318	69	FLT4284LBDST	\$3,097		
	42	84	29	318	69	FLV4284LBDST		\$4,166	\$4,582
	42	78	29	307	64	FLT4278RBDST	\$3,030		
	42	78	29	307	64	FLV4278RBDST		\$4,074	\$4,482
	42	78	29	307	64	FLT4278LBDST	\$3,030		
	42	78	29	307	64	FLV4278LBDST		\$4,074	\$4,482
	42	72	29	296	59	FLT4272RBDST	\$2,968		
	42	72	29	296	59	FLV4272RBDST		\$3,985	\$4,381
	42	72	29	296	59	FLT4272LBDST	\$2,968		
	42	72	29	296	59	FLV4272LBDST		\$3,985	\$4,381

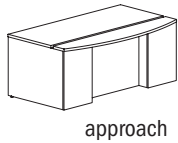
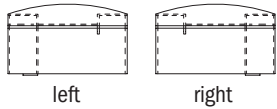
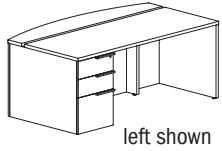

Features:

- eased edge profile on approach and user sides
- built in horizontal wire channel
- 6" overhang on approach side
- pedestal front locking
- FLT4284RBDST or FLT4284LBDST and FLV4284RBDST or FLV4284LBDST - chassis 36" x 84"
- FLT4278RBDST or FLT4278LBDST and FLV4278RBDST or FLV4278LBDST - chassis 36" x 78"
- FLT4272RBDST or FLT4272LBDST and FLV4272RBDST or FLV4272LBDST - chassis 36" x 72"

Options:

- must specify chassis grain direction on double cut veneer, see pages 11-13 for details
- veneer drawer fronts in paint available, specify paint color; add \$337 list; see page 14 for details
- on laminate units, contrasting worksurface tops and drawer fronts available, no upcharge; specify color, see page 14 for details
- ledge pulls standard; prism pulls available, specify and see page 9
- pedestal access doors available, specify; add \$283 list for laminate or \$337 list for veneer; see page 15 for details

FLUX - PRIVATE OFFICE

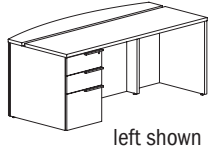
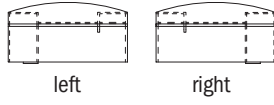
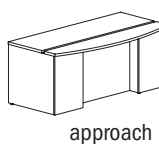
Description	D	W	H	CTN WT	CU FT	① Model	HPL Laminate	Flat Cut Veneer	Double Cut Veneer
 <p>left shown</p>  <p>left right</p>  <p>approach</p>	36	84	29	285	60	FLT3684RBDST	\$2,950		
	36	84	29	285	60	FLV3684RBDST		\$4,040	\$4,445
	36	84	29	285	60	FLT3684LBDST	\$2,950		
	36	84	29	285	60	FLV3684LBDST		\$4,040	\$4,445
	36	78	29	276	55	FLT3678RBDST	\$2,882		
	36	78	29	276	55	FLV3678RBDST		\$3,948	\$4,340
	36	78	29	276	55	FLT3678LBDST	\$2,882		
	36	78	29	276	55	FLV3678LBDST		\$3,948	\$4,340
	36	72	29	267	51	FLT3672RBDST	\$2,819		
	36	72	29	267	51	FLV3672RBDST		\$3,854	\$4,241
	36	72	29	267	51	FLT3672LBDST	\$2,819		
	36	72	29	267	51	FLV3672LBDST		\$3,854	\$4,241
	36	66	29	258	47	FLT3666RBDST	\$2,755		
	36	66	29	258	47	FLV3666RBDST		\$3,767	\$4,144
	36	66	29	258	47	FLT3666LBDST	\$2,755		
	36	66	29	258	47	FLV3666LBDST		\$3,767	\$4,144
	36	60	29	249	43	FLT3660RBDST	\$2,691		
	36	60	29	249	43	FLV3660RBDST		\$3,680	\$4,048
	36	60	29	249	43	FLT3660LBDST	\$2,691		
	36	60	29	249	43	FLV3660LBDST		\$3,680	\$4,048

Features:

- eased edge profile on approach and user sides
- built in horizontal wire channel
- 6" overhang on approach side
- pedestal front locking
- FLT3684RBDST or FLT3684LBDST and FLV3684RBDST or FLV3684LBDST - chassis 30" x 84"
- FLT3678RBDST or FLT3678LBDST and FLV3678RBDST or FLV3678LBDST - chassis 30" x 78"
- FLT3672RBDST or FLT3672LBDST and FLV3672RBDST or FLV3672LBDST - chassis 30" x 72"
- FLT3666RBDST or FLT3666LBDST and FLV3666RBDST or FLV3666LBDST - chassis 30" x 66"
- FLT3660RBDST or FLT3660LBDST and FLV3660RBDST or FLV3660LBDST - chassis 30" x 60"

Options:

- must specify chassis grain direction on double cut veneer, see pages 11-13 for details
- veneer drawer fronts in paint available, specify paint color; add \$337 list; see page 14 for details
- on laminate units, contrasting worksurface tops and drawer fronts available, no upcharge; specify laminate color, see page 14 for details
- ledge pulls standard; prism pulls available, specify and see page 9
- pedestal access doors available, specify; add \$283 list for laminate or \$337 list for veneer; see page 15 for details

To Order, Specify:

① Laminate Model #	② Laminate Type	③ Laminate Selection	④ Metal Color	⑤ Other Product Options
Laminate (FLT)	HPL	See Laminate Selection	See Metal Finish Color Options	See list of options for each specific unit; Specify and add accordingly.

① Veneer Model #	② Wood Species	③ Wood Finish	④ Metal Color	⑤ Other Product Options
Veneer (FLV)	Flat Cut CH1 Cherry MA1 Maple WA1 Walnut BO1 Black Oak	See Flat Cut Wood Finish Options	See Metal Finish Color Options	See list of options for each specific unit; Specify and add accordingly.
		<table border="1"> <tr> <th>Ⓐ Wood Finish</th> <th>Ⓑ Chassis Grain Direction</th> </tr> <tr> <td>See Double Cut Wood Finish Options</td> <td>For Double Cut Only: Vertical Horizontal</td> </tr> </table>		
Ⓐ Wood Finish	Ⓑ Chassis Grain Direction			
See Double Cut Wood Finish Options	For Double Cut Only: Vertical Horizontal			

FLUX - PRIVATE OFFICE

Description	D	W	H	CTN WT	CU FT	① Model	HPL Laminate	Flat Cut Veneer	Double Cut Veneer
Bow Front Single Pedestal Desk with Break Front Modesty	42	84	29	318	69	FLT4284RBD	\$2,901		
	42	84	29	318	69	FLV4284RBD		\$3,968	\$4,365
	42	84	29	318	69	FLT4284LBD	\$2,901		
	42	84	29	318	69	FLV4284LBD		\$3,968	\$4,365
	42	78	29	307	64	FLT4278RBD	\$2,836		
	42	78	29	307	64	FLV4278RBD		\$3,878	\$4,266
	42	78	29	307	64	FLT4278LBD	\$2,836		
	42	78	29	307	64	FLV4278LBD		\$3,878	\$4,266
	42	72	29	296	59	FLT4272RBD	\$2,770		
	42	72	29	296	59	FLV4272RBD		\$3,788	\$4,166
	42	72	29	296	59	FLT4272LBD	\$2,770		
	42	72	29	296	59	FLV4272LBD		\$3,788	\$4,166

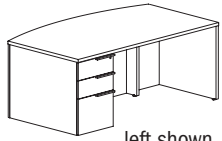

left shown

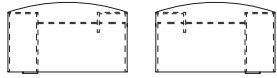

left

right

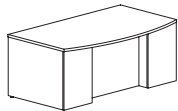

approach

Features:

- eased edge profile on approach and user sides
- 6" overhang on approach side
- pedestal front locking
- FLT4284RBD or FLT4284LBD and FLV4284RBD or FLV4284LBD - chassis 36" x 84"
- FLT4278RBD or FLT4278LBD and FLV4278RBD or FLV4278LBD - chassis 36" x 78"
- FLT4272RBD or FLT4272LBD and FLV4272RBD or FLV4272LBD - chassis 36" x 72"

Options:

- must specify chassis grain direction on double cut veneer, see pages 11-13 for details
- veneer drawer fronts in paint available, specify paint color and add \$337 list; see page 14 for details
- on laminate units, contrasting worksurface tops and drawer fronts available, no upcharge; specify laminate color, see page 14 for details
- ledge pulls standard; prism pulls available, specify and see page 9
- top grommet available, specify location; add \$128 list each; see page 42 for details
- worksurface power available, specify "to accommodate EC26" on your purchase order; EC26 unit must be ordered separately, see page 42
- pedestal access door with wire manager available, use with top grommet, specify; add \$337 list for laminate or \$390 list for veneer; see page 15 for details
- interior kneespace wire manager available, use with top grommet or power unit, specify and add \$114 list; see page 15 for details

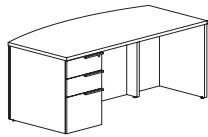
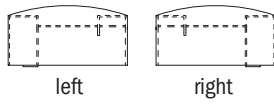
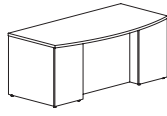
Description	D	W	H	CTN WT	CU FT	① Model	HPL Laminate	Flat Cut Veneer	Double Cut Veneer
 <p>left shown</p>  <p>left right</p>  <p>approach</p>	36	84	29	285	60	FLT3684RBD	\$2,755		
	36	84	29	285	60	FLV3684RBD		\$3,844	\$4,228
	36	84	29	285	60	FLT3684LBD	\$2,755		
	36	84	29	285	60	FLV3684LBD		\$3,844	\$4,228
	36	78	29	276	55	FLT3678RBD	\$2,687		
	36	78	29	276	55	FLV3678RBD		\$3,751	\$4,125
	36	78	29	276	55	FLT3678LBD	\$2,687		
	36	78	29	276	55	FLV3678LBD		\$3,751	\$4,125
	36	72	29	267	51	FLT3672RBD	\$2,621		
	36	72	29	267	51	FLV3672RBD		\$3,659	\$4,026
	36	72	29	267	51	FLT3672LBD	\$2,621		
	36	72	29	267	51	FLV3672LBD		\$3,659	\$4,026
	36	66	29	258	47	FLT3666RBD	\$2,559		
	36	66	29	258	47	FLV3666RBD		\$3,571	\$3,926
	36	66	29	258	47	FLT3666LBD	\$2,559		
	36	66	29	258	47	FLV3666LBD		\$3,571	\$3,926
	36	60	29	249	43	FLT3660RBD	\$2,495		
	36	60	29	249	43	FLV3660RBD		\$3,482	\$3,832
	36	60	29	249	43	FLT3660LBD	\$2,495		
	36	60	29	249	43	FLV3660LBD		\$3,482	\$3,832

Features:

- eased edge profile on approach and user sides
- 6" overhang on approach side
- pedestal front locking
- FLT3684RBD or FLT3684LBD and FLV3684RBD or FLV3684LBD - chassis 30" x 84"
- FLT3678RBD or FLT3678LBD and FLV3678RBD or FLV3678LBD - chassis 30" x 78"
- FLT3672RBD or FLT3672LBD and FLV3672RBD or FLV3672LBD - chassis 30" x 72"
- FLT3666RBD or FLT3666LBD and FLV3666RBD or FLV3666LBD - chassis 30" x 66"
- FLT3660RBD or FLT3660LBD and FLV3660RBD or FLV3660LBD - chassis 30" x 60"

Options:

- must specify chassis grain direction on double cut veneer, see pages 11-13 for details
- veneer drawer fronts in paint available, specify paint color; add \$337 list; see page 14 for details
- on laminate units, contrasting worksurface tops and drawer fronts available, no upcharge; specify laminate color, see page 14 for details
- ledge pulls standard; prism pulls available, specify and see page 9
- top grommet available, specify location; add \$128 list each; see page 42 for details
- worksurface power available, specify "to accommodate EC26" on your purchase order; EC26 unit must be ordered separately, see page 42
- pedestal access door with wire manager available, use with top grommet, specify; add \$337 list for laminate or \$390 list for veneer; see page 15 for details
- interior kneespace wire manager available, use with top grommet or power unit, specify and add \$114 list; see page 15 for details

To Order, Specify:

① Laminate Model #	② Laminate Type	③ Laminate Selection	④ Metal Color	⑤ Other Product Options
Laminate (FLT)	TFL	See Laminate Selection	See Metal Finish Color Options	See list of options for each specific unit; Specify and add accordingly.
	HPL			
	HLP			

① Veneer Model #	② Wood Species	③ Wood Finish	④ Metal Color	⑤ Other Product Options
Veneer (FLV)	Flat Cut CH1 Cherry MA1 Maple WA1 Walnut BO1 Black Oak	See Flat Cut Wood Finish Options	See Metal Finish Color Options	See list of options for each specific unit; Specify and add accordingly.
	Double Cut DC1 Double Cut	ⓐ Wood Finish See Double Cut Wood Finish Options		

Description	D	W	H	CTN WT	CU FT	① Model	HPL Laminate	Flat Cut Veneer	Double Cut Veneer
Single Pedestal Desk with Break	42	84	29	325	69	FLT4284REDST	\$2,893		
Front Modesty - Continuous Wire Channel - Split Top	42	84	29	325	69	FLV4284REDST		\$3,960	\$4,357
	42	84	29	325	69	FLT4284LEDST	\$2,893		
	42	84	29	325	69	FLV4284LEDST		\$3,960	\$4,357
	42	78	29	314	64	FLT4278REDST	\$2,827		
	42	78	29	314	64	FLV4278REDST		\$3,869	\$4,255
	42	78	29	314	64	FLT4278LEDST	\$2,827		
	42	78	29	314	64	FLV4278LEDST		\$3,869	\$4,255
	42	72	29	303	59	FLT4272REDST	\$2,762		
	42	72	29	303	59	FLV4272REDST		\$3,779	\$4,156
	42	72	29	303	59	FLT4272LEDST	\$2,762		
	42	72	29	303	59	FLV4272LEDST		\$3,779	\$4,156

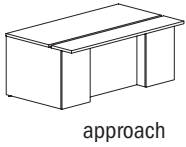
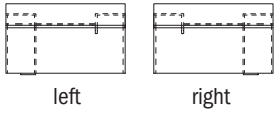
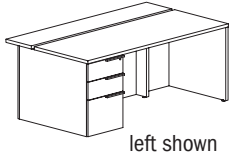

Features:

- eased edge profile on approach and user sides
- built in horizontal wire channel
- 6" overhang on approach side
- pedestal front locking
- FLT4284REDST or FLT4284LEDST and FLV4284REDST or FLV4284LEDST - chassis 36" x 84"
- FLT4278REDST or FLT4278LEDST and FLV4278REDST or FLV4278LEDST - chassis 36" x 78"
- FLT4272REDST or FLT4272LEDST and FLV4272REDST or FLV4272LEDST - chassis 36" x 72"

Options:

- must specify chassis grain direction on double cut veneer, see pages 11-13 for details
- veneer drawer fronts in paint available, specify paint color; add \$337 list; see page 14 for details
- on laminate units, contrasting worksurface tops and drawer fronts available, no upcharge; specify laminate color, see page 14 for details
- ledge pulls standard; prism pulls available, specify and see page 9
- pedestal access doors available, specify; add \$283 list for laminate or \$337 list for veneer; see page 15 for details

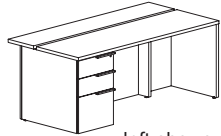
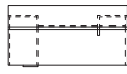
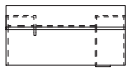
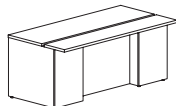
Description	D	W	H	CTN WT	CU FT	① Model	HPL Laminate	Flat Cut Veneer	Double Cut Veneer
 <p>left shown</p>   <p>left right</p>  <p>approach</p>	36	84	29	289	60	FLT3684REDST	\$2,764		
	36	84	29	289	60	FLV3684REDST		\$3,781	\$4,160
	36	84	29	289	60	FLT3684LEDST	\$2,764		
	36	84	29	289	60	FLV3684LEDST		\$3,781	\$4,160
	36	78	29	280	55	FLT3678REDST	\$2,701		
	36	78	29	280	55	FLV3678REDST		\$3,696	\$4,065
	36	78	29	280	55	FLT3678LEDST	\$2,701		
	36	78	29	280	55	FLV3678LEDST		\$3,696	\$4,065
	36	72	29	271	51	FLT3672REDST	\$2,641		
	36	72	29	271	51	FLV3672REDST		\$3,607	\$3,968
	36	72	29	271	51	FLT3672LEDST	\$2,641		
	36	72	29	271	51	FLV3672LEDST		\$3,607	\$3,968
	36	66	29	264	47	FLT3666REDST	\$2,592		
	36	66	29	264	47	FLV3666REDST		\$3,540	\$3,893
	36	66	29	264	47	FLT3666LEDST	\$2,592		
	36	66	29	264	47	FLV3666LEDST		\$3,540	\$3,893
	36	60	29	255	43	FLT3660REDST	\$2,544		
	36	60	29	255	43	FLV3660REDST		\$3,474	\$3,822
	36	60	29	255	43	FLT3660LEDST	\$2,544		
	36	60	29	255	43	FLV3660LEDST		\$3,474	\$3,822

Features:

- eased edge profile on approach and user sides
- built in horizontal wire channel
- 6" overhang on approach side
- pedestal front locking
- FLT3684REDST or FLT3684LEDST and FLV3684REDST or FLV3684LEDST - chassis 30" x 84"
- FLT3678REDST or FLT3678LEDST and FLV3678REDST or FLV3678LEDST - chassis 30" x 78"
- FLT3672REDST or FLT3672LEDST and FLV3672REDST or FLV3672LEDST - chassis 30" x 72"
- FLT3666REDST or FLT3666LEDST and FLV3666REDST or FLV3666LEDST - chassis 30" x 66"
- FLT3660REDST or FLT3660LEDST and FLV3660REDST or FLV3660LEDST - chassis 30" x 60"

Options:

- must specify chassis grain direction on double cut veneer, see pages 11-13 for details
- veneer drawer fronts in paint available, specify paint color; add \$337 list; see page 14 for details
- on laminate units, contrasting worksurface tops and drawer fronts available, no upcharge; specify laminate color, see page 14 for details
- ledge pulls standard; prism pulls available, specify and see page 9
- pedestal access doors available, specify; add \$283 list for laminate or \$337 list for veneer; see page 15 for details

To Order, Specify:

① Laminate Model #	② Laminate Type	③ Laminate Selection	④ Metal Color	⑤ Other Product Options
Laminate (FLT)	HPL	See Laminate Selection	See Metal Finish Color Options	See list of options for each specific unit; Specify and add accordingly.

① Veneer Model #	② Wood Species	③ Wood Finish	④ Metal Color	⑤ Other Product Options
Veneer (FLV)	Flat Cut CH1 Cherry MA1 Maple WA1 Walnut BO1 Black Oak	See Flat Cut Wood Finish Options	See Metal Finish Color Options	See list of options for each specific unit; Specify and add accordingly.
		<table border="1"> <tr> <th>ⓐ Wood Finish</th> <th>ⓑ Chassis Grain Direction</th> </tr> <tr> <td>See Double Cut Wood Finish Options</td> <td>For Double Cut Only: Vertical Horizontal</td> </tr> </table>		
ⓐ Wood Finish	ⓑ Chassis Grain Direction			
See Double Cut Wood Finish Options	For Double Cut Only: Vertical Horizontal			

FLUX - PRIVATE OFFICE

Description	D	W	H	CTN WT	CU FT	① Model	HPL Laminate	Flat Cut Veneer	Double Cut Veneer
Single Pedestal Desk with Break Front Modesty	42	84	29	325	69	FLT4284RED	\$2,695		
	42	84	29	325	69	FLV4284RED		\$3,764	\$4,140
	42	84	29	325	69	FLT4284LED	\$2,695		
	42	84	29	325	69	FLV4284LED		\$3,764	\$4,140
	42	78	29	314	64	FLT4278RED	\$2,632		
	42	78	29	314	64	FLV4278RED		\$3,671	\$4,038
	42	78	29	314	64	FLT4278LED	\$2,632		
	42	78	29	314	64	FLV4278LED		\$3,671	\$4,038
	42	72	29	303	59	FLT4272RED	\$2,567		
	42	72	29	303	59	FLV4272RED		\$3,583	\$3,941
	42	72	29	303	59	FLT4272LED	\$2,567		
	42	72	29	303	59	FLV4272LED		\$3,583	\$3,941

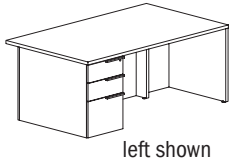

left shown

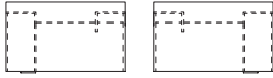

left

right

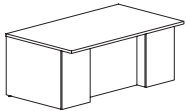

approach

Features:

- eased edge profile on approach and user sides
- 6" overhang on approach side
- pedestal front locking
- FLT4284RED or FLT4284LED and FLV4284RED or FLV4284LED - chassis 36" X 84"
- FLT4278RED or FLT4278LED and FLV4278RED or FLV4278LED - chassis 36" X 78"
- FLT4272RED or FLT4272LED and FLV4272RED or FLV4272LED - chassis 36" X 72"

Options:

- must specify chassis grain direction on double cut veneer, see pages 11-13 for details
- veneer drawer fronts in paint available, specify paint color and add \$337 list; see page 14 for details
- on laminate units, contrasting worksurface tops and drawer fronts available, no upcharge; specify laminate color, see page 14 for details
- ledge pulls standard; prism pulls available, specify and see page 9
- top grommet available, specify location; add \$128 list each; see page 42 for details
- worksurface power available, specify "to accommodate EC26" on your purchase order; EC26 unit must be ordered separately, see page 42
- pedestal access door with wire manager available, use with top grommet, specify; add \$337 list for laminate or \$390 list for veneer; see page 15 for details
- interior kneespace wire manager available, use with top grommet or power unit, specify and add \$114 list; see page 15 for details

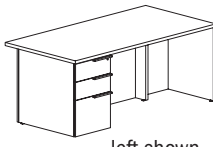
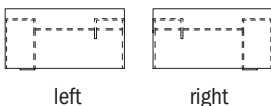
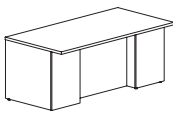
Description	D	W	H	CTN WT	CU FT	① Model	HPL Laminate	Flat Cut Veneer	Double Cut Veneer
Single Pedestal Desk with Break Front Modesty	36	84	29	289	60	FLT3684RED	\$2,568		
	36	84	29	289	60	FLV3684RED		\$3,585	\$3,944
 left shown	36	84	29	289	60	FLT3684LED	\$2,568		
	36	84	29	289	60	FLV3684LED		\$3,585	\$3,944
 left right	36	78	29	280	55	FLT3678RED	\$2,504		
	36	78	29	280	55	FLV3678RED		\$3,499	\$3,847
 approach	36	78	29	280	55	FLT3678LED	\$2,504		
	36	78	29	280	55	FLV3678LED		\$3,499	\$3,847
	36	72	29	271	51	FLT3672RED	\$2,444		
	36	72	29	271	51	FLV3672RED		\$3,412	\$3,753
	36	72	29	271	51	FLT3672LED	\$2,444		
	36	72	29	271	51	FLV3672LED		\$3,412	\$3,753
	36	66	29	264	47	FLT3666RED	\$2,395		
	36	66	29	264	47	FLV3666RED		\$3,344	\$3,678
	36	66	29	264	47	FLT3666LED	\$2,395		
	36	66	29	264	47	FLV3666LED		\$3,344	\$3,678
	36	60	29	255	43	FLT3660RED	\$2,348		
	36	60	29	255	43	FLV3660RED		\$3,277	\$3,605
	36	60	29	255	43	FLT3660LED	\$2,348		
	36	60	29	255	43	FLV3660LED		\$3,277	\$3,605

Features:

- eased edge profile on approach and user sides
- 6" overhang on approach side
- pedestal front locking
- FLT3684RED or FLT3684LED and FLV3684RED or FLV3684LED - chassis 30" x 84"
- FLT3678RED or FLT3678LED and FLV3678RED or FLV3678LED - chassis 30" x 78"
- FLT3672RED or FLT3672LED and FLV3672RED or FLV3672LED - chassis 30" x 72"
- FLV3666RED or FLV3666LED and FLT3666RED or FLT3666LED - chassis 30" x 66"
- FLT3660RED or FLT3660LED and FLV3660RED or FLV3660LED - chassis 30" x 60"

Options:

- must specify chassis grain direction on double cut veneer, see pages 11-13 for details
- veneer drawer fronts in paint available, specify paint color; add \$337 list; see page 14 for details
- on laminate units, contrasting worksurface tops and drawer fronts available, no upcharge; specify laminate color, see page 14 for details
- ledge pulls standard; prism pulls available, specify and see page 9
- top grommet available, specify location; add \$128 list each; see page 42 for details
- worksurface power available, specify "to accommodate EC26" on your purchase order; EC26 unit must be ordered separately, see page 42
- pedestal access door with wire manager available, use with top grommet, specify; add \$337 list for laminate or \$390 list for veneer; see page 15 for details
- interior kneespace wire manager available, use with top grommet or power unit, specify and add \$114 list; see page 15 for details

To Order, Specify:

① Laminate Model #	② Laminate Type	③ Laminate Selection	④ Metal Color	⑤ Other Product Options
Laminate (FLT)	TFL HPL HLP	See Laminate Selection	See Metal Finish Color Options	See list of options for each specific unit; specify and add accordingly.

① Veneer Model #	② Wood Species	③ Wood Finish - Finishes with an asterisk (*) have a coordinating laminate available	④ Metal Color	⑤ Other Product Options		
Veneer (FLV)	Flat Cut CH1 Cherry MA1 Maple WA1 Walnut BO1 Black Oak	See Flat Cut Wood Finish Options	See Metal Finish Color Options	See list of options for each specific unit; Specify and add accordingly.		
	Double Cut DC1 Double Cut	<table border="1"> <tr> <th>Ⓐ Wood Finish</th> <th>Ⓑ Chassis Grain Direction</th> </tr> <tr> <td>See Double Cut Wood Finish Options</td> <td>For Double Cut Only: Vertical Horizontal</td> </tr> </table>	Ⓐ Wood Finish		Ⓑ Chassis Grain Direction	See Double Cut Wood Finish Options
Ⓐ Wood Finish	Ⓑ Chassis Grain Direction					
See Double Cut Wood Finish Options	For Double Cut Only: Vertical Horizontal					

Description	D	W	H	CTN WT	CU FT	① Model	HPL Laminate	Flat Cut Veneer	Double Cut Veneer
Single Pedestal Desk with Break	36	84	29	306	60	FLT3684RDST	\$2,828		
Front Modesty -Continuous Wire Channel - Split Top	36	84	29	306	60	FLV3684RDST		\$3,871	\$4,258
	36	84	29	306	60	FLT3684LDST	\$2,828		
	36	84	29	306	60	FLV3684LDST		\$3,871	\$4,258
	36	78	29	295	55	FLT3678RDST	\$2,764		
	36	78	29	295	55	FLV3678RDST		\$3,781	\$4,160
	36	78	29	295	55	FLT3678LDST	\$2,764		
	36	78	29	295	55	FLV3678LDST		\$3,781	\$4,160
	36	72	29	284	51	FLT3672RDST	\$2,752		
	36	72	29	284	51	FLV3672RDST		\$3,695	\$4,064
	36	72	29	284	51	FLT3672LDST	\$2,752		
	36	72	29	284	51	FLV3672LDST		\$3,695	\$4,064

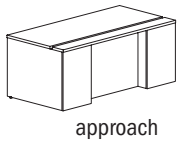
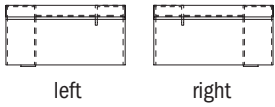
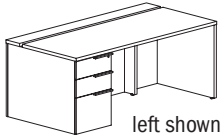



Features:

- eased edge profile on approach and user sides
- built in horizontal wire channel
- pedestal front locking
- FLT3684RDST or FLT3684LDST and FLV3684RDST or FLV3684LDST - chassis 36" x 84"
- FLT3678RDST or FLT3678LDST and FLV3678RDST or FLV3678LDST - chassis 36" x 78"
- FLT3672RDST or FLT3672LDST and FLV3672RDST or FLV3672LDST - chassis 36" x 72"

Options:

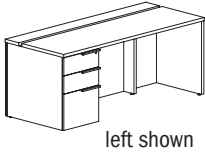
- must specify chassis grain direction on double cut veneer, see pages 11-13 for details
- veneer drawer fronts in paint available, specify paint color and add \$337 list; see page 14 for details
- on laminate units, contrasting worksurface tops and drawer fronts available, no upcharge; specify laminate color, see page 14 for details
- ledge pulls standard; prism pulls available, specify and see page 9
- pedestal access doors available, specify; add \$283 list for laminate or \$337 list for veneer; see page 15 for details

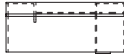
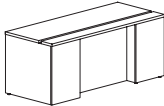
Description	D	W	H	CTN WT	CU FT	① Model	HPL Laminate	Flat Cut Veneer	Double Cut Veneer
Single Pedestal Desk with Break Front Modesty - Continuous Wire Channel - Split Top	30	84	29	272	50	FLT3084RDST	\$2,730		
	30	84	29	272	50	FLV3084RDST		\$3,733	\$4,107
	30	84	29	272	50	FLT3084LDST	\$2,730		
	30	84	29	272	50	FLV3084LDST		\$3,733	\$4,107
 	30	78	29	264	47	FLT3078RDST	\$2,671		
	30	78	29	264	47	FLV3078RDST		\$3,647	\$4,012
	30	78	29	264	47	FLT3078LDST	\$2,671		
	30	78	29	264	47	FLV3078LDST		\$3,647	\$4,012
	30	72	29	256	43	FLT3072RDST	\$2,609		
	30	72	29	256	43	FLV3072RDST		\$3,564	\$3,919
	30	72	29	256	43	FLT3072LDST	\$2,609		
	30	72	29	256	43	FLV3072LDST		\$3,564	\$3,919
	30	66	29	248	40	FLT3066RDST	\$2,550		
	30	66	29	248	40	FLV3066RDST		\$3,481	\$3,831
	30	66	29	248	40	FLT3066LDST	\$2,550		
	30	66	29	248	40	FLV3066LDST		\$3,481	\$3,831
	30	60	29	240	36	FLT3060RDST	\$2,494		
	30	60	29	240	36	FLV3060RDST		\$3,401	\$3,743
	30	60	29	240	36	FLT3060LDST	\$2,494		
	30	60	29	240	36	FLV3060LDST		\$3,401	\$3,743

Features:

- eased edge profile on approach and user sides
- built in horizontal wire channel
- pedestal front locking
- FLT3084RDST or FLT3084LDST and FLV3084RDST or FLV3084LDST - chassis 30" x 84"
- FLT3078RDST or FLT3078LDST and FLV3078RDST or FLV3078LDST - chassis 30" x 78"
- FLT3072RDST or FLT3072LDST and FLV3072RDST or FLV3072LDST - chassis 30" x 72"
- FLT3066RDST or FLT3066LDST and FLV3066RDST or FLV3066LDST - chassis 30" x 66"
- FLT3060RDST or FLT3060LDST and FLV3060RDST or FLV3060LDST - chassis 30" x 60"

Options:

- must specify chassis grain direction on double cut veneer, see pages 11-13 for details
- veneer drawer fronts in paint available, specify paint color; add \$337 list; see page 14 for details
- on laminate units, contrasting worksurface tops and drawer fronts available, no upcharge; specify laminate color, see page 14 for details
- ledge pulls standard; prism pulls available, specify and see page 9
- pedestal access doors available, specify; add \$283 list for laminate or \$337 list for veneer; see page 15 for details

To Order, Specify:

① Laminate Model #	② Laminate Type	③ Laminate Selection	④ Metal Color	⑤ Other Product Options
Laminate (FLT)	HPL	See Laminate Selection	See Metal Finish Color Options	See list of options for each specific unit; Specify and add accordingly.

① Veneer Model #	② Wood Species	③ Wood Finish	④ Metal Color	⑤ Other Product Options
Veneer (FLV)	Flat Cut CH1 Cherry MA1 Maple WA1 Walnut BO1 Black Oak	See Flat Cut Wood Finish Options	See Metal Finish Color Options	See list of options for each specific unit; Specify and add accordingly.
		<table border="1"> <tr> <th>ⓐ Wood Finish</th> <th>ⓑ Chassis Grain Direction</th> </tr> <tr> <td>See Double Cut Wood Finish Options</td> <td>For Double Cut Only: Vertical Horizontal</td> </tr> </table>		
ⓐ Wood Finish	ⓑ Chassis Grain Direction			
See Double Cut Wood Finish Options	For Double Cut Only: Vertical Horizontal			

FLUX - PRIVATE OFFICE

Description	D	W	H	CTN WT	CU FT	① Model	HPL Laminate	Flat Cut Veneer	Double Cut Veneer
Single Pedestal Desk with Break Front Modesty	36	84	29	306	60	FLT3684RD	\$2,633		
	36	84	29	306	60	FLV3684RD		\$3,674	\$4,041
	36	84	29	306	60	FLT3684LD	\$2,633		
	36	84	29	306	60	FLV3684LD		\$3,674	\$4,041
	36	78	29	295	55	FLT3678RD	\$2,568		
	36	78	29	295	55	FLV3678RD		\$3,585	\$3,944
	36	78	29	295	55	FLT3678LD	\$2,568		
	36	78	29	295	55	FLV3678LD		\$3,585	\$3,944
	36	72	29	284	51	FLT3672RD	\$2,554		
	36	72	29	284	51	FLV3672RD		\$3,498	\$3,846
	36	72	29	284	51	FLT3672LD	\$2,554		
	36	72	29	284	51	FLV3672LD		\$3,498	\$3,846

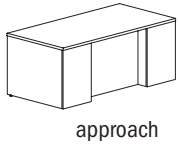
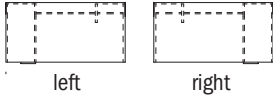
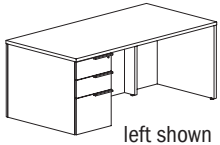

Features:

- eased edge profile on approach and user sides
- pedestal front locking
- FLT3684RD or FLT3684RD and FLV3684LD or FLV3684LD - chassis 36" x 84"
- FLT3678RD or FLT3678LD and FLV3678RD or FLV3678LD - chassis 36" x 78"
- FLT3672RD or FLT3672LD and FLV3672RD or FLV3672LD - chassis 36" x 72"

Options:

- must specify chassis grain direction on double cut veneer, see pages 11-13 for details
- veneer drawer fronts in paint available, specify paint color and add \$337 list; see page 14 for details
- on laminate units, contrasting worksurface tops and drawer fronts available, no upcharge; specify laminate color, see page 14 for details
- ledge pulls standard; prism pulls available, specify and see page 9
- top grommet available, specify location; add \$128 list each; see page 42 for details
- worksurface power available, specify "to accommodate EC26" on your purchase order; EC26 unit must be ordered separately, see page 42
- pedestal access door with wire manager available, use with top grommet, specify; add \$337 list for laminate or \$390 list for veneer; see page 15 for details
- interior kneespace wire manager available, use with top grommet or power unit, specify and add \$114 list; see page 15 for details

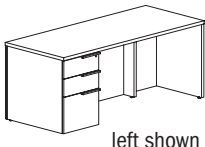
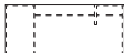
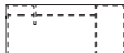
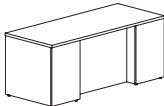
Description	D	W	H	CTN WT	CU FT	① Model	HPL Laminate	Flat Cut Veneer	Double Cut Veneer
Single Pedestal Desk with Break Front Modesty	30	84	29	272	50	FLT3084RD	\$2,532		
	30	84	29	272	50	FLV3084RD		\$3,536	\$3,891
	30	84	29	272	50	FLT3084LD	\$2,532		
	30	84	29	272	50	FLV3084LD		\$3,536	\$3,891
 	30	78	29	264	47	FLT3078RD	\$2,471		
	30	78	29	264	47	FLV3078RD		\$3,452	\$3,795
	30	78	29	264	47	FLT3078LD	\$2,471		
	30	78	29	264	47	FLV3078LD		\$3,452	\$3,795
	30	72	29	256	43	FLT3072RD	\$2,413		
	30	72	29	256	43	FLV3072RD		\$3,368	\$3,703
	30	72	29	256	43	FLT3072LD	\$2,413		
	30	72	29	256	43	FLV3072LD		\$3,368	\$3,703
	30	66	29	248	40	FLT3066RD	\$2,353		
	30	66	29	248	40	FLV3066RD		\$3,285	\$3,615
	30	66	29	248	40	FLT3066LD	\$2,353		
	30	66	29	248	40	FLV3066LD		\$3,285	\$3,615
	30	60	29	240	36	FLT3060RD	\$2,296		
	30	60	29	240	36	FLV3060RD		\$3,205	\$3,526
	30	60	29	240	36	FLT3060LD	\$2,296		
	30	60	29	240	36	FLV3060LD		\$3,205	\$3,526

Features:

- eased edge profile on approach and user sides
- pedestal front locking
- FLT3084RD or FLT3084LD and FLV3084RD or FLV3084LD - chassis 30" x 84"
- FLT3078RD or FLT3078LD and FLV3078RD or FLV3078LD - chassis 30" x 78"
- FLT3072RD or FLT3072LD and FLV3072RD or FLV3072LD - chassis 30" x 72"
- FLT3066RD or FLT3066LD and FLV3066RD or FLV3066LD - chassis 30" x 66"
- FLT3060RD or FLT3060LD and FLV3060RD or FLV3060LD - chassis 30" x 60"

Options:

- must specify chassis grain direction on double cut veneer, see pages 11-13 for details
- veneer drawer fronts in paint available, specify paint color; add \$337 list; see page 14 for details
- on laminate units, contrasting worksurface tops and drawer fronts available, no upcharge; specify laminate color, see page 14 for details
- ledge pulls standard; prism pulls available, specify and see page 9
- top grommet available, specify location; add \$128 list each; see page 42 for details
- worksurface power available, specify "to accommodate EC26" on your purchase order; EC26 unit must be ordered separately, see page 42
- pedestal access door with wire manager available, use with top grommet, specify; add \$337 list for laminate or \$390 list for veneer; see page 15 for details
- interior kneespace wire manager available, use with top grommet or power unit, specify and add \$114 list; see page 15 for details

To Order, Specify:

① Laminate Model #	② Laminate Type	③ Laminate Selection	④ Metal Color	⑤ Other Product Options
Laminate (FLT)	HPL	See Laminate Selection	See Metal Finish Color Options	See list of options for each specific unit; Specify and add accordingly.

① Veneer Model #	② Wood Species	③ Wood Finish	④ Metal Color	⑤ Other Product Options	
Veneer (FLV)	Flat Cut CH1 Cherry MA1 Maple WA1 Walnut BO1 Black Oak	See Flat Cut Wood Finish Options	See Metal Finish Color Options	See list of options for each specific unit; Specify and add accordingly.	
	Double Cut DC1 Double Cut	<table border="1"> <tr> <th>Ⓐ Wood Finish</th> <th>Ⓑ Chassis Grain Direction</th> </tr> <tr> <td>See Double Cut Wood Finish Options</td> <td>For Double Cut Only: Vertical Horizontal</td> </tr> </table>			Ⓐ Wood Finish
Ⓐ Wood Finish	Ⓑ Chassis Grain Direction				
See Double Cut Wood Finish Options	For Double Cut Only: Vertical Horizontal				

Description	D	W	H	CTN WT	CU FT	① Model	HPL Laminate	Flat Cut Veneer	Double Cut Veneer
Single Pedestal Desk with Flush Modesty	36	84	29	272	60	FLT3684REDF	\$2,436		
	36	84	29	272	60	FLV3684REDF		\$3,400	\$3,742
	36	84	29	272	60	FLT3684LEDF	\$2,436		
	36	84	29	272	60	FLV3684LEDF		\$3,400	\$3,742
	36	78	29	263	55	FLT3678REDF	\$2,377		
	36	78	29	263	55	FLV3678REDF		\$3,317	\$3,649
	36	78	29	263	55	FLT3678LEDF	\$2,377		
	36	78	29	263	55	FLV3678LEDF		\$3,317	\$3,649
	36	72	29	254	51	FLT3672REDF	\$2,320		
	36	72	29	254	51	FLV3672REDF		\$3,237	\$3,562
	36	72	29	254	51	FLT3672LEDF	\$2,320		
	36	72	29	254	51	FLV3672LEDF		\$3,237	\$3,562

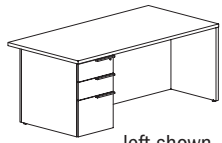

left shown

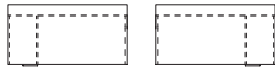

left

right

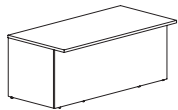



approach

Features:

- eased edge profile on approach and user sides
- 6" overhang on approach side
- pedestal front locking
- FLT3684REDF or FLT3684LEDF and FLV3684REDF or FLV3684LEDF - chassis 30" x 84"
- FLT3678REDF or FLV3678LEDF and FLV3678REDF or FLV3678LEDF - chassis 30" x 78"
- FLT3672REDF or FLT3672LEDF and FLV3672REDF or FLV3672LEDF - chassis 30" x 72"

Options:

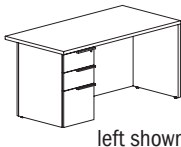
- must specify chassis grain direction on double cut veneer, see pages 11-13 for details
- veneer drawer fronts in paint available, specify paint color and add \$337 list; see page 14 for details
- on laminate units, contrasting worksurface tops and drawer fronts available, no upcharge; specify laminate color, see page 14 for details
- ledge pulls standard; prism pulls available, specify and see page 9
- top grommet available, specify location; add \$128 list each; see page 42 for details
- worksurface power available, specify "to accommodate EC26" on your purchase order; EC26 unit must be ordered separately, see page 42
- interior kneespace wire manager available, use with top grommet or power unit, specify and add \$114 list; see page 15 for details

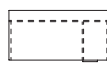
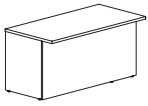
Description	D	W	H	CTN WT	CU FT	① Model	HPL Laminate	Flat Cut Veneer	Double Cut Veneer
Single Pedestal Desk with Flush Modesty  left shown   left right  approach	30	72	29	219	43	FLT3072REDF	\$2,212		
	30	72	29	219	43	FLV3072REDF		\$3,089	\$3,398
	30	72	29	219	43	FLT3072LEDF	\$2,212		
	30	72	29	219	43	FLV3072LEDF		\$3,089	\$3,398
	30	66	29	212	40	FLT3066REDF	\$2,159		
	30	66	29	212	40	FLV3066REDF		\$3,013	\$3,314
	30	66	29	212	40	FLT3066LEDF	\$2,159		
	30	66	29	212	40	FLV3066LEDF		\$3,013	\$3,314
	30	60	29	205	36	FLT3060REDF	\$2,107		
	30	60	29	205	36	FLV3060REDF		\$2,940	\$3,235
	30	60	29	205	36	FLT3060LEDF	\$2,107		
	30	60	29	205	36	FLV3060LEDF		\$2,940	\$3,235

Features:

- eased edge profile on approach and user sides
- 6" overhang on approach side
- pedestal front locking
- FLT3072REDF or FLT3072LEDF and FLV3072REDF or FLV3072LEDF - chassis 24" x 72"
- FLT3066REDF or FLT3066LEDF and FLV3066REDF or FLV3066LEDF - chassis 24" x 66"
- FLT3060REDF or FLT3060LEDF and FLV3060REDF or FLV3060LEDF - chassis 24" x 60"

Options:

- must specify chassis grain direction on double cut veneer, see pages 11-13 for details
- veneer drawer fronts in paint available, specify paint color and add \$337 list; see page 14 for details
- on laminate units, contrasting worksurface tops and drawer fronts available, no upcharge; specify laminate color, see page 14 for details
- ledge pulls standard; prism pulls available, specify and see page 9
- top grommet available, specify location; add \$128 list each; see page 42 for details
- worksurface power available, specify "to accommodate EC26" on your purchase order; EC26 unit must be ordered separately, see page 42
- interior kneespace wire manager available, use with top grommet or power unit, specify and add \$114 list; see page 15 for details

To Order, Specify:

① Laminate Model #	② Laminate Type	③ Laminate Selection	④ Metal Color	⑤ Other Product Options
Laminate (FLT)	HPL	See Laminate Selection	See Metal Finish Color Options	See list of options for each specific unit; Specify and add accordingly.

① Veneer Model #	② Wood Species	③ Wood Finish	④ Metal Color	⑤ Other Product Options
Veneer (FLV)	Flat Cut CH1 Cherry MA1 Maple WA1 Walnut BO1 Black Oak	See Flat Cut Wood Finish Options	See Metal Finish Color Options	See list of options for each specific unit; Specify and add accordingly.
		<table border="1"> <thead> <tr> <th>ⓐ Wood Finish</th> <th>ⓑ Chassis Grain Direction</th> </tr> </thead> <tbody> <tr> <td>See Double Cut Wood Finish Options</td> <td>For Double Cut Only: Vertical Horizontal</td> </tr> </tbody> </table>		
ⓐ Wood Finish	ⓑ Chassis Grain Direction			
See Double Cut Wood Finish Options	For Double Cut Only: Vertical Horizontal			

Description	D	W	H	CTN WT	CU FT	① Model	HPL Laminate	Flat Cut Veneer	Double Cut Veneer
Single Pedestal Desk with Flush Modesty - Continuous Wire Channel - Split Top	30	84	29	259	50	FLT3084RDSTF	\$2,568		
	30	84	29	259	50	FLV3084RDSTF		\$3,505	\$3,856
	30	84	29	259	50	FLT3084LDSTF	\$2,568		
	30	84	29	259	50	FLV3084LDSTF		\$3,505	\$3,856
	30	78	29	251	47	FLT3078RDSTF	\$2,509		
	30	78	29	251	47	FLV3078RDSTF		\$3,426	\$3,769
	30	78	29	251	47	FLT3078LDSTF	\$2,509		
	30	78	29	251	47	FLV3078LDSTF		\$3,426	\$3,769
	30	72	29	243	43	FLT3072RDSTF	\$2,564		
	30	72	29	243	43	FLV3072RDSTF		\$3,346	\$3,681
	30	72	29	243	43	FLT3072LDSTF	\$2,564		
	30	72	29	243	43	FLV3072LDSTF		\$3,346	\$3,681
	30	66	29	235	40	FLT3066RDSTF	\$2,407		
	30	66	29	235	40	FLV3066RDSTF		\$3,283	\$3,613
	30	66	29	235	40	FLT3066LDSTF	\$2,407		
	30	66	29	235	40	FLV3066LDSTF		\$3,283	\$3,613
	30	60	29	227	36	FLT3060RDSTF	\$2,365		
	30	60	29	227	36	FLV3060RDSTF		\$3,221	\$3,544
	30	60	29	227	36	FLT3060LDSTF	\$2,365		
	30	60	29	227	36	FLV3060LDSTF		\$3,221	\$3,544

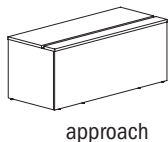
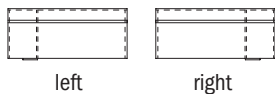
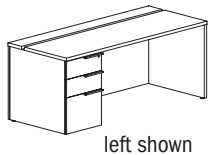

Features:

- eased edge profile on approach and user sides
- built in horizontal wire channel
- pedestal front locking
- FLT3084RDSTF or FLT3084LDSTF and FLV3084RDSTF or FLV3084LDSTF - chassis 30" x 84"
- FLT3078RDSTF or FLT3078LDSTF and FLV3078RDSTF or FLV3078LDSTF - chassis 30" x 78"
- FLT3072RDSTF or FLT3072LDSTF and FLV3072RDSTF or FLV3072LDSTF - chassis 30" x 72"
- FLT3066RDSTF or FLT3066LDSTF and FLV3066RDSTF or FLV3066LDSTF - chassis 30" x 66"
- FLT3060RDSTF or FLT3060LDSTF and FLV3060RDSTF or FLV3060LDSTF - chassis 30" x 60"

Options:

- must specify chassis grain direction on double cut veneer, see pages 11-13 for details
- veneer drawer fronts in paint available, specify paint color; add \$337 list; see page 14 for details
- on laminate units, contrasting worksurface tops and drawer fronts available, no upcharge; specify laminate color, see page 14 for details
- ledge pulls standard; prism pulls available, specify and see page 9

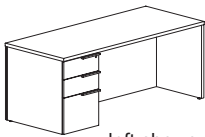
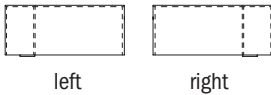
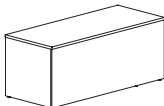
Description	D	W	H	CTN WT	CU FT	① Model	HPL Laminate	Flat Cut Veneer	Double Cut Veneer
 <p>left shown</p>  <p>left right</p>  <p>approach</p>	30	84	29	259	50	FLT3084RDF	\$2,371		
	30	84	29	259	50	FLV3084RDF		\$3,309	\$3,640
	30	84	29	259	50	FLT3084LDF	\$2,371		
	30	84	29	259	50	FLV3084LDF		\$3,309	\$3,640
	30	78	29	251	47	FLT3078RDF	\$2,313		
	30	78	29	251	47	FLV3078RDF		\$3,229	\$3,553
	30	78	29	251	47	FLT3078LDF	\$2,313		
	30	78	29	251	47	FLV3078LDF		\$3,229	\$3,553
	30	72	29	243	43	FLT3072RDF	\$2,259		
	30	72	29	243	43	FLV3072RDF		\$3,150	\$3,464
	30	72	29	243	43	FLT3072LDF	\$2,259		
	30	72	29	243	43	FLV3072LDF		\$3,150	\$3,464
	30	66	29	235	40	FLT3066RDF	\$2,210		
	30	66	29	235	40	FLV3066RDF		\$3,087	\$3,395
	30	66	29	235	40	FLT3066LDF	\$2,210		
	30	66	29	235	40	FLV3066LDF		\$3,087	\$3,395
	30	60	29	227	36	FLT3060RDF	\$2,168		
	30	60	29	227	36	FLV3060RDF		\$3,024	\$3,328
	30	60	29	227	36	FLT3060LDF	\$2,168		
	30	60	29	227	36	FLV3060LDF		\$3,024	\$3,328

Features:

- eased edge profile on approach and user sides
- pedestal front locking
- FLT3084RDF or FLT3084LDF and FLV3084RDF or FLV3084LDF - chassis 30" x 84"
- FLT3078RDF or FLT3078LDF and FLV3078RDF or FLV3078LDF - chassis 30" x 78"
- FLT3072RDF or FLT3072LDF and FLV3072RDF or FLV3072LDF - chassis 30" x 72"
- FLT3066RDF or FLT3066LDF and FLV3066RDF or FLV3066LDF - chassis 30" x 66"
- FLT3060RDF or FLT3060LDF and FLV3060RDF or FLV3060LDF - chassis 30" x 60"



Options:

- must specify chassis grain direction on double cut veneer, see pages 11-13 for details
- veneer drawer fronts in paint available, specify paint color; add \$337 list; see page 14 for details
- on laminate units, contrasting worksurface tops and drawer fronts available, no upcharge; specify laminate color, see page 14 for details
- ledge pulls standard; prism pulls available, specify and see page 9
- top grommet available, specify location; add \$128 list each; see page 42 for details
- worksurface power available, specify "to accommodate EC26" on your purchase order; EC26 unit must be ordered separately, see page 42
- interior kneespace wire manager available, use with top grommet or power unit, specify and add \$114 list; see page 15 for details

To Order, Specify:

① Laminate Model #	② Laminate Type	③ Laminate Selection	④ Metal Color	⑤ Other Product Options
Laminate (FLT)	HPL	See Laminate Selection	See Metal Finish Color Options	See list of options for each specific unit; Specify and add accordingly.

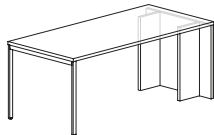
① Veneer Model #	② Wood Species	③ Wood Finish	④ Metal Color	⑤ Other Product Options
Veneer (FLV)	Flat Cut CH1 Cherry MA1 Maple WA1 Walnut BO1 Black Oak	See Flat Cut Wood Finish Options	See Metal Finish Color Options	See list of options for each specific unit; Specify and add accordingly.
		<table border="1"> <thead> <tr> <th>ⓐ Wood Finish</th> <th>ⓑ Chassis Grain Direction</th> </tr> </thead> <tbody> <tr> <td>See Double Cut Wood Finish Options</td> <td>For Double Cut Only: Vertical Horizontal</td> </tr> </tbody> </table>		
ⓐ Wood Finish	ⓑ Chassis Grain Direction			
See Double Cut Wood Finish Options	For Double Cut Only: Vertical Horizontal			

Description	D	W	H	CTN WT	CU FT	① Model	HPL Laminate	Flat Cut Veneer	Double Cut Veneer
Rectangular Peninsula Table Desk with End Leg Assembly and Panel End  	33½	84	29	169	56	FLT3484PDNEP	\$2,193		
	33½	84	29	169	56	FLV3484PDNEP		\$2,893	\$3,182
	33½	78	29	161	52	FLT3478PDNEP	\$2,157		
	33½	78	29	161	52	FLV3478PDNEP		\$2,842	\$3,128
	33½	72	29	153	48	FLT3472PDNEP	\$2,120		
	33½	72	29	153	48	FLV3472PDNEP		\$2,795	\$3,074
	33½	66	29	145	44	FLT3466PDNEP	\$2,085		
	33½	66	29	145	44	FLV3466PDNEP		\$2,747	\$3,022

Features:

- intended to be used with bridges or return units, see pages 154-159
- eased edge profile on approach and user sides

Options:

- must specify support panels grain direction on double cut veneer, see pages 11-13 for details
- on laminate units, contrasting worksurface tops and chassis available, no upcharge; specify color see page 14 for details
- 13 ½”h modesty panel available, specify; add \$427 list for laminate or \$594 list for veneer; see page 19 for details
- top grommet available, specify location; add \$128 list each; see page 42 for details
- 12” wide top grommet available, specify location; add \$168 list each; see page 42 for details
- worksurface power available, specify “to accommodate EC26” on your purchase order; EC26 unit must be ordered separately, see page 42
- wire manager tray available see accessory section on pages 48-49 for details

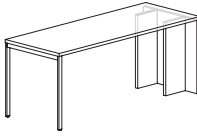
Description	D	W	H	CTN WT	CU FT	① Model	HPL Laminate	Flat Cut Veneer	Double Cut Veneer
Rectangular Peninsula Table	27 1/2	84	29	145	46	FLT2884PDNEP	\$2,116		
Desk with End Leg Assembly and Panel End 	27 1/2	84	29	145	46	FLV2884PDNEP		\$2,791	\$3,069
	27 1/2	78	29	139	43	FLT2878PDNEP	\$2,081		
	27 1/2	78	29	139	43	FLV2878PDNEP		\$2,744	\$3,018
	27 1/2	72	29	133	40	FLT2872PDNEP	\$2,047		
	27 1/2	72	29	133	40	FLV2872PDNEP		\$2,695	\$2,966
	27 1/2	66	29	127	37	FLT2866PDNEP	\$2,022		
	27 1/2	66	29	127	37	FLV2866PDNEP		\$2,662	\$2,930



Features:

- intended to be used with bridges or return units, see pages 154-159
- eased edge profile on approach and user sides

Options:

- must specify support panels grain direction on double cut veneer, see pages 11-13 for details
- on laminate units, contrasting worksurface tops and chassis available, no upcharge; specify color see page 14 for details
- 13 1/2" h modesty panel available, specify; add \$427 list for laminate or \$594 list for veneer; see page 19 for details
- top grommet available, specify location; add \$128 list each; see page 42 for details
- 12" wide top grommet available, specify location; add \$168 list each; see page 42 for details
- worksurface power available, specify "to accommodate EC26" on your purchase order; EC26 unit must be ordered separately, see page 42
- wire manager tray available see accessory section on pages 48-49 for details

To Order, Specify:

① Laminate Model #	② Laminate Type	③ Laminate Selection	④ Metal Color	⑤ Other Product Options
Laminate (FLT)	HPL	See Laminate Selection	See Metal Finish Color Options	See list of options for each specific unit; Specify and add accordingly.

① Veneer Model #	② Wood Species	③ Wood Finish	④ Metal Color	⑤ Other Product Options
Veneer (FLV)	Flat Cut CH1 Cherry MA1 Maple WA1 Walnut BO1 Black Oak	See Flat Cut Wood Finish Options	See Metal Finish Color Options	See list of options for each specific unit; Specify and add accordingly.
		<table border="1"> <thead> <tr> <th>③a Wood Finish</th> <th>③b Chassis Grain Direction</th> </tr> </thead> <tbody> <tr> <td>See Double Cut Wood Finish Options</td> <td>For Double Cut Only: Vertical Horizontal</td> </tr> </tbody> </table>		
③a Wood Finish	③b Chassis Grain Direction			
See Double Cut Wood Finish Options	For Double Cut Only: Vertical Horizontal			

Description	D	W	H	CTN WT	CU FT	① Model	HPL Laminate	Flat Cut Veneer	Double Cut Veneer
Rectangular Peninsula Table Desk with Frame Base and Panel End	33½	84	29	169	56	FLT3484PDPEP	\$2,193		
	33½	84	29	169	56	FLV3484PDPEP		\$2,893	\$3,182
	33½	78	29	161	52	FLT3478PDPEP	\$2,157		
	33½	78	29	161	52	FLV3478PDPEP		\$2,842	\$3,128
	33½	72	29	153	48	FLT3472PDPEP	\$2,120		
	33½	72	29	153	48	FLV3472PDPEP		\$2,795	\$3,074
	33½	66	29	145	44	FLT3466PDPEP	\$2,085		
	33½	66	29	145	44	FLV3466PDPEP		\$2,747	\$3,022

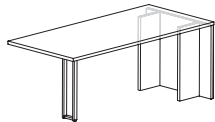

Features:

- must be used with run-off credenza or return units, see pages 154-159
- eased edge profile on approach and user sides

Options:

- must specify support panels grain direction on double cut veneer, see pages 11-13 for details
- on laminate units, contrasting worksurface tops and chassis available, no upcharge; specify color see page 14 for details
- 13 ½”h modesty panel available, specify; add \$427 list for laminate or \$594 list for veneer; see page 19 for details
- top grommet available, specify location; add \$128 list each; see page 42 for details
- 12” wide top grommet available, specify location; add \$168 list each; see page 42 for details
- worksurface power available, specify “to accommodate EC26” on your purchase order; EC26 unit must be ordered separately, see page 42
- wire manager tray available see accessory section on pages 48-49 for details

Description	D	W	H	CTN WT	CU FT	① Model	HPL Laminate	Flat Cut Veneer	Double Cut Veneer
Rectangular Peninsula Table	27 1/2	84	29	145	46	FLT2884PDPEP	\$2,116		
Desk with Frame Base and Panel End	27 1/2	84	29	145	46	FLV2884PDPEP		\$2,791	\$3,069
	27 1/2	78	29	139	43	FLT2878PDPEP	\$2,081		
	27 1/2	78	29	139	43	FLV2878PDPEP		\$2,744	\$3,018
	27 1/2	72	29	133	40	FLT2872PDPEP	\$2,047		
	27 1/2	72	29	133	40	FLV2872PDPEP		\$2,695	\$2,966
	27 1/2	66	29	127	37	FLT2866PDPEP	\$2,022		
	27 1/2	66	29	127	37	FLV2866PDPEP		\$2,662	\$2,930

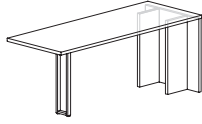

Features:

- must be used with run-off credenza or return units, see pages 154-159
- eased edge profile on approach and user sides

Options:

- must specify support panels grain direction on double cut veneer, see pages 11-13 for details
- on laminate units, contrasting worksurface tops and chassis available, no upcharge; specify color see page 14 for details
- 13 1/2" h modesty panel available, specify; add \$427 list for laminate or \$594 list for veneer; see page 19 for details
- top grommet available, specify location; add \$128 list each; see page 42 for details
- 12" wide top grommet available, specify location; add \$168 list each; see page 42 for details
- worksurface power available, specify "to accommodate EC26" on your purchase order; EC26 unit must be ordered separately, see page 42
- wire manager tray available see accessory section on pages 48-49 for details

To Order, Specify:

① Laminate Model #	② Laminate Type	③ Laminate Selection	④ Metal Color	⑤ Other Product Options
Laminate (FLT)	HPL	See Laminate Selection	See Metal Finish Color Options	See list of options for each specific unit; Specify and add accordingly.

① Veneer Model #	② Wood Species	③ Wood Finish	④ Metal Color	⑤ Other Product Options
Veneer (FLV)	Flat Cut CH1 Cherry MA1 Maple WA1 Walnut BO1 Black Oak	See Flat Cut Wood Finish Options	See Metal Finish Color Options	See list of options for each specific unit; Specify and add accordingly.
		<table border="1"> <thead> <tr> <th>③a Wood Finish</th> <th>③b Chassis Grain Direction</th> </tr> </thead> <tbody> <tr> <td>See Double Cut Wood Finish Options</td> <td>For Double Cut Only: Vertical Horizontal</td> </tr> </tbody> </table>		
③a Wood Finish	③b Chassis Grain Direction			
See Double Cut Wood Finish Options	For Double Cut Only: Vertical Horizontal			

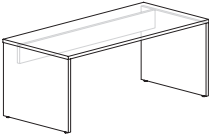
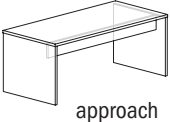
Description	D	W	H	CTN WT	CU FT	① Model	HPL Laminate	Flat Cut Veneer	Double Cut Veneer
  *desks are handed when grommets are applied; see page 42	33½	84	29	181	56	FLT3484PDEPPR	\$1,447		
	33½	84	29	181	56	FLV3484PDEPPR		\$2,190	\$2,409
	33½	84	29	181	56	FLT3484PDEPPL	\$1,447		
	33½	84	29	181	56	FLV3484PDEPPL		\$2,190	\$2,409
	33½	78	29	172	52	FLT3478PDEPPR	\$1,412		
	33½	78	29	172	52	FLV3478PDEPPR		\$2,136	\$2,351
	33½	78	29	172	52	FLT3478PDEPPL	\$1,412		
	33½	78	29	172	52	FLV3478PDEPPL		\$2,136	\$2,351
	33½	72	29	163	48	FLT3472PDEPPR	\$1,378		
	33½	72	29	163	48	FLV3472PDEPPR		\$2,085	\$2,294
	33½	72	29	163	48	FLT3472PDEPPL	\$1,378		
	33½	72	29	163	48	FLV3472PDEPPL		\$2,085	\$2,294
	33½	66	29	154	44	FLT3466PDEPPR	\$1,359		
	33½	66	29	154	44	FLV3466PDEPPR		\$2,055	\$2,260
	33½	66	29	154	44	FLT3466PDEPPL	\$1,359		
	33½	66	29	154	44	FLV3466PDEPPL		\$2,055	\$2,260

Features:

- eased edge profile on approach and user sides
- 6¾" h modesty with horizontal wire channel

Options:

- must specify support panels grain direction on double cut veneer, see pages 11-13 for details
- on laminate units, contrasting worksurface tops and chassis available, no upcharge; specify color see page 14 for details
- top grommet available, specify location; add \$128 list each; see page 42 for details
- 12" wide top grommet available, specify location; add \$168 list each; see page 42 for details
- worksurface power available, specify "to accommodate EC26" on your purchase order; EC26 unit must be ordered separately, see page 42
- wire manager tray available see accessory section on pages 48-49 for details

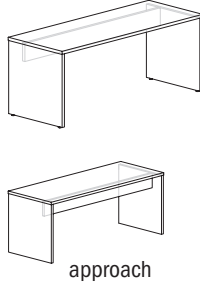
Description	D	W	H	CTN WT	CU FT	① Model	HPL Laminate	Flat Cut Veneer	Double Cut Veneer
 <p>approach</p>	27 1/2	84	29	154	46	FLT2884PDEPPR	\$1,368		
	27 1/2	84	29	154	46	FLV2884PDEPPR		\$2,071	\$2,278
	27 1/2	84	29	154	46	FLT2884PDEPPL	\$1,368		
	27 1/2	84	29	154	46	FLV2884PDEPPL		\$2,071	\$2,278
	27 1/2	78	29	148	43	FLT2878PDEPPR	\$1,336		
	27 1/2	78	29	148	43	FLV2878PDEPPR		\$2,020	\$2,222
	27 1/2	78	29	148	43	FLT2878PDEPPL	\$1,336		
	27 1/2	78	29	148	43	FLV2878PDEPPL		\$2,020	\$2,222
	27 1/2	72	29	142	40	FLT2872PDEPPR	\$1,301		
	27 1/2	72	29	142	40	FLV2872PDEPPR		\$1,972	\$2,169
	27 1/2	72	29	142	40	FLT2872PDEPPL	\$1,301		
	27 1/2	72	29	142	40	FLV2872PDEPPL		\$1,972	\$2,169
	27 1/2	66	29	136	37	FLT2866PDEPPR	\$1,283		
	27 1/2	66	29	136	37	FLV2866PDEPPR		\$1,941	\$2,135
	27 1/2	66	29	136	37	FLT2866PDEPPL	\$1,283		
27 1/2	66	29	136	37	FLV2866PDEPPL		\$1,941	\$2,135	

*desks are handed when grommets are applied; see page 42

Features:

- eased edge profile on approach and user sides
- 6 3/4" h modesty with horizontal wire channel



Options:

- must specify support panels grain direction on double cut veneer, see pages 11-13 for details
- on laminate units, contrasting worksurface tops and chassis available, no upcharge; specify color see page 14 for details
- top grommet available, specify location; add \$128 list each; see page 42 for details
- 12" wide top grommet available, specify location; add \$168 list each; see page 42 for details
- worksurface power available, specify "to accommodate EC26" on your purchase order; EC26 unit must be ordered separately, see page 42
- wire manager tray available see accessory section on pages 48-49 for details

To Order, Specify:

① Laminate Model #	② Laminate Type	③ Laminate Selection	④ Metal Color	⑤ Other Product Options
Laminate (FLT)	HPL	See Laminate Selection	See Metal Finish Color Options	See list of options for each specific unit; Specify and add accordingly.

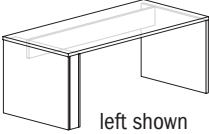
① Veneer Model #	② Wood Species	③ Wood Finish	④ Metal Color	⑤ Other Product Options
Veneer (FLV)	Flat Cut CH1 Cherry MA1 Maple WA1 Walnut BO1 Black Oak	See Flat Cut Wood Finish Options	See Metal Finish Color Options	See list of options for each specific unit; Specify and add accordingly.
	Double Cut DC1 Double Cut	3a Wood Finish See Double Cut Wood Finish Options		

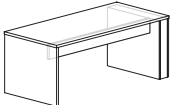



Description	D	W	H	CTN WT	CU FT	① Model	HPL Laminate	Flat Cut Veneer	Double Cut Veneer
Rectangular Peninsula Table Desk with 6" w Full Support Panel and Panel End  left shown  left right  approach - left	33½	84	29	207	56	FLT3484PDTEPR	\$1,943		
	33½	84	29	207	56	FLV3484PDTEPR		\$2,943	\$3,239
	33½	84	29	207	56	FLT3484PDTEPL	\$1,943		
	33½	84	29	207	56	FLV3484PDTEPL		\$2,943	\$3,239
	33½	78	29	198	52	FLT3478PDTEPR	\$1,896		
	33½	78	29	198	52	FLV3478PDTEPR		\$2,872	\$3,159
	33½	78	29	198	52	FLT3478PDTEPL	\$1,896		
	33½	78	29	198	52	FLV3478PDTEPL		\$2,872	\$3,159
	33½	72	29	189	48	FLT3472PDTEPR	\$1,851		
	33½	72	29	189	48	FLV3472PDTEPR		\$2,802	\$3,083
	33½	72	29	189	48	FLT3472PDTEPL	\$1,851		
	33½	72	29	189	48	FLV3472PDTEPL		\$2,802	\$3,083
	33½	66	29	180	44	FLT3466PDTEPR	\$1,823		
	33½	66	29	180	44	FLV3466PDTEPR		\$2,760	\$3,038
	33½	66	29	180	44	FLT3466PDTEPL	\$1,823		
	33½	66	29	180	44	FLV3466PDTEPL		\$2,760	\$3,038

Features:

- eased edge profile on approach and user sides
- 6¾" h modesty with horizontal wire channel

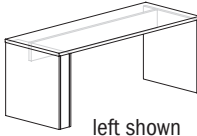
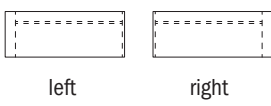
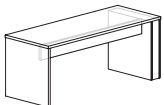
Options:

- must specify support panels grain direction on double cut veneer, see pages 11-13 for details
- on laminate units, contrasting worksurface tops and chassis available, no upcharge; specify color see page 14 for details
- top grommet available, specify location; add \$128 list each; see page 42 for details
- 12" wide top grommet available, specify location; add \$168 list each; see page 42 for details
- worksurface power available, specify "to accommodate EC26" on your purchase order; EC26 unit must be ordered separately, see page 42
- wire manager tray available see accessory section on pages 48-49 for details

Description	D	W	H	CTN WT	CU FT	① Model	HPL Laminate	Flat Cut Veneer	Double Cut Veneer
Rectangular Peninsula Table	27 1/2	84	29	177	46	FLT2884PDTEPR	\$1,850		
Desk with 6" w Full Support Panel and Panel End	27 1/2	84	29	177	46	FLV2884PDTEPR		\$2,800	\$3,081
	27 1/2	84	29	177	46	FLT2884PDTEPL	\$1,850		
	27 1/2	84	29	177	46	FLV2884PDTEPL		\$2,800	\$3,081
	27 1/2	78	29	171	43	FLT2878PDTEPR	\$1,806		
	27 1/2	78	29	171	43	FLV2878PDTEPR		\$2,731	\$3,006
	27 1/2	78	29	171	43	FLT2878PDTEPL	\$1,806		
	27 1/2	78	29	171	43	FLV2878PDTEPL		\$2,731	\$3,006
	27 1/2	72	29	165	40	FLT2872PDTEPR	\$1,760		
	27 1/2	72	29	165	40	FLV2872PDTEPR		\$2,667	\$2,934
	27 1/2	72	29	165	40	FLT2872PDTEPL	\$1,760		
	27 1/2	72	29	165	40	FLV2872PDTEPL		\$2,667	\$2,934
	27 1/2	66	29	159	37	FLT2866PDTEPR	\$1,735		
	27 1/2	66	29	159	37	FLV2866PDTEPR		\$2,626	\$2,890
	27 1/2	66	29	159	37	FLT2866PDTEPL	\$1,735		
	27 1/2	66	29	159	37	FLV2866PDTEPL		\$2,626	\$2,890

Features:

- eased edge profile on approach and user sides
- 6 3/4" h modesty with horizontal wire channel



Options:

- must specify support panels grain direction on double cut veneer, see pages 11-13 for details
- on laminate units, contrasting worksurface tops and chassis available, no upcharge; specify color see page 14 for details
- top grommet available, specify location; add \$128 list each; see page 42 for details
- 12" wide top grommet available, specify location; add \$168 list each; see page 42 for details
- worksurface power available, specify "to accommodate EC26" on your purchase order; EC26 unit must be ordered separately, see page 42
- wire manager tray available see accessory section on pages 48-49 for details

To Order, Specify:

① Laminate Model #	② Laminate Type	③ Laminate Selection	④ Metal Color	⑤ Other Product Options
Laminate (FLT)	HPL	See Laminate Selection	See Metal Finish Color Options	See list of options for each specific unit; Specify and add accordingly.

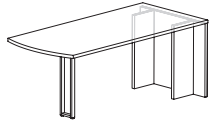
① Veneer Model #	② Wood Species	③ Wood Finish	④ Metal Color	⑤ Other Product Options
Veneer (FLV)	Flat Cut CH1 Cherry MA1 Maple WA1 Walnut BO1 Black Oak	See Flat Cut Wood Finish Options	See Metal Finish Color Options	See list of options for each specific unit; Specify and add accordingly.
		<table border="1"> <thead> <tr> <th>ⓐ Wood Finish</th> <th>ⓑ Chassis Grain Direction</th> </tr> </thead> <tbody> <tr> <td>See Double Cut Wood Finish Options</td> <td>For Double Cut Only: Vertical Horizontal</td> </tr> </tbody> </table>		
ⓐ Wood Finish	ⓑ Chassis Grain Direction			
See Double Cut Wood Finish Options	For Double Cut Only: Vertical Horizontal			



Description	D	W	H	CTN WT	CU FT	① Model	HPL Laminate	Flat Cut Veneer	Double Cut Veneer
Arc Peninsula Table Desk with Frame Base and Panel End  	33½	84	29	169	56	FLT3484PARCPEP	\$2,371		
	33½	84	29	169	56	FLV3484PARCPEP		\$3,133	\$3,447
	33½	78	29	161	52	FLT3478PARCPEP	\$2,321		
	33½	78	29	161	52	FLV3478PARCPEP		\$3,065	\$3,372
	33½	72	29	153	48	FLT3472PARCPEP	\$2,273		
	33½	72	29	153	48	FLV3472PARCPEP		\$3,002	\$3,302
	33½	66	29	145	44	FLT3466PARCPEP	\$2,253		
	33½	66	29	145	44	FLV3466PARCPEP		\$2,974	\$3,271

Features:

- must be used with run-off credenza or return units, see pages 120-125
- eased edge profile on approach and user sides

Options:

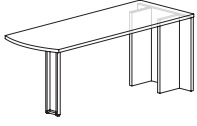
- must specify support panels grain direction on double cut veneer, see pages 11-13 for details
- on laminate units, contrasting worksurface tops and chassis available, no upcharge; specify color see page 14 for details
- 13 ½”h modesty panel available, specify; add \$427 list for laminate or \$594 list for veneer; see page 19 for details
- top grommet available, specify location; add \$128 list each; see page 42 for details
- 12” wide top grommet available, specify location; add \$168 list each; see page 42 for details
- worksurface power available, specify “to accommodate EC26” on your purchase order; EC26 unit must be ordered separately, see page 42
- wire manager tray available see accessory section on pages 48-49 for details

Description	D	W	H	CTN WT	CU FT	① Model	HPL Laminate	Flat Cut Veneer	Double Cut Veneer
 	27 1/2	84	29	145	46	FLT2884PARCPEP	\$2,295		
	27 1/2	84	29	145	46	FLV2884PARCPEP		\$3,028	\$3,333
	27 1/2	78	29	139	43	FLT2878PARCPEP	\$2,246		
	27 1/2	78	29	139	43	FLV2878PARCPEP		\$2,966	\$3,264
	27 1/2	72	29	133	40	FLT2872PARCPEP	\$2,199		
	27 1/2	72	29	133	40	FLV2872PARCPEP		\$2,901	\$3,193
	27 1/2	66	29	127	37	FLT2866PARCPEP	\$2,181		
	27 1/2	66	29	127	37	FLV2866PARCPEP		\$2,876	\$3,164

Features:

- must be used with run-off credenza or return units, see pages 120-125
- eased edge profile on approach and user sides

Options:

- must specify support panels grain direction on double cut veneer, see pages 11-13 for details
- on laminate units, contrasting worksurface tops and chassis available, no upcharge; specify color see page 14 for details
- 13 1/2" h modesty panel available, specify; add \$427 list for laminate or \$594 list for veneer; see page 19 for details
- top grommet available, specify location; add \$128 list each; see page 42 for details
- 12" wide top grommet available, specify location; add \$168 list each; see page 42 for details
- worksurface power available, specify "to accommodate EC26" on your purchase order; EC26 unit must be ordered separately, see page 42
- wire manager tray available see accessory section on pages 48-49 for details

To Order, Specify:

① Laminate Model #	② Laminate Type	③ Laminate Selection	④ Metal Color	⑤ Other Product Options
Laminate (FLT)	HPL	See Laminate Selection	See Metal Finish Color Options	See list of options for each specific unit; Specify and add accordingly.

① Veneer Model #	② Wood Species	③ Wood Finish	④ Metal Color	⑤ Other Product Options
Veneer (FLV)	Flat Cut CH1 Cherry MA1 Maple WA1 Walnut BO1 Black Oak	See Flat Cut Wood Finish Options	See Metal Finish Color Options	See list of options for each specific unit; Specify and add accordingly.
		<table border="1"> <thead> <tr> <th>③a Wood Finish</th> <th>③b Chassis Grain Direction</th> </tr> </thead> <tbody> <tr> <td>See Double Cut Wood Finish Options</td> <td>For Double Cut Only: Vertical Horizontal</td> </tr> </tbody> </table>		
③a Wood Finish	③b Chassis Grain Direction			
See Double Cut Wood Finish Options	For Double Cut Only: Vertical Horizontal			

Description	D	W	H	CTN WT	CU FT	① Model	HPL Laminate	Flat Cut Veneer	Double Cut Veneer
Boomerang Peninsula Table Desk with End Leg Assembly and Panel End	33½	84	29	169	56	FLT3484PBMNEPR	\$3,010		
	33½	84	29	169	56	FLV3484PBMNEPR		\$3,998	\$4,398
	33½	84	29	169	56	FLT3484PBMNEPL	\$3,010		
	33½	84	29	169	56	FLV3484PBMNEPL		\$3,998	\$4,398
	33½	78	29	161	52	FLT3478PBMNEPR	\$2,944		
	33½	78	29	161	52	FLV3478PBMNEPR		\$3,910	\$4,299
	33½	78	29	161	52	FLT3478PBMNEPL	\$2,944		
	33½	78	29	161	52	FLV3478PBMNEPL		\$3,910	\$4,299
	33½	72	29	153	48	FLT3472PBMNEPR	\$2,880		
	33½	72	29	153	48	FLV3472PBMNEPR		\$3,824	\$4,206
	33½	72	29	153	48	FLT3472PBMNEPL	\$2,880		
	33½	72	29	153	48	FLV3472PBMNEPL		\$3,824	\$4,206
	33½	66	29	145	44	FLT3466PBMNEPR	\$2,842		
	33½	66	29	145	44	FLV3466PBMNEPR		\$3,771	\$4,150
	33½	66	29	145	44	FLT3466PBMNEPL	\$2,842		
	33½	66	29	145	44	FLV3466PBMNEPL		\$3,771	\$4,150

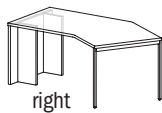
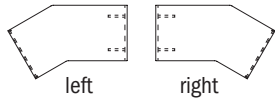
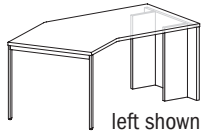

Features:

- must be used with run-off credenza or return units, see pages 120-125
- eased edge profile on approach and user sides

Options:

- must specify support panels grain direction on double cut veneer, see pages 11-13 for details
- on laminate units, contrasting worksurface tops and chassis available, no upcharge; specify color see page 14 for details
- 13 ½" h modesty panel available for 84" w and 78" w desk, specify; add \$427 list for laminate or \$594 list for veneer; see page 19 for details
- top grommet available, specify location; add \$128 list each; see page 42 for details
- 12" wide top grommet available, specify location; add \$168 list each; see page 42 for details
- worksurface power available, specify "to accommodate EC26" on your purchase order; EC26 unit must be ordered separately, see page 42
- wire manager tray available see accessory section on pages 48-49 for details

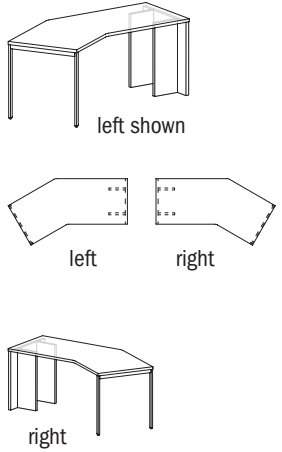
Description	D	W	H	CTN WT	CU FT	① Model	HPL Laminate	Flat Cut Veneer	Double Cut Veneer
Boomerang Peninsula Table	27 1/2	84	29	145	46	FLT2884PBMNEPR	\$2,952		
Desk with End Leg Assembly and Panel End	27 1/2	84	29	145	46	FLV2884PBMNEPR		\$3,919	\$4,313
	27 1/2	84	29	145	46	FLT2884PBMNEPL	\$2,952		
	27 1/2	84	29	145	46	FLV2884PBMNEPL		\$3,919	\$4,313
	27 1/2	78	29	139	43	FLT2878PBMNEPR	\$2,890		
	27 1/2	78	29	139	43	FLV2878PBMNEPR		\$3,833	\$4,217
	27 1/2	78	29	133	43	FLT2878PBMNEPL	\$2,890		
	27 1/2	78	29	133	43	FLV2878PBMNEPL		\$3,833	\$4,217
	27 1/2	72	29	133	40	FLT2872PBMNEPR	\$2,826		
	27 1/2	72	29	133	40	FLV2872PBMNEPR		\$3,749	\$4,123
	27 1/2	72	29	133	40	FLT2872PBMNEPL	\$2,826		
	27 1/2	72	29	133	40	FLV2872PBMNEPL		\$3,749	\$4,123
	27 1/2	66	29	127	37	FLT2866PBMNEPR	\$2,775		
	27 1/2	66	29	127	37	FLV2866PBMNEPR		\$3,698	\$4,068
	27 1/2	66	29	127	37	FLT2866PBMNEPL	\$2,775		
	27 1/2	66	29	127	37	FLV2866PBMNEPL		\$3,698	\$4,068

Features:

- must be used with run-off credenza or return units, see pages 120-125
- eased edge profile on approach and user sides

Options:

- must specify support panels grain direction on double cut veneer, see pages 11-13 for details
- on laminate units, contrasting worksurface tops and chassis available, no upcharge; specify color see page 14 for details
- 13 1/2" h modesty panel available for 84" w and 78" w desk, specify; add \$427 list for laminate or \$594 list for veneer; see page 19 for details
- top grommet available, specify location; add \$128 list each; see page 42 for details
- 12" wide top grommet available, specify location; add \$168 list each; see page 42 for details
- worksurface power available, specify "to accommodate EC26" on your purchase order; EC26 unit must be ordered separately, see page 42
- wire manager tray available see accessory section on pages 48-49 for details

To Order, Specify:

① Laminate Model #	② Laminate Type	③ Laminate Selection	④ Metal Color	⑤ Other Product Options
Laminate (FLT)	HPL	See Laminate Selection	See Metal Finish Color Options	See list of options for each specific unit; Specify and add accordingly.

① Veneer Model #	② Wood Species	③ Wood Finish	④ Metal Color	⑤ Other Product Options
Veneer (FLV)	Flat Cut CH1 Cherry MA1 Maple WA1 Walnut BO1 Black Oak	See Flat Cut Wood Finish Options	See Metal Finish Color Options	See list of options for each specific unit; Specify and add accordingly.
	Double Cut DC1 Double Cut	ⓐ Wood Finish See Double Cut Wood Finish Options		

Description	D	W	H	CTN WT	CU FT	① Model	HPL Laminate	Flat Cut Veneer	Double Cut Veneer
Rectangular Peninsula Table Desk with End Leg Assembly and Secondary Support End	33½	84	29	149	31	FLT3484PDN	\$2,066		
	33½	84	29	149	31	FLV3484PDN		\$2,720	\$2,993
	33½	78	29	140	28	FLT3478PDN	\$2,030		
	33½	78	29	140	28	FLV3478PDN		\$2,673	\$2,939
	33½	72	29	131	26	FLT3472PDN	\$1,993		
	33½	72	29	131	26	FLV3472PDN		\$2,622	\$2,884
	33½	66	29	122	24	FLT3466PDN	\$1,958		
	33½	66	29	122	24	FLV3466PDN		\$2,574	\$2,833

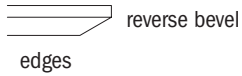
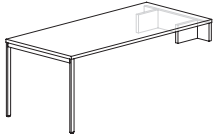

Features:

- peninsula desk mounting included in the list price of the unit, but must be specified when ordering secondary credenza; see pages 16-18 for details
- eased edge profile on approach and user sides

Options:

- must specify support panels grain direction on double cut veneer, see pages 11-13 for details
- on laminate units, contrasting worksurface tops and chassis available, no upcharge; specify color see page 14 for details
- reverse bevel edge available on three sides, specify; add \$429 list for laminate or \$168 list for veneer; see page 8 for details
- 13 ½" h modesty panel available, specify; add \$427 list for laminate or \$594 list for veneer; see page 19 for details
- top grommet available, specify location; add \$128 list each; see page 47 for details
- 12" wide top grommet available, specify location; add \$163 list each; see page 42 for details
- worksurface power available, specify "to accommodate EC26" on your purchase order; EC26 unit must be ordered separately, see page 42
- wire manager tray available see accessory section on pages 48-49 for details

Description	D	W	H	CTN WT	CU FT	① Model	HPL Laminate	Flat Cut Veneer	Double Cut Veneer
Rectangular Peninsula Table	27 1/2	84	29	128	25	FLT2884PDN	\$1,991		
Desk with End Leg Assembly and Secondary Support End	27 1/2	84	29	128	25	FLV2884PDN		\$2,617	\$2,880
	27 1/2	78	29	122	24	FLT2878PDN	\$1,955		
	27 1/2	78	29	122	24	FLV2878PDN		\$2,571	\$2,828
	27 1/2	72	29	116	22	FLT2872PDN	\$1,920		
	27 1/2	72	29	116	22	FLV2872PDN		\$2,524	\$2,778
	27 1/2	66	29	110	20	FLT2866PDN	\$1,895		
	27 1/2	66	29	110	20	FLV2866PDN		\$2,491	\$2,740

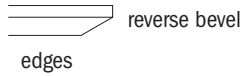
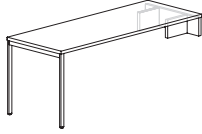

Features:

- peninsula desk mounting included in the list price of the unit, but must be specified when ordering secondary credenza; see pages 16-18 for details
- eased edge profile on approach and user sides

Options:

- must specify support panels grain direction on double cut veneer, see pages 11-13 for details
- on laminate units, contrasting worksurface tops and chassis available, no upcharge; specify color see page 14 for details
- reverse bevel edge available on three sides, specify; add \$429 list for laminate or \$168 list for veneer; see page 8 for details
- 13 1/2" h modesty panel available, specify; add \$427 list for laminate or \$594 list for veneer; see page 19 for details
- top grommet available, specify location; add \$128 list each; see page 47 for details
- 12" wide top grommet available, specify location; add \$163 list each; see page 42 for details
- worksurface power available, specify "to accommodate EC26" on your purchase order; EC26 unit must be ordered separately, see page 42
- wire manager tray available see accessory section on pages 48-49 for details

To Order, Specify:

① Laminate Model #	② Laminate Type	③ Laminate Selection	④ Metal Color	⑤ Other Product Options
Laminate (FLT)	HPL	See Laminate Selection	See Metal Finish Color Options	See list of options for each specific unit; Specify and add accordingly.

① Veneer Model #	② Wood Species	③ Wood Finish	④ Metal Color	⑤ Other Product Options
Veneer (FLV)	Flat Cut CH1 Cherry MA1 Maple WA1 Walnut BO1 Black Oak	See Flat Cut Wood Finish Options	See Metal Finish Color Options	See list of options for each specific unit; Specify and add accordingly.
		<table border="1"> <thead> <tr> <th>③a Wood Finish</th> <th>③b Chassis Grain Direction</th> </tr> </thead> <tbody> <tr> <td>See Double Cut Wood Finish Options</td> <td>For Double Cut Only: Vertical Horizontal</td> </tr> </tbody> </table>		
③a Wood Finish	③b Chassis Grain Direction			
See Double Cut Wood Finish Options	For Double Cut Only: Vertical Horizontal			

Description	D	W	H	CTN WT	CU FT	① Model	HPL Laminate	Flat Cut Veneer	Double Cut Veneer
Rectangular Peninsula Table Desk with Frame Base and Secondary Support End	33½	84	29	149	31	FLT3484PDP	\$2,066		
	33½	84	29	149	31	FLV3484PDP		\$2,720	\$2,993
	33½	78	29	140	28	FLT3478PDP	\$2,030		
	33½	78	29	140	28	FLV3478PDP		\$2,673	\$2,939
	33½	72	29	131	26	FLT3472PDP	\$1,993		
	33½	72	29	131	26	FLV3472PDP		\$2,622	\$2,884
	33½	66	29	122	24	FLT3466PDP	\$1,958		
	33½	66	29	122	24	FLV3466PDP		\$2,574	\$2,833

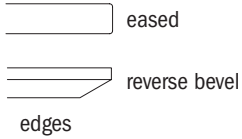
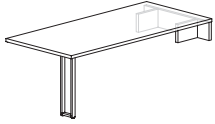

Features:

- peninsula desk mounting included in the list price of the unit, but must be specified when ordering secondary credenza; see pages 16-18 for details
- eased edge profile on approach and user sides

Options:

- must specify support panels grain direction on double cut veneer, see pages 11-13 for details
- on laminate units, contrasting worksurface tops and chassis available, no upcharge; specify color see page 14 for details
- reverse bevel edge available on three sides, specify; add \$429 list for laminate or \$168 list for veneer; see page 8 for details
- 13 ½" h modesty panel available, specify; add \$427 list for laminate or \$594 list for veneer; see page 19 for details
- top grommet available, specify location; add \$128 list each; see page 47 for details
- 12" wide top grommet available, specify location; add \$163 list each; see page 42 for details
- worksurface power available, specify "to accommodate EC26" on your purchase order; EC26 unit must be ordered separately, see page 42
- wire manager tray available see accessory section on pages 48-49 for details

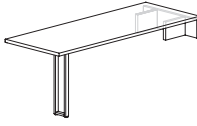
Description	D	W	H	CTN WT	CU FT	① Model	HPL Laminate	Flat Cut Veneer	Double Cut Veneer
Rectangular Peninsula Table Desk with Frame Base and Secondary Support End 	27 1/2	84	29	128	25	FLT2884PDP	\$1,991		
	27 1/2	84	29	128	25	FLV2884PDP		\$2,617	\$2,880
	27 1/2	78	29	122	24	FLT2878PDP	\$1,955		
	27 1/2	78	29	122	24	FLV2878PDP		\$2,571	\$2,828
	27 1/2	72	29	116	22	FLT2872PDP	\$1,920		
	27 1/2	72	29	116	22	FLV2872PDP		\$2,524	\$2,778
	27 1/2	66	29	110	20	FLT2866PDP	\$1,895		
	27 1/2	66	29	110	20	FLV2866PDP		\$2,491	\$2,740

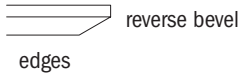

Features:

- peninsula desk mounting included in the list price of the unit, but must be specified when ordering secondary credenza; see pages 16-18 for details
- eased edge profile on approach and user sides

Options:

- must specify support panels grain direction on double cut veneer, see pages 11-13 for details
- on laminate units, contrasting worksurface tops and chassis available, no upcharge; specify color see page 14 for details
- reverse bevel edge available on three sides, specify; add \$429 list for laminate or \$168 list for veneer; see page 8 for details
- 13 1/2" h modesty panel available, specify; add \$427 list for laminate or \$594 list for veneer; see page 19 for details
- top grommet available, specify location; add \$128 list each; see page 47 for details
- 12" wide top grommet available, specify location; add \$163 list each; see page 42 for details
- worksurface power available, specify "to accommodate EC26" on your purchase order; EC26 unit must be ordered separately, see page 42
- wire manager tray available see accessory section on pages 48-49 for details

To Order, Specify:

① Laminate Model #	② Laminate Type	③ Laminate Selection	④ Metal Color	⑤ Other Product Options
Laminate (FLT)	HPL	See Laminate Selection	See Metal Finish Color Options	See list of options for each specific unit; Specify and add accordingly.

① Veneer Model #	② Wood Species	③ Wood Finish	④ Metal Color	⑤ Other Product Options
Veneer (FLV)	Flat Cut CH1 Cherry MA1 Maple WA1 Walnut BO1 Black Oak	See Flat Cut Wood Finish Options	See Metal Finish Color Options	See list of options for each specific unit; Specify and add accordingly.
		<table border="1"> <thead> <tr> <th>③a Wood Finish</th> <th>③b Chassis Grain Direction</th> </tr> </thead> <tbody> <tr> <td>See Double Cut Wood Finish Options</td> <td>For Double Cut Only: Vertical Horizontal</td> </tr> </tbody> </table>		
③a Wood Finish	③b Chassis Grain Direction			
See Double Cut Wood Finish Options	For Double Cut Only: Vertical Horizontal			

Description	D	W	H	CTN WT	CU FT	① Model	HPL Laminate	Flat Cut Veneer	Double Cut Veneer
Rectangular Peninsula Table Desk with Full Support Panel and Secondary Support End	33½	84	29	163	56	FLT3484PDEPR	\$1,445		
	33½	84	29	163	56	FLV3484PDEPR		\$2,187	\$2,405
	33½	84	29	163	56	FLT3484PDEPL	\$1,445		
	33½	84	29	163	56	FLV3484PDEPL		\$2,187	\$2,405
	33½	78	29	154	52	FLT3478PDEPR	\$1,410		
	33½	78	29	154	52	FLV3478PDEPR		\$2,132	\$2,347
	33½	78	29	154	52	FLT3478PDEPL	\$1,410		
	33½	78	29	154	52	FLV3478PDEPL		\$2,132	\$2,347
	33½	72	29	146	48	FLT3472PDEPR	\$1,374		
	33½	72	29	146	48	FLV3472PDEPR		\$2,079	\$2,289
	33½	72	29	146	48	FLT3472PDEPL	\$1,374		
	33½	72	29	146	48	FLV3472PDEPL		\$2,079	\$2,289
approach - left	33½	66	29	158	44	FLT3466PDEPR	\$1,347		
	33½	66	29	158	44	FLV3466PDEPR		\$2,040	\$2,243
	33½	66	29	158	44	FLT3466PDEPL	\$1,347		
33½	66	29	158	44	FLV3466PDEPL		\$2,040	\$2,243	

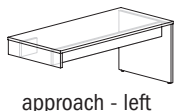
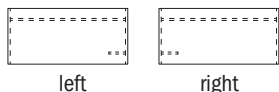
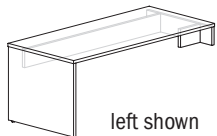

Features:

- peninsula desk mounting included in the list price of the unit, but must be specified when ordering secondary credenza; see pages 16-18 for details
- eased edge profile on approach and user sides
- 6¾" h modesty with horizontal wire channel

Options:

- must specify support panels grain direction on double cut veneer, see pages 11-13 for details
- on laminate units, contrasting worksurface tops and drawer fronts available, no upcharge; specify laminate color, see page 14 for details
- top grommet available, specify location; add \$128 list each; see page 42 for details
- 12" wide top grommet available, specify location; add \$168 list each; see page 42 for details
- worksurface power available, specify "to accommodate EC26" on your purchase order; EC26 unit must be ordered separately, see page 42
- wire manager tray available see accessory section on pages 48-49 for details

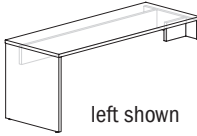
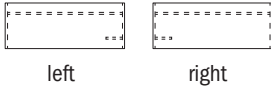
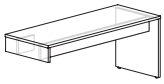
Description	D	W	H	CTN WT	CU FT	① Model	HPL Laminate	Flat Cut Veneer	Double Cut Veneer
Rectangular Peninsula Table	27 1/2	84	29	144	46	FLT2884PDEPR	\$1,195		
Desk with Full Support Panel and Secondary Support End	27 1/2	84	29	144	46	FLV2884PDEPR		\$1,809	\$1,991
	27 1/2	84	29	144	46	FLT2884PDEPL	\$1,195		
 left shown  left right  approach - left	27 1/2	84	29	144	46	FLV2884PDEPL		\$1,809	\$1,991
	27 1/2	78	29	137	43	FLT2878PDEPR	\$1,166		
	27 1/2	78	29	137	43	FLV2878PDEPR		\$1,765	\$1,941
	27 1/2	78	29	137	43	FLT2878PDEPL	\$1,166		
	27 1/2	78	29	137	43	FLV2878PDEPL		\$1,765	\$1,941
	27 1/2	72	29	130	40	FLT2872PDEPR	\$1,138		
	27 1/2	72	29	130	40	FLV2872PDEPR		\$1,722	\$1,895
	27 1/2	72	29	130	40	FLT2872PDEPL	\$1,138		
	27 1/2	72	29	130	40	FLV2872PDEPL		\$1,722	\$1,895
	27 1/2	66	29	123	37	FLT2866PDEPR	\$1,116		
	27 1/2	66	29	123	37	FLV2866PDEPR		\$1,688	\$1,856
	27 1/2	66	29	123	37	FLT2866PDEPL	\$1,116		
	27 1/2	66	29	123	37	FLV2866PDEPL		\$1,688	\$1,856

Features:

- peninsula desk mounting included in the list price of the unit, but must be specified when ordering secondary credenza; see pages 16-18 for details
- eased edge profile on approach and user sides
- 6 3/4" h modesty with horizontal wire channel

Options:

- must specify support panels grain direction on double cut veneer, see pages 11-13 for details
- on laminate units, contrasting worksurface tops and drawer fronts available, no upcharge; specify laminate color, see page 14 for details
- top grommet available, specify location; add \$128 list each; see page 42 for details
- 12" wide top grommet available, specify location; add \$168 list each; see page 42 for details
- worksurface power available, specify "to accommodate EC26" on your purchase order; EC26 unit must be ordered separately, see page 42
- wire manager tray available see accessory section on pages 48-49 for details

To Order, Specify:

① Laminate Model #	② Laminate Type	③ Laminate Selection	④ Metal Color	⑤ Other Product Options
Laminate (FLT)	HPL	See Laminate Selection	See Metal Finish Color Options	See list of options for each specific unit; Specify and add accordingly.

① Veneer Model #	② Wood Species	③ Wood Finish	④ Metal Color	⑤ Other Product Options
Veneer (FLV)	Flat Cut CH1 Cherry MA1 Maple WA1 Walnut BO1 Black Oak	See Flat Cut Wood Finish Options	See Metal Finish Color Options	See list of options for each specific unit; Specify and add accordingly.
		<table border="1"> <thead> <tr> <th>ⓐ Wood Finish</th> <th>ⓑ Chassis Grain Direction</th> </tr> </thead> <tbody> <tr> <td>See Double Cut Wood Finish Options</td> <td>For Double Cut Only: Vertical Horizontal</td> </tr> </tbody> </table>		
ⓐ Wood Finish	ⓑ Chassis Grain Direction			
See Double Cut Wood Finish Options	For Double Cut Only: Vertical Horizontal			

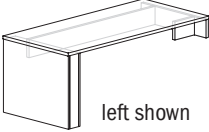
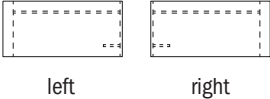
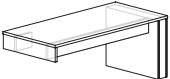
Description	D	W	H	CTN WT	CU FT	① Model	HPL Laminate	Flat Cut Veneer	Double Cut Veneer
  	33½	84	29	189	56	FLT3484DTEPR	\$1,941		
	33½	84	29	189	56	FLV3484DTEPR		\$2,939	\$3,233
	33½	84	29	189	56	FLT3484DTEPL	\$1,941		
	33½	84	29	189	56	FLV3484DTEPL		\$2,939	\$3,233
	33½	78	29	181	52	FLT3478DTEPR	\$1,893		
	33½	78	29	181	52	FLV3478DTEPR		\$2,868	\$3,154
	33½	78	29	181	52	FLT3478DTEPL	\$1,893		
	33½	78	29	181	52	FLV3478DTEPL		\$2,868	\$3,154
	33½	72	29	173	48	FLT3472DTEPR	\$1,849		
	33½	72	29	173	48	FLV3472DTEPR		\$2,798	\$3,078
	33½	72	29	173	48	FLT3472DTEPL	\$1,849		
	33½	72	29	173	48	FLV3472DTEPL		\$2,798	\$3,078
	33½	66	29	165	44	FLT3466DTEPR	\$1,810		
	33½	66	29	165	44	FLV3466DTEPR		\$2,743	\$3,016
	33½	66	29	165	44	FLT3466DTEPL	\$1,810		
33½	66	29	165	44	FLV3466DTEPL		\$2,743	\$3,016	

Features:

- peninsula desk mounting included in the list price of the unit, but must be specified when ordering secondary credenza; see pages 16-18 for details
- eased edge profile on approach and user sides
- 6¾" h modesty with horizontal wire channel

Options:

- must specify support panels grain direction on double cut veneer, see pages 11-13 for details
- on laminate units, contrasting worksurface tops and drawer fronts available, no upcharge; specify laminate color, see page 14 for details
- top grommet available, specify location; add \$128 list each; see page 42 for details
- 12" wide top grommet available, specify location; add \$168 list each; see page 42 for details
- worksurface power available, specify "to accommodate EC26" on your purchase order; EC26 unit must be ordered separately, see page 42
- wire manager tray available see accessory section on pages 48-49 for details

Description	D	W	H	CTN WT	CU FT	① Model	HPL Laminate	Flat Cut Veneer	Double Cut Veneer
Rectangular Peninsula Table Desk with 6" Full Support Panel and Secondary Support End	27 1/2	84	29	162	46	FLT2884DTEPR	\$1,675		
	27 1/2	84	29	162	46	FLV2884DTEPR		\$2,539	\$2,793
	27 1/2	84	29	162	46	FLT2884DTEPL	\$1,675		
	27 1/2	84	29	162	46	FLV2884DTEPL		\$2,539	\$2,793
	27 1/2	78	29	155	43	FLT2878DTEPR	\$1,634		
	27 1/2	78	29	155	43	FLV2878DTEPR		\$2,478	\$2,724
	27 1/2	78	29	155	43	FLT2878DTEPL	\$1,634		
	27 1/2	78	29	155	43	FLV2878DTEPL		\$2,478	\$2,724
	27 1/2	72	29	148	40	FLT2872DTEPR	\$1,597		
	27 1/2	72	29	148	40	FLV2872DTEPR		\$2,417	\$2,657
	27 1/2	72	29	148	40	FLT2872DTEPL	\$1,597		
	27 1/2	72	29	148	40	FLV2872DTEPL		\$2,417	\$2,657
	27 1/2	66	29	141	37	FLT2866DTEPR	\$1,564		
	27 1/2	66	29	141	37	FLV2866DTEPR		\$2,368	\$2,606
	27 1/2	66	29	141	37	FLT2866DTEPL	\$1,564		
	27 1/2	66	29	141	37	FLV2866DTEPL		\$2,368	\$2,606

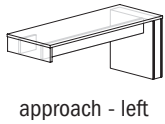
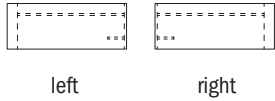
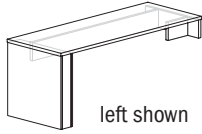

Features:

- peninsula desk mounting included in the list price of the unit, but must be specified when ordering secondary credenza; see pages 16-18 for details
- eased edge profile on approach and user sides
- 6 3/4" h modesty with horizontal wire channel

Options:

- must specify support panels grain direction on double cut veneer, see pages 11-13 for details
- on laminate units, contrasting worksurface tops and drawer fronts available, no upcharge; specify laminate color, see page 14 for details
- top grommet available, specify location; add \$128 list each; see page 42 for details
- 12" wide top grommet available, specify location; add \$168 list each; see page 42 for details
- worksurface power available, specify "to accommodate EC26" on your purchase order; EC26 unit must be ordered separately, see page 42
- wire manager tray available see accessory section on pages 48-49 for details

To Order, Specify:

① Laminate Model #	② Laminate Type	③ Laminate Selection	④ Metal Color	⑤ Other Product Options
Laminate (FLT)	HPL	See Laminate Selection	See Metal Finish Color Options	See list of options for each specific unit; Specify and add accordingly.

① Veneer Model #	② Wood Species	③ Wood Finish	④ Metal Color	⑤ Other Product Options
Veneer (FLV)	Flat Cut CH1 Cherry MA1 Maple WA1 Walnut BO1 Black Oak	See Flat Cut Wood Finish Options	See Metal Finish Color Options	See list of options for each specific unit; Specify and add accordingly.
		<table border="1"> <tr> <th>Ⓐ Wood Finish</th> <th>Ⓑ Chassis Grain Direction</th> </tr> <tr> <td>See Double Cut Wood Finish Options</td> <td>For Double Cut Only: Vertical Horizontal</td> </tr> </table>		
Ⓐ Wood Finish	Ⓑ Chassis Grain Direction			
See Double Cut Wood Finish Options	For Double Cut Only: Vertical Horizontal			

Description	D	W	H	CTN WT	CU FT	① Model	HPL Laminate	Flat Cut Veneer	Double Cut Veneer
Arc Peninsula Table Desk with Frame Base and Secondary Support End	33½	84	29	149	31	FLT3484PARCP	\$2,243		
	33½	84	29	149	31	FLV3484PARCP		\$2,963	\$3,258
	33½	78	29	140	28	FLT3478PARCP	\$2,195		
	33½	78	29	140	28	FLV3478PARCP		\$2,894	\$3,183
	33½	72	29	131	26	FLT3472PARCP	\$2,146		
	33½	72	29	131	26	FLV3472PARCP		\$2,828	\$3,112
	33½	66	29	122	24	FLT3466PARCP	\$2,126		
	33½	66	29	122	24	FLV3466PARCP		\$2,802	\$3,083

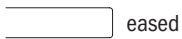
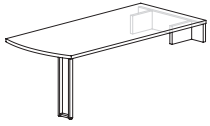

eased



reverse bevel

edges

Features:

- peninsula desk mounting included in the list price of the unit, but must be specified when ordering secondary credenza; see pages 16-18 for details
- eased edge profile on approach and user sides

Options:

- must specify support panels grain direction on double cut veneer, see pages 11-13 for details
- on laminate units, contrasting worksurface tops and chassis available, no upcharge; specify color see page 14 for details
- reverse bevel edge available on three sides, specify; add \$429 list for laminate or \$168 list for veneer; see page 8 for details
- 13 ½" h modesty panel available, specify; add \$427 list for laminate or \$594 list for veneer; see page 19 for details
- top grommet available, specify location; add \$128 list each; see page 47 for details
- 12" wide top grommet available, specify location; add \$163 list each; see page 42 for details
- worksurface power available, specify "to accommodate EC26" on your purchase order; EC26 unit must be ordered separately, see page 42
- wire manager tray available see accessory section on pages 48-49 for details

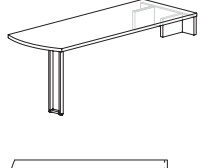
Description	D	W	H	CTN WT	CU FT	① Model	HPL Laminate	Flat Cut Veneer	Double Cut Veneer
Arc Peninsula Table Desk with Frame Base and Secondary Support End 	27 1/2	84	29	128	25	FLT2884PARCP	\$2,168		
	27 1/2	84	29	128	25	FLV2884PARCP		\$2,859	\$3,143
	27 1/2	78	29	122	24	FLT2878PARCP	\$2,120		
	27 1/2	78	29	122	24	FLV2878PARCP		\$2,795	\$3,074
	27 1/2	72	29	116	22	FLT2872PARCP	\$2,072		
	27 1/2	72	29	116	22	FLV2872PARCP		\$2,730	\$3,005
	27 1/2	66	29	110	20	FLT2866PARCP	\$2,055		
	27 1/2	66	29	110	20	FLV2866PARCP		\$2,705	\$2,976

Features:

- peninsula desk mounting included in the list price of the unit, but must be specified when ordering secondary credenza; see pages 16-18 for details
- eased edge profile on approach and user sides

Options:

- must specify support panels grain direction on double cut veneer, see pages 11-13 for details
- on laminate units, contrasting worksurface tops and chassis available, no upcharge; specify color see page 14 for details
- reverse bevel edge available on three sides, specify; add \$429 list for laminate or \$168 list for veneer; see page 8 for details
- 13 1/2" h modesty panel available, specify; add \$427 list for laminate or \$594 list for veneer; see page 19 for details
- top grommet available, specify location; add \$128 list each; see page 47 for details
- 12" wide top grommet available, specify location; add \$163 list each; see page 42 for details
- worksurface power available, specify "to accommodate EC26" on your purchase order; EC26 unit must be ordered separately, see page 42
- wire manager tray available see accessory section on pages 48-49 for details

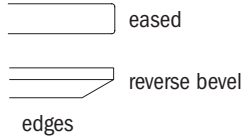

To Order, Specify:

① Laminate Model #	② Laminate Type	③ Laminate Selection	④ Metal Color	⑤ Other Product Options
Laminate (FLT)	HPL	See Laminate Selection	See Metal Finish Color Options	See list of options for each specific unit; Specify and add accordingly.

① Veneer Model #	② Wood Species	③ Wood Finish	④ Metal Color	⑤ Other Product Options
Veneer (FLV)	Flat Cut CH1 Cherry MA1 Maple WA1 Walnut BO1 Black Oak	See Flat Cut Wood Finish Options	See Metal Finish Color Options	See list of options for each specific unit; Specify and add accordingly.
		<table border="1"> <thead> <tr> <th>③a Wood Finish</th> <th>③b Chassis Grain Direction</th> </tr> </thead> <tbody> <tr> <td>See Double Cut Wood Finish Options</td> <td>For Double Cut Only: Vertical Horizontal</td> </tr> </tbody> </table>		
③a Wood Finish	③b Chassis Grain Direction			
See Double Cut Wood Finish Options	For Double Cut Only: Vertical Horizontal			

Description	D	W	H	CTN WT	CU FT	① Model	HPL Laminate	Flat Cut Veneer	Double Cut Veneer
Boomerang Peninsula Table Desk with End Leg Assembly and Secondary Support End	33½	84	29	149	31	FLT3484PBMNR	\$2,687		
	33½	84	29	149	31	FLV3484PBMNR		\$3,629	\$3,992
	33½	84	29	149	31	FLT3484PBMNL	\$2,687		
	33½	84	29	149	31	FLV3484PBMNL		\$3,629	\$3,992
	33½	78	29	140	28	FLT3478PBMNR	\$2,621		
	33½	78	29	140	28	FLV3478PBMNR		\$3,541	\$3,894
	33½	78	29	140	28	FLT3478PBMNL	\$2,621		
	33½	78	29	140	28	FLV3478PBMNL		\$3,541	\$3,894
	33½	72	29	131	26	FLT3472PBMNR	\$2,559		
	33½	72	29	131	26	FLV3472PBMNR		\$3,455	\$3,801
	33½	72	29	131	26	FLT3472PBMNL	\$2,559		
	33½	72	29	131	26	FLV3472PBMNL		\$3,455	\$3,801
	33½	66	29	122	24	FLT3466PBMNR	\$2,519		
	33½	66	29	122	24	FLV3466PBMNR		\$3,402	\$3,744
	33½	66	29	122	24	FLT3466PBMNL	\$2,519		
	33½	66	29	122	24	FLV3466PBMNL		\$3,402	\$3,744

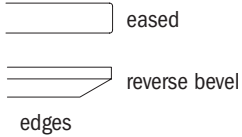
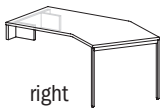
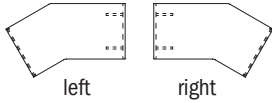
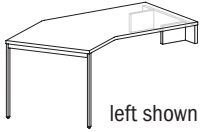



Features:

- peninsula desk mounting included in the list price of the unit, but must be specified when ordering secondary credenza; see pages 16-18 for details
- eased edge profile on approach and user sides

Options:

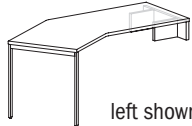
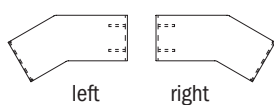
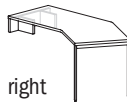
- must specify support panels grain direction on double cut veneer, see pages 11-13 for details
- on laminate units, contrasting worksurface tops and chassis available, no upcharge; specify color see page 14 for details
- reverse bevel edge available on three sides, specify; add \$429 list for laminate or \$168 list for veneer; see page 8 for details
- 13½" h modesty panel available for 84" w and 78" w desk, specify; add \$427 list for laminate or \$594 list for veneer; see page 19 for details
- top grommet available, specify location; add \$128 list each; see page 47 for details
- 12" wide top grommet available, specify location; add \$163 list each; see page 42 for details
- worksurface power available, specify "to accommodate EC26" on your purchase order; EC26 unit must be ordered separately, see page 42
- wire manager tray available see accessory section on pages 48-49 for details

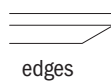
Description	D	W	H	CTN WT	CU FT	① Model	HPL Laminate	Flat Cut Veneer	Double Cut Veneer
Boomerang Peninsula Table	27 1/2	84	29	128	25	FLT2884PBMNR	\$2,630		
Desk with End Leg Assembly and Secondary Support End	27 1/2	84	29	128	25	FLV2884PBMNR		\$3,552	\$3,906
	27 1/2	84	29	128	25	FLT2884PBMNL	\$2,630		
 left shown  left right  right  eased  reverse bevel edges	27 1/2	84	29	128	25	FLV2884PBMNL		\$3,552	\$3,906
	27 1/2	78	29	122	24	FLT2878PBMNR	\$2,565		
	27 1/2	78	29	122	24	FLV2878PBMNR		\$3,464	\$3,812
	27 1/2	78	29	122	24	FLT2878PBMNL	\$2,565		
	27 1/2	78	29	122	24	FLV2878PBMNL		\$3,464	\$3,812
	27 1/2	72	29	116	22	FLT2872PBMNR	\$2,501		
	27 1/2	72	29	116	22	FLV2872PBMNR		\$3,380	\$3,718
	27 1/2	72	29	116	22	FLT2872PBMNL	\$2,501		
	27 1/2	72	29	116	22	FLV2872PBMNL		\$3,380	\$3,718
	27 1/2	66	29	110	20	FLT2866PBMNR	\$1,824		
	27 1/2	66	29	110	20	FLV2866PBMNR		\$2,465	\$2,713
	27 1/2	66	29	110	20	FLT2866PBMNL	\$1,824		
	27 1/2	66	29	110	20	FLV2866PBMNL		\$2,465	\$2,713

Features:

- peninsula desk mounting included in the list price of the unit, but must be specified when ordering secondary credenza; see pages 16-18 for details
- eased edge profile on approach and user sides

Options:

- must specify support panels grain direction on double cut veneer, see pages 11-13 for details
- on laminate units, contrasting worksurface tops and chassis available, no upcharge; specify color see page 14 for details
- reverse bevel edge available on three sides, specify; add \$429 list for laminate or \$168 list for veneer; see page 8 for details
- 13 1/2" h modesty panel available for 84" w and 78" w desk, specify; add \$427 list for laminate or \$594 list for veneer; see page 19 for details
- top grommet available, specify location; add \$128 list each; see page 47 for details
- 12" wide top grommet available, specify location; add \$163 list each; see page 42 for details
- worksurface power available, specify "to accommodate EC26" on your purchase order; EC26 unit must be ordered separately, see page 42
- wire manager tray available see accessory section on pages 48-49 for details

To Order, Specify:

① Laminate Model #	② Laminate Type	③ Laminate Selection	④ Metal Color	⑤ Other Product Options
Laminate (FLT)	HPL	See Laminate Selection	See Metal Finish Color Options	See list of options for each specific unit; Specify and add accordingly.

① Veneer Model #	② Wood Species	③ Wood Finish	④ Metal Color	⑤ Other Product Options		
Veneer (FLV)	Flat Cut CH1 Cherry MA1 Maple WA1 Walnut BO1 Black Oak	See Flat Cut Wood Finish Options	See Metal Finish Color Options	See list of options for each specific unit; Specify and add accordingly.		
	Double Cut DC1 Double Cut	<table border="1"> <tr> <th>ⓐ Wood Finish</th> <th>ⓑ Chassis Grain Direction</th> </tr> <tr> <td>See Double Cut Wood Finish Options</td> <td>For Double Cut Only: Vertical Horizontal</td> </tr> </table>	ⓐ Wood Finish		ⓑ Chassis Grain Direction	See Double Cut Wood Finish Options
ⓐ Wood Finish	ⓑ Chassis Grain Direction					
See Double Cut Wood Finish Options	For Double Cut Only: Vertical Horizontal					

Description	D	W	H	CTN WT	CU FT	① Model	HPL Laminate	Flat Cut Veneer	Double Cut Veneer
Rectangular Run-off Desk with End Leg Assembly	33½	72	29	119	22	FLT3472RRTN	\$1,639		
	33½	72	29	119	22	FLV3472RRTN		\$2,145	\$2,360
	33½	66	29	112	20	FLT3466RRTN	\$1,604		
	33½	66	29	112	20	FLV3466RRTN		\$2,098	\$2,307
	33½	60	29	105	18	FLT3460RRTN	\$1,569		
	33½	60	29	105	18	FLV3460RRTN		\$2,052	\$2,258
	33½	54	29	98	17	FLT3454RRTN	\$1,537		
	33½	54	29	98	17	FLV3454RRTN		\$2,004	\$2,205
	33½	48	29	91	16	FLT3448RRTN	\$1,516		
	33½	48	29	91	16	FLV3448RRTN		\$1,980	\$2,178

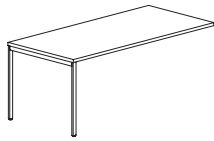

eased



reverse bevel

edges

Features:

- mounts perpendicular to primary height units
- eased edge profile on approach and user sides
- laminate tops wider than 60" are long grain

Options:

- reverse bevel edge available on three sides, specify; add \$429 list for laminate or \$168 list for veneer; see page 8 for details
- 13 ½" h modesty panel available, specify; add \$427 list for laminate or \$594 list for veneer; see page 19 for details
- top grommet available, specify location; add \$128 list each; see page 43 for details
- 12" wide top grommet available, specify location; add \$168 list each; see page 43 for details
- worksurface power available, specify "to accommodate EC26" on your purchase order; EC26 unit must be ordered separately, see page 43
- wire manager tray available see accessory section on pages 48-49 for details

Description	D	W	H	CTN WT	CU FT	① Model	HPL Laminate	Flat Cut Veneer	Double Cut Veneer
Rectangular Run-off Desk with End Leg Assembly 	27 1/2	72	29	101	18	FLT2872RRTN	\$1,618		
	27 1/2	72	29	101	18	FLV2872RRTN		\$2,114	\$2,326
	27 1/2	66	29	94	17	FLT2866RRTN	\$1,582		
	27 1/2	66	29	94	17	FLV2866RRTN		\$2,067	\$2,274
	27 1/2	60	29	87	15	FLT2860RRTN	\$1,548		
	27 1/2	60	29	87	15	FLV2860RRTN		\$2,021	\$2,223
	27 1/2	54	29	80	14	FLT2854RRTN	\$1,515		
	27 1/2	54	29	80	14	FLV2854RRTN		\$1,978	\$2,175
	27 1/2	48	29	80	13	FLT2848RRTN	\$1,495		
	27 1/2	48	29	80	13	FLV2848RRTN		\$1,951	\$2,146

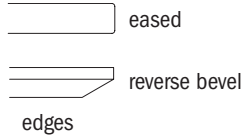

Features:

- mounts perpendicular to primary height units
- eased edge profile on approach and user sides
- laminate tops wider than 60" are long grain

Options:

- reverse bevel edge available on three sides, specify; add \$429 list for laminate or \$168 list for veneer; see page 8 for details
- 13 1/2" h modesty panel available, specify; add \$427 list for laminate or \$594 list for veneer; see page 19 for details
- top grommet available, specify location; add \$128 list each; see page 43 for details
- 12" wide top grommet available, specify location; add \$168 list each; see page 43 for details
- worksurface power available, specify "to accommodate EC26" on your purchase order; EC26 unit must be ordered separately, see page 43
- wire manager tray available see accessory section on pages 48-49 for details

To Order, Specify:

① Laminate Model #	② Laminate Type	③ Laminate Selection	④ Metal Color	⑤ Other Product Options
Laminate (FLT)	HPL	See Laminate Selection	See Metal Finish Color Options	See list of options for each specific unit; Specify and add accordingly.

① Veneer Model #	② Wood Species	③ Wood Finish	④ Metal Color	⑤ Other Product Options	
Veneer (FLV)	Flat Cut CH1 Cherry MA1 Maple WA1 Walnut BO1 Black Oak	See Flat Cut Wood Finish Options	See Metal Finish Color Options	See list of options for each specific unit; Specify and add accordingly.	
	Double Cut DC1 Double Cut	<table border="1"> <thead> <tr> <th>③a Wood Finish</th> <th>③b Chassis Grain Direction</th> </tr> </thead> <tbody> <tr> <td>See Double Cut Wood Finish Options</td> <td>For Double Cut Only: Vertical Horizontal</td> </tr> </tbody> </table>			③a Wood Finish
③a Wood Finish	③b Chassis Grain Direction				
See Double Cut Wood Finish Options	For Double Cut Only: Vertical Horizontal				

Description	D	W	H	CTN WT	CU FT	① Model	HPL Laminate	Flat Cut Veneer	Double Cut Veneer
Rectangular Run-off Desk with Frame Base	33½	72	29	119	22	FLT3472RRTP	\$1,639		
	33½	72	29	119	22	FLV3472RRTP		\$2,145	\$2,360
	33½	66	29	112	20	FLT3466RRTP	\$1,604		
	33½	66	29	112	20	FLV3466RRTP		\$2,098	\$2,307
	33½	60	29	105	18	FLT3460RRTP	\$1,569		
	33½	60	29	105	18	FLV3460RRTP		\$2,052	\$2,258
	33½	54	29	98	17	FLT3454RRTP	\$1,537		
	33½	54	29	98	17	FLV3454RRTP		\$2,004	\$2,205
	33½	48	29	91	16	FLT3448RRTP	\$1,516		
	33½	48	29	91	16	FLV3448RRTP		\$1,980	\$2,178

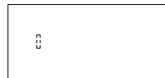
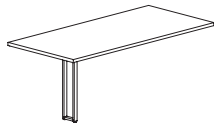

eased

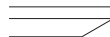

reverse bevel



edges

Features:

- mounts perpendicular to primary height units
- eased edge profile on approach and user sides
- laminate tops wider than 60" are long grain

Options:

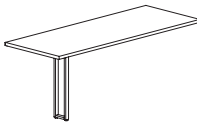
- reverse bevel edge available on three sides, specify; add \$429 list for laminate or \$168 list for veneer; see page 8 for details
- 13 ½" h modesty panel available, specify; add \$427 list for laminate or \$594 list for veneer; see page 19 for details
- top grommet available, specify location; add \$128 list each; see page 43 for details
- 12" wide top grommet available, specify location; add \$168 list each; see page 43 for details
- worksurface power available, specify "to accommodate EC26" on your purchase order; EC26 unit must be ordered separately, see page 43
- wire manager tray available see accessory section on pages 48-49 for details

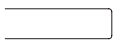
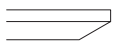
Description	D	W	H	CTN WT	CU FT	① Model	HPL Laminate	Flat Cut Veneer	Double Cut Veneer
   eased  reverse bevel edges	27 1/2	72	29	101	18	FLT2872RRTP	\$1,618		
	27 1/2	72	29	101	18	FLV2872RRTP		\$2,114	\$2,326
	27 1/2	66	29	94	17	FLT2866RRTP	\$1,582		
	27 1/2	66	29	94	17	FLV2866RRTP		\$2,067	\$2,274
	27 1/2	60	29	87	15	FLT2860RRTP	\$1,548		
	27 1/2	60	29	87	15	FLV2860RRTP		\$2,021	\$2,223
	27 1/2	54	29	80	14	FLT2854RRTP	\$1,515		
	27 1/2	54	29	80	14	FLV2854RRTP		\$1,978	\$2,175
	27 1/2	48	29	80	13	FLT2848RRTP	\$1,495		
	27 1/2	48	29	80	13	FLV2848RRTP		\$1,951	\$2,146

Features:

- mounts perpendicular to primary height units
- eased edge profile on approach and user sides
- laminate tops wider than 60" are long grain

Options:

- reverse bevel edge available on three sides, specify; add \$429 list for laminate or \$168 list for veneer; see page 8 for details
- 13 1/2" h modesty panel available, specify; add \$427 list for laminate or \$594 list for veneer; see page 19 for details
- top grommet available, specify location; add \$128 list each; see page 43 for details
- 12" wide top grommet available, specify location; add \$168 list each; see page 43 for details
- worksurface power available, specify "to accommodate EC26" on your purchase order; EC26 unit must be ordered separately, see page 43
- wire manager tray available see accessory section on pages 48-49 for details

To Order, Specify:

① Laminate Model #	② Laminate Type	③ Laminate Selection	④ Metal Color	⑤ Other Product Options
Laminate (FLT)	HPL	See Laminate Selection	See Metal Finish Color Options	See list of options for each specific unit; Specify and add accordingly.

① Veneer Model #	② Wood Species	③ Wood Finish	④ Metal Color	⑤ Other Product Options
Veneer (FLV)	Flat Cut CH1 Cherry MA1 Maple WA1 Walnut BO1 Black Oak	See Flat Cut Wood Finish Options	See Metal Finish Color Options	See list of options for each specific unit; Specify and add accordingly.
		<table border="1"> <thead> <tr> <th>③a Wood Finish</th> <th>③b Chassis Grain Direction</th> </tr> </thead> <tbody> <tr> <td>See Double Cut Wood Finish Options</td> <td>For Double Cut Only: Vertical Horizontal</td> </tr> </tbody> </table>		
③a Wood Finish	③b Chassis Grain Direction			
See Double Cut Wood Finish Options	For Double Cut Only: Vertical Horizontal			

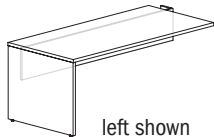
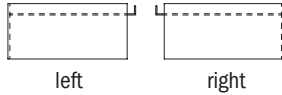
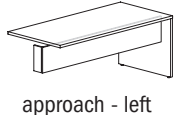
Description	D	W	H	CTN WT	CU FT	① Model	HPL Laminate	Flat Cut Veneer	Double Cut Veneer
Rectangular Run-off Desk with End Panel Support   	33½	72	29	141	48	FLT3472RDEPR	\$1,364		
	33½	72	29	141	48	FLV3472RDEPR		\$2,064	\$2,270
	33½	72	29	141	48	FLT3472RDEPL	\$1,364		
	33½	72	29	141	48	FLV3472RDEPL		\$2,064	\$2,270
	33½	66	29	130	44	FLT3466RDEPR	\$1,337		
	33½	66	29	130	44	FLV3466RDEPR		\$2,022	\$2,226
	33½	66	29	130	44	FLT3466RDEPL	\$1,337		
	33½	66	29	130	44	FLV3466RDEPL		\$2,022	\$2,226
	33½	60	29	119	40	FLT3460RDEPR	\$1,308		
	33½	60	29	119	40	FLV3460RDEPR		\$1,982	\$2,180
	33½	60	29	119	40	FLT3460RDEPL	\$1,308		
	33½	60	29	119	40	FLV3460RDEPL		\$1,982	\$2,180
	33½	54	29	108	36	FLT3454RDEPR	\$1,285		
	33½	54	29	108	36	FLV3454RDEPR		\$1,942	\$2,136
	33½	54	29	108	36	FLT3454RDEPL	\$1,285		
	33½	54	29	108	36	FLV3454RDEPL		\$1,942	\$2,136

Features:

- to be used with open corner primary height credenzas; see page 19
- mounts perpendicular to primary height units
- eased edge profile on approach and user sides
- laminate tops wider than 60" are long grain
- 6¾" h modesty with horizontal wire channel

Options:

- must specify support panels grain direction on double cut veneer, see pages 11-13 for details
- on laminate units, contrasting worksurface tops and chassis available, no upcharge; specify color, see page 14 for details
- top grommet available, specify location; add \$128 list each; see page 43 for details
- 12" wide top grommet available, specify location; add \$168 list each; see page 43 for details
- worksurface power available, specify "to accommodate EC26" on your purchase order; EC26 unit must be ordered separately, see page 43
- wire manager tray available see accessory section on pages 48-49 for details

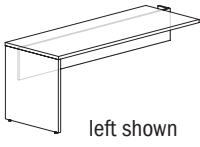
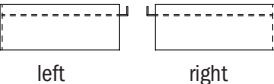
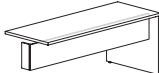
Description	D	W	H	CTN WT	CU FT	① Model	HPL Laminate	Flat Cut Veneer	Double Cut Veneer
 left shown  left right  approach - left	27 1/2	72	29	120	40	FLT2872RDEPR	\$1,125		
	27 1/2	72	29	120	40	FLV2872RDEPR		\$1,705	\$1,876
	27 1/2	72	29	120	40	FLT2872RDEPL	\$1,125		
	27 1/2	72	29	120	40	FLV2872RDEPL		\$1,705	\$1,876
	27 1/2	66	29	111	37	FLT2866RDEPR	\$1,104		
	27 1/2	66	29	111	37	FLV2866RDEPR		\$1,671	\$1,840
	27 1/2	66	29	111	37	FLT2866RDEPL	\$1,104		
	27 1/2	66	29	111	37	FLV2866RDEPL		\$1,671	\$1,840
	27 1/2	60	29	102	34	FLT2860RDEPR	\$1,082		
	27 1/2	60	29	102	34	FLV2860RDEPR		\$1,636	\$1,802
	27 1/2	60	29	102	34	FLT2860RDEPL	\$1,082		
	27 1/2	60	29	102	34	FLV2860RDEPL		\$1,636	\$1,802
	27 1/2	60	29	102	34	FLT2860RDEPL	\$1,082		
	27 1/2	60	29	102	34	FLV2860RDEPR		\$1,636	\$1,802
	27 1/2	54	29	93	30	FLT2854RDEPR	\$1,061		
	27 1/2	54	29	93	30	FLV2854RDEPR		\$1,604	\$1,766
	27 1/2	54	29	93	30	FLT2854RDEPL	\$1,061		
	27 1/2	54	29	93	30	FLV2854RDEPL		\$1,604	\$1,766

Features:

- to be used with open corner primary height credenzas; see page 19
- mounts perpendicular to primary height units
- eased edge profile on approach and user sides
- laminate tops wider than 60" are long grain
- 6 3/4" h modesty with horizontal wire channel

Options:

- must specify support panels grain direction on double cut veneer, see pages 11-13 for details
- on laminate units, contrasting worksurface tops and chassis available, no upcharge; specify color, see page 14 for details
- top grommet available, specify location; add \$128 list each; see page 43 for details
- 12" wide top grommet available, specify location; add \$168 list each; see page 43 for details
- worksurface power available, specify "to accommodate EC26" on your purchase order; EC26 unit must be ordered separately, see page 43
- wire manager tray available see accessory section on pages 48-49 for details

To Order, Specify:

① Laminate Model #	② Laminate Type	③ Laminate Selection	④ Metal Color	⑤ Other Product Options
Laminate (FLT)	HPL	See Laminate Selection	See Metal Finish Color Options	See list of options for each specific unit; Specify and add accordingly.

① Veneer Model #	② Wood Species	③ Wood Finish	④ Metal Color	⑤ Other Product Options
Veneer (FLV)	Flat Cut CH1 Cherry MA1 Maple WA1 Walnut BO1 Black Oak	See Flat Cut Wood Finish Options	See Metal Finish Color Options	See list of options for each specific unit; Specify and add accordingly.
		<table border="1"> <thead> <tr> <th>ⓐ Wood Finish</th> <th>ⓑ Chassis Grain Direction</th> </tr> </thead> <tbody> <tr> <td>See Double Cut Wood Finish Options</td> <td>For Double Cut Only: Vertical Horizontal</td> </tr> </tbody> </table>		
ⓐ Wood Finish	ⓑ Chassis Grain Direction			
See Double Cut Wood Finish Options	For Double Cut Only: Vertical Horizontal			

Description	D	W	H	CTN WT	CU FT	① Model	HPL Laminate	Flat Cut Veneer	Double Cut Veneer
Arc End Run-off Desk with Frame Base	33½	72	29	119	22	FLT3472ARCTP	\$1,799		
	33½	72	29	119	22	FLV3472ARCTP		\$2,362	\$2,598
	33½	66	29	112	20	FLT3466ARCTP	\$1,760		
	33½	66	29	112	20	FLV3466ARCTP		\$2,310	\$2,540
	33½	60	29	105	18	FLT3460ARCTP	\$1,722		
	33½	60	29	105	18	FLV3460ARCTP		\$2,258	\$2,482
	33½	54	29	98	17	FLT3454ARCTP	\$1,700		
	33½	54	29	98	17	FLV3454ARCTP		\$2,227	\$2,450
	33½	48	29	91	16	FLT3448ARCTP	\$1,677		
	33½	48	29	91	16	FLV3448ARCTP		\$2,197	\$2,417

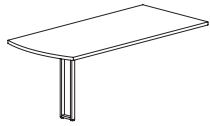

eased



reverse bevel

edges

Features:

- mounts perpendicular to primary height units
- eased edge profile on approach and user sides
- laminate tops wider than 60" are long grain

Options:

- reverse bevel edge available on three sides, specify; add \$429 list for laminate or \$168 list for veneer; see page 8 for details
- 13 ½" h modesty panel available, specify; add \$427 list for laminate or \$594 list for veneer; see page 19 for details
- top grommet available, specify location; add \$128 list each; see page 43 for details
- 12" wide top grommet available, specify location; add \$168 list each; see page 43 for details
- worksurface power available, specify "to accommodate EC26" on your purchase order; EC26 unit must be ordered separately, see page 43
- wire manager tray available see accessory section on pages 48-49 for details

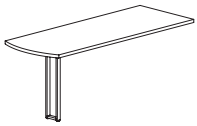
Description	D	W	H	CTN WT	CU FT	① Model	HPL Laminate	Flat Cut Veneer	Double Cut Veneer
Arc End Run-off Desk with Frame Base 	27 1/2	72	29	101	18	FLT2872ARCTP	\$1,755		
	27 1/2	72	29	101	18	FLV2872ARCTP		\$2,303	\$2,531
	27 1/2	66	29	94	17	FLT2866ARCTP	\$1,716		
	27 1/2	66	29	94	17	FLV2866ARCTP		\$2,251	\$2,477
	27 1/2	60	29	87	15	FLT2860ARCTP	\$1,679		
	27 1/2	60	29	87	15	FLV2860ARCTP		\$2,200	\$2,421
	27 1/2	54	29	80	14	FLT2854ARCTP	\$1,644		
	27 1/2	54	29	80	14	FLV2854ARCTP		\$2,151	\$2,367
	27 1/2	48	29	80	13	FLT2848ARCTP	\$1,623		
	27 1/2	48	29	80	13	FLV2848ARCTP		\$2,124	\$2,334



 eased

 reverse bevel edges

Features:

- mounts perpendicular to primary height units
- eased edge profile on approach and user sides
- laminate tops wider than 60" are long grain

Options:

- reverse bevel edge available on three sides, specify; add \$429 list for laminate or \$168 list for veneer; see page 8 for details
- 13 1/2" h modesty panel available, specify; add \$427 list for laminate or \$594 list for veneer; see page 19 for details
- top grommet available, specify location; add \$128 list each; see page 43 for details
- 12" wide top grommet available, specify location; add \$168 list each; see page 43 for details
- worksurface power available, specify "to accommodate EC26" on your purchase order; EC26 unit must be ordered separately, see page 43
- wire manager tray available see accessory section on pages 48-49 for details

To Order, Specify:

① Laminate Model #	② Laminate Type	③ Laminate Selection	④ Metal Color	⑤ Other Product Options
Laminate (FLT)	HPL	See Laminate Selection	See Metal Finish Color Options	See list of options for each specific unit; Specify and add accordingly.

① Veneer Model #	② Wood Species	③ Wood Finish	④ Metal Color	⑤ Other Product Options
Veneer (FLV)	Flat Cut CH1 Cherry MA1 Maple WA1 Walnut BO1 Black Oak	See Flat Cut Wood Finish Options	See Metal Finish Color Options	See list of options for each specific unit; Specify and add accordingly.
		<table border="1"> <thead> <tr> <th>③a Wood Finish</th> <th>③b Chassis Grain Direction</th> </tr> </thead> <tbody> <tr> <td>See Double Cut Wood Finish Options</td> <td>For Double Cut Only: Vertical Horizontal</td> </tr> </tbody> </table>		
③a Wood Finish	③b Chassis Grain Direction			
See Double Cut Wood Finish Options	For Double Cut Only: Vertical Horizontal			

Description	D	W	H	CTN WT	CU FT	① Model	HPL Laminate	Flat Cut Veneer	Double Cut Veneer
Boomerang Run-off Desk with End Leg Assembly	33½	72	29	119	22	FLT3472BMTNR	\$2,400		
	33½	72	29	119	22	FLV3472BMTNR		\$3,173	\$3,491
	33½	72	29	119	22	FLT3472BMTNL	\$2,400		
	33½	72	29	119	22	FLV3472BMTNL		\$3,173	\$3,491
	33½	66	29	112	20	FLT3466BMTNR	\$2,356		
	33½	66	29	112	20	FLV3466BMTNR		\$3,115	\$3,426
	33½	66	29	112	20	FLT3466BMTNL	\$2,356		
	33½	66	29	112	20	FLV3466BMTNL		\$3,115	\$3,426
	33½	60	29	105	18	FLT3460BMTNR	\$2,313		
	33½	60	29	105	18	FLV3460BMTNR		\$3,056	\$3,361
	33½	60	29	105	18	FLT3460BMTNL	\$2,313		
	33½	60	29	105	18	FLV3460BMTNL		\$3,056	\$3,361

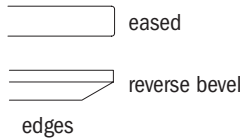
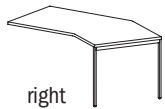
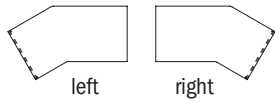
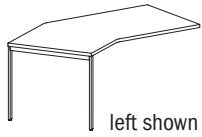

Features:

- mounts perpendicular to primary height units
- eased edge profile on approach and user sides
- laminate tops wider than 60" are long grain

Options:

- reverse bevel edge available on three sides, specify; add \$429 list for laminate or \$168 list for veneer; see page 8 for details
- 13 ½" h modesty panel available, specify; add \$427 list for laminate or \$594 list for veneer; see page 19 for details
- top grommet available, specify location; add \$128 list each; see page 43 for details
- 12" wide top grommet available, specify location; add \$168 list each; see page 43 for details
- worksurface power available, specify "to accommodate EC26" on your purchase order; EC26 unit must be ordered separately, see page 43
- wire manager tray available see accessory section on pages 48-49 for details

Description	D	W	H	CTN WT	CU FT	① Model	HPL Laminate	Flat Cut Veneer	Double Cut Veneer
Boomerang Run-off Desk with End Leg Assembly	27 1/2	72	29	101	18	FLT2872BMTNR	\$2,345		
	27 1/2	72	29	101	18	FLV2872BMTNR		\$3,097	\$3,409
	27 1/2	66	29	94	17	FLT2866BMTNL	\$2,304		
	27 1/2	66	29	94	17	FLV2866BMTNL		\$3,041	\$3,345
	27 1/2	60	29	87	15	FLT2860BMTNR	\$2,261		
	27 1/2	60	29	87	15	FLV2860BMTNR		\$2,984	\$3,283
	27 1/2	72	29	101	18	FLT2872BMTNL	\$2,345		
	27 1/2	72	29	101	18	FLV2872BMTNL		\$3,097	\$3,409
	27 1/2	66	29	94	17	FLT2866BMTNR	\$2,304		
	27 1/2	66	29	94	17	FLV2866BMTNR		\$3,041	\$3,345
	27 1/2	60	29	87	15	FLT2860BMTNL	\$2,261		
	27 1/2	60	29	87	15	FLV2860BMTNL		\$2,984	\$3,283

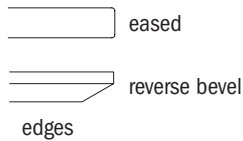
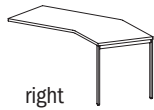
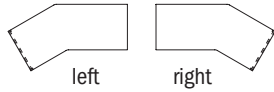
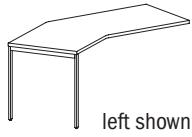

Features:

- mounts perpendicular to primary height units
- eased edge profile on approach and user sides
- laminate tops wider than 60" are long grain

Options:

- reverse bevel edge available on three sides, specify; add \$429 list for laminate or \$168 list for veneer; see page 8 for details
- 13 1/2" h modesty panel available, specify; add \$427 list for laminate or \$594 list for veneer; see page 19 for details
- top grommet available, specify location; add \$128 list each; see page 43 for details
- 12" wide top grommet available, specify location; add \$168 list each; see page 43 for details
- worksurface power available, specify "to accommodate EC26" on your purchase order; EC26 unit must be ordered separately, see page 43
- wire manager tray available see accessory section on pages 48-49 for details

To Order, Specify:

① Laminate Model #	② Laminate Type	③ Laminate Selection	④ Metal Color	⑤ Other Product Options
Laminate (FLT)	HPL	See Laminate Selection	See Metal Finish Color Options	See list of options for each specific unit; Specify and add accordingly.

① Veneer Model #	② Wood Species	③ Wood Finish	④ Metal Color	⑤ Other Product Options
Veneer (FLV)	Flat Cut CH1 Cherry MA1 Maple WA1 Walnut BO1 Black Oak	See Flat Cut Wood Finish Options	See Metal Finish Color Options	See list of options for each specific unit; Specify and add accordingly.
		<table border="1"> <thead> <tr> <th>③a Wood Finish</th> <th>③b Chassis Grain Direction</th> </tr> </thead> <tbody> <tr> <td>See Double Cut Wood Finish Options</td> <td>For Double Cut Only: Vertical Horizontal</td> </tr> </tbody> </table>		
③a Wood Finish	③b Chassis Grain Direction			
See Double Cut Wood Finish Options	For Double Cut Only: Vertical Horizontal			

Description	D	W	H	CTN WT	CU FT	① Model	HPL Laminate	Flat Cut Veneer	Double Cut Veneer
<p>left shown</p>	22	60	29	129	27	FLT2260-29FERR	\$1,598		
	22	60	29	129	27	FLV2260-29FERR		\$2,231	\$2,453
	22	60	29	129	27	FLT2260-29FELR	\$1,598		
	22	60	29	129	27	FLV2260-29FELR		\$2,231	\$2,453
	22	54	29	124	25	FLT2254-29FERR	\$1,566		
	22	54	29	124	25	FLV2254-29FERR		\$2,187	\$2,405
	22	54	29	124	25	FLT2254-29FELR	\$1,566		
	22	54	29	124	25	FLV2254-29FELR		\$2,187	\$2,405
	22	48	29	119	22	FLT2248-29FERR	\$1,537		
	22	48	29	119	22	FLV2248-29FERR		\$2,145	\$2,360
	22	48	29	119	22	FLT2248-29FELR	\$1,537		
	22	48	29	119	22	FLV2248-29FELR		\$2,145	\$2,360
	22	42	29	114	20	FLT2242-29FERR	\$1,506		
	22	42	29	114	20	FLV2242-29FERR		\$2,103	\$2,312
	22	42	29	114	20	FLT2242-29FELR	\$1,506		
	22	42	29	114	20	FLV2242-29FELR		\$2,103	\$2,312

Features:

- eased edge user side only
- pedestal front locking

Options:

- must specify chassis grain direction on double cut veneer, see pages 11-13 for details
- standard without kneespace modesty panel, partial and full modesty panels available; add \$161 list for laminate or \$201 list for veneer; see page 10 for details
- veneer drawer fronts in paint available, specify paint color; add \$337 list; see page 14 for details
- on laminate units, contrasting worksurface tops and drawer fronts available, no upcharge; specify color, see page 14 for details
- ledge pulls standard; prism pulls available, specify and see page 9
- interior wire manager from side to side in upper back, specify and add \$114 list; see page 15 for details
- top grommet available, specify location and add \$128 list each; see page 43 for details
- worksurface power available, specify "to accommodate EC26" on your purchase order; EC26 unit must be ordered separately, see page 43

Description	D	W	H	CTN WT	CU FT	① Model	HPL Laminate	Flat Cut Veneer	Double Cut Veneer
 <p>left shown</p>	22	60	29	129	27	FLT2260-29FERY	\$1,606		
	22	60	29	129	27	FLV2260-29FERY		\$2,238	\$2,460
	22	60	29	129	27	FLT2260-29FELY	\$1,606		
	22	60	29	129	27	FLV2260-29FELY		\$2,238	\$2,460
	22	54	29	124	25	FLT2254-29FERY	\$1,575		
	22	54	29	124	25	FLV2254-29FERY		\$2,195	\$2,415
	22	54	29	124	25	FLT2254-29FELY	\$1,575		
	22	54	29	124	25	FLV2254-29FELY		\$2,195	\$2,415
	22	48	29	119	22	FLT2248-29FERY	\$1,545		
	22	48	29	119	22	FLV2248-29FERY		\$2,151	\$2,367
	22	48	29	119	22	FLT2248-29FELY	\$1,545		
	22	48	29	119	22	FLV2248-29FELY		\$2,151	\$2,367
	22	42	29	114	20	FLT2242-29FERY	\$1,514		
	22	42	29	114	20	FLV2242-29FERY		\$2,109	\$2,320
	22	42	29	114	20	FLT2242-29FELY	\$1,514		
	22	42	29	114	20	FLV2242-29FELY		\$2,109	\$2,320

Features:

- eased edge user side only
- pedestal front locking

Options:

- must specify chassis grain direction on double cut veneer, see pages 11-13 for details
- standard without kneespace modesty panel, partial and full modesty panels available; add \$161 list for laminate or \$201 list for veneer; see page 10 for details
- veneer drawer fronts in paint available, specify paint color; add \$337 list; see page 14 for details
- on laminate units, contrasting worksurface tops and drawer fronts available, no upcharge; specify color, see page 14 for details
- ledge pulls standard; prism pulls available, specify and see page 9
- interior wire manager from side to side in upper back, specify and add \$114 list; see page 15 for details
- top grommet available, specify location and add \$128 list each; see page 43 for details
- worksurface power available, specify "to accommodate EC26" on your purchase order; EC26 unit must be ordered separately, see page 43

To Order, Specify:

① Laminate Model #	② Laminate Type	③ Laminate Selection	④ Metal Color	⑤ Other Product Options
Laminate (FLT)	HPL	See Laminate Selection	See Metal Finish Color Options	See list of options for each specific unit; Specify and add accordingly.

① Veneer Model #	② Wood Species	③ Wood Finish	④ Metal Color	⑤ Other Product Options
Veneer (FLV)	Flat Cut CH1 Cherry MA1 Maple WA1 Walnut BO1 Black Oak	See Flat Cut Wood Finish Options	See Metal Finish Color Options	See list of options for each specific unit; Specify and add accordingly.
		<table border="1"> <thead> <tr> <th>ⓐ Wood Finish</th> <th>ⓑ Chassis Grain Direction</th> </tr> </thead> <tbody> <tr> <td>See Double Cut Wood Finish Options</td> <td>For Double Cut Only: Vertical Horizontal</td> </tr> </tbody> </table>		
ⓐ Wood Finish	ⓑ Chassis Grain Direction			
See Double Cut Wood Finish Options	For Double Cut Only: Vertical Horizontal			

Description	D	W	H	CTN WT	CU FT	① Model	HPL Laminate	Flat Cut Veneer	Double Cut Veneer
 left shown	22	60	29	185	27	FLT2260-29FLRR	\$1,886		
	22	60	29	185	27	FLV2260-29FLRR		\$2,634	\$2,896
	22	60	29	185	27	FLT2260-29FLLR	\$1,886		
	22	60	29	185	27	FLV2260-29FLLR		\$2,634	\$2,896
	22	54	29	180	25	FLT2254-29FLRR	\$1,841		
	22	54	29	180	25	FLV2254-29FLRR		\$2,569	\$2,826
	22	54	29	180	25	FLT2254-29FLLR	\$1,841		
	22	54	29	180	25	FLV2254-29FLLR		\$2,569	\$2,826
	22	48	29	175	22	FLT2248-29FLRR	\$1,796		
	22	48	29	175	22	FLV2248-29FLRR		\$2,507	\$2,759
22	48	29	175	22	FLT2248-29FLLR	\$1,796			
22	48	29	175	22	FLV2248-29FLLR		\$2,507	\$2,759	

Features:

- eased edge user side only
- pedestal front locking

Options:

- must specify chassis grain direction on double cut veneer, see pages 11-13 for details
- standard without kneespace modesty panel, partial and full modesty panels available; add \$161 list for laminate or \$201 list for veneer; see page 10 for details
- veneer drawer fronts in paint available, specify paint color; add \$337 list; see page 14 for details
- on laminate units, contrasting worksurface tops and drawer fronts available, no upcharge; specify color, see page 14 for details
- ledge pulls standard; prism pulls available, specify and see page 9
- interior wire manager from side to side in upper back, specify and add \$114 list; see page 15 for details
- top grommet available, specify location and add \$128 list each; see page 43 for details
- worksurface power available, specify "to accommodate EC26" on your purchase order; EC26 unit must be ordered separately, see page 43

Description	D	W	H	CTN WT	CU FT	① Model	HPL Laminate	Flat Cut Veneer	Double Cut Veneer
 left shown	22	60	29	185	27	FLT2260-29FLRY	\$1,896		
	22	60	29	185	27	FLV2260-29FLRY		\$2,647	\$2,911
	22	60	29	185	27	FLT2260-29FLLY	\$1,896		
	22	60	29	185	27	FLV2260-29FLLY		\$2,647	\$2,911
	22	54	29	180	25	FLT2254-29FLRY	\$1,851		
	22	54	29	180	25	FLV2254-29FLRY		\$2,582	\$2,841
	22	54	29	180	25	FLT2254-29FLLY	\$1,851		
	22	54	29	180	25	FLV2254-29FLLY		\$2,582	\$2,841
	22	48	29	175	22	FLT2248-29FLRY	\$1,806		
	22	48	29	175	22	FLV2248-29FLRY		\$2,520	\$2,771
22	48	29	175	22	FLT2248-29FLLY	\$1,806			
22	48	29	175	22	FLV2248-29FLLY		\$2,520	\$2,771	

Features:

- eased edge user side only
- pedestal front locking

Options:

- must specify chassis grain direction on double cut veneer, see pages 11-13 for details
- standard without kneespace modesty panel, partial and full modesty panels available; add \$161 list for laminate or \$201 list for veneer; see page 10 for details
- veneer drawer fronts in paint available, specify paint color; add \$337 list; see page 14 for details
- on laminate units, contrasting worksurface tops and drawer fronts available, no upcharge; specify color, see page 14 for details
- ledge pulls standard; prism pulls available, specify and see page 9
- interior wire manager from side to side in upper back, specify and add \$114 list; see page 15 for details
- top grommet available, specify location and add \$128 list each; see page 43 for details
- worksurface power available, specify "to accommodate EC26" on your purchase order; EC26 unit must be ordered separately, see page 43

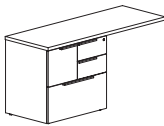
Description	D	W	H	CTN WT	CU FT	① Model	HPL Laminate	Flat Cut Veneer	Double Cut Veneer
 left shown	22	60	29	191	27	FLT2260-29FMRR	\$2,017		
	22	60	29	191	27	FLV2260-29FMRR		\$2,818	\$3,097
	22	60	29	191	27	FLT2260-29FMLR	\$2,017		
	22	60	29	191	27	FLV2260-29FMLR		\$2,818	\$3,097
	22	54	29	186	25	FLT2254-29FMRR	\$1,970		
	22	54	29	186	25	FLV2254-29FMRR		\$2,749	\$3,023
	22	54	29	186	25	FLT2254-29FMLR	\$1,970		
	22	54	29	186	25	FLV2254-29FMLR		\$2,749	\$3,023
	22	48	29	181	22	FLT2248-29FMRR	\$1,920		
	22	48	29	181	22	FLV2248-29FMRR		\$2,682	\$2,950
	22	48	29	181	22	FLT2248-29FMLR	\$1,920		
	22	48	29	181	22	FLV2248-29FMLR		\$2,682	\$2,950

Features:

- eased edge user side only
- pedestal front locking

Options:

- must specify chassis grain direction on double cut veneer, see pages 11-13 for details
- standard without kneespace modesty panel, partial and full modesty panels available; add \$161 list for laminate or \$201 list for veneer; see page 10 for details
- veneer drawer fronts in paint available, specify paint color; add \$337 list; see page 14 for details
- on laminate units, contrasting worksurface tops and drawer fronts available, no upcharge; specify color, see page 14 for details
- ledge pulls standard; prism pulls available, specify and see page 9
- interior wire manager from side to side in upper back, specify and add \$114 list; see page 15 for details
- top grommet available, specify location and add \$128 list each; see page 43 for details
- worksurface power available, specify "to accommodate EC26" on your purchase order; EC26 unit must be ordered separately, see page 43

To Order, Specify:

① Laminate Model #	② Laminate Type	③ Laminate Selection	④ Metal Color	⑤ Other Product Options
Laminate (FLT)	HPL	See Laminate Selection	See Metal Finish Color Options	See list of options for each specific unit; Specify and add accordingly.

① Veneer Model #	② Wood Species	③ Wood Finish	④ Metal Color	⑤ Other Product Options
Veneer (FLV)	Flat Cut CH1 Cherry MA1 Maple WA1 Walnut BO1 Black Oak	See Flat Cut Wood Finish Options	See Metal Finish Color Options	See list of options for each specific unit; Specify and add accordingly.
		<table border="1"> <thead> <tr> <th>③a Wood Finish</th> <th>③b Chassis Grain Direction</th> </tr> </thead> <tbody> <tr> <td>See Double Cut Wood Finish Options</td> <td>For Double Cut Only: Vertical Horizontal</td> </tr> </tbody> </table>		
③a Wood Finish	③b Chassis Grain Direction			
See Double Cut Wood Finish Options	For Double Cut Only: Vertical Horizontal			

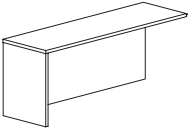
Description	D	W	H	CTN WT	CU FT	① Model	HPL Laminate	Flat Cut Veneer	Double Cut Veneer
 left shown	22	72	29	119	33	FLT2272RSHR	\$1,130		
	22	72	29	119	33	FLV2272RSHR		\$1,710	\$1,882
	22	72	29	119	33	FLT2272LSHR	\$1,130		
	22	72	29	119	33	FLV2272LSHR		\$1,710	\$1,882
	22	66	29	114	30	FLT2266RSHR	\$1,099		
	22	66	29	114	30	FLV2266RSHR		\$1,661	\$1,825
	22	66	29	114	30	FLT2266LSHR	\$1,099		
	22	66	29	114	30	FLV2266LSHR		\$1,661	\$1,825
	22	60	29	109	27	FLT2260RSHR	\$1,064		
	22	60	29	109	27	FLV2260RSHR		\$1,610	\$1,772
	22	60	29	109	27	FLT2260LSHR	\$1,064		
	22	60	29	109	27	FLV2260LSHR		\$1,610	\$1,772
	22	54	29	104	25	FLT2254RSHR	\$1,033		
	22	54	29	104	25	FLV2254RSHR		\$1,562	\$1,719
	22	54	29	104	25	FLT2254LSHR	\$1,033		
	22	54	29	104	25	FLV2254LSHR		\$1,562	\$1,719
	22	48		99	22	FLT2248RSHR	\$1,001		
	22	48	29	99	22	FLV2248RSHR		\$1,515	\$1,668
	22	48	29	99	22	FLT2248LSHR	\$1,001		
	22	48	29	99	22	FLV2248LSHR		\$1,515	\$1,668
22	42	29	94	20	FLT2242RSHR	\$971			
22	42	29	94	20	FLV2242RSHR		\$1,471	\$1,618	
22	42	29	94	20	FLT2242LSHR	\$971			
22	42	29	94	20	FLV2242LSHR		\$1,471	\$1,618	
22	36	29	89	17	FLT2236RSHR	\$943			
22	36	29	89	17	FLV2236RSHR		\$1,427	\$1,568	
22	36	29	89	17	FLT2236LSHR	\$943			
22	36	29	89	17	FLV2236LSHR		\$1,427	\$1,568	

Features:

- eased edge user side only
- laminate tops wider than 60" are long grain

Options:

- must specify chassis grain direction on double cut veneer, see pages 11-13 for details
- top grommet available, specify location; add \$128 list each; see page 43 for details

Description	D	W	H	CTN WT	CU FT	① Model	HPL Laminate	Flat Cut Veneer	Double Cut Veneer
Bridge 	22	50	1 3/16	69	3	FLT2250EB	\$596		
	22	50	1 3/16	69	3	FLV2250EB		\$743	\$817
	22	44	1 3/16	64	3	FLT2244EB	\$557		
	22	44	1 3/16	64	3	FLV2244EB		\$696	\$767
	22	38	1 3/16	59	2	FLT2238EB	\$548		
	22	38	1 3/16	59	2	FLV2238EB		\$685	\$753

Features:

- eased edge user side only

Options:

- standard without kneespace modesty panel, partial and full modesty panels available; add \$161 list for laminate or \$201 list for veneer; see page 10 for details
- when specify modesty with double cut veneer, specify grain direction, see pages 11-13 for details
- top grommet available, specify location; add \$128 list each; see page 43 for details
- worksurface power available, specify "to accommodate EC26" on your purchase order; EC26 unit must be ordered separately, see page 43

To Order, Specify:

① Laminate Model #	② Laminate Type	③ Laminate Selection	④ Metal Color	⑤ Other Product Options
Laminate (FLT)	HPL	See Laminate Selection	See Metal Finish Color Options	See list of options for each specific unit; Specify and add accordingly.

① Veneer Model #	② Wood Species	③ Wood Finish	④ Metal Color	⑤ Other Product Options
Veneer (FLV)	Flat Cut CH1 Cherry MA1 Maple WA1 Walnut BO1 Black Oak	See Flat Cut Wood Finish Options	See Metal Finish Color Options	See list of options for each specific unit; Specify and add accordingly.
	Double Cut DC1 Double Cut	③a Wood Finish See Double Cut Wood Finish Options		

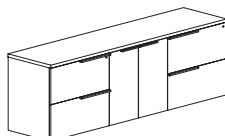
Description	D	W	H	CTN WT	CU FT	① Model	HPL Laminate	Flat Cut Veneer	Double Cut Veneer
	22	96	29	437	43	FLT2296-29F474	\$3,488		
	22	96	29	437	43	FLV2296-29F474		\$4,866	\$5,354
	22	90	29	416	40	FLT2290-29F474	\$3,386		
	22	90	29	416	40	FLV2290-29F474		\$4,726	\$5,199
	22	84	29	395	38	FLT2284-29F474	\$3,285		
	22	84	29	395	38	FLV2284-29F474		\$4,588	\$5,047

Features:

- eased edge profile user side
- pedestal front locking
- hinged door compartment has one adjustable shelf

Options:

- must specify chassis grain direction on double cut veneer, see pages 11-13 for details
- locking doors available, specify and add \$142 list
- veneer door and drawer fronts in paint available, specify paint color and add \$337; see page 14 for details
- on laminate units, contrasting worksurface tops and door fronts available, no upcharge; specify laminate color, see page 14 for details
- ledge pulls standard; prism pulls available, specify and see page 9
- oval grommets in back panel can be eliminated upon request, no upcharge
- interior horizontal wire manager with end grommets available, specify and add \$180 list; see page 38 for details
- top grommet available, specify location; add \$128 list each; see page 45 for details
- worksurface power available, specify "to accommodate EC26" on your purchase order; EC26 unit must be ordered separately, see page 45

FLUX - PRIVATE OFFICE

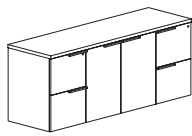
Description	D	W	H	CTN WT	CU FT	① Model	HPL Laminate	Flat Cut Veneer	Double Cut Veneer
	22	78	29	354	35	FLT2278-29F272	\$2,884		
	22	78	29	354	35	FLV2278-29F272		\$4,028	\$4,431
	22	72	29	333	32	FLT2272-29F272	\$2,801		
	22	72	29	333	32	FLV2272-29F272		\$3,910	\$4,299
	22	66	29	310	30	FLT2266-29F272	\$2,745		
	22	66	29	310	30	FLV2266-29F272		\$3,832	\$4,216
	22	60	29	289	27	FLT2260-29F272	\$2,689		
	22	60	29	289	27	FLV2260-29F272		\$3,754	\$4,132

Features:

- eased edge profile user side
- pedestal front locking
- hinged door compartment has one adjustable shelf

Options:

- must specify chassis grain direction on double cut veneer, see pages 11-13 for details
- locking doors available, specify and add \$142 list
- veneer door and drawer fronts in paint available, specify paint color and add \$337; see page 14 for details
- on laminate units, contrasting worksurface tops and door fronts available, no upcharge; specify laminate color, see page 14 for details
- ledge pulls standard; prism pulls available, specify and see page 9
- oval grommets in back panel can be eliminated upon request, no upcharge
- interior horizontal wire manager with end grommets available, specify and add \$180 list; see page 38 for details
- top grommet available, specify location; add \$128 list each; see page 45 for details
- worksurface power available, specify "to accommodate EC26" on your purchase order; EC26 unit must be ordered separately, see page 45

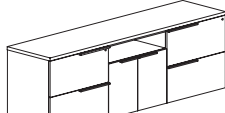
Description	D	W	H	CTN WT	CU FT	① Model	HPL Laminate	Flat Cut Veneer	Double Cut Veneer
Storage Credenza with Open Center 	22	96	29	447	43	FLT2296-29F484	\$3,566		
	22	96	29	447	43	FLV2296-29F484		\$4,980	\$5,478
	22	90	29	425	40	FLT2290-29F484	\$3,462		
	22	90	29	425	40	FLV2290-29F484		\$4,835	\$5,316
	22	84	29	402	38	FLT2284-29F484	\$3,361		
	22	84	29	402	38	FLV2284-29F484		\$4,695	\$5,163

Features:

- eased edge profile user side
- pedestal front locking
- hinged door compartment has one adjustable shelf

Options:

- must specify chassis grain direction on double cut veneer, see pages 11-13 for details
- locking doors available, specify and add \$142 list
- veneer door and drawer fronts in paint available, specify paint color and add \$337; see page 14 for details
- on laminate units, contrasting worksurface tops and door fronts available, no upcharge; specify laminate color, see page 14 for details
- ledge pulls standard; prism pulls available, specify and see page 9
- oval grommets in back panel can be eliminated upon request, no upcharge
- interior horizontal wire manager with end grommets available, specify and add \$180 list; see page 38 for details
- top grommet available, specify location; add \$128 list each; see page 45 for details
- worksurface power available, specify "to accommodate EC26" on your purchase order; EC26 unit must be ordered separately, see page 45

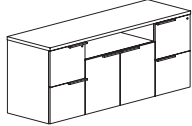
Storage Credenza with Open Center 	22	78	29	366	35	FLT2278-29F282	\$2,900		
	22	78	29	366	35	FLV2278-29F282		\$4,048	\$4,452
	22	72	29	344	32	FLT2272-29F282	\$2,816		
	22	72	29	344	32	FLV2272-29F282		\$3,930	\$4,324
	22	66	29	320	30	FLT2266-29F282	\$2,759		
	22	66	29	320	30	FLV2266-29F282		\$3,852	\$4,239
	22	60	29	298	27	FLT2260-29F282	\$2,704		
	22	60	29	298	27	FLV2260-29F282		\$3,775	\$4,153

Features:

- eased edge profile user side
- pedestal front locking
- hinged door compartment has one adjustable shelf

Options:

- must specify chassis grain direction on double cut veneer, see pages 11-13 for details
- locking doors available, specify and add \$142 list
- veneer door and drawer fronts in paint available, specify paint color and add \$337; see page 14 for details
- on laminate units, contrasting worksurface tops and door fronts available, no upcharge; specify laminate color, see page 14 for details
- ledge pulls standard; prism pulls available, specify and see page 9
- oval grommets in back panel can be eliminated upon request, no upcharge
- interior horizontal wire manager with end grommets available, specify and add \$180 list; see page 38 for details
- top grommet available, specify location; add \$128 list each; see page 45 for details
- worksurface power available, specify "to accommodate EC26" on your purchase order; EC26 unit must be ordered separately, see page 45

To Order, Specify:

① Laminate Model #	② Laminate Type	③ Laminate Selection	④ Metal Color	⑤ Other Product Options	
Laminate (FLT)	TFL	See Laminate Selection	See Metal Finish Color Options	See list of options for each specific unit; Specify and add accordingly.	
	HLP				
① Veneer Model #	② Wood Species	③ Wood Finish	④ Metal Color	⑤ Other Product Options	
Veneer (FLV)	Flat Cut CH1 Cherry MA1 Maple WA1 Walnut BO1 Black Oak	See Flat Cut Wood Finish Options	See Metal Finish Color Options	See list of options for each specific unit; Specify and add accordingly.	
	Double Cut DC1 Double Cut	<table border="1"> <thead> <tr> <th>ⓐ Wood Finish</th> <th>ⓑ Chassis Grain Direction</th> </tr> </thead> <tbody> <tr> <td>See Double Cut Wood Finish Options</td> <td>For Double Cut Only: Vertical Horizontal</td> </tr> </tbody> </table>			ⓐ Wood Finish
ⓐ Wood Finish	ⓑ Chassis Grain Direction				
See Double Cut Wood Finish Options	For Double Cut Only: Vertical Horizontal				

Description	D	W	H	CTN WT	CU FT	① Model	HPL Laminate	Fiat Cut Veneer	Double Cut Veneer
Lateral File Credenza	22	90	29	448	40	FLT2290-29F444	\$3,153		
	22	90	29	448	40	FLV2290-29F444		\$4,396	\$4,836

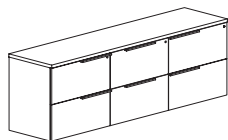

Features:

- eased edge profile user side
- pedestal front locking

Options:

- must specify chassis grain direction on double cut veneer, see pages 11-13 for details
- veneer drawer fronts in paint available, specify paint color and add \$337 list; see page 14 for details
- on laminate units, contrasting worksurface tops and drawer fronts available, no upcharge; specify color, see page 14 for details
- ledge pulls standard; prism pulls available, specify and see page 9
- oval grommets in back panel can be eliminated upon request, no upcharge
- top grommet available, specify location and add \$128 list each; see page 45 for details

Lateral File Credenza	22	72	29	354	32	FLT2272-29F44	\$2,357		
	22	72	29	354	32	FLV2272-29F44		\$3,291	\$3,620
	22	60	29	310	27	FLT2260-29F44	\$2,267		
	22	60	29	310	27	FLV2260-29F44		\$3,163	\$3,480

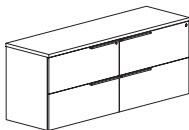

Features:

- eased edge profile user side
- pedestal front locking

Options:

- must specify chassis grain direction on double cut veneer, see pages 11-13 for details
- veneer drawer fronts in paint available, specify paint color and add \$337 list; see page 14 for details
- on laminate units, contrasting worksurface tops and drawer fronts available, no upcharge; specify color, see page 14 for details
- ledge pulls standard; prism pulls available, specify and see page 9
- oval grommets in back panel can be eliminated upon request, no upcharge
- top grommet available, specify location and add \$128 list each; see page 45 for details

Lateral File Pedestal	22	36	29	166	17	FLT2236-29F4	\$1,744		
	22	36	29	166	17	FLV2236-29F4		\$2,435	\$2,679
	22	30	29	150	14	FLT2230-29F4	\$1,494		
	22	30	29	150	17	FLV2230-29F4		\$2,085	\$2,294

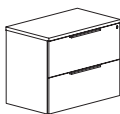

Features:

- eased edge profile user side
- pedestal front locking
- anti-tip interlock mechanism

Options:

- must specify chassis grain direction on double cut veneer, see pages 11-13 for details
- veneer drawer fronts in paint available, specify paint color and add \$337 list; see page 14 for details
- on laminate units, contrasting worksurface tops and drawer fronts available, no upcharge; specify color, see page 14 for details
- ledge pulls standard; prism pulls available, specify and see page 9
- oval grommet in back panel can be eliminated upon request, no upcharge
- top grommet available, specify location and add \$128 list each; see page 45 for details

FLUX - PRIVATE OFFICE

Description	D	W	H	CTN WT	CU FT	① Model	HPL Laminate	Flat Cut Veneer	Double Cut Veneer
 Box/Box/Lateral File Pedestal	22	36	29	166	17	FLT2236-29F3	\$1,756		
	22	36	29	166	17	FLV2236-29F3		\$2,447	\$2,692
	22	30	29	150	14	FLT2230-29F3	\$1,505		
	22	30	29	150	17	FLV2230-29F3		\$2,096	\$2,306

Features:

- eased edge profile user side
- pedestal front locking
- anti-tip interlock mechanism

Options:

- must specify chassis grain direction on double cut veneer, see pages 11-13 for details
- veneer drawer fronts in paint available, specify paint color and add \$337 list; see page 14 for details
- on laminate units, contrasting worksurface tops and drawer fronts available, no upcharge; specify color, see page 14 for details
- ledge pulls standard; prism pulls available, specify and see page 9
- oval grommet in back panel can be eliminated upon request, no upcharge
- top grommet available, specify location and add \$128 list each; see page 45 for details

To Order, Specify:

① Laminate Model #	② Laminate Type	③ Laminate Selection	④ Metal Color	⑤ Other Product Options
Laminate (FLT)	HPL	See Laminate Selection	See Metal Finish Color Options	See list of options for each specific unit; Specify and add accordingly.

① Veneer Model #	② Wood Species	③ Wood Finish	④ Metal Color	⑤ Other Product Options
Veneer (FLV)	Flat Cut CH1 Cherry MA1 Maple WA1 Walnut BO1 Black Oak	See Flat Cut Wood Finish Options	See Metal Finish Color Options	See list of options for each specific unit; Specify and add accordingly.
	Double Cut DC1 Double Cut	③a Wood Finish See Double Cut Wood Finish Options		

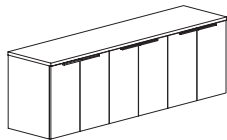
Description	D	W	H	CTN WT	CU FT	① Model	HPL Laminate	Flat Cut Veneer	Double Cut Veneer
Six Door Storage Credenza 	22	96	29	386	43	FLT2296-29F777	\$2,874		
	22	96	29	386	43	FLV2296-29F777		\$4,225	\$4,649
	22	90	29	365	40	FLT2290-29F777	\$2,791		
	22	90	29	365	40	FLV2290-29F777		\$4,102	\$4,513
	22	84	29	344	38	FLT2284-29F777	\$2,720		
	22	84	29	344	38	FLV2284-29F777		\$4,000	\$4,400

Features:

- eased edge profile user side
- each hinged door compartment has one adjustable shelf

Options:

- must specify chassis grain direction on double cut veneer, see pages 11-13 for details
- locking doors available, specify and add \$426 list
- veneer door fronts in paint available, specify paint color and add \$337 list; see page 14 for details
- on laminate units, contrasting worksurface tops and door fronts available, no upcharge; specify color, see page 14 for details
- ledge pulls standard; prism pulls available, specify and see page 9
- oval grommets in back panel can be eliminated upon request, no upcharge
- interior horizontal wire manager with end grommets available, specify and add \$180 list; see page 38 for details
- top grommet available, specify location; add \$128 list each; see page 45 for details
- worksurface power available, specify "to accommodate EC26" on your purchase order; EC26 unit must be ordered separately, see page 45

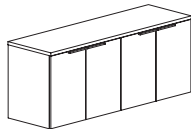
Four Door Storage Credenza 	22	78	29	312	34	FLT2278-29F77	\$2,496		
	22	78	29	312	34	FLV2278-29F77		\$3,667	\$4,034
	22	72	29	291	32	FLT2272-29F77	\$2,424		
	22	72	29	291	32	FLV2272-29F77		\$3,562	\$3,917
	22	66	29	270	29	FLT2266-29F77	\$2,326		
	22	66	29	270	29	FLV2266-29F77		\$3,419	\$3,761
	22	60	29	265	27	FLT2260-29F77	\$2,234		
	22	60	29	265	27	FLV2260-29F77		\$3,283	\$3,613

Features:

- eased edge profile user side
- each hinged door compartment has one adjustable shelf

Options:

- must specify chassis grain direction on double cut veneer, see pages 11-13 for details
- locking doors available, specify and add \$284 list
- veneer door fronts in paint available, specify paint color and add \$337 list; see page 14 for details
- on laminate units, contrasting worksurface tops and door fronts available, no upcharge; specify color, see page 14 for details
- ledge pulls standard; prism pulls available, specify and see page 9
- oval grommets in back panel can be eliminated upon request, no upcharge
- interior horizontal wire manager with end grommets available, specify and add \$180 list; see page 38 for details
- top grommet available, specify location; add \$128 list each; see page 45 for details
- worksurface power available, specify "to accommodate EC26" on your purchase order; EC26 unit must be ordered separately, see page 45

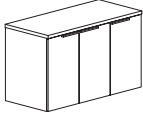
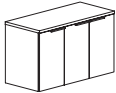
Description	D	W	H	CTN WT	CU FT	① Model	HPL Laminate	Flat Cut Veneer	Double Cut Veneer
 right shown  left	22	54	29	228	24	FLT2254-29F77R	\$2,034		
	22	54	29	228	24	FLV2254-29F77R		\$2,986	\$3,285
	22	54	29	228	24	FLT2254-29F77L	\$2,034		
	22	54	29	228	24	FLV2254-29F77L		\$2,986	\$3,285
	22	48	29	206	22	FLT2248-29F77R	\$1,931		
	22	48	29	206	22	FLV2248-29F77R		\$2,838	\$3,124
	22	48	29	206	22	FLT2248-29F77L	\$1,931		
	22	48	29	206	22	FLV2248-29F77L		\$2,838	\$3,124
	22	42	29	185	19	FLT2242-29F77R	\$1,834		
	22	42	29	185	19	FLV2242-29F77R		\$2,695	\$2,966
	22	42	29	185	19	FLT2242-29F77L	\$1,834		
	22	42	29	185	19	FLV2242-29F77L		\$2,695	\$2,966

Features:

- eased edge profile user side
- each hinged door compartment has one adjustable shelf

Options:

- must specify chassis grain direction on double cut veneer, see pages 11-13 for details
- locking doors available, specify and add \$284 list
- veneer door fronts in paint available, specify paint color and add \$337 list; see page 14 for details
- on laminate units, contrasting worksurface tops and door fronts available, no upcharge; specify color, see page 14 for details
- ledge pulls standard; prism pulls available, specify and see page 9
- oval grommets in back panel can be eliminated upon request, no upcharge
- interior horizontal wire manager with end grommets available, specify and add \$180 list; see page 38 for details
- top grommet available, specify location; add \$128 list each; see page 45 for details
- worksurface power available, specify "to accommodate EC26" on your purchase order; EC26 unit must be ordered separately, see page 45
- pull out trash can available, specify and add \$456 list; see page 36 for details

	22	36	29	156	17	FLT2236-29F7	\$1,303		
	22	36	29	156	17	FLV2236-29F7		\$1,917	\$2,108
	22	30	29	132	14	FLT2230-29F7	\$1,252		
	22	30	29	132	14	FLV2230-29F7		\$1,840	\$2,023

Features:

- eased edge profile user side
- each hinged door compartment has one adjustable shelf

Options:

- must specify chassis grain direction on double cut veneer, see pages 11-13 for details
- locking doors available, specify and add \$142 list
- veneer door fronts in paint available, specify paint color and add \$337 list; see page 14 for details
- on laminate units, contrasting worksurface tops and door fronts available, no upcharge; specify color, see page 14 for details
- ledge pulls standard; prism pulls available, specify and see page 9
- oval grommets in back panel can be eliminated upon request, no upcharge
- interior horizontal wire manager with end grommets available, specify and add \$180 list; see page 38 for details
- top grommet available, specify location; add \$128 list each; see page 45 for details
- worksurface power available, specify "to accommodate EC26" on your purchase order; EC26 unit must be ordered separately, see page 45

To Order, Specify:

① Laminate Model #	② Laminate Type	③ Laminate Selection	④ Metal Color	⑤ Other Product Options	
Laminate (FLT)	TFL	See Laminate Selection	See Metal Finish Color Options	See list of options for each specific unit; Specify and add accordingly.	
	HLP				
① Veneer Model #	② Wood Species	③ Wood Finish	④ Metal Color	⑤ Other Product Options	
Veneer (FLV)	Flat Cut CH1 Cherry MA1 Maple WA1 Walnut BO1 Black Oak	See Flat Cut Wood Finish Options	See Metal Finish Color Options	See list of options for each specific unit; Specify and add accordingly.	
	Double Cut DC1 Double Cut	<table border="1"> <thead> <tr> <th>ⓐ Wood Finish</th> <th>ⓑ Chassis Grain Direction</th> </tr> </thead> <tbody> <tr> <td>See Double Cut Wood Finish Options</td> <td>For Double Cut Only: Vertical Horizontal</td> </tr> </tbody> </table>			ⓐ Wood Finish
ⓐ Wood Finish	ⓑ Chassis Grain Direction				
See Double Cut Wood Finish Options	For Double Cut Only: Vertical Horizontal				

Description	D	W	H	CTN WT	CU FT	① Model	HPL Laminate	Flat Cut Veneer	Double Cut Veneer
Six Door Credenza with Open Center	22	96	29	394	43	FLT2296-29F787	\$2,995		
	22	96	29	394	43	FLV2296-29F787		\$4,180	\$4,598
	22	90	29	372	40	FLT2290-29F787	\$2,908		
	22	90	29	372	40	FLV2290-29F787		\$4,062	\$4,466
	22	84	29	353	38	FLT2284-29F787	\$2,823		
	22	84	29	353	38	FLV2284-29F787		\$3,941	\$4,334

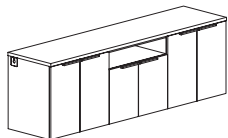

Features:

- eased edge profile user side
- each hinged door compartment has one adjustable shelf

Options:

- must specify chassis grain direction on double cut veneer, see pages 11-13 for details
- locking doors available, specify and add \$426 list
- veneer door and drawer fronts in paint available, specify paint color and add \$337; see page 14 for details
- on laminate units, contrasting worksurface tops and door fronts available, no upcharge; specify color, see page 14 for details
- ledge pulls standard; prism pulls available, specify and see page 9
- oval grommets in back panel can be eliminated upon request, no upcharge
- interior horizontal wire manager with end grommets available, specify and add \$180 list; see page 38 for details
- top grommet available, specify location; add \$128 list each; see page 45 for details
- worksurface power available, specify "to accommodate EC26" on your purchase order; EC26 unit must be ordered separately, see page 45

Four Door Credenza with Open Center	22	78	29	339	35	FLT2278-29F787	\$2,582		
	22	78	29	339	35	FLV2278-29F787		\$3,795	\$4,176
	22	72	29	310	32	FLT2272-29F787	\$2,496		
	22	72	29	310	32	FLV2272-29F787		\$3,667	\$4,034
	22	66	29	288	30	FLT2266-29F787	\$2,421		
	22	66	29	288	30	FLV2266-29F787		\$3,560	\$3,916
	22	60	29	266	27	FLT2260-29F787	\$2,350		
	22	60	29	266	27	FLV2260-29F787		\$3,453	\$3,796

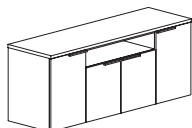

Features:

- eased edge profile user side
- each hinged door compartment has one adjustable shelf

Options:

- must specify chassis grain direction on double cut veneer, see pages 11-13 for details
- locking doors available, specify and add \$426 list
- veneer door and drawer fronts in paint available, specify paint color and add \$337; see page 14 for details
- on laminate units, contrasting worksurface tops and door fronts available, no upcharge; specify color, see page 14 for details
- ledge pulls standard; prism pulls available, specify and see page 9
- oval grommets in back panel can be eliminated upon request, no upcharge
- interior horizontal wire manager with end grommets available, specify and add \$180 list; see page 38 for details
- top grommet available, specify location; add \$128 list each; see page 45 for details
- worksurface power available, specify "to accommodate EC26" on your purchase order; EC26 unit must be ordered separately, see page 45
- pull out trash can available, specify and add \$456 list; see page 36 for details

Description	D	W	H	CTN WT	CU FT	① Model	HPL Laminate	Flat Cut Veneer	Double Cut Veneer
Two Door Credenza with Open Storage Compartment	22	54	29	228	25	FLT2254-29F707	\$2,138		
	22	54	29	228	25	FLV2254-29F707		\$3,140	\$3,457
	22	48	29	208	22	FLT2248-29F707	\$2,033		
	22	48	29	208	22	FLV2248-29F707		\$2,985	\$3,284
	22	42	29	189	19	FLT2242-29F707	\$1,930		
	22	42	29	189	19	FLV2242-29F707		\$2,836	\$3,121

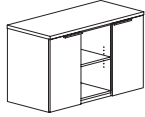

Features:

- eased edge profile user side
- each compartment has one adjustable shelf

Options:

- must specify chassis grain direction on double cut veneer, see pages 11-13 for details
- locking doors available, specify and add \$284 list
- veneer door fronts in paint available, specify paint color and add \$337 list; see page 14 for details
- on laminate units, contrasting worksurface tops and door fronts available, no upcharge; specify color, see page 14 for details
- ledge pulls standard; prism pulls available, specify and see page 9
- oval grommets in back panel can be eliminated upon request, no upcharge
- interior horizontal wire manager with end grommets available, specify and add \$180 list; see page 38 for details
- top grommet available, specify location; add \$128 list each; see page 45 for details
- worksurface power available, specify "to accommodate EC26" on your purchase order; EC26 unit must be ordered separately, see page 45
- pull out trash can available, specify and add \$456 list; see page 36 for details

To Order, Specify:

① Laminate Model #	② Laminate Type	③ Laminate Selection	④ Metal Color	⑤ Other Product Options
Laminate (FLT)	HPL	See Laminate Selection	See Metal Finish Color Options	See list of options for each specific unit; Specify and add accordingly.

① Veneer Model #	② Wood Species	③ Wood Finish	④ Metal Color	⑤ Other Product Options
Veneer (FLV)	Flat Cut CH1 Cherry MA1 Maple WA1 Walnut BO1 Black Oak	See Flat Cut Wood Finish Options	See Metal Finish Color Options	See list of options for each specific unit; Specify and add accordingly.
		<table border="1"> <thead> <tr> <th>ⓐ Wood Finish</th> <th>ⓑ Chassis Grain Direction</th> </tr> </thead> <tbody> <tr> <td>See Double Cut Wood Finish Options</td> <td>For Double Cut Only: Vertical Horizontal</td> </tr> </tbody> </table>		
ⓐ Wood Finish	ⓑ Chassis Grain Direction			
See Double Cut Wood Finish Options	For Double Cut Only: Vertical Horizontal			

Description	D	W	H	CTN WT	CU FT	① Model	HPL Laminate	Flat Cut Veneer	Double Cut Veneer
Lateral File and Open Storage Credenza	22	96	29	426	43	FLT2296-29F044	\$3,080		
	22	96	29	426	43	FLV2296-29F044		\$4,296	\$4,727
	22	96	29	436	43	FLT2296-29F440	\$3,080		
	22	96	29	436	43	FLV2296-29F440		\$4,296	\$4,727
	22	90	29	409	40	FLT2290-29F044	\$2,985		
	22	90	29	409	40	FLV2290-29F044		\$4,168	\$4,586
	22	90	29	409	40	FLT2290-29F440	\$2,985		
	22	90	29	409	40	FLV2290-29F440		\$4,168	\$4,586

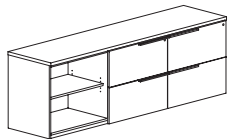

*044 shown

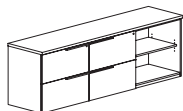

*440

Features:

- eased edge profile user side
- pedestal front locking
- open compartment with adjustable shelf
- shelf 12 1/2"d

Options:

- must specify chassis grain direction on double cut veneer, see pages 11-13 for details
- veneer drawer fronts in paint available, specify paint color and add \$337 list; see page 14 for details
- on laminate units, contrasting worksurface tops and drawer fronts available, no upcharge; specify color, see page 14 for details
- ledge pulls standard; prism pulls available, specify and see page 9
- oval grommets in back panel can be eliminated upon request, no upcharge
- interior horizontal wire manager with end grommets available, specify and add \$180 list; see page 38 for details
- top grommet available, specify location; add \$128 list each; see page 45 for details
- worksurface power available, specify "to accommodate EC26" on your purchase order; EC26 unit must be ordered separately, see page 45

Lateral File and Open Storage Credenza	22	72	29	295	32	FLT2272-29F04	\$2,373		
	22	72	29	295	32	FLV2272-29F04		\$3,313	\$3,644
	22	72	29	295	32	FLT2272-29F40	\$2,373		
	22	72	29	295	32	FLV2272-29F40		\$3,313	\$3,644
	22	66	29	273	30	FLT2266-29F04	\$2,257		
	22	66	29	273	30	FLV2266-29F04		\$3,148	\$3,462
	22	66	29	273	30	FLT2266-29F40	\$2,257		
	22	66	29	273	30	FLV2266-29F40		\$3,148	\$3,462
	22	60	29	256	27	FLT2260-29F04	\$2,144		
	22	60	29	256	27	FLV2260-29F04		\$2,989	\$3,289
22	60	29	256	27	FLT2260-29F40	\$2,144			
22	60	29	256	27	FLV2260-29F40		\$2,989	\$3,289	

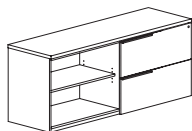

*04 shown

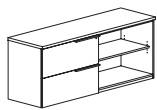

*40

Features:

- eased edge profile user side
- pedestal front locking
- open compartment with adjustable shelf
- shelf 12 1/2"d

Options:

- must specify chassis grain direction on double cut veneer, see pages 11-13 for details
- veneer drawer fronts in paint available, specify paint color and add \$337 list; see page 14 for details
- on laminate units, contrasting worksurface tops and drawer fronts available, no upcharge; specify color, see page 14 for details
- ledge pulls standard; prism pulls available, specify and see page 9
- oval grommets in back panel can be eliminated upon request, no upcharge
- interior horizontal wire manager with end grommets available, specify and add \$180 list; see page 38 for details
- top grommet available, specify location; add \$128 list each; see page 45 for details
- worksurface power available, specify "to accommodate EC26" on your purchase order; EC26 unit must be ordered separately, see page 44

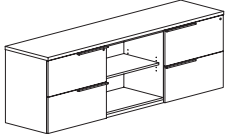
Description	D	W	H	CTN WT	CU FT	① Model	HPL Laminate	Flat Cut Veneer	Double Cut Veneer
Lateral Files and Open Storage Credenza 	22	96	29	416	43	FLT2296-29F404	\$3,080		
	22	96	29	416	43	FLV2296-29F404		\$4,296	\$4,727
	22	90	29	399	40	FLT2290-29F404	\$2,985		
	22	90	29	399	40	FLV2290-29F404		\$4,168	\$4,586

Features:

- eased edge profile user side
- pedestal front locking
- open compartment with adjustable shelf
- shelf 12 1/2"d

Options:

- must specify chassis grain direction on double cut veneer, see pages 11-13 for details
- veneer drawer fronts in paint available, specify paint color and add \$337 list; see page 14 for details
- on laminate units, contrasting worksurface tops and drawer fronts available, no upcharge; specify color, see page 14 for details
- ledge pulls standard; prism pulls available, specify and see page 9
- oval grommets in back panel can be eliminated upon request, no upcharge
- interior horizontal wire manager with end grommets available, specify and add \$180 list; see page 38 for details
- top grommet available, specify location; add \$128 list each; see page 45 for details
- worksurface power available, specify "to accommodate EC26" on your purchase order; EC26 unit must be ordered separately, see page 45

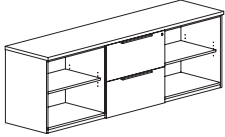
Description	D	W	H	CTN WT	CU FT	① Model	HPL Laminate	Flat Cut Veneer	Double Cut Veneer
Lateral File and Open Storage Credenza 	22	96	29	375	43	FLT2296-29F040	\$2,855		
	22	96	29	375	43	FLV2296-29F040		\$3,986	\$4,384
	22	90	29	353	40	FLT2290-29F040	\$2,768		
	22	90	29	353	40	FLV2290-29F040		\$3,867	\$4,253

Features:

- eased edge profile user side
- pedestal front locking
- open compartment with adjustable shelf
- shelf 12 1/2"d

Options:

- must specify chassis grain direction on double cut veneer, see pages 11-13 for details
- veneer drawer fronts in paint available, specify paint color and add \$337 list; see page 14 for details
- on laminate units, contrasting worksurface tops and drawer fronts available, no upcharge; specify color, see page 14 for details
- ledge pulls standard; prism pulls available, specify and see page 9
- oval grommets in back panel can be eliminated upon request, no upcharge
- interior horizontal wire manager with end grommets available, specify and add \$180 list; see page 38 for details
- top grommet available, specify location; add \$128 list each; see page 45 for details
- worksurface power available, specify "to accommodate EC26" on your purchase order; EC26 unit must be ordered separately, see page 45

To Order, Specify:

① Laminate Model #	② Laminate Type	③ Laminate Selection	④ Metal Color	⑤ Other Product Options
Laminate (FLT)	HPL	See Laminate Selection	See Metal Finish Color Options	See list of options for each specific unit; Specify and add accordingly.

① Veneer Model #	② Wood Species	③ Wood Finish	④ Metal Color	⑤ Other Product Options
Veneer (FLV)	Flat Cut CH1 Cherry MA1 Maple WA1 Walnut BO1 Black Oak	See Flat Cut Wood Finish Options	See Metal Finish Color Options	See list of options for each specific unit; Specify and add accordingly.
		<table border="1"> <thead> <tr> <th>ⓐ Wood Finish</th> <th>ⓑ Chassis Grain Direction</th> </tr> </thead> <tbody> <tr> <td>See Double Cut Wood Finish Options</td> <td>For Double Cut Only: Vertical Horizontal</td> </tr> </tbody> </table>		
ⓐ Wood Finish	ⓑ Chassis Grain Direction			
See Double Cut Wood Finish Options	For Double Cut Only: Vertical Horizontal			

Description	D	W	H	CTN WT	CU FT	① Model	HPL Laminate	Flat Cut Veneer	Double Cut Veneer
Double Sliding Door Credenza	22	90	29	345	40	FLT2290-29F909	\$2,474		
	22	90	29	345	40	FLV2290-29F909		\$3,634	\$3,999

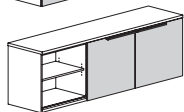
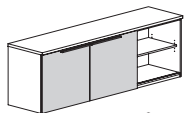
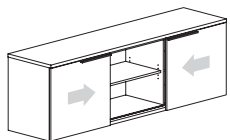

Features:

- eased edge profile user side
- locking doors not available
- each compartment has one adjustable shelf
- shelves 12 1/2" d

Options:

- must specify chassis grain direction on double cut veneer, see pages 11-13 for details
- veneer door fronts in paint available, specify paint color and add \$337 list; see page 14 for details
- on laminate units, contrasting worksurface tops and door fronts available, no upcharge; specify color, see page 14 for details
- ledge pulls standard; prism pulls available, specify and see page 9
- oval grommets in back panel can be eliminated upon request, no upcharge
- interior horizontal wire manager with end grommets available, specify and add \$180 list; see page 38 for details
- top grommet available, specify location; add \$128 list each; see page 45 for details
- worksurface power available, specify "to accommodate EC26" on your purchase order; EC26 unit must be ordered separately, see page 45

Sliding Door Credenza	22	90	29	327	40	FLT2290-29F090	\$2,350		
	22	90	29	327	40	FLV2290-29F090		\$3,453	\$3,796

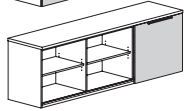
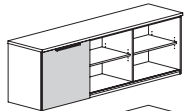
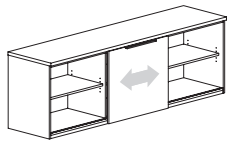

Features:

- eased edge profile user side
- locking doors not available
- each compartment has one adjustable shelf
- shelves 12 1/2" d

Options:

- must specify chassis grain direction on double cut veneer, see pages 11-13 for details
- veneer door fronts in paint available, specify paint color and add \$337 list; see page 14 for details
- on laminate units, contrasting worksurface tops and door fronts available, no upcharge; specify color, see page 14 for details
- ledge pulls standard; prism pulls available, specify and see page 9
- oval grommets in back panel can be eliminated upon request, no upcharge
- interior horizontal wire manager with end grommets available, specify and add \$180 list; see page 38 for details
- top grommet available, specify location; add \$128 list each; see page 45 for details
- worksurface power available, specify "to accommodate EC26" on your purchase order; EC26 unit must be ordered separately, see page 45

Description	D	W	H	CTN WT	CU FT	① Model	HPL Laminate	Flat Cut Veneer	Double Cut Veneer
Sliding Door Credenza	22	72	29	268	32	FLT2272-29F09	\$2,067		
	22	72	29	268	32	FLV2272-29F09		\$3,039	\$3,343
	22	60	29	228	27	FLT2260-29F09	\$1,951		
	22	60	29	228	27	FLV2260-29F09		\$2,867	\$3,153

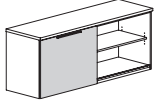
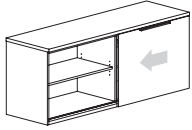

Features:

- eased edge profile user side
- locking doors not available
- each compartment has one adjustable shelf
- shelves 12 1/2"d

Options:

- must specify chassis grain direction on double cut veneer, see pages 11-13 for details
- veneer door fronts in paint available, specify paint color and add \$337 list; see page 14 for details
- on laminate units, contrasting worksurface tops and door fronts available, no upcharge; specify color, see page 14 for details
- ledge pulls standard; prism pulls available, specify and see page 9
- oval grommets in back panel can be eliminated upon request, no upcharge
- interior horizontal wire manager with end grommets available, specify and add \$180 list; see page 38 for details
- top grommet available, specify location; add \$128 list each; see page 45 for details
- worksurface power available, specify "to accommodate EC26" on your purchase order; EC26 unit must be ordered separately, see page 45

FLUX - PRIVATE OFFICE

To Order, Specify:

① Laminate Model #	② Laminate Type	③ Laminate Selection	④ Metal Color	⑤ Other Product Options
Laminate (FLT)	HPL	See Laminate Selection	See Metal Finish Color Options	See list of options for each specific unit; Specify and add accordingly.

① Veneer Model #	② Wood Species	③ Wood Finish	④ Metal Color	⑤ Other Product Options	
Veneer (FLV)	Flat Cut CH1 Cherry MA1 Maple WA1 Walnut BO1 Black Oak	See Flat Cut Wood Finish Options	See Metal Finish Color Options	See list of options for each specific unit; Specify and add accordingly.	
	Double Cut DC1 Double Cut	<table border="1"> <thead> <tr> <th>③a Wood Finish</th> <th>③b Chassis Grain Direction</th> </tr> </thead> <tbody> <tr> <td>See Double Cut Wood Finish Options</td> <td>For Double Cut Only: Vertical Horizontal</td> </tr> </tbody> </table>			③a Wood Finish
③a Wood Finish	③b Chassis Grain Direction				
See Double Cut Wood Finish Options	For Double Cut Only: Vertical Horizontal				

Description	D	W	H	CTN WT	CU FT	① Model	HPL Laminate	Flat Cut Veneer	Double Cut Veneer
Open Compartment Credenza	22	96	29	325	43	FLT2296-29F000	\$2,198		
	22	96	29	325	43	FLV2296-29F000		\$3,230	\$3,554
	22	90	29	308	40	FLT2290-29F000	\$2,134		
	22	90	29	308	40	FLV2290-29F000		\$3,136	\$3,452

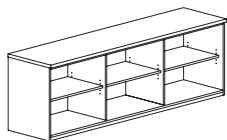

Features:

- eased edge profile user side
- each open compartment has one adjustable shelf
- shelves 12 1/2" d

Options:

- must specify chassis grain direction on double cut veneer, see pages 11-13 for details
- contrasting laminate worksurface tops, no upcharge; specify laminate color, see page 14 for details
- oval grommets in back panel can be eliminated upon request, no upcharge
- interior horizontal wire manager with end grommets available, specify and add \$180 list; see page 38 for details
- top grommet available, specify location and add \$128 list each; see page 45 for details
- worksurface power available, specify "to accommodate EC26" on your purchase order; EC26 unit must be ordered separately, see page 45

Open Compartment Credenza	22	72	29	245	32	FLT2272-29F00	\$1,945		
	22	72	29	245	32	FLV2272-29F00		\$2,861	\$3,146
	22	60	29	210	27	FLT2260-29F00	\$1,836		
	22	60	29	210	27	FLV2260-29F00		\$2,696	\$2,967

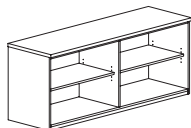

Features:

- eased edge profile user side
- each open compartment has one adjustable shelf
- shelves 12 1/2" d

Options:

- must specify chassis grain direction on double cut veneer, see pages 11-13 for details
- contrasting laminate worksurface tops, no upcharge; specify laminate color, see page 14 for details
- oval grommets in back panel can be eliminated upon request, no upcharge
- interior horizontal wire manager with end grommets available, specify and add \$180 list; see page 38 for details
- top grommet available, specify location and add \$128 list each; see page 45 for details
- worksurface power available, specify "to accommodate EC26" on your purchase order; EC26 unit must be ordered separately, see page 45

Description	D	W	H	CTN WT	CU FT	① Model	HPL Laminate	Flat Cut Veneer	Double Cut Veneer
Open Compartment	22	36	29	131	17	FLT2236-29F0	\$1,243		
	22	36	29	131	17	FLV2236-29F0		\$1,824	\$2,005
	22	30	29	113	14	FLT2230-29F0	\$1,194		
	22	30	29	113	14	FLV2230-29F0		\$1,755	\$1,931

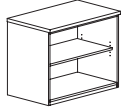

Features:

- eased edge profile user side
- open compartment with adjustable shelf
- shelf 12 1/2" d

Options:

- must specify chassis grain direction on double cut veneer, see pages 11-13 for details
- contrasting laminate worksurface tops, no upcharge; specify laminate color, see page 14 for details
- oval grommet in back panel can be eliminated upon request, no upcharge
- top grommet available, specify location; add \$128 list each; see page 45 for details
- worksurface power available, specify "to accommodate EC26" on your purchase order; EC26 unit must be ordered separately, see page 45

To Order, Specify:

① Laminate Model #	② Laminate Type	③ Laminate Selection	④ Metal Color	⑤ Other Product Options
Laminate (FLT)	HPL	See Laminate Selection	See Metal Finish Color Options	See list of options for each specific unit; Specify and add accordingly.

① Veneer Model #	② Wood Species	③ Wood Finish	④ Metal Color	⑤ Other Product Options	
Veneer (FLV)	Flat Cut CH1 Cherry MA1 Maple WA1 Walnut BO1 Black Oak	See Flat Cut Wood Finish Options	See Metal Finish Color Options	See list of options for each specific unit; Specify and add accordingly.	
	Double Cut DC1 Double Cut	<table border="1"> <thead> <tr> <th>ⓐ Wood Finish</th> <th>ⓑ Chassis Grain Direction</th> </tr> </thead> <tbody> <tr> <td>See Double Cut Wood Finish Options</td> <td>For Double Cut Only: Vertical Horizontal</td> </tr> </tbody> </table>			ⓐ Wood Finish
ⓐ Wood Finish	ⓑ Chassis Grain Direction				
See Double Cut Wood Finish Options	For Double Cut Only: Vertical Horizontal				

Description	D	W	H	CTN WT	CU FT	① Model	HPL Laminate	Flat Cut Veneer	Double Cut Veneer
Split Top Lateral File	22	96	29	336	43	FLT2296-29F4K4ST	\$3,560		
Kneespace Credenza	22	96	29	336	43	FLV2296-29F4K4ST		\$4,859	\$5,345
	22	90	29	328	40	FLT2290-29F4K4ST	\$3,479		
	22	90	29	328	40	FLV2290-29F4K4ST		\$4,746	\$5,225

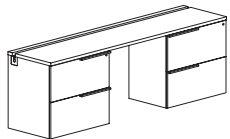

Features:

- eased edge profile user side
- built in horizontal wire channel
- 5”h back apron rail standard in kneespace
- pedestal front locking

Options:

- must specify chassis grain direction on double cut veneer, see pages 11-13 for details
- fixed half or full modesty panel available, specify style; add \$161 list for laminate panel or \$201 list for veneer panel, see page 23 for details
- removable modesty panel available, specify; add \$245 list for laminate or \$324 for veneer panel, see page 23 for details
- veneer drawer fronts in paint available, specify paint color and add \$337 list; see page 14 for details
- on laminate units, contrasting worksurface tops and drawer fronts available, no upcharge; specify color, see page 14 for details
- ledge pulls standard; prism pulls available, specify and see page 9

modesty panel options:

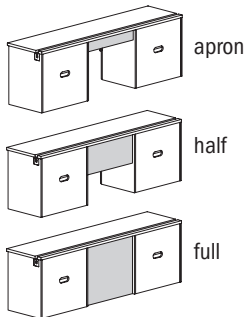

Description	D	W	H	CTN WT	CU FT	① Model	HPL Laminate	Flat Cut Veneer	Double Cut Veneer
Lateral File Kneespace Credenza	22	96	29	343	43	FLT2296-29F4K4	\$3,284		
	22	96	29	343	43	FLV2296-29F4K4		\$4,584	\$5,042
	22	90	29	235	40	FLT2290-29F4K4	\$3,204		
	22	90	29	235	40	FLV2290-29F4K4		\$4,473	\$4,920

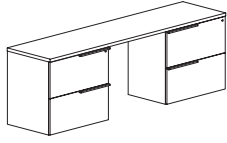

modesty panel options:

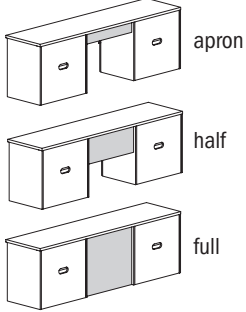

Features:

- eased edge profile user side
- 5”h back apron rail standard in kneespace
- pedestal front locking



Options:

- must specify chassis grain direction on double cut veneer, see pages 11-13 for details
- fixed half or full modesty panel available, specify style; add \$161 list for laminate panel or \$201 list for veneer panel, see page 23 for details
- removable modesty panel available, specify; add \$245 list for laminate or \$324 for veneer panel, see page 23 for details
- veneer drawer fronts in paint available, specify paint color and add \$337 list; see page 14 for details
- on laminate units, contrasting worksurface tops and drawer fronts available, no upcharge; specify color, see page 14 for details
- ledge pulls standard; prism pulls available, specify and see page 9
- interior horizontal wire manager with end grommets available, specify and add \$180 list; see page 38 for details
- top grommet available, specify location; add \$128 list each; see page 45 for details
- worksurface power available, specify “to accommodate EC26” on your purchase order; EC26 unit must be ordered separately, see page 45

To Order, Specify:

① Laminate Model #	② Laminate Type	③ Laminate Selection	④ Metal Color	⑤ Other Product Options
Laminate (FLT)	HPL	See Laminate Selection	See Metal Finish Color Options	See list of options for each specific unit; Specify and add accordingly.

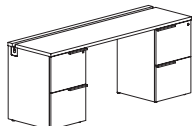
① Veneer Model #	② Wood Species	③ Wood Finish	④ Metal Color	⑤ Other Product Options	
Veneer (FLV)	Flat Cut CH1 Cherry MA1 Maple WA1 Walnut BO1 Black Oak	See Flat Cut Wood Finish Options	See Metal Finish Color Options	See list of options for each specific unit; Specify and add accordingly.	
	Double Cut DC1 Double Cut	<table border="1"> <thead> <tr> <th>③a Wood Finish</th> <th>③b Chassis Grain Direction</th> </tr> </thead> <tbody> <tr> <td>See Double Cut Wood Finish Options</td> <td>For Double Cut Only: Vertical Horizontal</td> </tr> </tbody> </table>			③a Wood Finish
③a Wood Finish	③b Chassis Grain Direction				
See Double Cut Wood Finish Options	For Double Cut Only: Vertical Horizontal				

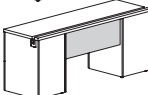
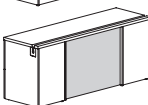
Description	D	W	H	CTN WT	CU FT	① Model	HPL Laminate	Fiat Cut Veneer	Double Cut Veneer
Split Top File/File	22	84	29	261	38	FLT2284-29F2K2ST	\$3,077		
Kneespace Credenza	22	84	29	261	38	FLV2284-29F2K2ST		\$4,185	\$4,603
	22	78	29	253	35	FLT2278-29F2K2ST	\$3,008		
	22	78	29	253	35	FLV2278-29F2K2ST		\$4,089	\$4,499
	22	72	29	245	32	FLT2272-29F2K2ST	\$2,941		
	22	72	29	245	32	FLV2272-29F2K2ST		\$3,997	\$4,396
	22	66	29	227	30	FLT2266-29F2K2ST	\$2,874		
modesty panel options:	22	66	29	227	30	FLV2266-29F2K2ST		\$3,904	\$4,294
 apron	22	60	29	219	27	FLT2260-29F2K2ST	\$2,808		
 half	22	60	29	219	27	FLV2260-29F2K2ST		\$3,812	\$4,194
 full									

Features:

- eased edge profile user side
- built in horizontal wire channel
- 5”h back apron rail standard in kneespace
- pedestal front locking

Options:

- must specify chassis grain direction on double cut veneer, see pages 11-13 for details
- fixed half or full modesty panel available, specify style; add \$161 list for laminate panel or \$201 list for veneer panel, see page 23 for details
- removable modesty panel available, specify; add \$245 list for laminate or \$324 for veneer panel, see page 23 for details
- veneer drawer fronts in paint available, specify paint color and add \$337 list; see page 14 for details
- on laminate units, contrasting worksurface tops and drawer fronts available, no upcharge; specify color, see page 14 for details
- ledge pulls standard; prism pulls available, specify and see page 9

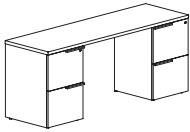
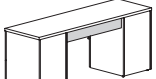
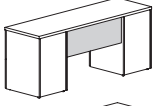
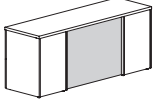
Description	D	W	H	CTN WT	CU FT	① Model	HPL Laminate	Flat Cut Veneer	Double Cut Veneer
 <p>modesty panel options:</p>  apron  half  full	22	84	29	265	38	FLT2284-29F2K2	\$2,801		
	22	84	29	265	38	FLV2284-29F2K2		\$3,910	\$4,299
	22	78	29	257	35	FLT2278-29F2K2	\$2,733		
	22	78	29	257	35	FLV2278-29F2K2		\$3,813	\$4,195
	22	72	29	249	32	FLT2272-29F2K2	\$2,667		
	22	72	29	249	32	FLV2272-29F2K2		\$3,720	\$4,093
	22	66	29	230	30	FLT2266-29F2K2	\$2,601		
	22	66	29	230	30	FLV2266-29F2K2		\$3,629	\$3,992
	22	60	29	222	27	FLT2260-29F2K2	\$2,532		
	22	60	29	222	27	FLV2260-29F2K2		\$3,536	\$3,891

Features:

- eased edge profile user side
- 5”h back apron rail standard in kneespace
- pedestal front locking

Options:

- must specify chassis grain direction on double cut veneer, see pages 11-13 for details
- fixed half or full modesty panel available, specify style; add \$161 list for laminate panel or \$201 list for veneer panel, see page 23 for details
- removable modesty panel available, specify; add \$245 list for laminate or \$324 for veneer panel, see page 23 for details
- veneer drawer fronts in paint available, specify paint color and add \$337 list; see page 14 for details
- on laminate units, contrasting worksurface tops and drawer fronts available, no upcharge; specify color, see page 14 for details
- ledge pulls standard; prism pulls available, specify and see page 9
- interior horizontal wire manager with end grommets available, specify and add \$180 list; see page 38 for details
- top grommet available, specify location; add \$128 list each; see page 45 for details
- worksurface power available, specify “to accommodate EC26” on your purchase order; EC26 unit must be ordered separately, see page 45

To Order, Specify:

① Laminate Model #	② Laminate Type	③ Laminate Selection	④ Metal Color	⑤ Other Product Options
Laminate (FLT)	HPL	See Laminate Selection	See Metal Finish Color Options	See list of options for each specific unit; Specify and add accordingly.

① Veneer Model #	② Wood Species	③ Wood Finish	④ Metal Color	⑤ Other Product Options
Veneer (FLV)	Flat Cut CH1 Cherry MA1 Maple WA1 Walnut BO1 Black Oak	See Flat Cut Wood Finish Options	See Metal Finish Color Options	See list of options for each specific unit; Specify and add accordingly.
		<table border="1"> <thead> <tr> <th>ⓐ Wood Finish</th> <th>ⓑ Chassis Grain Direction</th> </tr> </thead> <tbody> <tr> <td>See Double Cut Wood Finish Options</td> <td>For Double Cut Only: Vertical Horizontal</td> </tr> </tbody> </table>		
ⓐ Wood Finish	ⓑ Chassis Grain Direction			
See Double Cut Wood Finish Options	For Double Cut Only: Vertical Horizontal			

Description	D	W	H	CTN WT	CU FT	① Model	HPL Laminate	Flat Cut Veneer	Double Cut Veneer
Lateral File Pedestal Credenza with Continuous Wire Channel - Split Top	22	96	29	269	43	FLT2296-29FK4ST	\$2,716		
	22	96	29	269	43	FLV2296-29FK4ST		\$3,681	\$4,049
	22	96	29	269	43	FLT2296-29F4KST	\$2,716		
	22	96	29	269	43	FLV2296-29F4KST		\$3,681	\$4,049
	22	90	29	261	40	FLT2290-29FK4ST	\$2,642		
	22	90	29	261	40	FLV2290-29FK4ST		\$3,582	\$3,939
	22	90	29	261	40	FLT2290-29F4KST	\$2,642		
	22	90	29	261	40	FLV2290-29F4KST		\$3,582	\$3,939
	22	84	29	254	38	FLT2284-29FK4ST	\$2,571		
	22	84	29	254	38	FLV2284-29FK4ST		\$3,480	\$3,830
	22	84	29	254	38	FLT2284-29F4KST	\$2,571		
	22	84	29	254	38	FLV2284-29F4KST		\$3,480	\$3,830
	22	78	29	246	35	FLT2278-29FK4ST	\$2,503		
	22	78	29	246	35	FLV2278-29FK4ST		\$3,386	\$3,723
	22	78	29	246	35	FLT2278-29F4KST	\$2,503		
	22	78	29	246	35	FLV2278-29F4KST		\$3,386	\$3,723
	22	72	29	238	32	FLT2272-29FK4ST	\$2,436		
	22	72	29	238	32	FLV2272-29FK4ST		\$3,292	\$3,622
22	72	29	238	32	FLT2272-29F4KST	\$2,436			
22	72	29	238	32	FLV2272-29F4KST		\$3,292	\$3,622	

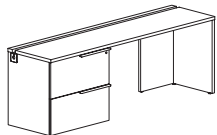

*4KST shown

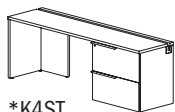

*K4ST

modesty panel options:

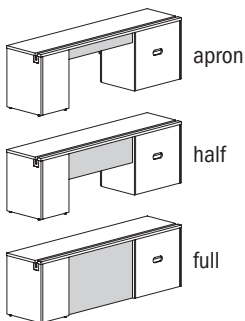

Features:

- eased edge profile user side
- built in horizontal wire channel
- 5”h back apron rail standard in kneespace
- pedestal front locking

Options:

- must specify chassis grain direction on double cut veneer, see pages 11-13 for details
- fixed half or full modesty panel available, specify style; add \$161 list for laminate panel or \$201 list for veneer panel, see page 23 for details
- removable modesty panel available, specify; add \$245 list for laminate or \$324 for veneer panel, see page 23 for details
- veneer drawer fronts in paint available, specify paint color and add \$337 list; see page 14 for details
- on laminate units, contrasting worksurface tops and drawer fronts available, no upcharge; specify color, see page 14 for details
- ledge pulls standard; prism pulls available, specify and see page 9
- knee clearance end panel available 13” depth, specify; no upcharge

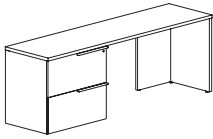
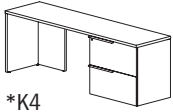
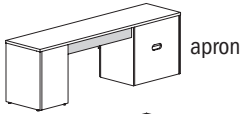
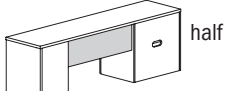
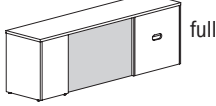
Description	D	W	H	CTN WT	CU FT	① Model	HPL Laminate	Flat Cut Veneer	Double Cut Veneer
 <p>*4K shown</p>  <p>*K4</p> <p>modesty panel options:</p>  <p>apron</p>  <p>half</p>  <p>full</p>	22	96	29	275	43	FLT2296-29FK4	\$2,440		
	22	96	29	275	43	FLV2296-29FK4		\$3,406	\$3,747
	22	96	29	275	43	FLT2296-29F4K	\$2,440		
	22	96	29	275	43	FLV2296-29F4K		\$3,406	\$3,747
	22	90	29	267	40	FLT2290-29FK4	\$2,367		
	22	90	29	267	40	FLV2290-29FK4		\$3,306	\$3,636
	22	90	29	267	40	FLT2290-29F4K	\$2,367		
	22	90	29	267	40	FLV2290-29F4K		\$3,306	\$3,636
	22	84	29	259	38	FLT2284-29FK4	\$2,296		
	22	84	29	259	38	FLV2284-29FK4		\$3,205	\$3,526
	22	84	29	259	38	FLT2284-29F4K	\$2,296		
	22	84	29	259	38	FLV2284-29F4K		\$3,205	\$3,526
	22	78	29	251	35	FLT2278-29FK4	\$2,229		
	22	78	29	251	35	FLV2278-29FK4		\$3,110	\$3,422
	22	78	29	251	35	FLT2278-29F4K	\$2,229		
	22	78	29	251	35	FLV2278-29F4K		\$3,110	\$3,422
	22	72	29	243	32	FLT2272-29FK4	\$2,161		
	22	72	29	243	32	FLV2272-29FK4		\$3,017	\$3,317
22	72	29	243	32	FLT2272-29F4K	\$2,161			
22	72	29	243	32	FLV2272-29F4K		\$3,017	\$3,317	

Features:

- eased edge profile user side
- 5”h back apron rail standard in kneespace
- pedestal front locking

Options:

- must specify chassis grain direction on double cut veneer, see pages 11-13 for details
- fixed half or full modesty panel available, specify style; add \$161 list for laminate panel or \$201 list for veneer panel, see page 23 for details
- removable modesty panel available, specify; add \$245 list for laminate or \$324 for veneer panel, see page 23 for details
- veneer drawer fronts in paint available, specify paint color and add \$337 list; see page 14 for details
- on laminate units, contrasting worksurface tops and drawer fronts available, no upcharge; specify color, see page 14 for details
- ledge pulls standard; prism pulls available, specify and see page 9
- interior horizontal wire manager with end grommets available, specify and add \$180 list; see page 38 for details
- top grommet available, specify location; add \$128 list each; see page 45 for details
- worksurface power available, specify “to accommodate EC26” on your purchase order; EC26 unit must be ordered separately, see page 45
- knee clearance end panel available 13” depth, specify; no upcharge

To Order, Specify:

① Laminate Model #	② Laminate Type	③ Laminate Selection	④ Metal Color	⑤ Other Product Options
Laminate (FLT)	HPL	See Laminate Selection	See Metal Finish Color Options	See list of options for each specific unit; Specify and add accordingly.

① Veneer Model #	② Wood Species	③ Wood Finish	④ Metal Color	⑤ Other Product Options
Veneer (FLV)	Flat Cut CH1 Cherry MA1 Maple WA1 Walnut BO1 Black Oak	See Flat Cut Wood Finish Options	See Metal Finish Color Options	See list of options for each specific unit; Specify and add accordingly.
		<table border="1"> <thead> <tr> <th>ⓐ Wood Finish</th> <th>ⓑ Chassis Grain Direction</th> </tr> </thead> <tbody> <tr> <td>See Double Cut Wood Finish Options</td> <td>For Double Cut Only: Vertical Horizontal</td> </tr> </tbody> </table>		
ⓐ Wood Finish	ⓑ Chassis Grain Direction			
See Double Cut Wood Finish Options	For Double Cut Only: Vertical Horizontal			

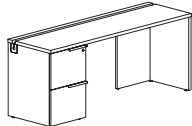
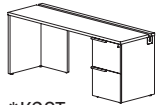
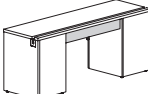
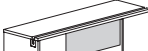
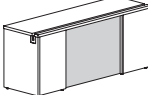
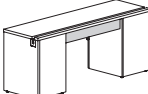
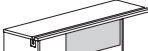
Description	D	W	H	CTN WT	CU FT	① Model	HPL Laminate	Flat Cut Veneer	Double Cut Veneer
File/File Pedestal Credenza with Continuous Wire Channel - Split Top	22	84	29	224	38	FLT2284-29FK2ST	\$2,427		
	22	84	29	224	38	FLV2284-29FK2ST		\$3,278	\$3,606
 *2KST shown	22	84	29	224	38	FLT2284-29F2KST	\$2,427		
	22	84	29	224	38	FLV2284-29F2KST		\$3,278	\$3,606
 *K2ST	22	78	29	216	35	FLT2278-29FK2ST	\$2,362		
	22	78	29	216	35	FLV2278-29FK2ST		\$3,190	\$3,509
modesty panel options:	22	78	29	216	35	FLT2278-29F2KST	\$2,362		
	22	78	29	216	35	FLV2278-29F2KST		\$3,190	\$3,509
 apron	22	72	29	208	32	FLT2272-29FK2ST	\$2,301		
	22	72	29	208	32	FLV2272-29FK2ST		\$3,099	\$3,412
 half	22	72	29	208	32	FLT2272-29F2KST	\$2,301		
	22	72	29	208	32	FLV2272-29F2KST		\$3,099	\$3,412
 full	22	66	29	193	30	FLT2266-29FK2ST	\$2,239		
	22	66	29	193	30	FLV2266-29FK2ST		\$3,017	\$3,317
modesty panel options:	22	66	29	193	30	FLT2266-29F2KST	\$2,239		
	22	66	29	193	30	FLV2266-29F2KST		\$3,017	\$3,317
 apron	22	60	29	185	27	FLT2260-29FK2ST	\$2,180		
	22	60	29	185	27	FLV2260-29FK2ST		\$2,935	\$3,227
 half	22	60	29	185	27	FLT2260-29F2KST	\$2,180		
	22	60	29	185	27	FLV2260-29F2KST		\$2,935	\$3,227

Features:

- eased edge profile user side
- built in horizontal wire channel
- 5”h back apron rail standard in kneespace
- pedestal front locking

Options:

- must specify chassis grain direction on double cut veneer, see pages 11-13 for details
- fixed half or full modesty panel available, specify style; add \$161 list for laminate panel or \$201 list for veneer panel, see page 23 for details
- removable modesty panel available, specify; add \$245 list for laminate or \$324 for veneer panel, see page 23 for details
- veneer drawer fronts in paint available, specify paint color and add \$337 list; see page 14 for details
- on laminate units, contrasting worksurface tops and drawer fronts available, no upcharge; specify color, see page 14 for details
- ledge pulls standard; prism pulls available, specify and see page 9
- knee clearance end panel available 13” depth, specify; no upcharge

FLUX - PRIVATE OFFICE

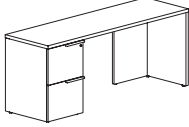
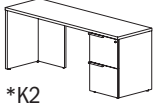
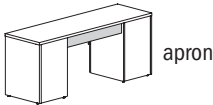
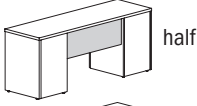
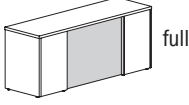
Description	D	W	H	CTN WT	CU FT	① Model	HPL Laminate	Flat Cut Veneer	Double Cut Veneer
 <p>*2K shown</p>  <p>*K2</p> <p>modesty panel options:</p>  <p>apron</p>  <p>half</p>  <p>full</p>	22	84	29	228	38	FLT2284-29FK2	\$2,150		
	22	84	29	228	38	FLV2284-29FK2		\$3,005	\$3,305
	22	84	29	228	38	FLT2284-29F2K	\$2,150		
	22	84	29	228	38	FLV2284-29F2K		\$3,005	\$3,305
	22	78	29	220	35	FLT2278-29FK2	\$2,086		
	22	78	29	220	35	FLV2278-29FK2		\$2,913	\$3,205
	22	78	29	220	35	FLT2278-29F2K	\$2,086		
	22	78	29	220	35	FLV2278-29F2K		\$2,913	\$3,205
	22	72	29	212	32	FLT2272-29FK2	\$2,025		
	22	72	29	212	32	FLV2272-29FK2		\$2,826	\$3,109
	22	72	29	212	32	FLT2272-29F2K	\$2,025		
	22	72	29	212	32	FLV2272-29F2K		\$2,826	\$3,109
	22	66	29	200	30	FLT2266-29FK2	\$1,962		
	22	66	29	200	30	FLV2266-29FK2		\$2,743	\$3,016
	22	66	29	200	30	FLT2266-29F2K	\$1,962		
	22	66	29	200	30	FLV2266-29F2K		\$2,743	\$3,016
	22	60	29	192	27	FLT2260-29FK2	\$1,906		
	22	60	29	192	27	FLV2260-29FK2		\$2,657	\$2,927
22	60	29	192	27	FLT2260-29F2K	\$1,906			
22	60	29	192	27	FLV2260-29F2K		\$2,657	\$2,927	

Features:

- eased edge profile user side
- 5”h back apron rail standard in kneespace
- pedestal front locking

Options:

- must specify chassis grain direction on double cut veneer, see pages 11-13 for details
- fixed half or full modesty panel available, specify style; add \$161 list for laminate panel or \$201 list for veneer panel, see page 23 for details
- removable modesty panel available, specify; add \$245 list for laminate or \$324 for veneer panel, see page 23 for details
- veneer drawer fronts in paint available, specify paint color and add \$337 list; see page 14 for details
- on laminate units, contrasting worksurface tops and drawer fronts available, no upcharge; specify color, see page 14 for details
- ledge pulls standard; prism pulls available, specify and see page 9
- interior horizontal wire manager with end grommets available, specify and add \$180 list; see page 38 for details
- top grommet available, specify location; add \$128 list each; see page 45 for details
- worksurface power available, specify “to accommodate EC26” on your purchase order; EC26 unit must be ordered separately, see page 45
- knee clearance end panel available 13” depth, specify; no upcharge

To Order, Specify:

① Laminate Model #	② Laminate Type	③ Laminate Selection	④ Metal Color	⑤ Other Product Options
Laminate (FLT)	HPL	See Laminate Selection	See Metal Finish Color Options	See list of options for each specific unit; Specify and add accordingly.

① Veneer Model #	② Wood Species	③ Wood Finish	④ Metal Color	⑤ Other Product Options
Veneer (FLV)	Flat Cut CH1 Cherry MA1 Maple WA1 Walnut BO1 Black Oak	See Flat Cut Wood Finish Options	See Metal Finish Color Options	See list of options for each specific unit; Specify and add accordingly.
		<table border="1"> <thead> <tr> <th>ⓐ Wood Finish</th> <th>ⓑ Chassis Grain Direction</th> </tr> </thead> <tbody> <tr> <td>See Double Cut Wood Finish Options</td> <td>For Double Cut Only: Vertical Horizontal</td> </tr> </tbody> </table>		
ⓐ Wood Finish	ⓑ Chassis Grain Direction			
See Double Cut Wood Finish Options	For Double Cut Only: Vertical Horizontal			

Description	D	W	H	CTN WT	CU FT	① Model	HPL Laminate	Flat Cut Veneer	Double Cut Veneer
	22	72	29	151	32	FLT2272-29FK	\$1,370		
	22	72	29	151	32	FLV2272-29FK		\$2,073	\$2,280
	22	66	29	142	30	FLT2266-29FK	\$1,329		
	22	66	29	142	30	FLV2266-29FK		\$2,013	\$2,213

Features:

- freestanding shell, modular pedestal units below and on the following two pages may be ordered: see page 37 for details
- eased edge profile user side

Options:

- must specify chassis grain direction on double cut veneer, see pages 11-13 for details
- top grommet available, specify location and add \$128 list each; see page 46 for details

	20 ¹⁵ / ₁₆	18	28	74	9	FLT2118-CSM2	\$1,117		
	20 ¹⁵ / ₁₆	18	28	74	9	FLV2118-CSM2		\$1,675	\$1,845
	20 ¹⁵ / ₁₆	15 ⁵ / ₈	28	74	9	FLT2116-CSM2	\$1,104		
	20 ¹⁵ / ₁₆	15 ⁵ / ₈	28	74	9	FLV2116-CSM2		\$1,658	\$1,823

Features:

- use inside of credenza shells or return shells, see page 37
- pedestal front locking

Options:

- must specify chassis grain direction on double cut veneer, see pages 11-13 for details
- veneer drawer fronts in paint available, specify paint color and add \$337 list; see page 14 for details
- on laminate units, contrasting fronts available, no upcharge; specify color, see page 14 for details
- ledge pulls standard; prism pulls available, specify and see page 9

	20 ¹⁵ / ₁₆	18	28	87	9	FLT2118-CSM1	\$1,122		
	20 ¹⁵ / ₁₆	18	28	87	9	FLV2118-CSM1		\$1,685	\$1,854
	20 ¹⁵ / ₁₆	15 ⁵ / ₈	28	80	8	FLT2116-CSM1	\$1,109		
	20 ¹⁵ / ₁₆	15 ⁵ / ₈	28	80	8	FLV2116-CSM1		\$1,665	\$1,830

Features:

- use inside of credenza shells or return shells, see page 37
- pedestal front locking

Options:

- must specify chassis grain direction on double cut veneer, see pages 11-13 for details
- veneer drawer fronts in paint available, specify paint color and add \$337 list; see page 14 for details
- on laminate units, contrasting fronts available, no upcharge; specify color, see page 14 for details
- ledge pulls standard; prism pulls available, specify and see page 9

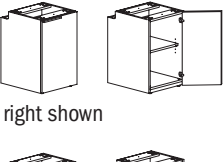
 <p>right shown</p> <p>left</p>	20 ¹⁵ / ₁₆	18	28	68	8	FLT2118-CSM7R	\$690		
	20 ¹⁵ / ₁₆	18	28	68	8	FLV2118-CSM7R		\$1,038	\$1,141
	20 ¹⁵ / ₁₆	18	28	68	8	FLT2118-CSM7L	\$690		
	20 ¹⁵ / ₁₆	18	28	68	8	FLV2118-CSM7L		\$1,038	\$1,141
	20 ¹⁵ / ₁₆	15 ⁵ / ₈	28	141	16	FLT2116-CSM7R	\$679		
	20 ¹⁵ / ₁₆	15 ⁵ / ₈	28	141	16	FLV2116-CSM7R		\$1,018	\$1,120
	20 ¹⁵ / ₁₆	15 ⁵ / ₈	28	129	14	FLT2116-CSM7L	\$679		
	20 ¹⁵ / ₁₆	15 ⁵ / ₈	28	129	14	FLV2116-CSM7L		\$1,018	\$1,120

Features:

- use inside of credenza shells or return shells, see page 37

Options:

- hinged door compartment has one adjustable shelf
- must specify chassis grain direction on double cut veneer, see pages 11-13 for details
- locking door available, specify and add \$142 list
- veneer door fronts in paint available, specify paint color and add \$337 list; see page 14 for details
- on laminate units, contrasting fronts available, no upcharge; specify color, see page 14 for details
- ledge pulls standard; prism pulls available, specify and see page 9

Description	D	W	H	CTN WT	CU FT	① Model	HPL Laminate	Flat Cut Veneer	Double Cut Veneer
Modular Lateral Credenza	20 ¹⁵ / ₁₆	36	28	141	16	FLT2136-CSM4	\$1,358		
Shell Pedestal	20 ¹⁵ / ₁₆	36	28	141	16	FLV2136-CSM4		\$2,036	\$2,240
	20 ¹⁵ / ₁₆	30	28	128	14	FLT2130-CSM4	\$1,323		
	20 ¹⁵ / ₁₆	30	28	128	14	FLV2130-CSM4		\$1,985	\$2,186



Features:

- use inside of credenza shells or return shells, see page 37
- pedestal front locking

Options:

- must specify chassis grain direction on double cut veneer, see pages 11-13 for details
- veneer drawer fronts in paint available, specify paint color and add \$337 list; see page 14 for details
- on laminate units, contrasting fronts available, no upcharge; specify color, see page 14 for details
- ledge pulls standard; prism pulls available, specify and see page 9

Description	D	W	H	CTN WT	CU FT	① Model	HPL Laminate	Flat Cut Veneer	Double Cut Veneer
Modular Lateral Credenza	20 ¹⁵ / ₁₆	36	28	141	16	FLT2136-CSM3	\$1,364		
Shell Pedestal	20 ¹⁵ / ₁₆	36	28	141	16	FLV2136-CSM3		\$2,047	\$2,252
	20 ¹⁵ / ₁₆	30	28	128	14	FLT2130-CSM3	\$1,329		
	20 ¹⁵ / ₁₆	30	28	128	14	FLV2130-CSM3		\$1,996	\$2,197



Features:

- use inside of credenza shells or return shells, see page 37
- pedestal front locking

Options:

- must specify chassis grain direction on double cut veneer, see pages 11-13 for details
- veneer drawer fronts in paint available, specify paint color and add \$337 list; see page 14 for details
- on laminate units, contrasting fronts available, no upcharge; specify color, see page 14 for details
- ledge pulls standard; prism pulls available, specify and see page 9

FLUX - PRIVATE OFFICE

To Order, Specify:

① Laminate Model #	② Laminate Type	③ Laminate Selection	④ Metal Color	⑤ Other Product Options
Laminate (FLT)	HPL	See Laminate Selection	See Metal Finish Color Options	See list of options for each specific unit; Specify and add accordingly.

① Veneer Model #	② Wood Species	③ Wood Finish	④ Metal Color	⑤ Other Product Options	
Veneer (FLV)	Flat Cut CH1 Cherry MA1 Maple WA1 Walnut BO1 Black Oak	See Flat Cut Wood Finish Options	See Metal Finish Color Options	See list of options for each specific unit; Specify and add accordingly.	
	Double Cut DC1 Double Cut	<table border="1"> <thead> <tr> <th>ⓐ Wood Finish</th> <th>ⓑ Chassis Grain Direction</th> </tr> </thead> <tbody> <tr> <td>See Double Cut Wood Finish Options</td> <td>For Double Cut Only: Vertical Horizontal</td> </tr> </tbody> </table>			ⓐ Wood Finish
ⓐ Wood Finish	ⓑ Chassis Grain Direction				
See Double Cut Wood Finish Options	For Double Cut Only: Vertical Horizontal				

Description	D	W	H	CTN WT	CU FT	① Model	HPL Laminate	Flat Cut Veneer	Double Cut Veneer
Modular Credenza Shell	20 15/16	30	28	138	14	FLT2130-CSMRM	\$1,438		
Multi-File Pedestal	20 15/16	30	28	138	14	FLV2130-CSMRM		\$2,160	\$2,376
	20 15/16	30	28	138	14	FLT2130-CSMLM	\$1,438		
	20 15/16	30	28	138	14	FLV2130-CSMLM		\$2,160	\$2,376



right shown



left

Features:

- use inside of credenza shells or return shells, see page 37
- pedestal front locking

Options:

- must specify chassis grain direction on double cut veneer, see pages 11-13 for details
- veneer drawer fronts in paint available, specify paint color and add \$337 list; see page 14 for details
- on laminate units, contrasting fronts available, no upcharge; specify color, see page 14 for details
- ledge pulls standard; prism pulls available, specify and see page 9

Modular Hinge Door Credenza Shell Pedestal	20 15/16	36	28	122	16	FLT2136-CSM7	\$1,151		
	20 15/16	36	28	122	16	FLV2136-CSM7		\$1,728	\$1,898
	20 15/16	30	28	108	14	FLT2130-CSM7	\$1,104		
	20 15/16	30	28	108	14	FLV2130-CSM7		\$1,659	\$1,824

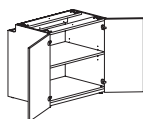

Features:

- use inside of credenza shells or return shells, see page 37
- hinged door compartment has one adjustable shelf

Options:

- must specify chassis grain direction on double cut veneer, see pages 11-13 for details
- locking doors available, specify and add \$142 list
- veneer door fronts in paint available, specify paint color and add \$337 list; see page 14 for details
- on laminate units, contrasting laminate door fronts available, no upcharge; specify laminate color, see page 14 for details
- ledge pulls standard; prism pulls available, specify and see page 9

Modular Hinge Door Credenza Shell Pedestal	20 15/16	36	28	132	16	FLT2136-CSM8	\$1,168		
	20 15/16	36	28	132	16	FLV2136-CSM8		\$1,753	\$1,930
	20 15/16	30	28	116	14	FLT2130-CSM8	\$1,123		
	20 15/16	30	28	116	14	FLV2130-CSM8		\$1,688	\$1,856

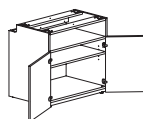

Features:

- use inside of credenza shells or return shells, see page 37
- hinged door compartment has one adjustable shelf

Options:

- must specify chassis grain direction on double cut veneer, see pages 11-13 for details
- locking doors available, specify and add \$142 list
- veneer door fronts in paint available, specify paint color and add \$337 list; see page 14 for details
- on laminate units, contrasting laminate door fronts available, no upcharge; specify laminate color, see page 14 for details
- ledge pulls standard; prism pulls available, specify and see page 9

Modular Open Credenza Shell Compartment	20 15/16	36	28	101	16	FLT2136-CSMO	\$1,019		
	20 15/16	36	28	101	16	FLV2136-CSMO		\$1,530	\$1,684
	20 15/16	30	28	91	14	FLT2130-CSMO	\$995		
	20 15/16	30	28	91	14	FLV2130-CSMO		\$1,493	\$1,642



Features:

- use inside of credenza shells or return shells, see page 37
- compartment has one adjustable shelf

Options:

- must specify chassis grain direction on double cut veneer, see pages 11-13 for details

Description	D	W	H	CTN WT	CU FT	① Model	HPL Laminate	Flat Cut Veneer	Double Cut Veneer
Mobile Pedestal	18	15 1/2	25	91	6	FLT1816-25FMP	\$1,348		
	18	15 1/2	25	91	6	FLV1816-25FMP		\$1,807	\$1,986



Features:

- box, box file only; letter width pedestal
- pedestal front locking
- no additional top needed
- dual wheel casters

Options:

- must specify chassis grain direction on double cut veneer, see pages 11-13 for details
- ledge pulls standard; prism pulls available, specify and see page 9

Box/File Mobile Pedestal	18	15 3/8	21	67	5	FLT1816-21FMP	\$1,213		
	18	15 3/8	21	67	5	FLV1816-21FMP		\$1,691	\$1,859



Features:

- dual wheel casters
- pedestal front locking

Options:

- must specify chassis grain direction on double cut veneer, see pages 11-13 for details
- veneer drawer fronts in paint available, specify paint color and add \$337 list; see page 14 for details
- on laminate units, contrasting fronts available, no upcharge; specify color, see page 14 for details
- ledge pulls standard; prism pulls available, specify and see page 9
- round or square seat cushion available, see page 17 for more details and page 213 for pricing

Mobile Pedestal - Top Storage	12 3/4	15 3/8	22	65	7	FLT1816-21FMPT	\$1,330		
	12 3/4	15 3/8	22	65	7	FLV1816-21FMPT		\$1,819	\$2,000



Features:

- pedestal front locking

Options:

- must specify chassis grain direction on double cut veneer, see pages 11-13 for details
- veneer drawer front available in contrasting paint color, specify paint color and add \$337 list
- laminate drawer fronts available in contrasting color, no upcharge, specify color; see pages 14 for details

To Order, Specify:

① Laminate Model #	② Laminate Type	③ Laminate Selection	④ Metal Color	⑤ Other Product Options
Laminate (FLT)	HPL	See Laminate Selection	See Metal Finish Color Options	See list of options for each specific unit; Specify and add accordingly.

① Veneer Model #	② Wood Species	③ Wood Finish	④ Metal Color	⑤ Other Product Options	
Veneer (FLV)	Flat Cut CH1 Cherry MA1 Maple WA1 Walnut BO1 Black Oak	See Flat Cut Wood Finish Options	See Metal Finish Color Options	See list of options for each specific unit; Specify and add accordingly.	
	Double Cut DC1 Double Cut	<table border="1"> <thead> <tr> <th>ⓐ Wood Finish</th> <th>ⓑ Chassis Grain Direction</th> </tr> </thead> <tbody> <tr> <td>See Double Cut Wood Finish Options</td> <td>For Double Cut Only: Vertical Horizontal</td> </tr> </tbody> </table>			ⓐ Wood Finish
ⓐ Wood Finish	ⓑ Chassis Grain Direction				
See Double Cut Wood Finish Options	For Double Cut Only: Vertical Horizontal				

Description	D	W	H	CTN WT	CU FT	① Model	HPL Laminate	Flat Cut Veneer	Double Cut Veneer
Split Top Box/File Kneespace	22	96	29	314	43	FLT2296-29L6K6ST	\$3,898		
Credenza - Flush Legs	22	96	29	314	43	FLV2296-29L6K6ST		\$4,979	\$5,476
	22	90	29	307	40	FLT2290-29L6K6ST	\$3,792		
	22	90	29	307	40	FLV2290-29L6K6ST		\$4,841	\$5,325

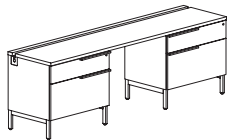

modesty panel options:

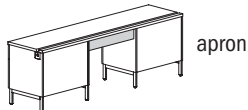

apron

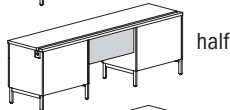

half

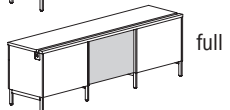

full

Features:

- eased edge profile user side
- built in horizontal wire channel
- 5”h back apron rail standard in kneespace
- pedestal front locking

Options:

- must specify chassis grain direction on double cut veneer, see pages 11-13 for details
- concealed box drawer(s) available, specify location in unit; add \$234 list for each laminate drawer or \$357 for each veneer drawer, see page 23 for details
- fixed half or full modesty panel available, specify style; add \$161 list for laminate panel or \$201 list for veneer panel, see page 23 for details
- veneer drawer fronts in paint available, specify paint color and add \$337 list; see page 14 for details
- on laminate units, contrasting worksurface tops and drawer fronts available, no upcharge; specify color, see page 14 for details
- ledge pulls standard; prism pulls available, specify and see page 9

Description	D	W	H	CTN WT	CU FT	① Model	HPL Laminate	Flat Cut Veneer	Double Cut Veneer
Box/File Kneespace Credenza - Flush Legs	22	96	29	320	43	FLT2296-29L6K6	\$3,623		
	22	96	29	320	43	FLV2296-29L6K6		\$4,703	\$5,174
	22	90	29	320	40	FLT2290-29L6K6	\$3,518		
	22	90	29	320	40	FLV2290-29L6K6		\$4,567	\$5,024

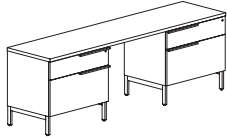

modesty panel options:

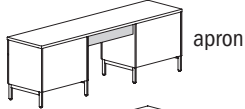

apron

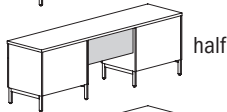

half

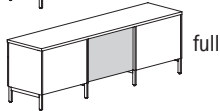

full

Features:

- eased edge profile user side
- 5”h back apron rail standard in kneespace
- pedestal front locking

Options:

- must specify chassis grain direction on double cut veneer, see pages 11-13 for details
- concealed box drawer(s) available, specify location in unit; add \$234 list for each laminate drawer or \$357 for each veneer drawer, see page 23 for details
- fixed half or full modesty panel available, specify style; add \$161 list for laminate panel or \$201 list for veneer panel, see page 23 for details
- veneer drawer fronts in paint available, specify paint color and add \$337 list; see page 14 for details
- on laminate units, contrasting worksurface tops and drawer fronts available, no upcharge; specify color, see page 14 for details
- ledge pulls standard; prism pulls available, specify and see page 9
- interior horizontal wire manager with end grommets available, specify and add \$180 list; see page 38 for details
- top grommet available, specify location; add \$128 list each; see page 45 for details
- worksurface power available, specify “to accommodate EC26” on your purchase order; EC26 unit must be ordered separately, see page 45

To Order, Specify:

① Laminate Model #	② Laminate Type	③ Laminate Selection	④ Metal Color	⑤ Other Product Options
Laminate (FLT)	HPL	See Laminate Selection	See Metal Finish Color Options	See list of options for each specific unit; Specify and add accordingly.

① Veneer Model #	② Wood Species	③ Wood Finish	④ Metal Color	⑤ Other Product Options	
Veneer (FLV)	Flat Cut CH1 Cherry MA1 Maple WA1 Walnut BO1 Black Oak	See Flat Cut Wood Finish Options	See Metal Finish Color Options	See list of options for each specific unit; Specify and add accordingly.	
	Double Cut DC1 Double Cut	<table border="1"> <thead> <tr> <th>③a Wood Finish</th> <th>③b Chassis Grain Direction</th> </tr> </thead> <tbody> <tr> <td>See Double Cut Wood Finish Options</td> <td>For Double Cut Only: Vertical Horizontal</td> </tr> </tbody> </table>			③a Wood Finish
③a Wood Finish	③b Chassis Grain Direction				
See Double Cut Wood Finish Options	For Double Cut Only: Vertical Horizontal				

Description	D	W	H	CTN WT	CU FT	① Model	HPL Laminate	Fiat Cut Veneer	Double Cut Veneer
Split Top Box/File Kneespace Credenza - Flush Legs	22	84	29	247	38	FLT2284-29L5K5ST	\$3,414		
	22	84	29	247	38	FLV2284-29L5K5ST		\$4,352	\$4,786
	22	78	29	240	35	FLT2278-29L5K5ST	\$3,323		
	22	78	29	240	35	FLV2278-29L5K5ST		\$4,230	\$4,656
	22	72	29	233	32	FLT2272-29L5K5ST	\$3,235		
	22	72	29	233	32	FLV2272-29L5K5ST		\$4,115	\$4,527
	22	66	29	219	30	FLT2266-29L5K5ST	\$3,160		
	22	66	29	219	30	FLV2266-29L5K5ST		\$4,022	\$4,423
	22	60	29	212	27	FLT2260-29L5K5ST	\$3,088		
	22	60	29	212	27	FLV2260-29L5K5ST		\$3,926	\$4,321

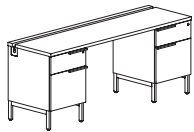

modesty panel options:



apron

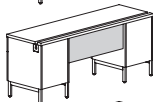

half

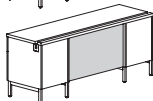

full

Features:

- eased edge profile user side
- built in horizontal wire channel
- 5”h back apron rail standard in kneespace
- pedestal front locking

Options:

- must specify chassis grain direction on double cut veneer, see pages 11-13 for details
- fixed half or full modesty panel available, specify style; add \$161 list for laminate panel or \$201 list for veneer panel, see page 23 for details
- veneer drawer fronts in paint available, specify paint color and add \$337 list; see page 14 for details
- on laminate units, contrasting worksurface tops and drawer fronts available, no upcharge; specify color, see page 14 for details
- ledge pulls standard; prism pulls available, specify and see page 9

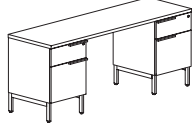
Description	D	W	H	CTN WT	CU FT	① Model	HPL Laminate	Flat Cut Veneer	Double Cut Veneer
	22	84	29	252	38	FLT2284-29L5K5	\$3,138		
	22	84	29	252	38	FLV2284-29L5K5		\$4,075	\$4,483
	22	78	29	245	35	FLT2278-29L5K5	\$3,048		
	22	78	29	245	35	FLV2278-29L5K5		\$3,957	\$4,353
	22	72	29	237	32	FLT2272-29L5K5	\$2,958		
	22	72	29	237	32	FLV2272-29L5K5		\$3,841	\$4,225
	22	66	29	222	30	FLT2266-29L5K5	\$2,884		
	22	66	29	222	30	FLV2266-29L5K5		\$3,746	\$4,120
	22	60	29	215	27	FLT2260-29L5K5	\$2,813		
	22	60	29	215	27	FLV2260-29L5K5		\$3,652	\$4,020

modesty panel options:

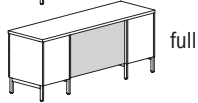
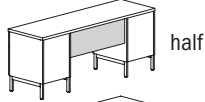
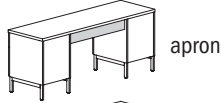

Features:

- eased edge profile user side
- 5”h back apron rail standard in kneespace
- pedestal front locking

Options:

- must specify chassis grain direction on double cut veneer, see pages 11-13 for details
- fixed half or full modesty panel available, specify style; add \$161 list for laminate panel or \$201 list for veneer panel, see page 23 for details
- veneer drawer fronts in paint available, specify paint color and add \$337 list; see page 14 for details
- on laminate units, contrasting worksurface tops and drawer fronts available, no upcharge; specify color, see page 14 for details
- ledge pulls standard; prism pulls available, specify and see page 9
- interior horizontal wire manager with end grommets available, specify and add \$180 list; see page 38 for details
- top grommet available, specify location; add \$128 list each; see page 45 for details
- worksurface power available, specify “to accommodate EC26” on your purchase order; EC26 unit must be ordered separately, see page 45

To Order, Specify:

① Laminate Model #	② Laminate Type	③ Laminate Selection	④ Metal Color	⑤ Other Product Options
Laminate (FLT)	HPL	See Laminate Selection	See Metal Finish Color Options	See list of options for each specific unit; Specify and add accordingly.

① Veneer Model #	② Wood Species	③ Wood Finish	④ Metal Color	⑤ Other Product Options
Veneer (FLV)	Flat Cut CH1 Cherry MA1 Maple WA1 Walnut BO1 Black Oak	See Flat Cut Wood Finish Options	See Metal Finish Color Options	See list of options for each specific unit; Specify and add accordingly.
		<table border="1"> <thead> <tr> <th>③a Wood Finish</th> <th>③b Chassis Grain Direction</th> </tr> </thead> <tbody> <tr> <td>See Double Cut Wood Finish Options</td> <td>For Double Cut Only: Vertical Horizontal</td> </tr> </tbody> </table>		
③a Wood Finish	③b Chassis Grain Direction			
See Double Cut Wood Finish Options	For Double Cut Only: Vertical Horizontal			

Description	D	W	H	CTN WT	CU FT	① Model	HPL Laminate	Flat Cut Veneer	Double Cut Veneer
Split Top Open Corner Lateral Credenza - Flush Legs	22	96	29	251	43	FLT2296-29LK6ST	\$3,004		
	22	96	29	251	43	FLV2296-29LK6ST		\$3,815	\$4,196
	22	96	29	251	43	FLT2296-29L6KST	\$3,004		
	22	96	29	251	43	FLV2296-29L6KST		\$3,815	\$4,196
	22	90	29	244	40	FLT2290-29LK6ST	\$2,936		
	22	90	29	244	40	FLV2290-29LK6ST		\$3,728	\$4,102
	22	90	29	256	40	FLT2290-29L6KST	\$2,936		
	22	90	29	256	40	FLV2290-29L6KST		\$3,728	\$4,102

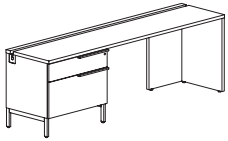

*6KST shown

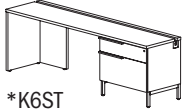

*K6ST

Features:

- eased edge profile user side
- built in horizontal wire channel
- 5”h back apron rail standard in kneespace
- pedestal front locking

Options:

- must specify chassis grain direction on double cut veneer, see pages 11-13 for details
- concealed box drawer available, specify; add \$234 list for each laminate drawer or \$357 for each veneer drawer, see page 23 for details
- fixed half or full modesty panel available, specify style; add \$161 list for laminate panel or \$201 list for veneer panel, see page 23 for details
- veneer drawer fronts in paint available, specify paint color and add \$337 list; see page 14 for details
- on laminate units, contrasting worksurface tops and drawer fronts available, no upcharge; specify color, see page 14 for details
- ledge pulls standard; prism pulls available, specify and see page 9
- knee clearance end panel available 13” depth, specify; no upcharge

modesty panel options:

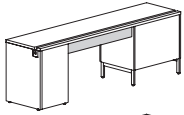

apron

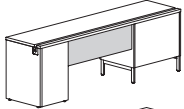

half

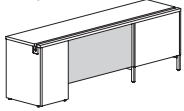

full

FLUX - PRIVATE OFFICE

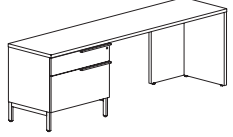
Description	D	W	H	CTN WT	CU FT	① Model	HPL Laminate	Flat Cut Veneer	Double Cut Veneer
Open Corner Lateral Credenza - Flush Legs  *6K shown	22	96	29	256	43	FLT2296-29LK6	\$2,727		
	22	96	29	256	43	FLV2296-29LK6		\$3,540	\$3,893
	22	96	29	256	43	FLT2296-29L6K	\$2,727		
	22	96	29	256	43	FLV2296-29L6K		\$3,540	\$3,893
	22	90	29	249	40	FLT2290-29LK6	\$2,658		
	22	90	29	249	40	FLV2290-29LK6		\$3,454	\$3,800
	22	90	29	249	40	FLT2290-29L6K	\$2,658		
	22	90	29	249	40	FLV2290-29L6K		\$3,454	\$3,800

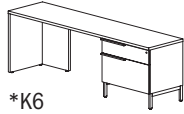

Features:

- eased edge profile user side
- 5" h back apron rail standard in kneespace
- pedestal front locking

Options:

- must specify chassis grain direction on double cut veneer, see pages 11-13 for details
- concealed box drawer available, specify; add \$234 list for each laminate drawer or \$357 for each veneer drawer, see page 23 for details
- fixed half or full modesty panel available, specify style; add \$161 list for laminate panel or \$201 list for veneer panel, see page 23 for details
- veneer drawer fronts in paint available, specify paint color and add \$337 list; see page 14 for details
- on laminate units, contrasting worksurface tops and drawer fronts available, no upcharge; specify color, see page 14 for details
- ledge pulls standard; prism pulls available, specify and see page 9
- interior horizontal wire manager with end grommets available, specify and add \$180 list; see page 38 for details
- top grommet available, specify location; add \$128 list each; see page 45 for details
- worksurface power available, specify "to accommodate EC26" on your purchase order; EC26 unit must be ordered separately, see page 45
- knee clearance end panel available 13" depth, specify; no upcharge

modesty panel options:

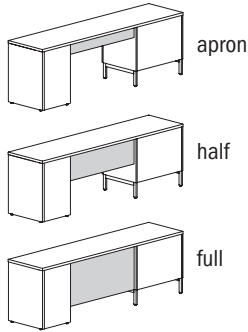

To Order, Specify:

① Laminate Model #	② Laminate Type	③ Laminate Selection	④ Metal Color	⑤ Other Product Options
Laminate (FLT)	HPL	See Laminate Selection	See Metal Finish Color Options	See list of options for each specific unit; Specify and add accordingly.

① Veneer Model #	② Wood Species	③ Wood Finish	④ Metal Color	⑤ Other Product Options	
Veneer (FLV)	Flat Cut CH1 Cherry MA1 Maple WA1 Walnut BO1 Black Oak	See Flat Cut Wood Finish Options	See Metal Finish Color Options	See list of options for each specific unit; Specify and add accordingly.	
	Double Cut DC1 Double Cut	<table border="1"> <thead> <tr> <th>③a Wood Finish</th> <th>③b Chassis Grain Direction</th> </tr> </thead> <tbody> <tr> <td>See Double Cut Wood Finish Options</td> <td>For Double Cut Only: Vertical Horizontal</td> </tr> </tbody> </table>			③a Wood Finish
③a Wood Finish	③b Chassis Grain Direction				
See Double Cut Wood Finish Options	For Double Cut Only: Vertical Horizontal				

Description	D	W	H	CTN WT	CU FT	① Model	HPL Laminate	Fiat Cut Veneer	Double Cut Veneer
Split Top Open Corner Credenza - Flush Legs	22	84	29	211	38	FLT2284-29LK5ST	\$2,921		
	22	84	29	211	38	FLV2284-29LK5ST		\$3,665	\$4,032
	22	84	29	211	38	FLT2284-29L5KST	\$2,921		
	22	84	29	211	38	FLV2284-29L5KST		\$3,665	\$4,032
	22	78	29	218	35	FLT2278-29LK5ST	\$2,868		
	22	78	29	218	35	FLV2278-29LK5ST		\$3,598	\$3,959
	22	78	29	218	35	FLT2278-29L5KST	\$2,868		
	22	78	29	218	35	FLV2278-29L5KST		\$3,598	\$3,959
	22	72	29	177	32	FLT2272-29LK5ST	\$2,818		
	22	72	29	177	32	FLV2272-29LK5ST		\$3,532	\$3,885
	22	72	29	177	32	FLT2272-29L5KST	\$2,818		
	22	72	29	177	32	FLV2272-29L5KST		\$3,532	\$3,885

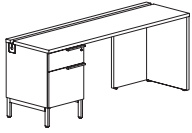

*5KST shown



*K5ST

modesty panel options:



apron

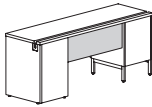

half

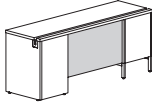

full

Features:

- eased edge profile user side
- built in horizontal wire channel
- 5”h back apron rail standard in kneespace
- pedestal front locking

Options:

- must specify chassis grain direction on double cut veneer, see pages 11-13 for details
- fixed half or full modesty panel available, specify style; add \$161 list for laminate panel or \$201 list for veneer panel, see page 23 for details
- veneer drawer fronts in paint available, specify paint color and add \$337 list; see page 14 for details
- ledge pulls standard; prism pulls available, specify and see page 9
- knee clearance end panel available 13” depth, specify; no upcharge

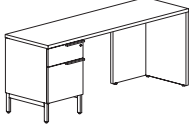
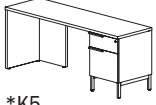
Description	D	W	H	CTN WT	CU FT	① Model	HPL Laminate	Flat Cut Veneer	Double Cut Veneer
 <p>*5K shown</p>  <p>*K5</p>	22	84	29	216	38	FLT2284-29LK5	\$2,646		
	22	84	29	216	38	FLV2284-29LK5		\$3,390	\$3,729
	22	84	29	216	38	FLT2284-29L5K	\$2,646		
	22	84	29	216	38	FLV2284-29L5K		\$3,390	\$3,729
	22	78	29	208	35	FLT2278-29LK5	\$2,592		
	22	78	29	208	35	FLV2278-29LK5		\$3,324	\$3,657
	22	78	29	208	35	FLT2278-29L5K	\$2,592		
	22	78	29	208	35	FLV2278-29L5K		\$3,324	\$3,657
	22	72	29	201	32	FLT2272-29LK5	\$2,541		
	22	72	29	201	32	FLV2272-29LK5		\$3,257	\$3,584
	22	72	29	201	32	FLT2272-29L5K	\$2,541		
	22	72	29	201	32	FLV2272-29L5K		\$3,257	\$3,584

Features:

- eased edge profile user side
- 5”h back apron rail standard in kneespace
- pedestal front locking

Options:

- must specify chassis grain direction on double cut veneer, see pages 11-13 for details
- fixed half or full modesty panel available, specify style; add \$161 list for laminate panel or \$201 list for veneer panel, see page 23 for details
- veneer drawer fronts in paint available, specify paint color and add \$337 list; see page 14 for details
- on laminate units, contrasting worksurface tops and drawer fronts available, no upcharge; specify color, see page 14 for details
- ledge pulls standard; prism pulls available, specify and see page 9
- interior horizontal wire manager with end grommets available, specify and add \$180 list; see page 38 for details
- top grommet available, specify location; add \$128 list each; see page 45 for details
- worksurface power available, specify “to accommodate EC26” on your purchase order; EC26 unit must be ordered separately, see page 45
- knee clearance end panel available 13” depth, specify; no upcharge

modesty panel options:

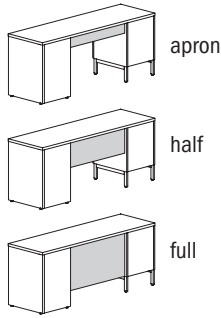

To Order, Specify:

① Laminate Model #	② Laminate Type	③ Laminate Selection	④ Metal Color	⑤ Other Product Options
Laminate (FLT)	HPL	See Laminate Selection	See Metal Finish Color Options	See list of options for each specific unit; Specify and add accordingly.

① Veneer Model #	② Wood Species	③ Wood Finish	④ Metal Color	⑤ Other Product Options
Veneer (FLV)	Flat Cut CH1 Cherry MA1 Maple WA1 Walnut BO1 Black Oak	See Flat Cut Wood Finish Options	See Metal Finish Color Options	See list of options for each specific unit; Specify and add accordingly.
		<table border="1"> <thead> <tr> <th>ⓐ Wood Finish</th> <th>ⓑ Chassis Grain Direction</th> </tr> </thead> <tbody> <tr> <td>See Double Cut Wood Finish Options</td> <td>For Double Cut Only: Vertical Horizontal</td> </tr> </tbody> </table>		
ⓐ Wood Finish	ⓑ Chassis Grain Direction			
See Double Cut Wood Finish Options	For Double Cut Only: Vertical Horizontal			

Description	D	W	H	CTN WT	CU FT	① Model	HPL Laminate	Flat Cut Veneer	Double Cut Veneer
Split Top Open Corner Credenza - Flush Legs	22	66	29	184	30	FLT2266-29LK5ST	\$2,208		
	22	66	29	184	30	FLV2266-29LK5ST		\$2,755	\$3,027
	22	66	29	184	30	FLT2266-29L5KST	\$2,208		
	22	66	29	184	30	FLV2266-29L5KST		\$2,755	\$3,027
	22	60	29	177	27	FLT2260-29LK5ST	\$2,170		
	22	60	29	177	27	FLV2260-29LK5ST		\$2,704	\$2,975
	22	60	29	177	27	FLT2260-29L5KST	\$2,170		
	22	60	29	177	27	FLV2260-29L5KST		\$2,704	\$2,975

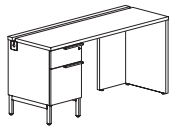

*5KST shown

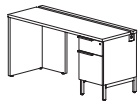

*K5ST

Features:

- eased edge profile user side
- built in horizontal wire channel
- 5”h back apron rail standard in kneespace
- pedestal front locking

Options:

- must specify chassis grain direction on double cut veneer, see pages 11-13 for details
- fixed half or full modesty panel available, specify style; add \$161 list for laminate panel or \$201 list for veneer panel, see page 23 for details
- veneer drawer fronts in paint available, specify paint color and add \$337 list; see page 14 for details
- on laminate units, contrasting worksurface tops and drawer fronts available, no upcharge; specify color, see page 14 for details
- ledge pulls standard; prism pulls available, specify and see page 9
- knee clearance end panel available 13” depth, specify; no upcharge

modesty panel options:

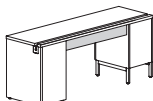

apron

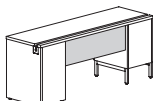

half

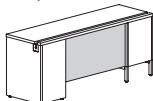

full

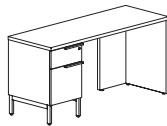
Description	D	W	H	CTN WT	CU FT	① Model	HPL Laminate	Flat Cut Veneer	Double Cut Veneer
 <p>*5K shown</p>	22	66	29	187	30	FLT2266-29LK5	\$1,933		
	22	66	29	187	30	FLV2266-29LK5		\$2,479	\$2,726
	22	66	29	187	30	FLT2266-29L5K	\$1,933		
	22	66	29	187	30	FLV2266-29L5K		\$2,479	\$2,726
	22	60	29	180	27	FLT2260-29LK5	\$1,895		
	22	60	29	180	27	FLV2260-29LK5		\$2,429	\$2,674
	22	60	29	180	27	FLT2260-29L5K	\$1,895		
	22	60	29	180	27	FLV2260-29L5K		\$2,429	\$2,674

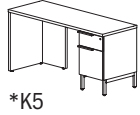

Features:

- eased edge profile user side
- 5”h back apron rail standard in kneespace
- pedestal front locking

Options:

- must specify chassis grain direction on double cut veneer, see pages 11-13 for details
- fixed half or full modesty panel available, specify style; add \$161 list for laminate panel or \$201 list for veneer panel, see page 23 for details
- veneer drawer fronts in paint available, specify paint color and add \$337 list; see page 14 for details
- on laminate units, contrasting worksurface tops and drawer fronts available, no upcharge; specify color, see page 14 for details
- ledge pulls standard; prism pulls available, specify and see page 9
- interior horizontal wire manager with end grommets available, specify and add \$180 list; see page 38 for details
- top grommet available, specify location; add \$128 list each; see page 45 for details
- worksurface power available, specify “to accommodate EC26” on your purchase order; EC26 unit must be ordered separately, see page 45
- knee clearance end panel available 13” depth, specify; no upcharge



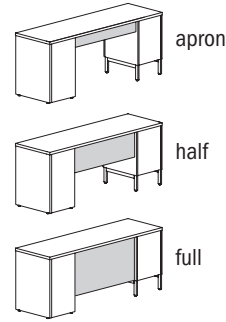





modesty panel options:

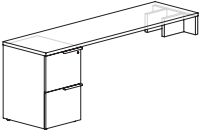

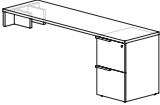
To Order, Specify:

① Laminate Model #	② Laminate Type	③ Laminate Selection	④ Metal Color	⑤ Other Product Options
Laminate (FLT)	HPL	See Laminate Selection	See Metal Finish Color Options	See list of options for each specific unit; Specify and add accordingly.

① Veneer Model #	② Wood Species	③ Wood Finish	④ Metal Color	⑤ Other Product Options
Veneer (FLV)	Flat Cut CH1 Cherry MA1 Maple WA1 Walnut BO1 Black Oak	See Flat Cut Wood Finish Options	See Metal Finish Color Options	See list of options for each specific unit; Specify and add accordingly.
		<table border="1"> <thead> <tr> <th>③a Wood Finish</th> <th>③b Chassis Grain Direction</th> </tr> </thead> <tbody> <tr> <td>See Double Cut Wood Finish Options</td> <td>For Double Cut Only: Vertical Horizontal</td> </tr> </tbody> </table>		
③a Wood Finish	③b Chassis Grain Direction			
See Double Cut Wood Finish Options	For Double Cut Only: Vertical Horizontal			

Description	D	W	H	CTN WT	CU FT	① Model	HPL Laminate	Flat Cut Veneer	Double Cut Veneer
File/File Peninsula Credenza	22	96	29	172	43	FLT2296-29FPC2K	\$2,268		
	22	96	29	172	43	FLV2296-29FPC2K		\$3,164	\$3,481
	22	96	29	172	43	FLT2296-29FPC2K	\$2,268		
	22	96	29	172	43	FLV2296-29FPC2K		\$3,164	\$3,481
	22	90	29	171	40	FLT2290-29FPC2K	\$2,212		
	22	90	29	171	40	FLV2290-29FPC2K		\$3,089	\$3,398
*2K shown	22	90	29	171	40	FLT2290-29FPC2K	\$2,212		
	22	90	29	171	40	FLV2290-29FPC2K		\$3,089	\$3,398
	22	84	29	166	38	FLT2284-29FPC2K	\$2,159		
	22	84	29	166	38	FLV2284-29FPC2K		\$3,013	\$3,314
	22	84	29	166	38	FLT2284-29FPC2K	\$2,159		
	22	84	29	166	38	FLV2284-29FPC2K		\$3,013	\$3,314
*K2	22	84	29	166	38	FLT2284-29FPC2K	\$2,159		
	22	84	29	166	38	FLV2284-29FPC2K		\$3,013	\$3,314
	22	78	29	161	35	FLT2278-29FPC2K	\$2,107		
	22	78	29	161	35	FLV2278-29FPC2K		\$2,940	\$3,235
	22	78	29	161	35	FLT2278-29FPC2K	\$2,107		
	22	78	29	161	35	FLV2278-29FPC2K		\$2,940	\$3,235
*K2	22	78	29	161	35	FLT2278-29FPC2K	\$2,107		
	22	78	29	161	35	FLV2278-29FPC2K		\$2,940	\$3,235
	22	72	29	156	32	FLT2272-29FPC2K	\$2,056		
	22	72	29	156	32	FLV2272-29FPC2K		\$2,868	\$3,154
	22	72	29	156	32	FLT2272-29FPC2K	\$2,056		
	22	72	29	156	32	FLV2272-29FPC2K		\$2,868	\$3,154

Features:

- intended to be used with secondary height credenzas; specify mounting location when ordering credenzas, see page 17
- eased edge profile user side
- pedestal front locking

Options:

- must specify chassis grain direction on double cut veneer, see pages 11-13 for details
- veneer drawer fronts in paint available, specify paint color and add \$337 list; see page 14 for details
- on laminate units, contrasting fronts available, no upcharge; specify color, see page 14 for details
- ledge pulls standard; prism pulls available, specify and see page 9
- top grommet available, specify location and add \$128 list each; see page 46 for details
- worksurface power available, specify "to accommodate EC26" on your purchase order; EC26 unit must be ordered separately, see page 46

FLUX - PRIVATE OFFICE

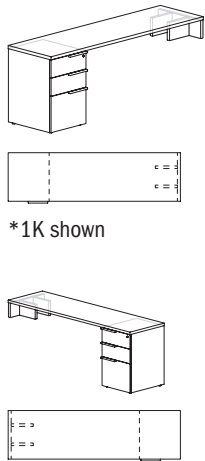
Description	D	W	H	CTN WT	CU FT	① Model	HPL Laminate	Flat Cut Veneer	Double Cut Veneer
Box/Box/File Peninsula Credenza	22	96	29	174	43	FLT2296-29FPCK1	\$2,274		
	22	96	29	174	43	FLV2296-29FPCK1		\$3,174	\$3,492
 <p>*1K shown</p> <p>*K1</p>	22	96	29	174	43	FLT2296-29FPC1K	\$2,274		
	22	96	29	174	43	FLV2296-29FPC1K		\$3,174	\$3,492
	22	90	29	173	40	FLT2290-29FPCK1	\$2,220		
	22	90	29	173	40	FLV2290-29FPCK1		\$3,096	\$3,408
	22	90	29	173	40	FLT2290-29FPC1K	\$2,220		
	22	90	29	173	40	FLV2290-29FPC1K		\$3,096	\$3,408
	22	84	29	168	38	FLT2284-29FPCK1	\$2,165		
	22	84	29	168	38	FLV2284-29FPCK1		\$3,020	\$3,324
	22	84	29	168	38	FLT2284-29FPC1K	\$2,165		
	22	84	29	168	38	FLV2284-29FPC1K		\$3,020	\$3,324
	22	78	29	165	35	FLT2278-29FPCK1	\$2,112		
	22	78	29	165	35	FLV2278-29FPCK1		\$2,946	\$3,243
	22	78	29	165	35	FLT2278-29FPC1K	\$2,112		
	22	78	29	165	35	FLV2278-29FPC1K		\$2,946	\$3,243
	22	72	29	158	32	FLT2272-29FPCK1	\$2,062		
	22	72	29	158	32	FLV2272-29FPCK1		\$2,875	\$3,163
	22	72	29	158	32	FLT2272-29FPC1K	\$2,062		
	22	72	29	158	32	FLV2272-29FPC1K		\$2,875	\$3,163

Features:

- intended to be used with secondary height credenzas; specify mounting location when ordering credenzas, see page 17
- eased edge profile user side
- pedestal front locking

Options:

- must specify chassis grain direction on double cut veneer, see pages 11-13 for details
- veneer drawer fronts in paint available, specify paint color and add \$337 list; see page 14 for details
- on laminate units, contrasting fronts available, no upcharge; specify color, see page 14 for details
- ledge pulls standard; prism pulls available, specify and see page 9
- top grommet available, specify location and add \$128 list each; see page 46 for details
- worksurface power available, specify "to accommodate EC26" on your purchase order; EC26 unit must be ordered separately, see page 46

To Order, Specify:

① Laminate Model #	② Laminate Type	③ Laminate Selection	④ Metal Color	⑤ Other Product Options
Laminate (FLT)	HPL	See Laminate Selection	See Metal Finish Color Options	See list of options for each specific unit; Specify and add accordingly.

① Veneer Model #	② Wood Species	③ Wood Finish	④ Metal Color	⑤ Other Product Options	
Veneer (FLV)	Flat Cut CH1 Cherry MA1 Maple WA1 Walnut BO1 Black Oak	See Flat Cut Wood Finish Options	See Metal Finish Color Options	See list of options for each specific unit; Specify and add accordingly.	
	Double Cut DC1 Double Cut	<table border="1"> <tr> <th>ⓐ Wood Finish</th> <th>ⓑ Chassis Grain Direction</th> </tr> <tr> <td>See Double Cut Wood Finish Options</td> <td>For Double Cut Only: Vertical Horizontal</td> </tr> </table>			ⓐ Wood Finish
ⓐ Wood Finish	ⓑ Chassis Grain Direction				
See Double Cut Wood Finish Options	For Double Cut Only: Vertical Horizontal				

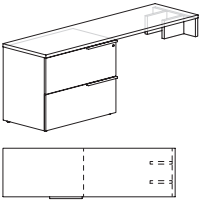
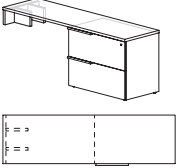
Description	D	W	H	CTN WT	CU FT	① Model	HPL Laminate	Flat Cut Veneer	Double Cut Veneer
Lateral File Peninsula Credenza  *4K shown  *K4	22	96	29	224	43	FLT2296-29FPCK4	\$2,497		
	22	96	29	224	43	FLV2296-29FPCK4		\$3,483	\$3,833
	22	96	29	224	43	FLT2296-29FPC4K	\$2,497		
	22	96	29	224	43	FLV2296-29FPC4K		\$3,483	\$3,833
	22	90	29	219	40	FLT2290-29FPCK4	\$2,435		
	22	90	29	219	40	FLV2290-29FPCK4		\$3,400	\$3,742
	22	90	29	219	40	FLT2290-29FPC4K	\$2,435		
	22	90	29	219	40	FLV2290-29FPC4K		\$3,400	\$3,742
	22	84	29	214	38	FLT2284-29FPCK4	\$2,376		
	22	84	29	214	38	FLV2284-29FPCK4		\$3,316	\$3,648
	22	84	29	214	38	FLT2284-29FPC4K	\$2,376		
	22	84	29	214	38	FLV2284-29FPC4K		\$3,316	\$3,648
	22	78	29	209	35	FLT2278-29FPCK4	\$2,319		
	22	78	29	209	35	FLV2278-29FPCK4		\$3,237	\$3,562
	22	78	29	209	35	FLT2278-29FPC4K	\$2,319		
	22	78	29	209	35	FLV2278-29FPC4K		\$3,237	\$3,562
22	72	29	205	32	FLT2272-29FPCK4	\$2,262			
22	72	29	205	32	FLV2272-29FPCK4		\$3,157	\$3,473	
22	72	29	205	32	FLT2272-29FPC4K	\$2,262			
22	72	29	205	32	FLV2272-29FPC4K		\$3,157	\$3,473	

Features:

- intended to be used with secondary height credenzas; specify mounting location when ordering credenzas, see page 17
- eased edge profile user side
- pedestal front locking

Options:

- must specify chassis grain direction on double cut veneer, see pages 11-13 for details
- veneer drawer fronts in paint available, specify paint color and add \$337 list; see page 14 for details
- on laminate units, contrasting fronts available, no upcharge; specify color, see page 14 for details
- ledge pulls standard; prism pulls available, specify and see page 9
- top grommet available, specify location and add \$128 list each; see page 46 for details
- worksurface power available, specify "to accommodate EC26" on your purchase order; EC26 unit must be ordered separately, see page 46

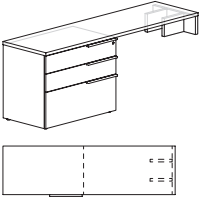
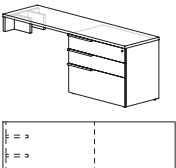
Box/Box/File Lateral Peninsula Credenza  *3K shown  *K3	22	96	29	224	43	FLT2296-29FPCK3	\$2,506		
	22	96	29	224	43	FLV2296-29FPCK3		\$3,499	\$3,847
	22	96	29	224	43	FLT2296-29FPC3K	\$2,506		
	22	96	29	224	43	FLV2296-29FPC3K		\$3,499	\$3,847
	22	90	29	220	40	FLT2290-29FPCK3	\$2,444		
	22	90	29	220	40	FLV2290-29FPCK3		\$3,413	\$3,754
	22	90	29	220	40	FLT2290-29FPC3K	\$2,444		
	22	90	29	220	40	FLV2290-29FPC3K		\$3,413	\$3,754
	22	84	29	215	38	FLT2284-29FPCK3	\$2,386		
	22	84	29	215	38	FLV2284-29FPCK3		\$3,330	\$3,662
	22	84	29	215	38	FLT2284-29FPC3K	\$2,386		
	22	84	29	215	38	FLV2284-29FPC3K		\$3,330	\$3,662
	22	78	29	211	35	FLT2278-29FPCK3	\$2,327		
	22	78	29	211	35	FLV2278-29FPCK3		\$3,248	\$3,574
	22	78	29	211	35	FLT2278-29FPC3K	\$2,327		
	22	78	29	211	35	FLV2278-29FPC3K		\$3,248	\$3,574
22	72	29	206	32	FLT2272-29FPCK3	\$2,270			
22	72	29	206	32	FLV2272-29FPCK3		\$3,170	\$3,488	
22	72	29	206	32	FLT2272-29FPC3K	\$2,270			
22	72	29	206	32	FLV2272-29FPC3K		\$3,170	\$3,488	

Features:

- intended to be used with secondary height credenzas; specify mounting location when ordering credenzas, see page 17
- eased edge profile user side
- pedestal front locking

Options:

- must specify chassis grain direction on double cut veneer, see pages 11-13 for details
- veneer drawer fronts in paint available, specify paint color and add \$337 list; see page 14 for details
- on laminate units, contrasting fronts available, no upcharge; specify color, see page 14 for details
- ledge pulls standard; prism pulls available, specify and see page 9
- top grommet available, specify location and add \$128 list each; see page 46 for details
- worksurface power available, specify "to accommodate EC26" on your purchase order; EC26 unit must be ordered separately, see page 46

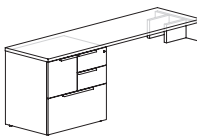
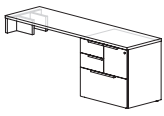
Description	D	W	H	CTN WT	CU FT	① Model	HPL Laminate	Flat Cut Veneer	Double Cut Veneer
 left shown  right	22	96	29	225	43	FLT2296-29FPMRR	\$2,635		
	22	96	29	225	43	FLV2296-29FPMRR		\$3,678	\$4,044
	22	96	29	225	43	FLT2296-29FPMLR	\$2,635		
	22	96	29	225	43	FLV2296-29FPMLR		\$3,678	\$4,044
	22	90	29	220	40	FLT2290-29FPMRR	\$2,570		
	22	90	29	220	40	FLV2290-29FPMRR		\$3,588	\$3,948
	22	90	29	220	40	FLT2290-29FPMLR	\$2,570		
	22	90	29	220	40	FLV2290-29FPMLR		\$3,588	\$3,948
	22	84	29	214	38	FLT2284-29FPMRR	\$2,507		
	22	84	29	214	38	FLV2284-29FPMRR		\$3,501	\$3,850
	22	84	29	214	38	FLT2284-29FPMLR	\$2,507		
	22	84	29	214	38	FLV2284-29FPMLR		\$3,501	\$3,850
	22	78	29	209	35	FLT2278-29FPMRR	\$2,447		
	22	78	29	209	35	FLV2278-29FPMRR		\$3,416	\$3,758
	22	78	29	209	35	FLT2278-29FPMLR	\$2,447		
	22	78	29	209	35	FLV2278-29FPMLR		\$3,416	\$3,758
	22	72	29	204	32	FLT2272-29FPMRR	\$2,387		
	22	72	29	204	32	FLV2272-29FPMRR		\$3,331	\$3,664
	22	72	29	204	32	FLT2272-29FPMLR	\$2,387		
	22	72	29	204	32	FLV2272-29FPMLR		\$3,331	\$3,664

Features:

- intended to be used with secondary height credenzas; specify mounting location when ordering credenzas, see page 17
- eased edge profile user side
- pedestal front locking

Options:

- must specify chassis grain direction on double cut veneer, see pages 11-13 for details
- veneer drawer fronts in paint available, specify paint color and add \$337 list; see page 14 for details
- on laminate units, contrasting fronts available, no upcharge; specify color, see page 14 for details
- ledge pulls standard; prism pulls available, specify and see page 9
- top grommet available, specify location and add \$128 list each; see page 46 for details
- worksurface power available, specify "to accommodate EC26" on your purchase order; EC26 unit must be ordered separately, see page 46

To Order, Specify:

① Laminate Model #	② Laminate Type	③ Laminate Selection	④ Metal Color	⑤ Other Product Options
Laminate (FLT)	HPL	See Laminate Selection	See Metal Finish Color Options	See list of options for each specific unit; Specify and add accordingly.

① Veneer Model #	② Wood Species	③ Wood Finish	④ Metal Color	⑤ Other Product Options
Veneer (FLV)	Flat Cut CH1 Cherry MA1 Maple WA1 Walnut BO1 Black Oak	See Flat Cut Wood Finish Options	See Metal Finish Color Options	See list of options for each specific unit; Specify and add accordingly.
		<table border="1"> <thead> <tr> <th>ⓐ Wood Finish</th> <th>ⓑ Chassis Grain Direction</th> </tr> </thead> <tbody> <tr> <td>See Double Cut Wood Finish Options</td> <td>For Double Cut Only: Vertical Horizontal</td> </tr> </tbody> </table>		
ⓐ Wood Finish	ⓑ Chassis Grain Direction			
See Double Cut Wood Finish Options	For Double Cut Only: Vertical Horizontal			

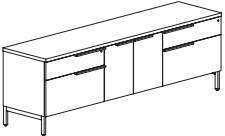
Description	D	W	H	CTN WT	CU FT	① Model	HPL Laminate	Flat Cut Veneer	Double Cut Veneer
	22	96	29	377	43	FLT2296-29L676	\$4,225		
	22	96	29	377	43	FLV2296-29L676		\$5,486	\$6,036
	22	90	29	359	40	FLT2290-29L676	\$4,100		
	22	90	29	359	40	FLV2290-29L676		\$5,324	\$5,858
	22	84	29	340	38	FLT2284-29L676	\$3,980		
	22	84	29	340	38	FLV2284-29L676		\$5,168	\$5,685

Features:

- eased edge profile user side
- pedestal front locking
- hinged door compartment has one adjustable shelf

Options:

- must specify chassis grain direction on double cut veneer, see pages 11-13 for details
- locking door available, specify and add \$142 list
- concealed box drawer(s) available, specify location in unit; add \$234 list for each laminate drawer or \$357 for each veneer drawer, see page 23 for details
- veneer door and drawer fronts in paint available, specify paint color and add \$337; see page 14 for details
- on laminate units, contrasting worksurface tops and door fronts available, no upcharge; specify laminate color, see page 14 for details
- ledge pulls standard; prism pulls available, specify and see page 9
- oval grommets in back panel can be eliminated upon request, no upcharge
- interior horizontal wire manager with end grommets available, specify and add \$180 list; see page 38 for details
- top grommet available, specify location; add \$128 list each; see page 45 for details
- worksurface power available, specify "to accommodate EC26" on your purchase order; EC26 unit must be ordered separately, see page 45

	22	90	29	369	40	FLT2290-29S676	\$4,100		
	22	90	29	369	40	FLV2290-29S676		\$5,324	\$5,858

Features:

- eased edge profile user side
- pedestal front locking
- hinged door compartment has one adjustable shelf

Options:

- must specify chassis grain direction on double cut veneer, see pages 11-13 for details
- locking door available, specify and add \$142 list
- concealed box drawer(s) available, specify location in unit; add \$234 list for each laminate drawer or \$357 for each veneer drawer, see page 23 for details
- veneer door and drawer fronts in paint available, specify paint color and add \$337; see page 14 for details
- on laminate units, contrasting worksurface tops and door fronts available, no upcharge; specify laminate color, see page 14 for details
- ledge pulls standard; prism pulls available, specify and see page 9
- oval grommets in back panel can be eliminated upon request, no upcharge
- interior horizontal wire manager with end grommets available, specify and add \$180 list; see page 38 for details
- top grommet available, specify location; add \$128 list each; see page 45 for details
- worksurface power available, specify "to accommodate EC26" on your purchase order; EC26 unit must be ordered separately, see page 45

Description	D IN	W IN	H IN	CTN QTY	CU FT	Model	HPL Laminate	Flat Cut Veneer	Double Cut Veneer
Storage Credenza - Flush Legs	22	78	29	311	35	FLT2278-29L575	\$3,727		
	22	78	29	311	35	FLV2278-29L575		\$4,838	\$5,322
	22	72	29	292	32	FLT2272-29L575	\$3,622		
	22	72	29	292	32	FLV2272-29L575		\$4,701	\$5,171
	22	66	29	273	30	FLT2266-29L575	\$3,562		
	22	66	29	273	30	FLV2266-29L575		\$4,622	\$5,086
	22	60	29	255	27	FLT2260-29L575	\$3,498		
	22	60	29	255	27	FLV2260-29L575		\$4,539	\$4,993

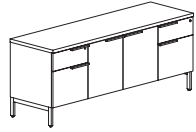

Features:

- eased edge profile user side
- pedestal front locking
- hinged door compartment has one adjustable shelf

Options:

- must specify chassis grain direction on double cut veneer, see pages 11-13 for details
- locking door available, specify and add \$142 list
- concealed box drawer(s) available, specify location in unit; add \$234 list for each laminate drawer or \$357 for each veneer drawer, see page 23 for details
- veneer door and drawer fronts in paint available, specify paint color and add \$337; see page 14 for details
- on laminate units, contrasting worksurface tops and door fronts available, no upcharge; specify laminate color, see page 14 for details
- ledge pulls standard; prism pulls available, specify and see page 9
- oval grommets in back panel can be eliminated upon request, no upcharge
- interior horizontal wire manager with end grommets available, specify and add \$180 list; see page 38 for details
- top grommet available, specify location; add \$128 list each; see page 45 for details
- worksurface power available, specify "to accommodate EC26" on your purchase order; EC26 unit must be ordered separately, see page 45

Storage Credenza - Inset Legs	22	72	29	298	32	FLT2272-29S575	\$3,622		
	22	72	29	298	32	FLV2272-29S575		\$4,701	\$5,171
	22	60	29	254	27	FLT2260-29S575	\$3,498		
	22	60	29	254	27	FLV2260-29S575		\$4,539	\$4,993

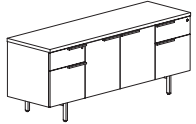

Features:

- eased edge profile user side
- pedestal front locking
- hinged door compartment has one adjustable shelf

Options:

- must specify chassis grain direction on double cut veneer, see pages 11-13 for details
- locking door available, specify and add \$142 list
- concealed box drawer(s) available, specify location in unit; add \$234 list for each laminate drawer or \$357 for each veneer drawer, see page 23 for details
- veneer door and drawer fronts in paint available, specify paint color and add \$337; see page 14 for details
- on laminate units, contrasting worksurface tops and door fronts available, no upcharge; specify laminate color, see page 14 for details
- ledge pulls standard; prism pulls available, specify and see page 9
- oval grommets in back panel can be eliminated upon request, no upcharge
- interior horizontal wire manager with end grommets available, specify and add \$180 list; see page 38 for details
- top grommet available, specify location; add \$128 list each; see page 45 for details
- worksurface power available, specify "to accommodate EC26" on your purchase order; EC26 unit must be ordered separately, see page 45

To Order, Specify:

1 Laminate Model #	2 Laminate Type	3 Laminate Selection	4 Metal Color	5 Other Product Options				
Laminate (FLT)	TFL HLP	See Laminate Selection	See Metal Finish Color Options	See list of options for each specific unit; Specify and add accordingly.				
1 Veneer Model #	2 Wood Species	3 Wood Finish	4 Metal Color	5 Other Product Options				
Veneer (FLV)	Flat Cut CH1 Cherry MA1 Maple WA1 Walnut BO1 Black Oak	See Flat Cut Wood Finish Options	See Metal Finish Color Options	See list of options for each specific unit; Specify and add accordingly.				
	Double Cut DC1 Double Cut	<table border="1"> <tr> <th>3a Wood Finish</th> <th>3b Chassis Grain Direction</th> </tr> <tr> <td>See Double Cut Wood Finish Options</td> <td>For Double Cut Only: Vertical Horizontal</td> </tr> </table>	3a Wood Finish	3b Chassis Grain Direction	See Double Cut Wood Finish Options	For Double Cut Only: Vertical Horizontal		
3a Wood Finish	3b Chassis Grain Direction							
See Double Cut Wood Finish Options	For Double Cut Only: Vertical Horizontal							

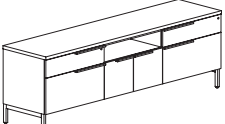
Description	D	W	H	CTN WT	CU FT	① Model	HPL Laminate	Flat Cut Veneer	Double Cut Veneer
Box/Lateral Storage Credenza with Open Center - Flush Legs 	22	96	29	365	43	FLT2296-29L686	\$4,267		
	22	96	29	365	43	FLV2296-29L686		\$5,540	\$6,095
	22	90	29	355	40	FLT2290-29L686	\$4,144		
	22	90	29	355	40	FLV2290-29L686		\$5,379	\$5,919
	22	84	29	332	38	FLT2284-29L686	\$4,023		
	22	84	29	332	38	FLV2284-29L686		\$5,225	\$5,747

Features:

- eased edge profile user side
- pedestal front locking
- hinged door compartment has one adjustable shelf

Options:

- must specify chassis grain direction on double cut veneer, see pages 11-13 for details
- locking door available, specify and add \$142 list
- concealed box drawer(s) available, specify location in unit; add \$234 list for each laminate drawer or \$357 for each veneer drawer, see page 23 for details
- veneer door and drawer fronts in paint available, specify paint color and add \$337; see page 14 for details
- on laminate units, contrasting worksurface tops and door fronts available, no upcharge; specify laminate color, see page 14 for details
- ledge pulls standard; prism pulls available, specify and see page 9
- oval grommets in back panel can be eliminated upon request, no upcharge
- interior horizontal wire manager with end grommets available, specify and add \$180 list; see page 38 for details
- top grommet available, specify location; add \$128 list each; see page 45 for details
- worksurface power available, specify "to accommodate EC26" on your purchase order; EC26 unit must be ordered separately, see page 45

Box/Lateral Storage Credenza with Open Center - Inset Legs 	22	90	29	390	40	FLT2290-29S686	\$4,144		
	22	90	29	390	40	FLV2290-29S686		\$5,379	\$5,919

Features:

- eased edge profile user side
- pedestal front locking
- hinged door compartment has one adjustable shelf

Options:

- must specify chassis grain direction on double cut veneer, see pages 11-13 for details
- locking door available, specify and add \$142 list
- concealed box drawer(s) available, specify location in unit; add \$234 list for each laminate drawer or \$357 for each veneer drawer, see page 23 for details
- veneer door and drawer fronts in paint available, specify paint color and add \$337; see page 14 for details
- on laminate units, contrasting worksurface tops and door fronts available, no upcharge; specify laminate color, see page 14 for details
- ledge pulls standard; prism pulls available, specify and see page 9
- oval grommets in back panel can be eliminated upon request, no upcharge
- interior horizontal wire manager with end grommets available, specify and add \$180 list; see page 38 for details
- top grommet available, specify location; add \$128 list each; see page 45 for details
- worksurface power available, specify "to accommodate EC26" on your purchase order; EC26 unit must be ordered separately, see page 45

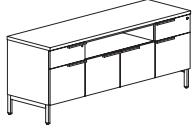
Description	D	W	H	CTN WT	CU FT	① Model	HPL Laminate	Flat Cut Veneer	Double Cut Veneer
 Box/Lateral Storage Credenza with Open Center - Flush Legs	22	78	29	300	35	FLT2278-29L585	\$3,769		
	22	78	29	300	35	FLV2278-29L585		\$4,893	\$5,383
	22	72	29	288	32	FLT2272-29L585	\$3,662		
	22	72	29	288	32	FLV2272-29L585		\$4,755	\$5,231
	22	66	29	269	30	FLT2266-29L585	\$3,602		
	22	66	29	269	30	FLV2266-29L585		\$4,679	\$5,146
	22	60	29	252	27	FLT2260-29L585	\$3,538		
	22	60	29	252	27	FLV2260-29L585		\$4,595	\$5,054

Features:

- eased edge profile user side
- pedestal front locking
- hinged door compartment has one adjustable shelf

Options:

- must specify chassis grain direction on double cut veneer, see pages 11-13 for details
- locking doors available, specify and add \$142 list
- veneer door and drawer fronts in paint available, specify paint color and add \$337; see page 14 for details
- on laminate units, contrasting worksurface tops and door fronts available, no upcharge; specify laminate color, see page 14 for details
- ledge pulls standard; prism pulls available, specify and see page 9
- oval grommets in back panel can be eliminated upon request, no upcharge
- interior horizontal wire manager with end grommets available, specify and add \$180 list; see page 38 for details
- top grommet available, specify location; add \$128 list each; see page 45 for details
- worksurface power available, specify "to accommodate EC26" on your purchase order; EC26 unit must be ordered separately, see page 45

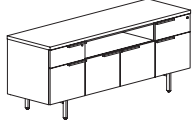
 Box/Lateral Storage Credenza with Open Center - Inset Legs	22	72	29	295	32	FLT2272-29S585	\$3,662		
	22	72	29	295	32	FLV2272-29S585		\$4,755	\$5,231
	22	60	29	250	27	FLT2260-29S585	\$3,538		
	22	60	29	250	27	FLV2260-29S585		\$4,595	\$5,054

Features:

- eased edge profile user side
- pedestal front locking
- hinged door compartment has one adjustable shelf

Options:

- must specify chassis grain direction on double cut veneer, see pages 11-13 for details
- locking doors available, specify and add \$142 list
- veneer door and drawer fronts in paint available, specify paint color and add \$337; see page 14 for details
- on laminate units, contrasting worksurface tops and door fronts available, no upcharge; specify laminate color, see page 14 for details
- ledge pulls standard; prism pulls available, specify and see page 9
- oval grommets in back panel can be eliminated upon request, no upcharge
- interior horizontal wire manager with end grommets available, specify and add \$180 list; see page 38 for details
- top grommet available, specify location; add \$128 list each; see page 45 for details
- worksurface power available, specify "to accommodate EC26" on your purchase order; EC26 unit must be ordered separately, see page 45

To Order, Specify:

① Laminate Model #	② Laminate Type	③ Laminate Selection		④ Metal Color	⑤ Other Product Options
Laminate (FLT)	TFL	See Laminate Selection		See Metal Finish Color Options	See list of options for each specific unit; Specify and add accordingly.
	HLP				
① Veneer Model #	② Wood Species	③ Wood Finish		④ Metal Color	⑤ Other Product Options
Veneer (FLV)	Flat Cut CH1 Cherry MA1 Maple WA1 Walnut BO1 Black Oak	See Flat Cut Wood Finish Options		See Metal Finish Color Options	See list of options for each specific unit; Specify and add accordingly.
	Double Cut DC1 Double Cut	③a Wood Finish See Double Cut Wood Finish Options	③b Chassis Grain Direction For Double Cut Only: Vertical Horizontal		

Description	D	W	H	CTN WT	CU FT	① Model	HPL Laminate	Flat Cut Veneer	Double Cut Veneer
Box/Lateral File Credenza - Flush Legs	22	90	29	392	40	FLT2290-29L666	\$4,043		
	22	90	29	392	40	FLV2290-29L666		\$5,251	\$5,777

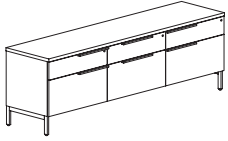

Features:

- eased edge profile user side
- pedestal front locking

Options:

- must specify chassis grain direction on double cut veneer, see pages 11-13 for details
- concealed box drawer(s) available, specify location in unit; add \$234 list for each laminate drawer or \$357 for each veneer drawer, see page 23 for details
- veneer drawer fronts in paint available, specify paint color and add \$337 list; see page 14 for details
- on laminate units, contrasting worksurface tops and drawer fronts available, no upcharge; specify color, see page 14 for details
- ledge pulls standard; prism pulls available, specify and see page 9
- oval grommets in back panel can be eliminated upon request, no upcharge
- interior horizontal wire manager with end grommets available, specify and add \$180 list; see page 38 for details
- top grommet available, specify location; add \$128 list each; see page 45 for details

FLUX - PRIVATE OFFICE

Box/Lateral File Credenza - Inset Legs	22	90	29	301	32	FLT2290-29S666	\$4,043		
	22	90	29	301	32	FLV2290-29S666		\$5,251	\$5,777

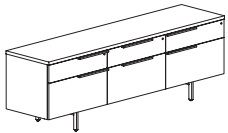

Features:

- eased edge profile user side
- pedestal front locking

Options:

- must specify chassis grain direction on double cut veneer, see pages 11-13 for details
- concealed box drawer(s) available, specify location in unit; add \$234 list for each laminate drawer or \$357 for each veneer drawer, see page 23 for details
- veneer drawer fronts in paint available, specify paint color and add \$337 list; see page 14 for details
- on laminate units, contrasting worksurface tops and drawer fronts available, no upcharge; specify color, see page 14 for details
- ledge pulls standard; prism pulls available, specify and see page 9
- oval grommets in back panel can be eliminated upon request, no upcharge
- interior horizontal wire manager with end grommets available, specify and add \$180 list; see page 38 for details
- top grommet available, specify location; add \$128 list each; see page 45 for details

Description	D	W	H	CTN WT	CU FT	① Model	HPL Laminate	Flat Cut Veneer	Double Cut Veneer
Box/Lateral File Credenza - Flush Legs	22	72	29	303	32	FLT2272-29L66	\$3,172		
	22	72	29	303	32	FLV2272-29L66		\$4,115	\$4,527
	22	60	29	268	27	FLT2260-29L66	\$3,071		
	22	60	29	268	27	FLV2260-29L66		\$3,989	\$4,391

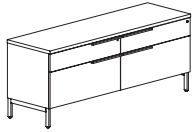

Features:

- eased edge profile user side
- pedestal front locking

Options:

- must specify chassis grain direction on double cut veneer, see pages 11-13 for details
- concealed box drawer(s) available, specify location in unit; add \$234 list for each laminate drawer or \$357 for each veneer drawer, see page 23 for details
- veneer drawer fronts in paint available, specify paint color and add \$337 list; see page 14 for details
- on laminate units, contrasting worksurface tops and drawer fronts available, no upcharge; specify color, see page 14 for details
- ledge pulls standard; prism pulls available, specify and see page 9
- oval grommets in back panel can be eliminated upon request, no upcharge
- interior horizontal wire manager with end grommets available, specify and add \$180 list; see page 38 for details
- top grommet available, specify location; add \$128 list each; see page 45 for details

Description	D	W	H	CTN WT	CU FT	① Model	HPL Laminate	Flat Cut Veneer	Double Cut Veneer
Box/Lateral File Credenza - Inset Legs	22	72	29	266	27	FLT2272-29S66	\$3,172		
	22	72	29	266	27	FLV2272-29S66		\$4,115	\$4,527
	22	60	29	323	40	FLT2260-29S66	\$3,071		
	22	60	29	323	40	FLV2260-29S66		\$3,989	\$4,391

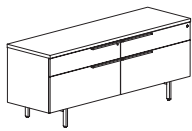

Features:

- eased edge profile user side
- pedestal front locking

Options:

- must specify chassis grain direction on double cut veneer, see pages 11-13 for details
- concealed box drawer(s) available, specify location in unit; add \$234 list for each laminate drawer or \$357 for each veneer drawer, see page 23 for details
- veneer drawer fronts in paint available, specify paint color and add \$337 list; see page 14 for details
- on laminate units, contrasting worksurface tops and drawer fronts available, no upcharge; specify color, see page 14 for details
- ledge pulls standard; prism pulls available, specify and see page 9
- oval grommets in back panel can be eliminated upon request, no upcharge
- interior horizontal wire manager with end grommets available, specify and add \$180 list; see page 38 for details
- top grommet available, specify location; add \$128 list each; see page 45 for details

To Order, Specify:

① Laminate Model #	② Laminate Type	③ Laminate Selection	④ Metal Color	⑤ Other Product Options
Laminate (FLT)	HPL	See Laminate Selection	See Metal Finish Color Options	See list of options for each specific unit; Specify and add accordingly.

① Veneer Model #	② Wood Species	③ Wood Finish	④ Metal Color	⑤ Other Product Options
Veneer (FLV)	Flat Cut CH1 Cherry MA1 Maple WA1 Walnut BO1 Black Oak	See Flat Cut Wood Finish Options	See Metal Finish Color Options	See list of options for each specific unit; Specify and add accordingly.
		<table border="1"> <thead> <tr> <th>③a Wood Finish</th> <th>③b Chassis Grain Direction</th> </tr> </thead> <tbody> <tr> <td>See Double Cut Wood Finish Options</td> <td>For Double Cut Only: Vertical Horizontal</td> </tr> </tbody> </table>		
③a Wood Finish	③b Chassis Grain Direction			
See Double Cut Wood Finish Options	For Double Cut Only: Vertical Horizontal			

Description	D	W	H	CTN WT	CU FT	① Model	HPL Laminate	Flat Cut Veneer	Double Cut Veneer
Six Door Credenza Open Center - Flush Legs	22	96	29	332	43	FLT2296-29L787	\$3,879		
	22	96	29	332	43	FLV2296-29L787		\$5,035	\$5,540
	22	90	29	321	40	FLT2290-29L787	\$3,785		
	22	90	29	321	40	FLV2290-29L787		\$4,916	\$5,407
	22	84	29	296	38	FLT2284-29L787	\$3,686		
	22	84	29	296	38	FLV2284-29L787		\$4,786	\$5,265

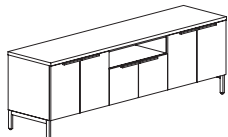

Features:

- eased edge profile user side
- each end compartment has one adjustable shelf

Options:

- must specify chassis grain direction on double cut veneer, see pages 11-13 for details
- locking doors available, specify and add \$426 list
- veneer door fronts in paint available, specify paint color and add \$337 list; see page 14 for details
- on laminate units, contrasting worksurface tops and door fronts available, no upcharge; specify laminate color, see page 14 for details
- ledge pulls standard; prism pulls available, specify and see page 9
- oval grommets in back panel can be eliminated upon request, no upcharge
- interior horizontal wire manager with end grommets available, specify and add \$180 list; see page 38 for details
- top grommet available, specify location; add \$128 list each; see page 45 for details
- worksurface power available, specify "to accommodate EC26" on your purchase order; EC26 unit must be ordered separately, see page 45

Four Door Credenza Open Center - Flush Legs	22	78	29	279	35	FLT2278-29L787	\$3,575		
	22	78	29	279	35	FLV2278-29L787		\$4,642	\$5,105
	22	72	29	265	32	FLT2272-29L787	\$3,461		
	22	72	29	265	32	FLV2272-29L787		\$4,493	\$4,943
	22	66	29	247	30	FLT2266-29L787	\$3,378		
	22	66	29	247	30	FLV2266-29L787		\$4,385	\$4,824
	22	60	29	229	27	FLT2260-29L787	\$3,289		
	22	60	29	229	27	FLV2260-29L787		\$4,270	\$4,699

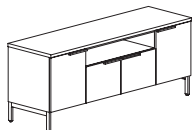

Features:

- eased edge profile user side
- each end compartment has one adjustable shelf

Options:

- must specify chassis grain direction on double cut veneer, see pages 11-13 for details
- locking doors available, specify and add \$426 list
- veneer door fronts in paint available, specify paint color and add \$337 list; see page 14 for details
- on laminate units, contrasting worksurface tops and door fronts available, no upcharge; specify laminate color, see page 14 for details
- ledge pulls standard; prism pulls available, specify and see page 9
- oval grommets in back panel can be eliminated upon request, no upcharge
- interior horizontal wire manager with end grommets available, specify and add \$180 list; see page 38 for details
- top grommet available, specify location; add \$128 list each; see page 45 for details
- worksurface power available, specify "to accommodate EC26" on your purchase order; EC26 unit must be ordered separately, see page 45

Description	D	W	H	CTN WT	CU FT	① Model	HPL Laminate	Flat Cut Veneer	Double Cut Veneer
Six Door Storage with Open Center - Inset Legs	22	90	29	318	40	FLT2290-29S787	\$3,785		
	22	90	29	318	40	FLV2290-29S787		\$4,916	\$5,407

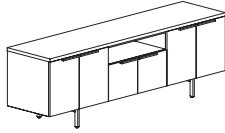

Features:

- eased edge profile user side
- each end compartment has one adjustable shelf

Options:

- must specify chassis grain direction on double cut veneer, see pages 11-13 for details
- locking doors available, specify and add \$426 list
- veneer door fronts in paint available, specify paint color and add \$337 list; see page 14 for details
- on laminate units, contrasting worksurface tops and door fronts available, no upcharge; specify color, see page 14 for details
- ledge pulls standard; prism pulls available, specify and see page 9
- oval grommets in back panel can be eliminated upon request, no upcharge
- interior horizontal wire manager with end grommets available, specify and add \$180 list; see page 38 for details
- top grommet available, specify location; add \$128 list each; see page 45 for details
- worksurface power available, specify "to accommodate EC26" on your purchase order; EC26 unit must be ordered separately, see page 45

Hinge Door Storage with Open Center - Inset Legs	D	W	H	CTN WT	CU FT	① Model	HPL Laminate	Flat Cut Veneer	Double Cut Veneer
	22	72	29	270	32	FLT2272-29S787	\$3,461		
	22	72	29	270	32	FLV2272-29S787		\$4,493	\$4,943
	22	60	29	234	27	FLT2260-29S787	\$3,289		
	22	60	29	234	27	FLV2260-29S787		\$4,270	\$4,699

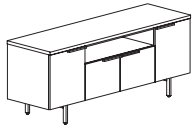

Features:

- eased edge profile user side
- each end compartment has one adjustable shelf

Options:

- must specify chassis grain direction on double cut veneer, see pages 11-13 for details
- locking doors available, specify and add \$426 list
- veneer door fronts in paint available, specify paint color and add \$337 list; see page 14 for details
- on laminate units, contrasting worksurface tops and door fronts available, no upcharge; specify color, see page 14 for details
- ledge pulls standard; prism pulls available, specify and see page 9
- oval grommets in back panel can be eliminated upon request, no upcharge
- interior horizontal wire manager with end grommets available, specify and add \$180 list; see page 38 for details
- top grommet available, specify location; add \$128 list each; see page 45 for details
- worksurface power available, specify "to accommodate EC26" on your purchase order; EC26 unit must be ordered separately, see page 45

To Order, Specify:

① Laminate Model #	② Laminate Type	③ Laminate Selection	④ Metal Color	⑤ Other Product Options
Laminate (FLT)	HPL	See Laminate Selection	See Metal Finish Color Options	See list of options for each specific unit; Specify and add accordingly.

① Veneer Model #	② Wood Species	③ Wood Finish	④ Metal Color	⑤ Other Product Options
Veneer (FLV)	Flat Cut CH1 Cherry MA1 Maple WA1 Walnut BO1 Black Oak	See Flat Cut Wood Finish Options	See Metal Finish Color Options	See list of options for each specific unit; Specify and add accordingly.
		<table border="1"> <thead> <tr> <th>③a Wood Finish</th> <th>③b Chassis Grain Direction</th> </tr> </thead> <tbody> <tr> <td>See Double Cut Wood Finish Options</td> <td>For Double Cut Only: Vertical Horizontal</td> </tr> </tbody> </table>		
③a Wood Finish	③b Chassis Grain Direction			
See Double Cut Wood Finish Options	For Double Cut Only: Vertical Horizontal			

Description	D	W	H	CTN WT	CU FT	① Model	HPL Laminate	Flat Cut Veneer	Double Cut Veneer
Six Door Storage Credenza - Flush Legs	22	96	29	336	43	FLT2296-29L777	\$3,914		
	22	96	29	336	43	FLV2296-29L777		\$5,081	\$5,591
	22	90	29	326	40	FLT2290-29L777	\$3,819		
	22	90	29	326	40	FLV2290-29L777		\$4,958	\$5,455
	22	84	29	302	38	FLT2284-29L777	\$3,730		
	22	84	29	302	38	FLV2284-29L777		\$4,845	\$5,330

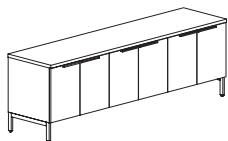

Features:

- eased edge profile user side
- each hinged door compartment has one adjustable shelf

Options:

- must specify chassis grain direction on double cut veneer, see pages 11-13 for details
- locking doors available, specify and add \$426 list
- veneer door fronts in paint available, specify paint color and add \$337 list; see page 14 for details
- on laminate units, contrasting worksurface tops and door fronts available, no upcharge; specify color, see page 14 for details
- ledge pulls standard; prism pulls available, specify and see page 9
- oval grommets in back panel can be eliminated upon request, no upcharge
- interior horizontal wire manager with end grommets available, specify and add \$180 list; see page 38 for details
- top grommet available, specify location; add \$128 list each; see page 45 for details
- worksurface power available, specify "to accommodate EC26" on your purchase order; EC26 unit must be ordered separately, see page 45

Six Door Storage Credenza - Inset Legs	22	90	29	320	40	FLT2290-29S777	\$3,819		
	22	90	29	320	40	FLV2290-29S777		\$4,958	\$5,455

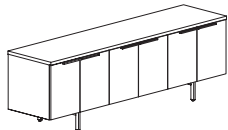

Features:

- eased edge profile user side
- each hinged door compartment has one adjustable shelf

Options:

- must specify chassis grain direction on double cut veneer, see pages 11-13 for details
- locking doors available, specify and add \$426 list
- veneer door fronts in paint available, specify paint color and add \$337 list; see page 14 for details
- on laminate units, contrasting worksurface tops and door fronts available, no upcharge; specify color, see page 14 for details
- ledge pulls standard; prism pulls available, specify and see page 9
- oval grommets in back panel can be eliminated upon request, no upcharge
- interior horizontal wire manager with end grommets available, specify and add \$180 list; see page 38 for details
- top grommet available, specify location; add \$128 list each; see page 45 for details
- worksurface power available, specify "to accommodate EC26" on your purchase order; EC26 unit must be ordered separately, see page 45

FLUX - PRIVATE OFFICE

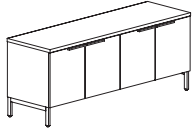
Description	D	W	H	CTN WT	CU FT	① Model	HPL Laminate	Flat Cut Veneer	Double Cut Veneer
Four Door Storage Credenza - Flush Legs 	22	78	29	277	35	FLT2278-29L77	\$3,475		
	22	78	29	277	35	FLV2278-29L77		\$4,514	\$4,965
	22	72	29	263	32	FLT2272-29L77	\$3,379		
	22	72	29	263	32	FLV2272-29L77		\$4,387	\$4,826
	22	66	29	239	30	FLT2266-29L77	\$3,270		
	22	66	29	239	30	FLV2266-29L77		\$4,246	\$4,668
	22	60	29	226	27	FLT2260-29L77	\$3,159		
	22	60	29	226	27	FLV2260-29L77		\$4,102	\$4,513

Features:

- eased edge profile user side
- each hinged door compartment has one adjustable shelf

Options:

- must specify chassis grain direction on double cut veneer, see pages 11-13 for details
- locking doors available, specify and add \$284 list
- veneer door fronts in paint available, specify paint color and add \$337 list; see page 14 for details
- on laminate units, contrasting worksurface tops and door fronts available, no upcharge; specify color, see page 14 for details
- ledge pulls standard; prism pulls available, specify and see page 9
- oval grommets in back panel can be eliminated upon request, no upcharge
- interior horizontal wire manager with end grommets available, specify and add \$180 list; see page 38 for details
- top grommet available, specify location; add \$128 list each; see page 45 for details
- worksurface power available, specify "to accommodate EC26" on your purchase order; EC26 unit must be ordered separately, see page 45

Four Door Storage Credenza - Inset Legs 	22	72	29	258	32	FLT2272-29S77	\$3,379		
	22	72	29	258	32	FLV2272-29S77		\$4,387	\$4,826
	22	60	29	224	27	FLT2260-29S77	\$3,159		
	22	60	29	224	27	FLV2260-29S77		\$4,102	\$4,513

Features:

- eased edge profile user side
- each hinged door compartment has one adjustable shelf

Options:

- must specify chassis grain direction on double cut veneer, see pages 11-13 for details
- locking doors available, specify and add \$284 list
- veneer door fronts in paint available, specify paint color and add \$337 list; see page 14 for details
- on laminate units, contrasting worksurface tops and door fronts available, no upcharge; specify color, see page 14 for details
- ledge pulls standard; prism pulls available, specify and see page 9
- oval grommets in back panel can be eliminated upon request, no upcharge
- interior horizontal wire manager with end grommets available, specify and add \$180 list; see page 38 for details
- top grommet available, specify location; add \$128 list each; see page 45 for details
- worksurface power available, specify "to accommodate EC26" on your purchase order; EC26 unit must be ordered separately, see page 45

To Order, Specify:

① Laminate Model #	② Laminate Type	③ Laminate Selection	④ Metal Color	⑤ Other Product Options
Laminate (FLT)	HPL	See Laminate Selection	See Metal Finish Color Options	See list of options for each specific unit; Specify and add accordingly.

① Veneer Model #	② Wood Species	③ Wood Finish	④ Metal Color	⑤ Other Product Options
Veneer (FLV)	Flat Cut CH1 Cherry MA1 Maple WA1 Walnut BO1 Black Oak	See Flat Cut Wood Finish Options	See Metal Finish Color Options	See list of options for each specific unit; Specify and add accordingly.
		<table border="1"> <thead> <tr> <th>ⓐ Wood Finish</th> <th>ⓑ Chassis Grain Direction</th> </tr> </thead> <tbody> <tr> <td>See Double Cut Wood Finish Options</td> <td>For Double Cut Only: Vertical Horizontal</td> </tr> </tbody> </table>		
ⓐ Wood Finish	ⓑ Chassis Grain Direction			
See Double Cut Wood Finish Options	For Double Cut Only: Vertical Horizontal			

Description	D	W	H	CTN WT	CU FT	① Model	HPL Laminate	Flat Cut Veneer	Double Cut Veneer
Three Door Storage Credenza - Flush Legs	22	54	29	207	25	FLT2254-29L77R	\$2,921		
	22	54	29	207	25	FLV2254-29L77R		\$3,792	\$4,173
	22	54	29	207	25	FLT2254-29L77L	\$2,921		
	22	54	29	207	25	FLV2254-29L77L		\$3,792	\$4,173
	22	42	29	171	19	FLT2242-29L77R	\$2,798		
	22	42	29	171	19	FLV2242-29L77R		\$3,632	\$3,995
	22	42	29	171	19	FLT2242-29L77L	\$2,798		
	22	42	29	171	19	FLV2242-29L77L		\$3,632	\$3,995

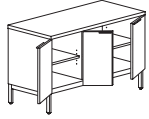

left shown



right

Features:

- eased edge profile user side
- each hinged door compartment has one adjustable shelf

Options:

- must specify chassis grain direction on double cut veneer, see pages 11-13 for details
- locking doors available, specify and add \$284 list
- veneer door fronts in paint available, specify paint color and add \$337 list; see page 14 for details
- on laminate units, contrasting worksurface tops and door fronts available, no upcharge; specify color, see page 14 for details
- ledge pulls standard; prism pulls available, specify and see page 9
- oval grommet in back panel can be eliminated upon request, no upcharge
- interior horizontal wire manager with end grommets available, specify and add \$180 list; see page 38 for details
- top grommet available, specify location; add \$128 list each; see page 45 for details
- worksurface power available, specify "to accommodate EC26" on your purchase order; EC26 unit must be ordered separately, see page 45

FLUX - PRIVATE OFFICE

Description	D	W	H	CTN WT	CU FT	① Model	HPL Laminate	Flat Cut Veneer	Double Cut Veneer
Two Door Storage - Flush Legs	22	36	29	144	17	FLT2236-29L7	\$2,688		
	22	36	29	144	17	FLV2236-29L7		\$3,490	\$3,837
	22	30	29	126	14	FLT2230-29L7	\$2,635		
	22	30	29	126	14	FLV2230-29L7		\$3,419	\$3,761



Features:

- eased edge profile user side
- hinged door compartment has one adjustable shelf

Options:

- must specify chassis grain direction on double cut veneer, see pages 11-13 for details
- locking doors available, specify and add \$142 list
- veneer door fronts in paint available, specify paint color and add \$337 list; see page 14 for details
- on laminate units, contrasting worksurface tops and door fronts available, no upcharge; specify color, see page 14 for details
- ledge pulls standard; prism pulls available, specify and see page 9
- oval grommet in back panel can be eliminated upon request, no upcharge
- interior horizontal wire manager with end grommets available, specify and add \$180 list; see page 38 for details
- top grommet available, specify location; add \$128 list each; see page 45 for details
- worksurface power available, specify "to accommodate EC26" on your purchase order; EC26 unit must be ordered separately, see page 45

To Order, Specify:

① Laminate Model #	② Laminate Type	③ Laminate Selection	④ Metal Color	⑤ Other Product Options
Laminate (FLT)	HPL	See Laminate Selection	See Metal Finish Color Options	See list of options for each specific unit; Specify and add accordingly.

① Veneer Model #	② Wood Species	③ Wood Finish	④ Metal Color	⑤ Other Product Options	
Veneer (FLV)	Flat Cut CH1 Cherry MA1 Maple WA1 Walnut BO1 Black Oak	See Flat Cut Wood Finish Options	See Metal Finish Color Options	See list of options for each specific unit; Specify and add accordingly.	
	Double Cut DC1 Double Cut	<table border="1"> <thead> <tr> <th>ⓐ Wood Finish</th> <th>ⓑ Chassis Grain Direction</th> </tr> </thead> <tbody> <tr> <td>See Double Cut Wood Finish Options</td> <td>For Double Cut Only: Vertical Horizontal</td> </tr> </tbody> </table>			ⓐ Wood Finish
ⓐ Wood Finish	ⓑ Chassis Grain Direction				
See Double Cut Wood Finish Options	For Double Cut Only: Vertical Horizontal				

Description	D	W	H	CTN WT	CU FT	① Model	HPL Laminate	Flat Cut Veneer	Double Cut Veneer
Box/Lateral with Open Storage Credenza - Flush Legs	22	96	29	352	43	FLT2296-29L606	\$3,966		
	22	96	29	352	43	FLV2296-29L606		\$5,150	\$5,666
	22	90	29	345	40	FLT2290-29L606	\$3,871		
	22	90	29	345	40	FLV2290-29L606		\$5,025	\$5,528

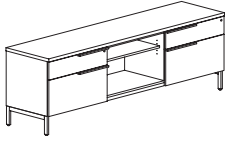

Features:

- eased edge profile user side
- pedestal front locking
- open compartment with adjustable shelf
- shelf 12 1/2"d

Options:

- must specify chassis grain direction on double cut veneer, see pages 11-13 for details
- concealed box drawer(s) available, specify location in unit; add \$234 list for each laminate drawer or \$357 for each veneer drawer, see page 23 for details
- veneer drawer fronts in paint available, specify paint color and add \$337 list; see page 14 for details
- on laminate units, contrasting worksurface tops and drawer fronts available, no upcharge; specify color, see page 14 for details
- ledge pulls standard; prism pulls available, specify and see page 9
- oval grommets in back panel can be eliminated upon request, no upcharge
- interior horizontal wire manager with end grommets available, specify and add \$180 list; see page 38 for details
- top grommet available, specify location; add \$128 list each; see page 45 for details
- worksurface power available, specify "to accommodate EC26" on your purchase order; EC26 unit must be ordered separately, see page 45

Box/Lateral File with Open Storage Credenza - Inset Legs	22	90	29	367	40	FLT2290-29S606	\$3,871		
	22	90	29	367	40	FLV2290-29S606		\$5,025	\$5,528

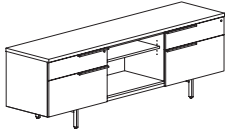

Features:

- eased edge profile user side
- pedestal front locking
- open compartment with adjustable shelf
- shelf 12 1/2"d

Options:

- must specify chassis grain direction on double cut veneer, see pages 11-13 for details
- concealed box drawer(s) available, specify location in unit; add \$234 list for each laminate drawer or \$357 for each veneer drawer, see page 23 for details
- veneer drawer fronts in paint available, specify paint color and add \$337 list; see page 14 for details
- on laminate units, contrasting worksurface tops and drawer fronts available, no upcharge; specify color, see page 14 for details
- ledge pulls standard; prism pulls available, specify and see page 9
- oval grommets in back panel can be eliminated upon request, no upcharge
- interior horizontal wire manager with end grommets available, specify and add \$180 list; see page 38 for details
- top grommet available, specify location; add \$128 list each; see page 45 for details
- worksurface power available, specify "to accommodate EC26" on your purchase order; EC26 unit must be ordered separately, see page 45

FLUX - PRIVATE OFFICE

Description	D	W	H	CTN WT	CU FT	① Model	HPL Laminate	Flat Cut Veneer	Double Cut Veneer
Box/Lateral with Open Storage Credenza - Flush Legs	22	96	29	320	43	FLT2296-29L060	\$3,727		
	22	96	29	320	43	FLV2296-29L060		\$4,840	\$5,324
	22	90	29	312	40	FLT2290-29L060	\$3,637		
	22	90	29	312	40	FLV2290-29L060		\$4,723	\$5,195

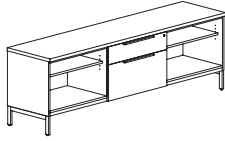

Features:

- eased edge profile user side
- pedestal front locking
- each open compartment has one adjustable shelf
- shelves 12 1/2"d

Options:

- must specify chassis grain direction on double cut veneer, see pages 11-13 for details
- concealed box drawer available, specify; add \$234 list for each laminate drawer or \$357 for each veneer drawer, see page 23 for details
- veneer drawer fronts in paint available, specify paint color and add \$337 list; see page 14 for details
- on laminate units, contrasting worksurface tops and drawer fronts available, no upcharge; specify color, see page 14 for details
- ledge pulls standard; prism pulls available, specify and see page 9
- oval grommets in back panel can be eliminated upon request, no upcharge
- interior horizontal wire manager with end grommets available, specify and add \$180 list; see page 38 for details
- top grommet available, specify location; add \$128 list each; see page 45 for details
- worksurface power available, specify "to accommodate EC26" on your purchase order; EC26 unit must be ordered separately, see page 45

Box/File with Open Storage Credenza - Inset Legs	22	90	29	330	40	FLT2290-29S060	\$3,637		
	22	90	29	330	40	FLV2290-29S060		\$4,723	\$5,195

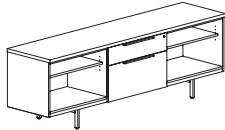

Features:

- eased edge profile user side
- pedestal front locking
- each open compartment has one adjustable shelf
- shelves 12 1/2"d

Options:

- must specify chassis grain direction on double cut veneer, see pages 11-13 for details
- concealed box drawer available, specify; add \$234 list for each laminate drawer or \$357 for each veneer drawer, see page 23 for details
- veneer drawer fronts in paint available, specify paint color and add \$337 list; see page 14 for details
- on laminate units, contrasting worksurface tops and drawer fronts available, no upcharge; specify color, see page 14 for details
- ledge pulls standard; prism pulls available, specify and see page 9
- oval grommets in back panel can be eliminated upon request, no upcharge
- interior horizontal wire manager with end grommets available, specify and add \$180 list; see page 38 for details
- top grommet available, specify location; add \$128 list each; see page 45 for details
- worksurface power available, specify "to accommodate EC26" on your purchase order; EC26 unit must be ordered separately, see page 45

To Order, Specify:

① Laminate Model #	② Laminate Type	③ Laminate Selection	④ Metal Color	⑤ Other Product Options
Laminate (FLT)	HPL	See Laminate Selection	See Metal Finish Color Options	See list of options for each specific unit; Specify and add accordingly.

① Veneer Model #	② Wood Species	③ Wood Finish	④ Metal Color	⑤ Other Product Options
Veneer (FLV)	Flat Cut CH1 Cherry MA1 Maple WA1 Walnut BO1 Black Oak	See Flat Cut Wood Finish Options	See Metal Finish Color Options	See list of options for each specific unit; Specify and add accordingly.
		<table border="1"> <thead> <tr> <th>ⓐ Wood Finish</th> <th>ⓑ Chassis Grain Direction</th> </tr> </thead> <tbody> <tr> <td>See Double Cut Wood Finish Options</td> <td>For Double Cut Only: Vertical Horizontal</td> </tr> </tbody> </table>		
ⓐ Wood Finish	ⓑ Chassis Grain Direction			
See Double Cut Wood Finish Options	For Double Cut Only: Vertical Horizontal			

Description	D	W	H	CTN WT	CU FT	① Model	HPL Laminate	Flat Cut Veneer	Double Cut Veneer
Box/Lateral File with Open Storage Credenza - Flush Legs	22	96	29	360	43	FLT2296-29L066	\$3,966		
	22	96	29	360	43	FLV2296-29L066		\$5,150	\$5,666
	22	96	29	360	43	FLT2296-29L660	\$3,966		
	22	96	29	360	43	FLV2296-29L660		\$5,150	\$5,666
	22	90	29	353	40	FLT2290-29L066	\$3,871		
	22	90	29	353	40	FLV2290-29L066		\$5,025	\$5,528
	22	90	29	353	40	FLT2290-29L660	\$3,871		
	22	90	29	353	40	FLV2290-29L660		\$5,025	\$5,528

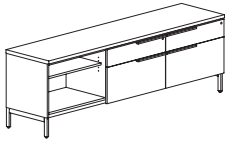

*066 shown

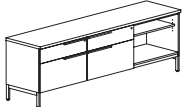

*660

Features:

- eased edge profile user side
- pedestal front locking
- open compartment with adjustable shelf
- shelf 12 1/2"d

Options:

- must specify chassis grain direction on double cut veneer, see pages 11-13 for details
- concealed box drawer(s) available, specify location in unit; add \$234 list for each laminate drawer or \$357 for each veneer drawer, see page 23 for details
- veneer drawer fronts in paint available, specify paint color and add \$337 list; see page 14 for details
- on laminate units, contrasting worksurface tops and drawer fronts available, no upcharge; specify color, see page 14 for details
- ledge pulls standard; prism pulls available, specify and see page 9
- oval grommets in back panel can be eliminated upon request, no upcharge
- interior horizontal wire manager with end grommets available, specify and add \$180 list; see page 38 for details
- top grommet available, specify location; add \$128 list each; see page 45 for details
- worksurface power available, specify "to accommodate EC26" on your purchase order; EC26 unit must be ordered separately, see page 45

Description	D	W	H	CTN WT	CU FT	① Model	HPL Laminate	Flat Cut Veneer	Double Cut Veneer
Box/Lateral File with Open Storage Credenza - Inset Legs	22	90	29	350	40	FLT2290-29S066	\$3,871		
	22	90	29	350	40	FLV2290-29S066		\$5,025	\$5,528
	22	90	29	350	40	FLT2290-29S660	\$3,871		
	22	90	29	350	40	FLV2290-29S660		\$5,025	\$5,528

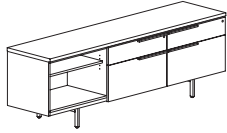

*066 shown

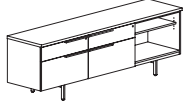

*660

Features:

- eased edge profile user side
- pedestal front locking
- open compartment with adjustable shelf
- shelf 12 1/2" d

Options:

- must specify chassis grain direction on double cut veneer, see pages 11-13 for details
- concealed box drawer(s) available, specify location in unit; add \$234 list for each laminate drawer or \$357 for each veneer drawer, see page 23 for details
- veneer drawer fronts in paint available, specify paint color and add \$337 list; see page 14 for details
- on laminate units, contrasting worksurface tops and drawer fronts available, no upcharge; specify color, see page 14 for details
- ledge pulls standard; prism pulls available, specify and see page 9
- oval grommets in back panel can be eliminated upon request, no upcharge
- interior horizontal wire manager with end grommets available, specify and add \$180 list; see page 38 for details
- top grommet available, specify location; add \$128 list each; see page 45 for details
- worksurface power available, specify "to accommodate EC26" on your purchase order; EC26 unit must be ordered separately, see page 45

To Order, Specify:

① Laminate Model #	② Laminate Type	③ Laminate Selection	④ Metal Color	⑤ Other Product Options
Laminate (FLT)	HPL	See Laminate Selection	See Metal Finish Color Options	See list of options for each specific unit; Specify and add accordingly.

① Veneer Model #	② Wood Species	③ Wood Finish	④ Metal Color	⑤ Other Product Options
Veneer (FLV)	Flat Cut CH1 Cherry MA1 Maple WA1 Walnut BO1 Black Oak	See Flat Cut Wood Finish Options	See Metal Finish Color Options	See list of options for each specific unit; Specify and add accordingly.
		<table border="1"> <thead> <tr> <th>3a Wood Finish</th> <th>3b Chassis Grain Direction</th> </tr> </thead> <tbody> <tr> <td>See Double Cut Wood Finish Options</td> <td>For Double Cut Only: Vertical Horizontal</td> </tr> </tbody> </table>		
3a Wood Finish	3b Chassis Grain Direction			
See Double Cut Wood Finish Options	For Double Cut Only: Vertical Horizontal			

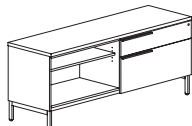
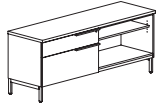
Description	D	W	H	CTN WT	CU FT	① Model	HPL Laminate	Flat Cut Veneer	Double Cut Veneer
Box/Lateral File with Open	22	72	29	265	32	FLT2272-29L06	\$3,189		
Storage Credenza - Flush Legs	22	72	29	265	32	FLV2272-29L06		\$4,139	\$4,551
	22	72	29	265	32	FLT2272-29L60	\$3,189		
	22	72	29	265	32	FLV2272-29L60		\$4,139	\$4,551
	22	66	29	238	30	FLT2266-29L06	\$3,060		
	22	66	29	238	30	FLV2266-29L06		\$3,973	\$4,370
*06 shown	22	66	29	238	30	FLT2266-29L60	\$3,060		
	22	66	29	238	30	FLV2266-29L60		\$3,973	\$4,370
	22	60	29	238	27	FLT2260-29L06	\$2,935		
	22	60	29	238	27	FLV2260-29L06		\$3,810	\$4,191
*60	22	60	29	228	27	FLT2260-29L60	\$2,935		
	22	60	29	228	27	FLV2260-29L60		\$3,810	\$4,191

Features:

- eased edge profile user side
- pedestal front locking
- open compartment with adjustable shelf
- shelf 12 1/2"d

Options:

- must specify chassis grain direction on double cut veneer, see pages 11-13 for details
- concealed box drawer available, specify; add \$234 list for each laminate drawer or \$357 for each veneer drawer, see page 23 for details
- veneer drawer fronts in paint available, specify paint color and add \$337 list; see page 14 for details
- on laminate units, contrasting worksurface tops and drawer fronts available, no upcharge; specify color, see page 14 for details
- ledge pulls standard; prism pulls available, specify and see page 9
- oval grommets in back panel can be eliminated upon request, no upcharge
- interior horizontal wire manager with end grommets available, specify and add \$180 list; see page 38 for details
- top grommet available, specify location; add \$128 list each; see page 45 for details
- worksurface power available, specify "to accommodate EC26" on your purchase order; EC26 unit must be ordered separately, see page 45

Description	D	W	H	CTN WT	CU FT	① Model	HPL Laminate	Flat Cut Veneer	Double Cut Veneer
Box/Lateral File with Open Storage Credenza - Inset Legs	22	72	29	265	32	FLT2272-29S06	\$3,189		
	22	72	29	265	32	FLV2272-29S06		\$4,139	\$4,551
	22	72	29	265	32	FLT2272-29S60	\$3,189		
	22	72	29	265	32	FLV2272-29S60		\$4,139	\$4,551
	22	60	29	226	27	FLT2260-29S06	\$2,935		
	22	60	29	226	27	FLV2260-29S06		\$3,810	\$4,191
	22	60	29	226	27	FLT2260-29S60	\$2,935		
	22	60	29	226	27	FLV2260-29S60		\$3,810	\$4,191

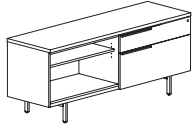

*06 shown

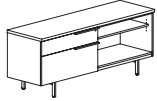

*60

Features:

- eased edge profile user side
- pedestal front locking
- open compartment with adjustable shelf
- shelf 12 1/2" d

Options:

- must specify chassis grain direction on double cut veneer, see pages 11-13 for details
- concealed box drawer available, specify; add \$234 list for each laminate drawer or \$357 for each veneer drawer, see page 23 for details
- veneer drawer fronts in paint available, specify paint color and add \$337 list; see page 14 for details
- on laminate units, contrasting worksurface tops and drawer fronts available, no upcharge; specify color, see page 14 for details
- ledge pulls standard; prism pulls available, specify and see page 9
- oval grommets in back panel can be eliminated upon request, no upcharge
- interior horizontal wire manager with end grommets available, specify and add \$180 list; see page 38 for details
- top grommet available, specify location; add \$128 list each; see page 45 for details
- worksurface power available, specify "to accommodate EC26" on your purchase order; EC26 unit must be ordered separately, see page 45

To Order, Specify:

① Laminate Model #	② Laminate Type	③ Laminate Selection	④ Metal Color	⑤ Other Product Options
Laminate (FLT)	HPL	See Laminate Selection	See Metal Finish Color Options	See list of options for each specific unit; Specify and add accordingly.

① Veneer Model #	② Wood Species	③ Wood Finish	④ Metal Color	⑤ Other Product Options
Veneer (FLV)	Flat Cut CH1 Cherry MA1 Maple WA1 Walnut BO1 Black Oak	See Flat Cut Wood Finish Options	See Metal Finish Color Options	See list of options for each specific unit; Specify and add accordingly.
		<table border="1"> <thead> <tr> <th>③a Wood Finish</th> <th>③b Chassis Grain Direction</th> </tr> </thead> <tbody> <tr> <td>See Double Cut Wood Finish Options</td> <td>For Double Cut Only: Vertical Horizontal</td> </tr> </tbody> </table>		
③a Wood Finish	③b Chassis Grain Direction			
See Double Cut Wood Finish Options	For Double Cut Only: Vertical Horizontal			

Description	D	W	H	CTN WT	CU FT	① Model	HPL Laminate	Flat Cut Veneer	Double Cut Veneer
Double Sliding Door Credenza - Flush Legs	22	90	29	336	40	FLT2290-29L909	\$3,459		
	22	90	29	336	40	FLV2290-29L909		\$4,488	\$4,939

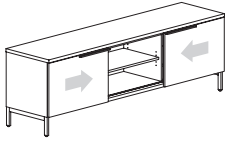

Features:

- eased edge profile user side
- locking doors not available
- open compartment with adjustable shelf
- shelves 12 1/2" d

Options:

- must specify chassis grain direction on double cut veneer, see pages 11-13 for details
- veneer door fronts in paint available, specify paint color and add \$337 list; see page 14 for details
- on laminate units, contrasting worksurface tops and door fronts available, no upcharge; specify color, see page 14 for details
- ledge pulls standard; prism pulls available, specify and see page 9
- oval grommets in back panel can be eliminated upon request, no upcharge
- interior horizontal wire manager with end grommets available, specify and add \$180 list; see page 38 for details
- top grommet available, specify location; add \$128 list each; see page 45 for details
- worksurface power available, specify "to accommodate EC26" on your purchase order; EC26 unit must be ordered separately, see page 45

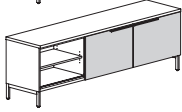
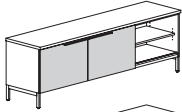

Double Sliding Door Credenza - Inset Legs	22	90	29	333	40	FLT2290-29S909	\$3,459		
	22	90	29	333	40	FLV2290-29S909		\$4,488	\$4,939

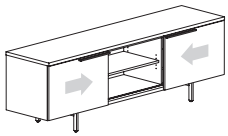

Features:

- eased edge profile user side
- locking doors not available
- open compartment with adjustable shelf
- shelves 12 1/2" d

Options:

- must specify chassis grain direction on double cut veneer, see pages 11-13 for details
- veneer door fronts in paint available, specify paint color and add \$337 list; see page 14 for details
- on laminate units, contrasting worksurface tops and door fronts available, no upcharge; specify color, see page 14 for details
- ledge pulls standard; prism pulls available, specify and see page 9
- oval grommets in back panel can be eliminated upon request, no upcharge
- interior horizontal wire manager with end grommets available, specify and add \$180 list; see page 38 for details
- top grommet available, specify location; add \$128 list each; see page 45 for details
- worksurface power available, specify "to accommodate EC26" on your purchase order; EC26 unit must be ordered separately, see page 45

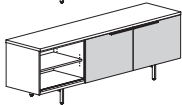
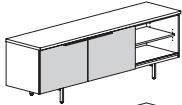

Description	D	W	H	CTN WT	CU FT	① Model	HPL Laminate	Flat Cut Veneer	Double Cut Veneer
Sliding Door Credenza - Flush Legs	22	90	29	319	40	FLT2290-29L090	\$3,317		
	22	90	29	319	40	FLV2290-29L090		\$4,307	\$4,739

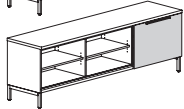
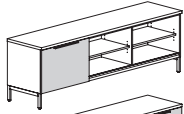
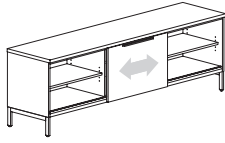

Features:

- eased edge profile user side
- locking door not available
- open compartment with adjustable shelf
- shelves 12 1/2"d

Options:

- must specify chassis grain direction on double cut veneer, see pages 11-13 for details
- veneer door fronts in paint available, specify paint color and add \$337 list; see page 14 for details
- on laminate units, contrasting worksurface tops and door fronts available, no upcharge; specify color, see page 14 for details
- ledge pulls standard; prism pulls available, specify and see page 9
- oval grommets in back panel can be eliminated upon request, no upcharge
- interior horizontal wire manager with end grommets available, specify and add \$180 list; see page 38 for details
- top grommet available, specify location; add \$128 list each; see page 45 for details
- worksurface power available, specify "to accommodate EC26" on your purchase order; EC26 unit must be ordered separately, see page 45

Sliding Door Credenza - Flush Legs	22	90	29	316	40	FLT2290-29S090	\$3,317		
	22	90	29	316	40	FLV2290-29S090		\$4,307	\$4,739

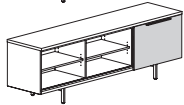
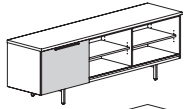
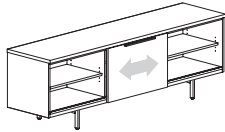

Features:

- eased edge profile user side
- locking door not available
- open compartment with adjustable shelf
- shelves 12 1/2"d

Options:

- must specify chassis grain direction on double cut veneer, see pages 11-13 for details
- veneer door fronts in paint available, specify paint color and add \$337 list; see page 14 for details
- on laminate units, contrasting worksurface tops and door fronts available, no upcharge; specify color, see page 14 for details
- ledge pulls standard; prism pulls available, specify and see page 9
- oval grommets in back panel can be eliminated upon request, no upcharge
- interior horizontal wire manager with end grommets available, specify and add \$180 list; see page 38 for details
- top grommet available, specify location; add \$128 list each; see page 45 for details
- worksurface power available, specify "to accommodate EC26" on your purchase order; EC26 unit must be ordered separately, see page 45

To Order, Specify:

① Laminate Model #	② Laminate Type	③ Laminate Selection	④ Metal Color	⑤ Other Product Options
Laminate (FLT)	HPL	See Laminate Selection	See Metal Finish Color Options	See list of options for each specific unit; Specify and add accordingly.

① Veneer Model #	② Wood Species	③ Wood Finish	④ Metal Color	⑤ Other Product Options
Veneer (FLV)	Flat Cut CH1 Cherry MA1 Maple WA1 Walnut BO1 Black Oak	See Flat Cut Wood Finish Options	See Metal Finish Color Options	See list of options for each specific unit; Specify and add accordingly.
		③a Wood Finish See Double Cut Wood Finish Options		

Description	D	W	H	CTN WT	CU FT	① Model	HPL Laminate	Flat Cut Veneer	Double Cut Veneer
Sliding Door Credenza - Flush Legs	22	72	29	250	32	FLT2272-29L09	\$2,975		
	22	72	29	250	32	FLV2272-29L09		\$3,863	\$4,250
	22	60	29	215	27	FLT2260-29L09	\$2,838		
	22	60	29	215	27	FLV2260-29L09		\$3,685	\$4,052

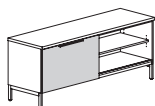
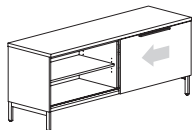

Features:

- eased edge profile user side
- locking door not available
- each compartment has one adjustable shelf
- shelves 12 1/2"d

Options:

- must specify chassis grain direction on double cut veneer, see pages 11-13 for details
- veneer door fronts in paint available, specify paint color and add \$337 list; see page 14 for details
- on laminate units, contrasting worksurface tops and door fronts available, no upcharge; specify color, see page 14 for details
- ledge pulls standard; prism pulls available, specify and see page 9
- oval grommets in back panel can be eliminated upon request, no upcharge
- interior horizontal wire manager with end grommets available, specify and add \$180 list; see page 38 for details
- top grommet available, specify location; add \$128 list each; see page 45 for details
- worksurface power available, specify "to accommodate EC26" on your purchase order; EC26 unit must be ordered separately, see page 45

Sliding Door Credenza - Inset Legs	22	72	29	244	32	FLT2272-29S09	\$2,975		
	22	72	29	244	32	FLV2272-29S09		\$3,863	\$4,250
	22	60	29	210	27	FLT2260-29S09	\$2,838		
	22	60	29	210	27	FLV2260-29S09		\$3,685	\$4,052

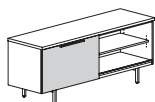
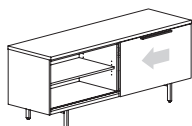

Features:

- eased edge profile user side
- locking door not available
- each compartment has one adjustable shelf
- shelves 12 1/2"d

Options:

- must specify chassis grain direction on double cut veneer, see pages 11-13 for details
- veneer door fronts in paint available, specify paint color and add \$337 list; see page 14 for details
- on laminate units, contrasting worksurface tops and door fronts available, no upcharge; specify color, see page 14 for details
- ledge pulls standard; prism pulls available, specify and see page 9
- oval grommets in back panel can be eliminated upon request, no upcharge
- interior horizontal wire manager with end grommets available, specify and add \$180 list; see page 38 for details
- top grommet available, specify location; add \$128 list each; see page 45 for details
- worksurface power available, specify "to accommodate EC26" on your purchase order; EC26 unit must be ordered separately, see page 45

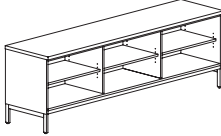
Description	D	W	H	CTN WT	CU FT	① Model	HPL Laminate	Flat Cut Veneer	Double Cut Veneer
Open Compartment Credenza - Flush Legs 	22	96	29	310	43	FLT2296-29L000	\$3,147		
	22	96	29	310	43	FLV2296-29L000		\$4,087	\$4,494
	22	90	29	301	40	FLT2290-29L000	\$3,075		
	22	90	29	301	40	FLV2290-29L000		\$3,992	\$4,393

Features:

- eased edge profile user side
- each open compartment has one adjustable shelf
- shelves 12 1/2"d

Options:

- must specify chassis grain direction on double cut veneer, see pages 11-13 for details
- contrasting laminate worksurface tops, no upcharge; specify laminate color, see page 14 for details
- oval grommets in back panel can be eliminated upon request, no upcharge
- interior horizontal wire manager with end grommets available, specify and add \$180 list; see page 38 for details
- top grommet available, specify location and add \$128 list each; see page 45 for details

Open Compartment Credenza - Flush Legs 	22	72	29	230	32	FLT2272-29L00	\$2,838		
	22	72	29	230	32	FLV2272-29L00		\$3,685	\$4,052
	22	60	29	199	27	FLT2260-29L00	\$2,710		
	22	60	29	199	27	FLV2260-29L00		\$3,516	\$3,869

Features:

- eased edge profile user side
- each open compartment has one adjustable shelf
- shelves 12 1/2"d

Options:

- must specify chassis grain direction on double cut veneer, see pages 11-13 for details
- contrasting laminate worksurface tops, no upcharge; specify laminate color, see page 14 for details
- oval grommets in back panel can be eliminated upon request, no upcharge
- interior horizontal wire manager with end grommets available, specify and add \$180 list; see page 38 for details
- top grommet available, specify location and add \$128 list each; see page 45 for details

Open Compartment - Flush Legs 	22	36	29	136	17	FLT2236-29L0	\$2,042		
	22	36	29	136	17	FLV2236-29L0		\$2,650	\$2,914
	22	30	29	111	14	FLT2230-29L0	\$1,983		
	22	30	29	111	14	FLV2230-29L0		\$2,573	\$2,832

Features:

- eased edge profile user side
- open compartment with adjustable shelf
- shelves 12 1/2"d

Options:

- must specify chassis grain direction on double cut veneer, see pages 11-13 for details
- contrasting laminate worksurface tops, no upcharge; specify laminate color, see page 14 for details
- oval grommets in back panel can be eliminated upon request, no upcharge
- interior horizontal wire manager with end grommets available, specify and add \$180 list; see page 38 for details
- top grommet available, specify location and add \$128 list each; see page 45 for details

To Order, Specify:

① Laminate Model #	② Laminate Type	③ Laminate Selection	④ Metal Color	⑤ Other Product Options
Laminate (FLT)	TFL	See Laminate Selection	See Metal Finish Color Options	See list of options for each specific unit; Specify and add accordingly.
	HLP			
① Veneer Model #	② Wood Species	③ Wood Finish	④ Metal Color	⑤ Other Product Options
Veneer (FLV)	Flat Cut CH1 Cherry MA1 Maple WA1 Walnut BO1 Black Oak	See Flat Cut Wood Finish Options	See Metal Finish Color Options	See list of options for each specific unit; Specify and add accordingly.
	Double Cut DC1 Double Cut	③a Wood Finish See Double Cut Wood Finish Options		

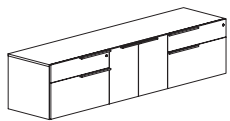
Description	D	W	H	CTN WT	CU FT	① Model	HPL Laminate	Flat Cut Veneer	Double Cut Veneer
Storage Credenza 	22	96	21	350	32	FLT2296-21F676	\$2,696		
	22	96	21	350	32	FLV2296-21F676		\$3,765	\$4,143
	22	90	21	335	30	FLT2290-21F676	\$2,633		
	22	90	21	335	30	FLV2290-21F676		\$3,674	\$4,041
	22	84	21	311	28	FLT2284-21F676	\$2,568		
	22	84	21	311	28	FLV2284-21F676		\$3,585	\$3,944

Features:

- pedestal front locking
- hinged door compartment has one adjustable shelf

Options:

- must specify chassis grain direction on double cut veneer, see pages 11-13 for details
- concealed box drawer(s) available, specify location in unit; add \$234 list for each laminate drawer or \$357 for each veneer drawer, see page 23 for details
- locking doors available, specify and add \$142 list
- veneer door and drawer fronts in paint available, specify paint color and add \$337; see page 14 for details
- on laminate units, contrasting door and drawer fronts available, no upcharge; specify color, see page 14 for details
- ledge pulls standard; prism pulls available, specify and see page 9
- oval grommets in back panel can be eliminated upon request, no upcharge
- oval or rectangular seat cushion available, see page 23 for more details and page 212 for pricing
- interior horizontal wire manager with end grommets available, specify and add \$180 list; see page 38 for details
- top grommet available, specify location; add \$128 list each; see page 45 for details
- worksurface power available, specify "to accommodate EC26" on your purchase order; EC26 unit must be ordered separately, see page 45

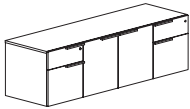
Description	D	W	H	CTN WT	CU FT	① Model	HPL Laminate	Flat Cut Veneer	Double Cut Veneer
	22	78	21	310	26	FLT2278-21F575	\$2,168		
	22	78	21	310	26	FLV2278-21F575		\$3,025	\$3,329
	22	72	21	288	24	FLT2272-21F575	\$2,114		
	22	72	21	288	24	FLV2272-21F575		\$2,951	\$3,246
	22	66	21	273	22	FLT2266-21F575	\$2,072		
	22	66	21	273	22	FLV2266-21F575		\$2,893	\$3,182
	22	60	21	257	20	FLT2260-21F575	\$2,033		
	22	60	21	257	20	FLV2260-21F575		\$2,834	\$3,120

Features:

- pedestal front locking
- hinged door compartment has one adjustable shelf

Options:

- must specify chassis grain direction on double cut veneer, see pages 11-13 for details
- locking doors available, specify and add \$142 list
- veneer door and drawer fronts in paint available, specify paint color and add \$337; see page 14 for details
- on laminate units, contrasting door and drawer fronts available, no upcharge; specify color, see page 14 for details
- ledge pulls standard; prism pulls available, specify and see page 9
- oval grommets in back panels can be eliminated upon request, no upcharge
- oval or rectangular seat cushion available, see page 23 for more details and page 212 for pricing
- interior horizontal wire manager with end grommets available, specify and add \$180 list; see page 38 for details
- top grommet available, specify location; add \$128 list each; see page 45 for details
- worksurface power available, specify "to accommodate EC26" on your purchase order; EC26 unit must be ordered separately, see page 45

FLUX - PRIVATE OFFICE

To Order, Specify:

① Laminate Model #	② Laminate Type	③ Laminate Selection	④ Metal Color	⑤ Other Product Options
Laminate (FLT)	HPL	See Laminate Selection	See Metal Finish Color Options	See list of options for each specific unit; Specify and add accordingly.

① Veneer Model #	② Wood Species	③ Wood Finish	④ Metal Color	⑤ Other Product Options
Veneer (FLV)	Flat Cut CH1 Cherry MA1 Maple WA1 Walnut BO1 Black Oak	See Flat Cut Wood Finish Options	See Metal Finish Color Options	See list of options for each specific unit; Specify and add accordingly.
		<table border="1"> <thead> <tr> <th>③a Wood Finish</th> <th>③b Chassis Grain Direction</th> </tr> </thead> <tbody> <tr> <td>See Double Cut Wood Finish Options</td> <td>For Double Cut Only: Vertical Horizontal</td> </tr> </tbody> </table>		
③a Wood Finish	③b Chassis Grain Direction			
See Double Cut Wood Finish Options	For Double Cut Only: Vertical Horizontal			

Description	D	W	H	CTN WT	CU FT	① Model	HPL Laminate	Flat Cut Veneer	Double Cut Veneer
Box/Lateral File Credenza	22	90	21	371	30	FLT2290-21F666	\$3,055		
	22	90	21	371	30	FLV2290-21F666		\$4,266	\$4,693

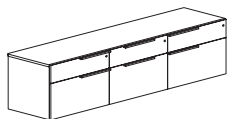

Features:

- pedestal front locking

Options:

- must specify chassis grain direction on double cut veneer, see pages 11-13 for details
- concealed box drawer(s) available, specify location in unit; add \$234 list for each laminate drawer or \$357 for each veneer drawer, see page 23 for details
- veneer drawer fronts in paint available, specify paint color and add \$337 list; see page 14 for details
- on laminate units, contrasting fronts available, no upcharge; specify color, see page 14 for details
- ledge pulls standard; prism pulls available, specify and see page 9
- oval grommets in back panel can be eliminated upon request, no upcharge
- oval or rectangular seat cushion available, see page 23 for more details and page 212 for pricing
- interior horizontal wire manager with end grommets available, specify and add \$180 list; see page 38 for details
- top grommet available, specify location; add \$128 list each; see page 45 for details

Box/Lateral File Credenza	22	72	21	289	24	FLT2272-21F66	\$2,274		
	22	72	21	289	24	FLV2272-21F66		\$3,174	\$3,492
	22	60	21	251	20	FLT2260-21F66	\$2,183		
	22	60	21	251	20	FLV2260-21F66		\$3,049	\$3,353

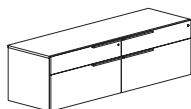

Features:

- pedestal front locking

Options:

- must specify chassis grain direction on double cut veneer, see pages 11-13 for details
- concealed box drawer(s) available, specify location in unit; add \$234 list for each laminate drawer or \$357 for each veneer drawer, see page 23 for details
- veneer drawer fronts in paint available, specify paint color and add \$337 list; see page 14 for details
- on laminate units, contrasting fronts available, no upcharge; specify color, see page 14 for details
- ledge pulls standard; prism pulls available, specify and see page 9
- oval grommets in back panel can be eliminated upon request, no upcharge
- oval or rectangular seat cushion available, see page 23 for more details and page 212 for pricing
- interior horizontal wire manager with end grommets available, specify and add \$180 list; see page 38 for details
- top grommet available, specify location; add \$128 list each; see page 45 for details

Description	D	W	H	CTN WT	CU FT	① Model	HPL Laminate	Flat Cut Veneer	Double Cut Veneer
 Box/Lateral File Pedestal	22	36	21	146	13	FLT2236-21F6	\$1,322		
	22	36	21	146	13	FLV2236-21F6		\$1,845	\$2,030
	22	30	21	126	11	FLT2230-21F6	\$1,291		
	22	30	21	126	11	FLV2230-21F6		\$1,799	\$1,981

Features:

- pedestal front locking

Options:

- must specify chassis grain direction on double cut veneer, see pages 11-13 for details
- concealed box drawer available, specify; add \$234 list for each laminate drawer or \$357 for each veneer drawer, see page 23 for details
- veneer drawer fronts in paint available, specify paint color and add \$337 list; see page 14 for details
- on laminate units, contrasting fronts available, no upcharge; specify color, see page 14 for details
- ledge pulls standard; prism pulls available, specify and see page 9
- oval grommet in back panel can be eliminated upon request, no upcharge
- oval or rectangular seat cushion available, see page 23 for more details and page 212 for pricing
- interior horizontal wire manager with end grommets available, specify and add \$180 list; see page 38 for details
- top grommet available, specify location; add \$128 list each; see page 45 for details

To Order, Specify:

① Laminate Model #	② Laminate Type	③ Laminate Selection	④ Metal Color	⑤ Other Product Options
Laminate (FLT)	HPL	See Laminate Selection	See Metal Finish Color Options	See list of options for each specific unit; Specify and add accordingly.

① Veneer Model #	② Wood Species	③ Wood Finish	④ Metal Color	⑤ Other Product Options
Veneer (FLV)	Flat Cut CH1 Cherry MA1 Maple WA1 Walnut BO1 Black Oak	See Flat Cut Wood Finish Options	See Metal Finish Color Options	See list of options for each specific unit; Specify and add accordingly.
	Double Cut DC1 Double Cut	③a Wood Finish See Double Cut Wood Finish Options		

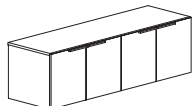
Description	D	W	H	CTN WT	CU FT	① Model	HPL Laminate	Flat Cut Veneer	Double Cut Veneer
	22	78	21	254	26	FLT2278-21F77	\$1,874		
	22	78	21	254	26	FLV2278-21F77		\$2,755	\$3,027
	22	72	21	238	24	FLT2272-21F77	\$1,828		
	22	72	21	238	24	FLV2272-21F77		\$2,687	\$2,955
	22	66	21	220	22	FLT2266-21F77	\$1,755		
	22	66	21	220	22	FLV2266-21F77		\$2,579	\$2,837
	22	60	21	205	20	FLT2260-21F77	\$1,686		
	22	60	21	205	20	FLV2260-21F77		\$2,477	\$2,723



Features:

- each hinged door compartment has one adjustable shelf

Options:

- must specify chassis grain direction on double cut veneer, see pages 11-13 for details
- locking doors available, specify and add \$284 list
- veneer door fronts in paint available, specify paint color and add \$337 list; see page 14 for details
- on laminate units, contrasting laminate door fronts available, no upcharge; specify laminate color, see page 14 for details
- ledge pulls standard; prism pulls available, specify and see page 9
- oval grommets in back panel can be eliminated upon request, no upcharge
- oval or rectangular seat cushion available, see page 23 for more details and page 212 for pricing
- interior horizontal wire manager with end grommets available, specify and add \$180 list; see page 38 for details
- top grommet available, specify location; add \$128 list each; see page 45 for details
- worksurface power available, specify "to accommodate EC26" on your purchase order; EC26 unit must be ordered separately, see page 45

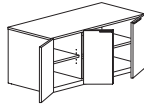
FLUX - PRIVATE OFFICE

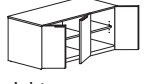
Description	D	W	H	CTN WT	CU FT	① Model	HPL Laminate	Flat Cut Veneer	Double Cut Veneer
  left shown   right	22	54	21	188	18	FLT2254-21F77R	\$1,534		
	22	54	21	188	18	FLV2254-21F77R		\$2,254	\$2,480
	22	54	21	185	18	FLT2254-21F77L	\$1,534		
	22	54	21	185	18	FLV2254-21F77L		\$2,254	\$2,480
	22	48	21	169	16	FLT2248-21F77R	\$1,456		
	22	48	21	169	16	FLV2248-21F77R		\$2,143	\$2,356
	22	48	21	163	16	FLT2248-21F77L	\$1,456		
	22	48	21	163	16	FLV2248-21F77L		\$2,143	\$2,356
	22	42	21	153	15	FLT2242-21F77R	\$1,383		
	22	42	21	153	15	FLV2242-21F77R		\$2,035	\$2,238
	22	42	21	150	15	FLT2242-21F77L	\$1,383		
	22	42	21	150	15	FLV2242-21F77L		\$2,035	\$2,238

Features:

- each hinged door compartment has one adjustable shelf

Options:

- must specify chassis grain direction on double cut veneer, see pages 11-13 for details
- locking doors available, specify and add \$426 list
- veneer door fronts in paint available, specify paint color and add \$337 list; see page 14 for details
- on laminate units, contrasting laminate door fronts available, no upcharge; specify laminate color, see page 14 for details
- ledge pulls standard; prism pulls available, specify and see page 9
- oval grommet in back panel can be eliminated upon request, no upcharge
- oval or rectangular seat cushion available, see page 23 for more details and page 212 for pricing
- interior horizontal wire manager with end grommets available, specify and add \$180 list; see page 38 for details
- top grommet available, specify location; add \$128 list each; see page 45 for details
- worksurface power available, specify "to accommodate EC26" on your purchase order; EC26 unit must be ordered separately, see page 45

Description	D	W	H	CTN WT	CU FT	① Model	HPL Laminate	Flat Cut Veneer	Double Cut Veneer
Two Door Storage	22	36	21	127	13	FLT2236-21F7	\$986		
	22	36	21	127	13	FLV2236-21F7		\$1,446	\$1,591
	22	30	21	109	11	FLT2230-21F7	\$946		
	22	30	21	109	11	FLV2230-21F7		\$1,386	\$1,527

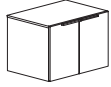

Features:

- compartment has one adjustable shelf

Options:

- must specify chassis grain direction on double cut veneer, see pages 11-13 for details
- locking doors available, specify and add \$142 list
- veneer door fronts in paint available, specify paint color and add \$337 list; see page 14 for details
- on laminate units, contrasting laminate door fronts available, no upcharge; specify laminate color, see page 14 for details
- ledge pulls standard; prism pulls available, specify and see page 9
- oval grommets in back panel can be eliminated upon request, no upcharge
- oval or rectangular seat cushion available, see page 23 for more details and page 212 for pricing
- interior horizontal wire manager with end grommets available, specify and add \$180 list; see page 38 for details
- top grommet available, specify location; add \$128 list each; see page 45 for details
- worksurface power available, specify "to accommodate EC26" on your purchase order; EC26 unit must be ordered separately, see page 45

To Order, Specify:

① Laminate Model #	② Laminate Type	③ Laminate Selection	④ Metal Color	⑤ Other Product Options
Laminate (FLT)	HPL	See Laminate Selection	See Metal Finish Color Options	See list of options for each specific unit; Specify and add accordingly.

① Veneer Model #	② Wood Species	③ Wood Finish	④ Metal Color	⑤ Other Product Options	
Veneer (FLV)	Flat Cut CH1 Cherry MA1 Maple WA1 Walnut BO1 Black Oak	See Flat Cut Wood Finish Options	See Metal Finish Color Options	See list of options for each specific unit; Specify and add accordingly.	
	Double Cut DC1 Double Cut	<table border="1"> <thead> <tr> <th>ⓐ Wood Finish</th> <th>ⓑ Chassis Grain Direction</th> </tr> </thead> <tbody> <tr> <td>See Double Cut Wood Finish Options</td> <td>For Double Cut Only: Vertical Horizontal</td> </tr> </tbody> </table>			ⓐ Wood Finish
ⓐ Wood Finish	ⓑ Chassis Grain Direction				
See Double Cut Wood Finish Options	For Double Cut Only: Vertical Horizontal				

Description	D	W	H	CTN WT	CU FT	① Model	HPL Laminate	Flat Cut Veneer	Double Cut Veneer
Box/Lateral File with Open Storage Credenza	22	96	21	327	32	FLT2296-21F606	\$2,836		
	22	96	21	327	32	FLV2296-21F606		\$3,959	\$4,355
	22	90	21	323	30	FLT2290-21F606	\$2,755		
	22	90	21	323	30	FLV2290-21F606		\$3,844	\$4,228

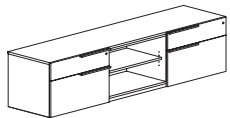

Features:

- pedestal front locking
- compartment has one adjustable shelf
- shelves 12 1/2" d

Options:

- must specify chassis grain direction on double cut veneer, see pages 11-13 for details
- peninsula desk mounting must be specified when ordering secondary credenza; see page 17 for details
- concealed box drawer(s) available, specify location in unit; add \$234 list for each laminate drawer or \$357 for each veneer drawer, see page 23 for details
- veneer drawer fronts in paint available, specify paint color and add \$337 list; see page 14 for details
- on laminate units, contrasting fronts available, no upcharge; specify color, see page 14 for details
- ledge pulls standard; prism pulls available, specify and see page 9
- oval grommets in back panel can be eliminated upon request, no upcharge
- oval or rectangular seat cushion available, see page 23 for more details and page 212 for pricing
- interior horizontal wire manager with end grommets available, specify and add \$180 list; see page 38 for details
- top grommet available, specify location; add \$128 list each; see page 45 for details
- worksurface power available, specify "to accommodate EC26" on your purchase order; EC26 unit must be ordered separately, see page 45

Description	D	W	H	CTN WT	CU FT	① Model	HPL Laminate	Flat Cut Veneer	Double Cut Veneer
Box/Lateral File with Open Storage Credenza	22	96	21	291	32	FLT2296-21F060	\$2,634		
	22	96	21	291	32	FLV2296-21F060		\$3,677	\$4,043
	22	90	21	288	30	FLT2290-21F060	\$2,559		
	22	90	21	288	30	FLV2290-21F060		\$3,569	\$3,925

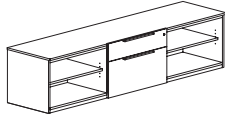

Features:

- pedestal front locking
- each open compartment has one adjustable shelf
- shelves 12 1/2" d

Options:

- must specify chassis grain direction on double cut veneer, see pages 11-13 for details
- peninsula desk mounting must be specified when ordering secondary credenza; see page 17 for details
- concealed box drawer available, specify; add \$234 list for each laminate drawer or \$357 for each veneer drawer, see page 23 for details
- veneer drawer fronts in paint available, specify paint color and add \$337 list; see page 14 for details
- on laminate units, contrasting fronts available, no upcharge; specify color, see page 14 for details
- ledge pulls standard; prism pulls available, specify and see page 9
- oval grommets in back panel can be eliminated upon request, no upcharge
- oval or rectangular seat cushion available, see page 23 for more details and page 212 for pricing
- interior horizontal wire manager with end grommets available, specify and add \$180 list; see page 38 for details
- top grommet available, specify location; add \$128 list each; see page 45 for details
- worksurface power available, specify "to accommodate EC26" on your purchase order; EC26 unit must be ordered separately, see page 45

To Order, Specify:

① Laminate Model #	② Laminate Type	③ Laminate Selection	④ Metal Color	⑤ Other Product Options
Laminate (FLT)	HPL	See Laminate Selection	See Metal Finish Color Options	See list of options for each specific unit; Specify and add accordingly.

① Veneer Model #	② Wood Species	③ Wood Finish	④ Metal Color	⑤ Other Product Options	
Veneer (FLV)	Flat Cut CH1 Cherry MA1 Maple WA1 Walnut BO1 Black Oak	See Flat Cut Wood Finish Options	See Metal Finish Color Options	See list of options for each specific unit; Specify and add accordingly.	
	Double Cut DC1 Double Cut	<table border="1"> <thead> <tr> <th>③a Wood Finish</th> <th>③b Chassis Grain Direction</th> </tr> </thead> <tbody> <tr> <td>See Double Cut Wood Finish Options</td> <td>For Double Cut Only: Vertical Horizontal</td> </tr> </tbody> </table>			③a Wood Finish
③a Wood Finish	③b Chassis Grain Direction				
See Double Cut Wood Finish Options	For Double Cut Only: Vertical Horizontal				

Description	D	W	H	CTN WT	CU FT	① Model	HPL Laminate	Flat Cut Veneer	Double Cut Veneer
Box/Lateral File with Open Storage Credenza	22	96	21	364	32	FLT2296-21F066	\$2,836		
	22	96	21	364	32	FLV2296-21F066		\$3,959	\$4,355
	22	96	21	332	32	FLT2296-21F660	\$2,836		
	22	96	21	332	32	FLV2296-21F660		\$3,959	\$4,355
	22	90	21	320	30	FLT2290-21F066	\$2,755		
	22	90	21	320	30	FLV2290-21F066		\$3,844	\$4,228
	22	90	21	320	30	FLT2290-21F660	\$2,755		
	22	90	21	320	30	FLV2290-21F660		\$3,844	\$4,228

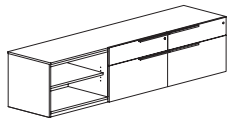

*066 shown



*660

Features:

- pedestal front locking
- compartment has one adjustable shelf
- shelf 12 1/2"d

Options:

- must specify chassis grain direction on double cut veneer, see pages 11-13 for details
- peninsula desk mounting must be specified when ordering secondary credenza; see page 17 for details
- concealed box drawer(s) available, specify location in unit; add \$234 list for each laminate drawer or \$357 for each veneer drawer, see page 23 for details
- veneer drawer fronts in paint available, specify paint color and add \$337 list; see page 14 for details
- on laminate units, contrasting fronts available, no upcharge; specify color, see page 14 for details
- ledge pulls standard; prism pulls available, specify and see page 9
- oval grommets in back panel can be eliminated upon request, no upcharge
- oval or rectangular seat cushion available, see page 23 for more details and page 212 for pricing
- interior horizontal wire manager with end grommets available, specify and add \$180 list; see page 38 for details
- top grommet available, specify location; add \$128 list each; see page 45 for details
- worksurface power available, specify "to accommodate EC26" on your purchase order; EC26 unit must be ordered separately, see page 45

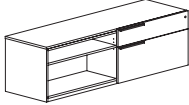
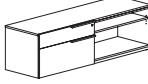
Description	D	W	H	CTN WT	CU FT	① Model	HPL Laminate	Flat Cut Veneer	Double Cut Veneer
Box/Lateral File with Open Storage Credenza  *06 shown  *60	22	72	21	232	24	FLT2272-21F06	\$2,253		
	22	72	21	232	24	FLV2272-21F06		\$3,019	\$3,323
	22	72	21	232	24	FLT2272-21F60	\$2,253		
	22	72	21	232	24	FLV2272-21F60		\$3,019	\$3,323
	22	66	21	214	22	FLT2266-21F06	\$2,188		
	22	66	21	214	22	FLV2266-21F06		\$2,933	\$3,225
	22	66	21	214	22	FLT2266-21F60	\$2,188		
	22	66	21	214	22	FLV2266-21F60		\$2,933	\$3,225
	22	60	21	203	20	FLT2260-21F06	\$2,125		
	22	60	21	203	20	FLV2260-21F06		\$2,844	\$3,130
	22	60	21	203	20	FLT2260-21F60	\$2,125		
	22	60	21	203	20	FLV2260-21F60		\$2,844	\$3,130

Features:

- pedestal front locking
- compartment has one adjustable shelf
- shelf 12 1/2" d

Options:

- must specify chassis grain direction on double cut veneer, see pages 11-13 for details
- peninsula desk mounting must be specified when ordering secondary credenza; see page 17 for details
- concealed box drawer available, specify; add \$234 list for each laminate drawer or \$357 for each veneer drawer, see page 23 for details
- veneer drawer fronts in paint available, specify paint color and add \$337 list; see page 14 for details
- on laminate units, contrasting fronts available, no upcharge; specify color, see page 14 for details
- ledge pulls standard; prism pulls available, specify and see page 9
- oval grommets in back panel can be eliminated upon request, no upcharge
- oval or rectangular seat cushion available, see page 23 for more details and page 212 for pricing
- interior horizontal wire manager with end grommets available, specify and add \$180 list; see page 38 for details
- top grommet available, specify location; add \$128 list each; see page 45 for details
- worksurface power available, specify "to accommodate EC26" on your purchase order; EC26 unit must be ordered separately, see page 45

To Order, Specify:

① Laminate Model #	② Laminate Type	③ Laminate Selection	④ Metal Color	⑤ Other Product Options
Laminate (FLT)	HPL	See Laminate Selection	See Metal Finish Color Options	See list of options for each specific unit; Specify and add accordingly.

① Veneer Model #	② Wood Species	③ Wood Finish	④ Metal Color	⑤ Other Product Options
Veneer (FLV)	Flat Cut CH1 Cherry MA1 Maple WA1 Walnut BO1 Black Oak	See Flat Cut Wood Finish Options	See Metal Finish Color Options	See list of options for each specific unit; Specify and add accordingly.
		<table border="1"> <thead> <tr> <th>ⓐ Wood Finish</th> <th>ⓑ Chassis Grain Direction</th> </tr> </thead> <tbody> <tr> <td>See Double Cut Wood Finish Options</td> <td>For Double Cut Only: Vertical Horizontal</td> </tr> </tbody> </table>		
ⓐ Wood Finish	ⓑ Chassis Grain Direction			
See Double Cut Wood Finish Options	For Double Cut Only: Vertical Horizontal			

Description	D	W	H	CTN WT	CU FT	① Model	HPL Laminate	Flat Cut Veneer	Double Cut Veneer
Double Sliding Door Credenza	22	90	21	291	30	FLT2290-21F909	\$2,362		
	22	90	21	291	30	FLV2290-21F909		\$3,296	\$3,627

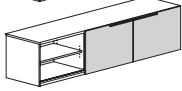
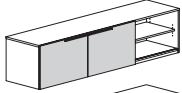
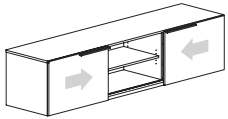

Features:

- locking doors not available
- each compartment has one adjustable shelf
- shelves 12 1/2"d

Options:

- must specify chassis grain direction on double cut veneer, see pages 11-13 for details
- peninsula desk mounting must be specified when ordering secondary credenza; see page 17 for details
- veneer door fronts in paint available, specify paint color and add \$337 list; see page 14 for details
- on laminate units, contrasting laminate door fronts available, no upcharge; specify laminate color, see page 14 for details
- ledge pulls standard; prism pulls available, specify and see page 9
- oval grommets in back panel can be eliminated upon request, no upcharge
- oval or rectangular seat cushion available, see page 23 for more details and page 212 for pricing
- interior horizontal wire manager with end grommets available, specify and add \$180 list; see page 38 for details
- top grommet available, specify location; add \$128 list each; see page 45 for details
- worksurface power available, specify "to accommodate EC26" on your purchase order; EC26 unit must be ordered separately, see page 45

Sliding Door Credenza	22	90	21	274	30	FLT2290-21F090	\$2,248		
	22	90	21	274	30	FLV2290-21F090		\$3,139	\$3,455

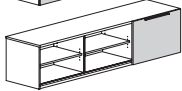
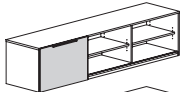
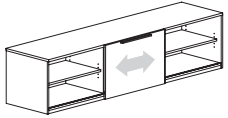

Features:

- locking doors not available
- each compartment has one adjustable shelf
- shelves 12 1/2"d

Options:

- must specify chassis grain direction on double cut veneer, see pages 11-13 for details
- peninsula desk mounting must be specified when ordering secondary credenza; see page 17 for details
- veneer door fronts in paint available, specify paint color and add \$337 list; see page 14 for details
- on laminate units, contrasting laminate door fronts available, no upcharge; specify laminate color, see page 14 for details
- ledge pulls standard; prism pulls available, specify and see page 9
- oval grommets in back panel can be eliminated upon request, no upcharge
- oval or rectangular seat cushion available, see page 23 for more details and page 212 for pricing
- interior horizontal wire manager with end grommets available, specify and add \$180 list; see page 38 for details
- top grommet available, specify location; add \$128 list each; see page 45 for details
- worksurface power available, specify "to accommodate EC26" on your purchase order; EC26 unit must be ordered separately, see page 45

Description	D	W	H	CTN WT	CU FT	① Model	HPL Laminate	Flat Cut Veneer	Double Cut Veneer
Sliding Door Credenza	22	72	21	211	24	FLT2272-21F09	\$2,050		
	22	72	21	211	24	FLV2272-21F09		\$2,863	\$3,150
	22	60	21	185	20	FLT2260-21F09	\$1,934		
	22	60	21	185	20	FLV2260-21F09		\$2,699	\$2,971

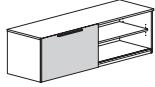
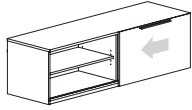

Features:

- locking doors not available
- each compartment has one adjustable shelf
- shelves 12 1/2"d

Options:

- must specify chassis grain direction on double cut veneer, see pages 11-13 for details
- peninsula desk mounting must be specified when ordering secondary credenza; see page 17 for details
- veneer door fronts in paint available, specify paint color and add \$337 list; see page 14 for details
- on laminate units, contrasting laminate door fronts available, no upcharge; specify laminate color, see page 14 for details
- ledge pulls standard; prism pulls available, specify and see page 9
- oval grommets in back panel can be eliminated upon request, no upcharge
- oval or rectangular seat cushion available, see page 23 for more details and page 212 for pricing
- interior horizontal wire manager with end grommets available, specify and add \$180 list; see page 38 for details
- top grommet available, specify location; add \$128 list each; see page 45 for details
- worksurface power available, specify "to accommodate EC26" on your purchase order; EC26 unit must be ordered separately, see page 45

To Order, Specify:

① Laminate Model #	② Laminate Type	③ Laminate Selection	④ Metal Color	⑤ Other Product Options
Laminate (FLT)	HPL	See Laminate Selection	See Metal Finish Color Options	See list of options for each specific unit; Specify and add accordingly.

① Veneer Model #	② Wood Species	③ Wood Finish	④ Metal Color	⑤ Other Product Options	
Veneer (FLV)	Flat Cut CH1 Cherry MA1 Maple WA1 Walnut BO1 Black Oak	See Flat Cut Wood Finish Options	See Metal Finish Color Options	See list of options for each specific unit; Specify and add accordingly.	
	Double Cut DC1 Double Cut	<table border="1"> <thead> <tr> <th>3a Wood Finish</th> <th>3b Chassis Grain Direction</th> </tr> </thead> <tbody> <tr> <td>See Double Cut Wood Finish Options</td> <td>For Double Cut Only: Vertical Horizontal</td> </tr> </tbody> </table>			3a Wood Finish
3a Wood Finish	3b Chassis Grain Direction				
See Double Cut Wood Finish Options	For Double Cut Only: Vertical Horizontal				

Description	D	W	H	CTN WT	CU FT	① Model	HPL Laminate	Flat Cut Veneer	Double Cut Veneer
Open Compartment Storage Credenza	22	90	21	246	30	FLT2290-21F000	\$1,952		
	22	90	21	246	30	FLV2290-21F000		\$2,723	\$2,997

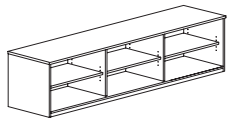

Features:

- square edge on top
- each open compartment has one adjustable shelf
- shelves 12 1/2"d

Options:

- must specify chassis grain direction on double cut veneer, see pages 11-13 for details
- peninsula desk mounting must be specified when ordering secondary credenza; see page 17 for details
- oval or rectangular seat cushion available, see page 23 for more details and page 212 for pricing
- oval grommets in back panel can be eliminated upon request, no upcharge
- interior horizontal wire manager with end grommets available, specify and add \$180 list; see page 38 for details
- top grommet available, specify location and add \$128 list each; see page 45 for details
- worksurface power available, specify "to accommodate EC26" on your purchase order; EC26 unit must be ordered separately, see page 45

Open Compartment Storage Credenza	22	72	21	193	24	FLT2272-21F00	\$1,779		
	22	72	21	193	24	FLV2272-21F00		\$2,484	\$2,733
	22	60	21	169	20	FLT2260-21F00	\$1,665		
	22	60	21	169	20	FLV2260-21F00		\$2,343	\$2,575

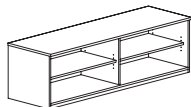

Features:

- square edge on top
- each open compartment has one adjustable shelf
- shelves 12 1/2"d

Options:

- must specify chassis grain direction on double cut veneer, see pages 11-13 for details
- peninsula desk mounting must be specified when ordering secondary credenza; see page 17 for details
- oval or rectangular seat cushion available, see page 23 for more details and page 212 for pricing
- oval grommets in back panel can be eliminated upon request, no upcharge
- interior horizontal wire manager with end grommets available, specify and add \$180 list; see page 38 for details
- top grommet available, specify location and add \$128 list each; see page 45 for details
- worksurface power available, specify "to accommodate EC26" on your purchase order; EC26 unit must be ordered separately, see page 45

Description	D	W	H	CTN WT	CU FT	① Model	HPL Laminate	Flat Cut Veneer	Double Cut Veneer
Open Storage with Side Power Access	22	36	21	118	13	FLT2236-21FE0	\$1,601		
	22	36	21	118	13	FLV2236-21FE0		\$2,077	\$2,285
	22	36	21	124	13	FLT2236-21FOE	\$1,601		
	22	36	21	124	13	FLV2236-21FOE		\$2,077	\$2,285
	22	30	21	101	11	FLT2230-21FE0	\$1,554		
	22	30	21	101	11	FLV2230-21FE0		\$2,016	\$2,218
	22	30	21	107	11	FLT2230-21FOE	\$1,554		
	22	30	21	107	11	FLV2230-21FOE		\$2,016	\$2,218



*OE shown

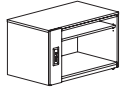

*EO

Features:

- square edge on top
- electrical power unit - EC26 included, specify color
- open compartment with adjustable shelf
- shelf 12 1/2" d

Options:

- must specify chassis grain direction on double cut veneer, see pages 11-13 for details
- oval or rectangular seat cushion available, see page 23 for more details and page 212 for pricing
- oval grommet in back panel can be eliminated upon request, no upcharge

To Order, Specify:

① Laminate Model #	② Laminate Type	③ Laminate Selection	④ Metal Color	⑤ Other Product Options
Laminate (FLT)	HPL	See Laminate Selection	See Metal Finish Color Options	See list of options for each specific unit; Specify and add accordingly.

① Veneer Model #	② Wood Species	③ Wood Finish	④ Metal Color	⑤ Other Product Options
Veneer (FLV)	Flat Cut CH1 Cherry MA1 Maple WA1 Walnut BO1 Black Oak	See Flat Cut Wood Finish Options	See Metal Finish Color Options	See list of options for each specific unit; Specify and add accordingly.
		<table border="1"> <thead> <tr> <th>ⓐ Wood Finish</th> <th>ⓑ Chassis Grain Direction</th> </tr> </thead> <tbody> <tr> <td>See Double Cut Wood Finish Options</td> <td>For Double Cut Only: Vertical Horizontal</td> </tr> </tbody> </table>		
ⓐ Wood Finish	ⓑ Chassis Grain Direction			
See Double Cut Wood Finish Options	For Double Cut Only: Vertical Horizontal			

Description	D	W	H	CTN WT	CU FT	① Model	HPL Laminate	Flat Cut Veneer	Double Cut Veneer
Lateral File Pedestal Credenza - Flush Legs	22	90	21	285	30	FLT2290-21L666	\$3,771		
	22	90	21	285	30	FLV2290-21L666		\$4,898	\$5,387

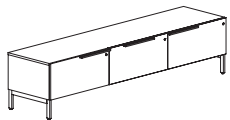

Features:

- pedestal front locking

Options:

- must specify chassis grain direction on double cut veneer, see pages 11-13 for details
- veneer drawer fronts in paint available, specify paint color and add \$337 list; see page 14 for details
- on laminate units, contrasting fronts available, no upcharge; specify color, see page 14 for details
- ledge pulls standard; prism pulls available, specify and see page 9
- oval or rectangular seat cushion available, see page 23 for more details and page 212 for pricing
- oval grommets in back panel can be eliminated upon request, no upcharge
- interior horizontal wire manager with end grommets available, specify and add \$180 list; see page 38 for details
- top grommet available, specify location and add \$128 list each; see page 45 for details

Lateral Credenza - Inset Legs	22	90	21	280	30	FLT2290-21S666	\$3,771		
	22	90	21	280	30	FLV2290-21S666		\$4,898	\$5,387

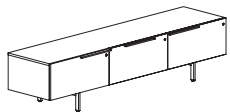

Features:

- pedestal front locking

Options:

- must specify chassis grain direction on double cut veneer, see pages 11-13 for details
- veneer drawer fronts in paint available, specify paint color and add \$337 list; see page 14 for details
- on laminate units, contrasting fronts available, no upcharge; specify color, see page 14 for details
- ledge pulls standard; prism pulls available, specify and see page 9
- oval or rectangular seat cushion available, see page 23 for more details and page 212 for pricing
- oval grommets in back panel can be eliminated upon request, no upcharge
- interior horizontal wire manager with end grommets available, specify and add \$180 list; see page 38 for details
- top grommet available, specify location and add \$128 list each; see page 45 for details

Lateral File Pedestal Credenza - Flush Legs	22	72	21	225	24	FLT2272-21L66	\$2,979		
	22	72	21	225	24	FLV2272-21L66		\$3,869	\$4,255
	22	60	21	198	20	FLT2260-21L66	\$2,811		
	22	60	21	198	20	FLV2260-21L66		\$3,649	\$4,015

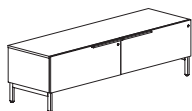

Features:

- pedestal front locking

Options:

- must specify chassis grain direction on double cut veneer, see pages 11-13 for details
- veneer drawer fronts in paint available, specify paint color and add \$337 list; see page 14 for details
- on laminate units, contrasting fronts available, no upcharge; specify color, see page 14 for details
- ledge pulls standard; prism pulls available, specify and see page 9
- oval or rectangular seat cushion available, see page 23 for more details and page 212 for pricing
- oval grommets in back panel can be eliminated upon request, no upcharge
- interior horizontal wire manager with end grommets available, specify and add \$180 list; see page 38 for details
- top grommet available, specify location and add \$128 list each; see page 45 for details

FLUX - PRIVATE OFFICE

Description	D	W	H	CTN WT	CU FT	① Model	HPL Laminate	Flat Cut Veneer	Double Cut Veneer
Lateral Credenza - Inset Legs	22	72	21	220	24	FLT2272-21S66	\$2,979		
	22	72	21	220	24	FLV2272-21S66		\$3,869	\$4,255

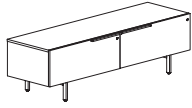

Features:

- pedestal front locking

Options:

- must specify chassis grain direction on double cut veneer, see pages 11-13 for details
- veneer drawer fronts in paint available, specify paint color and add \$337 list; see page 14 for details
- on laminate units, contrasting fronts available, no upcharge; specify color, see page 14 for details
- ledge pulls standard; prism pulls available, specify and see page 9
- oval or rectangular seat cushion available, see page 23 for more details and page 212 for pricing
- oval grommets in back panel can be eliminated upon request, no upcharge
- interior horizontal wire manager with end grommets available, specify and add \$180 list; see page 38 for details
- top grommet available, specify location and add \$128 list each; see page 45 for details

Lateral File Pedestal Credenza - Flush Legs	22	36	21	127	13	FLT2236-21L6	\$2,158		
	22	36	21	127	13	FLV2236-21L6		\$2,802	\$3,083
	22	30	21	104	11	FLT2230-21L6	\$2,096		
	22	30	21	104	11	FLV2230-21L6		\$2,719	\$2,992

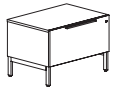

Features:

- pedestal front locking

Options:

- must specify chassis grain direction on double cut veneer, see pages 11-13 for details
- veneer drawer fronts in paint available, specify paint color and add \$337 list; see page 14 for details
- on laminate units, contrasting fronts available, no upcharge; specify color, see page 14 for details
- ledge pulls standard; prism pulls available, specify and see page 9
- oval or rectangular seat cushion available, see page 23 for more details and page 212 for pricing
- oval grommets in back panel can be eliminated upon request, no upcharge
- interior horizontal wire manager with end grommets available, specify and add \$180 list; see page 38 for details
- top grommet available, specify location and add \$128 list each; see page 45 for details

To Order, Specify:

① Laminate Model #	② Laminate Type	③ Laminate Selection	④ Metal Color	⑤ Other Product Options
Laminate (FLT)	HPL	See Laminate Selection	See Metal Finish Color Options	See list of options for each specific unit; Specify and add accordingly.

① Veneer Model #	② Wood Species	③ Wood Finish	④ Metal Color	⑤ Other Product Options
Veneer (FLV)	Flat Cut CH1 Cherry MA1 Maple WA1 Walnut BO1 Black Oak	See Flat Cut Wood Finish Options	See Metal Finish Color Options	See list of options for each specific unit; Specify and add accordingly.
		<table border="1"> <thead> <tr> <th>ⓐ Wood Finish</th> <th>ⓑ Chassis Grain Direction</th> </tr> </thead> <tbody> <tr> <td>See Double Cut Wood Finish Options</td> <td>For Double Cut Only: Vertical Horizontal</td> </tr> </tbody> </table>		
ⓐ Wood Finish	ⓑ Chassis Grain Direction			
See Double Cut Wood Finish Options	For Double Cut Only: Vertical Horizontal			

Description	D	W	H	CTN WT	CU FT	① Model	HPL Laminate	Flat Cut Veneer	Double Cut Veneer
Lateral File and Open Storage Credenza - Flush Legs	22	96	21	250	32	FLT2296-21L606	\$3,523		
	22	96	21	250	32	FLV2296-21L606		\$4,575	\$5,031
	22	90	21	258	30	FLT2290-21L606	\$3,419		
	22	90	21	258	30	FLV2290-21L606		\$4,441	\$4,885

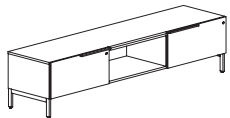

Features:

- pedestal front locking

Options:

- must specify chassis grain direction on double cut veneer, see pages 11-13 for details
- peninsula desk mounting must be specified when ordering secondary credenza; see page 17 for details
- veneer drawer fronts in paint available, specify paint color and add \$337 list; see page 14 for details
- on laminate units, contrasting fronts available, no upcharge; specify color, see page 14 for details
- ledge pulls standard; prism pulls available, specify and see page 9
- oval or rectangular seat cushion available, see page 23 for more details and page 212 for pricing
- oval grommets in back panel can be eliminated upon request, no upcharge
- interior horizontal wire manager with end grommets available, specify and add \$180 list; see page 38 for details
- top grommet available, specify location; add \$128 list each; see page 45 for details
- worksurface power available, specify "to accommodate EC26" on your purchase order; EC26 unit must be ordered separately, see page 45

Lateral File and Open Storage Credenza - Inset Legs	22	90	21	247	30	FLT2290-21S606	\$3,523		
	22	90	21	247	30	FLV2290-21S606		\$4,575	\$5,031

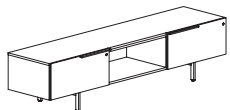

Features:

- pedestal front locking

Options:

- must specify chassis grain direction on double cut veneer, see pages 11-13 for details
- peninsula desk mounting must be specified when ordering secondary credenza; see page 17 for details
- veneer drawer fronts in paint available, specify paint color and add \$337 list; see page 14 for details
- on laminate units, contrasting fronts available, no upcharge; specify color, see page 14 for details
- ledge pulls standard; prism pulls available, specify and see page 9
- oval or rectangular seat cushion available, see page 23 for more details and page 212 for pricing
- oval grommets in back panel can be eliminated upon request, no upcharge
- interior horizontal wire manager with end grommets available, specify and add \$180 list; see page 38 for details
- top grommet available, specify location; add \$128 list each; see page 45 for details
- worksurface power available, specify "to accommodate EC26" on your purchase order; EC26 unit must be ordered separately, see page 45

Description	D	W	H	CTN WT	CU FT	① Model	HPL Laminate	Flat Cut Veneer	Double Cut Veneer
Lateral File and Open Storage Credenza - Flush Legs	22	96	21	232	32	FLT2296-21L060	\$3,300		
	22	96	21	232	32	FLV2296-21L060		\$4,284	\$4,710
	22	90	21	252	30	FLT2290-21L060	\$3,203		
	22	90	21	252	30	FLV2290-21L060		\$4,157	\$4,576

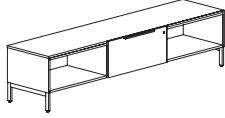

Features:

- pedestal front locking

Options:

- must specify chassis grain direction on double cut veneer, see pages 11-13 for details
- peninsula desk mounting must be specified when ordering secondary credenza; see page 17 for details
- veneer drawer fronts in paint available, specify paint color and add \$337 list; see page 14 for details
- on laminate units, contrasting fronts available, no upcharge; specify color, see page 14 for details
- ledge pulls standard; prism pulls available, specify and see page 9
- oval or rectangular seat cushion available, see page 23 for more details and page 212 for pricing
- oval grommets in back panel can be eliminated upon request, no upcharge
- interior horizontal wire manager with end grommets available, specify and add \$180 list; see page 38 for details
- top grommet available, specify location; add \$128 list each; see page 45 for details
- worksurface power available, specify "to accommodate EC26" on your purchase order; EC26 unit must be ordered separately, see page 45

Lateral File and Open Storage Credenza with Inset Legs	22	90	21	251	30	FLT2290-21S060	\$3,300		
	22	90	21	251	30	FLV2290-21S060		\$4,284	\$4,710

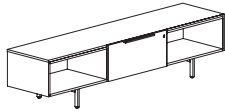

Features:

- pedestal front locking

Options:

- must specify chassis grain direction on double cut veneer, see pages 11-13 for details
- peninsula desk mounting must be specified when ordering secondary credenza; see page 17 for details
- veneer drawer fronts in paint available, specify paint color and add \$337 list; see page 14 for details
- on laminate units, contrasting fronts available, no upcharge; specify color, see page 14 for details
- ledge pulls standard; prism pulls available, specify and see page 9
- oval or rectangular seat cushion available, see page 23 for more details and page 212 for pricing
- oval grommets in back panel can be eliminated upon request, no upcharge
- interior horizontal wire manager with end grommets available, specify and add \$180 list; see page 38 for details
- top grommet available, specify location; add \$128 list each; see page 45 for details
- worksurface power available, specify "to accommodate EC26" on your purchase order; EC26 unit must be ordered separately, see page 45

To Order, Specify:

① Laminate Model #	② Laminate Type	③ Laminate Selection	④ Metal Color	⑤ Other Product Options
Laminate (FLT)	HPL	See Laminate Selection	See Metal Finish Color Options	See list of options for each specific unit; Specify and add accordingly.

① Veneer Model #	② Wood Species	③ Wood Finish	④ Metal Color	⑤ Other Product Options	
Veneer (FLV)	Flat Cut CH1 Cherry MA1 Maple WA1 Walnut BO1 Black Oak	See Flat Cut Wood Finish Options	See Metal Finish Color Options	See list of options for each specific unit; Specify and add accordingly.	
	Double Cut DC1 Double Cut	<table border="1"> <thead> <tr> <th>ⓐ Wood Finish</th> <th>ⓑ Chassis Grain Direction</th> </tr> </thead> <tbody> <tr> <td>See Double Cut Wood Finish Options</td> <td>For Double Cut Only: Vertical Horizontal</td> </tr> </tbody> </table>			ⓐ Wood Finish
ⓐ Wood Finish	ⓑ Chassis Grain Direction				
See Double Cut Wood Finish Options	For Double Cut Only: Vertical Horizontal				

Description	D	W	H	CTN WT	CU FT	① Model	HPL Laminate	Flat Cut Veneer	Double Cut Veneer
Lateral File and Open Storage Credenza - Flush Legs	22	96	21	256	32	FLT2296-21L066	\$3,523		
	22	96	21	256	32	FLV2296-21L066		\$4,575	\$5,031
	22	96	21	256	32	FLT2296-21L660	\$3,523		
	22	96	21	256	32	FLV2296-21L660		\$4,575	\$5,031
	22	90	21	256	30	FLT2290-21L066	\$3,419		
	22	90	21	256	30	FLV2290-21L066		\$4,441	\$4,885
	22	90	21	256	30	FLT2290-21L660	\$3,419		
	22	90	21	256	30	FLV2290-21L660		\$4,441	\$4,885

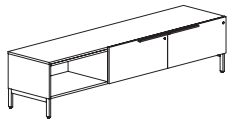

*066 shown

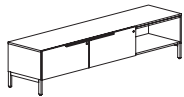

*660

Features:

- pedestal front locking

Options:

- must specify chassis grain direction on double cut veneer, see pages 11-13 for details
- peninsula desk mounting must be specified when ordering secondary credenza; see page 17 for details
- veneer drawer fronts in paint available, specify paint color and add \$337 list; see page 14 for details
- on laminate units, contrasting fronts available, no upcharge; specify color, see page 14 for details
- ledge pulls standard; prism pulls available, specify and see page 9
- oval or rectangular seat cushion available, see page 23 for more details and page 212 for pricing
- oval grommets in back panel can be eliminated upon request, no upcharge
- interior horizontal wire manager with end grommets available, specify and add \$180 list; see page 38 for details
- top grommet available, specify location; add \$128 list each; see page 45 for details
- worksurface power available, specify "to accommodate EC26" on your purchase order; EC26 unit must be ordered separately, see page 45

Description	D	W	H	CTN WT	CU FT	① Model	HPL Laminate	Flat Cut Veneer	Double Cut Veneer
Lateral File and Open Storage	22	90	21	251	30	FLT2290-21S066	\$3,523		
Credenza with Inset Legs -	22	90	21	251	30	FLV2290-21S066		\$4,575	\$5,031
Secondary Height	22	90	21	251	30	FLT2290-21S660	\$3,523		
	22	90	21	251	30	FLV2290-21S660		\$4,575	\$5,031

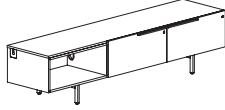

*066 shown

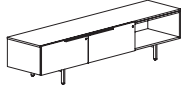

*660

Features:

- pedestal front locking

Options:

- must specify chassis grain direction on double cut veneer, see pages 11-13 for details
- peninsula desk mounting must be specified when ordering secondary credenza; see page 17 for details
- veneer drawer fronts in paint available, specify paint color and add \$337 list; see page 14 for details
- on laminate units, contrasting fronts available, no upcharge; specify color, see page 14 for details
- ledge pulls standard; prism pulls available, specify and see page 9
- oval or rectangular seat cushion available, see page 23 for more details and page 212 for pricing
- oval grommets in back panel can be eliminated upon request, no upcharge
- interior horizontal wire manager with end grommets available, specify and add \$180 list; see page 38 for details
- top grommet available, specify location; add \$128 list each; see page 45 for details
- worksurface power available, specify "to accommodate EC26" on your purchase order; EC26 unit must be ordered separately, see page 45

To Order, Specify:

① Laminate Model #	② Laminate Type	③ Laminate Selection	④ Metal Color	⑤ Other Product Options
Laminate (FLT)	HPL	See Laminate Selection	See Metal Finish Color Options	See list of options for each specific unit; Specify and add accordingly.

① Veneer Model #	② Wood Species	③ Wood Finish	④ Metal Color	⑤ Other Product Options
Veneer (FLV)	Flat Cut CH1 Cherry MA1 Maple WA1 Walnut BO1 Black Oak	See Flat Cut Wood Finish Options	See Metal Finish Color Options	See list of options for each specific unit; Specify and add accordingly.
		<table border="1"> <thead> <tr> <th>③a Wood Finish</th> <th>③b Chassis Grain Direction</th> </tr> </thead> <tbody> <tr> <td>See Double Cut Wood Finish Options</td> <td>For Double Cut Only: Vertical Horizontal</td> </tr> </tbody> </table>		
③a Wood Finish	③b Chassis Grain Direction			
See Double Cut Wood Finish Options	For Double Cut Only: Vertical Horizontal			

Description	D	W	H	CTN WT	CU FT	① Model	HPL Laminate	Flat Cut Veneer	Double Cut Veneer
Lateral File and Open Storage Credenza - Flush Legs	22	72	21	210	24	FLT2272-21L06	\$2,749		
	22	72	21	210	24	FLV2272-21L06		\$3,569	\$3,925
	22	72	21	210	24	FLT2272-21L60	\$2,749		
	22	72	21	210	24	FLV2272-21L60		\$3,569	\$3,925
	22	66	21	186	22	FLT2266-21L06	\$2,669		
	22	66	21	186	22	FLV2266-21L06		\$3,462	\$3,809
	22	66	21	177	22	FLT2266-21L60	\$2,669		
	22	66	21	177	22	FLV2266-21L60		\$3,462	\$3,809
	22	60	21	169	20	FLT2260-21L06	\$2,588		
	22	60	21	169	20	FLV2260-21L06		\$3,356	\$3,695
	22	60	21	169	20	FLT2260-21L60	\$2,588		
	22	60	21	169	20	FLV2260-21L60		\$3,356	\$3,695



*06 shown

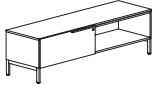

*60 shown

Features:

- pedestal front locking

Options:

- must specify chassis grain direction on double cut veneer, see pages 11-13 for details
- peninsula desk mounting must be specified when ordering secondary credenza; see page 17 for details
- veneer drawer fronts in paint available, specify paint color and add \$337 list; see page 14 for details
- on laminate units, contrasting fronts available, no upcharge; specify color, see page 14 for details
- ledge pulls standard; prism pulls available, specify and see page 9
- oval or rectangular seat cushion available, see page 23 for more details and page 212 for pricing
- oval grommets in back panel can be eliminated upon request, no upcharge
- interior horizontal wire manager with end grommets available, specify and add \$180 list; see page 38 for details
- top grommet available, specify location; add \$128 list each; see page 45 for details
- worksurface power available, specify "to accommodate EC26" on your purchase order; EC26 unit must be ordered separately, see page 45

Lateral File and Open Storage Credenza - Inset Legs	22	72	21	205	24	FLT2272-21S06	\$2,749		
	22	72	21	205	24	FLV2272-21S06		\$3,569	\$3,924
	22	72	21	205	24	FLT2272-21S60	\$2,749		
	22	72	21	205	24	FLV2272-21S60		\$3,569	\$3,924
	22	60	21	161	20	FLT2260-21S06	\$2,588		
	22	60	21	161	20	FLV2260-21S06		\$3,356	\$3,695
	22	60	21	161	20	FLT2260-21S60	\$2,588		
	22	60	21	161	20	FLV2260-21S60		\$3,356	\$3,695

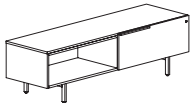

*06 shown

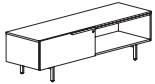

*60

Features:

- pedestal front locking

Options:

- must specify chassis grain direction on double cut veneer, see pages 11-13 for details
- peninsula desk mounting must be specified when ordering secondary credenza; see page 17 for details
- veneer drawer fronts in paint available, specify paint color and add \$337 list; see page 14 for details
- on laminate units, contrasting fronts available, no upcharge; specify color, see page 14 for details
- ledge pulls standard; prism pulls available, specify and see page 9
- oval or rectangular seat cushion available, see page 23 for more details and page 212 for pricing
- oval grommets in back panel can be eliminated upon request, no upcharge
- interior horizontal wire manager with end grommets available, specify and add \$180 list; see page 38 for details
- top grommet available, specify location; add \$128 list each; see page 45 for details
- worksurface power available, specify "to accommodate EC26" on your purchase order; EC26 unit must be ordered separately, see page 45

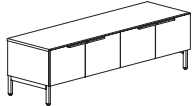
Description	D	W	H	CTN WT	CU FT	① Model	HPL Laminate	Flat Cut Veneer	Double Cut Veneer
 Four Door Storage - Flush Legs	22	72	21	189	24	FLT2272-21L77	\$2,323		
	22	72	21	189	24	FLV2272-21L77		\$3,016	\$3,316
	22	60	21	160	20	FLT2260-21L77	\$2,183		
	22	60	21	160	20	FLV2260-21L77		\$2,834	\$3,120

Options:

- must specify chassis grain direction on double cut veneer, see pages 11-13 for details
- locking doors available, specify and add \$284 list
- veneer door fronts in paint available, specify paint color and add \$337 list; see page 14 for details
- on laminate units, contrasting laminate door fronts available, no upcharge; specify laminate color, see page 14 for details
- ledge pulls standard; prism pulls available, specify and see page 9
- oval or rectangular seat cushion available, see page 23 for more details and page 212 for pricing
- on laminate units, contrasting laminate door fronts available, no upcharge; specify laminate color, see page 14 for details
- oval grommets in back panel can be eliminated upon request, no upcharge
- interior horizontal wire manager with end grommets available, specify and add \$180 list; see page 38 for details
- top grommet available, specify location; add \$128 list each; see page 45 for details
- worksurface power available, specify "to accommodate EC26" on your purchase order; EC26 unit must be ordered separately, see page 45

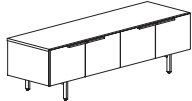
Description	D	W	H	CTN WT	CU FT	① Model	HPL Laminate	Flat Cut Veneer	Double Cut Veneer
 Four Door Storage Credenza - Inset Legs	22	72	21	196	20	FLT2272-21S77	\$2,323		
	22	72	21	196	20	FLV2272-21S77		\$3,016	\$3,316
	22	60	21	152	20	FLT2260-21S77	\$2,183		
	22	60	21	152	20	FLV2260-21S77		\$2,834	\$3,119

Options:

- must specify chassis grain direction on double cut veneer, see pages 11-13 for details
- locking doors available, specify and add \$284 list
- veneer door fronts in paint available, specify paint color and add \$337 list; see page 14 for details
- on laminate units, contrasting laminate door fronts available, no upcharge; specify laminate color, see page 14 for details
- ledge pulls standard; prism pulls available, specify and see page 9
- oval or rectangular seat cushion available, see page 23 for more details and page 212 for pricing
- oval grommets in back panel can be eliminated upon request, no upcharge
- interior horizontal wire manager with end grommets available, specify and add \$180 list; see page 38 for details
- top grommet available, specify location; add \$128 list each; see page 45 for details
- worksurface power available, specify "to accommodate EC26" on your purchase order; EC26 unit must be ordered separately, see page 45

To Order, Specify:

① Laminate Model #	② Laminate Type	③ Laminate Selection	④ Metal Color	⑤ Other Product Options
Laminate (FLT)	HPL	See Laminate Selection	See Metal Finish Color Options	See list of options for each specific unit; Specify and add accordingly.

① Veneer Model #	② Wood Species	③ Wood Finish	④ Metal Color	⑤ Other Product Options
Veneer (FLV)	Flat Cut CH1 Cherry MA1 Maple WA1 Walnut BO1 Black Oak	See Flat Cut Wood Finish Options	See Metal Finish Color Options	See list of options for each specific unit; Specify and add accordingly.
	Double Cut DC1 Double Cut	③a Wood Finish See Double Cut Wood Finish Options		

Description	D	W	H	CTN WT	CU FT	① Model	HPL Laminate	Flat Cut Veneer	Double Cut Veneer
Open Compartment Storage Credenza - Flush Legs	22	90	21	193	30	FLT2290-21L000	\$2,611		
	22	90	21	193	30	FLV2290-21L000		\$3,390	\$3,729

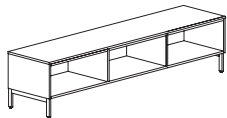

Options:

- must specify chassis grain direction on double cut veneer, see pages 11-13 for details
- peninsula desk mounting must be specified when ordering secondary credenza; see page 17 for details
- oval or rectangular seat cushion available, see page 23 for more details and page 212 for pricing
- oval grommets in back panel can be eliminated upon request, no upcharge
- top grommet available, specify location; add \$128 list each; see page 45 for details
- worksurface power available, specify "to accommodate EC26" on your purchase order; EC26 unit must be ordered separately, see page 45

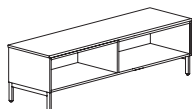

Open Compartment Storage Credenza - Flush Legs	22	72	21	136	24	FLT2272-21L00	\$2,089		
	22	72	21	136	24	FLV2272-21L00		\$2,714	\$2,984
	22	60	21	136	20	FLT2260-21L00	\$1,968		
	22	60	21	136	20	FLV2260-21L00		\$2,553	\$2,808



Options:

- must specify chassis grain direction on double cut veneer, see pages 11-13 for details
- peninsula desk mounting must be specified when ordering secondary credenza; see page 17 for details
- oval or rectangular seat cushion available, see page 23 for more details and page 212 for pricing
- oval grommets in back panel can be eliminated upon request, no upcharge
- top grommet available, specify location; add \$128 list each; see page 45 for details
- worksurface power available, specify "to accommodate EC26" on your purchase order; EC26 unit must be ordered separately, see page 45

FLUX - PRIVATE OFFICE

Description	D	W	H	CTN WT	CU FT	① Model	HPL Laminate	Flat Cut Veneer	Double Cut Veneer
Open Storage with Side Power Access - Flush Legs  *OE shown  *EO	22	36	21	100	13	FLT2236-21LE0	\$2,145		
	22	36	21	100	13	FLV2236-21LE0		\$2,782	\$3,061
	22	36	21	96	13	FLT2236-21LOE	\$2,145		
	22	36	21	96	13	FLV2236-21LOE		\$2,782	\$3,061
	22	30	21	84	11	FLT2230-21LE0	\$2,103		
	22	30	21	84	11	FLV2230-21LE0		\$2,727	\$3,002
	22	30	21	84	11	FLT2230-21LOE	\$2,103		
	22	30	21	84	11	FLV2230-21LOE		\$2,727	\$3,002

Features:

- square edge on top
- electrical power unit - EC26 included, specify color

Options:

- must specify chassis grain direction on double cut veneer, see pages 11-13 for details
- oval or rectangular seat cushion available, see page 23 for more details and page 212 for pricing
- oval grommet in back panel can be eliminated upon request, no upcharge

To Order, Specify:

① Laminate Model #	② Laminate Type	③ Laminate Selection	④ Metal Color	⑤ Other Product Options
Laminate (FLT)	HPL	See Laminate Selection	See Metal Finish Color Options	See list of options for each specific unit; Specify and add accordingly.

① Veneer Model #	② Wood Species	③ Wood Finish	④ Metal Color	⑤ Other Product Options
Veneer (FLV)	Flat Cut CH1 Cherry MA1 Maple WA1 Walnut BO1 Black Oak	See Flat Cut Wood Finish Options	See Metal Finish Color Options	See list of options for each specific unit; Specify and add accordingly.
		<table border="1"> <thead> <tr> <th>ⓐ Wood Finish</th> <th>ⓑ Chassis Grain Direction</th> </tr> </thead> <tbody> <tr> <td>See Double Cut Wood Finish Options</td> <td>For Double Cut Only: Vertical Horizontal</td> </tr> </tbody> </table>		
ⓐ Wood Finish	ⓑ Chassis Grain Direction			
See Double Cut Wood Finish Options	For Double Cut Only: Vertical Horizontal			

Description	D	W	H	CTN WT	CU FT	① Model	List Price Per Grade	
Oval Cushion  <ul style="list-style-type: none"> · use with secondary height units 30" - 36" wide · com ydg: 1 ¼ 	20	29	1 ¾	10	2	FLB20290VCUSH	COM \$286	
								A \$302
								B \$334
								COL/C \$387
								D \$456
								E \$523
								F \$629
								G \$745
								H \$867
								I \$1,057
								J \$1,287
								L1 \$830
								L2 \$966

Rectangular Cushion  <ul style="list-style-type: none"> · use with secondary height units 30" - 36" wide · com ydg: 1 ¼ 	20	29	1 ¾	11	2	FLB2029RECUSH	COM \$286	
								A \$302
								B \$334
								COL/C \$387
								D \$456
								E \$523
								F \$629
								G \$745
								H \$867
								I \$1,057
								J \$1,287
								L1 \$830
								L2 \$966

FLUX - PRIVATE OFFICE

Description	D	W	H	CTN WT	CU FT	① Model	List Price Per Grade	
Round Cushion	15 ¼	15 ¼	1 ¾	5	1	FLB1515RDCUSH	COM \$231	
 <ul style="list-style-type: none"> · use with secondary height 18"w mobile pedestals · com ydg: ¾ 							A \$240	
								B \$258
								COL/C \$290
								D \$333
								E \$372
								F \$436
								G \$505
								H \$579
								I \$691
								J \$832
								L1 \$555
							L2 \$638	

Square Cushion	15 ¼	15 ¼	1 ¾	5	1	FLB1515SQCUSH	COM \$231	
 <ul style="list-style-type: none"> · use with secondary height 18"w mobile pedestals · com ydg: ¾ 							A \$240	
								B \$258
								COL/C \$290
								D \$333
								E \$372
								F \$436
								G \$505
								H \$579
								I \$691
								J \$832
								L1 \$555
							L2 \$638	

FLUX - PRIVATE OFFICE

To Order, Specify:

① Model Number	② Fabric Selection	
(FLB)	Vendor Pattern Color	Visit www.jsifurniture.com/finishes-and-materials/textiles for our textiles program. See selection of standard and graded in manufacturers and patterns.

Description	D	W	H	CTN WT	CU FT	① Model	HPL Laminate	Flat Cut Veneer	Double Cut Veneer
Adjustable Height Rectangular Table Desk	36	72	Adj.	340	51	FLT3672AHT	\$6,392		
	36	72	Adj.	340	51	FLV3672AHT		\$6,961	\$7,657
	32	66	Adj.	323	42	FLT3266AHT	\$6,336		
	32	66	Adj.	323	42	FLV3266AHT		\$6,900	\$7,589
	32	60	Adj.	314	39	FLT3260AHT	\$6,312		
	32	60	Adj.	314	39	FLV3260AHT		\$6,871	\$7,557

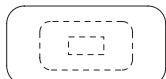
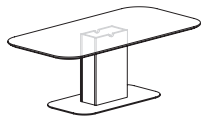

center mount

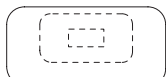
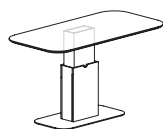

offset mount

Features:

- eased edge profile all sides
- top may be installed offset for a desk or centered for a meeting table, see page 47 for details
- removable panel provides access to power column and wiring
- powder coat steel base plate with neoprene leveling pads
- 27¾" to 45¾" height adjustment with digital controller, wire guide and 10' power cord
- maximum weight rating 140 lbs. (evenly distributed load)

Options:

- reverse bevel edge available on top perimeter, specify; add \$429 list for laminate or \$168 list for veneer; see page 8 for details
- top grommet available, specify location; add \$128 list each; see page 47 for details

Adjustable Height Square Table Desk	60	60	Adj.	377	70	FLT6060SAHT	\$6,821		
	60	60	Adj.	404	70	FLV6060SAHT		\$7,430	\$8,175
	54	54	Adj.	359	57	FLT5454SAHT	\$6,624		
	54	54	Adj.	381	57	FLV5454SAHT		\$7,221	\$7,944
	48	48	Adj.	77	14	FLT4848SAHT	\$6,555		
	48	48	Adj.	314	46	FLV4848SAHT		\$7,146	\$7,859

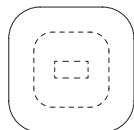
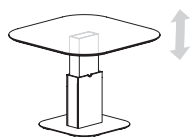
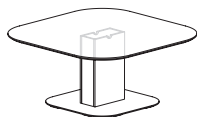

Features:

- eased edge profile all sides
- removable panel provides access to power column and wiring
- powder coat steel base plate with neoprene leveling pads
- 27¾" to 45¾" height adjustment with digital controller, wire guide and 10' power cord
- maximum weight rating 140 lbs. (evenly distributed load)

Options:

- reverse bevel edge available on top perimeter, specify; add \$429 list for laminate or \$168 list for veneer; see page 8 for details
- top grommet available, specify location; add \$128 list each; see page 47 for details

Description	D	W	H	CTN WT	CU FT	① Model	HPL Laminate	Flat Cut Veneer	Double Cut Veneer
Adjustable Height Round Table Desk	60	60	Adj.	404	70	FLT6060RAHT	\$6,821		
	60	60	Adj.	377	70	FLV6060RAHT		\$7,430	\$8,175
	54	54	Adj.	381	57	FLT5454RAHT	\$6,624		
	54	54	Adj.	359	57	FLV5454RAHT		\$7,221	\$7,944
	48	48	Adj.	314	46	FLT4848RAHT	\$6,555		
	48	48	Adj.	301	46	FLV4848RAHT		\$7,146	\$7,859

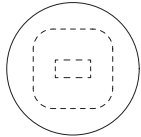
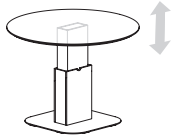
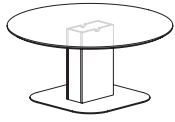

Features:

- eased edge profile all sides
- removable panel provides access to power column and wiring
- powder coat steel base plate with neoprene leveling pads
- 27¾" to 45¾" height adjustment with digital controller, wire guide and 10' power cord
- maximum weight rating 140 lbs. (evenly distributed load)

Options:

- reverse bevel edge available on top perimeter, specify; add \$429 list for laminate or \$168 list for veneer; see page 8 for details
- top grommet available, specify location; add \$128 list each; see page 47 for details

Adjustable Height Table - 120°	D	W	H	CTN WT	CU FT	Model	HPL Laminate	Flat Cut Veneer	Double Cut Veneer
Adjustable Height Table - 120°	30	84	Adj.	233	23	FLT3084-29AH120T	\$3,901		
	30	84	Adj.	233	23	FLV3084-29AH120T		\$4,836	\$5,174
	24	84	Adj.	218	21	FLT2484-29AH120T	\$3,821		
	24	84	Adj.	218	21	FLV2484-29AH120T		\$4,739	\$5,070

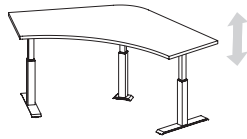
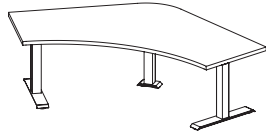

Features:

- eased edge profile on approach and user sides
- 22 ½" to 48 ½" height adjustment
- maximum weight rating 140 lbs. (evenly distributed load)
- key pad features height display with three memory settings; key pad mounts left or right
- 120" power cord

Options:

- specify Matte Black (MBK) or Arctic Silver (ASL) base finish
- top grommet available in center location, specify location; add \$128 list each
- optional EC33 unit must be ordered separately, see page 457
- undermount power available, specify and add \$946 list

To Order, Specify:

① Laminate Model #	② Laminate Type	③ Laminate Selection	④ Metal Color	⑤ Other Product Options
Laminate (FLT)	HPL	See Laminate Selection	See Metal Finish Color Options	See list of options for each specific unit; Specify and add accordingly.

① Veneer Model #	② Wood Species	③ Wood Finish	④ Metal Color	⑤ Other Product Options
Veneer (FLV)	Flat Cut CH1 Cherry MA1 Maple WA1 Walnut BO1 Black Oak	See Flat Cut Wood Finish Options	See Metal Finish Color Options	See list of options for each specific unit; Specify and add accordingly.
		<table border="1"> <thead> <tr> <th>Ⓐ Wood Finish</th> <th>Ⓑ Chassis Grain Direction</th> </tr> </thead> <tbody> <tr> <td>See Double Cut Wood Finish Options</td> <td>For Double Cut Only: Vertical Horizontal</td> </tr> </tbody> </table>		
Ⓐ Wood Finish	Ⓑ Chassis Grain Direction			
See Double Cut Wood Finish Options	For Double Cut Only: Vertical Horizontal			

Description	D	W	H	CTN WT	CU FT	① Model	HPL Laminate	Flat Cut Veneer	Double Cut Veneer
Electric Adjustable Height Table Desk 	36	72	Adj.	194	18	FLT3672AHTD-EL	\$2,568		
	36	72	Adj.	194	18	FLV3672AHTD-EL		\$3,200	\$3,383
	30	72	Adj.	175	16	FLT3072AHTD-EL	\$2,478		
	30	72	Adj.	175	16	FLV3072AHTD-EL		\$3,078	\$3,250
	30	66	Adj.	168	15	FLT3066AHTD-EL	\$2,445		
	30	66	Adj.	168	15	FLV3066AHTD-EL		\$3,043	\$3,212
	30	60	Adj.	160	14	FLT3060AHTD-EL	\$2,412		
	30	60	Adj.	160	14	FLV3060AHTD-EL		\$3,006	\$3,173
	24	72	Adj.	151	12	FLT2472AHTD-EL	\$2,390		
	24	72	Adj.	151	12	FLV2472AHTD-EL		\$2,954	\$3,120
	24	66	Adj.	146	11	FLT2466AHTD-EL	\$2,357		
	24	66	Adj.	146	11	FLV2466AHTD-EL		\$2,925	\$3,089
	24	60	Adj.	140	10	FLT2460AHTD-EL	\$2,327		
	24	60	Adj.	140	10	FLV2460AHTD-EL		\$2,897	\$3,058

Features:

- eased edge profile on approach and user sides
- 22½" to 49" height adjustment
- maximum weight rating 140 lbs. (evenly distributed load)
- key pad features height display with three memory settings; key pad mounts left or right
- display will reference position to the nearest ½"
- 120" power cord

Options:

- specify Matte Black (MBK) or Arctic Silver (ASL) base finish
- reverse bevel edge available on desk approach side only, specify; add \$429 list for laminate or \$168 list for veneer; see page 8 for details
- top grommet available, specify location and add \$128 list each; see page 47 for details
- undermount power available, specify and add \$946 list; power infeed sold separately, see page 224

Pneumatic Adjustable Height Table Desk 	36	72	Adj.	194	18	FLT3672AHTD-PN	\$4,406		
	36	72	Adj.	194	18	FLV3672AHTD-PN		\$5,213	\$5,732
	30	72	Adj.	175	16	FLT3072AHTD-PN	\$4,315		
	30	72	Adj.	175	16	FLV3072AHTD-PN		\$4,988	\$5,487
	30	66	Adj.	168	15	FLT3066AHTD-PN	\$4,225		
	30	66	Adj.	168	15	FLV3066AHTD-PN		\$4,842	\$5,327
	30	60	Adj.	160	14	FLT3060AHTD-PN	\$4,127		
	30	60	Adj.	160	14	FLV3060AHTD-PN		\$4,688	\$5,155
	24	72	Adj.	151	12	FLT2472AHTD-PN	\$4,132		
	24	72	Adj.	151	12	FLV2472AHTD-PN		\$4,669	\$5,136
	24	66	Adj.	146	11	FLT2466AHTD-PN	\$4,095		
	24	66	Adj.	146	11	FLV2466AHTD-PN		\$4,588	\$5,047
	24	60	Adj.	140	10	FLT2460AHTD-PN	\$4,040		
	24	60	Adj.	140	10	FLV2460AHTD-PN		\$4,487	\$4,937

Features:

- eased edge profile on approach and user sides
- 27½" to 44½" height adjustment
- 20 lbs. lift force, maximum weight rating 140 lbs. (evenly distributed load)
- release lever mounts under edge of top

Options:

- specify Matte Black (MBK) or Alloy (ALY) base finish
- reverse bevel edge available on desk approach side only, specify; add \$429 list for laminate or \$168 list for veneer; see page 8 for details
- top grommet available, specify location; add \$128 list each; see page 47 for details

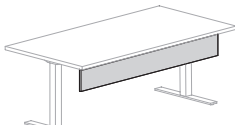
Description	D	W	H	CTN WT	CU FT	① Model	HPL Laminate	Flat Cut Veneer	Double Cut Veneer
Modesty Panels for Adjustable Height Tables 	¾	64	9	18	3	FLT0964TDM	\$437		
	¾	64	9	18	3	FLV0964TDM		\$728	\$801
	¾	58	9	16	2	FLT0958TDM	\$426		
	¾	58	9	16	2	FLV0958TDM		\$706	\$775
	¾	52	9	14	2	FLT0952TDM	\$412		
	¾	52	9	14	2	FLV0952TDM		\$682	\$750

Features:

- FLV0964TDM or FLT0964TDM use with 72" wide adjustable height table desk
- FLV0958TDM or FLT0958TDM use with 66" wide adjustable height table desk
- FLV0952TDM or FLT0952TDM use with 60" wide adjustable height table desk

Options:

- specify modesty panel bracket finish; Black Sandtex (BSX) or Stardust Silver (STS)

To Order, Specify:

① Laminate Model #	② Laminate Type	③ Laminate Selection	④ Metal Color	⑤ Other Product Options
Laminate (FLT)	HPL	See Laminate Selection	See Metal Finish Color Options	See list of options for each specific unit; Specify and add accordingly.

① Veneer Model #	② Wood Species	③ Wood Finish	④ Metal Color	⑤ Other Product Options
Veneer (FLV)	Flat Cut CH1 Cherry MA1 Maple WA1 Walnut BO1 Black Oak	See Flat Cut Wood Finish Options	See Metal Finish Color Options	See list of options for each specific unit; Specify and add accordingly.
		<table border="1"> <thead> <tr> <th>③a Wood Finish</th> <th>③b Chassis Grain Direction</th> </tr> </thead> <tbody> <tr> <td>See Double Cut Wood Finish Options</td> <td>For Double Cut Only: Vertical Horizontal</td> </tr> </tbody> </table>		
③a Wood Finish	③b Chassis Grain Direction			
See Double Cut Wood Finish Options	For Double Cut Only: Vertical Horizontal			

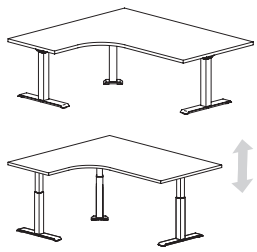
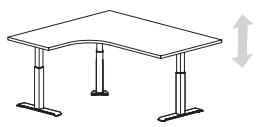
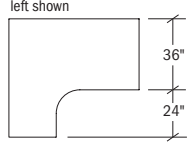
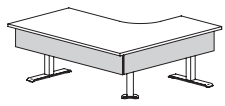
Description	D	W	H	CTN WT	CU FT	① Model	HPL Laminate	Flat Cut Veneer	Double Cut Veneer
Adjustable Height Corner Table - 90° One Piece Top   left shown   optional modesty panels	60	72	Adj.	259	33	FLT3672CT24AHR	\$4,119		
	60	72	Adj.	259	33	FLV3672CT24AHR		\$5,106	\$5,464
	60	72	Adj.	259	33	FLT3672CT24AHL	\$4,119		
	60	72	Adj.	259	33	FLV3672CT24AHL		\$5,106	\$5,464
	60	66	Adj.	240	31	FLT3666CT24AHR	\$4,040		
	60	66	Adj.	240	31	FLV3666CT24AHR		\$5,008	\$5,360
	60	66	Adj.	240	31	FLT3666CT24AHL	\$4,040		
	60	66	Adj.	240	31	FLV3666CT24AHL		\$5,008	\$5,360
	60	60	Adj.	231	28	FLT3660CT24AHR	\$3,962		
	60	60	Adj.	231	28	FLV3660CT24AHR		\$4,912	\$5,256
	60	60	Adj.	231	28	FLT3660CT24AHL	\$3,962		
	60	60	Adj.	231	28	FLV3660CT24AHL		\$4,912	\$5,256

Features:

- eased edge profile on approach and user sides
- 22½" to 49" height adjustment
- maximum weight rating 140 lbs. (evenly distributed load)
- key pad features height display with three memory settings; key pad mounts left or right
- display will reference position to the nearest ½"
- 120" power cord

Options:

- specify Matte Black (MBK) or Arctic Silver (ASL) base finish
- reverse bevel edge available on desk approach side only, specify; add \$429 list for laminate or \$168 list for veneer; see page 8 for details
- top grommet available, specify location and add \$128 list each; see page 47 for details
- modesty panel available (2-sides) moves with worksurface, specify \$889 list for laminate or \$1,430 list for veneer; see page 21 for details
- undermount power available, specify and add \$946 list; power infeed sold separately, see page 224

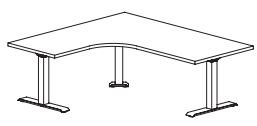
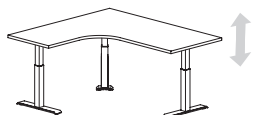
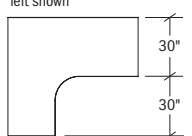
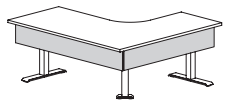
Adjustable Height Corner Table - 90° One Piece Top   left shown   optional modesty panels	60	72	Adj.	234	33	FLT3072CT30AHR	\$4,119		
	60	72	Adj.	234	33	FLV3072CT30AHR		\$5,106	\$5,464
	60	72	Adj.	234	33	FLT3072CT30AHL	\$4,119		
	60	72	Adj.	234	33	FLV3072CT30AHL		\$5,106	\$5,464
	60	66	Adj.	230	31	FLT3066CT30AHR	\$4,040		
	60	66	Adj.	230	31	FLV3066CT30AHR		\$5,008	\$5,360
	60	66	Adj.	230	31	FLT3066CT30AHL	\$4,040		
	60	66	Adj.	230	31	FLV3066CT30AHL		\$5,008	\$5,360
	60	60	Adj.	222	28	FLT3060CT30AHR	\$3,962		
	60	60	Adj.	222	28	FLV3060CT30AHR		\$4,912	\$5,256
	60	60	Adj.	222	28	FLT3060CT30AHL	\$3,962		
	60	60	Adj.	222	28	FLV3060CT30AHL		\$4,912	\$5,256

Features:

- eased edge profile on approach and user sides
- 22½" to 49" height adjustment
- maximum weight rating 140 lbs. (evenly distributed load)
- key pad features height display with three memory settings; key pad mounts left or right
- display will reference position to the nearest ½"
- 120" power cord

Options:

- specify Matte Black (MBK) or Arctic Silver (ASL) base finish
- reverse bevel edge available on desk approach side only, specify; add \$429 list for laminate or \$168 list for veneer; see page 8 for details
- top grommet available, specify location and add \$128 list each; see page 47 for details
- modesty panel available (2-sides) moves with worksurface, specify \$889 list for laminate or \$1,430 list for veneer; see page 21 for details
- undermount power available, specify and add \$946 list; power infeed sold separately, see page 224

Description	D	W	H	CTN WT	CU FT	① Model	HPL Laminate	Flat Cut Veneer	Double Cut Veneer
Adjustable Height Corner Table - 90° One Piece Top	60	72	Adj.	225	33	FLT2472CT36AHR	\$4,119		
	60	72	Adj.	225	33	FLV2472CT36AHR		\$5,106	\$5,464
	60	72	Adj.	225	33	FLT2472CT36AHL	\$4,119		
	60	72	Adj.	225	33	FLV2472CT36AHL		\$5,106	\$5,464
	60	66	Adj.	220	31	FLT2466CT36AHR	\$4,040		
	60	66	Adj.	220	31	FLV2466CT36AHR		\$5,008	\$5,360
	60	66	Adj.	220	31	FLT2466CT36AHL	\$4,040		
	60	66	Adj.	220	31	FLV2466CT36AHL		\$5,008	\$5,360
	60	60	Adj.	214	28	FLT2460CT36AHR	\$3,962		
	60	60	Adj.	214	28	FLV2460CT36AHR		\$4,912	\$5,256
	60	60	Adj.	214	28	FLT2460CT36AHL	\$3,962		
	60	60	Adj.	214	28	FLV2460CT36AHL		\$4,912	\$5,256

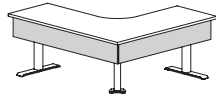
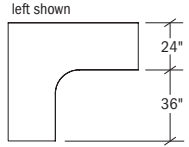
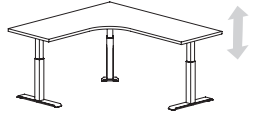
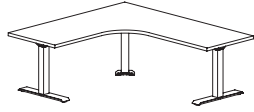

optional modesty panels

Features:

- eased edge profile on approach and user sides
- 22½" to 49" height adjustment
- maximum weight rating 140 lbs. (evenly distributed load)
- key pad features height display with three memory settings; key pad mounts left or right
- display will reference position to the nearest ½"
- 120" power cord



Options:

- specify Matte Black (MBK) or Arctic Silver (ASL) base finish
- reverse bevel edge available on desk approach side only, specify; add \$429 list for laminate or \$168 list for veneer; see page 8 for details
- top grommet available, specify location and add \$128 list each; see page 47 for details
- modesty panel available (2-sides) moves with worksurface, specify \$889 list for laminate or \$1,430 list for veneer; see page 21 for details
- undermount power available, specify and add \$946 list; power infeed sold separately, see page 224

To Order, Specify:

① Laminate Model #	② Laminate Type	③ Laminate Selection	④ Metal Color	⑤ Other Product Options
Laminate (FLT)	HPL	See Laminate Selection	See Metal Finish Color Options	See list of options for each specific unit; Specify and add accordingly.

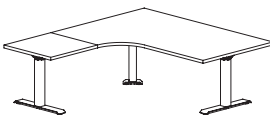
① Veneer Model #	② Wood Species	③ Wood Finish	④ Metal Color	⑤ Other Product Options
Veneer (FLV)	Flat Cut CH1 Cherry MA1 Maple WA1 Walnut BO1 Black Oak	See Flat Cut Wood Finish Options	See Metal Finish Color Options	See list of options for each specific unit; Specify and add accordingly.
		<table border="1"> <thead> <tr> <th>③a Wood Finish</th> <th>③b Chassis Grain Direction</th> </tr> </thead> <tbody> <tr> <td>See Double Cut Wood Finish Options</td> <td>For Double Cut Only: Vertical Horizontal</td> </tr> </tbody> </table>		
③a Wood Finish	③b Chassis Grain Direction			
See Double Cut Wood Finish Options	For Double Cut Only: Vertical Horizontal			

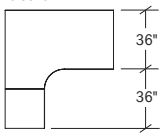
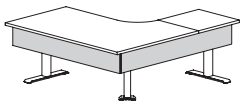
Description	D	W	H	CTN WT	CU FT	① Model	HPL Laminate	Flat Cut Veneer	Double Cut Veneer
Adjustable Height Corner Table - 90° Two Piece Top   left shown   optional modesty panels	72	72	Adj.	255	27	FLT3672CDT36R	\$4,216		
	72	72	Adj.	255	27	FLV3672CD36R		\$5,103	\$5,461
	72	72	Adj.	255	27	FLT3672CDT36L	\$4,216		
	72	72	Adj.	255	27	FLV3672CDT36L		\$5,227	\$5,594
	72	66	Adj.	247	25	FLT3666CDT36R	\$4,174		
	72	66	Adj.	247	25	FLV3666CDT36R		\$5,176	\$5,538
	72	66	Adj.	247	25	FLT3666CDT36L	\$4,174		
	72	66	Adj.	247	25	FLV3666CDT36L		\$5,176	\$5,538
	72	60	Adj.	237	23	FLT3660CDT36R	\$4,131		
	72	60	Adj.	237	23	FLV3660CDT36R		\$5,122	\$5,480
	72	60	Adj.	237	23	FLT3660CDT36L	\$4,131		
	72	60	Adj.	237	23	FLV3660CDT36L		\$5,122	\$5,480

Features:

- eased edge profile on approach and user sides
- 22½" to 49" height adjustment
- maximum weight rating 140 lbs. (evenly distributed load)
- key pad features height display with three memory settings; key pad mounts left or right
- display will reference position to the nearest ½"
- 120" power cord

Options:

- specify Matte Black (MBK) or Arctic Silver (ASL) base finish
- reverse bevel edge available on desk approach side only, specify; add \$429 list for laminate or \$168 list for veneer; see page 8 for details
- top grommet available, specify location and add \$128 list each; see page 47 for details
- modesty panel available (2-sides) moves with worksurface, specify \$889 list for laminate or \$1,430 list for veneer; see page 21 for details
- undermount power available, specify and add \$946 list; power infeed sold separately, see page 224

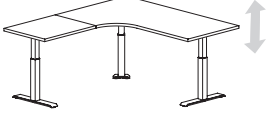
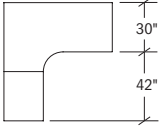
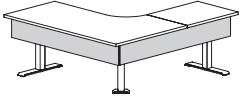
Adjustable Height Corner Table - 90° Two Piece Top   left shown   optional modesty panels	72	72	Adj.	223	24	FLT3072CDT42R	\$4,216		
	72	72	Adj.	223	24	FLV3072CDT42R		\$5,227	\$5,594
	72	72	Adj.	223	24	FLT3072CDT42L	\$4,216		
	72	72	Adj.	223	24	FLV3072CDT42L		\$5,227	\$5,594
	72	66	Adj.	213	22	FLT3066CDT42R	\$4,174		
	72	66	Adj.	213	22	FLV3066CDT42R		\$5,176	\$5,538
	72	66	Adj.	213	22	FLT3066CDT42L	\$4,174		
	72	66	Adj.	213	22	FLV3066CDT42L		\$5,176	\$5,538
	72	60	Adj.	203	21	FLT3060CDT42R	\$4,131		
	72	60	Adj.	203	21	FLV3060CDT42R		\$5,122	\$5,480
	72	60	Adj.	203	21	FLT3060CDT42L	\$4,131		
	72	60	Adj.	203	21	FLV3060CDT42L		\$5,122	\$5,480

Features:

- eased edge profile on approach and user sides
- 22½" to 49" height adjustment
- maximum weight rating 140 lbs. (evenly distributed load)
- key pad features height display with three memory settings; key pad mounts left or right
- display will reference position to the nearest ½"
- 120" power cord

Options:

- specify Matte Black (MBK) or Arctic Silver (ASL) base finish
- reverse bevel edge available on desk approach side only, specify; add \$429 list for laminate or \$168 list for veneer; see page 8 for details
- top grommet available, specify location and add \$128 list each; see page 47 for details
- modesty panel available (2-sides) moves with worksurface, specify \$889 list for laminate or \$1,430 list for veneer; see page 21 for details
- undermount power available, specify and add \$946 list; power infeed sold separately, see page 224

Description	D	W	H	CTN WT	CU FT	① Model	HPL Laminate	Flat Cut Veneer	Double Cut Veneer
Adjustable Height Corner Table - 90° Two Piece Top	72	72	Adj.	232	21	FLT2472CDT48R	\$4,216		
	72	72	Adj.	232	21	FLV2472CDT48R		\$5,227	\$5,594
	72	72	Adj.	232	21	FLT2472CDT48L	\$4,216		
	72	72	Adj.	232	21	FLV2472CDT48L		\$5,227	\$5,594
	72	66	Adj.	225	20	FLT2466CDT48R	\$4,174		
	72	66	Adj.	225	20	FLV2466CDT48R		\$5,176	\$5,538
	72	66	Adj.	225	20	FLT2466CDT48L	\$4,174		
	72	66	Adj.	225	20	FLV2466CDT48L		\$5,176	\$5,538
	72	60	Adj.	219	18	FLT2460CDT48R	\$4,131		
	72	60	Adj.	219	18	FLV2460CDT48R		\$5,122	\$5,480
	72	60	Adj.	219	18	FLT2460CDT48L	\$4,131		
	72	60	Adj.	219	18	FLV2460CDT48L		\$5,122	\$5,480

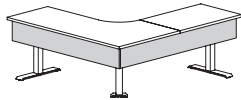
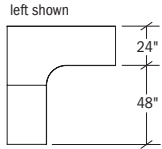
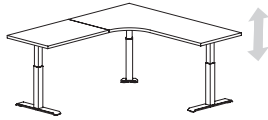

optional modesty panels

Features:

- eased edge profile on approach and user sides
- 22½" to 49" height adjustment
- maximum weight rating 140 lbs. (evenly distributed load)
- key pad features height display with three memory settings; key pad mounts left or right
- display will reference position to the nearest ½"
- 120" power cord

Options:

- specify Matte Black (MBK) or Arctic Silver (ASL) base finish
- reverse bevel edge available on desk approach side only, specify; add \$429 list for laminate or \$168 list for veneer; see page 8 for details
- top grommet available, specify location and add \$128 list each; see page 47 for details
- modesty panel available (2-sides) moves with worksurface, specify \$889 list for laminate or \$1,430 list for veneer; see page 21 for details
- undermount power available, specify and add \$946 list; power infeed sold separately, see page 224

To Order, Specify:

① Laminate Model #	② Laminate Type	③ Laminate Selection	④ Metal Color	⑤ Other Product Options
Laminate (FLT)	HPL	See Laminate Selection	See Metal Finish Color Options	See list of options for each specific unit; Specify and add accordingly.

① Veneer Model #	② Wood Species	③ Wood Finish	④ Metal Color	⑤ Other Product Options
Veneer (FLV)	Flat Cut CH1 Cherry MA1 Maple WA1 Walnut BO1 Black Oak	See Flat Cut Wood Finish Options	See Metal Finish Color Options	See list of options for each specific unit; Specify and add accordingly.
		<table border="1"> <thead> <tr> <th>ⓐ Wood Finish</th> <th>ⓑ Chassis Grain Direction</th> </tr> </thead> <tbody> <tr> <td>See Double Cut Wood Finish Options</td> <td>For Double Cut Only: Vertical Horizontal</td> </tr> </tbody> </table>		
ⓐ Wood Finish	ⓑ Chassis Grain Direction			
See Double Cut Wood Finish Options	For Double Cut Only: Vertical Horizontal			

Description	D	W	H	CTN WT	CU FT	① Model	HPL Laminate	Flat Cut Veneer	Double Cut Veneer
Adjustable Height Table & Return - 90° Two Piece Top	72	72	Adj.	253	20	FLT3672RTAH36R	\$3,396		
	72	72	Adj.	253	20	FLV3672RTAH36R		\$4,212	\$4,506
	72	72	Adj.	253	20	FLT3672RTAH36L	\$3,396		
	72	72	Adj.	253	20	FLV3672RTAH36L		\$4,212	\$4,506
	72	66	Adj.	248	19	FLT3666RTAH36R	\$3,357		
	72	66	Adj.	248	19	FLV3666RTAH36R		\$4,162	\$4,449
	72	66	Adj.	248	19	FLT3666RTAH36L	\$3,357		
	72	66	Adj.	248	19	FLV3666RTAH36L		\$4,162	\$4,449
	72	60	Adj.	239	17	FLT3660RTAH36R	\$3,318		
	72	60	Adj.	239	17	FLV3660RTAH36R		\$4,113	\$4,401
	72	60	Adj.	239	17	FLT3660RTAH36L	\$3,318		
	72	60	Adj.	239	17	FLV3660RTAH36L		\$4,113	\$4,401

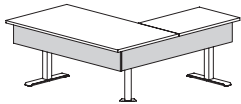
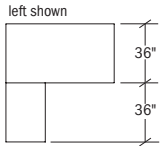
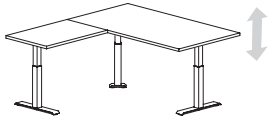

optional modesty panels

Features:

- eased edge profile on approach and user sides
- 22½" to 49" height adjustment
- maximum weight rating 140 lbs. (evenly distributed load)
- key pad features height display with three memory settings; key pad mounts left or right
- display will reference position to the nearest ½"
- 120" power cord

Options:

- specify Matte Black (MBK) or Arctic Silver (ASL) base finish
- reverse bevel edge available on desk approach side only, specify; add \$429 list for laminate or \$168 list for veneer; see page 8 for details
- top grommet available, specify location and add \$128 list each; see page 47 for details
- modesty panel available (2-sides) moves with worksurface, specify \$889 list for laminate or \$1,430 list for veneer; see page 21 for details
- undermount power available, specify and add \$946 list; power infeed sold separately, see page 224

Adjustable Height Table & Return - 90° Two Piece Top	72	72	Adj.	242	18	FLT3072RTAH42R	\$3,327		
	72	72	Adj.	242	18	FLV3072RTAH42R		\$4,127	\$4,416
	72	72	Adj.	242	18	FLT3072RTAH42L	\$3,327		
	72	72	Adj.	242	18	FLV3072RTAH42L		\$4,127	\$4,416
	72	66	Adj.	233	17	FLT3066RTAH42R	\$3,290		
	72	66	Adj.	233	17	FLV3066RTAH42R		\$4,079	\$4,364
	72	66	Adj.	233	17	FLT3066RTAH42L	\$3,290		
	72	66	Adj.	233	17	FLV3066RTAH42L		\$4,079	\$4,364
	72	60	Adj.	224	16	FLT3060RTAH42R	\$3,250		
	72	60	Adj.	224	16	FLV3060RTAH42R		\$4,031	\$4,312
	72	60	Adj.	224	16	FLT3060RTAH42L	\$3,250		
	72	60	Adj.	224	16	FLV3060RTAH42L		\$4,031	\$4,312

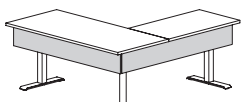
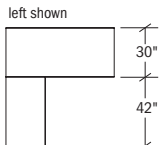
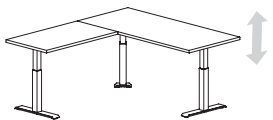
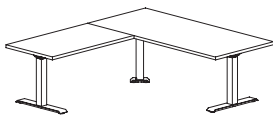

optional modesty panels

Features:

- eased edge profile on approach and user sides
- 22½" to 49" height adjustment
- maximum weight rating 140 lbs. (evenly distributed load)
- key pad features height display with three memory settings; key pad mounts left or right
- display will reference position to the nearest ½"
- 120" power cord

Options:

- specify Matte Black (MBK) or Arctic Silver (ASL) base finish
- reverse bevel edge available on desk approach side only, specify; add \$429 list for laminate or \$168 list for veneer; see page 8 for details
- top grommet available, specify location and add \$128 list each; see page 47 for details
- modesty panel available (2-sides) moves with worksurface, specify \$889 list for laminate or \$1,430 list for veneer; see page 21 for details
- undermount power available, specify and add \$946 list; power infeed sold separately, see page 224

Description	D	W	H	CTN WT	CU FT	① Model	HPL Laminate	Flat Cut Veneer	Double Cut Veneer
Adjustable Height Table & Return - 90° Two Piece Top	72	72	Adj.	231	15	FLT2472RTAH48R	\$3,262		
	72	72	Adj.	231	15	FLV2472RTAH48R		\$4,044	\$4,328
	72	72	Adj.	231	15	FLT2472RTAH48L	\$3,262		
	72	72	Adj.	231	15	FLV2472RTAH48L		\$4,044	\$4,328
	72	66	Adj.	225	14	FLT2466RTAH48R	\$3,225		
	72	66	Adj.	225	14	FLV2466RTAH48R		\$3,997	\$4,277
	72	66	Adj.	225	14	FLT2466RTAH48L	\$3,225		
	72	66	Adj.	225	14	FLV2466RTAH48L		\$3,997	\$4,277
	72	60	Adj.	219	13	FLT2460RTAH48R	\$3,185		
	72	60	Adj.	219	13	FLV2460RTAH48R		\$3,948	\$4,224
	72	60	Adj.	219	13	FLT2460RTAH48L	\$3,185		
	72	60	Adj.	219	13	FLV2460RTAH48L		\$3,948	\$4,224

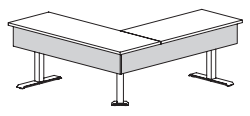
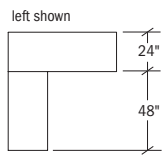
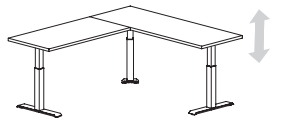
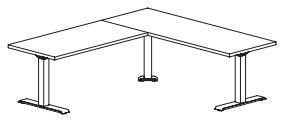

optional modesty panels

Features:

- eased edge profile on approach and user sides
- 22½" to 49" height adjustment
- maximum weight rating 140 lbs. (evenly distributed load)
- key pad features height display with three memory settings; key pad mounts left or right
- display will reference position to the nearest ½"
- 120" power cord

Options:

- specify Matte Black (MBK) or Arctic Silver (ASL) base finish
- reverse bevel edge available on desk approach side only, specify; add \$429 list for laminate or \$168 list for veneer; see page 8 for details
- top grommet available, specify location and add \$128 list each; see page 47 for details
- modesty panel available (2-sides) moves with worksurface, specify \$889 list for laminate or \$1,430 list for veneer; see page 21 for details
- undermount power available, specify and add \$946 list; power infeed sold separately, see page 224

To Order, Specify:

① Laminate Model #	② Laminate Type	③ Laminate Selection	④ Metal Color	⑤ Other Product Options
Laminate (FLT)	HPL	See Laminate Selection	See Metal Finish Color Options	See list of options for each specific unit; Specify and add accordingly.

① Veneer Model #	② Wood Species	③ Wood Finish	④ Metal Color	⑤ Other Product Options
Veneer (FLV)	Flat Cut CH1 Cherry MA1 Maple WA1 Walnut BO1 Black Oak	See Flat Cut Wood Finish Options	See Metal Finish Color Options	See list of options for each specific unit; Specify and add accordingly.
		<table border="1"> <thead> <tr> <th>ⓐ Wood Finish</th> <th>ⓑ Chassis Grain Direction</th> </tr> </thead> <tbody> <tr> <td>See Double Cut Wood Finish Options</td> <td>For Double Cut Only: Vertical Horizontal</td> </tr> </tbody> </table>		
ⓐ Wood Finish	ⓑ Chassis Grain Direction			
See Double Cut Wood Finish Options	For Double Cut Only: Vertical Horizontal			

FLUX - PRIVATE OFFICE

Description	D	W	H	CTN WT	CU FT	① Model	List Price
3 Prong Plug - 110 Power Infeed for Link System	-	72	-	1	1	EC-PI-L-72-A	\$264

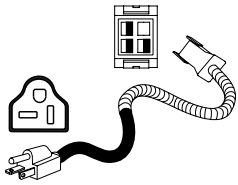

Features:

- 72" plug power infeed
- 20 amps/110 volts max
- 3 prong plug - 15 amp adapter plug
- single circuit use only
- use in conjunction with other link electrical items

plug included:
15 amp adapter

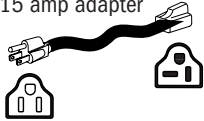

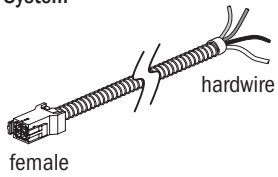

Hardwire Power Infeed for Link System	-	72	-	1	1	EC-PI-L-72-H	\$171
---------------------------------------	---	----	---	---	---	--------------	-------

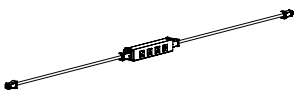
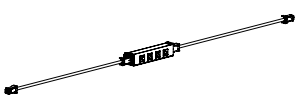
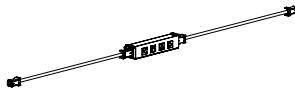

Features:

- 72" hardwire power infeed
- 20 amps/120 volts max
- single or two circuit
- electrical contractor responsible for connection to building power source
- use in conjunction with other link electrical items

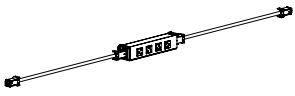
Description	D	W	H	CTN WT	CU FT	① Model	List Price
72" Power Link Kits - Circuit 1  <ul style="list-style-type: none"> · use with 72" tables · 72" plug power infeed · 20 amps/110 volts max · 3 prong plug - 15 amp adapter plug · Circuit 1 						ECAH-72UP-1	\$898
72" Power Link Kits - Circuit 2  <ul style="list-style-type: none"> · use with 72" tables · 72" plug power infeed · 20 amps/110 volts max · 3 prong plug - 15 amp adapter plug · Circuit 2 						ECAH-72UP-2	\$898
66" Power Link Kits - Circuit 1  <ul style="list-style-type: none"> · use with 66" tables · 72" plug power infeed · 20 amps/110 volts max · 3 prong plug - 15 amp adapter plug · Circuit 1 						ECAH-66UP-1	\$881
66" Power Link Kits - Circuit 2  <ul style="list-style-type: none"> · use with 66" tables · 72" plug power infeed · 20 amps/110 volts max · 3 prong plug - 15 amp adapter plug · Circuit 2 						ECAH-66UP-2	\$881
60" Power Link Kits - Circuit 1  <ul style="list-style-type: none"> · use with 60" tables · 72" plug power infeed · 20 amps/110 volts max · 3 prong plug - 15 amp adapter plug · Circuit 1 						ECAH-60UP-1	\$864
60" Power Link Kits - Circuit 2  <ul style="list-style-type: none"> · use with 60" tables · 72" plug power infeed · 20 amps/110 volts max · 3 prong plug - 15 amp adapter plug · Circuit 2 						ECAH-60UP-2	\$864

FLUX - PRIVATE OFFICE

To Order, Specify:

① Model Number	
----------------	--

Description	D	W	H	CTN WT	CU FT	① Model	HPL Laminate	Flat Cut Veneer	Double Cut Veneer
Adjustable Height Freestanding Desk Shell with Flush Modesty Panel	36	72	Adj.	305	51	FLT3672AHFDS	\$5,863		
	36	72	Adj.	305	51	FLV3672AHFDS		\$7,589	\$8,349
	36	66	Adj.	292	47	FLT3666AHFDS	\$5,826		
	36	66	Adj.	292	47	FLV3666AHFDS		\$7,539	\$8,292
	36	60	Adj.	279	43	FLT3660AHFDS	\$5,793		
	36	60	Adj.	279	43	FLV3660AHFDS		\$7,489	\$8,238

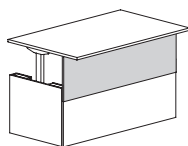
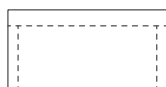
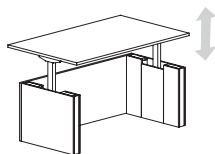
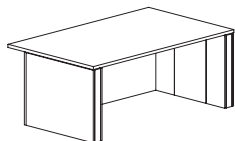

optional 20" modesty

Features:

- eased edge profile on approach and user sides
- 29" to 47" height adjustment with digital controller, wire guide and 10' power cord
- maximum weight rating 140 lbs. (evenly distributed load)

Options:

- must specify chassis grain direction on double cut veneer, see pages 11-13 for details
- reverse bevel edge available on desk approach side only, specify; add \$429 list for laminate or \$168 list for veneer; see page 8 for details
- 20"h modesty panel available, moves with worksurface, specify \$427 list for laminate or \$594 list for veneer; see page 15 for details
- top grommet available, specify location; add \$128 list each; see page 47 for details

FLUX - PRIVATE OFFICE

Adjustable Height Freestanding Desk Shell with Flush Modesty Panel	30	72	Adj.	283	43	FLT3072AHFDS	\$5,693		
	30	72	Adj.	283	43	FLV3072AHFDS		\$7,362	\$8,100
	30	66	Adj.	271	40	FLT3066AHFDS	\$5,662		
	30	66	Adj.	271	40	FLV3066AHFDS		\$7,317	\$8,049
	30	60	Adj.	259	36	FLT3060AHFDS	\$5,631		
	30	60	Adj.	259	36	FLV3060AHFDS		\$7,274	\$7,999

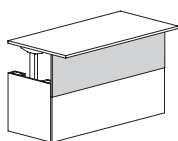
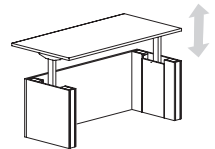
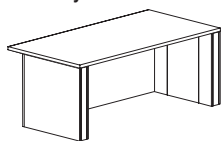

optional 20" modesty

Features:

- eased edge profile on approach and user sides
- 29" to 47" height adjustment with digital controller, wire guide and 10' power cord
- maximum weight rating 140 lbs. (evenly distributed load)

Options:

- must specify chassis grain direction on double cut veneer, see pages 11-13 for details
- reverse bevel edge available on desk approach side only, specify; add \$429 list for laminate or \$168 list for veneer; see page 8 for details
- 20"h modesty panel available, moves with worksurface, specify \$427 list for laminate or \$594 list for veneer; see page 15 for details
- top grommet available, specify location; add \$128 list each; see page 47 for details

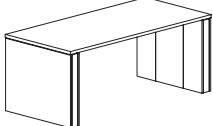
Description	D	W	H	CTN WT	CU FT	① Model	HPL Laminate	Flat Cut Veneer	Double Cut Veneer
Adjustable Height Freestanding Table 	33 1/2	72	Adj.	261	48	FLT3472AHFT	\$5,869		
	33 1/2	72	Adj.	261	48	FLV3472AHFT		\$7,604	\$8,362
	33 1/2	66	Adj.	253	44	FLT3466AHFT	\$5,834		
	33 1/2	66	Adj.	253	44	FLV3466AHFT		\$7,550	\$8,307
	33 1/2	60	Adj.	245	40	FLT3460AHFT	\$5,806		
	33 1/2	60	Adj.	245	40	FLV3460AHFT		\$7,501	\$8,252

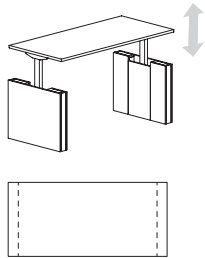

Features:

- eased edge profile on approach and user sides
- 29" to 47" height adjustment with digital controller, wire guide and 10' power cord
- maximum weight rating 140 lbs. (evenly distributed load)

Options:

- must specify chassis grain direction on double cut veneer, see pages 11-13 for details
- reverse bevel edge available on desk approach side only, specify; add \$429 list for laminate or \$168 list for veneer; see page 8 for details
- 13 1/2" h modesty panel available, moves with worksurface, specify \$427 list for laminate or \$594 list for veneer; see page 15 for details
- top grommet available, specify location; add \$128 list each; see page 47 for details

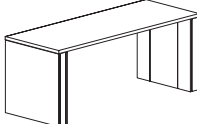
Adjustable Height Freestanding Table 	27 1/2	72	Adj.	227	40	FLT2872AHFT	\$5,698		
	27 1/2	72	Adj.	227	40	FLV2872AHFT		\$7,374	\$8,112
	27 1/2	66	Adj.	220	37	FLT2866AHFT	\$5,667		
	27 1/2	66	Adj.	220	37	FLV2866AHFT		\$7,326	\$8,061
	27 1/2	60	Adj.	213	34	FLT2860AHFT	\$5,637		
	27 1/2	60	Adj.	213	34	FLV2860AHFT		\$7,283	\$8,013

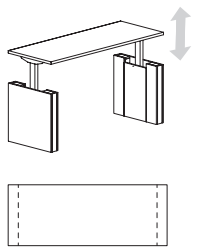

Features:

- eased edge profile on approach and user sides
- 29" to 47" height adjustment with digital controller, wire guide and 10' power cord
- maximum weight rating 140 lbs. (evenly distributed load)

Options:

- must specify chassis grain direction on double cut veneer, see pages 11-13 for details
- reverse bevel edge available on desk approach side only, specify; add \$429 list for laminate or \$168 list for veneer; see page 8 for details
- 13 1/2" h modesty panel available, moves with worksurface, specify \$427 list for laminate or \$594 list for veneer; see page 15 for details
- top grommet available, specify location; add \$128 list each; see page 47 for details

To Order, Specify:

① Laminate Model #	② Laminate Type	③ Laminate Selection	④ Metal Color	⑤ Other Product Options
Laminate (FLT)	HPL	See Laminate Selection	See Metal Finish Color Options	See list of options for each specific unit; Specify and add accordingly.

① Veneer Model #	② Wood Species	③ Wood Finish	④ Metal Color	⑤ Other Product Options
Veneer (FLV)	Flat Cut CH1 Cherry MA1 Maple WA1 Walnut BO1 Black Oak	See Flat Cut Wood Finish Options	See Metal Finish Color Options	See list of options for each specific unit; Specify and add accordingly.
		<table border="1"> <thead> <tr> <th>ⓐ Wood Finish</th> <th>ⓑ Chassis Grain Direction</th> </tr> </thead> <tbody> <tr> <td>See Double Cut Wood Finish Options</td> <td>For Double Cut Only: Vertical Horizontal</td> </tr> </tbody> </table>		
ⓐ Wood Finish	ⓑ Chassis Grain Direction			
See Double Cut Wood Finish Options	For Double Cut Only: Vertical Horizontal			

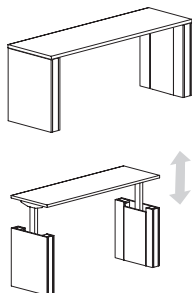
Description	D	W	H	CTN WT	CU FT	① Model	HPL Laminate	Flat Cut Veneer	Double Cut Veneer
Adjustable Height Credenza Shell 	22	72	Adj.	251	32	FLT2272-29FAHC	\$5,693		
	22	72	Adj.	251	32	FLV2272-29FAHC		\$7,362	\$8,100
	22	66	Adj.	243	30	FLT2266-29FAHC	\$5,662		
	22	66	Adj.	243	30	FLV2266-29FAHC		\$7,317	\$8,049
	22	60	Adj.	233	27	FLT2260-29FAHC	\$5,631		
	22	60	Adj.	233	27	FLV2260-29FAHC		\$7,274	\$7,999
	22	54	Adj.	222	25	FLT2254-29FAHC	\$5,603		
	22	54	Adj.	222	25	FLV2254-29FAHC		\$7,231	\$7,953
	22	48	Adj.	205	22	FLT2248-29FAHC	\$5,577		
22	48	Adj.	205	22	FLV2248-29FAHC		\$7,189	\$7,908	

Features:

- use to expand work station
- eased edge profile user side
- 29" to 47" height adjustment with digital controller, wire guide and 10' power cord

Options:

- must specify chassis grain direction on double cut veneer, see pages 11-13 for details
- top grommet available, specify location; add \$128 list each; see page 47 for details

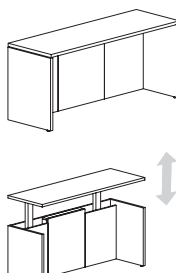
Adjustable Height Credenza Extension 	22	72	Adj.	261	32	FLT2272-29FAHCE	\$4,809		
	22	72	Adj.	261	32	FLV2272-29FAHCE		\$5,995	\$6,593
	22	66	Adj.	249	30	FLT2266-29FAHCE	\$4,778		
	22	66	Adj.	249	30	FLV2266-29FAHCE		\$5,953	\$6,547
	22	60	Adj.	242	27	FLT2260-29FAHCE	\$4,751		
	22	60	Adj.	242	27	FLV2260-29FAHCE		\$5,914	\$6,503
	22	54	Adj.	232	25	FLT2254-29FAHCE	\$4,723		
	22	54	Adj.	232	25	FLV2254-29FAHCE		\$5,872	\$6,459
	22	48	Adj.	226	22	FLT2248-29FAHCE	\$4,696		
	22	48	Adj.	226	22	FLV2248-29FAHCE		\$5,832	\$6,416

Features:

- use to expand work station
- eased edge profile user side
- 29" to 47" height adjustment with digital controller, wire guide and 10' power cord

Options:

- must specify chassis grain direction on double cut veneer, see pages 11-13 for details
- top grommet available, specify location; add \$128 list each; see page 47 for details
- wall access cutouts available, specify and add \$231 list

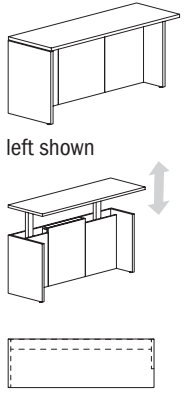
Description	D	W	H	CTN WT	CU FT	① Model	HPL Laminate	Flat Cut Veneer	Double Cut Veneer
Adjustable Height Return Shell  left shown	22	72	Adj.	220	33	FLT2272-29FAHRR	\$4,809		
	22	72	Adj.	220	33	FLV2272-29FAHRR		\$5,995	\$6,593
	22	72	Adj.	220	33	FLT2272-29FAHRL	\$4,809		
	22	72	Adj.	220	33	FLV2272-29FAHRL		\$5,995	\$6,593
	22	66	Adj.	208	30	FLT2266-29FAHRR	\$4,778		
	22	66	Adj.	208	30	FLV2266-29FAHRR		\$5,953	\$6,547
	22	66	Adj.	208	30	FLT2266-29FAHRL	\$4,778		
	22	66	Adj.	208	30	FLV2266-29FAHRL		\$5,953	\$6,547
	22	60	Adj.	196	27	FLT2260-29FAHRR	\$4,751		
	22	60	Adj.	196	27	FLV2260-29FAHRR		\$5,914	\$6,503
	22	60	Adj.	196	27	FLT2260-29FAHRL	\$4,751		
	22	60	Adj.	196	27	FLV2260-29FAHRL		\$5,914	\$6,503
	22	54	Adj.	184	25	FLT2254-29FAHRR	\$4,723		
	22	54	Adj.	184	25	FLV2254-29FAHRR		\$5,872	\$6,459
	22	54	Adj.	184	25	FLT2254-29FAHRL	\$4,723		
	22	54	Adj.	184	25	FLV2254-29FAHRL		\$5,872	\$6,459
	22	48	Adj.	172	22	FLT2248-29FAHRR	\$4,696		
	22	48	Adj.	172	22	FLV2248-29FAHRR		\$5,832	\$6,416
	22	48	Adj.	172	22	FLT2248-29FAHRL	\$4,696		
	22	48	Adj.	172	22	FLV2248-29FAHRL		\$5,832	\$6,416

Features:

- must be used with desk
- laminate tops wider than 60" are long grain
- 29" to 47" height adjustment with digital controller, wire guide and 10' power cord
- maximum weight rating 100 lbs. (evenly distributed load)

Options:

- must specify chassis grain direction on double cut veneer, see pages 11-13 for details
- top grommet available, specify location; add \$128 list each; see page 46 for details
- wall access cutouts available, specify and add \$231 list

To Order, Specify:

① Laminate Model #	② Laminate Type	③ Laminate Selection	④ Metal Color	⑤ Other Product Options
Laminate (FLT)	HPL	See Laminate Selection	See Metal Finish Color Options	See list of options for each specific unit; Specify and add accordingly.

① Veneer Model #	② Wood Species	③ Wood Finish	④ Metal Color	⑤ Other Product Options
Veneer (FLV)	Flat Cut CH1 Cherry MA1 Maple WA1 Walnut BO1 Black Oak	See Flat Cut Wood Finish Options	See Metal Finish Color Options	See list of options for each specific unit; Specify and add accordingly.
		<table border="1"> <thead> <tr> <th>ⓐ Wood Finish</th> <th>ⓑ Chassis Grain Direction</th> </tr> </thead> <tbody> <tr> <td>See Double Cut Wood Finish Options</td> <td>For Double Cut Only: Vertical Horizontal</td> </tr> </tbody> </table>		
ⓐ Wood Finish	ⓑ Chassis Grain Direction			
See Double Cut Wood Finish Options	For Double Cut Only: Vertical Horizontal			

FLUX - PRIVATE OFFICE

Description	D	W	H	CTN WT	CU FT	① Model	HPL Laminate	Flat Cut Veneer	Double Cut Veneer
Adjustable Height U-Configuration Desk and Bridge	80	72	Adj.	470	110	FLT3672-U44AHR	\$8,534		
	80	72	Adj.	470	110	FLV3672-U44AHR		\$10,874	\$11,960
	80	72	Adj.	470	110	FLT3672-U44AHL	\$8,534		
	80	72	Adj.	470	110	FLV3672-U44AHL		\$10,874	\$11,960
	80	66	Adj.	433	101	FLT3666-U44AHR	\$8,431		
	80	66	Adj.	433	101	FLV3666-U44AHR		\$10,726	\$11,798
	80	66	Adj.	433	101	FLT3666-U44AHL	\$8,431		
	80	66	Adj.	433	101	FLV3666-U44AHL		\$10,726	\$11,798
	80	60	Adj.	419	92	FLT3660-U44AHR	\$8,331		
	80	60	Adj.	419	92	FLV3660-U44AHR		\$10,581	\$11,641
	80	60	Adj.	419	92	FLT3660-U44AHL	\$8,331		
	80	60	Adj.	419	92	FLV3660-U44AHL		\$10,581	\$11,641

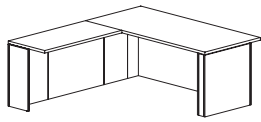

left shown

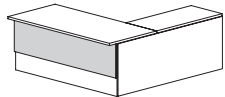
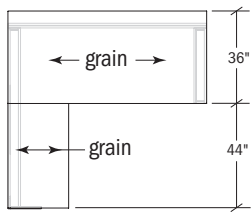
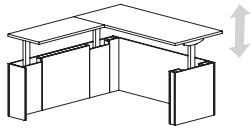

20" h optional modesty

Features:

- must attach to open corner credenza
- eased edge profile on approach and user sides
- 29" to 47" height adjustment with digital controller, wire guide and 10' power cord
- maximum weight rating 210 lbs. (evenly distributed load)

Options:

- must specify chassis grain direction on double cut veneer, see pages 11-13 for details
- reverse bevel edge available on desk approach side only, specify; add \$429 list for laminate or \$168 list for veneer; see page 8 for details
- 20" h modesty panel available, moves with worksurface, specify \$427 list for laminate or \$594 list for veneer; see page 15 for details
- top grommet available, specify location; add \$128 list each; see page 47 for details
- wall access cutouts available, specify and add \$231 list

FLUX - PRIVATE OFFICE

Description	D	W	H	CTN WT	CU FT	① Model	HPL Laminate	Flat Cut Veneer	Double Cut Veneer
Adjustable Height U-Configuration Desk and Bridge	74	72	Adj.	452	102	FLT3672-U38AHR	\$8,503		
	74	72	Adj.	452	102	FLV3672-U38AHR		\$10,827	\$11,910
	74	72	Adj.	452	102	FLT3672-U38AHL	\$8,503		
	74	72	Adj.	452	102	FLV3672-U38AHL		\$10,827	\$11,910
	74	66	Adj.	415	94	FLT3666-U38AHR	\$8,399		
	74	66	Adj.	415	94	FLV3666-U38AHR		\$10,679	\$11,749
	74	66	Adj.	415	94	FLT3666-U38AHL	\$8,399		
	74	66	Adj.	415	94	FLV3666-U38AHL		\$10,679	\$11,749
	74	60	Adj.	401	86	FLT3660-U38AHR	\$8,297		
	74	60	Adj.	401	86	FLV3660-U38AHR		\$10,535	\$11,588
	74	60	Adj.	401	86	FLT3660-U38AHL	\$8,297		
	74	60	Adj.	401	86	FLV3660-U38AHL		\$10,535	\$11,588

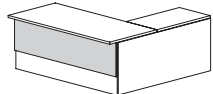
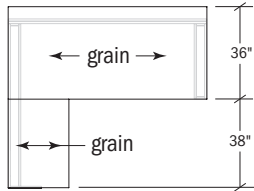
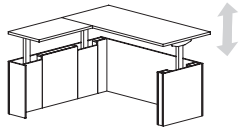
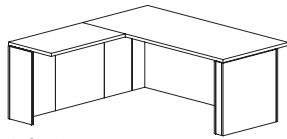

20" h optional modesty

Features:

- must attach to open corner credenza
- eased edge profile on approach and user sides
- 29" to 47" height adjustment with digital controller, wire guide and 10' power cord
- maximum weight rating 210 lbs. (evenly distributed load)

Options:

- must specify chassis grain direction on double cut veneer, see pages 11-13 for details
- reverse bevel edge available on desk approach side only, specify; add \$429 list for laminate or \$168 list for veneer; see page 8 for details
- 20" h modesty panel available, moves with worksurface, specify \$427 list for laminate or \$594 list for veneer; see page 15 for details
- top grommet available, specify location; add \$128 list each; see page 47 for details
- wall access cutouts available, specify and add \$231 list

To Order, Specify:

① Laminate Model #	② Laminate Type	③ Laminate Selection	④ Metal Color	⑤ Other Product Options
Laminate (FLT)	HPL	See Laminate Selection	See Metal Finish Color Options	See list of options for each specific unit; Specify and add accordingly.

① Veneer Model #	② Wood Species	③ Wood Finish	④ Metal Color	⑤ Other Product Options
Veneer (FLV)	Flat Cut CH1 Cherry MA1 Maple WA1 Walnut BO1 Black Oak	See Flat Cut Wood Finish Options	See Metal Finish Color Options	See list of options for each specific unit; Specify and add accordingly.
		<table border="1"> <thead> <tr> <th>③a Wood Finish</th> <th>③b Chassis Grain Direction</th> </tr> </thead> <tbody> <tr> <td>See Double Cut Wood Finish Options</td> <td>For Double Cut Only: Vertical Horizontal</td> </tr> </tbody> </table>		
③a Wood Finish	③b Chassis Grain Direction			
See Double Cut Wood Finish Options	For Double Cut Only: Vertical Horizontal			

Description	D	W	H	CTN WT	CU FT	① Model	HPL Laminate	Flat Cut Veneer	Double Cut Veneer
Adjustable Height U-Configuration Desk and Bridge	74	72	Adj.	433	102	FLT3072-U44AHR	\$8,290		
	74	72	Adj.	433	102	FLV3072-U44AHR		\$10,593	\$11,651
	74	72	Adj.	433	102	FLT3072-U44AHL	\$8,290		
	74	72	Adj.	433	102	FLV3072-U44AHL		\$10,593	\$11,651
	74	66	Adj.	396	94	FLT3066-U44AHR	\$8,188		
	74	66	Adj.	396	94	FLV3066-U44AHR		\$10,446	\$11,490
	74	66	Adj.	396	94	FLT3066-U44AHL	\$8,188		
	74	66	Adj.	396	94	FLV3066-U44AHL		\$10,446	\$11,490
	74	60	Adj.	382	86	FLT3060-U44AHR	\$8,088		
	74	60	Adj.	382	86	FLV3060-U44AHR		\$10,299	\$11,330
	74	60	Adj.	382	86	FLT3060-U44AHL	\$8,088		
	74	60	Adj.	382	86	FLV3060-U44AHL		\$10,299	\$11,330

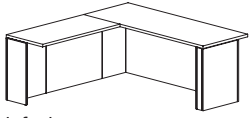

left shown

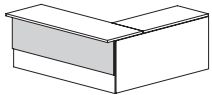
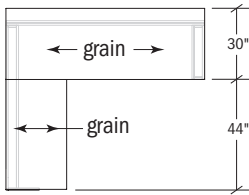
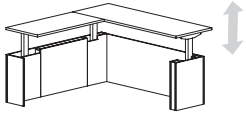

20"h optional modesty

Features:

- must attach to open corner credenza
- eased edge profile on approach and user sides
- 29" to 47" height adjustment with digital controller, wire guide and 10' power cord
- maximum weight rating 210 lbs. (evenly distributed load)

Options:

- must specify chassis grain direction on double cut veneer, see pages 11-13 for details
- reverse bevel edge available on desk approach side only, specify; add \$429 list for laminate or \$168 list for veneer; see page 8 for details
- 20"h modesty panel available, moves with worksurface, specify \$427 list for laminate or \$594 list for veneer; see page 15 for details
- top grommet available, specify location; add \$128 list each; see page 47 for details
- wall access cutouts available, specify and add \$231 list

FLUX - PRIVATE OFFICE

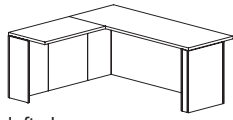
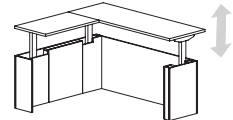
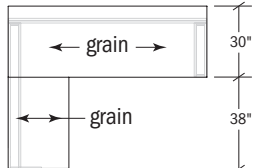
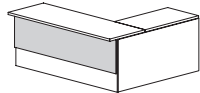
Description	D	W	H	CTN WT	CU FT	① Model	HPL Laminate	Flat Cut Veneer	Double Cut Veneer
Adjustable Height U-Configuration Desk and Bridge left shown     20" h optional modesty	68	72	Adj.	415	94	FLT3072-U38AHR	\$8,260		
	68	72	Adj.	415	94	FLV3072-U38AHR		\$10,545	\$11,600
	68	72	Adj.	415	94	FLT3072-U38AHL	\$8,260		
	68	72	Adj.	415	94	FLV3072-U38AHL		\$10,545	\$11,600
	68	66	Adj.	378	87	FLT3066-U38AHR	\$8,157		
	68	66	Adj.	378	87	FLV3066-U38AHR		\$10,400	\$11,438
	68	66	Adj.	378	87	FLT3066-U38AHL	\$8,157		
	68	66	Adj.	378	87	FLV3066-U38AHL		\$10,400	\$11,438
	68	60	Adj.	364	79	FLT3060-U38AHR	\$8,055		
	68	60	Adj.	364	79	FLV3060-U38AHR		\$10,254	\$11,277
	68	60	Adj.	364	79	FLT3060-U38AHL	\$8,055		
	68	60	Adj.	364	79	FLV3060-U38AHL		\$10,254	\$11,277

Features:

- must attach to open corner credenza
- eased edge profile on approach and user sides
- 29" to 47" height adjustment with digital controller, wire guide and 10' power cord
- maximum weight rating 210 lbs. (evenly distributed load)

Options:

- must specify chassis grain direction on double cut veneer, see pages 11-13 for details
- reverse bevel edge available on desk approach side only, specify; add \$429 list for laminate or \$168 list for veneer; see page 8 for details
- 20" h modesty panel available, moves with worksurface, specify \$427 list for laminate or \$594 list for veneer; see page 15 for details
- top grommet available, specify location; add \$128 list each; see page 47 for details
- wall access cutouts available, specify and add \$231 list

To Order, Specify:

① Laminate Model #	② Laminate Type	③ Laminate Selection	④ Metal Color	⑤ Other Product Options
Laminate (FLT)	HPL	See Laminate Selection	See Metal Finish Color Options	See list of options for each specific unit; Specify and add accordingly.

① Veneer Model #	② Wood Species	③ Wood Finish	④ Metal Color	⑤ Other Product Options
Veneer (FLV)	Flat Cut CH1 Cherry MA1 Maple WA1 Walnut BO1 Black Oak	See Flat Cut Wood Finish Options	See Metal Finish Color Options	See list of options for each specific unit; Specify and add accordingly.
		<table border="1"> <thead> <tr> <th>③a Wood Finish</th> <th>③b Chassis Grain Direction</th> </tr> </thead> <tbody> <tr> <td>See Double Cut Wood Finish Options</td> <td>For Double Cut Only: Vertical Horizontal</td> </tr> </tbody> </table>		
③a Wood Finish	③b Chassis Grain Direction			
See Double Cut Wood Finish Options	For Double Cut Only: Vertical Horizontal			

Description	D	W	H	CTN WT	CU FT	① Model	HPL Laminate	Flat Cut Veneer	Double Cut Veneer
Adjustable Height L-Configuration Desk and Return	80	72	Adj.	481	110	FLT3672-L44AHR	\$8,534		
	80	72	Adj.	481	110	FLV3672-L44AHR		\$10,874	\$11,960
	80	72	Adj.	481	110	FLT3672-L44AHL	\$8,534		
	80	72	Adj.	481	110	FLV3672-L44AHL		\$10,874	\$11,960
	80	66	Adj.	444	101	FLT3666-L44AHR	\$8,431		
	80	66	Adj.	444	101	FLV3666-L44AHR		\$10,726	\$11,798
	80	66	Adj.	444	101	FLT3666-L44AHL	\$8,431		
	80	66	Adj.	444	101	FLV3666-L44AHL		\$10,726	\$11,798
	80	60	Adj.	430	92	FLT3660-L44AHR	\$8,331		
	80	60	Adj.	430	92	FLV3660-L44AHR		\$10,581	\$11,641
	80	60	Adj.	430	92	FLT3660-L44AHL	\$8,331		
	80	60	Adj.	430	92	FLV3660-L44AHL		\$10,581	\$11,641

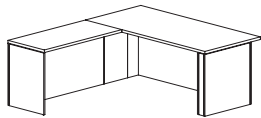

left shown

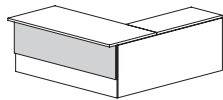
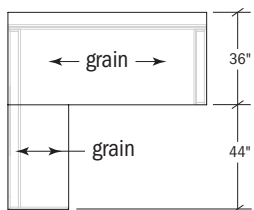
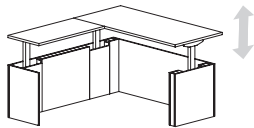

20"h optional modesty

Features:

- eased edge profile on approach and user sides
- 29" to 47" height adjustment with digital controller, wire guide and 10' power cord
- maximum weight rating 210 lbs. (evenly distributed load)

Options:

- must specify chassis grain direction on double cut veneer, see pages 11-13 for details
- reverse bevel edge available on desk approach side only, specify; add \$429 list for laminate or \$168 list for veneer; see page 8 for details
- 20"h modesty panel available, moves with worksurface, specify \$427 list for laminate or \$594 list for veneer; see page 15 for details
- top grommet available, specify location; add \$128 list each; see page 47 for details
- wall access cutouts available, specify and add \$231 list

FLUX - PRIVATE OFFICE

Description	D	W	H	CTN WT	CU FT	① Model	HPL Laminate	Flat Cut Veneer	Double Cut Veneer
Adjustable Height L-Configuration Desk and Return left shown 20"h optional modesty	74	72	Adj.	463	102	FLT3672-L38AHR	\$8,503		
	74	72	Adj.	463	102	FLV3672-L38AHR		\$10,827	\$11,910
	74	72	Adj.	463	102	FLT3672-L38AHL	\$8,503		
	74	72	Adj.	463	102	FLV3672-L38AHL		\$10,827	\$11,910
	74	66	Adj.	426	94	FLT3666-L38AHR	\$8,399		
	74	66	Adj.	426	94	FLV3666-L38AHR		\$10,679	\$11,749
	74	66	Adj.	426	94	FLT3666-L38AHL	\$8,399		
	74	66	Adj.	426	94	FLV3666-L38AHL		\$10,679	\$11,749
	74	60	Adj.	412	86	FLT3660-L38AHR	\$8,297		
	74	60	Adj.	412	86	FLV3660-L38AHR		\$10,535	\$11,588
	74	60	Adj.	412	86	FLT3660-L38AHL	\$8,297		
	74	60	Adj.	412	86	FLV3660-L38AHL		\$10,535	\$11,588

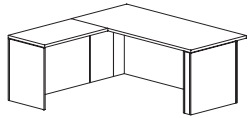

left shown

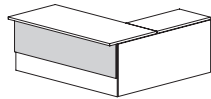
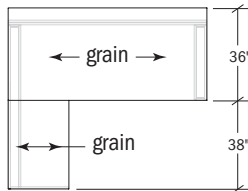
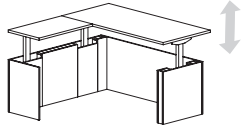

20"h optional modesty

Features:

- eased edge profile on approach and user sides
- 29" to 47" height adjustment with digital controller, wire guide and 10' power cord
- maximum weight rating 210 lbs. (evenly distributed load)

Options:

- must specify chassis grain direction on double cut veneer, see pages 11-13 for details
- reverse bevel edge available on desk approach side only, specify; add \$429 list for laminate or \$168 list for veneer; see page 8 for details
- 20"h modesty panel available, moves with worksurface, specify \$427 list for laminate or \$594 list for veneer; see page 15 for details
- top grommet available, specify location; add \$128 list each; see page 47 for details
- wall access cutouts available, specify and add \$231 list

To Order, Specify:

① Laminate Model #	② Laminate Type	③ Laminate Selection	④ Metal Color	⑤ Other Product Options
Laminate (FLT)	HPL	See Laminate Selection	See Metal Finish Color Options	See list of options for each specific unit; Specify and add accordingly.

① Veneer Model #	② Wood Species	③ Wood Finish	④ Metal Color	⑤ Other Product Options
Veneer (FLV)	Flat Cut CH1 Cherry MA1 Maple WA1 Walnut BO1 Black Oak	See Flat Cut Wood Finish Options	See Metal Finish Color Options	See list of options for each specific unit; Specify and add accordingly.
		<table border="1"> <thead> <tr> <th>③a Wood Finish</th> <th>③b Chassis Grain Direction</th> </tr> </thead> <tbody> <tr> <td>See Double Cut Wood Finish Options</td> <td>For Double Cut Only: Vertical Horizontal</td> </tr> </tbody> </table>		
③a Wood Finish	③b Chassis Grain Direction			
See Double Cut Wood Finish Options	For Double Cut Only: Vertical Horizontal			

Description	D	W	H	CTN WT	CU FT	① Model	HPL Laminate	Flat Cut Veneer	Double Cut Veneer
Adjustable Height L-Configuration Desk and Return	74	72	Adj.	444	102	FLT3072-L44AHR	\$8,290		
	74	72	Adj.	444	102	FLV3072-L44AHR		\$10,593	\$11,651
	74	72	Adj.	444	102	FLT3072-L44AHL	\$8,290		
	74	72	Adj.	444	102	FLV3072-L44AHL		\$10,593	\$11,651
	74	66	Adj.	407	94	FLT3066-L44AHR	\$8,188		
	74	66	Adj.	407	94	FLV3066-L44AHR		\$10,446	\$11,490
	74	66	Adj.	407	94	FLT3066-L44AHL	\$8,188		
	74	66	Adj.	407	94	FLV3066-L44AHL		\$10,446	\$11,490
	74	60	Adj.	393	86	FLT3060-L44AHR	\$8,088		
	74	60	Adj.	393	86	FLV3060-L44AHR		\$10,299	\$11,330
	74	60	Adj.	393	86	FLT3060-L44AHL	\$8,088		
	74	60	Adj.	393	86	FLV3060-L44AHL		\$10,299	\$11,330

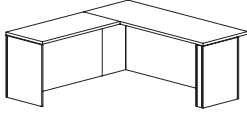

left shown

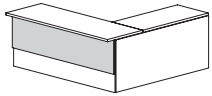
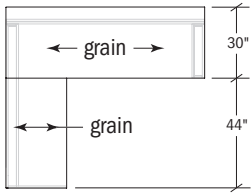
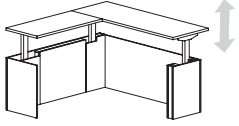

20"h optional modesty

Features:

- eased edge profile on approach and user sides
- 29" to 47" height adjustment with digital controller, wire guide and 10' power cord
- maximum weight rating 210 lbs. (evenly distributed load)

Options:

- must specify chassis grain direction on double cut veneer, see pages 11-13 for details
- reverse bevel edge available on desk approach side only, specify; add \$429 list for laminate or \$168 list for veneer; see page 8 for details
- 20"h modesty panel available, moves with worksurface, specify \$427 list for laminate or \$594 list for veneer; see page 15 for details
- top grommet available, specify location; add \$128 list each; see page 47 for details
- wall access cutouts available, specify and add \$231 list

FLUX - PRIVATE OFFICE

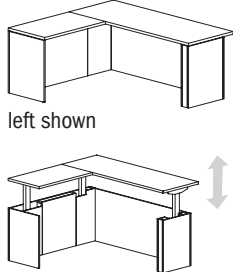
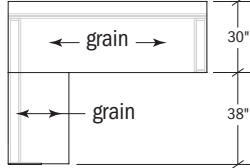
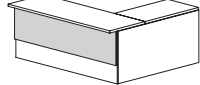
Description	D	W	H	CTN WT	CU FT	① Model	HPL Laminate	Flat Cut Veneer	Double Cut Veneer
Adjustable Height L-Configuration Desk and Return left shown    20"h optional modesty	68	72	Adj.	426	94	FLT3072-L38AHR	\$8,260		
	68	72	Adj.	426	94	FLV3072-L38AHR		\$10,545	\$11,600
	68	72	Adj.	426	94	FLT3072-L38AHL	\$8,260		
	68	72	Adj.	426	94	FLV3072-L38AHL		\$10,545	\$11,600
	68	66	Adj.	389	87	FLT3066-L38AHR	\$8,157		
	68	66	Adj.	389	87	FLV3066-L38AHR		\$10,400	\$11,438
	68	66	Adj.	389	87	FLT3066-L38AHL	\$8,157		
	68	66	Adj.	389	87	FLV3066-L38AHL		\$10,400	\$11,438
	68	60	Adj.	375	79	FLT3060-L38AHR	\$8,055		
	68	60	Adj.	375	79	FLV3060-L38AHR		\$10,254	\$11,277
	68	60	Adj.	375	79	FLT3060-L38AHL	\$8,055		
	68	60	Adj.	375	79	FLV3060-L38AHL		\$10,254	\$11,277

Features:

- eased edge profile on approach and user sides
- 29" to 47" height adjustment with digital controller, wire guide and 10' power cord
- maximum weight rating 210 lbs. (evenly distributed load)

Options:

- must specify chassis grain direction on double cut veneer, see pages 11-13 for details
- reverse bevel edge available on desk approach side only, specify; add \$429 list for laminate or \$168 list for veneer; see page 8 for details
- 20"h modesty panel available, moves with worksurface, specify \$427 list for laminate or \$594 list for veneer; see page 15 for details
- top grommet available, specify location; add \$128 list each; see page 47 for details
- wall access cutouts available, specify and add \$231 list

To Order, Specify:

① Laminate Model #	② Laminate Type	③ Laminate Selection	④ Metal Color	⑤ Other Product Options
Laminate (FLT)	HPL	See Laminate Selection	See Metal Finish Color Options	See list of options for each specific unit; Specify and add accordingly.

① Veneer Model #	② Wood Species	③ Wood Finish	④ Metal Color	⑤ Other Product Options
Veneer (FLV)	Flat Cut CH1 Cherry MA1 Maple WA1 Walnut BO1 Black Oak	See Flat Cut Wood Finish Options	See Metal Finish Color Options	See list of options for each specific unit; Specify and add accordingly.
		<table border="1"> <thead> <tr> <th>③a Wood Finish</th> <th>③b Chassis Grain Direction</th> </tr> </thead> <tbody> <tr> <td>See Double Cut Wood Finish Options</td> <td>For Double Cut Only: Vertical Horizontal</td> </tr> </tbody> </table>		
③a Wood Finish	③b Chassis Grain Direction			
See Double Cut Wood Finish Options	For Double Cut Only: Vertical Horizontal			

Description	D	W	H	CTN WT	CU FT	① Model	HPL Laminate	Flat Cut Veneer	Double Cut Veneer
Adjustable Height L-Configuration Desk and Return with One Piece Top	60	72	Adj.	449	83	FLT3672-C24AHR	\$8,480		
	60	72	Adj.	449	83	FLV3672-C24AHR		\$10,796	\$11,877
	60	72	Adj.	449	83	FLT3672-C24AHL	\$8,480		
	60	72	Adj.	449	83	FLV3672-C24AHL		\$10,796	\$11,877
	60	66	Adj.	412	77	FLT3666-C24AHR	\$8,377		
	60	66	Adj.	412	77	FLV3666-C24AHR		\$10,649	\$11,714
	60	66	Adj.	412	77	FLT3666-C24AHL	\$8,377		
	60	66	Adj.	412	77	FLV3666-C24AHL		\$10,649	\$11,714
	60	60	Adj.	398	70	FLT3660-C24AHR	\$8,278		
	60	60	Adj.	398	70	FLV3660-C24AHR		\$10,503	\$11,555
	60	60	Adj.	398	70	FLT3660-C24AHL	\$8,278		
	60	60	Adj.	398	70	FLV3660-C24AHL		\$10,503	\$11,555

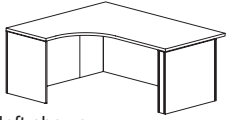

left shown

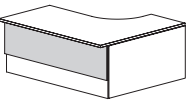
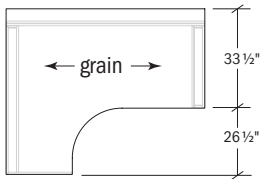
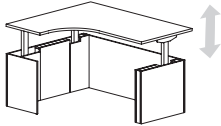

20"h optional modesty

Features:

- eased edge profile on approach and user sides
- 29" to 47" height adjustment with digital controller, wire guide and 10' power cord
- maximum weight rating 210 lbs. (evenly distributed load)

Options:

- must specify chassis grain direction on double cut veneer, see pages 11-13 for details
- reverse bevel edge available on desk approach side only, specify; add \$429 list for laminate or \$168 list for veneer; see page 8 for details
- 20"h modesty panel available, moves with worksurface, specify \$427 list for laminate or \$594 list for veneer; see page 15 for details
- top grommet available, specify location; add \$128 list each; see page 47 for details
- wall access cutouts available, specify and add \$231 list

Description	D	W	H	CTN WT	CU FT	① Model	HPL Laminate	Flat Cut Veneer	Double Cut Veneer
Adjustable Height L-Configuration Desk and Return with One Piece Top	60	72	Adj.	412	83	FLT3072-C30AHR	\$8,268		
	60	72	Adj.	412	83	FLV3072-C30AHR		\$10,561	\$11,618
	60	72	Adj.	412	83	FLT3072-C30AHL	\$8,268		
	60	72	Adj.	412	83	FLV3072-C30AHL		\$10,561	\$11,618
	60	66	Adj.	375	77	FLT3066-C30AHR	\$8,165		
	60	66	Adj.	375	77	FLV3066-C30AHR		\$10,413	\$11,456
	60	66	Adj.	375	77	FLT3066-C30AHL	\$8,165		
	60	66	Adj.	375	77	FLV3066-C30AHL		\$10,413	\$11,456
	60	60	Adj.	361	70	FLT3060-C30AHR	\$8,066		
	60	60	Adj.	361	70	FLV3060-C30AHR		\$10,269	\$11,297
	60	60	Adj.	361	70	FLT3060-C30AHL	\$8,066		
	60	60	Adj.	361	70	FLV3060-C30AHL		\$10,269	\$11,297

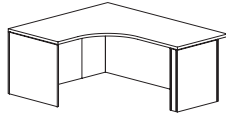

left shown

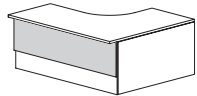
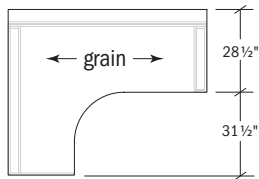
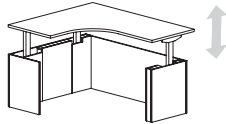

20" h optional modesty

Features:

- eased edge profile on approach and user sides
- 29" to 47" height adjustment with digital controller, wire guide and 10' power cord
- maximum weight rating 210 lbs. (evenly distributed load)

Options:

- must specify chassis grain direction on double cut veneer, see pages 11-13 for details
- reverse bevel edge available on desk approach side only, specify; add \$429 list for laminate or \$168 list for veneer; see page 8 for details
- 20" h modesty panel available, moves with worksurface, specify \$427 list for laminate or \$594 list for veneer; see page 15 for details
- top grommet available, specify location; add \$128 list each; see page 47 for details
- wall access cutouts available, specify and add \$231 list

To Order, Specify:

① Laminate Model #	② Laminate Type	③ Laminate Selection	④ Metal Color	⑤ Other Product Options
Laminate (FLT)	HPL	See Laminate Selection	See Metal Finish Color Options	See list of options for each specific unit; Specify and add accordingly.

① Veneer Model #	② Wood Species	③ Wood Finish	④ Metal Color	⑤ Other Product Options
Veneer (FLV)	Flat Cut CH1 Cherry MA1 Maple WA1 Walnut BO1 Black Oak	See Flat Cut Wood Finish Options	See Metal Finish Color Options	See list of options for each specific unit; Specify and add accordingly.
		<table border="1"> <thead> <tr> <th>③a Wood Finish</th> <th>③b Chassis Grain Direction</th> </tr> </thead> <tbody> <tr> <td>See Double Cut Wood Finish Options</td> <td>For Double Cut Only: Vertical Horizontal</td> </tr> </tbody> </table>		
③a Wood Finish	③b Chassis Grain Direction			
See Double Cut Wood Finish Options	For Double Cut Only: Vertical Horizontal			

Description	D	W	H	CTN WT	CU FT	① Model	HPL Laminate	Flat Cut Veneer	Double Cut Veneer
33" Adjustable Height Modular Peninsula Desk	33½	72	Adj.	205	26	FLT3472PAHD	\$4,732		
	33½	72	Adj.	205	26	FLV3472PAHD		\$5,916	\$6,505
	33½	66	Adj.	198	25	FLT3466PAHD	\$4,707		
	33½	66	Adj.	198	25	FLV3466PAHD		\$5,877	\$6,465
	33½	60	Adj.	191	24	FLT3460PAHD	\$4,683		
	33½	60	Adj.	191	24	FLV3460PAHD		\$5,843	\$6,425

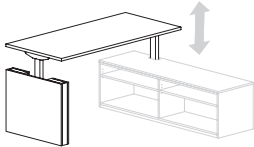
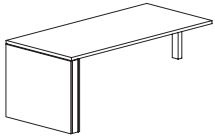

in application

Features:

- must be used with 96", 72" and 36" wide secondary height peninsula mount credenzas
- 29" to 47" height adjustment with digital controller, wire guide and 10' power cord
- maximum weight rating 140 lbs. (evenly distributed load)

Options:

- must specify support panels grain direction on double cut veneer, see pages 11-13 for details
- reverse bevel edge available on approach and user sides, specify; add \$429 list for laminate or \$168 list for veneer; see page 8 for details
- 13½" h modesty panel available, specify; add \$427 list for laminate or \$594 list for veneer; see page 19 for details
- top grommet available, specify location; add \$128 list each; see page 47 for details
- worksurface power available, specify "to accommodate EC26" on your purchase order; EC26 unit must be ordered separately, see page 47

Box/Lateral File Storage Credenza with Peninsula Desk Mount	D	W	H	CTN WT	CU FT	Model	HPL Laminate	Flat Cut Veneer	Double Cut Veneer
Box/Lateral File Storage Credenza with Peninsula Desk Mount	22	96	21	306	32	FLT2296-21FM60	\$2,920		
	22	96	21	306	32	FLV2296-21FM60		\$3,913	\$4,302
	22	96	21	306	32	FLT2296-21F06M	\$2,920		
	22	96	21	306	32	FLV2296-21F06M		\$3,913	\$4,302

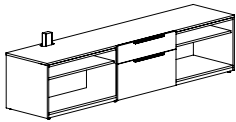

*M60 shown

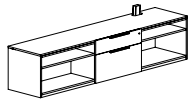

*O6M

Features:

- must be used with 33" deep adjustable height modular peninsula desk
- desk lift column can only be mounted in sections with an open compartment, see page 39 for details
- open compartments with adjustable shelves

Options:

- must specify chassis grain direction on double cut veneer, see pages 11-13 for details
- veneer drawer fronts in paint available, specify paint color; add \$337 list; see page 14 for details
- on laminate units, contrasting worksurface tops and drawer fronts available, no upcharge; specify laminate color, see page 14 for details
- ledge pulls standard; prism pulls available, specify and see page 9
- oval grommets in back panels can be eliminated upon request, no upcharge
- concealed box drawer(s) available, specify location in unit; add \$234 list for each laminate drawer or \$357 list for each veneer drawer, see page 23 for details
- seat cushion available, see page 23 for more details and page 212 for pricing
- top grommet available, specify location; add \$128 list each; see page 45 for details
- interior wire manager from side to side in upper back, specify and add \$114 list; see page 15 for details

Box/Lateral File Storage Credenza with Peninsula Desk Mount	D	W	H	CTN WT	CU FT	Model	HPL Laminate	Flat Cut Veneer	Double Cut Veneer
Box/Lateral File Storage Credenza with Peninsula Desk Mount	22	96	21	341	32	FLT2296-21FM66	\$3,131		
	22	96	21	341	32	FLV2296-21FM66		\$4,196	\$4,616
	22	96	21	341	32	FLT2296-21F66M	\$3,131		
	22	96	21	341	32	FLV2296-21F66M		\$4,196	\$4,616

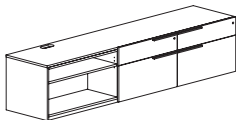

*M66 shown



*O66M

Features:

- must be used with 33" deep adjustable height modular peninsula desk
- desk lift column can only be mounted in sections with an open compartment, see page 39 for details
- open compartment with adjustable shelf

Options:

- must specify chassis grain direction on double cut veneer, see pages 11-13 for details
- veneer drawer fronts in paint available, specify paint color; add \$337 list; see page 14 for details
- on laminate units, contrasting worksurface tops and drawer fronts available, no upcharge; specify laminate color, see page 14 for details
- ledge pulls standard; prism pulls available, specify and see page 9
- oval grommets in back panels can be eliminated upon request, no upcharge
- concealed box drawer(s) available, specify location in unit; add \$234 list for each laminate drawer or \$357 list for each veneer drawer, see page 23 for details
- seat cushion available, see page 23 for more details and page 212 for pricing
- top grommet available, specify location; add \$128 list each; see page 45 for details
- interior wire manager from side to side in upper back, specify and add \$114 list; see page 15 for details

Description	D	W	H	CTN WT	CU FT	① Model	HPL Laminate	Flat Cut Veneer	Double Cut Veneer
Box/Lateral File Storage Credenza with Peninsula Desk Mount	22	72	21	267	24	FLT2272-21FM6	\$2,605		
	22	72	21	267	24	FLV2272-21FM6		\$3,490	\$3,837
	22	72	21	267	24	FLT2272-21F6M	\$2,605		
	22	72	21	267	24	FLV2272-21F6M		\$3,490	\$3,837

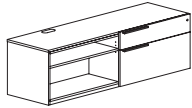

*M6 shown

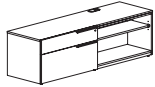

*6M

Features:

- must be used with 33" deep adjustable height modular peninsula desk
- desk lift column can only be mounted in sections with an open compartment, see page 39 for details
- open compartment with adjustable shelf

Options:

- must specify chassis grain direction on double cut veneer, see pages 11-13 for details
- veneer drawer fronts in paint available, specify paint color; add \$337 list; see page 14 for details
- on laminate units, contrasting worksurface tops and drawer fronts available, no upcharge; specify laminate color, see page 14 for details
- ledge pulls standard; prism pulls available, specify and see page 9
- oval grommets in back panels can be eliminated upon request, no upcharge
- concealed box drawer(s) available, specify location in unit; add \$234 list for each laminate drawer or \$357 list for each open compartment, see page 23 for details
- seat cushion available, see page 23 for more details and page 212 for pricing
- top grommet available, specify location; add \$128 list each; see page 45 for details
- interior wire manager from side to side in upper back, specify and add \$114 list; see page 15 for details

Sliding Door Credenza with Peninsula Desk Mount	22	72	21	225	24	FLT2272-21FM9	\$2,876		
	22	72	21	225	24	FLV2272-21FM9		\$3,854	\$4,241
	22	72	21	225	24	FLT2272-21F9M	\$2,876		
	22	72	21	225	24	FLV2272-21F9M		\$3,854	\$4,241

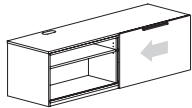

*M9 shown

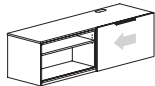
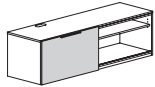

*9M

Features:

- must be used with 33" deep adjustable height modular peninsula desk
- desk lift column can only be mounted in sections with an open compartment, see page 39 for details
- each compartment has one adjustable shelf

Options:

- must specify chassis grain direction on double cut veneer, see pages 11-13 for details
- veneer door fronts in paint available, specify paint color; add \$337 list; see page 14 for details
- on laminate units, contrasting worksurface tops and drawer fronts available, no upcharge; specify laminate color, see page 14 for details
- ledge pulls standard; prism pulls available, specify and see page 9
- oval grommets in back panels can be eliminated upon request, no upcharge
- seat cushion available, see page 23 for more details and page 212 for pricing
- top grommet available, specify location; add \$128 list each; see page 45 for details
- interior wire manager from side to side in upper back, specify and add \$114 list; see page 15 for details

To Order, Specify:

① Laminate Model #	② Laminate Type	③ Laminate Selection	④ Metal Color	⑤ Other Product Options
Laminate (FLT)	HPL	See Laminate Selection	See Metal Finish Color Options	See list of options for each specific unit; Specify and add accordingly.

① Veneer Model #	② Wood Species	③ Wood Finish	④ Metal Color	⑤ Other Product Options	
Veneer (FLV)	Flat Cut CH1 Cherry MA1 Maple WA1 Walnut BO1 Black Oak	See Flat Cut Wood Finish Options	See Metal Finish Color Options	See list of options for each specific unit; Specify and add accordingly.	
	Double Cut DC1 Double Cut	<table border="1"> <thead> <tr> <th>ⓐ Wood Finish</th> <th>ⓑ Chassis Grain Direction</th> </tr> </thead> <tbody> <tr> <td>See Double Cut Wood Finish Options</td> <td>For Double Cut Only: Vertical Horizontal</td> </tr> </tbody> </table>			ⓐ Wood Finish
ⓐ Wood Finish	ⓑ Chassis Grain Direction				
See Double Cut Wood Finish Options	For Double Cut Only: Vertical Horizontal				

Description	D	W	H	CTN WT	CU FT	① Model	HPL Laminate	Flat Cut Veneer	Double Cut Veneer
Open Compartment Storage	22	96	21	266	32	FLT2296-21FM00	\$2,560		
Credenza with Peninsula	22	96	21	266	32	FLV2296-21FM00		\$3,602	\$3,963
Desk Mount	22	96	21	266	32	FLT2296-21F00M	\$2,560		
	22	96	21	266	32	FLV2296-21F00M		\$3,602	\$3,963

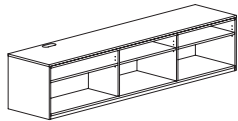

*M00 shown

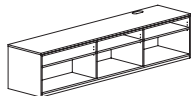

*00M

Features:

- must be used with 33" deep adjustable height modular peninsula desk
- square edge on top
- each compartment has one adjustable shelf

Options:

- must specify chassis grain direction on double cut veneer, see pages 11-13 for details
- oval grommets in back panels can be eliminated upon request, no upcharge
- seat cushion available, see page 23 for more details and page 212 for pricing
- top grommet available, specify location; add \$128 list each; see page 45 for details
- interior wire manager from side to side in upper back, specify and add \$114 list; see page 15 for details

Open Compartment Storage	22	72	21	204	24	FLT2272-21FM0	\$2,264		
Credenza with Peninsula	22	72	21	204	24	FLV2272-21FM0		\$3,190	\$3,509
Desk Mount	22	72	21	204	24	FLT2272-21F0M	\$2,264		
	22	72	21	204	24	FLV2272-21F0M		\$3,190	\$3,509

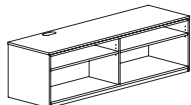

*M0 shown

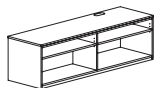

*0M

Features:

- must be used with 33" deep adjustable height modular peninsula desk
- square edge on top
- each compartment has one adjustable shelf

Options:

- must specify chassis grain direction on double cut veneer, see pages 11-13 for details
- oval grommets in back panels can be eliminated upon request, no upcharge
- seat cushion available, see page 23 for more details and page 212 for pricing
- top grommet available, specify location; add \$128 list each; see page 45 for details
- interior wire manager from side to side in upper back, specify and add \$114 list; see page 15 for details

Description	D	W	H	CTN WT	CU FT	① Model	HPL Laminate	Flat Cut Veneer	Double Cut Veneer
Open Compartment Storage Pedestal with Peninsula Desk Mount	22	36	21	111	13	FLT2236-21FMR	\$1,728		
	22	36	21	111	13	FLV2236-21FMR		\$2,430	\$2,675
	22	36	21	111	13	FLT2236-21FML	\$1,728		
	22	36	21	111	13	FLV2236-21FML		\$2,430	\$2,675

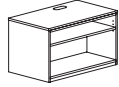

*MR shown



*ML

Features:

- must be used with 33" deep adjustable height modular peninsula desk
- square edge on top
- open compartment with adjustable shelf

Options:

- must specify chassis grain direction on double cut veneer, see pages 11-13 for details
- oval grommets in back panels can be eliminated upon request, no upcharge
- seat cushion available, see page 23 for more details and page 212 for pricing
- interior wire manager from side to side in upper back, specify and add \$114 list; see page 15 for details

To Order, Specify:

① Laminate Model #	② Laminate Type	③ Laminate Selection	④ Metal Color	⑤ Other Product Options
Laminate (FLT)	HPL	See Laminate Selection	See Metal Finish Color Options	See list of options for each specific unit; Specify and add accordingly.

① Veneer Model #	② Wood Species	③ Wood Finish	④ Metal Color	⑤ Other Product Options
Veneer (FLV)	Flat Cut CH1 Cherry MA1 Maple WA1 Walnut BO1 Black Oak	See Flat Cut Wood Finish Options	See Metal Finish Color Options	See list of options for each specific unit; Specify and add accordingly.
		<table border="1"> <thead> <tr> <th>③a Wood Finish</th> <th>③b Chassis Grain Direction</th> </tr> </thead> <tbody> <tr> <td>See Double Cut Wood Finish Options</td> <td>For Double Cut Only: Vertical Horizontal</td> </tr> </tbody> </table>		
③a Wood Finish	③b Chassis Grain Direction			
See Double Cut Wood Finish Options	For Double Cut Only: Vertical Horizontal			

Description	D	W	H	CTN WT	CU FT	① Model	HPL Laminate	Flat Cut Veneer	Double Cut Veneer
27" Adjustable Height Modular Peninsula Desk	27½	72	Adj.	182	21	FLT2872PAHD	\$4,502		
	27½	72	Adj.	182	21	FLV2872PAHD		\$5,697	\$6,268
	27½	66	Adj.	176	19	FLT2866PAHD	\$4,476		
	27½	66	Adj.	176	19	FLV2866PAHD		\$5,661	\$6,226
	27½	60	Adj.	170	19	FLT2860PAHD	\$4,449		
	27½	60	Adj.	170	19	FLV2860PAHD		\$5,623	\$6,186

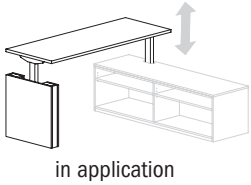
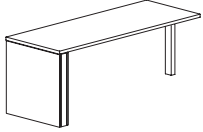

Features:

- must be used with 90", 60" and 30" wide secondary height peninsula mount credenzas
- 29" to 47" height adjustment with digital controller, wire guide and 10' power cord
- maximum weight rating 140 lbs. (evenly distributed load)

Options:

- must specify support panels grain direction on double cut veneer, see pages 11-13 for details
- reverse bevel edge available on approach and user sides, specify; add \$429 list for laminate or \$168 list for veneer; see page 8 for details
- 13½" h modesty panel available, specify; add \$427 list for laminate or \$594 list for veneer; see page 19 for details
- top grommet available, specify location; add \$128 list each; see page 47 for details
- worksurface power available, specify "to accommodate EC26" on your purchase order; EC26 unit must be ordered separately, see page 42

Box/Lateral File Storage Credenza with Peninsula Desk Mount	22	90	21	278	30	FLT2290-21FM60	\$2,834		
	22	90	21	278	30	FLV2290-21FM60		\$3,796	\$4,177
	22	90	21	278	30	FLT2290-21F06M	\$2,834		
	22	90	21	278	30	FLV2290-21F06M		\$3,796	\$4,177

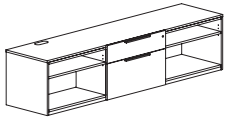

*M60 shown

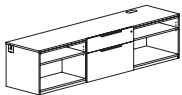

*06M

Features:

- must be used with 27" deep adjustable height modular peninsula desk
- desk lift column can only be mounted in sections with an open compartment, see page 39 for details
- open compartment with adjustable shelf

Options:

- must specify chassis grain direction on double cut veneer, see pages 11-13 for details
- veneer drawer fronts in paint available, specify paint color; add \$337 list; see page 14 for details
- on laminate units, contrasting worksurface tops and drawer fronts available, no upcharge; specify laminate color, see page 14 for details
- ledge pulls standard; prism pulls available, specify and see page 9
- oval grommets in back panels can be eliminated upon request, no upcharge
- concealed box drawer(s) available, specify location in unit; add \$234 list for each laminate drawer or \$357 list for each veneer drawer, see page 23 for details
- seat cushion available, see page 23 for more details and page 212 for pricing
- top grommet available, specify location; add \$128 list each; see page 45 for details
- interior wire manager from side to side in upper back, specify and add \$114 list; see page 15 for details

Description	D	W	H	CTN WT	CU FT	① Model	HPL Laminate	Flat Cut Veneer	Double Cut Veneer
Box/Lateral File Storage Credenza with Peninsula Desk Mount	22	90	21	313	30	FLT2290-21FM66	\$2,997		
	22	90	21	313	30	FLV2290-21FM66		\$4,073	\$4,481
	22	90	21	313	30	FLT2290-21F66M	\$2,997		
	22	90	21	313	30	FLV2290-21F66M		\$4,073	\$4,481

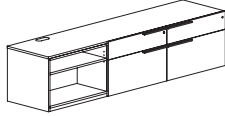

*M66 shown

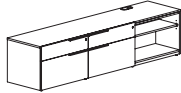

*66M

Features:

- must be used with 27" deep adjustable height modular peninsula desk
- desk lift column can only be mounted in sections with an open compartment, see page 39 for details
- open compartment with adjustable shelf

Options:

- must specify chassis grain direction on double cut veneer, see pages 11-13 for details
- veneer drawer fronts in paint available, specify paint color; add \$337 list; see page 14 for details
- on laminate units, contrasting worksurface tops and drawer fronts available, no upcharge; specify laminate color, see page 14 for details
- ledge pulls standard; prism pulls available, specify and see page 9
- oval grommets in back panels can be eliminated upon request, no upcharge
- concealed box drawer(s) available, specify location in unit; add \$234 list for each laminate drawer or \$357 list for each veneer drawer, see page 23 for details
- seat cushion available, see page 23 for more details and page 212 for pricing
- top grommet available, specify location; add \$128 list each; see page 45 for details
- interior wire manager from side to side in upper back, specify and add \$114 list; see page 15 for details

Box/Lateral File Storage Credenza with Peninsula Desk Mount	22	60	21	239	21	FLT2260-21FM6	\$2,456		
	22	60	21	239	21	FLV2260-21FM6		\$3,291	\$3,620
	22	60	21	239	21	FLT2260-21F6M	\$2,456		
	22	60	21	239	21	FLV2260-21F6M		\$3,291	\$3,620

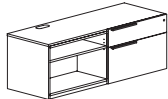

*M6 shown

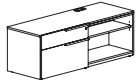

*6M

Features:

- must be used with 27" deep adjustable height modular peninsula desk
- desk lift column can only be mounted in sections with an open compartment, see page 39 for details
- open compartment with adjustable shelf

Options:

- must specify chassis grain direction on double cut veneer, see pages 11-13 for details
- veneer drawer fronts in paint available, specify paint color; add \$337 list; see page 14 for details
- on laminate units, contrasting worksurface tops and drawer fronts available, no upcharge; specify laminate color, see page 14 for details
- ledge pulls standard; prism pulls available, specify and see page 9
- oval grommets in back panels can be eliminated upon request, no upcharge
- concealed box drawer(s) available, specify location in unit; add \$234 list for each laminate drawer or \$357 list for each veneer drawer, see page 23 for details
- seat cushion available, see page 23 for more details and page 212 for pricing
- top grommet available, specify location; add \$128 list each; see page 45 for details
- interior wire manager from side to side in upper back, specify and add \$114 list; see page 15 for details

To Order, Specify:

① Laminate Model #	② Laminate Type	③ Laminate Selection	④ Metal Color	⑤ Other Product Options
Laminate (FLT)	HPL	See Laminate Selection	See Metal Finish Color Options	See list of options for each specific unit; Specify and add accordingly.

① Veneer Model #	② Wood Species	③ Wood Finish	④ Metal Color	⑤ Other Product Options	
Veneer (FLV)	Flat Cut CH1 Cherry MA1 Maple WA1 Walnut BO1 Black Oak	See Flat Cut Wood Finish Options	See Metal Finish Color Options	See list of options for each specific unit; Specify and add accordingly.	
	Double Cut DC1 Double Cut	<table border="1"> <thead> <tr> <th>ⓐ Wood Finish</th> <th>ⓑ Chassis Grain Direction</th> </tr> </thead> <tbody> <tr> <td>See Double Cut Wood Finish Options</td> <td>For Double Cut Only: Vertical Horizontal</td> </tr> </tbody> </table>			ⓐ Wood Finish
ⓐ Wood Finish	ⓑ Chassis Grain Direction				
See Double Cut Wood Finish Options	For Double Cut Only: Vertical Horizontal				

Description	D	W	H	CTN WT	CU FT	① Model	HPL Laminate	Flat Cut Veneer	Double Cut Veneer
Sliding Door Credenza with Peninsula Desk Mount	22	90	21	276	31	FLT2290-21FM99	\$2,715		
	22	90	21	276	31	FLV2290-21FM99		\$3,637	\$4,001
	22	90	21	276	31	FLT2290-21F99M	\$2,715		
	22	90	21	276	31	FLV2290-21F99M		\$3,637	\$4,001

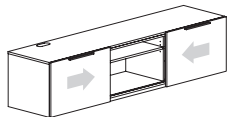

*M99 shown

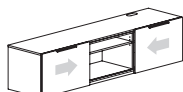
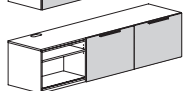
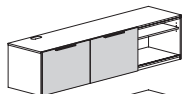

*99M

Features:

- must be used with 27" deep adjustable height modular peninsula desk
- desk lift column can only be mounted in sections with an open compartment, see page 39 for details
- each compartment has one adjustable shelf

Options:

- must specify chassis grain direction on double cut veneer, see pages 11-13 for details
- veneer door fronts in paint available, specify paint color; add \$337 list; see page 14 for details
- on laminate units, contrasting worksurface tops and drawer fronts available, no upcharge; specify laminate color, see page 14 for details
- ledge pulls standard; prism pulls available, specify and see page 9
- oval grommets in back panels can be eliminated upon request, no upcharge
- seat cushion available, see page 23 for more details and page 212 for pricing
- top grommet available, specify location; add \$128 list each; see page 45 for details
- interior wire manager from side to side in upper back, specify and add \$114 list; see page 15 for details

Sliding Door Credenza with Peninsula Desk Mount	22	90	21	259	31	FLT2290-21FM90	\$2,611		
	22	90	21	259	31	FLV2290-21FM90		\$3,499	\$3,847
	22	90	21	259	31	FLT2290-21F09M	\$2,611		
	22	90	21	259	31	FLV2290-21F09M		\$3,499	\$3,847

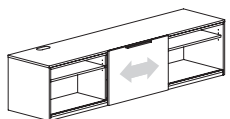

*M90 shown

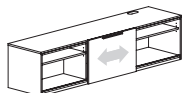
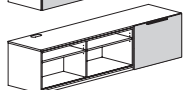
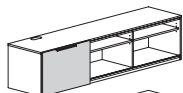

*09M

Features:

- must be used with 27" deep adjustable height modular peninsula desk
- desk lift column can only be mounted in sections with an open compartment, see page 39 for details
- each compartment has one adjustable shelf

Options:

- must specify chassis grain direction on double cut veneer, see pages 11-13 for details
- veneer door fronts in paint available, specify paint color; add \$337 list; see page 14 for details
- on laminate units, contrasting worksurface tops and drawer fronts available, no upcharge; specify laminate color, see page 14 for details
- ledge pulls standard; prism pulls available, specify and see page 9
- oval grommets in back panels can be eliminated upon request, no upcharge
- seat cushion available, see page 23 for more details and page 212 for pricing
- top grommet available, specify location; add \$128 list each; see page 45 for details
- interior wire manager from side to side in upper back, specify and add \$114 list; see page 15 for details

Description	D	W	H	CTN WT	CU FT	① Model	HPL Laminate	Flat Cut Veneer	Double Cut Veneer
Sliding Door Credenza with Peninsula Desk Mount	22	60	21	185	21	FLT2260-21FM9	\$2,244		
	22	60	21	185	21	FLV2260-21FM9		\$3,008	\$3,309
	22	60	21	185	21	FLT2260-21F9M	\$2,244		
	22	60	21	185	21	FLV2260-21F9M		\$3,008	\$3,309

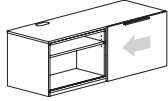

*M9 shown

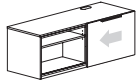
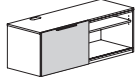

*9M

Features:

- must be used with 27" deep adjustable height modular peninsula desk
- desk lift column can only be mounted in sections with an open compartment, see page 39 for details
- each compartment has one adjustable shelf

Options:

- must specify chassis grain direction on double cut veneer, see pages 11-13 for details
- veneer door fronts in paint available, specify paint color; add \$337 list; see page 14 for details
- on laminate units, contrasting worksurface tops and drawer fronts available, no upcharge; specify laminate color, see page 14 for details
- ledge pulls standard; prism pulls available, specify and see page 9
- oval grommets in back panels can be eliminated upon request, no upcharge
- seat cushion available, see page 23 for more details and page 212 for pricing
- top grommet available, specify location; add \$128 list each; see page 45 for details
- interior wire manager from side to side in upper back, specify and add \$114 list; see page 15 for details

To Order, Specify:

① Laminate Model #	② Laminate Type	③ Laminate Selection	④ Metal Color	⑤ Other Product Options
Laminate (FLT)	HPL	See Laminate Selection	See Metal Finish Color Options	See list of options for each specific unit; Specify and add accordingly.

① Veneer Model #	② Wood Species	③ Wood Finish	④ Metal Color	⑤ Other Product Options	
Veneer (FLV)	Flat Cut CH1 Cherry MA1 Maple WA1 Walnut BO1 Black Oak	See Flat Cut Wood Finish Options	See Metal Finish Color Options	See list of options for each specific unit; Specify and add accordingly.	
	Double Cut DC1 Double Cut	<table border="1"> <thead> <tr> <th>③a Wood Finish</th> <th>③b Chassis Grain Direction</th> </tr> </thead> <tbody> <tr> <td>See Double Cut Wood Finish Options</td> <td>For Double Cut Only: Vertical Horizontal</td> </tr> </tbody> </table>			③a Wood Finish
③a Wood Finish	③b Chassis Grain Direction				
See Double Cut Wood Finish Options	For Double Cut Only: Vertical Horizontal				

Description	D	W	H	CTN WT	CU FT	① Model	HPL Laminate	Flat Cut Veneer	Double Cut Veneer
Open Compartment Storage	22	90	21	238	30	FLT2290-21FM00	\$2,189		
Credenza with Peninsula	22	90	21	238	30	FLV2290-21FM00		\$3,082	\$3,389
Desk Mount	22	90	21	238	30	FLT2290-21F00M	\$2,189		
	22	90	21	238	30	FLV2290-21F00M		\$3,082	\$3,389

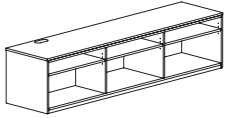

*M00 shown

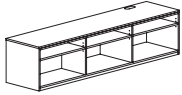

*00M

Features:

- must be used with 27" deep adjustable height modular peninsula desk
- square edge on top
- each compartment has one adjustable shelf

Options:

- must specify chassis grain direction on double cut veneer, see pages 11-13 for details
- oval grommets in back panels can be eliminated upon request, no upcharge
- seat cushion available, see page 23 for more details and page 212 for pricing
- top grommet available, specify location; add \$128 list each; see page 45 for details
- interior wire manager from side to side in upper back, specify and add \$114 list; see page 15 for details

Open Compartment Storage	22	60	21	176	21	FLT2260-21FM0	\$1,884		
Credenza with Peninsula	22	60	21	176	21	FLV2260-21FM0		\$2,650	\$2,914
Desk Mount	22	60	21	176	21	FLT2260-21F0M	\$1,884		
	22	60	21	176	21	FLV2260-21F0M		\$2,650	\$2,914

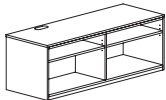

*M0

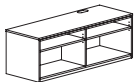

*0M

Features:

- must be used with 27" deep adjustable height modular peninsula desk
- square edge on top
- each compartment has one adjustable shelf

Options:

- must specify chassis grain direction on double cut veneer, see pages 11-13 for details
- oval grommets in back panels can be eliminated upon request, no upcharge
- seat cushion available, see page 23 for more details and page 212 for pricing
- top grommet available, specify location; add \$128 list each; see page 45 for details
- interior wire manager from side to side in upper back, specify and add \$114 list; see page 15 for details

Description	D	W	H	CTN WT	CU FT	① Model	HPL Laminate	Flat Cut Veneer	Double Cut Veneer
Open Compartment Storage	22	30	21	83	11	FLT2230-21FMR	\$1,661		
Pedestal with Peninsula Desk	22	30	21	83	11	FLV2230-21FMR		\$2,334	\$2,569
Mount	22	30	21	83	11	FLT2230-21FML	\$1,661		
	22	30	21	83	11	FLV2230-21FML		\$2,334	\$2,569



*MR shown



*ML

Features:

- must be used with 27" deep adjustable height modular peninsula desk
- square edge on top
- open compartment with adjustable shelf

Options:

- must specify chassis grain direction on double cut veneer, see pages 11-13 for details
- oval grommets in back panels can be eliminated upon request, no upcharge
- interior wire manager from side to side in upper back, specify and add \$114 list; see page 15 for details

To Order, Specify:

① Laminate Model #	② Laminate Type	③ Laminate Selection	④ Metal Color	⑤ Other Product Options
Laminate (FLT)	HPL	See Laminate Selection	See Metal Finish Color Options	See list of options for each specific unit; Specify and add accordingly.

① Veneer Model #	② Wood Species	③ Wood Finish	④ Metal Color	⑤ Other Product Options
Veneer (FLV)	Flat Cut CH1 Cherry MA1 Maple WA1 Walnut BO1 Black Oak	See Flat Cut Wood Finish Options	See Metal Finish Color Options	See list of options for each specific unit; Specify and add accordingly.
		<table border="1"> <thead> <tr> <th>ⓐ Wood Finish</th> <th>ⓑ Chassis Grain Direction</th> </tr> </thead> <tbody> <tr> <td>See Double Cut Wood Finish Options</td> <td>For Double Cut Only: Vertical Horizontal</td> </tr> </tbody> </table>		
ⓐ Wood Finish	ⓑ Chassis Grain Direction			
See Double Cut Wood Finish Options	For Double Cut Only: Vertical Horizontal			

Description	D	W	H	CTN WT	CU FT	① Model	HPL Laminate	Flat Cut Veneer	Double Cut Veneer
Square Pneumatic Adjustable Height Table	30	30	Adj.	42	19	FLT3030SAT4B	\$1,983		
	30	30	Adj.	42	19	FLV3030SAT4B		\$2,447	\$2,692
	24	24	Adj.	34	13	FLT2424SAT4B	\$1,943		
	24	24	Adj.	34	13	FLV2424SAT4B		\$2,397	\$2,638



Features:

- ¾" top with flat edge
- 4-star cast aluminum base
- 26" to 38" height adjustment, casters increase heights by 2"
- release lever mounts under edge of top
- 15 lbs. lift force, maximum weight rating 75 lbs. (evenly distributed load)

Options:

- casters available, four locking, specify and add \$98 list

Round Pneumatic Adjustable Height Table	36	36	Adj.	46	27	FLT3636RAT4B	\$2,021		
	36	36	Adj.	46	27	FLV3636RAT4B		\$2,497	\$2,747
	30	30	Adj.	39	19	FLT3030RAT4B	\$1,983		
	30	30	Adj.	39	19	FLV3030RAT4B		\$2,447	\$2,692

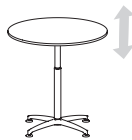

Features:

- ¾" top with flat edge
- 4-star cast aluminum base
- 26" to 38" height adjustment, casters increase heights by 2"
- release lever mounts under edge of top
- 15 lbs. lift force, maximum weight rating 75 lbs. (evenly distributed load)

Options:

- casters available, four locking, specify and add \$98 list

FLUX - PRIVATE OFFICE

Description	D	W	H	CTN WT	CU FT	① Model	HPL Laminate	Flat Cut Veneer	Double Cut Veneer
Oval Pneumatic Adjustable	26	36	Adj.	42	20	FLT26360AT4B	\$2,062		
Height Table	26	36	Adj.	42	20	FLV26360AT4B		\$2,548	\$2,803



Features:

- ¾" top with flat edge
- 4-star cast aluminum base
- 26" to 38" height adjustment, casters increase heights by 2"
- release lever mounts under edge of top
- 15 lbs. lift force, maximum weight rating 75 lbs. (evenly distributed load)

Options:



- casters available, four locking, specify and add \$98 list

FLUX - PRIVATE OFFICE

To Order, Specify:







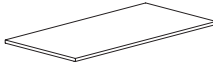

① Laminate Model #	② Laminate Type	③ Laminate Selection	④ Metal Color	⑤ Other Product Options
Laminate (FLT)	HPL	See Laminate Selection	See Metal Finish Color Options	See list of options for each specific unit; Specify and add accordingly.

① Veneer Model #	② Wood Species	③ Wood Finish	④ Metal Color	⑤ Other Product Options
Veneer (FLV)	Flat Cut CH1 Cherry MA1 Maple WA1 Walnut BO1 Black Oak	See Flat Cut Wood Finish Options	See Metal Finish Color Options	See list of options for each specific unit; Specify and add accordingly.
		<table border="1"> <thead> <tr> <th>③a Wood Finish</th> <th>③b Chassis Grain Direction</th> </tr> </thead> <tbody> <tr> <td>See Double Cut Wood Finish Options</td> <td>For Double Cut Only: Vertical Horizontal</td> </tr> </tbody> </table>		
③a Wood Finish	③b Chassis Grain Direction			
See Double Cut Wood Finish Options	For Double Cut Only: Vertical Horizontal			

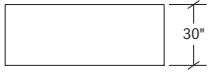
Description	D	W	H	CTN WT	CU FT	① Model	HPL Laminate	Fiat Cut Veneer	Double Cut Veneer
Modular Bow Front Desk Top  	36	84	1 3/16	103	7	FLT3684BMCT	\$1,530		
	36	84	1 3/16	103	7	FLV3684BMCT		\$2,366	\$2,604
	36	78	1 3/16	96	6	FLT3678BMCT	\$1,475		
	36	78	1 3/16	96	6	FLV3678BMCT		\$2,273	\$2,500
	36	72	1 3/16	89	6	FLT3672BMCT	\$1,419		
	36	72	1 3/16	89	6	FLV3672BMCT		\$2,182	\$2,400
	36	66	1 3/16	82	5	FLT3666BMCT	\$1,401		
	36	66	1 3/16	82	5	FLV3666BMCT		\$2,150	\$2,366
	36	60	1 3/16	75	5	FLT3660BMCT	\$1,378		
	36	60	1 3/16	75	5	FLV3660BMCT		\$2,117	\$2,330

Features:

- eased edge profile on approach and user sides

Description	D	W	H	CTN WT	CU FT	① Model	HPL Laminate	Flat Cut Veneer	Double Cut Veneer
Modular Rectangular Desk Top	36	84	1 3/16	101	7	FLT3684MCT	\$1,131		
	36	84	1 3/16	101	7	FLV3684MCT		\$1,788	\$1,970
	36	78	1 3/16	94	6	FLT3678MCT	\$1,051		
	36	78	1 3/16	94	6	FLV3678MCT		\$1,663	\$1,828
	36	72	1 3/16	87	6	FLT3672MCT	\$970		
	36	72	1 3/16	87	6	FLV3672MCT		\$1,535	\$1,690
	36	66	1 3/16	80	5	FLT3666MCT	\$891		
	36	66	1 3/16	80	5	FLV3666MCT		\$1,407	\$1,548
	36	60	1 3/16	73	5	FLT3660MCT	\$810		
	36	60	1 3/16	73	5	FLV3660MCT		\$1,281	\$1,409
	30	84	1 3/16	85	6	FLT3084MCT	\$945		
	30	84	1 3/16	85	6	FLV3084MCT		\$1,492	\$1,640
	30	78	1 3/16	79	5	FLT3078MCT	\$877		
	30	78	1 3/16	79	5	FLV3078MCT		\$1,384	\$1,525
	30	72	1 3/16	73	5	FLT3072MCT	\$810		
	30	72	1 3/16	73	5	FLV3072MCT		\$1,281	\$1,409
	30	66	1 3/16	68	5	FLT3066MCT	\$742		
	30	66	1 3/16	68	5	FLV3066MCT		\$1,174	\$1,292
	30	60	1 3/16	62	4	FLT3060MCT	\$675		
	30	60	1 3/16	62	4	FLV3060MCT		\$1,068	\$1,175

· eased edge profile on approach and user sides

FLUX - PRIVATE OFFICE

To Order, Specify:

① Laminate Model #	② Laminate Type	③ Laminate Selection	④ Metal Color	⑤ Other Product Options
Laminate (FLT)	HPL	See Laminate Selection	See Metal Finish Color Options	See list of options for each specific unit; Specify and add accordingly.

① Veneer Model #	② Wood Species	③ Wood Finish	④ Metal Color	⑤ Other Product Options
Veneer (FLV)	Flat Cut CH1 Cherry MA1 Maple WA1 Walnut BO1 Black Oak	See Flat Cut Wood Finish Options	See Metal Finish Color Options	See list of options for each specific unit; Specify and add accordingly.
		<table border="1"> <thead> <tr> <th>③a Wood Finish</th> <th>③b Chassis Grain Direction</th> </tr> </thead> <tbody> <tr> <td>See Double Cut Wood Finish Options</td> <td>For Double Cut Only: Vertical Horizontal</td> </tr> </tbody> </table>		
③a Wood Finish	③b Chassis Grain Direction			
See Double Cut Wood Finish Options	For Double Cut Only: Vertical Horizontal			

Description	D	W	H	CTN WT	CU FT	① Model	HPL Laminate	Flat Cut Veneer	Double Cut Veneer
 Modular File/File Desk Pedestal	36	18	28	110	14	FLT3618-29FM2	\$1,187		
	36	18	28	110	14	FLV3618-29FM2		\$1,784	\$1,961
	36	15%	28	100	12	FLT3616-29FM2	\$1,169		
	36	15%	28	100	12	FLV3616-29FM2		\$1,757	\$1,933
	30	18	28	97	12	FLT3018-29FM2	\$1,154		
	30	18	28	97	12	FLV3018-29FM2		\$1,733	\$1,906
	30	15%	28	90	10	FLT3016-29FM2	\$1,135		
	30	15%	28	90	10	FLV3016-29FM2		\$1,706	\$1,877

Features:

- use with other modular components, requires a modular top, see page 37
- pedestal front locking

Options:

- must specify chassis grain direction on double cut veneer, see pages 11-13 for details
- veneer drawer fronts in paint available, specify paint color and add \$337 list; see page 14 for details
- on laminate units, contrasting fronts available, no upcharge; specify color, see page 14 for details
- ledge pulls standard; prism pulls available, specify and see page 9

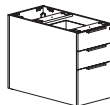

Description	D	W	H	CTN WT	CU FT	① Model	HPL Laminate	Flat Cut Veneer	Double Cut Veneer
 Modular Box/Box/File Desk Pedestal	36	18	28	114	14	FLT3618-29FM1	\$1,193		
	36	18	28	114	14	FLV3618-29FM1		\$1,793	\$1,972
	36	15%	28	104	12	FLT3616-29FM1	\$1,176		
	36	15%	28	104	12	FLV3616-29FM1		\$1,766	\$1,942
	30	18	28	102	12	FLT3018-29FM1	\$1,159		
	30	18	28	102	12	FLV3018-29FM1		\$1,740	\$1,915
	30	15%	28	95	10	FLT3016-29FM1	\$1,141		
	30	15%	28	95	10	FLV3016-29FM1		\$1,714	\$1,886

Features:

- use with other modular components, requires a modular top, see page 37
- pedestal front locking

Options:

- must specify chassis grain direction on double cut veneer, see pages 11-13 for details
- veneer drawer fronts in paint available, specify paint color and add \$337 list; see page 14 for details
- on laminate units, contrasting fronts available, no upcharge; specify color, see page 14 for details
- ledge pulls standard; prism pulls available, specify and see page 9



Description	D	W	H	CTN WT	CU FT	① Model	HPL Laminate	Flat Cut Veneer	Double Cut Veneer
 left shown  right	36	18	28	74	14	FLT3618WEAR	\$871		
	36	18	28	74	14	FLV3618WEAR		\$1,306	\$1,438
	36	18	28	74	14	FLT3618WEAL	\$871		
	36	18	28	74	14	FLV3618WEAL		\$1,306	\$1,438
	36	15 3/8	28	71	12	FLT3616WEAR	\$857		
	36	15 3/8	28	71	12	FLV3616WEAR		\$1,290	\$1,417
	36	15 3/8	28	71	12	FLT3616WEAL	\$857		
	36	15 3/8	28	71	12	FLV3616WEAL		\$1,290	\$1,417

Features:

- use with other modular components, requires a modular top, see page 37

Options:

- must specify chassis grain direction on double cut veneer, see pages 11-13 for details

Description	D	W	H	CTN WT	CU FT	① Model	HPL Laminate	Flat Cut Veneer	Double Cut Veneer
 left shown  right	30	18	28	68	12	FLT3018WEAR	\$854		
	30	18	28	68	12	FLV3018WEAR		\$1,283	\$1,411
	30	18	28	68	12	FLT3018WEAL	\$854		
	30	18	28	68	12	FLV3018WEAL		\$1,283	\$1,411
	30	15 3/8	28	65	10	FLT3016WEAR	\$841		
	30	15 3/8	28	65	10	FLV3016WEAR		\$1,261	\$1,390
	30	15 3/8	28	65	10	FLT3016WEAL	\$841		
	30	15 3/8	28	65	10	FLV3016WEAL		\$1,261	\$1,390

Features:

- use with other modular components, requires a modular top, see page 37

Options:

- must specify chassis grain direction on double cut veneer, see pages 11-13 for details

To Order, Specify:

① Laminate Model #	② Laminate Type	③ Laminate Selection	④ Metal Color	⑤ Other Product Options
Laminate (FLT)	HPL	See Laminate Selection	See Metal Finish Color Options	See list of options for each specific unit; Specify and add accordingly.

① Veneer Model #	② Wood Species	③ Wood Finish	④ Metal Color	⑤ Other Product Options
Veneer (FLV)	Flat Cut CH1 Cherry MA1 Maple WA1 Walnut BO1 Black Oak	See Flat Cut Wood Finish Options	See Metal Finish Color Options	See list of options for each specific unit; Specify and add accordingly.
		<table border="1"> <thead> <tr> <th>ⓐ Wood Finish</th> <th>ⓑ Chassis Grain Direction</th> </tr> </thead> <tbody> <tr> <td>See Double Cut Wood Finish Options</td> <td>For Double Cut Only: Vertical Horizontal</td> </tr> </tbody> </table>		
ⓐ Wood Finish	ⓑ Chassis Grain Direction			
See Double Cut Wood Finish Options	For Double Cut Only: Vertical Horizontal			

Description	D	W	H	CTN WT	CU FT	① Model	HPL Laminate	Fiat Cut Veneer	Double Cut Veneer
	7/8	48	28	34	3	FLT2848MDA	\$405		
	7/8	48	28	34	3	FLV2848MDA		\$605	\$666
	7/8	42	28	31	3	FLT2842MDA	\$351		
	7/8	42	28	31	3	FLV2842MDA		\$524	\$578
	7/8	36	28	27	2	FLT2836MDA	\$325		
	7/8	36	28	27	2	FLV2836MDA		\$486	\$536
	7/8	40 3/4	28	30	3	FLT2841MDA	\$346		
	7/8	40 3/4	28	30	3	FLV2841MDA		\$516	\$567
	7/8	34 3/4	28	27	2	FLT2835MDA	\$316		
	7/8	34 3/4	28	27	2	FLV2835MDA		\$472	\$520
	7/8	27 3/4	28	23	2	FLT2829MDA	\$315		
	7/8	27 3/4	28	23	2	FLV2829MDA		\$461	\$505

Features:

- use with other modular components, requires a modular top, see page 37

Options:

- must specify chassis grain direction on double cut veneer, see pages 11-13 for details

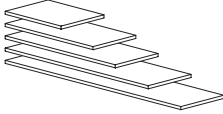
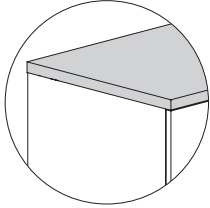
Description	D	W	H	CTN WT	CU FT	① Model	HPL Laminate	Flat Cut Veneer	Double Cut Veneer
Modular Credenza Top for Primary Height  	22	108	1 3/16	80	5	FLT22108MCT	\$891		
	22	108	1 3/16	80	5	FLV22108MCT		\$1,407	\$1,548
	22	102	1 3/16	76	5	FLT22102MCT	\$841		
	22	102	1 3/16	76	5	FLV22102MCT		\$1,329	\$1,463
	22	96	1 3/16	72	5	FLT2296MCT	\$793		
	22	96	1 3/16	72	5	FLV2296MCT		\$1,251	\$1,375
	22	90	1 3/16	68	5	FLT2290MCT	\$742		
	22	90	1 3/16	68	5	FLV2290MCT		\$1,174	\$1,292
	22	84	1 3/16	64	4	FLT2284MCT	\$692		
	22	84	1 3/16	64	4	FLV2284MCT		\$1,095	\$1,205
	22	78	1 3/16	59	4	FLT2278MCT	\$645		
	22	78	1 3/16	59	4	FLV2278MCT		\$1,018	\$1,120
	22	72	1 3/16	55	4	FLT2272MCT	\$595		
	22	72	1 3/16	55	4	FLV2272MCT		\$937	\$1,034
	22	66	1 3/16	51	4	FLT2266MCT	\$545		
	22	66	1 3/16	51	4	FLV2266MCT		\$861	\$948
	22	60	1 3/16	47	3	FLT2260MCT	\$496		
	22	60	1 3/16	47	3	FLV2260MCT		\$783	\$861
	22	54	1 3/16	43	3	FLT2254MCT	\$448		
	22	54	1 3/16	43	3	FLV2254MCT		\$707	\$777
	22	48	1 3/16	39	3	FLT2248MCT	\$398		
	22	48	1 3/16	39	3	FLV2248MCT		\$627	\$689
	22	42	1 3/16	35	2	FLT2242MCT	\$349		
	22	42	1 3/16	35	2	FLV2242MCT		\$550	\$605
	22	36	1 3/16	30	2	FLT2236MCT	\$299		
	22	36	1 3/16	30	2	FLV2236MCT		\$471	\$519
	22	30	1 3/16	26	2	FLT2230MCT	\$249		
	22	30	1 3/16	26	2	FLV2230MCT		\$393	\$432
22	18	1 3/16	15	1	FLT2218MCT	\$223			
22	18	1 3/16	15	1	FLV2218MCT		\$323	\$356	

Features:

- use with primary height modular components
- eased edge profile user side

To Order, Specify:

① Laminate Model #	② Laminate Type	③ Laminate Selection	④ Metal Color	⑤ Other Product Options
Laminate (FLT)	HPL	See Laminate Selection	See Metal Finish Color Options	See list of options for each specific unit; Specify and add accordingly.

① Veneer Model #	② Wood Species	③ Wood Finish	④ Metal Color	⑤ Other Product Options
Veneer (FLV)	Flat Cut CH1 Cherry MA1 Maple WA1 Walnut BO1 Black Oak	See Flat Cut Wood Finish Options	See Metal Finish Color Options	See list of options for each specific unit; Specify and add accordingly.
		③a Wood Finish See Double Cut Wood Finish Options		

FLUX - PRIVATE OFFICE

Description	D	W	H	CTN WT	CU FT	① Model	HPL Laminate	Fiat Cut Veneer	Double Cut Veneer
Modular Return Top for Primary Height (short grain)	22	60	1 3/16	47	3	FLT6022MRT	\$517		
	22	60	1 3/16	47	3	FLV6022MRT		\$803	\$883
	22	54	1 3/16	43	3	FLT5422MRT	\$469		
	22	54	1 3/16	43	3	FLV5422MRT		\$727	\$797
	22	48	1 3/16	39	3	FLT4822MRT	\$420		
	22	48	1 3/16	39	3	FLV4822MRT		\$648	\$711
	22	42	1 3/16	32	4	FLT4222MRT	\$376		
	22	42	1 3/16	32	4	FLV4222MRT		\$579	\$638
	22	36	1 3/16	29	4	FLT3622MRT	\$339		
	22	36	1 3/16	29	4	FLV3622MRT		\$524	\$574

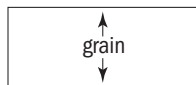
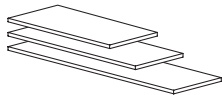

Features:

- use with primary height modular components
- eased edge profile user side
- grain patterns runs short
- mounting brackets included

Modular File/File Credenza Pedestal	22	18	28	87	9	FLT2218-29FM2	\$1,117		
	22	18	28	87	9	FLV2218-29FM2		\$1,675	\$1,845
	22	15 5/8	28	80	8	FLT2216-29FM2	\$1,104		
	22	15 5/8	28	80	8	FLV2216-29FM2		\$1,658	\$1,823



Features:

- use with other modular components, requires a modular top, see page 37
- pedestal front locking

Options:

- must specify chassis grain direction on double cut veneer, see pages 11-13 for details
- veneer drawer fronts in paint available, specify paint color and add \$337 list; see page 14 for details
- on laminate units, contrasting fronts available, no upcharge; specify color, see page 14 for details
- ledge pulls standard; prism pulls available, specify and see page 9

Modular Box/Box/File Credenza Pedestal	22	18	28	89	9	FLT2218-29FM1	\$1,122		
	22	18	28	89	9	FLV2218-29FM1		\$1,685	\$1,854
	22	15 5/8	28	82	8	FLT2216-29FM1	\$1,109		
	22	15 5/8	28	82	8	FLV2216-29FM1		\$1,665	\$1,830



Features:

- use with other modular components, requires a modular top, see page 37
- pedestal front locking

Options:

- must specify chassis grain direction on double cut veneer, see pages 11-13 for details
- veneer drawer fronts in paint available, specify paint color and add \$337 list; see page 14 for details
- on laminate units, contrasting fronts available, no upcharge; specify color, see page 14 for details
- ledge pulls standard; prism pulls available, specify and see page 9

Description	D	W	H	CTN WT	CU FT	① Model	HPL Laminate	Flat Cut Veneer	Double Cut Veneer
Modular Hinge Door	22	18	28	74	9	FLT2218-29FM7R	\$690		
Storage Pedestal	22	18	28	74	9	FLV2218-29FM7R		\$1,038	\$1,141
	22	18	28	74	9	FLT2218-29FM7L	\$690		
	22	18	28	74	9	FLV2218-29FM7L		\$1,038	\$1,141
	22	15 3/8	28	68	8	FLT2216-29FM7R	\$679		
	22	15 3/8	28	68	8	FLV2216-29FM7R		\$1,018	\$1,120
	22	15 3/8	28	68	8	FLT2216-29FM7L	\$679		
	22	15 3/8	28	68	8	FLV2216-29FM7L		\$1,018	\$1,120

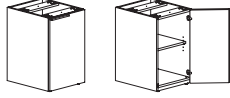

right shown

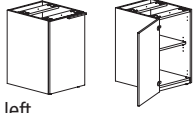

left

Features:

- use with other modular components, requires a modular top, see page 37
- hinged door compartment has one adjustable shelf

Options:

- must specify chassis grain direction on double cut veneer, see pages 11-13 for details
- locking doors available, specify and add \$142 list
- veneer door fronts in paint available, specify paint color and add \$337 list; see page 14 for details
- on laminate units, contrasting fronts available, no upcharge; specify color, see page 14 for details
- ledge pulls standard; prism pulls available, specify and see page 9
- pull out trash can available, specify, add \$456 list; see page 36 for details

Modular Open Compartment	22	18	28	66	13	FLT2218-29FM0	\$629		
	22	18	28	66	13	FLV2218-29FM0		\$945	\$1,040



Features:

- use with other modular components, requires a modular top, see page 37
- compartment has one adjustable shelf

Options:

- must specify chassis grain direction on double cut veneer, see pages 11-13 for details

To Order, Specify:

① Laminate Model #	② Laminate Type	③ Laminate Selection	④ Metal Color	⑤ Other Product Options
Laminate (FLT)	HPL	See Laminate Selection	See Metal Finish Color Options	See list of options for each specific unit; Specify and add accordingly.

① Veneer Model #	② Wood Species	③ Wood Finish	④ Metal Color	⑤ Other Product Options
Veneer (FLV)	Flat Cut CH1 Cherry MA1 Maple WA1 Walnut BO1 Black Oak	See Flat Cut Wood Finish Options	See Metal Finish Color Options	See list of options for each specific unit; Specify and add accordingly.
		<table border="1"> <thead> <tr> <th>ⓐ Wood Finish</th> <th>ⓑ Chassis Grain Direction</th> </tr> </thead> <tbody> <tr> <td>See Double Cut Wood Finish Options</td> <td>For Double Cut Only: Vertical Horizontal</td> </tr> </tbody> </table>		
ⓐ Wood Finish	ⓑ Chassis Grain Direction			
See Double Cut Wood Finish Options	For Double Cut Only: Vertical Horizontal			

Description	D	W	H	CTN WT	CU FT	① Model	HPL Laminate	Flat Cut Veneer	Double Cut Veneer
Modular Lateral Credenza Pedestal	22	36	28	141	16	FLT2236-29FM4	\$1,358		
	22	36	28	141	16	FLV2236-29FM4		\$2,036	\$2,240
	22	30	28	128	14	FLT2230-29FM4	\$1,323		
	22	30	28	128	14	FLV2230-29FM4		\$1,985	\$2,186

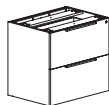

Features:

- use with other modular components, requires a modular top, see page 37
- pedestal front locking

Options:

- must specify chassis grain direction on double cut veneer, see pages 11-13 for details
- veneer drawer fronts in paint available, specify paint color and add \$337 list; see page 14 for details
- on laminate units, contrasting fronts available, no upcharge; specify color, see page 14 for details
- ledge pulls standard; prism pulls available, specify and see page 9

Modular Lateral Credenza Pedestal	22	36	28	141	16	FLT2236-29FM3	\$1,364		
	22	36	28	141	16	FLV2236-29FM3		\$2,047	\$2,252
	22	30	28	129	14	FLT2230-29FM3	\$1,329		
	22	30	28	129	14	FLV2230-29FM3		\$1,996	\$2,197



Features:

- use with other modular components, requires a modular top, see page 37
- pedestal front locking

Options:

- must specify chassis grain direction on double cut veneer, see pages 11-13 for details
- veneer drawer fronts in paint available, specify paint color and add \$337 list; see page 14 for details
- on laminate units, contrasting fronts available, no upcharge; specify color, see page 14 for details
- ledge pulls standard; prism pulls available, specify and see page 9

Modular Credenza Multi-File Pedestal	22	30	28	138	14	FLT2230-29FMRM	\$1,438		
	22	30	28	138	14	FLV2230-29FMRM		\$2,160	\$2,376
	22	30	28	138	14	FLT2230-29FMLM	\$1,438		
	22	30	28	138	14	FLV2230-29FMLM		\$2,160	\$2,376



right shown

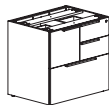

left

Features:

- use with other modular components, requires a modular top, see page 37
- pedestal front locking

Options:

- must specify chassis grain direction on double cut veneer, see pages 11-13 for details
- veneer drawer fronts in paint available, specify paint color and add \$337 list; see page 14 for details
- on laminate units, contrasting fronts available, no upcharge; specify color, see page 14 for details
- ledge pulls standard; prism pulls available, specify and see page 9

Modular Hinge Door Credenza Pedestal	22	36	28	122	16	FLT2236-29FM7	\$1,151		
	22	36	28	122	16	FLV2236-29FM7		\$1,728	\$1,898
	22	30	28	108	14	FLT2230-29FM7	\$1,104		
	22	30	28	108	14	FLV2230-29FM7		\$1,659	\$1,824

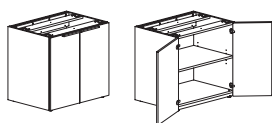

Features:

- use with other modular components, requires a modular top, see page 37
- hinged door compartment has one adjustable shelf

Options:

- must specify chassis grain direction on double cut veneer, see pages 11-13 for details
- locking doors available, specify and add \$142 list
- veneer door fronts in paint available, specify paint color and add \$337 list; see page 14 for details
- on laminate units, contrasting laminate door fronts available, no upcharge; specify laminate color, see page 14 for details
- ledge pulls standard; prism pulls available, specify and see page 9

Description	D	W	H	CTN WT	CU FT	① Model	HPL Laminate	Flat Cut Veneer	Double Cut Veneer
Modular Hinge Door with Open Shelf Credenza Pedestal	22	36	28	132	16	FLT2236-29FM8	\$1,168		
	22	36	28	132	16	FLV2236-29FM8		\$1,753	\$1,930
	22	30	28	116	14	FLT2230-29FM8	\$1,123		
	22	30	28	116	14	FLV2230-29FM8		\$1,688	\$1,856

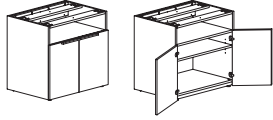

Features:

- use with other modular components, requires a modular top, see page 37
- hinged door compartment has one adjustable shelf

Options:

- must specify chassis grain direction on double cut veneer, see pages 11-13 for details
- locking doors available, specify and add \$142 list
- veneer door fronts in paint available, specify paint color and add \$337 list; see page 14 for details
- on laminate units, contrasting laminate door fronts available, no upcharge; specify laminate color, see page 14 for details
- ledge pulls standard; prism pulls available, specify and see page 9

Modular Open Compartment	D	W	H	CTN WT	CU FT	Model	HPL Laminate	Flat Cut Veneer	Double Cut Veneer
Modular Open Compartment	22	36	28	101	16	FLT2236-29FM0	\$1,019		
	22	36	28	101	16	FLV2236-29FM0		\$1,530	\$1,684
	22	30	28	91	14	FLT2230-29FM0	\$995		
	22	30	28	91	14	FLV2230-29FM0		\$1,493	\$1,642



Features:

- use with other modular components, requires a modular top, see page 37
- compartment has one adjustable shelf

Options:

- must specify chassis grain direction on double cut veneer, see pages 11-13 for details

To Order, Specify:

① Laminate Model #	② Laminate Type	③ Laminate Selection	④ Metal Color	⑤ Other Product Options
Laminate (FLT)	HPL	See Laminate Selection	See Metal Finish Color Options	See list of options for each specific unit; Specify and add accordingly.

① Veneer Model #	② Wood Species	③ Wood Finish	④ Metal Color	⑤ Other Product Options
Veneer (FLV)	Flat Cut CH1 Cherry MA1 Maple WA1 Walnut BO1 Black Oak	See Flat Cut Wood Finish Options	See Metal Finish Color Options	See list of options for each specific unit; Specify and add accordingly.
		<table border="1"> <thead> <tr> <th>ⓐ Wood Finish</th> <th>ⓑ Chassis Grain Direction</th> </tr> </thead> <tbody> <tr> <td>See Double Cut Wood Finish Options</td> <td>For Double Cut Only: Vertical Horizontal</td> </tr> </tbody> </table>		
ⓐ Wood Finish	ⓑ Chassis Grain Direction			
See Double Cut Wood Finish Options	For Double Cut Only: Vertical Horizontal			

Description	D	W	H	CTN WT	CU FT	① Model	HPL Laminate	Flat Cut Veneer	Double Cut Veneer
Modular Box/File Pedestal - Primary Height	22	18	28	85	9	FLT2218-29LM5	\$1,755		
	22	18	28	85	9	FLV2218-29LM5		\$2,278	\$2,506



Features:

- must be connected to another unit with a common top, this unit is not freestanding
- pedestal front locking

Options:

- must specify chassis grain direction on double cut veneer, see pages 11-13 for details
- veneer drawer fronts in paint available, specify paint color and add \$337 list; see page 14 for details
- on laminate units, contrasting fronts available, no upcharge; specify color, see page 14 for details
- ledge pulls standard; prism pulls available, specify and see page 9

Modular Single Door Storage Pedestal - Primary Height	22	18	28	72	9	FLT2218-29LM7R	\$1,575		
	22	18	28	72	9	FLV2218-29LM7R		\$2,043	\$2,247
	22	18	28	72	9	FLT2218-29LM7L	\$1,575		
	22	18	28	72	9	FLV2218-29LM7L		\$2,043	\$2,247

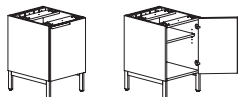

right shown

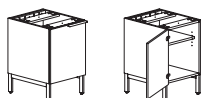

left

Features:

- must be connected to another unit with a common top, this unit is not freestanding

Options:

- must specify chassis grain direction on double cut veneer, see pages 11-13 for details
- locking door available, specify and add \$142 list
- veneer door fronts in paint available, specify paint color and add \$337 list; see page 14 for details
- on laminate units, contrasting laminate door fronts available, no upcharge; specify laminate color, see page 14 for details
- ledge pulls standard; prism pulls available, specify and see page 9

Modular Open Compartment - Primary Height	22	18	28	66	13	FLT2218-29LM0	\$1,513		
	22	18	28	66	13	FLV2218-29LM0		\$1,950	\$2,145



Features:

- use with other modular components, requires a modular top, see page 37
- open compartment with adjustable shelf

Options:

- must specify chassis grain direction on double cut veneer, see pages 11-13 for details

Modular Box/Lateral File - Primary Height	22	36	28	129	16	FLT2236-29LM6	\$2,043		
	22	36	28	129	16	FLV2236-29LM6		\$2,651	\$2,917
	22	30	28	125	14	FLT2230-29LM6	\$1,983		
	22	30	28	125	14	FLV2230-29LM6		\$2,573	\$2,832



Features:

- must be connected to another unit with a common top, this unit is not freestanding
- pedestal front locking

Options:

- must specify chassis grain direction on double cut veneer, see pages 11-13 for details
- veneer drawer fronts in paint available, specify paint color and add \$337 list; see page 14 for details
- on laminate units, contrasting fronts available, no upcharge; specify color, see page 14 for details
- ledge pulls standard; prism pulls available, specify and see page 9

Modular Hidden Drawer Pedestal - Primary Height	22	36	28	131	16	FLT2236-29LMB	\$2,280		
	22	36	28	131	16	FLV2236-29LMB		\$2,958	\$3,256
	22	30	28	121	14	FLT2230-29LMB	\$2,221		
	22	30	28	121	14	FLV2230-29LMB		\$2,881	\$3,171



Features:

- must be connected to another unit with a common top, this unit is not freestanding
- pedestal front locking
- concealed box drawer

Options:

- must specify chassis grain direction on double cut veneer, see pages 11-13 for details
- veneer drawer fronts in paint available, specify paint color and add \$337 list; see page 14 for details
- on laminate units, contrasting fronts available, no upcharge; specify color, see page 14 for details
- ledge pulls standard; prism pulls available, specify and see page 9

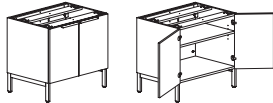
Description	D	W	H	CTN WT	CU FT	① Model	HPL Laminate	Flat Cut Veneer	Double Cut Veneer
	22	36	28	114	16	FLT2236-29LM7	\$1,774		
	22	36	28	114	16	FLV2236-29LM7		\$2,303	\$2,531
	22	30	28	103	14	FLT2230-29LM7	\$1,732		
	22	30	28	103	14	FLV2230-29LM7		\$2,244	\$2,470

Features:

- use with other modular components, requires a modular top, see page 37
- hinged door compartment has one adjustable shelf

Options:

- must specify chassis grain direction on double cut veneer, see pages 11-13 for details
- locking doors available, specify and add \$142 list
- veneer door fronts in paint available, specify paint color and add \$337 list; see page 14 for details
- on laminate units, contrasting laminate door fronts available, no upcharge; specify laminate color, see page 14 for details
- ledge pulls standard; prism pulls available, specify and see page 9

	22	36	28	109	16	FLT2236-29LM8	\$1,796		
	22	36	28	109	16	FLV2236-29LM8		\$2,331	\$2,565
	22	30	28	99	14	FLT2230-29LM8	\$1,752		
	22	30	28	99	14	FLV2230-29LM8		\$2,274	\$2,501

Features:

- must be connected to another unit with a common top, this unit is not freestanding
- hinged door compartment has one adjustable shelf

Options:

- must specify chassis grain direction on double cut veneer, see pages 11-13 for details
- locking doors available, specify and add \$142 list
- veneer door fronts in paint available, specify paint color and add \$337 list; see page 14 for details
- on laminate units, contrasting laminate door fronts available, no upcharge; specify laminate color, see page 14 for details
- ledge pulls standard; prism pulls available, specify and see page 9

	22	36	28	99	16	FLT2236-29LM0	\$1,631		
	22	36	28	99	16	FLV2236-29LM0		\$2,117	\$2,330
	22	30	28	91	14	FLT2230-29LM0	\$1,592		
	22	30	28	91	14	FLV2230-29LM0		\$2,067	\$2,274

Features:

- use with other modular components, requires a modular top, see page 37
- open compartment with adjustable shelf

Options:

- must specify chassis grain direction on double cut veneer, see pages 11-13 for details

To Order, Specify:

① Laminate Model #	② Laminate Type	③ Laminate Selection	④ Metal Color	⑤ Other Product Options
Laminate (FLT)	HPL	See Laminate Selection	See Metal Finish Color Options	See list of options for each specific unit; Specify and add accordingly.

① Veneer Model #	② Wood Species	③ Wood Finish	④ Metal Color	⑤ Other Product Options	
Veneer (FLV)	Flat Cut CH1 Cherry MA1 Maple WA1 Walnut BO1 Black Oak	See Flat Cut Wood Finish Options	See Metal Finish Color Options	See list of options for each specific unit; Specify and add accordingly.	
	Double Cut DC1 Double Cut	<table border="1"> <thead> <tr> <th>ⓐ Wood Finish</th> <th>ⓑ Chassis Grain Direction</th> </tr> </thead> <tbody> <tr> <td>See Double Cut Wood Finish Options</td> <td>For Double Cut Only: Vertical Horizontal</td> </tr> </tbody> </table>			ⓐ Wood Finish
ⓐ Wood Finish	ⓑ Chassis Grain Direction				
See Double Cut Wood Finish Options	For Double Cut Only: Vertical Horizontal				

Description	D	W	H	CTN WT	CU FT	① Model	HPL Laminate	Fiat Cut Veneer	Double Cut Veneer
Modular Credenza Wing End Support for Primary Height Units	22	18	28	43	9	FLT2218WEAR	\$595		
	22	18	28	43	9	FLV2218WEAR		\$891	\$979
	22	18	28	43	9	FLT2218WEAL	\$595		
	22	18	28	43	9	FLV2218WEAL		\$891	\$979
	22	15 ⁵ / ₁₆	28	40	8	FLT2216WEAR	\$585		
	22	15 ⁵ / ₁₆	28	40	8	FLV2216WEAR		\$879	\$967
	22	15 ⁵ / ₁₆	28	40	8	FLT2216WEAL	\$585		
	22	15 ⁵ / ₁₆	28	40	8	FLV2216WEAL		\$879	\$967



right shown



left

Features:

- use with other modular components, requires a modular top, see page 37

Options:

- must specify chassis grain direction on double cut veneer, see pages 11-13 for details

Description	D	W	H	CTN WT	CU FT	① Model	HPL Laminate	Fiat Cut Veneer	Double Cut Veneer
Modular Desk T-Support for Secondary Height Units	33 ¹ / ₄	11 ³ / ₁₆	28	48	9	FLT3428-MDTS	\$775		
	33 ¹ / ₄	11 ³ / ₁₆	28	48	9	FLV3428-MDTS		\$1,007	\$1,105
	27 ¹ / ₄	11 ³ / ₁₆	28	41	7	FLT2828-MDTS	\$672		
	27 ¹ / ₄	11 ³ / ₁₆	28	41	7	FLV2828-MDTS		\$873	\$959
	21 ³ / ₄	11 ³ / ₁₆	28	31	6	FLT2228-MDTS	\$646		
	21 ³ / ₄	11 ³ / ₁₆	28	31	6	FLV2228-MDTS		\$838	\$924

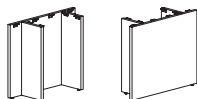

Features:

- use with other modular components, requires a modular top, see page 37

Options:

- must specify chassis grain direction on double cut veneer, see pages 11-13 for details

Description	D	W	H	CTN WT	CU FT	① Model	HPL Laminate	Fiat Cut Veneer	Double Cut Veneer
Modular Desk T-Support for Secondary Height Units	33 ¹ / ₄	11 ³ / ₁₆	6 ³ / ₁₆	19	3	FLT3407-MDTS	\$561		
	33 ¹ / ₄	11 ³ / ₁₆	6 ³ / ₁₆	19	3	FLV3407-MDTS		\$727	\$800
	27 ¹ / ₄	11 ³ / ₁₆	6 ³ / ₁₆	16	2	FLT2807-MDTS	\$538		
	27 ¹ / ₄	11 ³ / ₁₆	6 ³ / ₁₆	16	2	FLV2807-MDTS		\$701	\$770
	21 ³ / ₄	11 ³ / ₁₆	6 ³ / ₁₆	12	2	FLT2207-MDTS	\$519		
	21 ³ / ₄	11 ³ / ₁₆	6 ³ / ₁₆	12	2	FLV2207-MDTS		\$674	\$741



Features:

- use with other modular components, requires a modular top, see page 37

Options:

- must specify chassis grain direction on double cut veneer, see pages 11-13 for details

Description	D	W	H	CTN WT	CU FT	1 Model	HPL Laminate	Flat Cut Veneer	Double Cut Veneer
Modular Credenza Full Modesty Panel for Primary Height Modular Units	¾	47 7/8	28	35	3	FLT2848MCFA	\$405		
	¾	47 7/8	28	35	3	FLV2848MCFA		\$605	\$666
	¾	41 7/8	28	32	3	FLT2842MCFA	\$351		
	¾	41 7/8	28	32	3	FLV2842MCFA		\$524	\$578
	¾	35 7/8	28	28	2	FLT2836MCFA	\$325		
	¾	35 7/8	28	28	2	FLV2836MCFA		\$486	\$536
	¾	29 7/8	28	24	2	FLT2830MCFA	\$300		
	¾	29 7/8	28	24	2	FLV2830MCFA		\$449	\$494
	¾	23 7/8	28	20	2	FLT2824MCFA	\$293		
	¾	23 7/8	28	20	2	FLV2824MCFA		\$436	\$481
	¾	17 7/8	28	18	2	FLT2818MCFA	\$290		
	¾	17 7/8	28	18	2	FLV2818MCFA		\$432	\$475

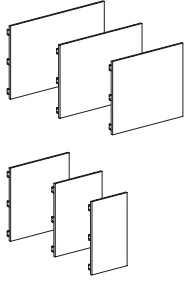

Features:

- use with other modular components, requires a modular top, see page 37

Options:

- must specify chassis grain direction on double cut veneer, see pages 11-13 for details

Description	D	W	H	CTN WT	CU FT	1 Model	HPL Laminate	Flat Cut Veneer	Double Cut Veneer
Modular Credenza Partial Modesty Panel for Primary Height Modular Units	¾	47 7/8	12	21	2	FLT2848MCPA	\$405		
	¾	47 7/8	12	21	2	FLV2848MCPA		\$605	\$666
	¾	41 7/8	12	19	2	FLT2842MCPA	\$351		
	¾	41 7/8	12	19	2	FLV2842MCPA		\$524	\$578
	¾	35 7/8	12	17	1	FLT2836MCPA	\$325		
	¾	35 7/8	12	17	1	FLV2836MCPA		\$486	\$536
	¾	29 7/8	12	15	1	FLT2830MCPA	\$300		
	¾	29 7/8	12	15	1	FLV2830MCPA		\$449	\$494
	¾	23 7/8	12	13	1	FLT2824MCPA	\$293		
	¾	23 7/8	12	13	1	FLV2824MCPA		\$436	\$481
	¾	17 7/8	12	11	1	FLT2818MCPA	\$290		
	¾	17 7/8	12	11	1	FLV2818MCPA		\$432	\$475

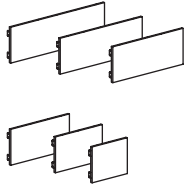

Features:

- use with other modular components, requires a modular top, see page 37

Options:

- must specify chassis grain direction on double cut veneer, see pages 11-13 for details

To Order, Specify:

1 Laminate Model #	2 Laminate Type	3 Laminate Selection	4 Metal Color	5 Other Product Options
Laminate (FLT)	HPL	See Laminate Selection	See Metal Finish Color Options	See list of options for each specific unit; Specify and add accordingly.

1 Veneer Model #	2 Wood Species	3 Wood Finish	4 Metal Color	5 Other Product Options
Veneer (FLV)	Flat Cut CH1 Cherry MA1 Maple WA1 Walnut BO1 Black Oak	See Flat Cut Wood Finish Options	See Metal Finish Color Options	See list of options for each specific unit; Specify and add accordingly.
		<table border="1"> <thead> <tr> <th>3a Wood Finish</th> <th>3b Chassis Grain Direction</th> </tr> </thead> <tbody> <tr> <td>See Double Cut Wood Finish Options</td> <td>For Double Cut Only: Vertical Horizontal</td> </tr> </tbody> </table>		
3a Wood Finish	3b Chassis Grain Direction			
See Double Cut Wood Finish Options	For Double Cut Only: Vertical Horizontal			

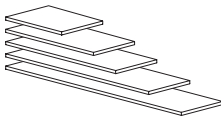
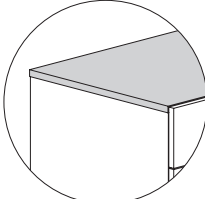
Description	D	W	H	CTN WT	CU FT	① Model	HPL Laminate	Flat Cut Veneer	Double Cut Veneer
Modular Credenza Top for Secondary Height  	21 1/8	108	3/4	57	5	FLT21108MCT	\$648		
	21 1/8	108	3/4	57	5	FLV21108MCT		\$837	\$921
	21 1/8	102	3/4	54	4	FLT21102MCT	\$610		
	21 1/8	102	3/4	54	4	FLV21102MCT		\$792	\$871
	21 1/8	96	3/4	51	4	FLT2196MCT	\$577		
	21 1/8	96	3/4	51	4	FLV2196MCT		\$743	\$817
	21 1/8	90	3/4	48	4	FLT2190MCT	\$541		
	21 1/8	90	3/4	48	4	FLV2190MCT		\$697	\$768
	21 1/8	84	3/4	45	4	FLT2184MCT	\$505		
	21 1/8	84	3/4	45	4	FLV2184MCT		\$651	\$718
	21 1/8	78	3/4	43	3	FLT2178MCT	\$469		
	21 1/8	78	3/4	43	3	FLV2178MCT		\$605	\$666
	21 1/8	72	3/4	40	3	FLT2172MCT	\$432		
	21 1/8	72	3/4	40	3	FLV2172MCT		\$558	\$615
	21 1/8	66	3/4	37	3	FLT2166MCT	\$398		
	21 1/8	66	3/4	37	3	FLV2166MCT		\$514	\$563
	21 1/8	60	3/4	34	3	FLT2160MCT	\$360		
	21 1/8	60	3/4	34	3	FLV2160MCT		\$466	\$514
	21 1/8	54	3/4	31	3	FLT2154MCT	\$325		
	21 1/8	54	3/4	31	3	FLV2154MCT		\$421	\$463
	21 1/8	48	3/4	28	2	FLT2148MCT	\$290		
	21 1/8	48	3/4	28	2	FLV2148MCT		\$375	\$412
	21 1/8	42	3/4	25	2	FLT2142MCT	\$254		
	21 1/8	42	3/4	25	2	FLV2142MCT		\$327	\$360
	21 1/8	36	3/4	23	2	FLT2136MCT	\$217		
	21 1/8	36	3/4	23	2	FLV2136MCT		\$281	\$310
	21 1/8	30	3/4	20	2	FLT2130MCT	\$211		
	21 1/8	30	3/4	20	2	FLV2130MCT		\$272	\$298
	21 1/8	18	3/4	14	1	FLT2118MCT	\$203		
	21 1/8	18	3/4	14	1	FLV2118MCT		\$261	\$286

Features:

- use with secondary height modular components; designed to fit behind drawer fronts and door fronts
- eased edge profile user side

Description	D	W	H	CTN WT	CU FT	① Model	HPL Laminate	Flat Cut Veneer	Double Cut Veneer
Modular Box/File Pedestal - Secondary Height	22	18	21	69	7	FLT2218-21FM5	\$825		
	22	18	21	69	7	FLV2218-21FM5		\$1,152	\$1,265



Options:

- must specify chassis grain direction on double cut veneer, see pages 11-13 for details
- veneer drawer fronts in paint available, specify paint color and add \$337 list; see page 14 for details
- on laminate units, contrasting fronts available, no upcharge; specify color, see page 14 for details
- ledge pulls standard; prism pulls available, specify and see page 9

Modular Single Door Storage Pedestal - Secondary Height	22	18	21	59	7	FLT2218-21FM7R	\$633		
	22	18	21	59	7	FLV2218-21FM7R		\$883	\$971
	22	18	21	59	7	FLT2218-21FM7L	\$633		
	22	18	21	59	7	FLV2218-21FM7L		\$883	\$971

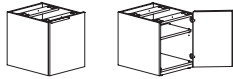

right shown

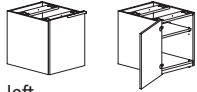

left

Features:

- use with other modular components, requires a modular top, see page 37
- hinged door compartment has one adjustable shelf

Options:

- must specify chassis grain direction on double cut veneer, see pages 11-13 for details
- locking door available, specify and add \$142 list
- veneer door fronts in paint available, specify paint color and add \$337 list; see page 14 for details
- on laminate units, contrasting laminate door fronts available, no upcharge; specify laminate color, see page 14 for details
- ledge pulls standard; prism pulls available, specify and see page 9

Modular Open Compartment	22	18	21	54	10	FLT2218-21FM0	\$565		
	22	18	21	54	10	FLV2218-21FM0		\$789	\$866



Features:

- use with other modular components, requires a modular top, see page 37
- open compartment with adjustable shelf

Options:

- must specify chassis grain direction on double cut veneer, see pages 11-13 for details

To Order, Specify:

① Laminate Model #	② Laminate Type	③ Laminate Selection	④ Metal Color	⑤ Other Product Options
Laminate (FLT)	HPL	See Laminate Selection	See Metal Finish Color Options	See list of options for each specific unit; Specify and add accordingly.

① Veneer Model #	② Wood Species	③ Wood Finish	④ Metal Color	⑤ Other Product Options	
Veneer (FLV)	Flat Cut CH1 Cherry MA1 Maple WA1 Walnut BO1 Black Oak	See Flat Cut Wood Finish Options	See Metal Finish Color Options	See list of options for each specific unit; Specify and add accordingly.	
	Double Cut DC1 Double Cut	<table border="1"> <thead> <tr> <th>ⓐ Wood Finish</th> <th>ⓑ Chassis Grain Direction</th> </tr> </thead> <tbody> <tr> <td>See Double Cut Wood Finish Options</td> <td>For Double Cut Only: Vertical Horizontal</td> </tr> </tbody> </table>			ⓐ Wood Finish
ⓐ Wood Finish	ⓑ Chassis Grain Direction				
See Double Cut Wood Finish Options	For Double Cut Only: Vertical Horizontal				

Description	D	W	H	CTN WT	CU FT	① Model	HPL Laminate	Flat Cut Veneer	Double Cut Veneer
Modular Box/Lateral File - Secondary Height	22	36	21	131	13	FLT2236-21FM6	\$1,068		
	22	36	21	131	13	FLV2236-21FM6		\$1,489	\$1,637
	22	30	21	116	11	FLT2230-21FM6	\$1,041		
	22	30	21	116	11	FLV2230-21FM6		\$1,452	\$1,598



Features:

- use with other modular components, requires a modular top, see page 37
- must specify chassis grain direction on double cut veneer, see pages 11-13 for details
- pedestal front locking

Options:

- ledge pulls standard; prism pulls available, specify and see page 9
- veneer drawer fronts in paint available, specify paint color and add \$337 list; see page 14 for details
- on laminate units, contrasting fronts available, no upcharge; specify color, see page 14 for details

Modular Hidden Drawer Pedestal - Secondary Height	22	36	21	134	13	FLT2236-21FMB	\$1,295		
	22	36	21	134	13	FLV2236-21FMB		\$1,806	\$1,985
	22	30	21	118	11	FLT2230-21FMB	\$1,261		
	22	30	21	118	11	FLV2230-21FMB		\$1,760	\$1,938



Features:

- use with other modular components, requires a modular top, see page 37
- pedestal front locking

Options:

- must specify chassis grain direction on double cut veneer, see pages 11-13 for details
- veneer drawer fronts in paint available, specify paint color and add \$337 list; see page 14 for details
- on laminate units, contrasting fronts available, no upcharge; specify color, see page 14 for details
- ledge pulls standard; prism pulls available, specify and see page 9

Modular Two Door Pedestal - Secondary Height	22	36	21	116	13	FLT2236-21FM7	\$1,084		
	22	36	21	116	13	FLV2236-21FM7		\$1,513	\$1,665
	22	30	21	105	11	FLT2230-21FM7	\$1,063		
	22	30	21	105	11	FLV2230-21FM7		\$1,483	\$1,630

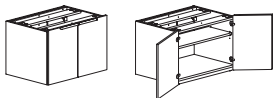

Features:

- use with other modular components, requires a modular top, see page 37
- hinged door compartment has one adjustable shelf

Options:

- must specify chassis grain direction on double cut veneer, see pages 11-13 for details
- locking doors available, specify and add \$142 list
- veneer door fronts in paint available, specify paint color and add \$337 list; see page 14 for details
- on laminate units, contrasting fronts available, no upcharge; specify color, see page 14 for details
- ledge pulls standard; prism pulls available, specify and see page 9

Modular Storage Pedestal with Open Center Shelf - Secondary Height	22	36	21	116	13	FLT2236-21FM8	\$1,111		
	22	36	21	116	13	FLV2236-21FM8		\$1,549	\$1,703
	22	30	21	105	11	FLT2230-21FM8	\$1,084		
	22	30	21	105	11	FLV2230-21FM8		\$1,512	\$1,664

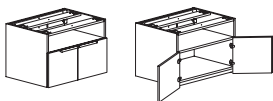

Features:

- use with other modular components, requires a modular top, see page 37

Options:

- must specify chassis grain direction on double cut veneer, see pages 11-13 for details
- locking doors available, specify and add \$142 list
- veneer door fronts in paint available, specify paint color and add \$337 list; see page 14 for details
- on laminate units, contrasting laminate door fronts available, no upcharge; specify laminate color, see page 14 for details
- ledge pulls standard; prism pulls available, specify and see page 9

FLUX - PRIVATE OFFICE



Description	D	W	H	CTN WT	CU FT	① Model	HPL Laminate	Flat Cut Veneer	Double Cut Veneer
	22	36	21	99	13	FLT2236-21FM0	\$980		
	22	36	21	99	13	FLV2236-21FM0		\$1,369	\$1,506
	22	30	21	90	11	FLT2230-21FM0	\$958		
	22	30	21	90	11	FLV2230-21FM0		\$1,337	\$1,471

Features:

- use with other modular components, requires a modular top, see page 37
- open compartment with adjustable shelf

Options:

- must specify chassis grain direction on double cut veneer, see pages 11-13 for details

Description	D	W	H	CTN WT	CU FT	① Model	HPL Laminate	Flat Cut Veneer	Double Cut Veneer
 <p>*OE shown</p>  <p>*EO</p>	22	36	21	106	13	FLT2236-21FME0	\$1,379		
	22	36	21	106	13	FLV2236-21FME0		\$1,926	\$2,117
	22	36	21	106	13	FLT2236-21FM0E	\$1,379		
	22	36	21	106	13	FLV2236-21FM0E		\$1,926	\$2,117
	22	30	21	94	11	FLT2230-21FME0	\$1,346		
	22	30	21	94	11	FLV2230-21FME0		\$1,879	\$2,067
	22	30	21	94	11	FLT2230-21FM0E	\$1,346		
	22	30	21	94	11	FLV2230-21FM0E		\$1,879	\$2,067

Features:

- square edge on top
- electrical power unit - EC26 included, specify color
- open compartment with adjustable shelf
- shelf 12 1/2"d

Options:

- must specify chassis grain direction on double cut veneer, see pages 11-13 for details
- oval grommet in back panel can be eliminated upon request, no upcharge

Description	D	W	H	CTN WT	CU FT	① Model	List Price
	2	67	3/4	5	1	GP0267SB	\$112
	2	61	3/4	5	1	GP0261SB	\$100
	2	55	3/4	4	1	GP0255SB	\$94
	2	49	3/4	4	1	GP0249SB	\$85
	2	43	3/4	3	1	GP0243SB	\$80

- required when worksurfaces unsupported span is greater than 48"
- black metal
- includes screws for attachment to worksurfaces 1" thick and greater

To Order, Specify:

① Laminate Model #	② Laminate Type	③ Laminate Selection	④ Metal Color	⑤ Other Product Options
Laminate (FLT)	HPL	See Laminate Selection	See Metal Finish Color Options	See list of options for each specific unit; Specify and add accordingly.

① Veneer Model #	② Wood Species	③ Wood Finish	④ Metal Color	⑤ Other Product Options
Veneer (FLV)	Flat Cut CH1 Cherry MA1 Maple WA1 Walnut BO1 Black Oak	See Flat Cut Wood Finish Options	See Metal Finish Color Options	See list of options for each specific unit; Specify and add accordingly.
		<table border="1"> <thead> <tr> <th>ⓐ Wood Finish</th> <th>ⓑ Chassis Grain Direction</th> </tr> </thead> <tbody> <tr> <td>See Double Cut Wood Finish Options</td> <td>For Double Cut Only: Vertical Horizontal</td> </tr> </tbody> </table>		
ⓐ Wood Finish	ⓑ Chassis Grain Direction			
See Double Cut Wood Finish Options	For Double Cut Only: Vertical Horizontal			

Description	D	W	H	CTN WT	CU FT	① Model	Laminate	Flat Cut Veneer	Double Cut Veneer
Double Height Overhead Cabinet with Six Doors	15 $\frac{7}{8}$ "	95 $\frac{7}{8}$ "	52"	323	55	FLT1696-52S0	\$2,805		
	15 $\frac{7}{8}$ "	95 $\frac{7}{8}$ "	52"	323	55	FLV1696-52S0		\$4,749	\$5,226
	15 $\frac{7}{8}$ "	89 $\frac{7}{8}$ "	52"	306	52	FLT1690-52S0	\$2,635		
	15 $\frac{7}{8}$ "	89 $\frac{7}{8}$ "	52"	306	52	FLV1690-52S0		\$4,462	\$4,908
	15 $\frac{7}{8}$ "	83 $\frac{7}{8}$ "	52"	289	48	FLT1684-52S0	\$2,460		
	15 $\frac{7}{8}$ "	83 $\frac{7}{8}$ "	52"	289	48	FLV1684-52S0		\$4,167	\$4,584

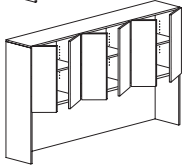
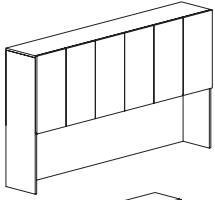

Features:

- use with primary height units, fastening hardware included
- backside of unit intended to go against wall, cabinet should be secured to wall as a safety precaution
- laminate grain direction runs horizontal on back panel of overhead cabinets
- ¼" overhang at the bottom of the door allows access
- 22¾" vertical clearance between worksurface and bottom of door, excluding task light
- two ⅝" dia. holes in upper corners of back panel for task light wiring access
- exterior back panel unfinished
- adjustable shelves

Options:

- must specify chassis grain direction on double cut veneer, see pages 11-13 for details
- veneer door fronts in paint available, specify paint color and add \$337 list; see page 14 for details
- on laminate units, contrasting laminate door fronts available, no upcharge; specify laminate color, see page 14 for details
- white glass doors with aluminum trim available, specify and add \$4,488 list for 96"w, \$4,299 list for 90"w, \$4,137 list for 84"w; see page 31 for details
- markerboard laminate doors available, specify and add \$1,144 list; see page 31 for details
- locking doors available, specify and add \$426 list (not available on glass doors)
- tackboard or markerboard available, see pages 292-295
- task lights available, see page 443

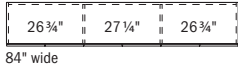
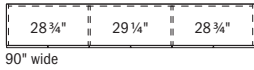
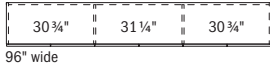

FLUX - PRIVATE OFFICE

Description	D	W	H	CTN WT	CU FT	① Model	Laminate	Flat Cut Veneer	Double Cut Veneer
Double Height Overhead Cabinet with Four Doors	15 7/8	77 7/8	52	264	45	FLT1678-52S0	\$2,294		
	15 7/8	77 7/8	52	264	45	FLV1678-52S0		\$3,758	\$4,134
	15 7/8	71 7/8	52	247	42	FLT1672-52S0	\$2,161		
	15 7/8	71 7/8	52	247	42	FLV1672-52S0		\$3,540	\$3,893
	15 7/8	65 7/8	52	235	38	FLT1666-52S0	\$2,042		
	15 7/8	65 7/8	52	235	38	FLV1666-52S0		\$3,345	\$3,679
	15 7/8	59 7/8	52	218	35	FLT1660-52S0	\$1,953		
	15 7/8	59 7/8	52	218	35	FLV1660-52S0		\$3,198	\$3,518

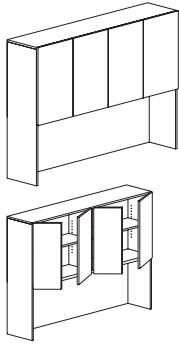

78" wide



72" wide



66" wide



60" wide

Features:

- use with primary height units, fastening hardware included
- backside of unit intended to go against wall, cabinet should be secured to wall as a safety precaution
- laminate grain direction runs horizontal on back panel of overhead cabinets
- 1/4" overhang at the bottom of the door allows access
- 22 3/4" vertical clearance between worksurface and bottom of door, excluding task light
- two 5/8" dia. holes in upper corners of back panel for task light wiring access
- exterior back panel unfinished
- adjustable shelves

Options:

- must specify chassis grain direction on double cut veneer, see pages 11-13 for details
- veneer door fronts in paint available, specify paint color and add \$337 list; see page 14 for details
- on laminate units, contrasting laminate door fronts available, no upcharge; specify laminate color, see page 14 for details
- white glass doors with aluminum trim available, specify and add \$3,437 list for 78"w, \$3,247 list for 72"w, \$3,058 list for 66"w, \$2,869 list for 60"w; see page 31 for details
- markerboard laminate doors available, specify and add \$763 list; see page 31 for details
- locking doors available, specify and add \$284 list (not available on glass doors)
- tackboard or markerboard available, see pages 292-295
- task lights available, see page 443

To Order, Specify:

① Laminate Model #	② Laminate Selection	③ Metal Color	④ Other Product Options
Laminate (FLT)	See Laminate Selection	See Metal Finish Color Options	See list of options for each specific unit; Specify and add accordingly.

① Veneer Model #	② Wood Species	③ Wood Finish	④ Metal Color	⑤ Other Product Options
Veneer (FLV)	Flat Cut CH1 Cherry MA1 Maple WA1 Walnut BO1 Black Oak	See Flat Cut Wood Finish Options	See Metal Finish Color Options	See list of options for each specific unit; Specify and add accordingly.
		③a Wood Finish See Double Cut Wood Finish Options		

Description	D	W	H	CTN WT	CU FT	① Model	Laminate	Flat Cut Veneer	Double Cut Veneer
Double Height Overhead Cabinet with Three Doors	15 ⁷ / ₈	53 ⁷ / ₈	52	200	32	FLT1654-52SOR	\$1,910		
	15 ⁷ / ₈	53 ⁷ / ₈	52	200	32	FLV1654-52SOR		\$3,077	\$3,384
	15 ⁷ / ₈	53 ⁷ / ₈	52	200	32	FLT1654-52SOL	\$1,910		
	15 ⁷ / ₈	53 ⁷ / ₈	52	200	32	FLV1654-52SOL		\$3,077	\$3,384
	15 ⁷ / ₈	47 ⁷ / ₈	52	183	28	FLT1648-52SOR	\$1,845		
	15 ⁷ / ₈	47 ⁷ / ₈	52	183	28	FLV1648-52SOR		\$2,972	\$3,268
	15 ⁷ / ₈	47 ⁷ / ₈	52	183	28	FLT1648-52SOL	\$1,845		
	15 ⁷ / ₈	47 ⁷ / ₈	52	183	28	FLV1648-52SOL		\$2,972	\$3,268
	15 ⁷ / ₈	41 ⁷ / ₈	52	165	25	FLT1642-52SOR	\$1,785		
	15 ⁷ / ₈	41 ⁷ / ₈	52	165	25	FLV1642-52SOR		\$2,875	\$3,163
	15 ⁷ / ₈	41 ⁷ / ₈	52	165	25	FLT1642-52SOL	\$1,785		
	15 ⁷ / ₈	41 ⁷ / ₈	52	165	25	FLV1642-52SOL		\$2,875	\$3,163

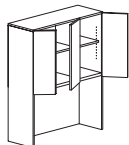
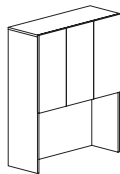

right shown



54" wide

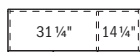

48" wide

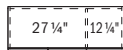

42" wide

Features:

- use with primary height units, fastening hardware included
- backside of unit intended to go against wall, cabinet should be secured to wall as a safety precaution
- laminate grain direction runs horizontal on back panel of overhead cabinets
- 1/4" overhang at the bottom of the door allows access
- 22³/₄" vertical clearance between worksurface and bottom of door, excluding task light
- two 5/8" dia. holes in upper corners of back panel for task light wiring access
- exterior back panel unfinished
- adjustable shelves

Options:

- must specify chassis grain direction on double cut veneer, see pages 11-13 for details
- veneer door fronts in paint available, specify paint color and add \$337 list; see page 14 for details
- on laminate units, contrasting laminate door fronts available, no upcharge; specify laminate color, see page 14 for details
- white glass doors with aluminum trim available, specify and add \$2,436 list for 54"w, \$2,246 list for 48"w, \$2,058 list for 42"w; see page 31 for details
- markerboard laminate doors available, specify and add \$560 list; see page 31 for details
- locking doors available, specify and add \$284 list (not available on glass doors)
- tackboard or markerboard available, see pages 292-295
- task lights available, see page 443

Description	D	W	H	CTN WT	CU FT	① Model	Laminate	Flat Cut Veneer	Double Cut Veneer
Double Height Overhead Cabinet with Two Doors	15 7/8	35 7/8	52	137	22	FLT1636-52S0	\$1,694		
	15 7/8	35 7/8	52	137	22	FLV1636-52S0		\$2,726	\$3,000
	15 7/8	29 7/8	52	120	18	FLT1630-52S0	\$1,622		
	15 7/8	29 7/8	52	120	18	FLV1630-52S0		\$2,612	\$2,874

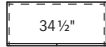
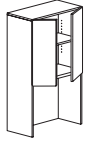
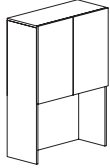

36" wide



30" wide

Features:

- use with primary height units, fastening hardware included
- backside of unit intended to go against wall, cabinet should be secured to wall as a safety precaution
- laminate grain direction runs horizontal on back panel of overhead cabinets
- 1/4" overhang at the bottom of the door allows access
- 22 3/4" vertical clearance between worksurface and bottom of door, excluding task light
- two 5/8" dia. holes in upper corners of back panel for task light wiring access
- exterior back panel unfinished
- adjustable shelf

Options:

- must specify chassis grain direction on double cut veneer, see pages 11-13 for details
- veneer door fronts in paint available, specify paint color and add \$337 list; see page 14 for details
- on laminate units, contrasting laminate door fronts available, no upcharge; specify laminate color, see page 14 for details
- white glass doors with aluminum trim available, specify and add \$1,626 list for 36"w, \$1,437 list for 30"w; see page 31 for details
- markerboard laminate doors available, specify and add \$385 list; see page 31 for details
- locking doors available, specify and add \$142 list (not available on glass doors)
- tackboard or markerboard available, see pages 292-295
- task lights available, see page 443

To Order, Specify:

① Laminate Model #	② Laminate Selection	③ Metal Color	④ Other Product Options
Laminate (FLT)	See Laminate Selection	See Metal Finish Color Options	See list of options for each specific unit; Specify and add accordingly.

① Veneer Model #	② Wood Species	③ Wood Finish	④ Metal Color	⑤ Other Product Options
Veneer (FLV)	Flat Cut CH1 Cherry MA1 Maple WA1 Walnut BO1 Black Oak	See Flat Cut Wood Finish Options	See Metal Finish Color Options	See list of options for each specific unit; Specify and add accordingly.
		3a Wood Finish See Double Cut Wood Finish Options		

Description	D	W	H	CTN WT	CU FT	Model	Laminate	Flat Cut Veneer	Double Cut Veneer
Double Height Overhead Cabinet with Four Doors and Open Center	15 7/8"	95 7/8"	52"	303	55	FLT1696-52SMO	\$2,665		
	15 7/8"	95 7/8"	52"	303	55	FLV1696-52SMO		\$4,514	\$4,965
	15 7/8"	89 7/8"	52"	287	52	FLT1690-52SMO	\$2,503		
	15 7/8"	89 7/8"	52"	287	52	FLV1690-52SMO		\$4,240	\$4,663
	15 7/8"	83 7/8"	52"	271	48	FLT1684-52SMO	\$2,341		
	15 7/8"	83 7/8"	52"	271	48	FLV1684-52SMO		\$3,960	\$4,357

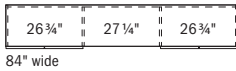
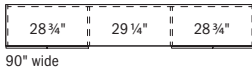
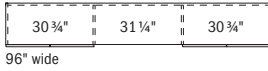
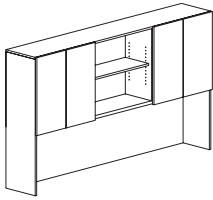

Features:

- use with primary height units, fastening hardware included
- backside of unit intended to go against wall, cabinet should be secured to wall as a safety precaution
- laminate grain direction runs horizontal on back panel of overhead cabinets
- 1/4" overhang at the bottom of the door allows access
- 22 3/4" vertical clearance between worksurface and bottom of door, excluding task light
- two 5/8" dia. holes in upper corners of back panel for task light wiring access
- exterior back panel unfinished
- adjustable shelves

Options:

- must specify chassis grain direction on double cut veneer, see pages 11-13 for details
- veneer door fronts in paint available, specify paint color and add \$337 list; see page 14 for details
- on laminate units, contrasting laminate door fronts available, no upcharge; specify laminate color, see page 14 for details
- white glass doors with aluminum trim available, specify and add \$2,995 list for 96"w, \$2,869 list for 90"w, \$2,743 list for 84"w; see page 31 for details
- markerboard laminate doors available, specify and add \$763 list; see page 31 for details
- locking doors available, specify and add \$284 list (not available on glass doors)
- tackboard or markerboard available, see pages 292-295
- task lights available, see page 443

Double Height Overhead Cabinet with Two Doors and Open Compartment	15 7/8"	77 7/8"	52"	239	45	FLT1678-52SMOR	\$2,180		
	15 7/8"	77 7/8"	52"	239	45	FLV1678-52SMOR		\$3,571	\$3,926
	15 7/8"	77 7/8"	52"	239	45	FLT1678-52SMOL	\$2,180		
	15 7/8"	77 7/8"	52"	239	45	FLV1678-52SMOL		\$3,571	\$3,926
	15 7/8"	71 7/8"	52"	224	42	FLT1672-52SMOR	\$2,055		
	15 7/8"	71 7/8"	52"	224	42	FLV1672-52SMOR		\$3,366	\$3,701
	15 7/8"	71 7/8"	52"	224	42	FLT1672-52SMOL	\$2,055		
	15 7/8"	71 7/8"	52"	224	42	FLV1672-52SMOL		\$3,366	\$3,701
	15 7/8"	65 7/8"	52"	215	38	FLT1666-52SMOR	\$1,940		
	15 7/8"	65 7/8"	52"	215	38	FLV1666-52SMOR		\$3,179	\$3,498
	15 7/8"	65 7/8"	52"	215	38	FLT1666-52SMOL	\$1,940		
	15 7/8"	65 7/8"	52"	215	38	FLV1666-52SMOL		\$3,179	\$3,498
	15 7/8"	59 7/8"	52"	199	35	FLT1660-52SMOR	\$1,855		
	15 7/8"	59 7/8"	52"	199	35	FLV1660-52SMOR		\$3,039	\$3,343
	15 7/8"	59 7/8"	52"	199	35	FLT1660-52SMOL	\$1,855		
	15 7/8"	59 7/8"	52"	199	35	FLV1660-52SMOL		\$3,039	\$3,343

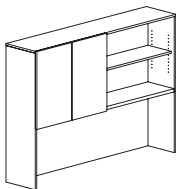

left shown

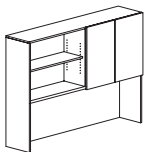

right

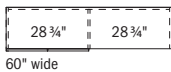
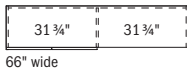
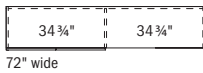
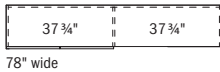

Features:

- use with primary height units, fastening hardware included
- backside of unit intended to go against wall, cabinet should be secured to wall as a safety precaution
- laminate grain direction runs horizontal on back panel of overhead cabinets
- 1/4" overhang at the bottom of the door allows access
- 22 3/4" vertical clearance between worksurface and bottom of door, excluding task light
- two 5/8" dia. holes in upper corners of back panel for task light wiring access
- exterior back panel unfinished
- adjustable shelves

Options:

- must specify chassis grain direction on double cut veneer, see pages 11-13 for details
- veneer door fronts in paint available, specify paint color and add \$337 list; see page 14 for details
- on laminate units, contrasting laminate door fronts available, no upcharge; specify laminate color, see page 14 for details
- white glass doors with aluminum trim available, specify and add \$1,720 list for 78"w, \$1,626 list for 72"w, \$1,531 list for 66"w, \$1,437 list for 60"w; see page 31 for details
- markerboard laminate doors available, specify and add \$385 list; see page 31 for details
- locking doors available, specify and add \$142 list (not available on glass doors)
- tackboard or markerboard available, see pages 292-295
- task lights available, see page 443

Description	D	W	H	CTN WT	CU FT	① Model	Laminate	Flat Cut Veneer	Double Cut Veneer
Double Height Overhead Cabinet with Two Doors and Open Center	15 7/8"	53 7/8"	52"	197	32	FLT1654-52SMO	\$1,815		
	15 7/8"	53 7/8"	52"	197	32	FLV1654-52SMO		\$2,925	\$3,216
	15 7/8"	47 7/8"	52"	181	28	FLT1648-52SMO	\$1,751		
	15 7/8"	47 7/8"	52"	181	28	FLV1648-52SMO		\$2,823	\$3,107
	15 7/8"	41 7/8"	52"	165	25	FLT1642-52SMO	\$1,698		
	15 7/8"	41 7/8"	52"	165	25	FLV1642-52SMO		\$2,733	\$3,007

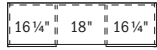
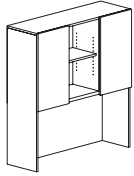

54" wide



48" wide



42" wide

Features:

- use with primary height units, fastening hardware included
- backside of unit intended to go against wall, cabinet should be secured to wall as a safety precaution
- laminate grain direction runs horizontal on back panel of overhead cabinets
- 1/4" overhang at the bottom of the door allows access
- 22 3/4" vertical clearance between worksurface and bottom of door, excluding task light
- two 5/8" dia. holes in upper corners of back panel for task light wiring access
- exterior back panel unfinished
- adjustable shelves

Options:

- must specify chassis grain direction on double cut veneer, see pages 11-13 for details
- veneer door fronts in paint available, specify paint color and add \$337 list; see page 14 for details
- on laminate units, contrasting laminate door fronts available, no upcharge; specify laminate color, see page 14 for details
- white glass doors with aluminum trim available, specify and add \$1,586 list for 54"w, \$1,462 list for 48"w, \$1,338 list for 42"w; see page 31 for details
- markerboard laminate doors available, specify and add \$385 list; see page 31 for details
- locking doors available, specify and add \$284 list (not available on glass doors)
- tackboard or markerboard available, see pages 292-295
- task lights available, see page 443

To Order, Specify:

① Laminate Model #	② Laminate Selection	③ Metal Color	④ Other Product Options
Laminate (FLT)	See Laminate Selection	See Metal Finish Color Options	See list of options for each specific unit; Specify and add accordingly.

① Veneer Model #	② Wood Species	③ Wood Finish	④ Metal Color	⑤ Other Product Options
Veneer (FLV)	Flat Cut CH1 Cherry MA1 Maple WA1 Walnut BO1 Black Oak	See Flat Cut Wood Finish Options	See Metal Finish Color Options	See list of options for each specific unit; Specify and add accordingly.
		3a Wood Finish See Double Cut Wood Finish Options		

Description	D	W	H	CTN WT	CU FT	Model	Laminate	Flat Cut Veneer	Double Cut Veneer
Double Height Storage Overhead Cabinet with Four Doors, Open Center and Cubbies	15 7/8"	95 7/8"	52"	313	55	FLT1696-52SMOCC	\$2,787		
	15 7/8"	95 7/8"	52"	313	55	FLV1696-52SMOCC		\$4,691	\$5,159
	15 7/8"	89 7/8"	52"	297	52	FLT1690-52SMOCC	\$2,627		
	15 7/8"	89 7/8"	52"	297	52	FLV1690-52SMOCC		\$4,415	\$4,858
	15 7/8"	83 7/8"	52"	280	48	FLT1684-52SMOCC	\$2,460		
	15 7/8"	83 7/8"	52"	280	48	FLV1684-52SMOCC		\$4,139	\$4,551

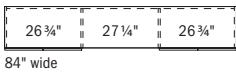
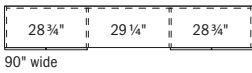
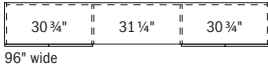
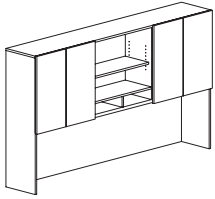

Features:

- use with primary height units, fastening hardware included
- backside of unit intended to go against wall, cabinet should be secured to wall as a safety precaution
- laminate grain direction runs horizontal on back panel of overhead cabinets
- 1/4" overhang at the bottom of the door allows access
- 22 3/4" vertical clearance between worksurface and bottom of door, excluding task light
- two 5/8" dia. holes in upper corners of back panel for task light wiring access
- exterior back panel unfinished
- adjustable shelves

Options:

- must specify chassis grain direction on double cut veneer, see pages 11-13 for details
- veneer door fronts in paint available, specify paint color and add \$337 list; see page 14 for details
- on laminate units, contrasting laminate door fronts available, no upcharge; specify laminate color, see page 14 for details
- white glass doors with aluminum trim available, specify and add \$2,995 list for 96"w, \$2,869 list for 90"w, \$2,743 list for 84"w; see page 31 for details
- markerboard laminate doors available, specify and add \$763 list; see page 31 for details
- locking doors available, specify and add \$284 list (not available on glass doors)
- tackboard or markerboard available, see pages 292-295
- task lights available, see page 443

Double Height Storage Overhead Cabinet with Two Doors, Open Center and Cubbies	15 7/8"	77 7/8"	52"	260	45	FLT1678-52SMOCC	\$2,304		
	15 7/8"	77 7/8"	52"	260	45	FLV1678-52SMOCC		\$3,747	\$4,122
	15 7/8"	71 7/8"	52"	245	42	FLT1672-52SMOCC	\$2,178		
	15 7/8"	71 7/8"	52"	245	42	FLV1672-52SMOCC		\$3,541	\$3,894
	15 7/8"	65 7/8"	52"	233	38	FLT1666-52SMOCC	\$2,064		
	15 7/8"	65 7/8"	52"	233	38	FLV1666-52SMOCC		\$3,354	\$3,692
	15 7/8"	59 7/8"	52"	221	35	FLT1660-52SMOCC	\$1,979		
	15 7/8"	59 7/8"	52"	221	35	FLV1660-52SMOCC		\$3,216	\$3,538

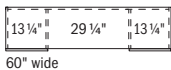
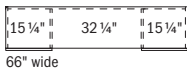
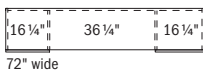
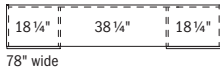
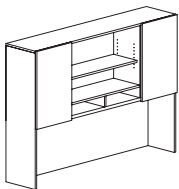

Features:

- use with primary height units, fastening hardware included
- backside of unit intended to go against wall, cabinet should be secured to wall as a safety precaution
- laminate grain direction runs horizontal on back panel of overhead cabinets
- 1/4" overhang at the bottom of the door allows access
- 22 3/4" vertical clearance between worksurface and bottom of door, excluding task light
- two 5/8" dia. holes in upper corners of back panel for task light wiring access
- exterior back panel unfinished
- adjustable shelves

Options:

- must specify chassis grain direction on double cut veneer, see pages 11-13 for details
- veneer door fronts in paint available, specify paint color and add \$337 list; see page 14 for details
- on laminate units, contrasting laminate door fronts available, no upcharge; specify laminate color, see page 14 for details
- white glass doors with aluminum trim available, specify and add \$1,720 list for 78"w, \$1,626 list for 72"w, \$1,531 list for 66"w, \$1,437 list for 60"w; see page 31 for details
- markerboard laminate doors available, specify and add \$385 list; see page 31 for details
- locking doors available, specify and add \$284 list (not available on glass doors)
- tackboard or markerboard available, see pages 292-295
- task lights available, see page 443

Description	D	W	H	CTN WT	CU FT	① Model	Laminate	Flat Cut Veneer	Double Cut Veneer
Double Height Overhead Cabinet with Two Doors, Open Center and Cubby	15 7/8"	53 7/8"	52"	202	32	FLT1654-52SMOCC	\$1,938		
	15 7/8"	53 7/8"	52"	202	32	FLV1654-52SMOCC		\$3,099	\$3,412
	15 7/8"	47 7/8"	52"	186	28	FLT1648-52SMOCC	\$1,874		
	15 7/8"	47 7/8"	52"	186	28	FLV1648-52SMOCC		\$3,002	\$3,302
	15 7/8"	41 7/8"	52"	169	25	FLT1642-52SMOCC	\$1,820		
	15 7/8"	41 7/8"	52"	169	25	FLV1642-52SMOCC		\$2,910	\$3,202

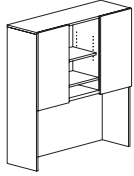

54" wide



48" wide



42" wide

Features:

- use with primary height units, fastening hardware included
- backside of unit intended to go against wall, cabinet should be secured to wall as a safety precaution
- laminate grain direction runs horizontal on back panel of overhead cabinets
- 1/4" overhang at the bottom of the door allows access
- 22 3/4" vertical clearance between worksurface and bottom of door, excluding task light
- two 5/8" dia. holes in upper corners of back panel for task light wiring access
- exterior back panel unfinished
- adjustable shelves

Options:

- must specify chassis grain direction on double cut veneer, see pages 11-13 for details
- veneer door fronts in paint available, specify paint color and add \$337 list; see page 14 for details
- on laminate units, contrasting laminate door fronts available, no upcharge; specify laminate color, see page 14 for details
- white glass doors with aluminum trim available, specify and add \$1,586 list for 54"w, \$1,462 list for 48"w, \$1,338 list for 42"w; see page 31 for details
- markerboard laminate doors available, specify and add \$385 list; see page 31 for details
- locking doors available, specify and add \$284 list (not available on glass doors)
- tackboard or markerboard available, see pages 292-295
- task lights available, see page 443

To Order, Specify:

① Laminate Model #	② Laminate Selection	③ Metal Color	④ Other Product Options
Laminate (FLT)	See Laminate Selection	See Metal Finish Color Options	See list of options for each specific unit; Specify and add accordingly.

① Veneer Model #	② Wood Species	③ Wood Finish	④ Metal Color	⑤ Other Product Options
Veneer (FLV)	Flat Cut CH1 Cherry MA1 Maple WA1 Walnut BO1 Black Oak	See Flat Cut Wood Finish Options	See Metal Finish Color Options	See list of options for each specific unit; Specify and add accordingly.
		3a Wood Finish See Double Cut Wood Finish Options		

Description	D	W	H	CTN WT	CU FT	① Model	Laminate	Flat Cut Veneer	Double Cut Veneer
Double Height Storage Overhead Cabinet with Sliding Doors	15 15/16	95 7/8	52	311	55	FLT1696-52SD	\$3,151		
	15 15/16	95 7/8	52	311	55	FLV1696-52SD		\$5,163	\$5,680
	15 15/16	89 13/16	52	295	52	FLT1690-52SD	\$2,920		
	15 15/16	89 13/16	52	295	52	FLV1690-52SD		\$4,785	\$5,264
	15 15/16	83 7/8	52	279	49	FLT1684-52SD	\$2,688		
	15 15/16	83 7/8	52	279	49	FLV1684-52SD		\$4,404	\$4,845

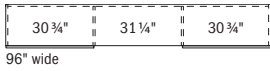
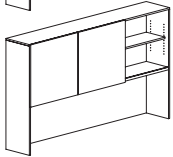
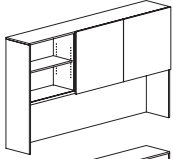
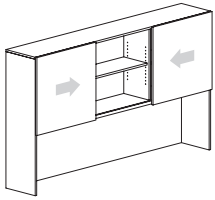

96" wide

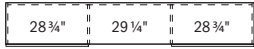

90" wide

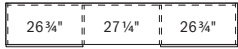

84" wide

Features:

- use with primary height units, fastening hardware included
- backside of unit intended to go against wall, cabinet should be secured to wall as a safety precaution
- laminate grain direction runs horizontal on back panel of overhead cabinets
- 22 3/4" vertical clearance between worksurface and bottom of door, excluding task light
- two 5/8" dia. holes in upper corners of back panel for task light wiring access
- exterior back panel unfinished
- locking not available
- adjustable shelves

Options:

- must specify chassis grain direction on double cut veneer, see pages 11-13 for details
- veneer door fronts in paint available, specify paint color and add \$337 list; see page 14 for details
- on laminate units, contrasting laminate door fronts available, no upcharge; specify laminate color, see page 14 for details
- white glass doors with aluminum trim available, specify and add \$2,626 list for 96"w, \$2,498 list for 90"w, \$2,372 list for 84"w; see page 31 for details
- markerboard laminate doors available, specify and add \$569 list; see page 31 for details
- tackboard or markerboard available, see pages 292-295
- task lights available, see page 443

Double Height Storage Overhead Cabinet with Sliding Door	15 15/16	77 7/8	52	245	45	FLT1678-52SD	\$2,591		
	15 15/16	77 7/8	52	245	45	FLV1678-52SD		\$4,107	\$4,518
	15 15/16	71 7/8	52	224	42	FLT1672-52SD	\$2,444		
	15 15/16	71 7/8	52	224	42	FLV1672-52SD		\$3,876	\$4,263
	15 15/16	65 7/8	52	214	39	FLT1666-52SD	\$2,312		
	15 15/16	65 7/8	52	214	39	FLV1666-52SD		\$3,666	\$4,033
	15 15/16	59 7/8	52	193	35	FLT1660-52SD	\$2,212		
	15 15/16	59 7/8	52	193	35	FLV1660-52SD		\$3,510	\$3,861

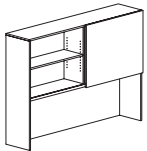
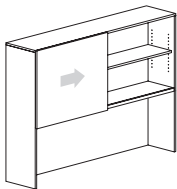

78" wide



72" wide



66" wide

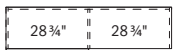

60" wide

Features:

- use with primary height units, fastening hardware included
- backside of unit intended to go against wall, cabinet should be secured to wall as a safety precaution
- laminate grain direction runs horizontal on back panel of overhead cabinets
- 22 3/4" vertical clearance between worksurface and bottom of door, excluding task light
- two 5/8" dia. holes in upper corners of back panel for task light wiring access
- exterior back panel unfinished
- locking not available
- adjustable shelves

Options:

- must specify chassis grain direction on double cut veneer, see pages 11-13 for details
- veneer door fronts in paint available, specify paint color and add \$337 list; see page 14 for details
- on laminate units, contrasting laminate door fronts available, no upcharge; specify laminate color, see page 14 for details
- white glass doors with aluminum trim available, specify and add \$1,535 list for 78"w, \$1,441 list for 72"w, \$1,346 list for 66"w, \$1,251 list for 60"w; see page 31 for details
- markerboard laminate doors available, specify and add \$286 list; see page 31 for details
- tackboard or markerboard available, see pages 292-295
- task lights available, see page 443

Description	D	W	H	CTN WT	CU FT	① Model	Laminate	Flat Cut Veneer	Double Cut Veneer
Double Height Storage Overhead Cabinet with Sliding Door	15 15/16	53 7/8	52	183	32	FLT1654-52SD	\$2,165		
	15 15/16	53 7/8	52	183	32	FLV1654-52SD		\$3,378	\$3,716
	15 15/16	47 7/8	52	167	28	FLT1648-52SD	\$2,094		
	15 15/16	47 7/8	52	167	28	FLV1648-52SD		\$3,266	\$3,592
	15 15/16	41 7/8	52	152	25	FLT1642-52SD	\$2,030		
	15 15/16	41 7/8	52	152	25	FLV1642-52SD		\$3,165	\$3,482

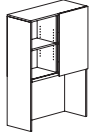
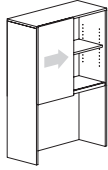

54" wide



48" wide

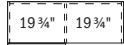

42" wide

Features:

- use with primary height units, fastening hardware included
- backside of unit intended to go against wall, cabinet should be secured to wall as a safety precaution
- laminate grain direction runs horizontal on back panel of overhead cabinets
- 22 3/4" vertical clearance between worksurface and bottom of door, excluding task light
- two 5/8" dia. holes in upper corners of back panel for task light wiring access
- exterior back panel unfinished
- locking not available
- adjustable shelves

Options:

- must specify chassis grain direction on double cut veneer, see pages 11-13 for details
- veneer door fronts in paint available, specify paint color and add \$337 list; see page 14 for details
- on laminate units, contrasting laminate door fronts available, no upcharge; specify laminate color, see page 14 for details
- white glass doors with aluminum trim available, specify and add \$1,156 list for 54"w, \$1,062 list for 48"w, \$968 list for 42"w; see page 31 for details
- markerboard laminate doors available, specify and add \$286 list; see page 31 for details
- tackboard or markerboard available, see pages 292-295
- task lights available, see page 443

Double Height Storage Overhead Cabinet with Sliding Door	15 15/16	35 7/8	52	136	22	FLT1636-52SD	\$1,925		
	15 15/16	35 7/8	52	136	22	FLV1636-52SD		\$3,004	\$3,304
	15 15/16	29 7/8	52	121	18	FLT1630-52SD	\$1,848		
	15 15/16	29 7/8	52	121	18	FLV1630-52SD		\$2,882	\$3,172

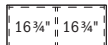
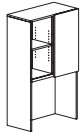
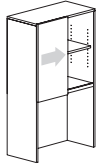

36" wide



30" wide

Features:

- use with primary height units, fastening hardware included
- backside of unit intended to go against wall, cabinet should be secured to wall as a safety precaution
- laminate grain direction runs horizontal on back panel of overhead cabinets
- 22 3/4" vertical clearance between worksurface and bottom of door, excluding task light
- two 5/8" dia. holes in upper corners of back panel for task light wiring access
- exterior back panel unfinished
- locking not available
- adjustable shelves

Options:

- must specify chassis grain direction on double cut veneer, see pages 11-13 for details
- veneer door fronts in paint available, specify paint color and add \$337 list; see page 14 for details
- on laminate units, contrasting laminate door fronts available, no upcharge; specify laminate color, see page 14 for details
- white glass doors with aluminum trim available, specify and add \$872 list for 36"w, \$778 list for 30"w; see page 31 for details
- markerboard laminate doors available, specify and add \$286 list; see page 31 for details
- tackboard or markerboard available, see pages 292-295
- task lights available, see page 443

To Order, Specify:

① Laminate Model #	② Laminate Selection	③ Metal Color	④ Other Product Options
Laminate (FLT)	See Laminate Selection	See Metal Finish Color Options	See list of options for each specific unit; Specify and add accordingly.

① Veneer Model #	② Wood Species	③ Wood Finish	④ Metal Color	⑤ Other Product Options
Veneer (FLV)	Flat Cut CH1 Cherry MA1 Maple WA1 Walnut BO1 Black Oak	See Flat Cut Wood Finish Options	See Metal Finish Color Options	See list of options for each specific unit; Specify and add accordingly.
		<table border="1"> <thead> <tr> <th>ⓐ Wood Finish</th> <th>ⓑ Chassis Grain Direction</th> </tr> </thead> <tbody> <tr> <td>See Double Cut Wood Finish Options</td> <td>For Double Cut Only: Vertical Horizontal</td> </tr> </tbody> </table>		
ⓐ Wood Finish	ⓑ Chassis Grain Direction			
See Double Cut Wood Finish Options	For Double Cut Only: Vertical Horizontal			
Double Cut DC1 Double Cut				

Description	D	W	H	CTN WT	CU FT	① Model	Laminate	Flat Cut Veneer	Double Cut Veneer
Double Height Open Storage Overhead Cabinet	15	95 $\frac{7}{8}$ "	52	257	52	FLT1596-5200	\$2,440		
	15	95 $\frac{7}{8}$ "	52	257	52	FLV1596-5200		\$4,134	\$4,547
	15	89 $\frac{13}{16}$ "	52	244	49	FLT1590-5200	\$2,292		
	15	89 $\frac{13}{16}$ "	52	244	49	FLV1590-5200		\$3,883	\$4,272
	15	83 $\frac{7}{8}$ "	52	231	46	FLT1584-5200	\$2,144		
	15	83 $\frac{7}{8}$ "	52	231	46	FLV1584-5200		\$3,627	\$3,989

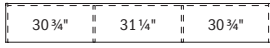
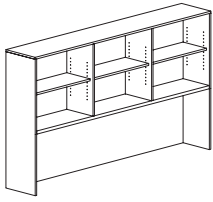

96" wide



90" wide

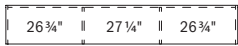

84" wide

Features:

- use with primary height units, fastening hardware included
- laminate grain direction runs horizontal on back panel of overhead cabinets
- backside of unit intended to go against wall, cabinet should be secured to wall as a safety precaution
- 23" vertical clearance between worksurface and bottom of cabinet, excluding task light
- two $\frac{5}{8}$ " dia. holes in upper corners of back panel for task light wiring access
- exterior back panel unfinished
- adjustable shelves

Options:

- must specify chassis grain direction on double cut veneer, see pages 11-13 for details
- tackboard or markerboard available, see pages 292-295
- task lights available, see page 443

Double Height Open Storage Overhead Cabinet	15	77 $\frac{7}{8}$ "	52	210	43	FLT1578-5200	\$1,998		
	15	77 $\frac{7}{8}$ "	52	210	43	FLV1578-5200		\$3,270	\$3,597
	15	71 $\frac{7}{8}$ "	52	197	40	FLT1572-5200	\$1,882		
	15	71 $\frac{7}{8}$ "	52	197	40	FLV1572-5200		\$3,082	\$3,389
	15	65 $\frac{7}{8}$ "	52	189	37	FLT1566-5200	\$1,779		
	15	65 $\frac{7}{8}$ "	52	189	37	FLV1566-5200		\$2,910	\$3,202
	15	59 $\frac{7}{8}$ "	52	175	33	FLT1560-5200	\$1,700		
	15	59 $\frac{7}{8}$ "	52	175	33	FLV1560-5200		\$2,784	\$3,063

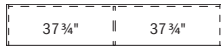
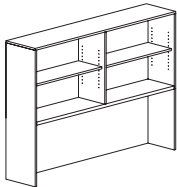

78" wide



72" wide

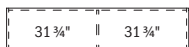

66" wide

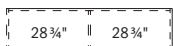

60" wide

Features:

- use with primary height units, fastening hardware included
- laminate grain direction runs horizontal on back panel of overhead cabinets
- backside of unit intended to go against wall, cabinet should be secured to wall as a safety precaution
- 23" vertical clearance between worksurface and bottom of cabinet, excluding task light
- two $\frac{5}{8}$ " dia. holes in upper corners of back panel for task light wiring access
- exterior back panel unfinished
- adjustable shelves

Options:

- must specify chassis grain direction on double cut veneer, see pages 11-13 for details
- tackboard or markerboard available, see pages 292-295
- task lights available, see page 443

FLUX - PRIVATE OFFICE

Description	D	W	H	CTN WT	CU FT	① Model	Laminate	Flat Cut Veneer	Double Cut Veneer
Double Height Open Storage Overhead Cabinet	15	53 7/8	52	162	30	FLT1554-5200	\$1,663		
	15	53 7/8	52	162	30	FLV1554-5200		\$2,678	\$2,945
	15	47 7/8	52	148	27	FLT1548-5200	\$1,604		
	15	47 7/8	52	148	27	FLV1548-5200		\$2,585	\$2,844
	15	41 7/8	52	134	24	FLT1542-5200	\$1,555		
	15	41 7/8	52	134	24	FLV1542-5200		\$2,501	\$2,754

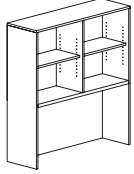

54" wide



48" wide

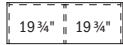

42" wide

Features:

- use with primary height units, fastening hardware included
- laminate grain direction runs horizontal on back panel of overhead cabinets
- backside of unit intended to go against wall, cabinet should be secured to wall as a safety precaution
- 23" vertical clearance between worksurface and bottom of cabinet, excluding task light
- two 5/8" dia. holes in upper corners of back panel for task light wiring access
- exterior back panel unfinished
- adjustable shelves

Options:

- must specify chassis grain direction on double cut veneer, see pages 11-13 for details
- tackboard or markerboard available, see pages 292-295
- task lights available, see page 443

Double Height Open Storage Overhead Cabinet	15	35 7/8	52	110	21	FLT1536-5200	\$1,474		
	15	35 7/8	52	110	21	FLV1536-5200		\$2,372	\$2,610
	15	29 7/8	52	97	17	FLT1530-5200	\$1,412		
	15	29 7/8	52	97	17	FLV1530-5200		\$2,273	\$2,500

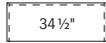
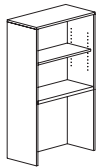

36" wide



30" wide

Features:

- use with primary height units, fastening hardware included
- laminate grain direction runs horizontal on back panel of overhead cabinets
- backside of unit intended to go against wall, cabinet should be secured to wall as a safety precaution
- 23" vertical clearance between worksurface and bottom of cabinet, excluding task light
- two 5/8" dia. holes in upper corners of back panel for task light wiring access
- exterior back panel unfinished
- adjustable shelves

Options:

- must specify chassis grain direction on double cut veneer, see pages 11-13 for details
- tackboard or markerboard available, see pages 292-295
- task lights available, see page 443

To Order, Specify:

① Laminate Model #	② Laminate Selection	③ Metal Color	④ Other Product Options
Laminate (FLT)	See Laminate Selection	See Metal Finish Color Options	See list of options for each specific unit; Specify and add accordingly.

① Veneer Model #	② Wood Species	③ Wood Finish	④ Metal Color	⑤ Other Product Options
Veneer (FLV)	Flat Cut CH1 Cherry MA1 Maple WA1 Walnut BO1 Black Oak	See Flat Cut Wood Finish Options	See Metal Finish Color Options	See list of options for each specific unit; Specify and add accordingly.
		③a Wood Finish See Double Cut Wood Finish Options		

Description	D	W	H	CTN WT	CU FT	① Model	Laminate	Flat Cut Veneer	Double Cut Veneer
Storage Overhead Cabinet with Four Doors	15 $\frac{7}{8}$ "	95 $\frac{7}{8}$ "	40"	232	43	FLT1696-40S0	\$2,243		
	15 $\frac{7}{8}$ "	95 $\frac{7}{8}$ "	40"	232	43	FLV1696-40S0		\$3,801	\$4,180
	15 $\frac{7}{8}$ "	89 $\frac{7}{8}$ "	40"	220	40	FLT1690-40S0	\$2,108		
	15 $\frac{7}{8}$ "	89 $\frac{7}{8}$ "	40"	220	40	FLV1690-40S0		\$3,571	\$3,926
	15 $\frac{7}{8}$ "	83 $\frac{7}{8}$ "	40"	208	38	FLT1684-40S0	\$1,971		
	15 $\frac{7}{8}$ "	83 $\frac{7}{8}$ "	40"	208	38	FLV1684-40S0		\$3,334	\$3,667

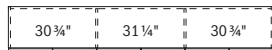
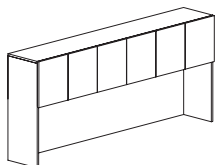

96" wide



90" wide

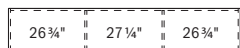

84" wide

Features:

- use with primary height units, fastening hardware included
- laminate grain direction runs horizontal on back panel of overhead cabinets
- 1/4" overhang at the bottom of the door allows access
- 22 3/4" vertical clearance between worksurface and bottom of door, excluding task light
- two 5/8" dia. holes in upper corners of back panel for task light wiring access
- exterior back panel unfinished

Options:

- must specify chassis grain direction on double cut veneer, see pages 11-13 for details
- veneer door fronts in paint available, specify paint color and add \$337 list; see page 14 for details
- on laminate units, contrasting laminate door fronts available, no upcharge; specify laminate color, see page 14 for details
- white glass doors with aluminum trim available, specify and add \$3,348 list; see page 31 for details
- markerboard laminate doors available, specify and add \$1,116 list; see page 31 for details
- locking doors available, specify and add \$426 list (not available on glass doors)
- tackboard or markerboard available, see pages 292-295
- task lights available, see page 443

Description	D	W	H	CTN WT	CU FT	① Model	Laminate	Flat Cut Veneer	Double Cut Veneer
Storage Overhead Cabinet with Four Doors	15 7/8"	77 7/8"	40"	192	35	FLT1678-40S0	\$1,834		
	15 7/8"	77 7/8"	40"	192	35	FLV1678-40S0		\$3,007	\$3,308
	15 7/8"	71 7/8"	40"	178	33	FLT1672-40S0	\$1,732		
	15 7/8"	71 7/8"	40"	178	33	FLV1672-40S0		\$2,832	\$3,116
	15 7/8"	65 7/8"	40"	172	30	FLT1666-40S0	\$1,633		
	15 7/8"	65 7/8"	40"	172	30	FLV1666-40S0		\$2,677	\$2,943
	15 7/8"	59 7/8"	40"	160	27	FLT1660-40S0	\$1,562		
	15 7/8"	59 7/8"	40"	160	27	FLV1660-40S0		\$2,560	\$2,815

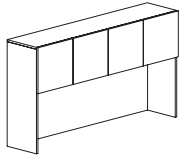

78" wide



72" wide



66" wide



60" wide

Features:

- use with primary height units, fastening hardware included
- laminate grain direction runs horizontal on back panel of overhead cabinets
- 1/4" overhang at the bottom of the door allows access
- 22 3/4" vertical clearance between worksurface and bottom of door, excluding task light
- two 5/8" dia. holes in upper corners of back panel for task light wiring access
- exterior back panel unfinished

Options:

- must specify chassis grain direction on double cut veneer, see pages 11-13 for details
- veneer door fronts in paint available, specify paint color and add \$337 list; see page 14 for details
- on laminate units, contrasting laminate door fronts available, no upcharge; specify laminate color, see page 14 for details
- white glass doors with aluminum trim available, specify and add \$2,433 list for 78"w, \$2,321 list for 72"w, \$2,234 list for 66"w or 60"w; see page 31 for details
- markerboard laminate doors available, specify and add \$744 list; see page 31 for details
- locking doors available, specify and add \$284 list (not available on glass doors)
- tackboard or markerboard available, see pages 292-295
- task lights available, see page 443

To Order, Specify:

① Laminate Model #	② Laminate Selection	③ Metal Color	④ Other Product Options
Laminate (FLT)	See Laminate Selection	See Metal Finish Color Options	See list of options for each specific unit; Specify and add accordingly.

① Veneer Model #	② Wood Species	③ Wood Finish	④ Metal Color	⑤ Other Product Options
Veneer (FLV)	Flat Cut CH1 Cherry MA1 Maple WA1 Walnut BO1 Black Oak	See Flat Cut Wood Finish Options	See Metal Finish Color Options	See list of options for each specific unit; Specify and add accordingly.
		3a Wood Finish See Double Cut Wood Finish Options		

Description	D	W	H	CTN WT	CU FT	① Model	Laminate	Flat Cut Veneer	Double Cut Veneer
Storage Overhead Cabinet with Three Doors	15 $\frac{7}{8}$ "	53 $\frac{7}{8}$ "	40"	147	25	FLT1654-40SOR	\$1,528		
	15 $\frac{7}{8}$ "	53 $\frac{7}{8}$ "	40"	147	25	FLV1654-40SOR		\$2,459	\$2,706
	15 $\frac{7}{8}$ "	53 $\frac{7}{8}$ "	40"	147	25	FLT1654-40SOL	\$1,528		
	15 $\frac{7}{8}$ "	53 $\frac{7}{8}$ "	40"	147	25	FLV1654-40SOL		\$2,459	\$2,706
	15 $\frac{7}{8}$ "	47 $\frac{7}{8}$ "	40"	134	22	FLT1648-40SOR	\$1,476		
	15 $\frac{7}{8}$ "	47 $\frac{7}{8}$ "	40"	134	22	FLV1648-40SOR		\$2,376	\$2,614
	15 $\frac{7}{8}$ "	47 $\frac{7}{8}$ "	40"	134	22	FLT1648-40SOL	\$1,476		
	15 $\frac{7}{8}$ "	47 $\frac{7}{8}$ "	40"	134	22	FLV1648-40SOL		\$2,376	\$2,614
	15 $\frac{7}{8}$ "	41 $\frac{7}{8}$ "	40"	122	20	FLT1642-40SOR	\$1,430		
	15 $\frac{7}{8}$ "	41 $\frac{7}{8}$ "	40"	122	20	FLV1642-40SOR		\$2,303	\$2,531
	15 $\frac{7}{8}$ "	41 $\frac{7}{8}$ "	40"	122	20	FLT1642-40SOL	\$1,430		
	15 $\frac{7}{8}$ "	41 $\frac{7}{8}$ "	40"	122	20	FLV1642-40SOL		\$2,303	\$2,531

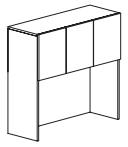

right shown

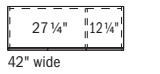
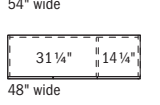
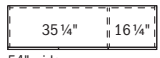

Features:

- use with primary height units, fastening hardware included
- laminate grain direction runs horizontal on back panel of overhead cabinets
- 1/4" overhang at the bottom of the door allows access
- 22 3/4" vertical clearance between worksurface and bottom of door, excluding task light
- two 5/8" dia. holes in upper corners of back panel for task light wiring access
- exterior back panel unfinished

Options:

- must specify chassis grain direction on double cut veneer, see pages 11-13 for details
- veneer door fronts in paint available, specify paint color and add \$337 list; see page 14 for details
- on laminate units, contrasting laminate door fronts available, no upcharge; specify laminate color, see page 14 for details
- white glass doors with aluminum trim available, specify and add \$1,742 list for 54"w, \$1,675 list for 48"w or 42"w; see page 31 for details
- markerboard laminate doors available, specify and add \$560 list; see page 31 for details
- locking doors available, specify and add \$284 list (not available on glass doors)
- tackboard or markerboard available, see pages 292-295
- task lights available, see page 443

FLUX - PRIVATE OFFICE

Description	D	W	H	CTN WT	CU FT	① Model	Laminate	Flat Cut Veneer	Double Cut Veneer
Storage Overhead Cabinet with Two Doors	15 7/8	35 7/8	40	102	17	FLT1636-40SO	\$1,357		
	15 7/8	35 7/8	40	102	17	FLV1636-40SO		\$2,181	\$2,399
	15 7/8	29 7/8	40	90	14	FLT1630-40SO	\$1,299		
	15 7/8	29 7/8	40	90	14	FLV1630-40SO		\$2,089	\$2,301

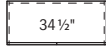
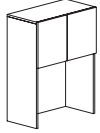

36" wide



30" wide

Features:

- use with primary height units, fastening hardware included
- laminate grain direction runs horizontal on back panel of overhead cabinets
- 1/4" overhang at the bottom of the door allows access
- 22 3/4" vertical clearance between worksurface and bottom of door, excluding task light
- two 5/8" dia. holes in upper corners of back panel for task light wiring access
- exterior back panel unfinished

Options:

- must specify chassis grain direction on double cut veneer, see pages 11-13 for details
- veneer door fronts in paint available, specify paint color and add \$337 list; see page 14 for details
- on laminate units, contrasting laminate door fronts available, no upcharge; specify laminate color, see page 14 for details
- white glass doors with aluminum trim available, specify and add \$1,163 list for 36"w, \$1,119 list for 30"w; see page 31 for details
- markerboard laminate doors available, specify and add \$375 list; see page 31 for details
- locking doors available, specify and add \$142 list (not available on glass doors)
- tackboard or markerboard available, see pages 292-295
- task lights available, see page 443

To Order, Specify:

① Laminate Model #	② Laminate Selection	③ Metal Color	④ Other Product Options
Laminate (FLT)	See Laminate Selection	See Metal Finish Color Options	See list of options for each specific unit; Specify and add accordingly.

① Veneer Model #	② Wood Species	③ Wood Finish	④ Metal Color	⑤ Other Product Options
Veneer (FLV)	Flat Cut CH1 Cherry MA1 Maple WA1 Walnut BO1 Black Oak	See Flat Cut Wood Finish Options	See Metal Finish Color Options	See list of options for each specific unit; Specify and add accordingly.
		3a Wood Finish See Double Cut Wood Finish Options		

Description	D	W	H	CTN WT	CU FT	① Model	Laminate	Flat Cut Veneer	Double Cut Veneer
Storage Overhead Cabinet with Four Doors and Open Center	15 7/8"	95 7/8"	40"	221	43	FLT1696-40SMO	\$2,130		
	15 7/8"	95 7/8"	40"	221	43	FLV1696-40SMO		\$3,606	\$3,966
	15 7/8"	89 7/8"	40"	209	40	FLT1690-40SMO	\$1,972		
	15 7/8"	89 7/8"	40"	209	40	FLV1690-40SMO		\$3,337	\$3,670
	15 7/8"	83 7/8"	40"	198	38	FLT1684-40SMO	\$1,812		
	15 7/8"	83 7/8"	40"	198	38	FLV1684-40SMO		\$3,065	\$3,372

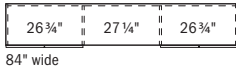
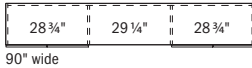
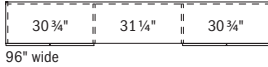
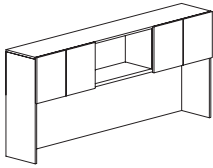

Features:

- use with primary height units, fastening hardware included
- laminate grain direction runs horizontal on back panel of overhead cabinets
- 1/4" overhang at the bottom of the door allows access
- 22 3/4" vertical clearance between worksurface and bottom of door, excluding task light
- two 5/8" dia. holes in upper corners of back panel for task light wiring access
- exterior back panel unfinished

Options:

- must specify chassis grain direction on double cut veneer, see pages 11-13 for details
- veneer door fronts in paint available, specify paint color and add \$337 list; see page 14 for details
- on laminate units, contrasting laminate door fronts available, no upcharge; specify laminate color, see page 14 for details
- white glass doors with aluminum trim available, specify and add \$2,234 list; see page 31 for details
- markerboard laminate doors available, specify and add \$744 list; see page 31 for details
- locking doors available, specify and add \$284 list (not available on glass doors)
- tackboard or markerboard available, see pages 292-295
- task lights available, see page 443

Storage Overhead Cabinet with Two Doors and open compartment	15 7/8"	77 7/8"	40"	180	35	FLT1678-40SMOR	\$1,744		
	15 7/8"	77 7/8"	40"	180	35	FLV1678-40SMOR		\$2,857	\$3,140
	15 7/8"	77 7/8"	40"	180	35	FLT1678-40SMOL	\$1,744		
	15 7/8"	77 7/8"	40"	180	35	FLV1678-40SMOL		\$2,857	\$3,140
	15 7/8"	71 7/8"	40"	169	33	FLT1672-40SMOR	\$1,643		
	15 7/8"	71 7/8"	40"	169	33	FLV1672-40SMOR		\$2,691	\$2,961
	15 7/8"	71 7/8"	40"	169	33	FLT1672-40SMOL	\$1,643		
	15 7/8"	71 7/8"	40"	169	33	FLV1672-40SMOL		\$2,691	\$2,961
	15 7/8"	65 7/8"	40"	163	30	FLT1666-40SMOR	\$1,555		
	15 7/8"	65 7/8"	40"	163	30	FLV1666-40SMOR		\$2,544	\$2,799
	15 7/8"	65 7/8"	40"	163	30	FLT1666-40SMOL	\$1,555		
	15 7/8"	65 7/8"	40"	163	30	FLV1666-40SMOL		\$2,544	\$2,799
	15 7/8"	59 7/8"	40"	152	27	FLT1660-40SMOR	\$1,485		
	15 7/8"	59 7/8"	40"	152	27	FLV1660-40SMOR		\$2,431	\$2,676
	15 7/8"	59 7/8"	40"	152	27	FLT1660-40SMOL	\$1,485		
	15 7/8"	59 7/8"	40"	152	27	FLV1660-40SMOL		\$2,431	\$2,676

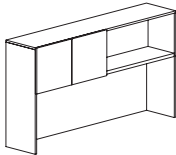

left shown

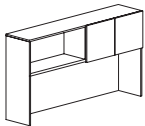

right

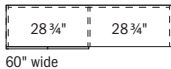
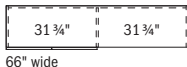
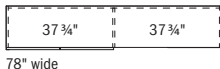

Features:

- use with primary height units, fastening hardware included
- laminate grain direction runs horizontal on back panel of overhead cabinets
- 1/4" overhang at the bottom of the door allows access
- 22 3/4" vertical clearance between worksurface and bottom of door, excluding task light
- two 5/8" dia. holes in upper corners of back panel for task light wiring access
- exterior back panel unfinished

Options:

- must specify chassis grain direction on double cut veneer, see pages 11-13 for details
- veneer door fronts in paint available, specify paint color and add \$337 list; see page 14 for details
- on laminate units, contrasting laminate door fronts available, no upcharge; specify laminate color, see page 14 for details
- white glass doors with aluminum trim available, specify and add \$1,218 list for 78"w, \$1,163 list for 72"w, \$1,119 list for 66"w or 60"w; see page 31 for details
- markerboard laminate doors available, specify and add \$375 list; see page 31 for details
- locking doors available, specify and add \$142 list (not available on glass doors)
- tackboard or markerboard available, see pages 292-295
- task lights available, see page 443

Description	D	W	H	CTN WT	CU FT	① Model	Laminate	Flat Cut Veneer	Double Cut Veneer
Storage Overhead Cabinet with Two Doors with Open Center	15 7/8	53 7/8	40	145	25	FLT1654-40SMO	\$1,452		
	15 7/8	53 7/8	40	145	25	FLV1654-40SMO		\$2,341	\$2,573
	15 7/8	47 7/8	40	133	22	FLT1648-40SMO	\$1,405		
	15 7/8	47 7/8	40	133	22	FLV1648-40SMO		\$2,260	\$2,487
	15 7/8	41 7/8	40	121	20	FLT1642-40SMO	\$1,359		
	15 7/8	41 7/8	40	121	20	FLV1642-40SMO		\$2,187	\$2,405

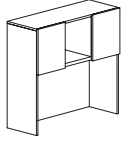

54" wide



48" wide



42" wide

Features:

- use with primary height units, fastening hardware included
- laminate grain direction runs horizontal on back panel of overhead cabinets
- 1/4" overhang at the bottom of the door allows access
- 22 3/4" vertical clearance between worksurface and bottom of door, excluding task light
- two 5/8" dia. holes in upper corners of back panel for task light wiring access
- exterior back panel unfinished

Options:

- must specify chassis grain direction on double cut veneer, see pages 11-13 for details
- veneer door fronts in paint available, specify paint color and add \$337 list; see page 14 for details
- on laminate units, contrasting laminate door fronts available, no upcharge; specify laminate color, see page 14 for details
- white glass doors with aluminum trim available, specify and add \$1,134 list for 54"w, \$1,091 list for 48"w or 42"w; see page 31 for details
- markerboard laminate doors available, specify and add \$375 list; see page 31 for details
- locking doors available, specify and add \$284 list (not available on glass doors)
- tackboard or markerboard available, see pages 292-295
- task lights available, see page 443

To Order, Specify:

① Laminate Model #	② Laminate Selection	③ Metal Color	④ Other Product Options
Laminate (FLT)	See Laminate Selection	See Metal Finish Color Options	See list of options for each specific unit; Specify and add accordingly.

① Veneer Model #	② Wood Species	③ Wood Finish	④ Metal Color	⑤ Other Product Options
Veneer (FLV)	Flat Cut CH1 Cherry MA1 Maple WA1 Walnut BO1 Black Oak	See Flat Cut Wood Finish Options	See Metal Finish Color Options	See list of options for each specific unit; Specify and add accordingly.
		③a Wood Finish See Double Cut Wood Finish Options		

Description	D	W	H	CTN WT	CU FT	Model	Laminate	Flat Cut Veneer	Double Cut Veneer
Storage Overhead Cabinet with Sliding Doors	15 15/16	95 7/8	40	232	43	FLT1696-40SD	\$2,522		
	15 15/16	95 7/8	40	232	43	FLV1696-40SD		\$4,133	\$4,546
	15 15/16	89 7/8	40	220	41	FLT1690-40SD	\$2,335		
	15 15/16	89 7/8	40	220	41	FLV1690-40SD		\$3,829	\$4,210
	15 15/16	83 7/8	40	209	38	FLT1684-40SD	\$2,151		
	15 15/16	83 7/8	40	209	38	FLV1684-40SD		\$3,523	\$3,876

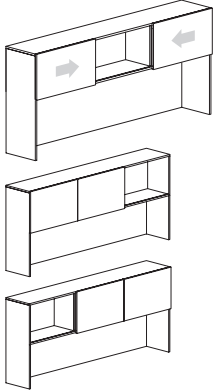

Features:

- use with primary height units, fastening hardware included
- laminate grain direction runs horizontal on back panel of overhead cabinets
- 22 3/4" vertical clearance between worksurface and bottom of door, excluding task light
- two 5/8" dia. holes in upper corners of back panel for task light wiring access
- exterior back panel unfinished
- locking not available

Options:

- must specify chassis grain direction on double cut veneer, see pages 11-13 for details
- veneer door fronts in paint available, specify paint color and add \$337 list; see page 14 for details
- on laminate units, contrasting laminate door fronts available, no upcharge; specify laminate color, see page 14 for details
- white glass doors with aluminum trim available, specify and add \$1,787 list for 96"w, \$1,714 list for 90"w, \$1,639 list for 84"w; see page 31 for details
- markerboard laminate doors available, specify and add \$555 list; see page 31 for details
- tackboard or markerboard available, see pages 292-295
- task lights available, see page 443

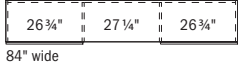
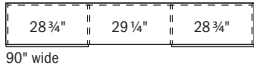
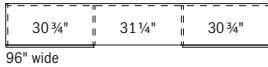

Storage Overhead Cabinet with Sliding Door	15 15/16	77 7/8	40	187	35	FLT1678-40SD	\$2,073		
	15 15/16	77 7/8	40	187	35	FLV1678-40SD		\$3,286	\$3,617
	15 15/16	71 7/8	40	175	33	FLT1672-40SD	\$1,955		
	15 15/16	71 7/8	40	175	33	FLV1672-40SD		\$3,099	\$3,412
	15 15/16	65 7/8	40	164	30	FLT1666-40SD	\$1,851		
	15 15/16	65 7/8	40	164	30	FLV1666-40SD		\$2,935	\$3,227
	15 15/16	59 7/8	40	153	27	FLT1660-40SD	\$1,772		
	15 15/16	59 7/8	40	153	27	FLV1660-40SD		\$2,807	\$3,088

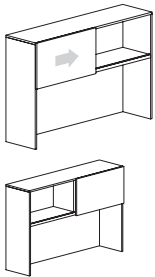

Features:

- use with primary height units, fastening hardware included
- laminate grain direction runs horizontal on back panel of overhead cabinets
- 22 3/4" vertical clearance between worksurface and bottom of door, excluding task light
- two 5/8" dia. holes in upper corners of back panel for task light wiring access
- exterior back panel unfinished
- locking not available

Options:

- must specify chassis grain direction on double cut veneer, see pages 11-13 for details
- veneer door fronts in paint available, specify paint color and add \$337 list; see page 14 for details
- on laminate units, contrasting laminate door fronts available, no upcharge; specify laminate color, see page 14 for details
- white glass doors with aluminum trim available, specify and add \$1,029 list for 78"w, \$1,029 list for 72"w, \$916 list for 66"w \$858 list for 60"w; see page 31 for details
- markerboard laminate doors available, specify and add \$279 list; see page 31 for details
- tackboard or markerboard available, see pages 292-295
- task lights available, see page 443

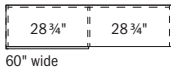
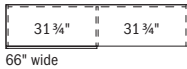
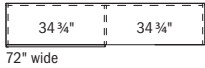
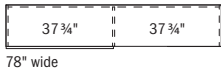

FLUX - PRIVATE OFFICE

Description	D	W	H	CTN WT	CU FT	① Model	Laminate	Flat Cut Veneer	Double Cut Veneer
Storage Overhead Cabinet with Sliding Door	15 15/16	53 7/8	40	141	25	FLT1654-40SD	\$1,733		
	15 15/16	53 7/8	40	141	25	FLV1654-40SD		\$2,702	\$2,973
	15 15/16	47 7/8	40	130	22	FLT1648-40SD	\$1,674		
	15 15/16	47 7/8	40	130	22	FLV1648-40SD		\$2,613	\$2,875
	15 15/16	41 7/8	40	119	20	FLT1642-40SD	\$1,623		
	15 15/16	41 7/8	40	119	20	FLV1642-40SD		\$2,532	\$2,787

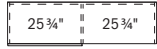
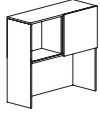
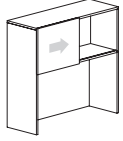

54" wide

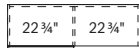

48" wide

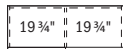

42" wide

Features:

- use with primary height units, fastening hardware included
- laminate grain direction runs horizontal on back panel of overhead cabinets
- 22 3/4" vertical clearance between worksurface and bottom of door, excluding task light
- two 5/8" dia. holes in upper corners of back panel for task light wiring access
- exterior back panel unfinished
- locking not available

Options:

- must specify chassis grain direction on double cut veneer, see pages 11-13 for details
- veneer door fronts in paint available, specify paint color and add \$337 list; see page 14 for details
- on laminate units, contrasting laminate door fronts available, no upcharge; specify laminate color, see page 14 for details
- white glass doors with aluminum trim available, specify and add \$803 list for 54"w, \$778 list for 48"w, \$748 list for 42"w; see page 31 for details
- markerboard laminate doors available, specify and add \$279 list; see page 31 for details
- tackboard or markerboard available, see pages 292-295
- task lights available, see page 443

Storage Overhead Cabinet with Sliding Door	15 15/16	35 7/8	40	107	17	FLT1636-40SD	\$1,541		
	15 15/16	35 7/8	40	107	17	FLV1636-40SD		\$2,404	\$2,645
	15 15/16	29 7/8	40	96	14	FLT1630-40SD	\$1,479		
	15 15/16	29 7/8	40	96	14	FLV1630-40SD		\$2,307	\$2,538

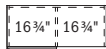
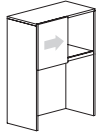

36" wide



30" wide

Features:

- use with primary height units, fastening hardware included
- laminate grain direction runs horizontal on back panel of overhead cabinets
- 22 3/4" vertical clearance between worksurface and bottom of door, excluding task light
- two 5/8" dia. holes in upper corners of back panel for task light wiring access
- exterior back panel unfinished
- locking not available

Options:

- must specify chassis grain direction on double cut veneer, see pages 11-13 for details
- veneer door fronts in paint available, specify paint color and add \$337 list; see page 14 for details
- on laminate units, contrasting laminate door fronts available, no upcharge; specify laminate color, see page 14 for details
- white glass doors with aluminum trim available, specify and add \$636 list for 36"w, \$607 list for 30"w; see page 31 for details
- markerboard laminate doors available, specify and add \$279 list; see page 31 for details
- tackboard or markerboard available, see pages 292-295
- task lights available, see page 443

To Order, Specify:

① Laminate Model #	② Laminate Selection	③ Metal Color	④ Other Product Options
Laminate (FLT)	See Laminate Selection	See Metal Finish Color Options	See list of options for each specific unit; Specify and add accordingly.

① Veneer Model #	② Wood Species	③ Wood Finish	④ Metal Color	⑤ Other Product Options
Veneer (FLV)	Flat Cut CH1 Cherry MA1 Maple WA1 Walnut BO1 Black Oak	See Flat Cut Wood Finish Options	See Metal Finish Color Options	See list of options for each specific unit; Specify and add accordingly.
		3a Wood Finish See Double Cut Wood Finish Options		

Description	D	W	H	CTN WT	CU FT	① Model	Laminate	Flat Cut Veneer	Double Cut Veneer
Open Storage Overhead Cabinet	15	95%	40	199	41	FLT1596-4000	\$1,953		
	15	95%	40	199	41	FLV1596-4000		\$3,308	\$3,639
	15	89%	40	189	38	FLT1590-4000	\$1,834		
	15	89%	40	189	38	FLV1590-4000		\$3,107	\$3,417
	15	83%	40	179	36	FLT1584-4000	\$1,715		
	15	83%	40	179	36	FLV1584-4000		\$2,902	\$3,194

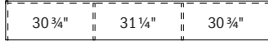
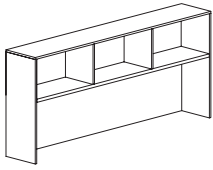

96" wide

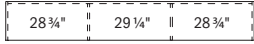

90" wide

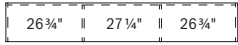

84" wide

Features:

- use with primary height units, fastening hardware included
- laminate grain direction runs horizontal on back panel of overhead cabinets
- 23" vertical clearance between worksurface and bottom of cabinet, excluding task light
- two 5/8" dia. holes in upper corners of back panel for task light wiring access
- exterior back panel unfinished

Options:

- must specify chassis grain direction on double cut veneer, see pages 11-13 for details
- tackboard or markerboard available, see pages 292-295
- task lights available, see page 443

Open Storage Overhead Cabinet	15	77%	40	164	34	FLT1578-4000	\$1,598		
	15	77%	40	164	34	FLV1578-4000		\$2,615	\$2,878
	15	71%	40	154	31	FLT1572-4000	\$1,508		
	15	71%	40	154	31	FLV1572-4000		\$2,466	\$2,714
	15	65%	40	150	29	FLT1566-4000	\$1,423		
	15	65%	40	150	29	FLV1566-4000		\$2,329	\$2,563
	15	59%	40	139	26	FLT1560-4000	\$1,363		
	15	59%	40	139	26	FLV1560-4000		\$2,227	\$2,450

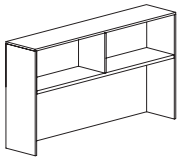

78" wide



72" wide



66" wide

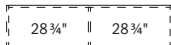

60" wide

Features:

- use with primary height units, fastening hardware included
- laminate grain direction runs horizontal on back panel of overhead cabinets
- 23" vertical clearance between worksurface and bottom of cabinet, excluding task light
- two 5/8" dia. holes in upper corners of back panel for task light wiring access
- exterior back panel unfinished

Options:

- must specify chassis grain direction on double cut veneer, see pages 11-13 for details
- tackboard or markerboard available, see pages 292-295
- task lights available, see page 443

Description	D	W	H	CTN WT	CU FT	① Model	Laminate	Flat Cut Veneer	Double Cut Veneer
Open Storage Overhead Cabinet	15	53 7/8"	40	129	24	FLT1554-4000	\$1,330		
	15	53 7/8"	40	129	24	FLV1554-4000		\$2,143	\$2,356
	15	47 7/8"	40	118	21	FLT1548-4000	\$1,287		
	15	47 7/8"	40	118	21	FLV1548-4000		\$2,069	\$2,276
	15	41 7/8"	40	108	19	FLT1542-4000	\$1,245		
	15	41 7/8"	40	108	19	FLV1542-4000		\$2,002	\$2,202

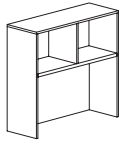

54" wide

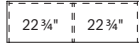

48" wide

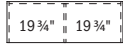

42" wide

Features:

- use with primary height units, fastening hardware included
- laminate grain direction runs horizontal on back panel of overhead cabinets
- 23" vertical clearance between worksurface and bottom of cabinet, excluding task light
- two 5/8" dia. holes in upper corners of back panel for task light wiring access
- exterior back panel unfinished

Options:

- must specify chassis grain direction on double cut veneer, see pages 11-13 for details
- tackboard or markerboard available, see pages 292-295
- task lights available, see page 443

Open Storage Overhead Cabinet	15	35 7/8"	40	90	16	FLT1536-4000	\$1,181		
	15	35 7/8"	40	90	16	FLV1536-4000		\$1,897	\$2,087
	15	29 7/8"	40	80	14	FLT1530-4000	\$1,131		
	15	29 7/8"	40	80	14	FLV1530-4000		\$1,820	\$2,002

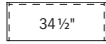
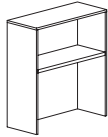

36" wide



30" wide

Features:

- use with primary height units, fastening hardware included
- laminate grain direction runs horizontal on back panel of overhead cabinets
- 23" vertical clearance between worksurface and bottom of cabinet, excluding task light
- two 5/8" dia. holes in upper corners of back panel for task light wiring access
- exterior back panel unfinished

Options:

- must specify chassis grain direction on double cut veneer, see pages 11-13 for details
- tackboard or markerboard available, see pages 292-295
- task lights available, see page 443

To Order, Specify:

① Laminate Model #	② Laminate Selection	③ Metal Color	④ Other Product Options
Laminate (FLT)	See Laminate Selection	See Metal Finish Color Options	See list of options for each specific unit; Specify and add accordingly.

① Veneer Model #	② Wood Species	③ Wood Finish	④ Metal Color	⑤ Other Product Options
Veneer (FLV)	Flat Cut CH1 Cherry MA1 Maple WA1 Walnut BO1 Black Oak	See Flat Cut Wood Finish Options	See Metal Finish Color Options	See list of options for each specific unit; Specify and add accordingly.
		3a Wood Finish See Double Cut Wood Finish Options		

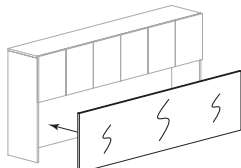
Description	D	W	H	CTN WT	CU FT	① Model	List Price
Overhead Cabinet Markerboard Panel 	13/16	94 1/4	22	57	5	FLB9523CMB	\$1,311
	13/16	88 1/4	22	53	4	FLB8923CMB	\$1,229
	13/16	82 1/4	22	69	6	FLB8323CMB	\$1,146
	13/16	76 1/4	22	46	4	FLB7723CMB	\$1,062
	13/16	70 1/4	22	42	4	FLB7123CMB	\$979
	13/16	64 1/4	22	54	4	FLB6523CMB	\$895
	13/16	58 1/4	22	35	3	FLB5923CMB	\$813
	13/16	52 1/4	22	32	3	FLB5323CMB	\$729
	13/16	46 1/4	22	28	3	FLB4723CMB	\$647
	13/16	40 1/4	22	25	2	FLB4123CMB	\$562
	13/16	34 1/4	22	21	2	FLB3523CMB	\$479
	13/16	28 1/4	22	18	2	FLB2923CMB	\$397

Features:

- use with 40”h and 52”h overhead cabinets
- standard markerboard laminate with aluminum pvc edge
- attaches to cabinet interior, mounting hardware included

FLUX - PRIVATE OFFICE

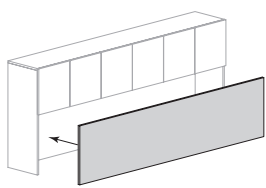
Description	D	W	H	CTN WT	CU FT	① Model	List Price Per Grade
96”w Tackboard for Overhead Cabinet 	13/16	94 1/4	22	25	4	FLB9522TK	COM \$745
							A \$783
							B \$855
							C \$982
							D \$1,148
							E \$1,311
							F \$1,568
							G \$1,844
							H \$2,136
							I \$2,593
							J \$3,142

Features:

- for use with 96” wide storage overhead cabinet
- use with 40”h and 52”h overhead cabinets
- attaches to cabinet interior, mounting hardware included
- com ydg: 3

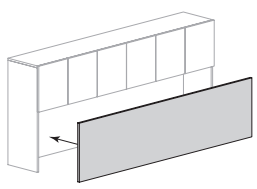
90”w Tackboard for Overhead Cabinet 	13/16	88 1/4	22	23	4	FLB8922TK	COM \$713
							A \$748
							B \$814
							C \$931
							D \$1,083
							E \$1,234
							F \$1,471
							G \$1,721
							H \$1,990
							I \$2,407
							J \$2,910

Features:

- for use with 90”w storage overhead cabinet
- use with 40”h and 52”h overhead cabinets
- attaches to cabinet interior, mounting hardware included
- com ydg: 2 3/4

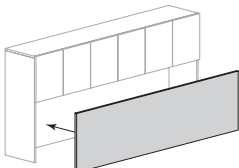
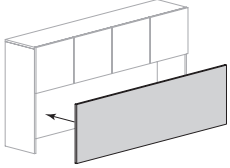
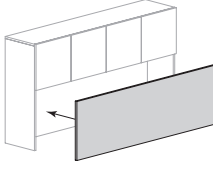
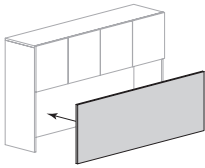
Description	D	W	H	CTN WT	CU FT	① Model	List Price Per Grade
84" w Tackboard for Overhead Cabinet 	13 1/16	82 1/4	22	22	4	FLB8322TK	COM \$681 A \$712 B \$773 C \$881 D \$1,018 E \$1,154 F \$1,368 G \$1,597 H \$1,841 I \$2,222 J \$2,679
Features: <ul style="list-style-type: none"> for use with 84" w storage overhead cabinet use with 40" h and 52" h overhead cabinets attaches to cabinet interior, mounting hardware included com ydg: 2 1/2 							
78" w Tackboard for Overhead Cabinet 	13 1/16	76 1/4	22	20	4	FLB7722TK	COM \$648 A \$680 B \$740 C \$847 D \$986 E \$1,121 F \$1,336 G \$1,564 H \$1,808 I \$2,189 J \$2,646
Features: <ul style="list-style-type: none"> for use with 78" w storage overhead cabinet use with 40" h and 52" h overhead cabinets attaches to cabinet interior, mounting hardware included com ydg: 2 1/2 							
72" w Tackboard for Overhead Cabinet 	13 1/16	70 1/4	22	19	3	FLB7122TK	COM \$617 A \$646 B \$699 C \$796 D \$920 E \$1,042 F \$1,235 G \$1,441 H \$1,661 I \$2,002 J \$2,415
Features: <ul style="list-style-type: none"> for use with 72" w storage overhead cabinet use with 40" h and 52" h overhead cabinets attaches to cabinet interior, mounting hardware included com ydg: 2 1/4 							
66" w Tackboard for Overhead Cabinet 	13 1/16	64 1/4	22	17	3	FLB6522TK	COM \$584 A \$608 B \$658 C \$743 D \$852 E \$964 F \$1,132 G \$1,318 H \$1,512 I \$1,817 J \$2,182
Features: <ul style="list-style-type: none"> for use with 66" w storage overhead cabinet use with 40" h and 52" h overhead cabinets attaches to cabinet interior, mounting hardware included com ydg: 2 							

FLUX - PRIVATE OFFICE

To Order, Specify:

① Model Number	② Fabric Selection	
(FLB)	Vendor Pattern Color	Visit www.jsifurniture.com/finishes-and-materials/textiles for our textiles program. See selection of standard and graded in manufacturers and patterns.

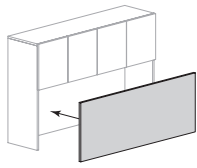
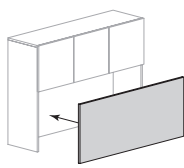
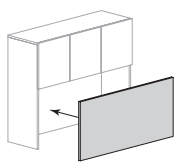
Description	D	W	H	CTN WT	CU FT	① Model	List Price Per Grade	
60" w Tackboard for Overhead Cabinet 	$1\frac{3}{16}$	58 $\frac{1}{4}$	22	15	3	FLB5922TK	COM \$552	
	Features:							A \$577
	· for use with 60" w storage overhead cabinet							B \$625
	· use with 40" h and 52" h overhead cabinets							C \$711
	· attaches to cabinet interior, mounting hardware included							D \$819
	· com ydg: 2							E \$929
								F \$1,101
								G \$1,285
								H \$1,479
								I \$1,784
								J \$2,149
	54" w Tackboard for Overhead Cabinet 	$1\frac{3}{16}$	52 $\frac{1}{4}$	22	14	3	FLB5322TK	COM \$520
Features:							A \$542	
· for use with 54" w storage overhead cabinet							B \$584	
· use with 40" h and 52" h overhead cabinets							C \$659	
· attaches to cabinet interior, mounting hardware included							D \$755	
· com ydg: 1 $\frac{3}{4}$							E \$851	
							F \$1,000	
							G \$1,161	
							H \$1,331	
							I \$1,598	
							J \$1,918	
48" w Tackboard for Overhead Cabinet 		$1\frac{3}{16}$	46 $\frac{1}{4}$	22	12	2	FLB4722TK	COM \$486
	Features:							A \$506
	· for use with 48" w storage overhead cabinet							B \$542
	· use with 40" h and 52" h overhead cabinets							C \$606
	· attaches to cabinet interior, mounting hardware included							D \$688
	· com ydg: 1 $\frac{1}{2}$							E \$772
								F \$899
								G \$1,037
								H \$1,183
								I \$1,412
								J \$1,686

FLUX - PRIVATE OFFICE

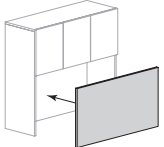
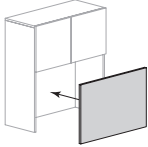
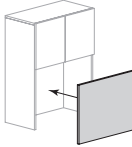
Description	D	W	H	CTN WT	CU FT	① Model	List Price Per Grade
42" w Tackboard for Overhead Cabinet 	13 1/16	40 1/4	22	11	2	FLB4122TK	COM \$456 A \$474 B \$511 C \$576 D \$658 E \$740 F \$868 G \$1,003 H \$1,152 I \$1,380 J \$1,655
36" w Tackboard for Overhead Cabinet 	13 1/16	34 1/4	22	9	2	FLB3522TK	COM \$423 A \$437 B \$469 C \$522 D \$593 E \$661 F \$767 G \$882 H \$1,002 I \$1,193 J \$1,422
30" w Tackboard Overhead Cabinet 	13 1/16	28 1/4	22	8	2	FLB2922TK	COM \$390 A \$402 B \$427 C \$470 D \$524 E \$580 F \$666 G \$757 H \$854 I \$1,007 J \$1,188

- Features:**
- for use with 42" w storage overhead cabinet
 - use with 40" h and 52" h overhead cabinets
 - attaches to cabinet interior, mounting hardware included
 - com ydg: 1 1/2

- Features:**
- for use with 36" w storage overhead cabinet
 - use with 40" h and 52" h overhead cabinets
 - attaches to cabinet interior, mounting hardware included
 - com ydg: 1 1/4

- Features:**
- for use with 30" w storage overhead cabinet
 - use with 40" h and 52" h overhead cabinets
 - attaches to cabinet interior, mounting hardware included
 - com ydg: 1

FLUX - PRIVATE OFFICE

To Order, Specify:

① Model Number	② Fabric Selection	
(FLB)	Vendor Pattern Color	Visit www.jsifurniture.com/finishes-and-materials/textiles for our textiles program. See selection of standard and graded in manufacturers and patterns.

Description	D	W	H	CTN WT	CU FT	① Model	Laminate	Flat Cut Veneer	Double Cut Veneer
Storage Overhead Cabinet with Four Doors	15 $\frac{7}{8}$ "	95 $\frac{7}{8}$ "	48"	254	51	FLT1696-48S0	\$2,322		
	15 $\frac{7}{8}$ "	95 $\frac{7}{8}$ "	48"	254	51	FLV1696-48S0		\$3,933	\$4,327
	15 $\frac{7}{8}$ "	89 $\frac{7}{8}$ "	48"	241	48	FLT1690-48S0	\$2,182		
	15 $\frac{7}{8}$ "	89 $\frac{7}{8}$ "	48"	241	48	FLV1690-48S0		\$3,696	\$4,065
	15 $\frac{7}{8}$ "	83 $\frac{7}{8}$ "	48"	228	45	FLT1684-48S0	\$2,039		
	15 $\frac{7}{8}$ "	83 $\frac{7}{8}$ "	48"	228	45	FLV1684-48S0		\$3,452	\$3,795

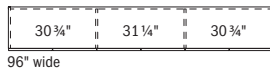
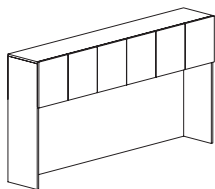

96" wide

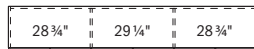

90" wide

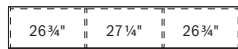

84" wide

Features:

- use with secondary height units, fastening hardware included
- laminate grain direction runs horizontal on back panel of overhead cabinets
- 1/4" overhang at the bottom of the door allows access
- 30 $\frac{3}{4}$ " vertical clearance between worksurface and bottom of door, excluding task light
- two 5/8" dia. holes in upper corners of back panel for task light wiring access
- exterior back panel unfinished

Options:

- must specify chassis grain direction on double cut veneer, see pages 11-13 for details
- veneer door fronts in paint available, specify paint color and add \$337 list; see page 14 for details
- on laminate units, contrasting laminate door fronts available, no upcharge; specify laminate color, see page 14 for details
- white glass doors with aluminum trim available, specify and add \$3,348 list; see page 31 for details
- markerboard laminate doors available, specify and add \$1,116 list; see page 31 for details
- locking doors available, specify and add \$426 list (not available on glass doors)
- tackboard or markerboard available, see pages 306-309
- task lights available, see page 443

Description	D	W	H	CTN WT	CU FT	① Model	Laminate	Flat Cut Veneer	Double Cut Veneer
Storage Overhead Cabinet with Four Doors	15 7/8	77 7/8	48	220	42	FLT1678-48S0	\$1,898		
	15 7/8	77 7/8	48	220	42	FLV1678-48S0		\$3,112	\$3,423
	15 7/8	71 7/8	48	197	39	FLT1672-48S0	\$1,789		
	15 7/8	71 7/8	48	197	39	FLV1672-48S0		\$2,933	\$3,225
	15 7/8	65 7/8	48	189	36	FLT1666-48S0	\$1,692		
	15 7/8	65 7/8	48	189	36	FLV1666-48S0		\$2,768	\$3,048
	15 7/8	59 7/8	48	175	33	FLT1660-48S0	\$1,619		
	15 7/8	59 7/8	48	175	33	FLV1660-48S0		\$2,647	\$2,911

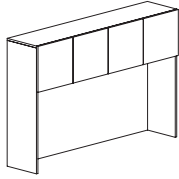

78" wide

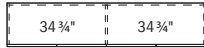

72" wide



66" wide



60" wide

Features:

- use with secondary height units, fastening hardware included
- laminate grain direction runs horizontal on back panel of overhead cabinets
- 1/4" overhang at the bottom of the door allows access
- 30 3/4" vertical clearance between worksurface and bottom of door, excluding task light
- two 5/8" dia. holes in upper corners of back panel for task light wiring access
- exterior back panel unfinished

Options:

- must specify chassis grain direction on double cut veneer, see pages 11-13 for details
- veneer door fronts in paint available, specify paint color and add \$337 list; see page 14 for details
- on laminate units, contrasting laminate door fronts available, no upcharge; specify laminate color, see page 14 for details
- white glass doors with aluminum trim available, specify and add \$2,433 list for 78"w, \$2,321 list for 72"w, \$2,234 list for 66"w or 60"w; see page 31 for details
- markerboard laminate doors available, specify and add \$744 list; see page 31 for details
- locking doors available, specify and add \$284 list (not available on glass doors)
- tackboard or markerboard available, see pages 306-309
- task lights available, see page 443

To Order, Specify:

① Laminate Model #	② Laminate Selection	③ Metal Color	④ Other Product Options
Laminate (FLT)	See Laminate Selection	See Metal Finish Color Options	See list of options for each specific unit; Specify and add accordingly.

① Veneer Model #	② Wood Species	③ Wood Finish	④ Metal Color	⑤ Other Product Options
Veneer (FLV)	Flat Cut CH1 Cherry MA1 Maple WA1 Walnut BO1 Black Oak	See Flat Cut Wood Finish Options	See Metal Finish Color Options	See list of options for each specific unit; Specify and add accordingly.
		③a Wood Finish See Double Cut Wood Finish Options		

Description	D	W	H	CTN WT	CU FT	① Model	Laminate	Flat Cut Veneer	Double Cut Veneer
Storage Overhead Cabinet with Three Doors	15 $\frac{7}{8}$ "	53 $\frac{7}{8}$ "	48"	162	29	FLT1654-48SOR	\$1,581		
	15 $\frac{7}{8}$ "	53 $\frac{7}{8}$ "	48"	162	29	FLV1654-48SOR		\$2,548	\$2,803
	15 $\frac{7}{8}$ "	53 $\frac{7}{8}$ "	48"	162	29	FLT1654-48SOL	\$1,581		
	15 $\frac{7}{8}$ "	53 $\frac{7}{8}$ "	48"	162	29	FLV1654-48SOL		\$2,548	\$2,803
	15 $\frac{7}{8}$ "	47 $\frac{7}{8}$ "	48"	148	26	FLT1648-48SOR	\$1,528		
	15 $\frac{7}{8}$ "	47 $\frac{7}{8}$ "	48"	148	26	FLV1648-48SOR		\$2,459	\$2,706
	15 $\frac{7}{8}$ "	47 $\frac{7}{8}$ "	48"	148	26	FLT1648-48SOL	\$1,528		
	15 $\frac{7}{8}$ "	47 $\frac{7}{8}$ "	48"	148	26	FLV1648-48SOL		\$2,459	\$2,706
	15 $\frac{7}{8}$ "	41 $\frac{7}{8}$ "	48"	134	23	FLT1642-48SOR	\$1,479		
	15 $\frac{7}{8}$ "	41 $\frac{7}{8}$ "	48"	134	23	FLV1642-48SOR		\$2,384	\$2,621
	15 $\frac{7}{8}$ "	41 $\frac{7}{8}$ "	48"	134	23	FLT1642-48SOL	\$1,479		
	15 $\frac{7}{8}$ "	41 $\frac{7}{8}$ "	48"	134	23	FLV1642-48SOL		\$2,384	\$2,621

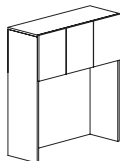

right shown



54" wide

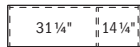

48" wide

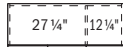

42" wide

Features:

- use with secondary height units, fastening hardware included
- laminate grain direction runs horizontal on back panel of overhead cabinets
- 1/4" overhang at the bottom of the door allows access
- 30 3/4" vertical clearance between worksurface and bottom of door, excluding task light
- two 5/8" dia. holes in upper corners of back panel for task light wiring access
- exterior back panel unfinished

Options:

- must specify chassis grain direction on double cut veneer, see pages 11-13 for details
- veneer door fronts in paint available, specify paint color and add \$337 list; see page 14 for details
- on laminate units, contrasting laminate door fronts available, no upcharge; specify laminate color, see page 14 for details
- white glass doors with aluminum trim available, specify and add \$1,742 list for 54"w, \$1,675 list for 48"w or 42"w; see page 31 for details
- markerboard laminate doors available, specify and add \$560 list; see page 31 for details
- locking doors available, specify and add \$284 list (not available on glass doors)
- tackboard or markerboard available, see pages 306-309
- task lights available, see page 443

Description	D	W	H	CTN WT	CU FT	① Model	Laminate	Flat Cut Veneer	Double Cut Veneer
Storage Overhead Cabinet with Two Doors	15 7/8	35 7/8	48	113	20	FLT1636-48S0	\$1,404		
	15 7/8	35 7/8	48	113	20	FLV1636-48S0		\$2,259	\$2,486
	15 7/8	29 7/8	48	100	17	FLT1630-48S0	\$1,344		
	15 7/8	29 7/8	48	100	17	FLV1630-48S0		\$2,164	\$2,378

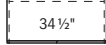
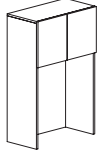

36" wide



30" wide

Features:

- use with secondary height units, fastening hardware included
- laminate grain direction runs horizontal on back panel of overhead cabinets
- 1/4" overhang at the bottom of the door allows access
- 30 3/4" vertical clearance between worksurface and bottom of door, excluding task light
- two 5/8" dia. holes in upper corners of back panel for task light wiring access
- exterior back panel unfinished

Options:

- must specify chassis grain direction on double cut veneer, see pages 11-13 for details
- veneer door fronts in paint available, specify paint color and add \$337 list; see page 14 for details
- on laminate units, contrasting laminate door fronts available, no upcharge; specify laminate color, see page 14 for details
- white glass doors with aluminum trim available, specify and add \$1,163 list for 36"w, \$1,119 list for 30"w; see page 31 for details
- markerboard laminate doors available, specify and add \$375 list; see page 31 for details
- locking doors available, specify and add \$142 list (not available on glass doors)
- tackboard or markerboard available, see pages 306-309
- task lights available, see page 443

To Order, Specify:

① Laminate Model #	② Laminate Selection	③ Metal Color	④ Other Product Options
Laminate (FLT)	See Laminate Selection	See Metal Finish Color Options	See list of options for each specific unit; Specify and add accordingly.

① Veneer Model #	② Wood Species	③ Wood Finish	④ Metal Color	⑤ Other Product Options
Veneer (FLV)	Flat Cut CH1 Cherry MA1 Maple WA1 Walnut BO1 Black Oak	See Flat Cut Wood Finish Options	See Metal Finish Color Options	See list of options for each specific unit; Specify and add accordingly.
		3a Wood Finish See Double Cut Wood Finish Options		

Description	D	W	H	CTN WT	CU FT	Model	Laminate	Flat Cut Veneer	Double Cut Veneer
Storage Overhead Cabinet with Four Doors with Open Center	15 7/8"	95 7/8"	48"	242	51	FLT1696-48SMO	\$2,208		
	15 7/8"	95 7/8"	48"	242	51	FLV1696-48SMO		\$3,741	\$4,114
	15 7/8"	89 7/8"	48"	230	48	FLT1690-48SMO	\$2,044		
	15 7/8"	89 7/8"	48"	230	48	FLV1690-48SMO		\$3,461	\$3,808
	15 7/8"	83 7/8"	48"	217	45	FLT1684-48SMO	\$1,881		
	15 7/8"	83 7/8"	48"	217	45	FLV1684-48SMO		\$3,182	\$3,501

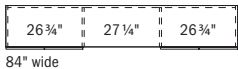
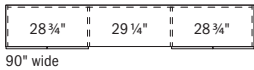
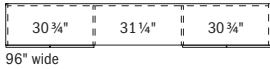
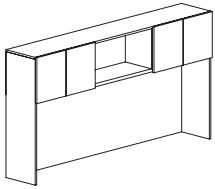

Features:

- use with secondary height units, fastening hardware included
- laminate grain direction runs horizontal on back panel of overhead cabinets
- 1/4" overhang at the bottom of the door allows access
- 30 3/4" vertical clearance between worksurface and bottom of door, excluding task light
- two 5/8" dia. holes in upper corners of back panel for task light wiring access
- exterior back panel unfinished

Options:

- must specify chassis grain direction on double cut veneer, see pages 11-13 for details
- veneer door fronts in paint available, specify paint color and add \$337 list; see page 14 for details
- on laminate units, contrasting laminate door fronts available, no upcharge; specify laminate color, see page 14 for details
- white glass doors with aluminum trim available, specify and add \$2,234 list; see page 31 for details
- markerboard laminate doors available, specify and add \$744 list; see page 31 for details
- locking doors available, specify and add \$284 list (not available on glass doors)
- tackboard or markerboard available, see pages 306-309
- task lights available, see page 443

Storage Overhead Cabinet with Two Doors with Open Compartment	15 7/8"	77 7/8"	48"	196	42	FLT1678-48SMOR	\$1,809		
	15 7/8"	77 7/8"	48"	196	42	FLV1678-48SMOR		\$2,961	\$3,257
	15 7/8"	77 7/8"	48"	196	42	FLT1678-48SMOL	\$1,809		
	15 7/8"	77 7/8"	48"	196	42	FLV1678-48SMOL		\$2,961	\$3,257
	15 7/8"	71 7/8"	48"	184	39	FLT1672-48SMOR	\$1,703		
	15 7/8"	71 7/8"	48"	184	39	FLV1672-48SMOR		\$2,791	\$3,069
	15 7/8"	71 7/8"	48"	184	39	FLT1672-48SMOL	\$1,703		
	15 7/8"	71 7/8"	48"	184	39	FLV1672-48SMOL		\$2,791	\$3,069
	15 7/8"	65 7/8"	48"	177	36	FLT1666-48SMOR	\$1,612		
	15 7/8"	65 7/8"	48"	177	36	FLV1666-48SMOR		\$2,638	\$2,902
	15 7/8"	65 7/8"	48"	177	36	FLT1666-48SMOL	\$1,612		
	15 7/8"	65 7/8"	48"	177	36	FLV1666-48SMOL		\$2,638	\$2,902
	15 7/8"	59 7/8"	48"	164	33	FLT1660-48SMOR	\$1,540		
	15 7/8"	59 7/8"	48"	164	33	FLV1660-48SMOR		\$2,520	\$2,771
	15 7/8"	59 7/8"	48"	164	33	FLT1660-48SMOL	\$1,540		
	15 7/8"	59 7/8"	48"	164	33	FLV1660-48SMOL		\$2,520	\$2,771

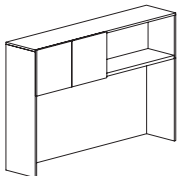

left shown

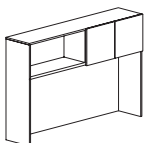

right

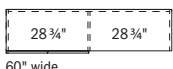
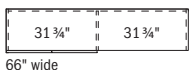
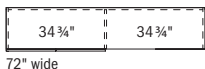
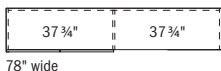

Features:

- use with secondary height units, fastening hardware included
- laminate grain direction runs horizontal on back panel of overhead cabinets
- 1/4" overhang at the bottom of the door allows access
- 30 3/4" vertical clearance between worksurface and bottom of door, excluding task light
- two 5/8" dia. holes in upper corners of back panel for task light wiring access
- exterior back panel unfinished

Options:

- must specify chassis grain direction on double cut veneer, see pages 11-13 for details
- veneer door fronts in paint available, specify paint color and add \$337 list; see page 14 for details
- on laminate units, contrasting laminate door fronts available, no upcharge; specify laminate color, see page 14 for details
- white glass doors with aluminum trim available, specify and add \$1,218 list for 78"w, \$1,163 list for 72"w, \$1,119 list for 66"w or 60"w; see page 31 for details
- markerboard laminate doors available, specify and add \$375 list; see page 31 for details
- locking doors available, specify and add \$142 list (not available on glass doors)
- tackboard or markerboard available, see pages 306-309
- task lights available, see page 443

Description	D	W	H	CTN WT	CU FT	① Model	Laminate	Flat Cut Veneer	Double Cut Veneer
Storage Overhead Cabinet with Two Doors with Open Center	15 7/8	53 7/8	48	159	29	FLT1654-48SMO	\$1,819		
	15 7/8	53 7/8	48	159	29	FLV1654-48SMO		\$2,755	\$3,027
	15 7/8	47 7/8	48	146	26	FLT1648-48SMO	\$1,758		
	15 7/8	47 7/8	48	146	26	FLV1648-48SMO		\$2,663	\$2,931
	15 7/8	41 7/8	48	133	23	FLT1642-48SMO	\$1,703		
	15 7/8	41 7/8	48	133	23	FLV1642-48SMO		\$2,580	\$2,838

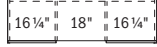
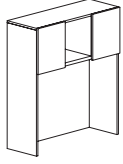

54" wide



48" wide



42" wide

Features:

- use with secondary height units, fastening hardware included
- laminate grain direction runs horizontal on back panel of overhead cabinets
- 1/4" overhang at the bottom of the door allows access
- 30 3/4" vertical clearance between worksurface and bottom of door, excluding task light
- two 5/8" dia. holes in upper corners of back panel for task light wiring access
- exterior back panel unfinished

Options:

- must specify chassis grain direction on double cut veneer, see pages 11-13 for details
- veneer door fronts in paint available, specify paint color and add \$337 list; see page 14 for details
- on laminate units, contrasting laminate door fronts available, no upcharge; specify laminate color, see page 14 for details
- white glass doors with aluminum trim available, specify and add \$1,134 list for 54"w, \$1,091 list for 48"w or 42"w; see page 31 for details
- markerboard laminate doors available, specify and add \$375 list; see page 31 for details
- locking doors available, specify and add \$142 list (not available on glass doors)
- tackboard or markerboard available, see pages 306-309
- task lights available, see page 443

To Order, Specify:

① Laminate Model #	② Laminate Selection	③ Metal Color	④ Other Product Options
Laminate (FLT)	See Laminate Selection	See Metal Finish Color Options	See list of options for each specific unit; Specify and add accordingly.

① Veneer Model #	② Wood Species	③ Wood Finish	④ Metal Color	⑤ Other Product Options
Veneer (FLV)	Flat Cut CH1 Cherry MA1 Maple WA1 Walnut BO1 Black Oak	See Flat Cut Wood Finish Options	See Metal Finish Color Options	See list of options for each specific unit; Specify and add accordingly.
		3a Wood Finish See Double Cut Wood Finish Options		

Description	D	W	H	CTN WT	CU FT	① Model	Laminate	Flat Cut Veneer	Double Cut Veneer
Storage Overhead Cabinet with Sliding Door	15 15/16	95 7/8	48	251	51	FLT1696-48SD	\$2,602		
	15 15/16	95 7/8	48	251	51	FLV1696-48SD		\$4,264	\$4,692
	15 15/16	89 7/8	48	239	48	FLT1690-48SD	\$2,413		
	15 15/16	89 7/8	48	239	48	FLV1690-48SD		\$3,954	\$4,350
	15 15/16	83 7/8	48	226	45	FLT1684-48SD	\$2,221		
	15 15/16	83 7/8	48	226	45	FLV1684-48SD		\$3,639	\$4,003

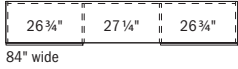
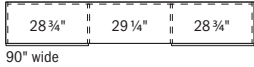
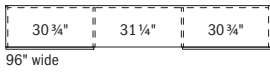
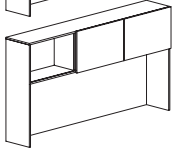
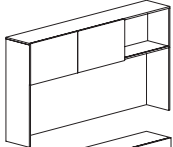
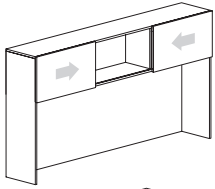

Features:

- use with secondary height units, fastening hardware included
- laminate grain direction runs horizontal on back panel of overhead cabinets
- 30 3/4" vertical clearance between worksurface and bottom of door, excluding task light
- two 5/8" dia. holes in upper corners of back panel for task light wiring access
- exterior back panel unfinished
- locking not available

Options:

- must specify chassis grain direction on double cut veneer, see pages 11-13 for details
- veneer door fronts in paint available, specify paint color and add \$337 list; see page 14 for details
- on laminate units, contrasting laminate door fronts available, no upcharge; specify laminate color, see page 14 for details
- white glass doors with aluminum trim available, specify and add \$1,787 list for 96"w, \$1,714 list for 90"w, \$1,639 list for 84"w; see page 31 for details
- markerboard laminate doors available, specify and add \$555 list; see page 31 for details
- tackboard or markerboard available, see pages 306-309
- task lights available, see page 443

Storage Overhead Cabinet with Sliding Door	15 15/16	77 7/8	48	203	42	FLT1678-48SD	\$2,138		
	15 15/16	77 7/8	48	203	42	FLV1678-48SD		\$3,391	\$3,730
	15 15/16	71 7/8	48	190	39	FLT1672-48SD	\$2,016		
	15 15/16	71 7/8	48	190	39	FLV1672-48SD		\$3,201	\$3,520
	15 15/16	65 7/8	48	178	36	FLT1666-48SD	\$1,909		
	15 15/16	65 7/8	48	178	36	FLV1666-48SD		\$3,027	\$3,331
	15 15/16	59 7/8	48	166	33	FLT1660-48SD	\$1,825		
	15 15/16	59 7/8	48	166	33	FLV1660-48SD		\$2,896	\$3,186

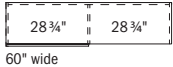
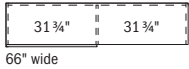
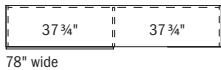
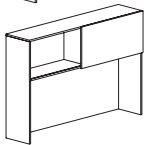
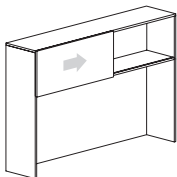

Features:

- use with secondary height units, fastening hardware included
- laminate grain direction runs horizontal on back panel of overhead cabinets
- 30 3/4" vertical clearance between worksurface and bottom of door, excluding task light
- two 5/8" dia. holes in upper corners of back panel for task light wiring access
- exterior back panel unfinished
- locking not available

Options:

- must specify chassis grain direction on double cut veneer, see pages 11-13 for details
- veneer door fronts in paint available, specify paint color and add \$337 list; see page 14 for details
- on laminate units, contrasting laminate door fronts available, no upcharge; specify laminate color, see page 14 for details
- white glass doors with aluminum trim available, specify and add \$1,003 list for 78"w, \$947 list for 72"w, \$893 list for 66"w \$837 list for 60"w; see page 31 for details
- markerboard laminate doors available, specify and add \$279 list; see page 31 for details
- tackboard or markerboard available, see pages 306-309
- task lights available, see page 443

Description	D	W	H	CTN WT	CU FT	① Model	Laminate	Flat Cut Veneer	Double Cut Veneer
Storage Overhead Cabinet with Sliding Door	15 15/16	53 7/8	48	153	30	FLT1654-48SD	\$1,785		
	15 15/16	53 7/8	48	153	30	FLV1654-48SD		\$2,790	\$3,067
	15 15/16	47 7/8	48	141	26	FLT1648-48SD	\$1,728		
	15 15/16	47 7/8	48	141	26	FLV1648-48SD		\$2,696	\$2,967
	15 15/16	41 7/8	48	128	23	FLT1642-48SD	\$1,673		
	15 15/16	41 7/8	48	128	23	FLV1642-48SD		\$2,614	\$2,876

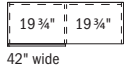
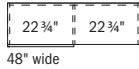
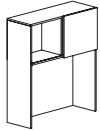
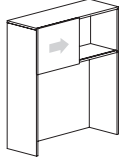

Features:

- use with secondary height units, fastening hardware included
- laminate grain direction runs horizontal on back panel of overhead cabinets
- 30 3/4" vertical clearance between worksurface and bottom of door, excluding task light
- two 5/8" dia. holes in upper corners of back panel for task light wiring access
- exterior back panel unfinished
- locking not available

Options:

- must specify chassis grain direction on double cut veneer, see pages 11-13 for details
- veneer door fronts in paint available, specify paint color and add \$337 list; see page 14 for details
- on laminate units, contrasting laminate door fronts available, no upcharge; specify laminate color, see page 14 for details
- white glass doors with aluminum trim available, specify and add \$803 list for 54"w, \$778 list for 48"w, \$748 list for 42"w; see page 31 for details
- markerboard laminate doors available, specify and add \$279 list; see page 31 for details
- tackboard or markerboard available, see pages 306-309
- task lights available, see page 443

Storage Overhead Cabinet with Sliding Door	15 15/16	35 7/8	48	116	20	FLT1636-48SD	\$1,589		
	15 15/16	35 7/8	48	116	20	FLV1636-48SD		\$2,480	\$2,727
	15 15/16	29 7/8	48	104	17	FLT1630-48SD	\$1,525		
	15 15/16	29 7/8	48	104	17	FLV1630-48SD		\$2,378	\$2,616

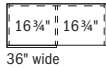
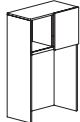
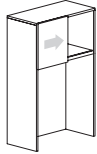

Features:

- use with secondary height units, fastening hardware included
- laminate grain direction runs horizontal on back panel of overhead cabinets
- 30 3/4" vertical clearance between worksurface and bottom of door, excluding task light
- two 5/8" dia. holes in upper corners of back panel for task light wiring access
- exterior back panel unfinished
- locking not available

Options:

- must specify chassis grain direction on double cut veneer, see pages 11-13 for details
- veneer door fronts in paint available, specify paint color and add \$337 list; see page 14 for details
- on laminate units, contrasting laminate door fronts available, no upcharge; specify laminate color, see page 14 for details
- white glass doors with aluminum trim available, specify and add \$636 list for 36"w, \$607 list for 30"w; see page 31 for details
- markerboard laminate doors available, specify and add \$279 list; see page 31 for details
- tackboard or markerboard available, see pages 306-309
- task lights available, see page 443

To Order, Specify:

① Laminate Model #	② Laminate Selection	③ Metal Color	④ Other Product Options
Laminate (FLT)	See Laminate Selection	See Metal Finish Color Options	See list of options for each specific unit; Specify and add accordingly.

① Veneer Model #	② Wood Species	③ Wood Finish	④ Metal Color	⑤ Other Product Options
Veneer (FLV)	Flat Cut CH1 Cherry MA1 Maple WA1 Walnut BO1 Black Oak	See Flat Cut Wood Finish Options	See Metal Finish Color Options	See list of options for each specific unit; Specify and add accordingly.
		<table border="1"> <thead> <tr> <th>ⓐ Wood Finish</th> <th>ⓑ Chassis Grain Direction</th> </tr> </thead> <tbody> <tr> <td>See Double Cut Wood Finish Options</td> <td>For Double Cut Only: Vertical Horizontal</td> </tr> </tbody> </table>		
ⓐ Wood Finish	ⓑ Chassis Grain Direction			
See Double Cut Wood Finish Options	For Double Cut Only: Vertical Horizontal			
Double Cut DC1 Double Cut				

Description	D	W	H	CTN WT	CU FT	① Model	Laminate	Flat Cut Veneer	Double Cut Veneer
Open Storage Overhead Cabinet	15	95 $\frac{7}{8}$ "	48	218	49	FLT1596-4800	\$2,033		
	15	95 $\frac{7}{8}$ "	48	218	49	FLV1596-4800		\$3,440	\$3,785
	15	89 $\frac{7}{8}$ "	48	207	46	FLT1590-4800	\$1,910		
	15	89 $\frac{7}{8}$ "	48	207	46	FLV1590-4800		\$3,230	\$3,554
	15	83 $\frac{7}{8}$ "	48	196	43	FLT1584-4800	\$1,784		
	15	83 $\frac{7}{8}$ "	48	196	43	FLV1584-4800		\$3,018	\$3,320

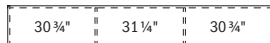
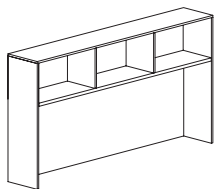

96" wide

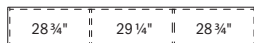

90" wide

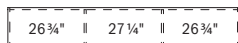

84" wide

Features:

- use with secondary height units, fastening hardware included
- laminate grain direction runs horizontal on back panel of overhead cabinets
- 31" vertical clearance between worksurface and bottom of cabinet, excluding task light
- two 5/8" dia. holes in upper corners of back panel for task light wiring access
- exterior back panel unfinished

Options:

- must specify chassis grain direction on double cut veneer, see pages 11-13 for details
- tackboard or markerboard available, see pages 306-309
- task lights available, see page 443

Open Storage Overhead Cabinet	15	77 $\frac{7}{8}$ "	48	180	40	FLT1578-4800	\$1,663		
	15	77 $\frac{7}{8}$ "	48	180	40	FLV1578-4800		\$2,720	\$2,993
	15	71 $\frac{7}{8}$ "	48	169	37	FLT1572-4800	\$1,566		
	15	71 $\frac{7}{8}$ "	48	169	37	FLV1572-4800		\$2,565	\$2,822
	15	65 $\frac{7}{8}$ "	48	163	34	FLT1566-4800	\$1,480		
	15	65 $\frac{7}{8}$ "	48	163	34	FLV1566-4800		\$2,424	\$2,667
	15	59 $\frac{7}{8}$ "	48	152	31	FLT1560-4800	\$1,415		
	15	59 $\frac{7}{8}$ "	48	152	31	FLV1560-4800		\$2,316	\$2,548

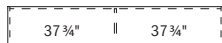
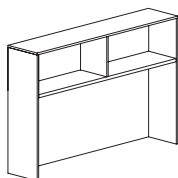

78" wide



72" wide



66" wide

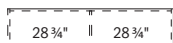

60" wide

Features:

- use with secondary height units, fastening hardware included
- laminate grain direction runs horizontal on back panel of overhead cabinets
- 31" vertical clearance between worksurface and bottom of cabinet, excluding task light
- two 5/8" dia. holes in upper corners of back panel for task light wiring access
- exterior back panel unfinished

Options:

- must specify chassis grain direction on double cut veneer, see pages 11-13 for details
- tackboard or markerboard available, see pages 306-309
- task lights available, see page 443

Description	D	W	H	CTN WT	CU FT	① Model	Laminate	Flat Cut Veneer	Double Cut Veneer
Open Storage Overhead Cabinet	15	53 7/8	48	140	28	FLT1554-4800	\$1,383		
	15	53 7/8	48	140	28	FLV1554-4800		\$2,229	\$2,451
	15	47 7/8	48	129	25	FLT1548-4800	\$1,338		
	15	47 7/8	48	129	25	FLV1548-4800		\$2,153	\$2,370
	15	41 7/8	48	117	22	FLT1542-4800	\$1,295		
	15	41 7/8	48	117	22	FLV1542-4800		\$2,084	\$2,292

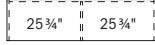
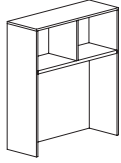

54" wide

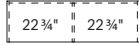

48" wide

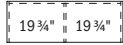

42" wide

Features:

- use with secondary height units, fastening hardware included
- laminate grain direction runs horizontal on back panel of overhead cabinets
- 31" vertical clearance between worksurface and bottom of cabinet, excluding task light
- two 5/8" dia. holes in upper corners of back panel for task light wiring access
- exterior back panel unfinished

Options:

- must specify chassis grain direction on double cut veneer, see pages 11-13 for details
- tackboard or markerboard available, see pages 306-309
- task lights available, see page 443

Open Storage Overhead Cabinet	15	35 7/8	48	99	19	FLT1536-4800	\$1,227		
	15	35 7/8	48	99	19	FLV1536-4800		\$1,976	\$2,172
	15	29 7/8	48	88	16	FLT1530-4800	\$1,177		
	15	29 7/8	48	88	16	FLV1530-4800		\$1,892	\$2,082

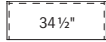
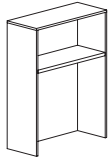

36" wide



30" wide

Features:

- use with secondary height units, fastening hardware included
- laminate grain direction runs horizontal on back panel of overhead cabinets
- 31" vertical clearance between worksurface and bottom of cabinet, excluding task light
- two 5/8" dia. holes in upper corners of back panel for task light wiring access
- exterior back panel unfinished

Options:

- must specify chassis grain direction on double cut veneer, see pages 11-13 for details
- tackboard or markerboard available, see pages 306-309
- task lights available, see page 443

To Order, Specify:

① Laminate Model #	② Laminate Selection	③ Metal Color	④ Other Product Options
Laminate (FLT)	See Laminate Selection	See Metal Finish Color Options	See list of options for each specific unit; Specify and add accordingly.

① Veneer Model #	② Wood Species	③ Wood Finish	④ Metal Color	⑤ Other Product Options
Veneer (FLV)	Flat Cut CH1 Cherry MA1 Maple WA1 Walnut BO1 Black Oak	See Flat Cut Wood Finish Options	See Metal Finish Color Options	See list of options for each specific unit; Specify and add accordingly.
		③a Wood Finish See Double Cut Wood Finish Options		

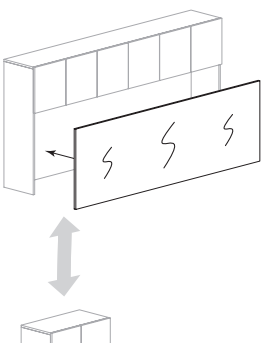
Description	D	W	H	CTN WT	CU FT	① Model	List Price
Overhead Cabinet Markerboard Panel 	13/16	94 1/4	30	76	6	FLB9531CMB	\$1,787
	13/16	88 1/4	30	71	6	FLB8931CMB	\$1,674
	13/16	82 1/4	30	67	5	FLB8331CMB	\$1,561
	13/16	76 1/4	30	62	5	FLB7731CMB	\$1,447
	13/16	70 1/4	30	57	5	FLB7131CMB	\$1,336
	13/16	64 1/4	30	52	4	FLB6531CMB	\$1,220
	13/16	58 1/4	30	47	4	FLB5931CMB	\$1,106
	13/16	52 1/4	30	43	4	FLB5331CMB	\$995
	13/16	46 1/4	30	38	3	FLB4731CMB	\$881
	13/16	40 1/4	30	33	3	FLB4131CMB	\$767
	13/16	34 1/4	30	28	3	FLB3531CMB	\$651
	13/16	28 1/4	30	24	2	FLB2931CMB	\$540

Features:

- use with 48”h overhead cabinets
- standard markerboard laminate with aluminum pvc edge
- attaches to cabinet interior, mounting hardware included

FLUX - PRIVATE OFFICE

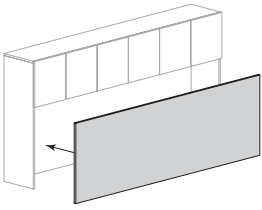
Description	D	W	H	CTN WT	CU FT	① Model	List Price Per Grade
96”w Tackboard for Overhead Cabinet 	13/16	94 1/4	30	33	6	FLB9530TK	COM \$929
							A \$968
							B \$1,040
							C \$1,168
							D \$1,334
							E \$1,496
							F \$1,753
							G \$2,027
							H \$2,321
							I \$2,779
							J \$3,328

Features:

- for use with 96” wide storage overhead cabinet
- use with 48”h overhead cabinets
- attaches to cabinet interior, mounting hardware included
- com ydg: 3

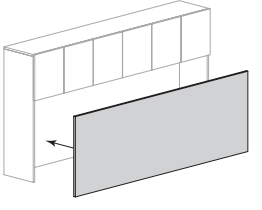
96”w Tackboard for Overhead Cabinet 	13/16	88 1/4	30	31	5	FLB8930TK	COM \$886
							A \$921
							B \$988
							C \$1,105
							D \$1,256
							E \$1,407
							F \$1,642
							G \$1,893
							H \$2,161
							I \$2,580
							J \$3,085

Features:

- for use with 90”w storage overhead cabinet
- use with 48”h overhead cabinets
- attaches to cabinet interior, mounting hardware included
- com ydg: 2 3/4

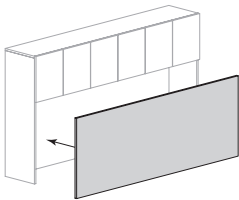
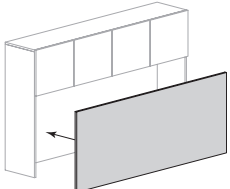
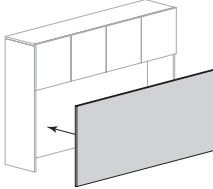
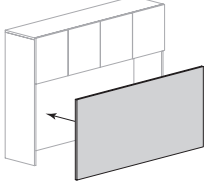
Description	D	W	H	CTN WT	CU FT	① Model	List Price Per Grade
84" w Tackboard for Overhead Cabinet 	13 1/16	82 1/4	30	29	5	FLB8330TK	COM \$843 A \$873 B \$933 C \$1,041 D \$1,178 E \$1,316 F \$1,528 G \$1,757 H \$2,001 I \$2,384 J \$2,840
Features: <ul style="list-style-type: none"> for use with 84" w storage overhead cabinet use with 48" h overhead cabinets attaches to cabinet interior, mounting hardware included com ydg: 2 1/2 							
78" w Tackboard for Overhead Cabinet 	13 1/16	76 1/4	30	27	5	FLB7730TK	COM \$797 A \$830 B \$888 C \$997 D \$1,134 E \$1,270 F \$1,484 G \$1,713 H \$1,957 I \$2,337 J \$2,797
Features: <ul style="list-style-type: none"> for use with 78" w storage overhead cabinet use with 48" h overhead cabinets attaches to cabinet interior, mounting hardware included com ydg: 2 1/2 							
72" w Tackboard for Overhead Cabinet 	13 1/16	70 1/4	30	25	4	FLB7130TK	COM \$754 A \$783 B \$837 C \$933 D \$1,057 E \$1,181 F \$1,372 G \$1,579 H \$1,797 I \$2,141 J \$2,552
Features: <ul style="list-style-type: none"> for use with 72" w storage overhead cabinet use with 48" h overhead cabinets attaches to cabinet interior, mounting hardware included com ydg: 2 1/4 							
66" w Tackboard for Overhead Cabinet 	13 1/16	64 1/4	30	23	4	FLB6530TK	COM \$710 A \$734 B \$783 C \$869 D \$978 E \$1,088 F \$1,258 G \$1,442 H \$1,636 I \$1,942 J \$2,309
Features: <ul style="list-style-type: none"> for use with 66" w storage overhead cabinet use with 48" h overhead cabinets attaches to cabinet interior, mounting hardware included com ydg: 2 							

FLUX - PRIVATE OFFICE

To Order, Specify:

① Model Number	② Fabric Selection
(FLB)	Vendor Pattern Color Visit www.jsifurniture.com/finishes-and-materials/textiles for our textiles program. See selection of standard and graded in manufacturers and patterns.

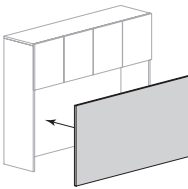
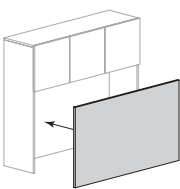
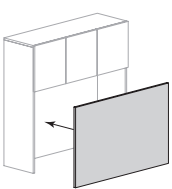
Description	D	W	H	CTN WT	CU FT	① Model	List Price Per Grade	
60" w Tackboard for Overhead Cabinet 	$1\frac{3}{16}$	58 $\frac{1}{4}$	30	21	4	FLB5930TK	COM \$667	
	Features:							A \$690
	· for use with 60" w storage overhead cabinet							B \$740
	· use with 48" h overhead cabinets							C \$825
	· attaches to cabinet interior, mounting hardware included							D \$934
	· com ydg: 2							E \$1,044
								F \$1,216
								G \$1,401
								H \$1,593
								I \$1,898
							J \$2,264	
54" w Tackboard for Overhead Cabinet 	$1\frac{3}{16}$	52 $\frac{1}{4}$	30	19	3	FLB5330TK	COM \$621	
	Features:							A \$645
	· for use with 54" w storage overhead cabinet							B \$686
	· use with 48" h overhead cabinets							C \$760
	· attaches to cabinet interior, mounting hardware included							D \$857
	· com ydg: 1 $\frac{3}{4}$							E \$955
								F \$1,103
								G \$1,261
								H \$1,434
								I \$1,700
							J \$2,020	
48" w Tackboard for Overhead Cabinet 	$1\frac{3}{16}$	46 $\frac{1}{4}$	30	17	3	FLB4730TK	COM \$578	
	Features:							A \$597
	· for use with 48" w storage overhead cabinet							B \$631
	· use with 48" h overhead cabinets							C \$696
	· attaches to cabinet interior, mounting hardware included							D \$779
	· com ydg: 1 $\frac{1}{2}$							E \$861
								F \$991
								G \$1,125
								H \$1,273
								I \$1,503
							J \$1,777	

FLUX - PRIVATE OFFICE

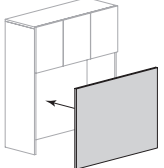
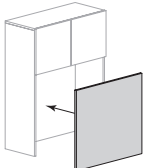
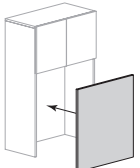
Description	D	W	H	CTN WT	CU FT	① Model	List Price Per Grade	
42" w Tackboard for Overhead Cabinet 	13 1/16	40 1/4	30	15	3	FLB4130TK	COM \$535	
	Features:							A \$554
	· for use with 42" w storage overhead cabinet							B \$589
	· use with 48" h overhead cabinets							C \$653
	· attaches to cabinet interior, mounting hardware included							D \$736
	· com ydg: 1 1/2							E \$817
								F \$947
								G \$1,083
								H \$1,229
								I \$1,457
								J \$1,734
	36" w Tackboard for Overhead Cabinet 	13 1/16	34 1/4	30	12	2	FLB3530TK	COM \$489
		Features:						
· for use with 36" w storage overhead cabinet							B \$536	
· use with 48" h overhead cabinets							C \$589	
· attaches to cabinet interior, mounting hardware included							D \$659	
· com ydg: 1 1/4							E \$727	
							F \$834	
							G \$948	
							H \$1,070	
							I \$1,259	
							J \$1,489	
30" w Tackboard for Overhead Cabinet 		13 1/16	28 1/4	30	10	2	FLB2930TK	COM \$444
		Features:						
	· for use with 30" w storage overhead cabinet							B \$481
	· use with 48" h overhead cabinets							C \$524
	· attaches to cabinet interior, mounting hardware included							D \$580
	· com ydg: 1							E \$634
								F \$720
								G \$812
								H \$909
								I \$1,062
								J \$1,245

FLUX - PRIVATE OFFICE

To Order, Specify:

① Model Number	② Fabric Selection	
(FLB)	Vendor Pattern Color	Visit www.jsifurniture.com/finishes-and-materials/textiles for our textiles program. See selection of standard and graded in manufacturers and patterns.

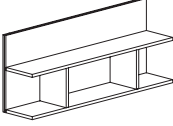
Description	D	W	H	CTN WT	CU FT	① Model	Laminate	Flat Cut Veneer	Double Cut Veneer
Double Height Wall Mount Overhead Shelf 	15	96	29	174	30	FLT1596-29WMS	\$1,508		
	15	96	29	174	30	FLV1596-29WMS		\$2,316	\$2,548
	15	90	29	164	29	FLT1590-29WMS	\$1,435		
	15	90	29	164	29	FLV1590-29WMS		\$2,205	\$2,428
	15	84	29	154	27	FLT1584-29WMS	\$1,378		
	15	84	29	154	27	FLV1584-29WMS		\$2,117	\$2,330
	15	78	29	144	25	FLT1578-29WMS	\$1,323		
	15	78	29	144	25	FLV1578-29WMS		\$2,034	\$2,237
	15	72	29	135	23	FLT1572-29WMS	\$1,084		
	15	72	29	135	23	FLV1572-29WMS		\$1,667	\$1,831
	15	66	29	125	21	FLT1566-29WMS	\$1,041		
	15	66	29	125	21	FLV1566-29WMS		\$1,599	\$1,758
	15	60	29	115	19	FLT1560-29WMS	\$999		
	15	60	29	115	19	FLV1560-29WMS		\$1,535	\$1,690
	15	54	29	105	18	FLT1554-29WMS	\$960		
	15	54	29	105	18	FLV1554-29WMS		\$1,475	\$1,623
	15	48	29	95	16	FLT1548-29WMS	\$923		
15	48	29	95	16	FLV1548-29WMS		\$1,415	\$1,557	
15	42	29	85	14	FLT1542-29WMS	\$885			
15	42	29	85	14	FLV1542-29WMS		\$1,361	\$1,495	

Features:

- supported by wall cleat - hardware provided by installer
- laminate grain direction runs horizontal on back panel of shelf

Options:

- must specify chassis grain direction on double cut veneer, see pages 11-13 for details

Description	D	W	H	CTN WT	CU FT	① Model	Laminate	Flat Cut Veneer	Double Cut Veneer
Double Height Wall Mount Overhead Shelf	15	36	29	70	12	FLT1536-29WMS	\$790		
	15	36	29	70	12	FLV1536-29WMS		\$1,213	\$1,334
	15	30	29	60	10	FLT1530-29WMS	\$758		
	15	30	29	60	10	FLV1530-29WMS		\$1,165	\$1,282

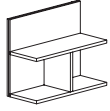

Features:

- supported by wall cleat - hardware provided by installer
- laminate grain direction runs horizontal on back panel of shelf

Options:

- must specify chassis grain direction on double cut veneer, see pages 11-13 for details

To Order, Specify:

① Laminate Model #	② Laminate Selection	③ Metal Color	④ Other Product Options
Laminate (FLT)	See Laminate Selection	See Metal Finish Color Options	See list of options for each specific unit; Specify and add accordingly.

① Veneer Model #	② Wood Species	③ Wood Finish	④ Metal Color	⑤ Other Product Options
Veneer (FLV)	Flat Cut CH1 Cherry MA1 Maple WA1 Walnut BO1 Black Oak	See Flat Cut Wood Finish Options	See Metal Finish Color Options	See list of options for each specific unit; Specify and add accordingly.
		③a Wood Finish See Double Cut Wood Finish Options		

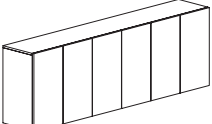
Description	D	W	H	CTN WT	CU FT	Model	Laminate	Flat Cut Veneer	Double Cut Veneer
Wall Mount Double Height Overhead with Six Doors 	15 $\frac{7}{8}$ "	96	29 $\frac{1}{4}$ "	284	32	FLT1696-29WSO	\$2,392		
	15 $\frac{7}{8}$ "	96	29 $\frac{1}{4}$ "	284	32	FLV1696-29WSO		\$4,496	\$4,947
	15 $\frac{7}{8}$ "	90	29 $\frac{1}{4}$ "	269	30	FLT1690-29WSO	\$2,264		
	15 $\frac{7}{8}$ "	90	29 $\frac{1}{4}$ "	269	30	FLV1690-29WSO		\$4,217	\$4,640
	15 $\frac{7}{8}$ "	84	29 $\frac{1}{4}$ "	253	28	FLT1684-29WSO	\$2,144		
	15 $\frac{7}{8}$ "	84	29 $\frac{1}{4}$ "	253	28	FLV1684-29WSO		\$3,934	\$4,328

Features:

- supported by wall cleat - hardware provided by installer
- secure wall attachment required; pilot holes provided in back panel
- laminate grain direction runs horizontal on back panel of overhead cabinets
- 1/4" overhang at the bottom of the door allows access
- adjustable shelves

Options:

- must specify chassis grain direction on double cut veneer, see pages 11-13 for details
- veneer door fronts in paint available, specify paint color and add \$337 list; see page 14 for details
- on laminate units, contrasting laminate door fronts available, no upcharge; specify laminate color, see page 14 for details
- white glass doors with aluminum trim available, specify and add \$4,488 list for 96"w, \$4,299 list for 90"w, \$4,137 list for 84"w; see page 31 for details
- markerboard laminate doors available, specify and add \$1,144 list; see page 31 for details
- locking doors available, specify and add \$414 list (not available on glass doors)

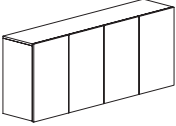
Wall Mount Double Height Overhead with Four Doors 	15 $\frac{7}{8}$ "	78	29 $\frac{1}{4}$ "	230	26	FLT1678-29WSO	\$2,098		
	15 $\frac{7}{8}$ "	78	29 $\frac{1}{4}$ "	230	26	FLV1678-29WSO		\$3,656	\$4,022
	15 $\frac{7}{8}$ "	72	29 $\frac{1}{4}$ "	215	24	FLT1672-29WSO	\$1,985		
	15 $\frac{7}{8}$ "	72	29 $\frac{1}{4}$ "	215	24	FLV1672-29WSO		\$3,375	\$3,712
	15 $\frac{7}{8}$ "	66	29 $\frac{1}{4}$ "	199	22	FLT1666-29WSO	\$1,879		
	15 $\frac{7}{8}$ "	66	29 $\frac{1}{4}$ "	199	22	FLV1666-29WSO		\$3,226	\$3,550
	15 $\frac{7}{8}$ "	60	29 $\frac{1}{4}$ "	190	21	FLT1660-29WSO	\$1,793		
	15 $\frac{7}{8}$ "	60	29 $\frac{1}{4}$ "	190	21	FLV1660-29WSO		\$3,069	\$3,377

Features:

- supported by wall cleat - hardware provided by installer
- secure wall attachment required; pilot holes provided in back panel
- laminate grain direction runs horizontal on back panel of overhead cabinets
- 1/4" overhang at the bottom of the door allows access
- adjustable shelves

Options:

- must specify chassis grain direction on double cut veneer, see pages 11-13 for details
- veneer door fronts in paint available, specify paint color and add \$337 list; see page 14 for details
- on laminate units, contrasting laminate door fronts available, no upcharge; specify laminate color, see page 14 for details
- white glass doors with aluminum trim available, specify and add \$3,437 list for 78"w, \$3,247 list for 72"w, \$3,058 list for 66"w, \$2,869 list for 60"w; see page 31 for details
- markerboard laminate doors available, specify and add \$763 list; see page 31 for details
- locking doors available, specify and add \$276 list (not available on glass doors)

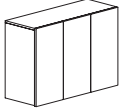
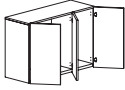
Description	D	W	H	CTN WT	CU FT	① Model	Laminate	Flat Cut Veneer	Double Cut Veneer
Wall Mount Double Height Overhead with Three Doors   right shown	15 7/8	54	29 1/4	173	19	FLT1654-29WSOR	\$1,685		
	15 7/8	54	29 1/4	173	19	FLV1654-29WSOR		\$2,767	\$3,046
	15 7/8	54	29 1/4	173	19	FLT1654-29WSOL	\$1,685		
	15 7/8	54	29 1/4	173	19	FLV1654-29WSOL		\$2,767	\$3,046
	15 7/8	48	29 1/4	157	17	FLT1648-29WSOR	\$1,445		
	15 7/8	48	29 1/4	157	17	FLV1648-29WSOR		\$2,424	\$2,667
	15 7/8	48	29 1/4	157	17	FLT1648-29WSOL	\$1,445		
	15 7/8	48	29 1/4	157	17	FLV1648-29WSOL		\$2,424	\$2,667
	15 7/8	42	29 1/4	141	15	FLT1642-29WSOR	\$1,372		
	15 7/8	42	29 1/4	141	15	FLV1642-29WSOR		\$2,224	\$2,447
	15 7/8	42	29 1/4	141	15	FLT1642-29WSOL	\$1,372		
	15 7/8	42	29 1/4	141	15	FLV1642-29WSOL		\$2,224	\$2,447

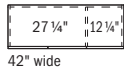
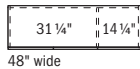
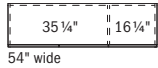

Features:

- supported by wall cleat - hardware provided by installer
- secure wall attachment required; pilot holes provided in back panel
- laminate grain direction runs horizontal on back panel of overhead cabinets
- 1/4" overhang at the bottom of the door allows access
- adjustable shelves

Options:

- must specify chassis grain direction on double cut veneer, see pages 11-13 for details
- veneer door fronts in paint available, specify paint color and add \$337 list; see page 14 for details
- on laminate units, contrasting laminate door fronts available, no upcharge; specify laminate color, see page 14 for details
- white glass doors with aluminum trim available, specify and add \$2,436 list for 54"w, \$2,246 list for 48"w, \$2,058 list for 42"w; see page 31 for details
- markerboard laminate doors available, specify and add \$560 list; see page 31 for details
- locking doors available, specify and add \$276 list (not available on glass doors)

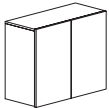
Wall Mount Double Height Overhead with Two Doors 	15 7/8	36	29 1/4	114	13	FLT1636-29WSO	\$1,194		
	15 7/8	36	29 1/4	114	13	FLV1636-29WSO		\$2,085	\$2,294
	15 7/8	30	29 1/4	99	11	FLT1630-29WSO	\$1,137		
	15 7/8	30	29 1/4	99	11	FLV1630-29WSO		\$1,986	\$2,187

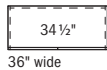
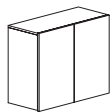

Features:

- supported by wall cleat - hardware provided by installer
- secure wall attachment required; pilot holes provided in back panel
- laminate grain direction runs horizontal on back panel of overhead cabinets
- 1/4" overhang at the bottom of the door allows access
- adjustable shelves

Options:

- must specify chassis grain direction on double cut veneer, see pages 11-13 for details
- veneer door fronts in paint available, specify paint color and add \$337 list; see page 14 for details
- on laminate units, contrasting laminate door fronts available, no upcharge; specify laminate color, see page 14 for details
- white glass doors with aluminum trim available, specify and add \$1,626 list for 36"w, \$1,437 list for 30"w; see page 31 for details
- markerboard laminate doors available, specify and add \$385 list; see page 31 for details
- locking doors available, specify and add \$138 list (not available on glass doors)

To Order, Specify:

① Laminate Model #	② Laminate Selection	③ Metal Color	④ Other Product Options
Laminate (FLT)	See Laminate Selection	See Metal Finish Color Options	See list of options for each specific unit; Specify and add accordingly.

① Veneer Model #	② Wood Species	③ Wood Finish	④ Metal Color	⑤ Other Product Options
Veneer (FLV)	Flat Cut CH1 Cherry MA1 Maple WA1 Walnut BO1 Black Oak	See Flat Cut Wood Finish Options	See Metal Finish Color Options	See list of options for each specific unit; Specify and add accordingly.
	Double Cut DC1 Double Cut	ⓐ Wood Finish See Double Cut Wood Finish Options		

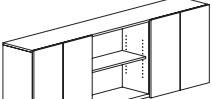
Description	D	W	H	CTN WT	CU FT	① Model	Laminate	Flat Cut Veneer	Double Cut Veneer
Wall Mount Double Height Overhead with Four Doors and Open Center 	15 7/8	96	29 1/4	264	32	FLT1696-29WSMO	\$2,371		
	15 7/8	96	29 1/4	264	32	FLV1696-29WSMO		\$3,882	\$4,269
	15 7/8	90	29 1/4	250	30	FLT1690-29WSMO	\$2,231		
	15 7/8	90	29 1/4	250	30	FLV1690-29WSMO		\$3,649	\$4,015
	15 7/8	84	29 1/4	236	28	FLT1684-29WSMO	\$2,085		
	15 7/8	84	29 1/4	236	28	FLV1684-29WSMO		\$3,416	\$3,758

Features:

- supported by wall cleat - hardware provided by installer
- secure wall attachment required; pilot holes provided in back panel
- laminate grain direction runs horizontal on back panel of overhead cabinets
- 1/4" overhang at the bottom of the door allows access
- adjustable shelves

Options:

- must specify chassis grain direction on double cut veneer, see pages 11-13 for details
- veneer door fronts in paint available, specify paint color and add \$337 list; see page 14 for details
- on laminate units, contrasting laminate door fronts available, no upcharge; specify laminate color, see page 14 for details
- white glass doors with aluminum trim available, specify and add \$2,995 list for 96"w, \$2,869 list for 90"w, \$2,743 list for 84"w; see page 31 for details
- markerboard laminate doors available, specify and add \$763 list; see page 31 for details
- locking doors available, specify and add \$276 list (not available on glass doors)

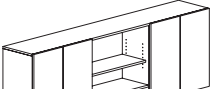
Wall Mount Double Height Overhead Cabinet with Four Doors, Open Center and Cubbies 	15 7/8	96	29 1/4	275	32	FLT1696-29WSMOCC	\$2,495		
	15 7/8	96	29 1/4	275	32	FLV1696-29WSMOCC		\$4,059	\$4,465
	15 7/8	90	29 1/4	260	30	FLT1690-29WSMOCC	\$2,353		
	15 7/8	90	29 1/4	260	30	FLV1690-29WSMOCC		\$3,829	\$4,210
	15 7/8	84	29 1/4	245	28	FLT1684-29WSMOCC	\$2,208		
	15 7/8	84	29 1/4	245	28	FLV1684-29WSMOCC		\$3,593	\$3,954

Features:

- supported by wall cleat - hardware provided by installer
- secure wall attachment required; pilot holes provided in back panel
- laminate grain direction runs horizontal on back panel of overhead cabinets
- 1/4" overhang at the bottom of the door allows access
- adjustable shelves

Options:

- must specify chassis grain direction on double cut veneer, see pages 11-13 for details
- veneer door fronts in paint available, specify paint color and add \$337 list; see page 14 for details
- on laminate units, contrasting laminate door fronts available, no upcharge; specify laminate color, see page 14 for details
- white glass doors with aluminum trim available, specify and add \$2,995 list for 96"w, \$2,869 list for 90"w, \$2,743 list for 84"w; see page 31 for details
- markerboard laminate doors available, specify and add \$763 list; see page 31 for details
- locking doors available, specify and add \$276 list (not available on glass doors)

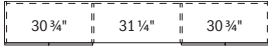

96" wide

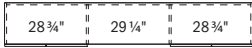

90" wide

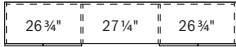

84" wide

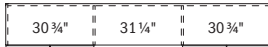

96" wide



90" wide

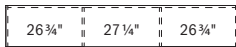

84" wide

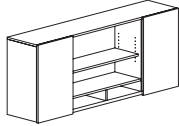
Description	D	W	H	CTN WT	CU FT	① Model	Laminate	Flat Cut Veneer	Double Cut Veneer
Wall Mount Double Height Overhead Cabinet with Two Doors, Open Center and Cubbies 	15 7/8	78	29 1/4	226	26	FLT1678-29WSMOCC	\$2,071		
	15 7/8	78	29 1/4	226	26	FLV1678-29WSMOCC		\$3,265	\$3,591
	15 7/8	72	29 1/4	211	24	FLT1672-29WSMOCC	\$1,959		
	15 7/8	72	29 1/4	211	24	FLV1672-29WSMOCC		\$3,090	\$3,399
	15 7/8	66	29 1/4	197	22	FLT1666-29WSMOCC	\$1,862		
	15 7/8	66	29 1/4	197	22	FLV1666-29WSMOCC		\$2,935	\$3,227
	15 7/8	60	29 1/4	187	21	FLT1660-29WSMOCC	\$1,788		
	15 7/8	60	29 1/4	187	21	FLV1660-29WSMOCC		\$2,820	\$3,099

Features:

- supported by wall cleat - hardware provided by installer
- secure wall attachment required; pilot holes provided in back panel
- laminate grain direction runs horizontal on back panel of overhead cabinets
- 1/4" overhang at the bottom of the door allows access
- adjustable shelves

Options:

- must specify chassis grain direction on double cut veneer, see pages 11-13 for details
- veneer door fronts in paint available, specify paint color and add \$337 list; see page 14 for details
- on laminate units, contrasting laminate door fronts available, no upcharge; specify laminate color, see page 14 for details
- white glass doors with aluminum trim available, specify and add \$1,720 list for 78"w, \$1,626 list for 72"w, \$1,531 list for 66"w, \$1,437 list for 60"w; see page 31 for details
- markerboard laminate doors available, specify and add \$385 list; see page 31 for details
- locking doors available, specify and add \$276 list (not available on glass doors)

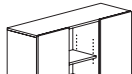
Wall Mount Double Height Overhead Cabinet with 2 Doors, Open Center and Cubbies 	15 7/8	54	29 1/4	174	19	FLT1654-29WSMOCC	\$1,751		
	15 7/8	54	29 1/4	174	19	FLV1654-29WSMOCC		\$2,718	\$2,989
	15 7/8	48	29 1/4	159	17	FLT1648-29WSMOCC	\$1,699		
	15 7/8	48	29 1/4	159	17	FLV1648-29WSMOCC		\$2,636	\$2,899
	15 7/8	42	29 1/4	143	15	FLT1642-29WSMOCC	\$1,648		
	15 7/8	42	29 1/4	143	15	FLV1642-29WSMOCC		\$2,560	\$2,815

Features:

- supported by wall cleat - hardware provided by installer
- secure wall attachment required; pilot holes provided in back panel
- laminate grain direction runs horizontal on back panel of overhead cabinets
- 1/4" overhang at the bottom of the door allows access
- adjustable shelves

Options:

- must specify chassis grain direction on double cut veneer, see pages 11-13 for details
- veneer door fronts in paint available, specify paint color and add \$337 list; see page 14 for details
- on laminate units, contrasting laminate door fronts available, no upcharge; specify laminate color, see page 14 for details
- white glass doors with aluminum trim available, specify and add \$1,586 list for 54"w, \$1,462 list for 48"w, \$1,338 list for 42"w; see page 31 for details
- markerboard laminate doors available, specify and add \$385 list; see page 31 for details
- locking doors available, specify and add \$276 list (not available on glass doors)

To Order, Specify:

① Laminate Model #	② Laminate Selection	③ Metal Color	④ Other Product Options
Laminate (FLT)	See Laminate Selection	See Metal Finish Color Options	See list of options for each specific unit; Specify and add accordingly.

① Veneer Model #	② Wood Species	③ Wood Finish	④ Metal Color	⑤ Other Product Options
Veneer (FLV)	Flat Cut CH1 Cherry MA1 Maple WA1 Walnut BO1 Black Oak	See Flat Cut Wood Finish Options	See Metal Finish Color Options	See list of options for each specific unit; Specify and add accordingly.
		3a Wood Finish See Double Cut Wood Finish Options		
	Double Cut DC1 Double Cut			

Description	D	W	H	CTN WT	CU FT	① Model	Laminate	Flat Cut Veneer	Double Cut Veneer
Wall Mount Double Height Overhead with Two Doors and Open Compartment	15 7/8	78	29 1/4	206	26	FLT1678-29WSMOR	\$1,948		
	15 7/8	78	29 1/4	206	26	FLV1678-29WSMOR		\$3,087	\$3,395
	15 7/8	78	29 1/4	206	26	FLT1678-29WSMOL	\$1,948		
	15 7/8	78	29 1/4	206	26	FLV1678-29WSMOL		\$3,087	\$3,395
	15 7/8	72	29 1/4	192	24	FLT1672-29WSMOR	\$1,836		
	15 7/8	72	29 1/4	192	24	FLV1672-29WSMOR		\$2,911	\$3,203
	15 7/8	72	29 1/4	192	24	FLT1672-29WSMOL	\$1,836		
	15 7/8	72	29 1/4	192	24	FLV1672-29WSMOL		\$2,911	\$3,203
	15 7/8	66	29 1/4	179	22	FLT1666-29WSMOR	\$1,740		
	15 7/8	66	29 1/4	179	22	FLV1666-29WSMOR		\$2,758	\$3,033
	15 7/8	66	29 1/4	179	22	FLT1666-29WSMOL	\$1,740		
	15 7/8	66	29 1/4	179	22	FLV1666-29WSMOL		\$2,758	\$3,033
	15 7/8	60	29 1/4	170	21	FLT1660-29WSMOR	\$1,667		
	15 7/8	60	29 1/4	170	21	FLV1660-29WSMOR		\$2,641	\$2,905
	15 7/8	60	29 1/4	170	21	FLT1660-29WSMOL	\$1,667		
	15 7/8	60	29 1/4	170	21	FLV1660-29WSMOL		\$2,641	\$2,905

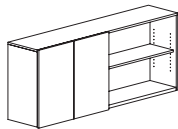

left shown

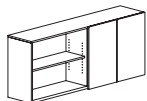

right

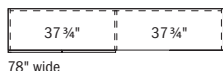

78" wide

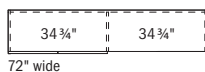

72" wide

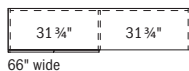

66" wide

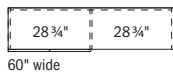

60" wide

Features:

- supported by wall cleat - hardware provided by installer
- secure wall attachment required; pilot holes provided in back panel
- laminate grain direction runs horizontal on back panel of overhead cabinets
- 1/4" overhang at the bottom of the door allows access
- adjustable shelves

Options:

- must specify chassis grain direction on double cut veneer, see pages 11-13 for details
- veneer door fronts in paint available, specify paint color and add \$337 list; see page 14 for details
- on laminate units, contrasting laminate door fronts available, no upcharge; specify laminate color, see page 14 for details
- white glass doors with aluminum trim available, specify and add \$1,720 list for 78"w, \$1,626 list for 72"w, \$1,531 list for 66"w, \$1,437 list for 60"w; see page 31 for details
- markerboard laminate doors available, specify and add \$385 list; see page 31 for details
- locking doors available, specify and add \$138 list (not available on glass doors)

Description	D	W	H	CTN WT	CU FT	① Model	Laminate	Flat Cut Veneer	Double Cut Veneer
Wall Mount Double Height Overhead with Two Doors and Open Center	15 7/8"	54"	29 1/4"	169	19	FLT1654-29WSMO	\$1,628		
	15 7/8"	54"	29 1/4"	169	19	FLV1654-29WSMO		\$2,540	\$2,795
	15 7/8"	48"	29 1/4"	154	17	FLT1648-29WSMO	\$1,576		
	15 7/8"	48"	29 1/4"	154	17	FLV1648-29WSMO		\$2,457	\$2,704
	15 7/8"	42"	29 1/4"	139	15	FLT1642-29WSMO	\$1,525		
	15 7/8"	42"	29 1/4"	139	15	FLV1642-29WSMO		\$2,383	\$2,619

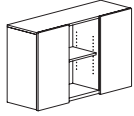

54" wide



48" wide



42" wide

Features:

- supported by wall cleat - hardware provided by installer
- secure wall attachment required; pilot holes provided in back panel
- laminate grain direction runs horizontal on back panel of overhead cabinets
- 1/4" overhang at the bottom of the door allows access
- adjustable shelves

Options:

- must specify chassis grain direction on double cut veneer, see pages 11-13 for details
- veneer door fronts in paint available, specify paint color and add \$337 list; see page 14 for details
- on laminate units, contrasting laminate door fronts available, no upcharge; specify laminate color, see page 14 for details
- white glass doors with aluminum trim available, specify and add \$2,436 list for 54"w, \$2,246 list for 48"w, \$2,058 list for 42"w; see page 31 for details
- markerboard laminate doors available, specify and add \$385 list; see page 31 for details
- locking doors available, specify and add \$276 list (not available on glass doors)

To Order, Specify:

① Laminate Model #	② Laminate Selection	③ Metal Color	④ Other Product Options
Laminate (FLT)	See Laminate Selection	See Metal Finish Color Options	See list of options for each specific unit; Specify and add accordingly.

① Veneer Model #	② Wood Species	③ Wood Finish	④ Metal Color	⑤ Other Product Options
Veneer (FLV)	Flat Cut CH1 Cherry MA1 Maple WA1 Walnut BO1 Black Oak	See Flat Cut Wood Finish Options	See Metal Finish Color Options	See list of options for each specific unit; Specify and add accordingly.
		③a Wood Finish See Double Cut Wood Finish Options		

Description	D	W	H	CTN WT	CU FT	① Model	Laminate	Flat Cut Veneer	Double Cut Veneer
Wall Mount Double Height Overhead Cabinet Sliding Door	15 15/16	96	29 1/4	276	32	FLT1696-29WSD	\$2,723		
	15 15/16	96	29 1/4	276	32	FLV1696-29WSD		\$4,461	\$4,906
	15 15/16	90	29 1/4	261	30	FLT1690-29WSD	\$2,562		
	15 15/16	90	29 1/4	261	30	FLV1690-29WSD		\$4,195	\$4,615
	15 15/16	84	29 1/4	246	28	FLT1684-29WSD	\$2,395		
	15 15/16	84	29 1/4	246	28	FLV1684-29WSD		\$3,924	\$4,319

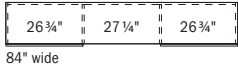
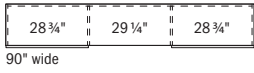
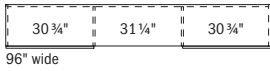
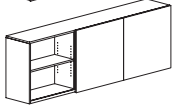
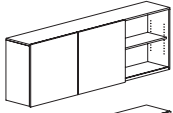
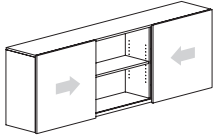

Features:

- supported by wall cleat - hardware provided by installer
- secure wall attachment required; pilot holes provided in back panel
- laminate grain direction runs horizontal on back panel of overhead cabinets
- locking not available
- adjustable shelves

Options:

- must specify chassis grain direction on double cut veneer, see pages 11-13 for details
- veneer door fronts in paint available, specify paint color and add \$337 list; see page 14 for details
- on laminate units, contrasting laminate door fronts available, no upcharge; specify laminate color, see page 14 for details
- white glass doors with aluminum trim available, specify and add \$2,626 list for 96" w, \$2,498 list for 90" w, \$2,372 list for 84" w; see page 31 for details
- markerboard laminate doors available, specify and add \$569 list; see page 31 for details

Wall Mount Double Height Overhead Cabinet Sliding Door	15 15/16	78	29 1/4	214	26	FLT1678-29WSD	\$2,238		
	15 15/16	78	29 1/4	214	26	FLV1678-29WSD		\$3,546	\$3,902
	15 15/16	72	29 1/4	200	25	FLT1672-29WSD	\$2,110		
	15 15/16	72	29 1/4	200	25	FLV1672-29WSD		\$3,346	\$3,681
	15 15/16	66	29 1/4	185	23	FLT1666-29WSD	\$1,998		
	15 15/16	66	29 1/4	185	23	FLV1666-29WSD		\$3,168	\$3,483
	15 15/16	60	29 1/4	178	21	FLT1660-29WSD	\$1,915		
	15 15/16	60	29 1/4	178	21	FLV1660-29WSD		\$3,033	\$3,338

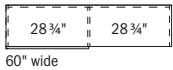
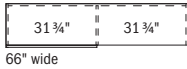
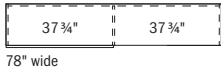
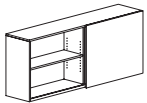
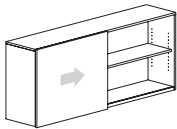

Features:

- supported by wall cleat - hardware provided by installer
- secure wall attachment required; pilot holes provided in back panel
- laminate grain direction runs horizontal on back panel of overhead cabinets
- locking not available
- adjustable shelves

Options:

- must specify chassis grain direction on double cut veneer, see pages 11-13 for details
- veneer door fronts in paint available, specify paint color and add \$337 list; see page 14 for details
- on laminate units, contrasting laminate door fronts available, no upcharge; specify laminate color, see page 14 for details
- white glass doors w/ith aluminum trim available, specify and add \$1,535 list for 78" w, \$1,441 list for 72" w, \$1,346 list for 66" w, \$1,216 list for 60" w; see page 31 for details
- markerboard laminate doors available, specify and add \$286 list; see page 31 for details

FLUX - PRIVATE OFFICE

Description	D	W	H	CTN WT	CU FT	① Model	Laminate	Flat Cut Veneer	Double Cut Veneer
Wall Mount Double Height Overhead Cabinet Sliding Door	15 15/16	54	29 1/4	157	19	FLT1654-29WSD	\$1,870		
	15 15/16	54	29 1/4	157	19	FLV1654-29WSD		\$2,919	\$3,211
	15 15/16	48	29 1/4	143	17	FLT1648-29WSD	\$1,809		
	15 15/16	48	29 1/4	143	17	FLV1648-29WSD		\$2,825	\$3,108
	15 15/16	42	29 1/4	129	15	FLT1642-29WSD	\$1,751		
	15 15/16	42	29 1/4	129	15	FLV1642-29WSD		\$2,735	\$3,009

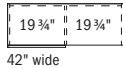
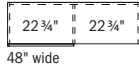
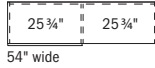
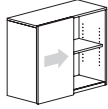

Features:

- supported by wall cleat - hardware provided by installer
- secure wall attachment required; pilot holes provided in back panel
- laminate grain direction runs horizontal on back panel of overhead cabinets
- locking not available
- adjustable shelves

Options:

- must specify chassis grain direction on double cut veneer, see pages 11-13 for details
- veneer door fronts in paint available, specify paint color and add \$337 list; see page 14 for details
- on laminate units, contrasting laminate door fronts available, no upcharge; specify laminate color, see page 14 for details
- white glass doors with aluminum trim available, specify and add \$1,156 list for 54"w, \$1,062 list for 48"w, \$968 list for 42"w; see page 31 for details
- markerboard laminate doors available, specify and add \$286 list; see page 31 for details

Wall Mount Double Height Overhead Cabinet Sliding Door	15 15/16	36	29 1/4	115	13	FLT1636-29WSD	\$1,665		
	15 15/16	36	29 1/4	115	13	FLV1636-29WSD		\$2,598	\$2,858
	15 15/16	30	29 1/4	101	11	FLT1630-29WSD	\$1,598		
	15 15/16	30	29 1/4	101	11	FLV1630-29WSD		\$2,494	\$2,743

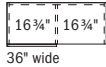
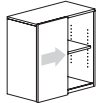

Features:

- supported by wall cleat - hardware provided by installer
- secure wall attachment required; pilot holes provided in back panel
- laminate grain direction runs horizontal on back panel of overhead cabinets
- locking not available
- adjustable shelves

Options:

- must specify chassis grain direction on double cut veneer, see pages 11-13 for details
- veneer door fronts in paint available, specify paint color and add \$337 list; see page 14 for details
- on laminate units, contrasting laminate door fronts available, no upcharge; specify laminate color, see page 14 for details
- white glass doors with aluminum trim available, specify and add \$636 list for 36"w, \$607 list for 30"w; see page 31 for details
- markerboard laminate doors available, specify and add \$286 list; see page 31 for details

To Order, Specify:

① Laminate Model #	② Laminate Selection	③ Metal Color	④ Other Product Options
Laminate (FLT)	See Laminate Selection	See Metal Finish Color Options	See list of options for each specific unit; Specify and add accordingly.

① Veneer Model #	② Wood Species	③ Wood Finish	④ Metal Color	⑤ Other Product Options
Veneer (FLV)	Flat Cut CH1 Cherry MA1 Maple WA1 Walnut BO1 Black Oak	See Flat Cut Wood Finish Options	See Metal Finish Color Options	See list of options for each specific unit; Specify and add accordingly.
		3a Wood Finish See Double Cut Wood Finish Options		

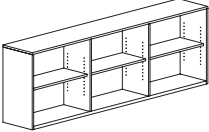
Description	D	W	H	CTN WT	CU FT	Model	Laminate	Flat Cut Veneer	Double Cut Veneer
Wall Mount Double Height Open Overhead 	15	96	29	222	30	FLT1596-29W00	\$2,081		
	15	96	29	222	30	FLV1596-29W00		\$3,914	\$4,304
	15	90	29	210	29	FLT1590-29W00	\$1,972		
	15	90	29	210	29	FLV1590-29W00		\$3,669	\$4,036
	15	84	29	198	27	FLT1584-29W00	\$1,867		
	15	84	29	198	27	FLV1584-29W00		\$3,424	\$3,768

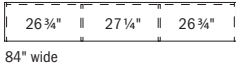
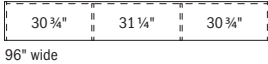

Features:

- supported by wall cleat - hardware provided by installer
- secure wall attachment required; pilot holes provided in back panel
- laminate grain direction runs horizontal on back panel of overhead cabinets
- adjustable shelves

Options:

- must specify chassis grain direction on double cut veneer, see pages 11-13 for details

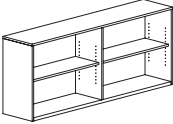
Wall Mount Double Height Open Overhead 	15	78	29	179	25	FLT1578-29W00	\$1,825		
	15	78	29	179	25	FLV1578-29W00		\$3,181	\$3,500
	15	72	29	167	23	FLT1572-29W00	\$1,730		
	15	72	29	167	23	FLV1572-29W00		\$2,936	\$3,229
	15	66	29	155	21	FLT1566-29W00	\$1,634		
	15	66	29	155	21	FLV1566-29W00		\$2,808	\$3,090
	15	60	29	148	19	FLT1560-29W00	\$1,560		
	15	60	29	148	19	FLV1560-29W00		\$2,673	\$2,939

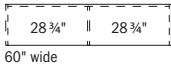
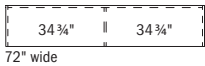
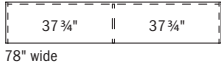

Features:

- supported by wall cleat - hardware provided by installer
- secure wall attachment required; pilot holes provided in back panel
- laminate grain direction runs horizontal on back panel of overhead cabinets
- adjustable shelves

Options:

- must specify chassis grain direction on double cut veneer, see pages 11-13 for details

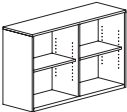
Wall Mount Double Height Open Overhead 	15	54	29	136	18	FLT1554-29W00	\$1,468		
	15	54	29	136	18	FLV1554-29W00		\$2,409	\$2,650
	15	48	29	124	16	FLT1548-29W00	\$1,258		
	15	48	29	124	16	FLV1548-29W00		\$2,110	\$2,321
	15	42	29	112	14	FLT1542-29W00	\$1,195		
	15	42	29	112	14	FLV1542-29W00		\$1,935	\$2,129

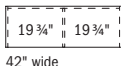
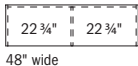
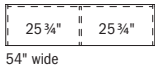

Features:

- supported by wall cleat - hardware provided by installer
- secure wall attachment required; pilot holes provided in back panel
- laminate grain direction runs horizontal on back panel of overhead cabinets
- adjustable shelves

Options:

- must specify chassis grain direction on double cut veneer, see pages 11-13 for details

Description	D	W	H	CTN WT	CU FT	① Model	Laminate	Flat Cut Veneer	Double Cut Veneer
Wall Mount Double Height Open Overhead	15	36	29	89	12	FLT1536-29W00	\$1,040		
	15	36	29	89	12	FLV1536-29W00		\$1,816	\$1,998
	15	30	29	77	10	FLT1530-29W00	\$991		
	15	30	29	77	10	FLV1530-29W00		\$1,731	\$1,902

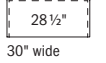
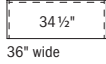
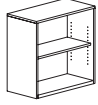

Features:

- supported by wall cleat - hardware provided by installer
- secure wall attachment required; pilot holes provided in back panel
- laminate grain direction runs horizontal on back panel of overhead cabinets
- adjustable shelf

Options:

- must specify chassis grain direction on double cut veneer, see pages 11-13 for details

Overhead Wall Mount Shelf	D	W	H	CTN WT	CU FT	① Model	Laminate	Flat Cut Veneer	Double Cut Veneer
	15	96	17	92	19	FLT1596-17WMS	\$1,078		
15	96	17	92	19	FLV1596-17WMS		\$1,657	\$1,821	
15	90	17	86	18	FLT1590-17WMS	\$1,029			
15	90	17	86	18	FLV1590-17WMS		\$1,578	\$1,736	
15	84	17	81	17	FLT1584-17WMS	\$987			
15	84	17	81	17	FLV1584-17WMS		\$1,514	\$1,667	
15	78	17	75	15	FLT1578-17WMS	\$947			
15	78	17	75	15	FLV1578-17WMS		\$1,453	\$1,599	
15	72	17	69	14	FLT1572-17WMS	\$777			
15	72	17	69	14	FLV1572-17WMS		\$1,189	\$1,308	
15	66	17	64	13	FLT1566-17WMS	\$745			
15	66	17	64	13	FLV1566-17WMS		\$1,144	\$1,257	
15	60	17	58	12	FLT1560-17WMS	\$716			
15	60	17	58	12	FLV1560-17WMS		\$1,099	\$1,209	
15	54	17	52	11	FLT1554-17WMS	\$687			
15	54	17	52	11	FLV1554-17WMS		\$1,054	\$1,161	
15	48	17	47	10	FLT1548-17WMS	\$661			
15	48	17	47	10	FLV1548-17WMS		\$1,011	\$1,113	
15	42	17	41	9	FLT1542-17WMS	\$633			
15	42	17	41	9	FLV1542-17WMS		\$971	\$1,069	
15	36	17	36	8	FLT1536-17WMS	\$608			
15	36	17	36	8	FLV1536-17WMS		\$933	\$1,029	
15	30	17	31	6	FLT1530-17WMS	\$584			
15	30	17	31	6	FLV1530-17WMS		\$895	\$987	



Features:

- supported by wall cleat - hardware provided by installer
- laminate grain direction runs horizontal on back panel of shelf

Options:

- must specify chassis grain direction on double cut veneer, see pages 11-13 for details

To Order, Specify:

① Laminate Model #	② Laminate Selection	③ Metal Color	④ Other Product Options
Laminate (FLT)	See Laminate Selection	See Metal Finish Color Options	See list of options for each specific unit; Specify and add accordingly.

① Veneer Model #	② Wood Species	③ Wood Finish	④ Metal Color	⑤ Other Product Options
Veneer (FLV)	Flat Cut CH1 Cherry MA1 Maple WA1 Walnut BO1 Black Oak	See Flat Cut Wood Finish Options	See Metal Finish Color Options	See list of options for each specific unit; Specify and add accordingly.
		③a Wood Finish See Double Cut Wood Finish Options		

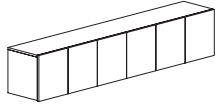
Description	D	W	H	CTN WT	CU FT	Model	Laminate	Flat Cut Veneer	Double Cut Veneer
Wall Mount Overhead Cabinet with Six Doors 	15 7/8	96	17 1/4	184	20	FLT1696-17WSO	\$1,931		
	15 7/8	96	17 1/4	184	20	FLV1696-17WSO		\$3,268	\$3,595
	15 7/8	90	17 1/4	173	19	FLT1690-17WSO	\$1,813		
	15 7/8	90	17 1/4	173	19	FLV1690-17WSO		\$3,070	\$3,379
	15 7/8	84	17 1/4	163	18	FLT1684-17WSO	\$1,695		
	15 7/8	84	17 1/4	163	18	FLV1684-17WSO		\$2,869	\$3,156

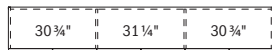

96" wide

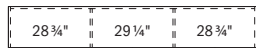

90" wide

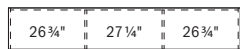

84" wide

Features:

- supported by wall cleat - hardware provided by installer
- secure wall attachment required; pilot holes provided in back panel
- laminate grain direction runs horizontal on back panel of overhead cabinets
- 1/4" overhang at the bottom of the door allows access

Options:

- must specify chassis grain direction on double cut veneer, see pages 11-13 for details
- veneer door fronts in paint available, specify paint color and add \$337 list; see page 14 for details
- on laminate units, contrasting laminate door fronts available, no upcharge; specify laminate color, see page 14 for details
- white glass doors with aluminum trim available, specify and add \$3,348 list; see page 31 for details
- markerboard laminate doors available, specify and add \$1,144 list; see page 31 for details
- locking doors available, specify and add \$426 list (not available on glass doors)

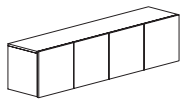
Wall Mount Overhead Cabinet with Four Doors 	15 7/8	78	17 1/4	149	16	FLT1678-17WSO	\$1,580		
	15 7/8	78	17 1/4	149	16	FLV1678-17WSO		\$2,585	\$2,844
	15 7/8	72	17 1/4	139	15	FLT1672-17WSO	\$1,489		
	15 7/8	72	17 1/4	139	15	FLV1672-17WSO		\$2,436	\$2,681
	15 7/8	66	17 1/4	129	14	FLT1666-17WSO	\$1,407		
	15 7/8	66	17 1/4	129	14	FLV1666-17WSO		\$2,304	\$2,532
	15 7/8	60	17 1/4	124	13	FLT1660-17WSO	\$1,344		
	15 7/8	60	17 1/4	124	13	FLV1660-17WSO		\$2,201	\$2,423

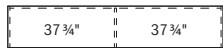

78" wide

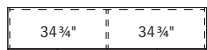

72" wide



66" wide

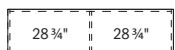

60" wide

Features:

- supported by wall cleat - hardware provided by installer
- secure wall attachment required; pilot holes provided in back panel
- laminate grain direction runs horizontal on back panel of overhead cabinets
- 1/4" overhang at the bottom of the door allows access

Options:

- must specify chassis grain direction on double cut veneer, see pages 11-13 for details
- veneer door fronts in paint available, specify paint color and add \$337 list; see page 14 for details
- on laminate units, contrasting laminate door fronts available, no upcharge; specify laminate color, see page 14 for details
- white glass doors with aluminum trim available, specify and add \$2,373 list for 78"w, \$2,264 list for 72"w, \$2,179 list for 66"w or 60"w; see page 31 for details
- markerboard laminate doors available, specify and add \$763 list; see page 31 for details
- locking doors available, specify and add \$283 list (not available on glass doors)

Description	D	W	H	CTN WT	CU FT	① Model	Laminate	Flat Cut Veneer	Double Cut Veneer
Wall Mount Overhead Cabinet with Three Doors	15 7/8	54	17 1/4	115	12	FLT1654-17WSOR	\$1,316		
	15 7/8	54	17 1/4	115	12	FLV1654-17WSOR		\$2,117	\$2,330
	15 7/8	54	17 1/4	115	12	FLT1654-17WSOL	\$1,316		
	15 7/8	54	17 1/4	115	12	FLV1654-17WSOL		\$2,117	\$2,330
	15 7/8	48	17 1/4	103	10	FLT1648-17WSOR	\$1,270		
	15 7/8	48	17 1/4	103	10	FLV1648-17WSOR		\$2,044	\$2,248
	15 7/8	48	17 1/4	103	10	FLT1648-17WSOL	\$1,270		
	15 7/8	48	17 1/4	103	10	FLV1648-17WSOL		\$2,044	\$2,248
	15 7/8	42	17 1/4	93	9	FLT1642-17WSOR	\$1,229		
	15 7/8	42	17 1/4	93	9	FLV1642-17WSOR		\$1,980	\$2,178
	15 7/8	42	17 1/4	93	9	FLT1642-17WSOL	\$1,229		
	15 7/8	42	17 1/4	93	9	FLV1642-17WSOL		\$1,980	\$2,178

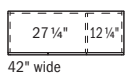
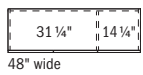
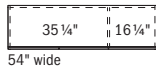
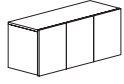

Features:

- supported by wall cleat - hardware provided by installer
- secure wall attachment required; pilot holes provided in back panel
- laminated grain direction runs horizontal on back panel of overhead cabinets
- 1/4" overhang at the bottom of the door allows access

Options:

- must specify chassis grain direction on double cut veneer, see pages 11-13 for details
- veneer door fronts in paint available, specify paint color and add \$337 list; see page 14 for details
- on laminate units, contrasting laminate door fronts available, no upcharge; specify laminate color, see page 14 for details
- white glass doors with aluminum trim available, specify and add \$1,742 list for 54" w, \$1,675 list for 48" w or 42" w; see page 31 for details
- markerboard laminate doors available, specify and add \$560 list; see page 31 for details
- locking doors available, specify and add \$283 list (not available on glass doors)

Description	D	W	H	CTN WT	CU FT	① Model	Laminate	Flat Cut Veneer	Double Cut Veneer
Wall Mount Overhead Cabinet with Two Doors	15 7/8	36	17 1/4	75	8	FLT1636-17WSO	\$1,166		
	15 7/8	36	17 1/4	75	8	FLV1636-17WSO		\$1,877	\$2,065
	15 7/8	30	17 1/4	65	7	FLT1630-17WSO	\$1,119		
	15 7/8	30	17 1/4	65	7	FLV1630-17WSO		\$1,799	\$1,981

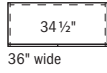
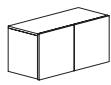

Features:

- supported by wall cleat - hardware provided by installer
- secure wall attachment required; pilot holes provided in back panel
- laminated grain direction runs horizontal on back panel of overhead cabinets
- 1/4" overhang at the bottom of the door allows access

Options:

- must specify chassis grain direction on double cut veneer, see pages 11-13 for details
- veneer door fronts in paint available, specify paint color and add \$337 list; see page 14 for details
- on laminate units, contrasting laminate door fronts available, no upcharge; specify laminate color, see page 14 for details
- white glass doors with aluminum trim available, specify and add \$1,163 list for 36" w, \$1,119 list for 30" w; see page 31 for details
- markerboard laminate doors available, specify and add \$385 list; see page 31 for details
- locking doors available, specify and add \$142 list (not available on glass doors)

To Order, Specify:

① Laminate Model #	② Laminate Selection	③ Metal Color	④ Other Product Options
Laminate (FLT)	See Laminate Selection	See Metal Finish Color Options	See list of options for each specific unit; Specify and add accordingly.

① Veneer Model #	② Wood Species	③ Wood Finish	④ Metal Color	⑤ Other Product Options
Veneer (FLV)	Flat Cut CH1 Cherry MA1 Maple WA1 Walnut BO1 Black Oak	See Flat Cut Wood Finish Options	See Metal Finish Color Options	See list of options for each specific unit; Specify and add accordingly.
		<table border="1"> <thead> <tr> <th>ⓐ Wood Finish</th> <th>ⓑ Chassis Grain Direction</th> </tr> </thead> <tbody> <tr> <td>See Double Cut Wood Finish Options</td> <td>For Double Cut Only: Vertical Horizontal</td> </tr> </tbody> </table>		
ⓐ Wood Finish	ⓑ Chassis Grain Direction			
See Double Cut Wood Finish Options	For Double Cut Only: Vertical Horizontal			

FLUX - PRIVATE OFFICE

Description	D	W	H	CTN WT	CU FT	Model	Laminate	Flat Cut Veneer	Double Cut Veneer
Wall Mount Overhead Cabinet with Four Doors and Open Center	15 7/8	96	17 1/4	172	20	FLT1696-17WSMO	\$1,872		
	15 7/8	96	17 1/4	172	20	FLV1696-17WSMO		\$3,171	\$3,489
	15 7/8	90	17 1/4	162	19	FLT1690-17WSMO	\$1,760		
	15 7/8	90	17 1/4	162	19	FLV1690-17WSMO		\$2,979	\$3,277
	15 7/8	84	17 1/4	153	18	FLT1684-17WSMO	\$1,643		
	15 7/8	84	17 1/4	153	18	FLV1684-17WSMO		\$2,784	\$3,063

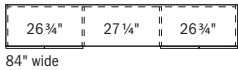
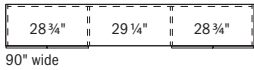
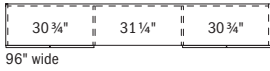
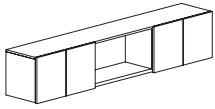

Features:

- supported by wall cleat - hardware provided by installer
- secure wall attachment required; pilot holes provided in back panel
- laminated grain direction runs horizontal on back panel of overhead cabinets
- 1/4" overhang at the bottom of the door allows access

Options:

- must specify chassis grain direction on double cut veneer, see pages 11-13 for details
- veneer door fronts in paint available, specify paint color and add \$337 list; see page 14 for details
- on laminate units, contrasting laminate door fronts available, no upcharge; specify laminate color, see page 14 for details
- white glass doors with aluminum trim available, specify and add \$2,234 list; see page 31 for details
- markerboard laminate doors available, specify and add \$763 list; see page 31 for details
- locking doors available, specify and add \$283 list (not available on glass doors)

Wall Mount Overhead Cabinet with Two Doors and Open Compartment	15 7/8	78	17 1/4	135	16	FLT1678-17WSMOR	\$1,534		
	15 7/8	78	17 1/4	135	16	FLV1678-17WSMOR		\$2,509	\$2,761
	15 7/8	78	17 1/4	135	16	FLT1678-17WSMOL	\$1,534		
	15 7/8	78	17 1/4	135	16	FLV1678-17WSMOL		\$2,509	\$2,761
	15 7/8	72	17 1/4	126	15	FLT1672-17WSMOR	\$1,445		
	15 7/8	72	17 1/4	126	15	FLV1672-17WSMOR		\$2,365	\$2,603
	15 7/8	72	17 1/4	126	15	FLT1672-17WSMOL	\$1,445		
	15 7/8	72	17 1/4	126	15	FLV1672-17WSMOL		\$2,365	\$2,603
	15 7/8	66	17 1/4	117	14	FLT1666-17WSMOR	\$1,365		
	15 7/8	66	17 1/4	117	14	FLV1666-17WSMOR		\$2,234	\$2,457
	15 7/8	66	17 1/4	117	14	FLT1666-17WSMOL	\$1,365		
	15 7/8	66	17 1/4	117	14	FLV1666-17WSMOL		\$2,234	\$2,457
	15 7/8	60	17 1/4	113	13	FLT1660-17WSMOR	\$1,305		
	15 7/8	60	17 1/4	113	13	FLV1660-17WSMOR		\$2,136	\$2,351
	15 7/8	60	17 1/4	113	13	FLT1660-17WSMOL	\$1,305		
		15 7/8	60	17 1/4	113	13	FLV1660-17WSMOL		\$2,136

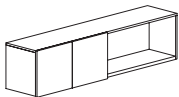

left shown

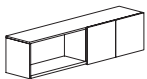

right

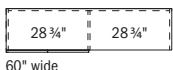
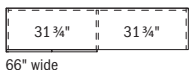
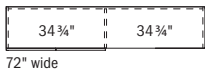
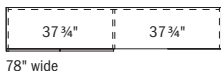

Features:

- supported by wall cleat - hardware provided by installer
- secure wall attachment required; pilot holes provided in back panel
- laminated grain direction runs horizontal on back panel of overhead cabinets
- 1/4" overhang at the bottom of the door allows access

Options:

- must specify chassis grain direction on double cut veneer, see pages 11-13 for details
- veneer door fronts in paint available, specify paint color and add \$337 list; see page 14 for details
- on laminate units, contrasting laminate door fronts available, no upcharge; specify laminate color, see page 14 for details
- white glass doors with aluminum trim available, specify and add \$1,218 list for 78"w, \$1,163 list for 72"w, \$1,119 list for 66"w or 60"w; see page 31 for details
- markerboard laminate doors available, specify and add \$385 list; see page 31 for details
- locking doors available, specify and add \$142 list (not available on glass doors)

Description	D	W	H	CTN WT	CU FT	① Model	Laminate	Flat Cut Veneer	Double Cut Veneer
Wall Mount Overhead Cabinet with Two Doors and Open Center	15 7/8	54	17 1/4	111	12	FLT1654-17WSMO	\$1,278		
	15 7/8	54	17 1/4	111	12	FLV1654-17WSMO		\$2,056	\$2,261
	15 7/8	48	17 1/4	102	10	FLT1648-17WSMO	\$1,233		
	15 7/8	48	17 1/4	102	10	FLV1648-17WSMO		\$1,985	\$2,186
	15 7/8	42	17 1/4	92	9	FLT1642-17WSMO	\$1,194		
	15 7/8	42	17 1/4	92	9	FLV1642-17WSMO		\$1,920	\$2,113

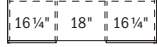
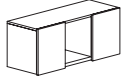

54" wide

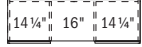

48" wide



42" wide

Features:

- supported by wall cleat - hardware provided by installer
- secure wall attachment required; pilot holes provided in back panel
- laminate grain direction runs horizontal on back panel of overhead cabinets
- 1/4" overhang at the bottom of the door allows access

Options:

- must specify chassis grain direction on double cut veneer, see pages 11-13 for details
- veneer door fronts in paint available, specify paint color and add \$337 list; see page 14 for details
- on laminate units, contrasting laminate door fronts available, no upcharge; specify laminate color, see page 14 for details
- white glass doors with aluminum trim available, specify and add \$1,134 list for 54"w, \$1,091 list for 48"w or 42"w; see page 31 for details
- markerboard laminate doors available, specify and add \$385 list; see page 31 for details
- locking doors available, specify and add \$283 list (not available on glass doors)

To Order, Specify:

① Laminate Model #	② Laminate Selection	③ Metal Color	④ Other Product Options
Laminate (FLT)	See Laminate Selection	See Metal Finish Color Options	See list of options for each specific unit; Specify and add accordingly.

① Veneer Model #	② Wood Species	③ Wood Finish	④ Metal Color	⑤ Other Product Options
Veneer (FLV)	Flat Cut CH1 Cherry MA1 Maple WA1 Walnut BO1 Black Oak	See Flat Cut Wood Finish Options	See Metal Finish Color Options	See list of options for each specific unit; Specify and add accordingly.
		③a Wood Finish See Double Cut Wood Finish Options		

Description	D	W	H	CTN WT	CU FT	Model	Laminate	Flat Cut Veneer	Double Cut Veneer
Wall Mount Overhead Cabinet with Sliding Doors	15 15/16	96	17 1/4	177	20	FLT1696-17WSD	\$2,179		
	15 15/16	96	17 1/4	177	20	FLV1696-17WSD		\$3,567	\$3,923
	15 15/16	90	17 1/4	167	19	FLT1690-17WSD	\$2,050		
	15 15/16	90	17 1/4	167	19	FLV1690-17WSD		\$3,354	\$3,692
	15 15/16	84	17 1/4	158	18	FLT1684-17WSD	\$1,918		
	15 15/16	84	17 1/4	158	18	FLV1684-17WSD		\$3,139	\$3,455

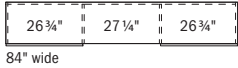
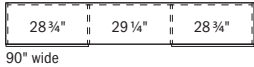
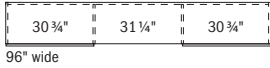
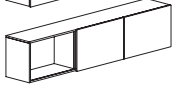
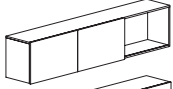
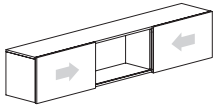

Features:

- supported by wall cleat - hardware provided by installer
- secure wall attachment required; pilot holes provided in back panel
- laminate grain direction runs horizontal on back panel of overhead cabinets
- locking not available

Options:

- must specify chassis grain direction on double cut veneer, see pages 11-13 for details
- veneer door fronts in paint available, specify paint color and add \$337 list; see page 14 for details
- on laminate units, contrasting laminate door fronts available, no upcharge; specify laminate color, see page 14 for details
- white glass doors with aluminum trim available, specify and add \$1,787 list for 96"w, \$1,714 list for 90"w, \$1,639 list for 84"w; see page 31 for details
- markerboard laminate doors available, specify and add \$569 list; see page 31 for details

Wall Mount Overhead Cabinet with Sliding Door	15 15/16	78	17 1/4	138	16	FLT1678-17WSD	\$1,789		
	15 15/16	78	17 1/4	138	16	FLV1678-17WSD		\$2,837	\$3,122
	15 15/16	72	17 1/4	129	15	FLT1672-17WSD	\$1,690		
	15 15/16	72	17 1/4	129	15	FLV1672-17WSD		\$2,678	\$2,945
	15 15/16	66	17 1/4	120	14	FLT1666-17WSD	\$1,599		
	15 15/16	66	17 1/4	120	14	FLV1666-17WSD		\$2,534	\$2,790
	15 15/16	60	17 1/4	111	13	FLT1660-17WSD	\$1,531		
	15 15/16	60	17 1/4	111	13	FLV1660-17WSD		\$2,428	\$2,672

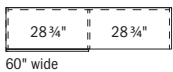
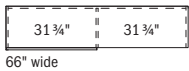
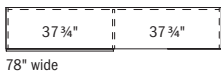
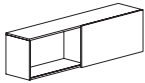
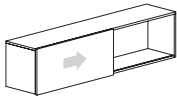

Features:

- supported by wall cleat - hardware provided by installer
- secure wall attachment required; pilot holes provided in back panel
- laminate grain direction runs horizontal on back panel of overhead cabinets
- locking not available

Options:

- must specify chassis grain direction on double cut veneer, see pages 11-13 for details
- veneer door fronts in paint available, specify paint color and add \$337 list; see page 14 for details
- on laminate units, contrasting laminate door fronts available, no upcharge; specify laminate color, see page 14 for details
- white glass doors with aluminum trim available, specify and add \$1,029 list for 78"w, \$971 list for 72"w, \$916 list for 66"w \$858 list for 60"w; see page 31 for details
- markerboard laminate doors available, specify and add \$286 list; see page 31 for details

Description	D	W	H	CTN WT	CU FT	① Model	Laminate	Flat Cut Veneer	Double Cut Veneer
Wall Mount Overhead Cabinet with Sliding Door	15 15/16	54	17 1/4	102	12	FLT1654-17WSD	\$1,496		
	15 15/16	54	17 1/4	102	12	FLV1654-17WSD		\$2,334	\$2,569
	15 15/16	48	17 1/4	92	10	FLT1648-17WSD	\$1,448		
	15 15/16	48	17 1/4	92	10	FLV1648-17WSD		\$2,260	\$2,487
	15 15/16	42	17 1/4	83	9	FLT1642-17WSD	\$1,404		
	15 15/16	42	17 1/4	83	9	FLV1642-17WSD		\$2,188	\$2,406

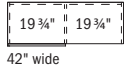
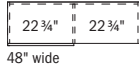
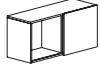
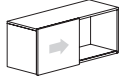

Features:

- supported by wall cleat - hardware provided by installer
- secure wall attachment required; pilot holes provided in back panel
- laminated grain direction runs horizontal on back panel of overhead cabinets
- locking not available

Options:

- must specify chassis grain direction on double cut veneer, see pages 11-13 for details
- veneer door fronts in paint available, specify paint color and add \$337 list; see page 14 for details
- on laminate units, contrasting laminate door fronts available, no upcharge; specify laminate color, see page 14 for details
- white glass doors with aluminum trim available, specify and add \$803 list for 54" w, \$778 list for 48" w, \$748 list for 42" w; see page 31 for details
- markerboard laminate doors available, specify and add \$286 list; see page 31 for details

Wall Mount Overhead Cabinet with Sliding Door	15 15/16	36	17 1/4	74	8	FLT1636-17WSD	\$1,331		
	15 15/16	36	17 1/4	74	8	FLV1636-17WSD		\$2,078	\$2,288
	15 15/16	30	17 1/4	65	7	FLT1630-17WSD	\$1,281		
	15 15/16	30	17 1/4	65	7	FLV1630-17WSD		\$1,995	\$2,195

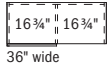

Features:

- supported by wall cleat - hardware provided by installer
- secure wall attachment required; pilot holes provided in back panel
- laminated grain direction runs horizontal on back panel of overhead cabinets
- locking not available

Options:

- must specify chassis grain direction on double cut veneer, see pages 11-13 for details
- veneer door fronts in paint available, specify paint color and add \$337 list; see page 14 for details
- on laminate units, contrasting laminate door fronts available, no upcharge; specify laminate color, see page 14 for details
- white glass doors with aluminum trim available, specify and add \$636 list for 36" w, \$607 list for 30" w; see page 31 for details
- markerboard laminate doors available, specify and add \$286 list; see page 31 for details

To Order, Specify:

① Laminate Model #	② Laminate Selection	③ Metal Color	④ Other Product Options
Laminate (FLT)	See Laminate Selection	See Metal Finish Color Options	See list of options for each specific unit; Specify and add accordingly.

① Veneer Model #	② Wood Species	③ Wood Finish	④ Metal Color	⑤ Other Product Options
Veneer (FLV)	Flat Cut CH1 Cherry MA1 Maple WA1 Walnut BO1 Black Oak	See Flat Cut Wood Finish Options	See Metal Finish Color Options	See list of options for each specific unit; Specify and add accordingly.
		③a Wood Finish See Double Cut Wood Finish Options		

Description	D	W	H	CTN WT	CU FT	① Model	Laminate	Flat Cut Veneer	Double Cut Veneer
Wall Mount Open Overhead	15	96	17	145	19	FLT1596-17W00	\$1,679		
	15	96	17	145	19	FLV1596-17W00		\$2,844	\$3,130
	15	90	17	137	18	FLT1590-17W00	\$1,579		
	15	90	17	137	18	FLV1590-17W00		\$2,673	\$2,939
	15	84	17	130	17	FLT1584-17W00	\$1,475		
	15	84	17	130	17	FLV1584-17W00		\$2,497	\$2,747

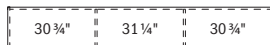
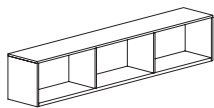

96" wide

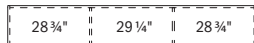

90" wide

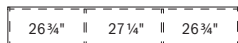

84" wide

Features:

- supported by wall cleat - hardware provided by installer
- secure wall attachment required; pilot holes provided in back panel
- laminate grain direction runs horizontal on back panel of overhead cabinets

Options:

- must specify chassis grain direction on double cut veneer, see pages 11-13 for details

Wall Mount Open Overhead	15	78	17	117	15	FLT1578-17W00	\$1,374		
	15	78	17	117	15	FLV1578-17W00		\$2,251	\$2,477
	15	72	17	109	14	FLT1572-17W00	\$1,296		
	15	72	17	109	14	FLV1572-17W00		\$2,122	\$2,332
	15	66	17	101	13	FLT1566-17W00	\$1,225		
	15	66	17	101	13	FLV1566-17W00		\$2,003	\$2,203
	15	60	17	98	12	FLT1560-17W00	\$1,173		
	15	60	17	98	12	FLV1560-17W00		\$1,917	\$2,108

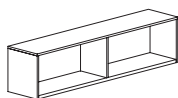

78" wide



72" wide



66" wide

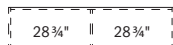



60" wide

Features:

- supported by wall cleat - hardware provided by installer
- secure wall attachment required; pilot holes provided in back panel
- laminate grain direction runs horizontal on back panel of overhead cabinets

Options:

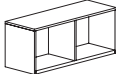
- must specify chassis grain direction on double cut veneer, see pages 11-13 for details

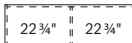
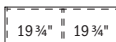

Description	D	W	H	CTN WT	CU FT	① Model	Laminate	Flat Cut Veneer	Double Cut Veneer
Wall Mount Open Overhead   54" wide  48" wide  42" wide	15	54	17	90	11	FLT1554-17W00	\$1,146		
	15	54	17	90	11	FLV1554-17W00		\$1,845	\$2,030
	15	48	17	82	10	FLT1548-17W00	\$1,106		
	15	48	17	82	10	FLV1548-17W00		\$1,782	\$1,959
	15	42	17	74	9	FLT1542-17W00	\$1,072		
	15	42	17	74	9	FLV1542-17W00		\$1,724	\$1,896

Features:

- supported by wall cleat - hardware provided by installer
- secure wall attachment required; pilot holes provided in back panel
- laminate grain direction runs horizontal on back panel of overhead cabinets

Options:

- must specify chassis grain direction on double cut veneer, see pages 11-13 for details

Wall Mount Open Overhead   36" wide  30" wide	15	36	17	57	8	FLT1536-17W00	\$1,015		
	15	36	17	57	8	FLV1536-17W00		\$1,633	\$1,798
	15	30	17	49	6	FLT1530-17W00	\$974		
	15	30	17	49	6	FLV1530-17W00		\$1,566	\$1,724

Features:

- supported by wall cleat - hardware provided by installer
- secure wall attachment required; pilot holes provided in back panel
- laminate grain direction runs horizontal on back panel of overhead cabinets

Options:

- must specify chassis grain direction on double cut veneer, see pages 11-13 for details

To Order, Specify:

① Laminate Model #	② Laminate Selection	③ Metal Color	④ Other Product Options
Laminate (FLT)	See Laminate Selection	See Metal Finish Color Options	See list of options for each specific unit; Specify and add accordingly.

① Veneer Model #	② Wood Species	③ Wood Finish	④ Metal Color	⑤ Other Product Options
Veneer (FLV)	Flat Cut CH1 Cherry MA1 Maple WA1 Walnut BO1 Black Oak	See Flat Cut Wood Finish Options	See Metal Finish Color Options	See list of options for each specific unit; Specify and add accordingly.
		③a Wood Finish See Double Cut Wood Finish Options		

Description	D	W	H	CTN WT	CU FT	① Model	Laminate	Flat Cut Veneer	Double Cut Veneer
Wall Mount Cubby with Open Vertical Storage Compartment	15	96	17	100	19	FLT1596WCUOR	\$1,978		
	15	96	17	100	19	FLV1596WCUOR		\$3,045	\$3,347
	15	96	17	100	19	FLT1596WCUOL	\$1,978		
	15	96	17	100	19	FLV1596WCUOL		\$3,045	\$3,347
	15	90	17	96	18	FLT1590WCUOR	\$1,861		
	15	90	17	96	18	FLV1590WCUOR		\$2,767	\$3,046
	15	90	17	96	18	FLT1590WCUOL	\$1,861		
	15	90	17	96	18	FLV1590WCUOL		\$2,767	\$3,046
	15	84	17	91	17	FLT1584WCUOR	\$1,828		
	15	84	17	91	17	FLV1584WCUOR		\$2,570	\$2,827
	15	84	17	91	17	FLT1584WCUOL	\$1,828		
	15	84	17	91	17	FLV1584WCUOL		\$2,570	\$2,827

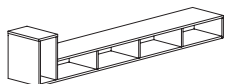

left shown

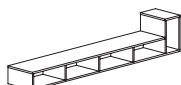

right

Features:

- supported by wall cleat - hardware provided by installer
- laminate grain direction runs horizontal on back panel of cubbies

Options:

- must specify chassis grain direction on double cut veneer, see pages 11-13 for details

Wall Mount Cubby with Open Vertical Storage Compartment	15	78	17	85	15	FLT1578WCUOR	\$1,626		
	15	78	17	85	15	FLV1578WCUOR		\$2,487	\$2,735
	15	78	17	85	15	FLT1578WCUOL	\$1,626		
	15	78	17	85	15	FLV1578WCUOL		\$2,487	\$2,735
	15	72	17	80	14	FLT1572WCUOR	\$1,526		
	15	72	17	80	14	FLV1572WCUOR		\$2,327	\$2,562
	15	72	17	80	14	FLT1572WCUOL	\$1,526		
	15	72	17	80	14	FLV1572WCUOL		\$2,327	\$2,562
	15	66	17	75	13	FLT1566WCUOR	\$1,427		
	15	66	17	75	13	FLV1566WCUOR		\$2,168	\$2,386
	15	66	17	75	13	FLT1566WCUOL	\$1,427		
	15	66	17	75	13	FLV1566WCUOL		\$2,168	\$2,386
	15	60	17	70	12	FLT1560WCUOR	\$1,338		
	15	60	17	70	12	FLV1560WCUOR		\$2,026	\$2,231
	15	60	17	70	12	FLT1560WCUOL	\$1,338		
	15	60	17	70	12	FLV1560WCUOL		\$2,026	\$2,231

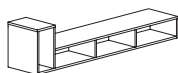

left shown

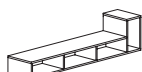

right

Features:

- supported by wall cleat - hardware provided by installer
- laminate grain direction runs horizontal on back panel of cubbies

Options:

- must specify chassis grain direction on double cut veneer, see pages 11-13 for details

Description	D	W	H	CTN WT	CU FT	① Model	Laminate	Flat Cut Veneer	Double Cut Veneer
Wall Mount Cubby with Open Vertical Storage Compartment	15	54	17	64	11	FLT1554WCUOR	\$1,256		
	15	54	17	64	11	FLV1554WCUOR		\$1,899	\$2,089
	15	54	17	64	11	FLT1554WCUOL	\$1,256		
	15	54	17	64	11	FLV1554WCUOL		\$1,899	\$2,089
	15	48	17	59	10	FLT1548WCUOR	\$1,184		
	15	48	17	59	10	FLV1548WCUOR		\$1,785	\$1,962
	15	48	17	59	10	FLT1548WCUOL	\$1,184		
	15	48	17	59	10	FLV1548WCUOL		\$1,785	\$1,962
	15	42	17	54	9	FLT1542WCUOR	\$1,111		
	15	42	17	54	9	FLV1542WCUOR		\$1,670	\$1,837
	15	42	17	54	9	FLT1542WCUOL	\$1,111		
	15	42	17	54	9	FLV1542WCUOL		\$1,670	\$1,837

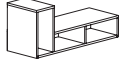

left shown

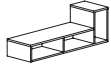

right

Features:

- supported by wall cleat - hardware provided by installer
- laminate grain direction runs horizontal on back panel of cubbies

Options:

- must specify chassis grain direction on double cut veneer, see pages 11-13 for details

Wall Mount Cubby with Open Vertical Storage Compartment	15	36	17	49	8	FLT1536WCUOR	\$1,045		
	15	36	17	49	8	FLV1536WCUOR		\$1,565	\$1,722
	15	36	17	49	8	FLT1536WCUOL	\$1,045		
	15	36	17	49	8	FLV1536WCUOL		\$1,565	\$1,722
	15	30	17	44	6	FLT1530WCUOR	\$988		
	15	30	17	44	6	FLV1530WCUOR		\$1,474	\$1,622
	15	30	17	44	6	FLT1530WCUOL	\$988		
	15	30	17	44	6	FLV1530WCUOL		\$1,474	\$1,622

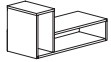

left shown



right

Features:

- supported by wall cleat - hardware provided by installer
- laminate grain direction runs horizontal on back panel of cubbies



Options:

- must specify chassis grain direction on double cut veneer, see pages 11-13 for details

To Order, Specify:

① Laminate Model #	② Laminate Selection	③ Metal Color	④ Other Product Options
Laminate (FLT)	See Laminate Selection	See Metal Finish Color Options	See list of options for each specific unit; Specify and add accordingly.

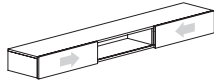
① Veneer Model #	② Wood Species	③ Wood Finish	④ Metal Color	⑤ Other Product Options
Veneer (FLV)	Flat Cut CH1 Cherry MA1 Maple WA1 Walnut BO1 Black Oak	See Flat Cut Wood Finish Options	See Metal Finish Color Options	See list of options for each specific unit; Specify and add accordingly.
		③a Wood Finish See Double Cut Wood Finish Options		

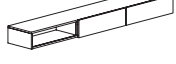
Description	D	W	H	CTN WT	CU FT	① Model	Laminate	Flat Cut Veneer	Double Cut Veneer
Wall Mount Cubby with Sliding Doors   	15 15/16	96	8 1/4	111	11	FLT1696WSDCU	\$2,003		
	15 15/16	96	8 1/4	111	11	FLV1696WSDCU		\$3,283	\$3,613
	15 15/16	90	8 1/4	100	11	FLT1690WSDCU	\$1,886		
	15 15/16	90	8 1/4	100	11	FLV1690WSDCU		\$3,088	\$3,396
	15 15/16	84	8 1/4	89	10	FLT1684WSDCU	\$1,765		
	15 15/16	84	8 1/4	89	10	FLV1684WSDCU		\$2,890	\$3,179

Features:

- supported by wall cleat - hardware provided by installer
- laminate grain direction runs horizontal on back panel of cubbies
- locking not available

Options:

- must specify chassis grain direction on double cut veneer, see pages 11-13 for details
- veneer door fronts in paint available, specify paint color and add \$337 list; see page 14 for details
- on laminate units, contrasting laminate door fronts available, no upcharge; specify laminate color, see page 14 for details
- white glass doors with aluminum trim available, specify and add \$1,639 list for 96" w, \$1,568 list for 90" w, \$1,538 list for 84" w; see page 31 for details
- markerboard laminate doors available, specify and add \$569 list; see page 31 for details

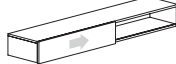
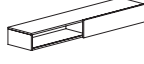
Wall Mount Cubby with Sliding Door  	15 15/16	78	8 1/4	79	9	FLT1678WSDCU	\$1,648		
	15 15/16	78	8 1/4	79	9	FLV1678WSDCU		\$2,611	\$2,872
	15 15/16	72	8 1/4	74	9	FLT1672WSDCU	\$1,554		
	15 15/16	72	8 1/4	74	9	FLV1672WSDCU		\$2,464	\$2,712
	15 15/16	66	8 1/4	69	8	FLT1666WSDCU	\$1,473		
	15 15/16	66	8 1/4	69	8	FLV1666WSDCU		\$2,331	\$2,565
	15 15/16	60	8 1/4	63	7	FLT1660WSDCU	\$1,410		
	15 15/16	60	8 1/4	63	7	FLV1660WSDCU		\$2,234	\$2,457

Features:

- supported by wall cleat - hardware provided by installer
- laminate grain direction runs horizontal on back panel of cubbies
- locking not available

Options:

- must specify chassis grain direction on double cut veneer, see pages 11-13 for details
- veneer door fronts in paint available, specify paint color and add \$337 list; see page 14 for details
- on laminate units, contrasting laminate door fronts available, no upcharge; specify laminate color, see page 14 for details
- white glass doors with aluminum trim available, specify and add \$822 list for 78" w, \$786 list for 72" w, \$772 list for 66" w or 60" w; see page 31 for details
- markerboard laminate doors available, specify and add \$286 list; see page 31 for details

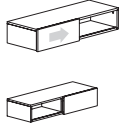
Description	D	W	H	CTN WT	CU FT	① Model	Laminate	Flat Cut Veneer	Double Cut Veneer
Wall Mount Cubby with Sliding Door 	15 15/16	54	8 1/4	58	7	FLT1654WSDCU	\$1,378		
	15 15/16	54	8 1/4	58	7	FLV1654WSDCU		\$2,149	\$2,365
	15 15/16	48	8 1/4	53	6	FLT1648WSDCU	\$1,334		
	15 15/16	48	8 1/4	53	6	FLV1648WSDCU		\$2,078	\$2,288
	15 15/16	42	8 1/4	48	5	FLT1642WSDCU	\$1,291		
	15 15/16	42	8 1/4	48	5	FLV1642WSDCU		\$2,014	\$2,216
	15 15/16	36	8 1/4	43	5	FLT1636WSDCU	\$1,226		
	15 15/16	36	8 1/4	43	5	FLV1636WSDCU		\$1,912	\$2,105
	15 15/16	30	8 1/4	38	4	FLT1630WSDCU	\$1,177		
	15 15/16	30	8 1/4	38	4	FLV1630WSDCU		\$1,834	\$2,019

Features:

- supported by wall cleat - hardware provided by installer
- laminate grain direction runs horizontal on back panel of cubbies
- locking not available

Options:

- must specify chassis grain direction on double cut veneer, see pages 11-13 for details
- veneer door fronts in paint available, specify paint color and add \$337 list; see page 14 for details
- on laminate units, contrasting laminate door fronts available, no upcharge; specify laminate color, see page 14 for details
- white glass doors with aluminum trim available, specify and add \$753 list; see page 31 for details
- markerboard laminate doors available, specify and add \$286 list; see page 31 for details

To Order, Specify:

① Laminate Model #	② Laminate Selection	③ Metal Color	④ Other Product Options
Laminate (FLT)	See Laminate Selection	See Metal Finish Color Options	See list of options for each specific unit; Specify and add accordingly.

① Veneer Model #	② Wood Species	③ Wood Finish	④ Metal Color	⑤ Other Product Options
Veneer (FLV)	Flat Cut CH1 Cherry MA1 Maple WA1 Walnut BO1 Black Oak	See Flat Cut Wood Finish Options	See Metal Finish Color Options	See list of options for each specific unit; Specify and add accordingly.
		3a Wood Finish See Double Cut Wood Finish Options		

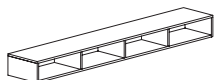
Description	D	W	H	CTN WT	CU FT	① Model	Laminate	Flat Cut Veneer	Double Cut Veneer
15"d Wall Mount Cubby 	15	96	8	90	11	FLT1596WCU	\$1,692		
	15	96	8	90	11	FLV1596WCU		\$2,603	\$2,863
	15	90	8	86	10	FLT1590WCU	\$1,591		
	15	90	8	86	10	FLV1590WCU		\$2,367	\$2,605
	15	84	8	81	9	FLT1584WCU	\$1,564		
	15	84	8	81	9	FLV1584WCU		\$2,198	\$2,418

Features:

- supported by wall cleat - hardware provided by installer
- laminate grain direction runs horizontal on back panel of cubbies

Options:

- must specify chassis grain direction on double cut veneer, see pages 11-13 for details

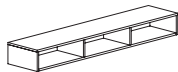
15"d Wall Mount Cubby 	15	78	8	75	9	FLT1578WCU	\$1,390		
	15	78	8	75	9	FLV1578WCU		\$2,126	\$2,337
	15	72	8	70	8	FLT1572WCU	\$1,305		
	15	72	8	70	8	FLV1572WCU		\$1,991	\$2,189
	15	66	8	65	8	FLT1566WCU	\$1,219		
	15	66	8	65	8	FLV1566WCU		\$1,854	\$2,040
	15	60	8	60	7	FLT1560WCU	\$1,145		
	15	60	8	60	7	FLV1560WCU		\$1,734	\$1,907

Features:

- supported by wall cleat - hardware provided by installer
- laminate grain direction runs horizontal on back panel of cubbies

Options:

- must specify chassis grain direction on double cut veneer, see pages 11-13 for details

15"d Wall Mount Cubby 	15	54	8	54	6	FLT1554WCU	\$1,074		
	15	54	8	54	6	FLV1554WCU		\$1,624	\$1,786
	15	48	8	49	6	FLT1548WCU	\$1,011		
	15	48	8	49	6	FLV1548WCU		\$1,526	\$1,678
	15	42	8	44	5	FLT1542WCU	\$949		
	15	42	8	44	5	FLV1542WCU		\$1,429	\$1,569
	15	36	8	39	4	FLT1536WCU	\$895		
	15	36	8	39	4	FLV1536WCU		\$1,339	\$1,473
	15	30	8	34	4	FLT1530WCU	\$845		
	15	30	8	34	4	FLV1530WCU		\$1,259	\$1,384

Features:

- supported by wall cleat - hardware provided by installer
- laminate grain direction runs horizontal on back panel of cubbies

Options:

- must specify chassis grain direction on double cut veneer, see pages 11-13 for details

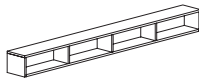
Description	D	W	H	CTN WT	CU FT	① Model	Laminate	Flat Cut Veneer	Double Cut Veneer
9"d Wall Mount Cubby 	9	96	8	68	7	FLT0996WCU	\$1,510		
	9	96	8	68	7	FLV0996WCU		\$2,323	\$2,559
	9	90	8	64	7	FLT0990WCU	\$1,422		
	9	90	8	64	7	FLV0990WCU		\$2,114	\$2,326
	9	84	8	60	6	FLT0984WCU	\$1,397		
	9	84	8	60	6	FLV0984WCU		\$1,961	\$2,159

Features:

- supported by wall cleat - hardware provided by installer
- laminate grain direction runs horizontal on back panel of cubbies

Options:

- must specify chassis grain direction on double cut veneer, see pages 11-13 for details

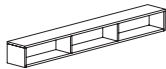
9"d Wall Mount Cubby 	9	78	8	55	6	FLT0978WCU	\$1,241		
	9	78	8	55	6	FLV0978WCU		\$1,897	\$2,087
	9	72	8	51	5	FLT0972WCU	\$1,166		
	9	72	8	51	5	FLV0972WCU		\$1,778	\$1,955
	9	66	8	49	5	FLT0966WCU	\$1,090		
	9	66	8	49	5	FLV0966WCU		\$1,657	\$1,821
	9	60	8	43	5	FLT0960WCU	\$1,021		
	9	60	8	43	5	FLV0960WCU		\$1,548	\$1,702

Features:

- supported by wall cleat - hardware provided by installer
- laminate grain direction runs horizontal on back panel of cubbies

Options:

- must specify chassis grain direction on double cut veneer, see pages 11-13 for details

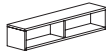
9"d Wall Mount Cubby 	9	54	8	39	4	FLT0954WCU	\$959		
	9	54	8	39	4	FLV0954WCU		\$1,451	\$1,597
	9	48	8	35	4	FLT0948WCU	\$906		
	9	48	8	35	4	FLV0948WCU		\$1,364	\$1,499
	9	42	8	31	3	FLT0942WCU	\$848		
	9	42	8	31	3	FLV0942WCU		\$1,275	\$1,403
	9	36	8	27	3	FLT0936WCU	\$800		
	9	36	8	27	3	FLV0936WCU		\$1,195	\$1,316
	9	30	8	23	3	FLT0930WCU	\$755		
9	30	8	23	3	FLV0930WCU		\$1,124	\$1,237	

Features:

- supported by wall cleat - hardware provided by installer
- laminate grain direction runs horizontal on back panel of cubbies

Options:

- must specify chassis grain direction on double cut veneer, see pages 11-13 for details

To Order, Specify:

① Laminate Model #	② Laminate Selection	③ Metal Color	④ Other Product Options
Laminate (FLT)	See Laminate Selection	See Metal Finish Color Options	See list of options for each specific unit; Specify and add accordingly.

① Veneer Model #	② Wood Species	③ Wood Finish	④ Metal Color	⑤ Other Product Options
Veneer (FLV)	Flat Cut CH1 Cherry MA1 Maple WA1 Walnut BO1 Black Oak	See Flat Cut Wood Finish Options	See Metal Finish Color Options	See list of options for each specific unit; Specify and add accordingly.
		3a Wood Finish See Double Cut Wood Finish Options		

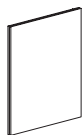
Description	D	W	H	CTN WT	CU FT	① Model	Laminate	Flat Cut Veneer	Double Cut Veneer
Wall Mount Panel 	1 1/16	48	40 13/16	53	5	FLT4841WMP	\$1,103		
	1 1/16	48	40 13/16	53	5	FLV4841WMP		\$1,736	\$1,910
	1 1/16	42	40 13/16	48	4	FLT4241WMP	\$1,082		
	1 1/16	42	40 13/16	48	4	FLV4241WMP		\$1,701	\$1,871
	1 1/16	39	40 13/16	45	4	FLT3941WMP	\$1,055		
	1 1/16	39	40 13/16	45	4	FLV3941WMP		\$1,664	\$1,829
	1 1/16	36	40 13/16	42	4	FLT3641WMP	\$1,032		
	1 1/16	36	40 13/16	42	4	FLV3641WMP		\$1,626	\$1,787
	1 1/16	33	40 13/16	38	4	FLT3341WMP	\$1,005		
	1 1/16	33	40 13/16	38	4	FLV3341WMP		\$1,589	\$1,746
	1 1/16	30	40 13/16	36	3	FLT3041WMP	\$980		
	1 1/16	30	40 13/16	36	3	FLV3041WMP		\$1,554	\$1,709
	1 1/16	24	40 13/16	29	3	FLT2441WMP	\$961		
	1 1/16	24	40 13/16	29	3	FLV2441WMP		\$1,521	\$1,673
1 1/16	18	40 13/16	23	2	FLT1841WMP	\$941			
1 1/16	18	40 13/16	23	2	FLV1841WMP		\$1,489	\$1,637	

Features:

- pair with primary height units to achieve 69" overall height
- supported by wall cleat - hardware provided by installer
- grain direction runs vertical on flat cut veneer, horizontal on laminate
- spacing of attachment cleats allows wire management

Options:

- must specify grain direction on double cut veneer, see pages 11-13 for details

Description	D	W	H	CTN WT	CU FT	① Model	List Price
Wall Mount Markerboard 	1 1/16	48	40 13/16	53	5	FLB4841WMMB	\$1,300
	1 1/16	42	40 13/16	48	4	FLB4241WMMB	\$1,276
	1 1/16	39	40 13/16	45	4	FLB3941WMMB	\$1,247
	1 1/16	36	40 13/16	42	4	FLB3641WMMB	\$1,216
	1 1/16	33	40 13/16	38	4	FLB3341WMMB	\$1,185
	1 1/16	30	40 13/16	36	3	FLB3041WMMB	\$1,156
	1 1/16	24	40 13/16	29	3	FLB2441WMMB	\$1,132
	1 1/16	18	40 13/16	23	2	FLB1841WMMB	\$1,111

Features:

- pair with primary height units to achieve 69" overall height
- supported by wall cleat - hardware provided by installer
- standard markerboard laminate with aluminum pvc edge
- spacing of attachment cleats allows wire management

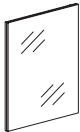
Description	D	W	H	CTN WT	CU FT	① Model	List Price
 Wall Mount Glass Markerboard	1 1/16	48	40 13/16	75	4	FLB4841WMMBG	\$3,367
	1 1/16	42	40 13/16	65	4	FLB4241WMMBG	\$2,876
	1 1/16	39	40 13/16	61	4	FLB3941WMMBG	\$2,735
	1 1/16	36	40 13/16	56	3	FLB3641WMMBG	\$2,596
	1 1/16	33	40 13/16	51	3	FLB3341WMMBG	\$2,454
	1 1/16	30	40 13/16	47	3	FLB3041WMMBG	\$2,312
	1 1/16	24	40 13/16	38	2	FLB2441WMMBG	\$2,032
	1 1/16	18	40 13/16	28	2	FLB1841WMMBG	\$1,751



Features:

- pair with primary height units to achieve 69" overall height
- supported by wall cleat - hardware provided by installer
- white back painted glass with an aluminum profile frame
- spacing of attachment cleats allows wire management





To Order, Specify:

① Laminate Model #	② Laminate Selection	③ Metal Color	④ Other Product Options
Laminate (FLT)	See Laminate Selection	See Metal Finish Color Options	See list of options for each specific unit; Specify and add accordingly.

① Veneer Model #	② Wood Species	③ Wood Finish	④ Metal Color	⑤ Other Product Options
Veneer (FLV)	Flat Cut CH1 Cherry MA1 Maple WA1 Walnut BO1 Black Oak	See Flat Cut Wood Finish Options	See Metal Finish Color Options	See list of options for each specific unit; Specify and add accordingly.
		③a Wood Finish See Double Cut Wood Finish Options		

Description	D	W	H	CTN WT	CU FT	① Model	List Price Per Grade
48" w Wall Mount Tack Panel 	1 1/16	48	40 3/4	34	5	FLB4841WT	COM \$926 A \$946 B \$980 C \$1,044 D \$1,127 E \$1,212 F \$1,339 G \$1,475 H \$1,622 I \$1,851 J \$2,125
	Features: · pair with primary height units to achieve 69" overall height · supported by wall cleat - hardware provided by installer · com ydg: 1 1/2						
42" w Wall Mount Tack Panel 	1 1/16	42	40 3/4	32	4	FLB4241WT	COM \$867 A \$886 B \$923 C \$987 D \$1,069 E \$1,152 F \$1,281 G \$1,415 H \$1,562 I \$1,793 J \$2,066
	Features: · pair with primary height units to achieve 69" overall height · supported by wall cleat - hardware provided by installer · com ydg: 1 1/2						
39" w Wall Mount Tack Panel 	1 1/16	39	40 3/4	31	4	FLB3941WT	COM \$837 A \$852 B \$883 C \$935 D \$1,005 E \$1,074 F \$1,181 G \$1,296 H \$1,416 I \$1,607 J \$1,836
	Features: · pair with primary height units to achieve 69" overall height · supported by wall cleat - hardware provided by installer · com ydg: 1 1/4						
36" w Wall Mount Tack Panel 	1 1/16	36	40 3/4	30	4	FLB3641WT	COM \$806 A \$822 B \$852 C \$907 D \$975 E \$1,043 F \$1,151 G \$1,264 H \$1,385 I \$1,578 J \$1,807
	Features: · pair with primary height units to achieve 69" overall height · supported by wall cleat - hardware provided by installer · com ydg: 1 1/4						

FLUX - PRIVATE OFFICE

Description	D	W	H	CTN WT	CU FT	① Model	List Price Per Grade
33" w Wall Mount Tack Panel  Features: <ul style="list-style-type: none"> · pair with primary height units to achieve 69" overall height · supported by wall cleat - hardware provided by installer · com ydg: 1 ¼ 	1 ⅞	33	40 ¾	29	4	FLB3341WT	COM \$777 A \$793 B \$822 C \$876 D \$946 E \$1,012 F \$1,120 G \$1,235 H \$1,359 I \$1,547 J \$1,777
30" w Wall Mount Tack Panel  Features: <ul style="list-style-type: none"> · pair with primary height units to achieve 69" overall height · supported by wall cleat - hardware provided by installer · com ydg: 1 	1 ⅞	30	40 ¾	28	3	FLB3041WT	COM \$747 A \$759 B \$783 C \$825 D \$882 E \$935 F \$1,021 G \$1,113 H \$1,212 I \$1,364 J \$1,546
24" w Wall Mount Tack Panel  Features: <ul style="list-style-type: none"> · pair with primary height units to achieve 69" overall height · supported by wall cleat - hardware provided by installer · com ydg: 1 	1 ⅞	24	40 ¾	23	3	FLB2441WT	COM \$687 A \$702 B \$724 C \$768 D \$822 E \$877 F \$964 G \$1,054 H \$1,152 I \$1,303 J \$1,487
18" w Wall Mount Tack Panel  Features: <ul style="list-style-type: none"> · pair with primary height units to achieve 69" overall height · supported by wall cleat - hardware provided by installer · com ydg: 1 	1 ⅞	18	40 ¾	18	2	FLB1841WT	COM \$627 A \$641 B \$665 C \$708 D \$761 E \$816 F \$904 G \$995 H \$1,091 I \$1,245 J \$1,427

FLUX - PRIVATE OFFICE

To Order, Specify:

① Model Number	② Fabric Selection	
(FLB)	Vendor Pattern Color	Visit www.jsifurniture.com/finishes-and-materials/textiles for our textiles program. See selection of standard and graded in manufacturers and patterns.

Description	D	W	H	CTN WT	CU FT	① Model	Laminate	Flat Cut Veneer	Double Cut Veneer
Wall Mount Panel 	1 1/16	48	23 1/2	33	3	FLT4824WMP	\$914		
	1 1/16	48	23 1/2	33	3	FLV4824WMP		\$1,438	\$1,582
	1 1/16	42	23 1/2	30	3	FLT4224WMP	\$897		
	1 1/16	42	23 1/2	30	3	FLV4224WMP		\$1,411	\$1,553
	1 1/16	39	23 1/2	28	3	FLT3924WMP	\$874		
	1 1/16	39	23 1/2	28	3	FLV3924WMP		\$1,378	\$1,515
	1 1/16	36	23 1/2	26	3	FLT3624WMP	\$854		
	1 1/16	36	23 1/2	26	3	FLV3624WMP		\$1,347	\$1,483
	1 1/16	33	23 1/2	24	2	FLT3324WMP	\$834		
	1 1/16	33	23 1/2	24	2	FLV3324WMP		\$1,319	\$1,450
	1 1/16	30	23 1/2	22	2	FLT3024WMP	\$813		
	1 1/16	30	23 1/2	22	2	FLV3024WMP		\$1,288	\$1,415
	1 1/16	24	23 1/2	18	2	FLT2424WMP	\$797		
	1 1/16	24	23 1/2	18	2	FLV2424WMP		\$1,260	\$1,385
1 1/16	18	23 1/2	14	2	FLT1824WMP	\$781			
1 1/16	18	23 1/2	14	2	FLV1824WMP		\$1,234	\$1,359	

Features:

- pair with primary height units and overhead cabinets or shelves to achieve 69" overall height
- supported by wall cleat - hardware provided by installer
- grain direction runs vertical on flat cut veneer, horizontal on laminate
- spacing of attachment cleats allows wire management

Options:

- must specify grain direction on double cut veneer, see pages 11-13 for details

Description	D	W	H	CTN WT	CU FT	① Model	List Price
Wall Mount Markerboard 	1 1/16	48	23 1/2	36	3	FLB4824WMMB	\$1,078
	1 1/16	42	23 1/2	30	3	FLB4224WMMB	\$1,057
	1 1/16	39	23 1/2	28	3	FLB3924WMMB	\$1,033
	1 1/16	36	23 1/2	26	3	FLB3624WMMB	\$1,007
	1 1/16	33	23 1/2	24	2	FLB3324WMMB	\$981
	1 1/16	30	23 1/2	21	2	FLB3024WMMB	\$959
	1 1/16	24	23 1/2	18	2	FLB2424WMMB	\$937
	1 1/16	18	23 1/2	14	2	FLB1824WMMB	\$921

Features:

- pair with primary height units and overhead cabinets or shelves to achieve 69" overall height
- supported by wall cleat - hardware provided by installer
- standard markerboard laminate with aluminum pvc edge
- spacing of attachment cleats allows wire management

Description	D	W	H	CTN WT	CU FT	① Model	List Price
 Wall Mount Glass Markerboard	1 5/16	48	23 1/2	43	3	FLB4824WMMBG	\$2,203
	1 5/16	42	23 1/2	38	2	FLB4224WMMBG	\$2,042
	1 5/16	39	23 1/2	35	2	FLB3924WMMBG	\$1,960
	1 5/16	36	23 1/2	33	2	FLB3624WMMBG	\$1,882
	1 5/16	33	23 1/2	30	2	FLB3324WMMBG	\$1,802
	1 5/16	30	23 1/2	27	2	FLB3024WMMBG	\$1,720
	1 5/16	24	23 1/2	22	2	FLB2424WMMBG	\$1,557
	1 5/16	18	23 1/2	17	1	FLB1824WMMBG	\$1,397

Features:

- pair with primary height units and overhead cabinets or shelves to achieve 69" overall height
- supported by wall cleat - hardware provided by installer
- white back painted glass with an aluminum profile frame
- spacing of attachment cleats allows wire management

To Order, Specify:

① Laminate Model #	② Laminate Selection	③ Metal Color	④ Other Product Options
Laminate (FLT)	See Laminate Selection	See Metal Finish Color Options	See list of options for each specific unit; Specify and add accordingly.

① Veneer Model #	② Wood Species	③ Wood Finish	④ Metal Color	⑤ Other Product Options
Veneer (FLV)	Flat Cut CH1 Cherry MA1 Maple WA1 Walnut BO1 Black Oak	See Flat Cut Wood Finish Options	See Metal Finish Color Options	See list of options for each specific unit; Specify and add accordingly.
		③a Wood Finish See Double Cut Wood Finish Options		

Description	D	W	H	CTN WT	CU FT	① Model	List Price Per Grade
 <p>48\"w Wall Mount Tack Panel</p> <p>Features:</p> <ul style="list-style-type: none"> · pair with primary height units and overhead cabinets or shelves to achieve 69\" overall height · supported by wall cleat - hardware provided by installer · com ydg: 1 ½ 	1 ⅞	48	23 ½	20	3	FLB4824WT	COM \$724
	A	\$743					
	B	\$779					
	C	\$844					
	D	\$926					
	E	\$1,008					
	F	\$1,137					
	G	\$1,273					
	H	\$1,419					
	I	\$1,649					
	J	\$1,923					
 <p>42\"w Wall Mount Tack Panel</p> <p>Features:</p> <ul style="list-style-type: none"> · pair with primary height units and overhead cabinets or shelves to achieve 69\" overall height · supported by wall cleat - hardware provided by installer · com ydg: 1 ½ 	1 ⅞	42	23 ½	18	3	FLB4224WT	COM \$688
	A	\$709					
	B	\$743					
	C	\$807					
	D	\$891					
	E	\$972					
	F	\$1,102					
	G	\$1,237					
	H	\$1,383					
	I	\$1,614					
	J	\$1,888					
 <p>39\"w Wall Mount Tack Panel</p> <p>Features:</p> <ul style="list-style-type: none"> · pair with primary height units and overhead cabinets or shelves to achieve 69\" overall height · supported by wall cleat - hardware provided by installer · com ydg: 1 ¼ 	1 ⅞	39	23 ½	18	3	FLB3924WT	COM \$671
	A	\$687					
	B	\$718					
	C	\$772					
	D	\$841					
	E	\$909					
	F	\$1,015					
	G	\$1,130					
	H	\$1,252					
	I	\$1,442					
	J	\$1,671					
 <p>36\"w Wall Mount Tack Panel</p> <p>Features:</p> <ul style="list-style-type: none"> · pair with primary height units and overhead cabinets or shelves to achieve 69\" overall height · supported by wall cleat - hardware provided by installer · com ydg: 1 ¼ 	1 ⅞	36	23 ½	17	2	FLB3624WT	COM \$654
	A	\$670					
	B	\$702					
	C	\$754					
	D	\$823					
	E	\$892					
	F	\$998					
	G	\$1,113					
	H	\$1,235					
	I	\$1,424					
	J	\$1,655					

FLUX - PRIVATE OFFICE

Description	D	W	H	CTN WT	CU FT	① Model	List Price Per Grade
33" w Wall Mount Tack Panel	1 9/16	33	23 1/2	17	2	FLB3324WT	COM \$638
 <p>Features:</p> <ul style="list-style-type: none"> · pair with primary height units and overhead cabinets or shelves to achieve 69" overall height · supported by wall cleat - hardware provided by installer · com ydg: 1 1/4 	A						\$653
	B						\$683
	C						\$737
	D						\$806
	E						\$874
	F						\$980
	G						\$1,096
	H						\$1,218
	I						\$1,409
	J						\$1,636
30" w Wall Mount Tack Panel	1 9/16	30	23 1/2	16	2	FLB3024WT	COM \$619
 <p>Features:</p> <ul style="list-style-type: none"> · pair with primary height units and overhead cabinets or shelves to achieve 69" overall height · supported by wall cleat - hardware provided by installer · com ydg: 1 	A						\$631
	B						\$655
	C						\$699
	D						\$754
	E						\$810
	F						\$894
	G						\$987
	H						\$1,083
	I						\$1,236
	J						\$1,417
24" w Wall Mount Tack Panel	1 9/16	24	23 1/2	14	2	FLB2424WT	COM \$585
 <p>Features:</p> <ul style="list-style-type: none"> · pair with primary height units and overhead cabinets or shelves to achieve 69" overall height · supported by wall cleat - hardware provided by installer · com ydg: 1 	A						\$598
	B						\$621
	C						\$666
	D						\$720
	E						\$775
	F						\$860
	G						\$952
	H						\$1,048
	I						\$1,202
	J						\$1,383
18" w Wall Mount Tack Panel	1 9/16	18	23 1/2	11	2	FLB1824WT	COM \$552
 <p>Features:</p> <ul style="list-style-type: none"> · pair with primary height units and overhead cabinets or shelves to achieve 69" overall height · supported by wall cleat - hardware provided by installer · com ydg: 1 	A						\$563
	B						\$588
	C						\$630
	D						\$686
	E						\$741
	F						\$825
	G						\$919
	H						\$1,015
	I						\$1,168
	J						\$1,349

FLUX - PRIVATE OFFICE

To Order, Specify:

① Model Number	② Fabric Selection
(FLB)	Vendor Pattern Color Visit www.jsifurniture.com/finishes-and-materials/textiles for our textiles program. See selection of standard and graded in manufacturers and patterns.

Description	D	W	H	CTN WT	CU FT	① Model	Laminate	Flat Cut Veneer	Double Cut Veneer
Wall Mount Panel 	1 1/16	48	31 1/2	42	4	FLT4832WMP	\$977		
	1 1/16	48	31 1/2	42	4	FLV4832WMP		\$1,537	\$1,691
	1 1/16	42	31 1/2	38	4	FLT4232WMP	\$958		
	1 1/16	42	31 1/2	38	4	FLV4232WMP		\$1,506	\$1,658
	1 1/16	39	31 1/2	36	3	FLT3932WMP	\$934		
	1 1/16	39	31 1/2	36	3	FLV3932WMP		\$1,473	\$1,621
	1 1/16	36	31 1/2	33	3	FLT3632WMP	\$913		
	1 1/16	36	31 1/2	33	3	FLV3632WMP		\$1,440	\$1,584
	1 1/16	33	31 1/2	31	3	FLT3332WMP	\$891		
	1 1/16	33	31 1/2	31	3	FLV3332WMP		\$1,407	\$1,548
	1 1/16	30	31 1/2	28	3	FLT3032WMP	\$868		
	1 1/16	30	31 1/2	28	3	FLV3032WMP		\$1,374	\$1,513
	1 1/16	24	31 1/2	23	2	FLT2432WMP	\$851		
	1 1/16	24	31 1/2	23	2	FLV2432WMP		\$1,347	\$1,483
1 1/16	18	31 1/2	18	2	FLT1832WMP	\$835			
1 1/16	18	31 1/2	18	2	FLV1832WMP		\$1,319	\$1,450	

Features:

- pair with secondary height units and overhead cabinets or shelves to achieve 69" overall height
- supported by wall cleat - hardware provided by installer
- grain direction runs vertical on flat cut veneer, horizontal on laminate
- spacing of attachment cleats allows wire management

Options:

- must specify grain direction on double cut veneer, see pages 11-13 for details

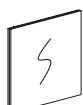
							List Price
Wall Mount Markerboard 	1 1/16	48	31 1/2	42	4	FLB4832WMMB	\$1,113
	1 1/16	42	31 1/2	38	4	FLB4232WMMB	\$1,090
	1 1/16	39	31 1/2	36	3	FLB3932WMMB	\$1,064
	1 1/16	36	31 1/2	33	3	FLB3632WMMB	\$1,039
	1 1/16	33	31 1/2	31	3	FLB3332WMMB	\$1,012
	1 1/16	30	31 1/2	28	3	FLB3032WMMB	\$990
	1 1/16	24	31 1/2	23	2	FLB2432WMMB	\$969
	1 1/16	18	31 1/2	18	2	FLB1832WMMB	\$949

Features:

- pair with secondary height units and overhead cabinets or shelves to achieve 69" overall height
- supported by wall cleat - hardware provided by installer
- standard markerboard laminate with aluminum pvc edge
- spacing of attachment cleats allows wire management

Description	D	W	H	CTN WT	CU FT	① Model	List Price
 Wall Mount Glass Markerboard	1 1/6	48	31 1/2	58	3	FLB4832WMMBG	\$2,808
	1 1/6	42	31 1/2	51	3	FLB4232WMMBG	\$2,429
	1 1/6	39	31 1/2	47	3	FLB3932WMMBG	\$2,320
	1 1/6	36	31 1/2	43	3	FLB3632WMMBG	\$2,210
	1 1/6	33	31 1/2	40	3	FLB3332WMMBG	\$2,104
	1 1/6	30	31 1/2	36	2	FLB3032WMMBG	\$1,995
	1 1/6	24	31 1/2	29	2	FLB2432WMMBG	\$1,779
	1 1/6	18	31 1/2	22	2	FLB1832WMMBG	\$1,561

Features:

- pair with secondary height units and overhead cabinets or shelves to achieve 69" overall height
- supported by wall cleat - hardware provided by installer
- white back painted glass with an aluminum profile frame
- spacing of attachment cleats allows wire management



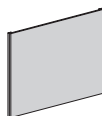
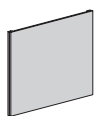
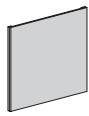
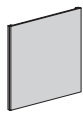

To Order, Specify:

① Laminate Model #	② Laminate Selection	③ Metal Color	④ Other Product Options
Laminate (FLT)	See Laminate Selection	See Metal Finish Color Options	See list of options for each specific unit; Specify and add accordingly.

① Veneer Model #	② Wood Species	③ Wood Finish	④ Metal Color	⑤ Other Product Options
Veneer (FLV)	Flat Cut CH1 Cherry MA1 Maple WA1 Walnut BO1 Black Oak	See Flat Cut Wood Finish Options	See Metal Finish Color Options	See list of options for each specific unit; Specify and add accordingly.
		③a Wood Finish See Double Cut Wood Finish Options		

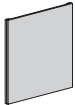
Description	D	W	H	CTN WT	CU FT	① Model	List Price Per Grade			
 <p>48" w Wall Mount Tack Panel</p> <p>Features:</p> <ul style="list-style-type: none"> · pair with secondary height units and overhead cabinets or shelves to achieve 69" overall height · supported by wall cleat - hardware provided by installer · com ydg: 1 ½ 	1 ⅞	48	31 ½	27	4	FLB4832WT	COM \$816 A \$837 B \$872 C \$935 D \$1,019 E \$1,102 F \$1,229 G \$1,366 H \$1,513 I \$1,742 J \$2,016			
	 <p>42" w Wall Mount Tack Panel</p> <p>Features:</p> <ul style="list-style-type: none"> · pair with secondary height units and overhead cabinets or shelves to achieve 69" overall height · supported by wall cleat - hardware provided by installer · com ydg: 1 ½ 	1 ⅞	42	31 ½	25	3	FLB4232WT	COM \$772 A \$792 B \$825 C \$891 D \$972 E \$1,055 F \$1,184 G \$1,321 H \$1,468 I \$1,696 J \$1,971		
		 <p>39" w Wall Mount Tack Panel</p> <p>Features:</p> <ul style="list-style-type: none"> · pair with secondary height units and overhead cabinets or shelves to achieve 69" overall height · supported by wall cleat - hardware provided by installer · com ydg: 1 ¼ 	1 ⅞	39	31 ½	24	3	FLB3932WT	COM \$748 A \$763 B \$794 C \$847 D \$917 E \$986 F \$1,091 G \$1,208 H \$1,328 I \$1,517 J \$1,746	
			 <p>36" w Wall Mount Tack Panel</p> <p>Features:</p> <ul style="list-style-type: none"> · pair with secondary height units and overhead cabinets or shelves to achieve 69" overall height · supported by wall cleat - hardware provided by installer · com ydg: 1 ¼ 	1 ⅞	36	31 ½	23	3	FLB3632WT	COM \$726 A \$741 B \$772 C \$824 D \$894 E \$964 F \$1,069 G \$1,184 H \$1,305 I \$1,495 J \$1,725

FLUX - PRIVATE OFFICE

Description	D	W	H	CTN WT	CU FT	① Model	List Price Per Grade
33" w Wall Mount Tack Panel 	1 9/16	33	31 1/2	22	3	FLB3332WT	COM \$703 A \$718 B \$748 C \$801 D \$871 E \$937 F \$1,044 G \$1,161 H \$1,283 I \$1,473 J \$1,701
Features: <ul style="list-style-type: none"> · pair with secondary height units and overhead cabinets or shelves to achieve 69" overall height · supported by wall cleat - hardware provided by installer · com ydg: 1 1/4 							
30" w Wall Mount Tack Panel 	1 9/16	30	31 1/2	21	3	FLB3032WT	COM \$679 A \$690 B \$716 C \$758 D \$813 E \$868 F \$955 G \$1,044 H \$1,142 I \$1,296 J \$1,478
Features: <ul style="list-style-type: none"> · pair with secondary height units and overhead cabinets or shelves to achieve 69" overall height · supported by wall cleat - hardware provided by installer · com ydg: 1 							
24" w Wall Mount Tack Panel 	1 9/16	24	31 1/2	18	2	FLB2432WT	COM \$631 A \$646 B \$669 C \$712 D \$768 E \$822 F \$908 G \$999 H \$1,096 I \$1,250 J \$1,432
Features: <ul style="list-style-type: none"> · pair with secondary height units and overhead cabinets or shelves to achieve 69" overall height · supported by wall cleat - hardware provided by installer · com ydg: 1 							
18" w Wall Mount Tack Panel 	1 9/16	18	31 1/2	14	2	FLB1832WT	COM \$587 A \$599 B \$623 C \$667 D \$721 E \$777 F \$861 G \$955 H \$1,050 I \$1,204 J \$1,384
Features: <ul style="list-style-type: none"> · pair with secondary height units and overhead cabinets or shelves to achieve 69" overall height · supported by wall cleat - hardware provided by installer · com ydg: 1 							

FLUX - PRIVATE OFFICE

To Order, Specify:

① Model Number	② Fabric Selection	
(FLB)	Vendor Pattern Color	Visit www.jsifurniture.com/finishes-and-materials/textiles for our textiles program. See selection of standard and graded in manufacturers and patterns.

Description	D	W	H	CTN WT	CU FT	① Model	Laminate	Flat Cut Veneer	Double Cut Veneer
Wall Mount Panel 	1 1/16	48	48 13/16	63	6	FLT4849WMP	\$1,202		
	1 1/16	48	48 13/16	63	6	FLV4849WMP		\$1,891	\$2,087
	1 1/16	42	48 13/16	56	5	FLT4249WMP	\$1,178		
	1 1/16	42	48 13/16	56	5	FLV4249WMP		\$1,854	\$2,040
	1 1/16	39	48 13/16	53	5	FLT3949WMP	\$1,151		
	1 1/16	39	48 13/16	53	5	FLV3949WMP		\$1,813	\$1,995
	1 1/16	36	48 13/16	49	4	FLT3649WMP	\$1,122		
	1 1/16	36	48 13/16	49	4	FLV3649WMP		\$1,773	\$1,949
	1 1/16	33	48 13/16	45	4	FLT3349WMP	\$1,095		
	1 1/16	33	48 13/16	45	4	FLV3349WMP		\$1,733	\$1,906
	1 1/16	30	48 13/16	42	4	FLT3049WMP	\$1,069		
	1 1/16	30	48 13/16	42	4	FLV3049WMP		\$1,693	\$1,861
	1 1/16	24	48 13/16	35	3	FLT2449WMP	\$1,047		
	1 1/16	24	48 13/16	35	3	FLV2449WMP		\$1,659	\$1,824
	1 1/16	18	48 13/16	27	3	FLT1849WMP	\$1,029		
1 1/16	18	48 13/16	27	3	FLV1849WMP		\$1,623	\$1,785	

Features:

- pair with secondary height units to achieve 69" overall height
- supported by wall cleat - hardware provided by installer
- grain direction runs vertical on flat cut veneer, horizontal on laminate
- spacing of attachment cleats allows wire management

Options:

- must specify grain direction on double cut veneer, see pages 11-13 for details

FLUX - PRIVATE OFFICE

Description	D	W	H	CTN WT	CU FT	① Model	List Price
Wall Mount Markerboard 	1 1/16	48	48 13/16	63	6	FLB4849WMMB	\$1,417
	1 1/16	42	48 13/16	56	5	FLB4249WMMB	\$1,390
	1 1/16	39	48 13/16	53	5	FLB3949WMMB	\$1,359
	1 1/16	36	48 13/16	49	4	FLB3649WMMB	\$1,324
	1 1/16	33	48 13/16	45	4	FLB3349WMMB	\$1,292
	1 1/16	30	48 13/16	42	4	FLB3049WMMB	\$1,259
	1 1/16	24	48 13/16	35	3	FLB2449WMMB	\$1,235
	1 1/16	18	48 13/16	27	3	FLB1849WMMB	\$1,212

Features:

- pair with secondary height units to achieve 69" overall height
- supported by wall cleat - hardware provided by installer
- standard markerboard laminate with aluminum pvc edge
- spacing of attachment cleats allows wire management

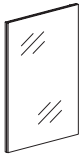
Description	D	W	H	CTN WT	CU FT	① Model	List Price
 Wall Mount Glass Markerboard	1 1/16	48	48 13/16	89	5	FLB4849WMMBG	\$3,844
	1 1/16	42	48 13/16	78	4	FLB4249WMMBG	\$3,477
	1 1/16	39	48 13/16	73	4	FLB3949WMMBG	\$3,293
	1 1/16	36	48 13/16	67	4	FLB3649WMMBG	\$3,112
	1 1/16	33	48 13/16	61	4	FLB3349WMMBG	\$2,930
	1 1/16	30	48 13/16	56	3	FLB3049WMMBG	\$2,744
	1 1/16	24	48 13/16	45	3	FLB2449WMMBG	\$2,376
	1 1/16	18	48 13/16	34	2	FLB1849WMMBG	\$1,917





Features:

- pair with secondary height units to achieve 69" overall height
- supported by wall cleat - hardware provided by installer
- white back painted glass with an aluminum profile frame
- spacing of attachment cleats allows wire management



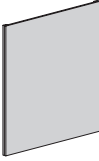

To Order, Specify:

① Laminate Model #	② Laminate Selection	③ Metal Color	④ Other Product Options
Laminate (FLT)	See Laminate Selection	See Metal Finish Color Options	See list of options for each specific unit; Specify and add accordingly.

① Veneer Model #	② Wood Species	③ Wood Finish	④ Metal Color	⑤ Other Product Options
Veneer (FLV)	Flat Cut CH1 Cherry MA1 Maple WA1 Walnut BO1 Black Oak	See Flat Cut Wood Finish Options	See Metal Finish Color Options	See list of options for each specific unit; Specify and add accordingly.
		③a Wood Finish See Double Cut Wood Finish Options		

Description	D	W	H	CTN WT	CU FT	① Model	List Price Per Grade	
 <p>48\"w Wall Mount Tack Panel</p> <p>Features:</p> <ul style="list-style-type: none"> · pair with secondary height units to achieve 69\" overall height · supported by wall cleat - hardware provided by installer · com ydg: 1 ½ 	1 ⅞	48	48 ¾	41	6	FLB4849WT	COM \$1,020	
	A	\$1,040						
	B	\$1,075						
	C	\$1,140						
	D	\$1,222						
	E	\$1,303						
	F	\$1,433						
	G	\$1,568						
	H	\$1,715						
	I	\$1,945						
	J	\$2,220						
	 <p>42\"w Wall Mount Tack Panel</p> <p>Features:</p> <ul style="list-style-type: none"> · pair with secondary height units to achieve 69\" overall height · supported by wall cleat - hardware provided by installer · com ydg: 1 ½ 	1 ⅞	42	48 ¾	38	5	FLB4249WT	COM \$948
		A	\$968					
B		\$1,002						
C		\$1,068						
D		\$1,151						
E		\$1,233						
F		\$1,362						
G		\$1,496						
H		\$1,643						
I		\$1,872						
J		\$2,147						
 <p>39\"w Wall Mount Tack Panel</p> <p>Features:</p> <ul style="list-style-type: none"> · pair with secondary height units to achieve 69\" overall height · supported by wall cleat - hardware provided by installer · com ydg: 1 ¼ 		1 ⅞	39	48 ¾	37	5	FLB3949WT	COM \$913
		A	\$928					
	B	\$959						
	C	\$1,011						
	D	\$1,082						
	E	\$1,151						
	F	\$1,256						
	G	\$1,371						
	H	\$1,493						
	I	\$1,684						
	J	\$1,912						
	 <p>36\"w Wall Mount Tack Panel</p> <p>Features:</p> <ul style="list-style-type: none"> · pair with secondary height units to achieve 69\" overall height · supported by wall cleat - hardware provided by installer · com ydg: 1 ¼ 	1 ⅞	36	48 ¾	36	4	FLB3649WT	COM \$877
		A	\$893					
B		\$924						
C		\$977						
D		\$1,045						
E		\$1,114						
F		\$1,220						
G		\$1,337						
H		\$1,456						
I		\$1,648						
J		\$1,877						

FLUX - PRIVATE OFFICE

Description	D	W	H	CTN WT	CU FT	① Model	List Price Per Grade
33" w Wall Mount Tack Panel	1 9/16	33	48 3/4	34	4	FLB3349WT	COM \$841
 <p>Features:</p> <ul style="list-style-type: none"> · pair with secondary height units to achieve 69" overall height · supported by wall cleat - hardware provided by installer · com ydg: 1 1/4 	A						\$856
	B						\$886
	C						\$940
	D						\$1,009
	E						\$1,078
	F						\$1,184
	G						\$1,299
	H						\$1,421
	I						\$1,611
	J						\$1,841
30" w Wall Mount Tack Panel	1 9/16	30	48 3/4	33	4	FLB3049WT	COM \$804
 <p>Features:</p> <ul style="list-style-type: none"> · pair with secondary height units to achieve 69" overall height · supported by wall cleat - hardware provided by installer · com ydg: 1 	A						\$817
	B						\$843
	C						\$885
	D						\$940
	E						\$996
	F						\$1,081
	G						\$1,173
	H						\$1,268
	I						\$1,422
	J						\$1,604
24" w Wall Mount Tack Panel	1 9/16	24	48 3/4	28	3	FLB2449WT	COM \$733
 <p>Features:</p> <ul style="list-style-type: none"> · pair with secondary height units to achieve 69" overall height · supported by wall cleat - hardware provided by installer · com ydg: 1 	A						\$747
	B						\$771
	C						\$813
	D						\$868
	E						\$924
	F						\$1,008
	G						\$1,101
	H						\$1,196
	I						\$1,349
	J						\$1,533
18" w Wall Mount Tack Panel	1 9/16	18	48 3/4	22	3	FLB1849WT	COM \$664
 <p>Features:</p> <ul style="list-style-type: none"> · pair with secondary height units to achieve 69" overall height · supported by wall cleat - hardware provided by installer · com ydg: 1 	A						\$675
	B						\$699
	C						\$742
	D						\$797
	E						\$852
	F						\$936
	G						\$1,031
	H						\$1,125
	I						\$1,281
	J						\$1,461

FLUX - PRIVATE OFFICE

To Order, Specify:

① Model Number	② Fabric Selection	
(FLB)	Vendor Pattern Color	Visit www.jsifurniture.com/finishes-and-materials/textiles for our textiles program. See selection of standard and graded in manufacturers and patterns.

Description	D	W	H	CTN WT	CU FT	① Model	Laminate	Flat Cut Veneer	Double Cut Veneer
 Workwall Panel with Mini Shelf	8 1/2	48	23 1/2	50	13	FLT4824WPMS	\$1,109		
	8 1/2	48	23 1/2	50	13	FLV4824WPMS		\$1,736	\$1,910
	8 1/2	42	23 1/2	36	8	FLT4224WPMS	\$945		
	8 1/2	42	23 1/2	36	8	FLV4224WPMS		\$1,484	\$1,631
	8 1/2	39	23 1/2	34	7	FLT3924WPMS	\$921		
	8 1/2	39	23 1/2	34	7	FLV3924WPMS		\$1,451	\$1,597
	8 1/2	36	23 1/2	31	7	FLT3624WPMS	\$898		
	8 1/2	36	23 1/2	31	7	FLV3624WPMS		\$1,417	\$1,560
	8 1/2	33	23 1/2	28	6	FLT3324WPMS	\$877		
	8 1/2	33	23 1/2	28	6	FLV3324WPMS		\$1,384	\$1,525
	8 1/2	30	23 1/2	26	6	FLT3024WPMS	\$855		
	8 1/2	30	23 1/2	26	6	FLV3024WPMS		\$1,357	\$1,490
	8 1/2	24	23 1/2	29	7	FLT2424WPMS	\$950		
	8 1/2	24	23 1/2	29	7	FLV2424WPMS		\$1,510	\$1,663

Features:

- pair with primary height units and overhead cabinets or shelves to achieve 69" overall height
- supported by wall cleat - hardware provided by installer
- grain direction runs vertical on flat cut veneer, horizontal on laminate
- spacing of attachment cleats allows wire management

Options:

- must specify grain direction on double cut veneer, see pages 11-13 for details
- tackboard or markerboard available for above the shelf, see pages 360-361

 Workwall Panel with File Shelf	8 1/2	48	23 1/2	38	13	FLT4824WPFF	\$1,188		
	8 1/2	48	23 1/2	38	13	FLV4824WPFF		\$1,741	\$1,916
	8 1/2	42	23 1/2	36	8	FLT4224WPFF	\$1,162		
	8 1/2	42	23 1/2	36	8	FLV4224WPFF		\$1,701	\$1,871
	8 1/2	39	23 1/2	34	7	FLT3924WPFF	\$1,140		
	8 1/2	39	23 1/2	34	7	FLV3924WPFF		\$1,669	\$1,836
	8 1/2	36	23 1/2	31	7	FLT3624WPFF	\$1,117		
	8 1/2	36	23 1/2	31	7	FLV3624WPFF		\$1,634	\$1,799
	8 1/2	33	23 1/2	28	6	FLT3324WPFF	\$1,095		
	8 1/2	33	23 1/2	28	6	FLV3324WPFF		\$1,604	\$1,766
	8 1/2	30	23 1/2	26	6	FLT3024WPFF	\$1,074		
	8 1/2	30	23 1/2	26	6	FLV3024WPFF		\$1,572	\$1,732

Features:

- pair with primary height units and overhead cabinets or shelves to achieve 69" overall height
- supported by wall cleat - hardware provided by installer
- grain direction runs vertical on flat cut veneer, horizontal on laminate
- file brackets for letter hanging file folders
- spacing of attachment cleats allows wire management

Options:

- must specify grain direction on double cut veneer, see pages 11-13 for details
- tackboard or markerboard available for above the shelf, see pages 360-361

 Workwall Panel with File Shelf	8 1/2	24	23 1/2	26	7	FLT2424WPF	\$1,052		
	8 1/2	24	23 1/2	26	7	FLV2424WPF		\$1,543	\$1,696

Features:

- pair with primary height units and overhead cabinets or shelves to achieve 69" overall height
- supported by wall cleat - hardware provided by installer
- grain direction runs vertical on flat cut veneer, horizontal on laminate
- file brackets for letter hanging file folders
- spacing of attachment cleats allows wire management

Options:

- must specify grain direction on double cut veneer, see pages 11-13 for details
- tackboard or markerboard available for above the shelf, see pages 360-361

Description	D	W	H	CTN WT	CU FT	① Model	Laminate	Flat Cut Veneer	Double Cut Veneer
 Workwall Panel with Accessory File Shelf	8 1/2	48	23 1/2	45	13	FLT4824WPCDF	\$1,188		
	8 1/2	48	23 1/2	45	13	FLV4824WPCDF		\$1,741	\$1,916
	8 1/2	42	23 1/2	37	8	FLT4224WPCDF	\$1,162		
	8 1/2	42	23 1/2	37	8	FLV4224WPCDF		\$1,701	\$1,871
	8 1/2	39	23 1/2	35	7	FLT3924WPCDF	\$1,140		
	8 1/2	39	23 1/2	35	7	FLV3924WPCDF		\$1,669	\$1,836
	8 1/2	36	23 1/2	33	7	FLT3624WPCDF	\$1,117		
	8 1/2	36	23 1/2	33	7	FLV3624WPCDF		\$1,634	\$1,799
	8 1/2	33	23 1/2	30	6	FLT3324WPCDF	\$1,095		
	8 1/2	33	23 1/2	30	6	FLV3324WPCDF		\$1,604	\$1,766
	8 1/2	30	23 1/2	27	6	FLT3024WPCDF	\$1,074		
	8 1/2	30	23 1/2	27	6	FLV3024WPCDF		\$1,572	\$1,732

Features:

- pair with primary height units and overhead cabinets or shelves to achieve 69" overall height
- supported by wall cleat - hardware provided by installer
- grain direction runs vertical on flat cut veneer, horizontal on laminate
- file brackets for letter hanging file folders
- includes plastic tool accessories; pencil cup and paper clip dish
- spacing of attachment cleats allows wire management

Options:

- must specify grain direction on double cut veneer, see pages 11-13 for details
- tackboard or markerboard available for above the shelf, see pages 360-361

Description	D	W	H	CTN WT	CU FT	① Model	Laminate	Flat Cut Veneer	Double Cut Veneer
 Workwall Panel with Accessory File Shelf	8 1/2	48	23 1/2	48	13	FLT4824WPFCD	\$1,188		
	8 1/2	48	23 1/2	48	13	FLV4824WPFCD		\$1,741	\$1,916
	8 1/2	42	23 1/2	38	8	FLT4224WPFCD	\$1,162		
	8 1/2	42	23 1/2	38	8	FLV4224WPFCD		\$1,701	\$1,871
	8 1/2	39	23 1/2	36	7	FLT3924WPFCD	\$1,140		
	8 1/2	39	23 1/2	36	7	FLV3924WPFCD		\$1,669	\$1,836
	8 1/2	36	23 1/2	34	7	FLT3624WPFCD	\$1,117		
	8 1/2	36	23 1/2	34	7	FLV3624WPFCD		\$1,634	\$1,799
	8 1/2	33	23 1/2	30	6	FLT3324WPFCD	\$1,095		
	8 1/2	33	23 1/2	30	6	FLV3324WPFCD		\$1,604	\$1,766
	8 1/2	30	23 1/2	28	6	FLT3024WPFCD	\$1,074		
	8 1/2	30	23 1/2	28	6	FLV3024WPFCD		\$1,572	\$1,732

Features:

- pair with primary height units and overhead cabinets or shelves to achieve 69" overall height
- supported by wall cleat - hardware provided by installer
- grain direction runs vertical on flat cut veneer, horizontal on laminate
- file brackets for letter hanging file folders
- includes plastic tool accessories; pencil cup and paper clip dish
- spacing of attachment cleats allows wire management

Options:

- must specify grain direction on double cut veneer, see pages 11-13 for details
- tackboard or markerboard available for above the shelf, see pages 360-361

To Order, Specify:

① Laminate Model #	② Laminate Selection	③ Metal Color	④ Other Product Options
Laminate (FLT)	See Laminate Selection	See Metal Finish Color Options	See list of options for each specific unit; Specify and add accordingly.

① Veneer Model #	② Wood Species	③ Wood Finish - Finishes with an asterisk (*) have a coordinating laminate available	④ Metal Color	⑤ Other Product Options		
Veneer (FLV)	Flat Cut CH1 Cherry MA1 Maple WA1 Walnut BO1 Black Oak	See Flat Cut Wood Finish Options	See Metal Finish Color Options	See list of options for each specific unit; Specify and add accordingly.		
	Double Cut DC1 Double Cut	<table border="1"> <thead> <tr> <th>ⓐ Wood Finish</th> <th>ⓑ Chassis Grain Direction</th> </tr> </thead> <tbody> <tr> <td>See Double Cut Wood Finish Options</td> <td>For Double Cut Only: Vertical Horizontal</td> </tr> </tbody> </table>	ⓐ Wood Finish		ⓑ Chassis Grain Direction	See Double Cut Wood Finish Options
ⓐ Wood Finish	ⓑ Chassis Grain Direction					
See Double Cut Wood Finish Options	For Double Cut Only: Vertical Horizontal					

Description	D	W	H	CTN WT	CU FT	① Model	Laminate	Flat Cut Veneer	Double Cut Veneer
Workwall Panel with Accessory Shelf 	8 1/2	48	23 1/2	47	13	FLT4824WPCDT	\$1,188		
	8 1/2	48	23 1/2	47	13	FLV4824WPCDT		\$1,741	\$1,916
	8 1/2	42	23 1/2	38	8	FLT4224WPCDT	\$1,162		
	8 1/2	42	23 1/2	38	8	FLV4224WPCDT		\$1,701	\$1,871
	8 1/2	39	23 1/2	36	7	FLT3924WPCDT	\$1,140		
	8 1/2	39	23 1/2	36	7	FLV3924WPCDT		\$1,669	\$1,836
	8 1/2	36	23 1/2	34	7	FLT3624WPCDT	\$1,117		
	8 1/2	36	23 1/2	34	7	FLV3624WPCDT		\$1,634	\$1,799
	8 1/2	33	23 1/2	30	6	FLT3324WPCDT	\$1,095		
	8 1/2	33	23 1/2	30	6	FLV3324WPCDT		\$1,604	\$1,766
	8 1/2	30	23 1/2	28	6	FLT3024WPCDT	\$1,074		
	8 1/2	30	23 1/2	28	6	FLV3024WPCDT		\$1,572	\$1,732
	8 1/2	24	23 1/2	27	7	FLT2424WPCDT	\$1,055		
	8 1/2	24	23 1/2	27	7	FLV2424WPCDT		\$1,543	\$1,696

Features:

- pair with primary height units and overhead cabinets or shelves to achieve 69" overall height
- supported by wall cleat - hardware provided by installer
- grain direction runs vertical on flat cut veneer, horizontal on laminate
- file brackets for letter hanging file folders
- includes plastic tool accessories; pencil cup, paper clip dish and utility tray

Options:

- spacing of attachment cleats allows wire management
- must specify grain direction on double cut veneer, see pages 11-13 for details

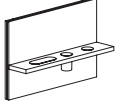
Description	D	W	H	CTN WT	CU FT	① Model	Laminate	Flat Cut Veneer	Double Cut Veneer
Workwall Panel with Accessory Shelf 	8 ½	48	23 ½	50	13	FLT4824WPTCD	\$1,188		
	8 ½	48	23 ½	50	13	FLV4824WPTCD		\$1,741	\$1,916
	8 ½	42	23 ½	38	8	FLT4224WPTCD	\$1,162		
	8 ½	42	23 ½	38	8	FLV4224WPTCD		\$1,701	\$1,871
	8 ½	39	23 ½	36	7	FLT3924WPTCD	\$1,140		
	8 ½	39	23 ½	36	7	FLV3924WPTCD		\$1,669	\$1,836
	8 ½	36	23 ½	34	7	FLT3624WPTCD	\$1,117		
	8 ½	36	23 ½	34	7	FLV3624WPTCD		\$1,634	\$1,799
	8 ½	33	23 ½	30	6	FLT3324WPTCD	\$1,095		
	8 ½	33	23 ½	30	6	FLV3324WPTCD		\$1,604	\$1,766
	8 ½	30	23 ½	28	6	FLT3024WPTCD	\$1,074		
	8 ½	30	23 ½	28	6	FLV3024WPTCD		\$1,572	\$1,732
	8 ½	24	23 ½	27	7	FLT2424WPTCD	\$1,055		
	8 ½	24	23 ½	27	7	FLV2424WPTCD		\$1,543	\$1,696

Features:

- pair with primary height units and overhead cabinets or shelves to achieve 69" overall height
- supported by wall cleat - hardware provided by installer
- grain direction runs vertical on flat cut veneer, horizontal on laminate
- includes black plastic tool accessories; pencil cup, paper clip dish and utility tray
- spacing of attachment cleats allows wire management

Options:

- must specify grain direction on double cut veneer, see pages 11-13 for details
- tackboard or markerboard available for above the shelf, see pages 360-361

To Order, Specify:

① Laminate Model #	② Laminate Selection	③ Metal Color	④ Other Product Options
Laminate (FLT)	See Laminate Selection	See Metal Finish Color Options	See list of options for each specific unit; Specify and add accordingly.

① Veneer Model #	② Wood Species	③ Wood Finish	④ Metal Color	⑤ Other Product Options
Veneer (FLV)	Flat Cut CH1 Cherry MA1 Maple WA1 Walnut BO1 Black Oak	See Flat Cut Wood Finish Options	See Metal Finish Color Options	See list of options for each specific unit; Specify and add accordingly.
		③a Wood Finish See Double Cut Wood Finish Options		

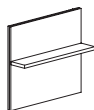
Description	D	W	H	CTN WT	CU FT	① Model	Laminate	Flat Cut Veneer	Double Cut Veneer
 Workwall Panel with Mini Shelf	8 1/2	48	31 1/2	58	17	FLT4832WPMS	\$1,102		
	8 1/2	48	31 1/2	58	17	FLV4832WPMS		\$1,733	\$1,907
	8 1/2	42	31 1/2	44	10	FLT4232WPMS	\$1,075		
	8 1/2	42	31 1/2	44	10	FLV4232WPMS		\$1,692	\$1,860
	8 1/2	39	31 1/2	41	9	FLT3932WPMS	\$1,048		
	8 1/2	39	31 1/2	41	9	FLV3932WPMS		\$1,654	\$1,818
	8 1/2	36	31 1/2	38	9	FLT3632WPMS	\$1,024		
	8 1/2	36	31 1/2	38	9	FLV3632WPMS		\$1,618	\$1,779
	8 1/2	33	31 1/2	35	8	FLT3332WPMS	\$999		
	8 1/2	33	31 1/2	35	8	FLV3332WPMS		\$1,580	\$1,738
	8 1/2	30	31 1/2	32	7	FLT3032WPMS	\$974		
	8 1/2	30	31 1/2	32	7	FLV3032WPMS		\$1,545	\$1,699
	8 1/2	24	31 1/2	34	9	FLT2432WPMS	\$936		
	8 1/2	24	31 1/2	34	9	FLV2432WPMS		\$1,510	\$1,663

Features:

- pair with secondary height units and overhead cabinets or shelves to achieve 69" overall height
- supported by wall cleat - hardware provided by installer
- grain direction runs vertical on flat cut veneer, horizontal on laminate
- spacing of attachment cleats allows wire management

Options:

- must specify grain direction on double cut veneer, see pages 11-13 for details
- tackboard or markerboard available for above the shelf, see pages 360-361

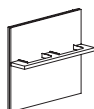
 Workwall Panel with File Shelf	8 1/2	48	31 1/2	51	17	FLT4832WPFF	\$1,322		
	8 1/2	48	31 1/2	51	17	FLV4832WPFF		\$1,949	\$2,144
	8 1/2	42	31 1/2	44	10	FLT4232WPFF	\$1,295		
	8 1/2	42	31 1/2	44	10	FLV4232WPFF		\$1,910	\$2,103
	8 1/2	39	31 1/2	41	9	FLT3932WPFF	\$1,266		
	8 1/2	39	31 1/2	41	9	FLV3932WPFF		\$1,871	\$2,059
	8 1/2	36	31 1/2	38	9	FLT3632WPFF	\$1,241		
	8 1/2	36	31 1/2	38	9	FLV3632WPFF		\$1,833	\$2,017
	8 1/2	33	31 1/2	35	8	FLT3332WPFF	\$1,217		
	8 1/2	33	31 1/2	35	8	FLV3332WPFF		\$1,797	\$1,978
	8 1/2	30	31 1/2	32	7	FLT3032WPFF	\$1,193		
	8 1/2	30	31 1/2	32	7	FLV3032WPFF		\$1,761	\$1,939

Features:

- pair with secondary height units and overhead cabinets or shelves to achieve 69" overall height
- supported by wall cleat - hardware provided by installer
- grain direction runs vertical on flat cut veneer, horizontal on laminate
- file brackets for letter hanging file folders

Options:

- must specify grain direction on double cut veneer, see pages 11-13 for details
- tackboard or markerboard available for above the shelf, see pages 360-361

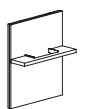
 Workwall Panel with File Shelf	8 1/2	24	31 1/2	31	9	FLT2432WPF	\$1,168		
	8 1/2	24	31 1/2	31	9	FLV2432WPF		\$1,915	\$2,106

Features:

- pair with secondary height units and overhead cabinets or shelves to achieve 69" overall height
- supported by wall cleat - hardware provided by installer
- grain direction runs vertical on flat cut veneer, horizontal on laminate
- file brackets for letter hanging file folders

Options:

- must specify grain direction on double cut veneer, see pages 11-13 for details
- tackboard or markerboard available for above the shelf, see pages 360-361

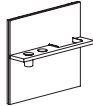
Description	D	W	H	CTN WT	CU FT	① Model	Laminate	Flat Cut Veneer	Double Cut Veneer
 Workwall Panel with Accessory File Shelf	8 1/2	48	31 1/2	55	17	FLT4832WPCDF	\$1,322		
	8 1/2	48	31 1/2	55	17	FLV4832WPCDF		\$1,949	\$2,144
	8 1/2	42	31 1/2	46	10	FLT4232WPCDF	\$1,295		
	8 1/2	42	31 1/2	46	10	FLV4232WPCDF		\$1,910	\$2,103
	8 1/2	39	31 1/2	43	9	FLT3932WPCDF	\$1,266		
	8 1/2	39	31 1/2	43	9	FLV3932WPCDF		\$1,871	\$2,059
	8 1/2	36	31 1/2	40	9	FLT3632WPCDF	\$1,241		
	8 1/2	36	31 1/2	40	9	FLV3632WPCDF		\$1,833	\$2,017
	8 1/2	33	31 1/2	36	8	FLT3332WPCDF	\$1,217		
	8 1/2	33	31 1/2	36	8	FLV3332WPCDF		\$1,797	\$1,978
	8 1/2	30	31 1/2	33	7	FLT3032WPCDF	\$1,193		
	8 1/2	30	31 1/2	33	7	FLV3032WPCDF		\$1,761	\$1,939

Features:

- pair with secondary height units and overhead cabinets or shelves to achieve 69" overall height
- supported by wall cleat - hardware provided by installer
- grain direction runs vertical on flat cut veneer, horizontal on laminate
- file brackets for letter hanging file folders
- includes plastic tool accessories; pencil cup and paper clip dish
- spacing of attachment cleats allows wire management

Options:

- must specify grain direction on double cut veneer, see pages 11-13 for details
- tackboard or markerboard available for above the shelf, see pages 360-361

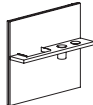
Description	D	W	H	CTN WT	CU FT	① Model	Laminate	Flat Cut Veneer	Double Cut Veneer
 Workwall Panel with Accessory File Shelf	8 1/2	48	31 1/2	58	17	FLT4832WPFCD	\$1,322		
	8 1/2	48	31 1/2	58	17	FLV4832WPFCD		\$1,949	\$2,144
	8 1/2	42	31 1/2	46	10	FLT4232WPFCD	\$1,295		
	8 1/2	42	31 1/2	46	10	FLV4232WPFCD		\$1,910	\$2,103
	8 1/2	39	31 1/2	43	9	FLT3932WPFCD	\$1,266		
	8 1/2	39	31 1/2	43	9	FLV3932WPFCD		\$1,871	\$2,059
	8 1/2	36	31 1/2	40	9	FLT3632WPFCD	\$1,241		
	8 1/2	36	31 1/2	40	9	FLV3632WPFCD		\$1,833	\$2,017
	8 1/2	33	31 1/2	36	8	FLT3332WPFCD	\$1,217		
	8 1/2	33	31 1/2	36	8	FLV3332WPFCD		\$1,797	\$1,978
	8 1/2	33	31 1/2	33	7	FLT3032WPFCD	\$1,193		
	8 1/2	33	31 1/2	33	7	FLV3032WPFCD		\$1,761	\$1,939

Features:

- pair with secondary height units and overhead cabinets or shelves to achieve 69" overall height
- supported by wall cleat - hardware provided by installer
- grain direction runs vertical on flat cut veneer, horizontal on laminate
- file brackets for letter hanging file folders
- includes plastic tool accessories; pencil cup and paper clip dish
- spacing of attachment cleats allows wire management

Options:

- must specify grain direction on double cut veneer, see pages 11-13 for details

To Order, Specify:

① Laminate Model #	② Laminate Selection	③ Metal Color	④ Other Product Options
Laminate (FLT)	See Laminate Selection	See Metal Finish Color Options	See list of options for each specific unit; Specify and add accordingly.

① Veneer Model #	② Wood Species	③ Wood Finish	④ Metal Color	⑤ Other Product Options
Veneer (FLV)	Flat Cut CH1 Cherry MA1 Maple WA1 Walnut BO1 Black Oak	See Flat Cut Wood Finish Options	See Metal Finish Color Options	See list of options for each specific unit; Specify and add accordingly.
		③a Wood Finish See Double Cut Wood Finish Options		

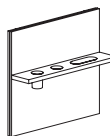
Description	D	W	H	CTN WT	CU FT	① Model	Laminate	Flat Cut Veneer	Double Cut Veneer
Workwall Panel with Accessory Shelf 	8 1/2	48	31 1/2	56	17	FLT4832WPCDT	\$1,322		
	8 1/2	48	31 1/2	56	17	FLV4832WPCDT		\$1,949	\$2,144
	8 1/2	42	31 1/2	47	10	FLT4232WPCDT	\$1,295		
	8 1/2	42	31 1/2	47	10	FLV4232WPCDT		\$1,910	\$2,103
	8 1/2	39	31 1/2	44	9	FLT3932WPCDT	\$1,266		
	8 1/2	39	31 1/2	44	9	FLV3932WPCDT		\$1,871	\$2,059
	8 1/2	36	31 1/2	41	9	FLT3632WPCDT	\$1,241		
	8 1/2	36	31 1/2	41	9	FLV3632WPCDT		\$1,833	\$2,017
	8 1/2	33	31 1/2	37	8	FLT3332WPCDT	\$1,217		
	8 1/2	33	31 1/2	37	8	FLV3332WPCDT		\$1,797	\$1,978
	8 1/2	30	31 1/2	34	7	FLT3032WPCDT	\$1,193		
	8 1/2	30	31 1/2	34	7	FLV3032WPCDT		\$1,761	\$1,939
	8 1/2	24	31 1/2	31	9	FLT2432WPCDT	\$1,168		
	8 1/2	24	31 1/2	31	9	FLV2432WPCDT		\$1,915	\$2,106

Features:

- pair with secondary height units and overhead cabinets or shelves to achieve 69" overall height
- supported by wall cleat - hardware provided by installer
- grain direction runs vertical on flat cut veneer, horizontal on laminate
- includes plastic tool accessories; pencil cup, paper clip dish and utility tray
- spacing of attachment cleats allows wire management

Options:

- must specify grain direction on double cut veneer, see pages 11-13 for details
- tackboard or markerboard available for above the shelf, see pages 360-361

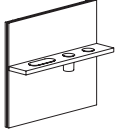
Description	D	W	H	CTN WT	CU FT	① Model	Laminate	Flat Cut Veneer	Double Cut Veneer
Workwall Panel with Accessory Shelf 	8 ½	48	31 ½	59	17	FLT4832WPTCD	\$1,322		
	8 ½	48	31 ½	59	17	FLV4832WPTCD		\$1,949	\$2,144
	8 ½	42	31 ½	47	10	FLT4232WPTCD	\$1,295		
	8 ½	42	31 ½	47	10	FLV4232WPTCD		\$1,910	\$2,103
	8 ½	39	31 ½	44	9	FLT3932WPTCD	\$1,266		
	8 ½	39	31 ½	44	9	FLV3932WPTCD		\$1,871	\$2,059
	8 ½	36	31 ½	41	9	FLT3632WPTCD	\$1,241		
	8 ½	36	31 ½	41	9	FLV3632WPTCD		\$1,833	\$2,017
	8 ½	33	31 ½	37	8	FLT3332WPTCD	\$1,217		
	8 ½	33	31 ½	37	8	FLV3332WPTCD		\$1,797	\$1,978
	8 ½	30	31 ½	34	7	FLT3032WPTCD	\$1,193		
	8 ½	30	31 ½	34	7	FLV3032WPTCD		\$1,761	\$1,939
	8 ½	24	31 ½	34	9	FLT2432WPTCD	\$1,168		
	8 ½	24	31 ½	34	9	FLV2432WPTCD		\$1,915	\$2,106

Features:

- pair with secondary height units and overhead cabinets or shelves to achieve 69" overall height
- supported by wall cleat - hardware provided by installer
- grain direction runs vertical on flat cut veneer, horizontal on laminate
- includes black plastic tool accessories; pencil cup, paper clip dish and utility tray
- spacing of attachment cleats allows wire management

Options:

- must specify grain direction on double cut veneer, see pages 11-13 for details
- tackboard or markerboard available for above the shelf, see pages 360-361

Description	D	W	H	CTN WT	CU FT	① Model	List Price
Work Tool Set	3	2	6	2	1	FLBWTOOLS	\$68

Features:

- work tool accessory set - utility cup, dish, and tray
- black plastic

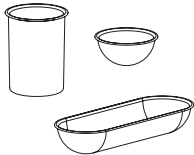

To Order, Specify:

① Laminate Model #	② Laminate Selection	③ Metal Color	④ Other Product Options
Laminate (FLT)	See Laminate Selection	See Metal Finish Color Options	See list of options for each specific unit; Specify and add accordingly.

① Veneer Model #	② Wood Species	③ Wood Finish	④ Metal Color	⑤ Other Product Options
Veneer (FLV)	Flat Cut CH1 Cherry MA1 Maple WA1 Walnut BO1 Black Oak	See Flat Cut Wood Finish Options	See Metal Finish Color Options	See list of options for each specific unit; Specify and add accordingly.
		③a Wood Finish See Double Cut Wood Finish Options		

Description	D	W	H	CTN WT	CU FT	① Model	List Price
Workwall Panels	¾	48	12½			FLB4813MBA	\$341
Markerboard Add	1 ⅙	42	12 ⅙	15	2	FLB4213MBA	\$312
	1 ⅙	39	12 ⅙	14	2	FLB3913MBA	\$283
	1 ⅙	36	12 ⅙	13	1	FLB3613MBA	\$259
	1 ⅙	33	12 ⅙	12	1	FLB3313MBA	\$235
	1 ⅙	30	12 ⅙	11	1	FLB3013MBA	\$214
	¾	24	12½			FLB2413MBA	\$194

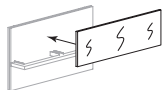

- Features:**
- mounts with magnets above the shelf - template included
 - standard markerboard laminate with aluminum pvc edge

Description	D	W	H	CTN WT	CU FT	① Model	List Price Per Grade
48" w Insert Tackboard	¾	48	12½	5	2	FLB4813WTK	COM \$369

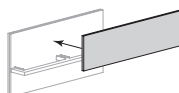

- Features:**
- attaches to cabinet interior, mounting hardware included
 - com ydg: 1 ¾

- A \$391
- B \$431
- C \$503
- D \$598
- E \$689
- F \$835
- G \$990
- H \$1,155
- I \$1,412
- J \$1,721

42" w Insert Tackboard	1 ⅙	42	12 ⅙	4	2	FLB4213WTK	COM \$368
------------------------	-----	----	------	---	---	------------	-----------

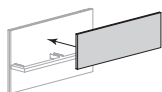

- Features:**
- attaches to cabinet interior, mounting hardware included
 - com ydg: 1 ½

- A \$389
- B \$424
- C \$488
- D \$571
- E \$653
- F \$782
- G \$919
- H \$1,064
- I \$1,295
- J \$1,567

39" w Insert Tackboard	1 ⅙	39	12 ⅙	4	2	FLB3913WTK	COM \$358
------------------------	-----	----	------	---	---	------------	-----------

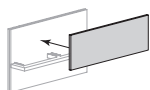

- Features:**
- attaches to cabinet interior, mounting hardware included
 - com ydg: 1 ¼

- A \$375
- B \$405
- C \$459
- D \$527
- E \$596
- F \$703
- G \$816
- H \$937
- I \$1,129
- J \$1,360

FLUX - PRIVATE OFFICE

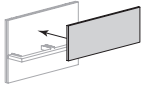
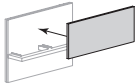
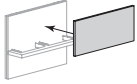
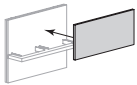
Description	D	W	H	CTN WT	CU FT	① Model	List Price Per Grade
36" w Insert Tackboard 	1 9/16	36	12 1/16	4	2	FLB3613WTK	COM \$349 A \$364 B \$396 C \$449 D \$519 E \$587 F \$691 G \$807 H \$929 I \$1,120 J \$1,348
33" w Insert Tackboard 	1 9/16	33	12 1/16	3	2	FLB3313WTK	COM \$340 A \$356 B \$387 C \$439 D \$509 E \$578 F \$683 G \$799 H \$921 I \$1,111 J \$1,340
30" w Insert Tackboard 	1 9/16	30	12 1/16	3	2	FLB3013WTK	COM \$333 A \$345 B \$366 C \$410 D \$466 E \$521 F \$606 G \$697 H \$795 I \$948 J \$1,130
24" w Insert Tackboard 	3/4	24	12 1/2	2	2	FLB2413WTK	COM \$310 A \$323 B \$346 C \$388 D \$441 E \$494 F \$577 G \$666 H \$758 I \$907 J \$1,083

Features:

- attaches to cabinet interior, mounting hardware included
- com ydg: 1 1/4

Features:

- attaches to cabinet interior, mounting hardware included
- com ydg: 1 1/4

Features:

- attaches to cabinet interior, mounting hardware included
- com ydg: 1

Features:

- attaches to cabinet interior, mounting hardware included
- com ydg: 1

To Order, Specify:

① Model Number	② Fabric Selection
(FLB)	Vendor Pattern Color

FLUX - PRIVATE OFFICE

Description	D	W	H	CTN WT	CU FT	① Model	Laminate	Flat Cut Veneer	Double Cut Veneer
52" h Two Door Storage Tower	15 $\frac{1}{16}$ "	35 $\frac{7}{8}$ "	52	183	22	FLT1636-52STD	\$1,939		
	15 $\frac{1}{16}$ "	35 $\frac{7}{8}$ "	52	183	22	FLV1636-52STD		\$2,981	\$3,278
	15 $\frac{1}{16}$ "	29 $\frac{7}{8}$ "	52	169	19	FLT1630-52STD	\$1,604		
	15 $\frac{1}{16}$ "	29 $\frac{7}{8}$ "	52	169	19	FLV1630-52STD		\$2,466	\$2,714

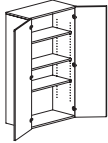
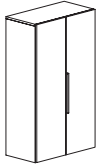

Features:

- use with primary height units, fastening hardware included
- laminate grain direction runs vertical on back panel of storage towers
- four adjustable shelves

Options:

- must specify chassis grain direction on double cut veneer, see pages 11-13 for details
- veneer door fronts in paint available, specify paint color and add \$337 list; see page 14 for details
- on laminate units, contrasting laminate door fronts available, no upcharge; specify laminate color, see page 14 for details
- white glass doors with aluminum trim available, specify and add \$2,548 list for 36" w, \$2,212 list for 30" w; see page 31 for details
- markerboard laminate doors available, specify and add \$442 list; see page 31 for details
- ledge pull standard on the right hinge door, prism pull available, specify and see page 9
- locking doors available, specify and add \$142 list (not available on glass doors)

52" h Sliding Door Storage Tower	15 $\frac{1}{16}$ "	35 $\frac{7}{8}$ "	52	182	22	FLT1636-52STSD	\$2,171		
	15 $\frac{1}{16}$ "	35 $\frac{7}{8}$ "	52	182	22	FLV1636-52STSD		\$3,338	\$3,671
	15 $\frac{1}{16}$ "	29 $\frac{7}{8}$ "	52	167	18	FLT1630-52STSD	\$1,797		
	15 $\frac{1}{16}$ "	29 $\frac{7}{8}$ "	52	167	18	FLV1630-52STSD		\$2,761	\$3,039

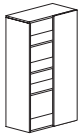
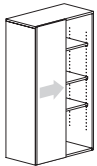

Features:

- use with primary height units, fastening hardware included
- laminate grain direction runs vertical on back panel of storage towers
- four adjustable shelves
- locking not available

Options:

- must specify chassis grain direction on double cut veneer, see pages 11-13 for details
- veneer door fronts in paint available, specify paint color and add \$337 list; see page 14 for details
- on laminate units, contrasting laminate door fronts available, no upcharge; specify laminate color, see page 14 for details
- white glass doors with aluminum trim available, specify and add \$1,318 list for 36" w, \$1,148 list for 30" w; see page 31 for details
- markerboard laminate doors available, specify and add \$286 list; see page 31 for details

52" h Open Storage Tower	15	35 $\frac{7}{8}$ "	52	136	21	FLT1536-52STO	\$1,320		
	15	35 $\frac{7}{8}$ "	52	136	21	FLV1536-52STO		\$2,026	\$2,231
	15	29 $\frac{7}{8}$ "	52	123	18	FLT1530-52STO	\$1,202		
	15	29 $\frac{7}{8}$ "	52	123	18	FLV1530-52STO		\$1,849	\$2,034

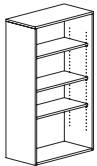

Features:

- use with primary height units, fastening hardware included
- laminate grain direction runs vertical on back panel of storage towers
- four adjustable shelves

Options:

- must specify chassis grain direction on double cut veneer, see pages 11-13 for details

52" h Side Wardrobe with Open Shelf	15 $\frac{1}{16}$ "	35 $\frac{7}{8}$ "	52	138	22	FLT1636-52STSWR	\$1,497		
	15 $\frac{1}{16}$ "	35 $\frac{7}{8}$ "	52	138	22	FLV1636-52STSWR		\$2,304	\$2,532
	15 $\frac{1}{16}$ "	35 $\frac{7}{8}$ "	52	137	22	FLT1636-52STSWL	\$1,497		
	15 $\frac{1}{16}$ "	35 $\frac{7}{8}$ "	52	137	22	FLV1636-52STSWL		\$2,304	\$2,532
	15 $\frac{1}{16}$ "	29 $\frac{7}{8}$ "	52	130	18	FLT1630-52STSWR	\$1,434		
	15 $\frac{1}{16}$ "	29 $\frac{7}{8}$ "	52	130	18	FLV1630-52STSWR		\$2,203	\$2,426
	15 $\frac{1}{16}$ "	29 $\frac{7}{8}$ "	52	129	18	FLT1630-52STSWL	\$1,434		
	15 $\frac{1}{16}$ "	29 $\frac{7}{8}$ "	52	129	18	FLV1630-52STSWL		\$2,203	\$2,426

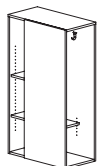
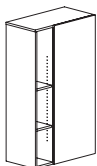

right shown

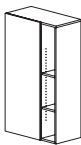
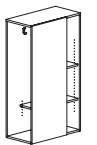

left

Features:

- use with primary height units, fastening hardware included
- side entry wardrobe with two coat hooks
- 8 $\frac{1}{4}$ " w open compartment with three adjustable shelves

Options:

- must specify chassis grain direction on double cut veneer, see pages 11-13 for details

Description	D	W	H	CTN WT	CU FT	① Model	Laminate	Flat Cut Veneer	Double Cut Veneer
52" h Storage Tower	15 $\frac{7}{8}$	17 $\frac{7}{8}$	52	126	12	FLT1618-52STDR	\$1,264		
	15 $\frac{7}{8}$	17 $\frac{7}{8}$	52	126	12	FLV1618-52STDR		\$1,943	\$2,139
	15 $\frac{7}{8}$	17 $\frac{7}{8}$	52	126	12	FLT1618-52STD L	\$1,264		
	15 $\frac{7}{8}$	17 $\frac{7}{8}$	52	126	12	FLV1618-52STD L		\$1,943	\$2,139

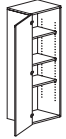

left shown

Features:

- use with primary height units, fastening hardware included
- laminate grain direction runs vertical on back panel of storage towers
- four adjustable shelves

Options:

- must specify chassis grain direction on double cut veneer, see pages 11-13 for details
- veneer door fronts in paint available, specify paint color and add \$337 list; see page 14 for details
- on laminate units, contrasting laminate door fronts available, no upcharge; specify laminate color, see page 14 for details
- white glass doors with aluminum trim available, specify and add \$1,276 list; see page 31 for details
- markerboard laminate doors available, specify and add \$286 list; see page 31 for details
- ledge pulls standard; prism pulls available, specify and see page 9
- locking door available, specify and add \$142 list (not available on glass door)

52" h Open Storage Tower	15	17 $\frac{7}{8}$	52	108	11	FLT1518-52STO	\$1,202		
	15	17 $\frac{7}{8}$	52	108	11	FLV1518-52STO		\$1,849	\$2,034

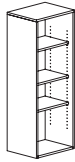

Features:

- use with primary height units, fastening hardware included
- laminate grain direction runs vertical on back panel of storage towers
- three adjustable shelves

Options:

- must specify chassis grain direction on double cut veneer, see pages 11-13 for details

To Order, Specify:

① Laminate Model #	② Laminate Selection	③ Metal Color	④ Other Product Options
Laminate (FLT)	See Laminate Selection	See Metal Finish Color Options	See list of options for each specific unit; Specify and add accordingly.

① Veneer Model #	② Wood Species	③ Wood Finish	④ Metal Color	⑤ Other Product Options
Veneer (FLV)	Flat Cut CH1 Cherry MA1 Maple WA1 Walnut BO1 Black Oak	See Flat Cut Wood Finish Options	See Metal Finish Color Options	See list of options for each specific unit; Specify and add accordingly.
		③a Wood Finish See Double Cut Wood Finish Options		

Description	D	W	H	CTN WT	CU FT	Model	Laminate	Flat Cut Veneer	Double Cut Veneer
40" h Two Door Storage Tower	15 $\frac{1}{8}$ "	35 $\frac{7}{8}$ "	40	130	17	FLT1636-40STD	\$1,565		
	15 $\frac{1}{8}$ "	35 $\frac{7}{8}$ "	40	130	17	FLV1636-40STD		\$2,406	\$2,647
	15 $\frac{1}{8}$ "	29 $\frac{7}{8}$ "	40	115	14	FLT1630-40STD	\$1,296		
	15 $\frac{1}{8}$ "	29 $\frac{7}{8}$ "	40	115	14	FLV1630-40STD		\$1,992	\$2,190

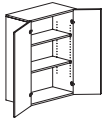
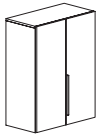

Features:

- use with primary height units, fastening hardware included
- laminate grain direction runs vertical on back panel of storage towers
- two adjustable shelves

Options:

- must specify chassis grain direction on double cut veneer, see pages 11-13 for details
- veneer door fronts in paint available, specify paint color and add \$337 list; see page 14 for details
- on laminate units, contrasting laminate door fronts available, no upcharge; specify laminate color, see page 14 for details
- white glass doors with aluminum trim available, specify and add \$2,034 list for 36" w, \$1,775 list for 30" w; see page 31 for details
- markerboard laminate doors available, specify and add \$442 list; see page 31 for details
- ledge pull standard on the right hinge door, prism pull available, specify and see page 9
- locking doors available, specify and add \$138 list (not available on glass doors)

40" h Sliding Door Storage Tower	15 $\frac{1}{8}$ "	35 $\frac{7}{8}$ "	40	129	17	FLT1636-40STSD	\$1,752		
	15 $\frac{1}{8}$ "	35 $\frac{7}{8}$ "	40	129	17	FLV1636-40STSD		\$2,694	\$2,965
	15 $\frac{1}{8}$ "	29 $\frac{7}{8}$ "	40	115	14	FLT1630-40STSD	\$1,451		
	15 $\frac{1}{8}$ "	29 $\frac{7}{8}$ "	40	115	14	FLV1630-40STSD		\$2,231	\$2,453

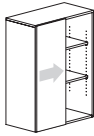

Features:

- use with primary height units, fastening hardware included
- laminate grain direction runs vertical on back panel of storage towers
- two adjustable shelves
- locking not available

Options:

- must specify chassis grain direction on double cut veneer, see pages 11-13 for details
- veneer door fronts in paint available, specify paint color and add \$337 list; see page 14 for details
- on laminate units, contrasting laminate door fronts available, no upcharge; specify laminate color, see page 14 for details
- white glass doors with aluminum trim available, specify and add \$1,081 list for 36" w, \$966 list for 30" w; see page 31 for details
- markerboard laminate doors available, specify and add \$286 list; see page 31 for details

40" h Open Storage Tower	15	35 $\frac{7}{8}$ "	40	103	16	FLT1536-40STO	\$1,064		
	15	35 $\frac{7}{8}$ "	40	103	16	FLV1536-40STO		\$1,636	\$1,802
	15	29 $\frac{7}{8}$ "	40	95	14	FLT1530-40STO	\$971		
	15	29 $\frac{7}{8}$ "	40	95	14	FLV1530-40STO		\$1,493	\$1,642

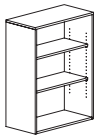

Features:

- use with primary height units, fastening hardware included
- laminate grain direction runs vertical on back panel of storage towers
- two adjustable shelves

Options:

- must specify chassis grain direction on double cut veneer, see pages 11-13 for details

40" h Side Wardrobe with Open Shelf	15 $\frac{1}{8}$ "	35 $\frac{7}{8}$ "	40	115	17	FLT1636-40STSWR	\$1,440		
	15 $\frac{1}{8}$ "	35 $\frac{7}{8}$ "	40	115	17	FLV1636-40STSWR		\$2,212	\$2,434
	15 $\frac{1}{8}$ "	35 $\frac{7}{8}$ "	40	115	17	FLT1636-40STSWL	\$1,440		
	15 $\frac{1}{8}$ "	35 $\frac{7}{8}$ "	40	115	17	FLV1636-40STSWL		\$2,212	\$2,434
	15 $\frac{1}{8}$ "	29 $\frac{7}{8}$ "	40	109	14	FLT1630-40STSWR	\$1,378		
	15 $\frac{1}{8}$ "	29 $\frac{7}{8}$ "	40	109	14	FLV1630-40STSWR		\$2,116	\$2,329
	15 $\frac{1}{8}$ "	29 $\frac{7}{8}$ "	40	109	14	FLT1630-40STSWL	\$1,378		
	15 $\frac{1}{8}$ "	29 $\frac{7}{8}$ "	40	109	14	FLV1630-40STSWL		\$2,116	\$2,329

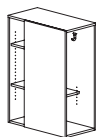
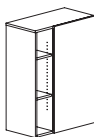

right shown

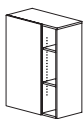
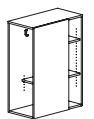

left

Features:

- use with primary height units, fastening hardware included
- side entry wardrobe with two coat hooks
- 8 $\frac{1}{4}$ " w open compartment with two adjustable shelves

Options:

- must specify chassis grain direction on double cut veneer, see pages 11-13 for details

Description	D	W	H	CTN WT	CU FT	① Model	Laminate	Flat Cut Veneer	Double Cut Veneer
40" h Storage Tower	15 $\frac{7}{8}$	17 $\frac{7}{8}$	40	91	9	FLT1618-40STDR	\$1,021		
	15 $\frac{7}{8}$	17 $\frac{7}{8}$	40	91	9	FLV1618-40STDR		\$1,569	\$1,730
	15 $\frac{7}{8}$	17 $\frac{7}{8}$	40	91	10	FLT1618-40STDL	\$1,021		
	15 $\frac{7}{8}$	17 $\frac{7}{8}$	40	91	10	FLV1618-40STDL		\$1,569	\$1,730

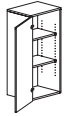
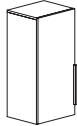

left shown

Features:

- use with primary height units, fastening hardware included
- laminate grain direction runs vertical on back panel of storage towers
- two adjustable shelves

Options:

- must specify chassis grain direction on double cut veneer, see pages 11-13 for details
- veneer door fronts in paint available, specify paint color and add \$337 list; see page 14 for details
- on laminate units, contrasting laminate door fronts available, no upcharge; specify laminate color, see page 14 for details
- white glass doors with aluminum trim available, specify and add \$1,019 list; see page 31 for details
- markerboard laminate doors available, specify and add \$286 list; see page 31 for details
- ledge pulls standard; prism pulls available, specify and see page 9
- locking door available, specify and add \$142 list (not available on glass door)

40" h Open Storage Tower	15	17 $\frac{7}{8}$	40	83	9	FLT1518-40STO	\$971		
	15	17 $\frac{7}{8}$	40	83	9	FLV1518-40STO		\$1,493	\$1,642

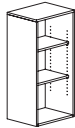

Features:

- use with primary height units, fastening hardware included
- laminate grain direction runs vertical on back panel of storage towers
- two adjustable shelves

Options:

- must specify chassis grain direction on double cut veneer, see pages 11-13 for details

To Order, Specify:

① Laminate Model #	② Laminate Selection	③ Metal Color	④ Other Product Options
Laminate (FLT)	See Laminate Selection	See Metal Finish Color Options	See list of options for each specific unit; Specify and add accordingly.

① Veneer Model #	② Wood Species	③ Wood Finish	④ Metal Color	⑤ Other Product Options
Veneer (FLV)	Flat Cut CH1 Cherry MA1 Maple WA1 Walnut BO1 Black Oak	See Flat Cut Wood Finish Options	See Metal Finish Color Options	See list of options for each specific unit; Specify and add accordingly.
		③a Wood Finish See Double Cut Wood Finish Options		

Description	D	W	H	CTN WT	CU FT	① Model	Laminate	Flat Cut Veneer	Double Cut Veneer
48" h Two Door Storage Tower	15 ⁷ / ₈	35 ⁷ / ₈	48	151	20	FLT1636-48STD	\$1,848		
	15 ⁷ / ₈	35 ⁷ / ₈	48	151	20	FLV1636-48STD		\$2,838	\$3,124
	15 ⁷ / ₈	29 ⁷ / ₈	48	137	17	FLT1630-48STD	\$1,528		
	15 ⁷ / ₈	29 ⁷ / ₈	48	137	17	FLV1630-48STD		\$2,350	\$2,582

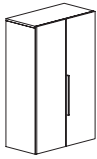

Features:

- use with secondary height units, fastening hardware included
- laminate grain direction runs vertical on back panel of storage towers
- three adjustable shelves

Options:

- must specify chassis grain direction on double cut veneer, see pages 11-13 for details
- veneer door fronts in paint available, specify paint color and add \$337 list; see page 14 for details
- on laminate units, contrasting laminate door fronts available, no upcharge; specify laminate color, see page 14 for details
- white glass doors with aluminum trim available, specify and add \$2,395 list for 36" w, \$2,086 list for 30" w; see page 31 for details
- markerboard laminate doors available, specify and add \$442 list; see page 31 for details
- ledge pull standard on the right hinge door, prism pull available, specify and see page 9
- locking doors available, specify and add \$138 list (not available on glass doors)

48" h Sliding Door Storage Tower	15 ¹⁵ / ₁₆	35 ⁷ / ₈	48	150	20	FLT1636-48STSD	\$2,068		
	15 ¹⁵ / ₁₆	35 ⁷ / ₈	48	150	20	FLV1636-48STSD		\$3,180	\$3,499
	15 ¹⁵ / ₁₆	29 ⁷ / ₈	48	136	17	FLT1630-48STSD	\$1,711		
	15 ¹⁵ / ₁₆	29 ⁷ / ₈	48	136	17	FLV1630-48STSD		\$2,632	\$2,894

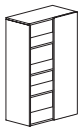
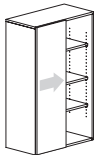

Features:

- use with secondary height units, fastening hardware included
- laminate grain direction runs vertical on back panel of storage towers
- three adjustable shelves
- locking not available

Options:

- must specify chassis grain direction on double cut veneer, see pages 11-13 for details
- veneer door fronts in paint available, specify paint color and add \$337 list; see page 14 for details
- on laminate units, contrasting laminate door fronts available, no upcharge; specify laminate color, see page 14 for details
- white glass doors with aluminum trim available, specify and add \$1,208 list for 36" w, \$1,057 list for 30" w; see page 31 for details
- markerboard laminate doors available, specify and add \$286 list; see page 31 for details

48" h Open Storage Tower	15	35 ⁷ / ₈	48	114	19	FLT1536-48STO	\$1,256		
	15	35 ⁷ / ₈	48	114	19	FLV1536-48STO		\$1,931	\$2,125
	15	29 ⁷ / ₈	48	104	16	FLT1530-48STO	\$1,146		
	15	29 ⁷ / ₈	48	104	16	FLV1530-48STO		\$1,760	\$1,938

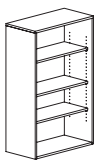

Features:

- use with secondary height units, fastening hardware included
- laminate grain direction runs vertical on back panel of storage towers
- three adjustable shelves

Options:

- must specify chassis grain direction on double cut veneer, see pages 11-13 for details

48" h Side Wardrobe with Open Shelf	15 ¹³ / ₁₆	35 ⁷ / ₈	48	121	20	FLT1636-48STSWR	\$1,470		
	15 ¹³ / ₁₆	35 ⁷ / ₈	48	121	20	FLV1636-48STSWR		\$2,258	\$2,482
	15 ¹³ / ₁₆	35 ⁷ / ₈	48	121	20	FLT1636-48STSWL	\$1,470		
	15 ¹³ / ₁₆	35 ⁷ / ₈	48	121	20	FLV1636-48STSWL		\$2,258	\$2,482
	15 ¹³ / ₁₆	29 ⁷ / ₈	48	114	17	FLT1630-48STSWR	\$1,406		
	15 ¹³ / ₁₆	29 ⁷ / ₈	48	114	17	FLV1630-48STSWR		\$2,160	\$2,376
	15 ¹³ / ₁₆	29 ⁷ / ₈	48	114	17	FLT1630-48STSWL	\$1,406		
	15 ¹³ / ₁₆	29 ⁷ / ₈	48	114	17	FLV1630-48STSWL		\$2,160	\$2,376

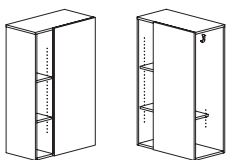

right shown

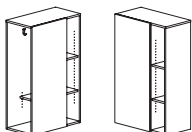

left

Features:

- use with secondary height units, fastening hardware included
- side entry wardrobe with two coat hooks
- 8¹/₄" w open compartment with three adjustable shelves

Options:

- must specify chassis grain direction on double cut veneer, see pages 11-13 for details

Description	D	W	H	CTN WT	CU FT	① Model	Laminate	Flat Cut Veneer	Double Cut Veneer
48" h Storage Tower	15 $\frac{7}{8}$	17 $\frac{7}{8}$	48	105	11	FLT1618-48STDR	\$1,205		
	15 $\frac{7}{8}$	17 $\frac{7}{8}$	48	105	11	FLV1618-48STDR		\$1,852	\$2,039
	15 $\frac{7}{8}$	17 $\frac{7}{8}$	48	105	11	FLT1618-48STDL	\$1,205		
	15 $\frac{7}{8}$	17 $\frac{7}{8}$	48	105	11	FLV1618-48STDL		\$1,852	\$2,039

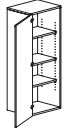
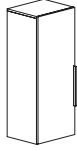

left shown

Features:

- use with secondary height units, fastening hardware included
- laminate grain direction runs vertical on back panel of storage towers
- three adjustable shelves

Options:

- must specify chassis grain direction on double cut veneer, see pages 11-13 for details
- veneer door fronts in paint available, specify paint color and add \$337 list; see page 14 for details
- on laminate units, contrasting laminate door fronts available, no upcharge; specify laminate color, see page 14 for details
- white glass doors with aluminum trim available, specify and add \$1,198 list; see page 31 for details
- markerboard laminate doors available, specify and add \$286 list; see page 31 for details
- ledge pulls standard; prism pulls available, specify and see page 9
- locking door available, specify and add \$142 list (not available on glass door)

48" h Open Storage Tower	15	17 $\frac{7}{8}$	48	92	10	FLT1518-48STO	\$1,146		
	15	17 $\frac{7}{8}$	48	92	10	FLV1518-48STO		\$1,760	\$1,938

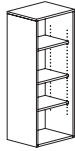

Features:

- use with secondary height units, fastening hardware included
- laminate grain direction runs vertical on back panel of storage towers
- three adjustable shelves

Options:

- must specify chassis grain direction on double cut veneer, see pages 11-13 for details

To Order, Specify:

① Laminate Model #	② Laminate Selection	③ Metal Color	④ Other Product Options
Laminate (FLT)	See Laminate Selection	See Metal Finish Color Options	See list of options for each specific unit; Specify and add accordingly.

① Veneer Model #	② Wood Species	③ Wood Finish	④ Metal Color	⑤ Other Product Options	
Veneer (FLV)	Flat Cut CH1 Cherry MA1 Maple WA1 Walnut BO1 Black Oak	See Flat Cut Wood Finish Options	See Metal Finish Color Options	See list of options for each specific unit; Specify and add accordingly.	
	Double Cut DC1 Double Cut	<table border="1"> <thead> <tr> <th>③a Wood Finish</th> <th>③b Chassis Grain Direction</th> </tr> </thead> <tbody> <tr> <td>See Double Cut Wood Finish Options</td> <td>For Double Cut Only: Vertical Horizontal</td> </tr> </tbody> </table>			③a Wood Finish
③a Wood Finish	③b Chassis Grain Direction				
See Double Cut Wood Finish Options	For Double Cut Only: Vertical Horizontal				

Description	D	W	H	CTN WT	CU FT	① Model	Laminate	Flat Cut Veneer	Double Cut Veneer
Monitor Cabinet with Dual Shelf Storage	15 ¹⁵ / ₁₆	95 ⁷ / ₈	40	255	43	FLT1696-40STVS	\$3,629		
	15 ¹⁵ / ₁₆	95 ⁷ / ₈	40	255	43	FLV1696-40STVS		\$5,944	\$6,541
	15 ¹⁵ / ₁₆	89 ⁷ / ₈	40	243	41	FLT1690-40STVS	\$3,523		
	15 ¹⁵ / ₁₆	89 ⁷ / ₈	40	243	41	FLV1690-40STVS		\$5,774	\$6,349
	15 ¹⁵ / ₁₆	83 ⁷ / ₈	40	231	38	FLT1684-40STVS	\$3,420		
	15 ¹⁵ / ₁₆	83 ⁷ / ₈	40	231	38	FLV1684-40STVS		\$5,604	\$6,165

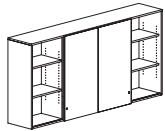
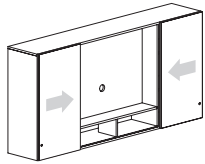

Features:

- use with primary height credenzas
- two adjustable shelves in storage section
- flat screen monitor may be mounted in media section
- divided shelf with oval grommet in back panel
- lock is standard on storage section only
- extreme back panel allows for monitor bracket mounting and wire pass through
- 95⁷/₈"w cabinet = 48" media section; monitor not to exceed 45" w x 29" h
- 89⁷/₈"w cabinet = 45" media section; monitor not to exceed 42" w x 29" h
- 83⁷/₈"w cabinet = 42" media section; monitor not to exceed 39" w x 29" h

Options:

- must specify chassis grain direction on double cut veneer, see pages 11-13 for details
- veneer door fronts in paint available, specify paint color and add \$328 list; see page 14 for details
- on laminate units, contrasting laminate door fronts available, no upcharge; specify laminate color, see page 14 for details
- white glass doors with aluminum trim available, specify and add \$2,674 list for 96" w, \$2,544 list for 90" w, \$2,415 list for 84" w; see page 31 for details
- markerboard laminate doors available, specify and add \$569 list; see page 31 for details

FLUX - PRIVATE OFFICE

Description	Model	List Price Per Tackboard Fabric Grade											
		COM	A	B	C	D	E	F	G	H	I	J	
Monitor Cabinet with Dual Work-in-Process Storage	FLT1696-40PTVP	Laminate	\$3,983	\$4,008	\$4,057	\$4,143	\$4,253	\$4,362	\$4,533	\$4,717	\$4,910	\$5,217	\$5,581
	FLV1696-40PTVP	Flat Cut	\$6,147	\$6,172	\$6,220	\$6,305	\$6,416	\$6,526	\$6,696	\$6,880	\$7,073	\$7,382	\$7,744
		Double Cut	\$6,700	\$6,729	\$6,774	\$6,862	\$6,972	\$7,081	\$7,252	\$7,435	\$7,629	\$7,936	\$8,301
	D - 15 1/8" W - 95 7/8" H - 40" CTN WT - 265 CU FT - 43												
	FLT1690-40PTVP	Laminate	\$3,877	\$3,903	\$3,950	\$4,036	\$4,146	\$4,256	\$4,426	\$4,611	\$4,805	\$5,111	\$5,475
	FLV1690-40PTVP	Flat Cut	\$5,975	\$6,002	\$6,049	\$6,133	\$6,246	\$6,357	\$6,526	\$6,709	\$6,905	\$7,209	\$7,574
		Double Cut	\$6,513	\$6,541	\$6,587	\$6,674	\$6,784	\$6,894	\$7,064	\$7,248	\$7,441	\$7,747	\$8,113
	D - 15 1/8" W - 89 7/8" H - 40" CTN WT - 252 CU FT - 41												
	FLT1684-40PTVP	Laminate	\$3,772	\$3,800	\$3,846	\$3,933	\$4,042	\$4,153	\$4,324	\$4,507	\$4,701	\$5,009	\$5,373
	FLV1684-40PTVP	Flat Cut	\$5,812	\$5,838	\$5,885	\$5,972	\$6,082	\$6,191	\$6,363	\$6,545	\$6,739	\$7,046	\$7,410
		Double Cut	\$6,336	\$6,361	\$6,409	\$6,494	\$6,605	\$6,715	\$6,884	\$7,068	\$7,261	\$7,569	\$7,933
	D - 15 1/8" W - 83 7/8" H - 40" CTN WT - 239 CU FT - 38												

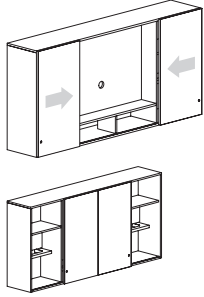

Features:

- use with primary height credenzas
- sliding doors
- locking is standard on sliding doors in closed storage position
- work sections contain lower letter size file opening shelf, tackboard, and fixed upper shelf
- flat screen monitor may be mounted in center section
- divided shelf with oval grommet in back panel
- extreme back panel allows for monitor bracket mounting and wire pass through
- 95 7/8" w cabinet = 48" w media section; monitor not to exceed 45" w x 29" h
- 89 7/8" w cabinet = 45" w media section; monitor not to exceed 42" w x 29" h
- 83 7/8" w cabinet = 42" w media section; monitor not to exceed 39" w x 29" h

Options:

- must specify chassis grain direction on double cut veneer, see pages 11-13 for details
- veneer door fronts in paint available, specify paint color and add \$337 list; see page 14 for details
- on laminate units, contrasting door fronts available, no upcharge; specify color, see page 14 for details
- white glass doors with aluminum trim available, specify and add \$2,674 list for 96" w, \$2,544 list for 90" w, \$2,415 list for 84" w; see page 31 for details
- markerboard laminate doors available, specify and add \$569 list; see page 31 for details
- tackboard included in work-in-process section
- com ydg: 95 7/8" w cabinet = 3; 89 7/8" w cabinet = 3; 83 7/8" w cabinet = 3

To Order, Specify:

1 Model Number	2 Fabric Selection	
	Vendor Pattern Color	Visit www.jsifurniture.com/finishes-and-materials/textiles for our textiles program. See selection of standard and graded in manufacturers and patterns.

To Order, Specify:

1 Laminate Model #	2 Laminate Selection	3 Metal Color	4 Other Product Options
Laminate (FLT)	See Laminate Selection	See Metal Finish Color Options	See list of options for each specific unit; Specify and add accordingly.

1 Veneer Model #	2 Wood Species	3 Wood Finish	4 Metal Color	5 Other Product Options	
Veneer (FLV)	Flat Cut CH1 Cherry MA1 Maple WA1 Walnut BO1 Black Oak	See Flat Cut Wood Finish Options	See Metal Finish Color Options	See list of options for each specific unit; Specify and add accordingly.	
	Double Cut DC1 Double Cut	<table border="1"> <thead> <tr> <th>3a Wood Finish</th> <th>3b Chassis Grain Direction</th> </tr> </thead> <tbody> <tr> <td>See Double Cut Wood Finish Options</td> <td>For Double Cut Only: Vertical Horizontal</td> </tr> </tbody> </table>			3a Wood Finish
3a Wood Finish	3b Chassis Grain Direction				
See Double Cut Wood Finish Options	For Double Cut Only: Vertical Horizontal				

Description

Center Monitor Cabinet with Side Storage and Side Work-in-Process Storage

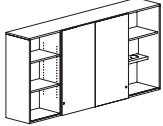
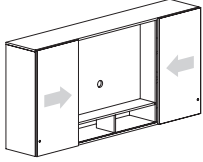

*STVP shown

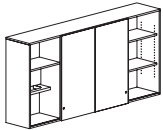

*PTVS

FLUX - PRIVATE OFFICE

List Price Per Tackboard Fabric Grade

Model		COM	A	B	C	D	E	F	G	H	I	J
FLT1696-40STVP	Laminate	\$3,684	\$3,698	\$3,720	\$3,764	\$3,819	\$3,875	\$3,959	\$4,050	\$4,147	\$4,299	\$4,483
	Flat Cut	\$5,848	\$5,860	\$5,884	\$5,927	\$5,982	\$6,038	\$6,122	\$6,214	\$6,311	\$6,466	\$6,647
FLV1696-40STVP	Double Cut	\$6,403	\$6,416	\$6,439	\$6,483	\$6,539	\$6,594	\$6,677	\$6,770	\$6,867	\$7,020	\$7,202
	Laminate	\$3,684	\$3,698	\$3,720	\$3,764	\$3,819	\$3,875	\$3,959	\$4,050	\$4,147	\$4,299	\$4,483
FLT1696-40PTVS	Flat Cut	\$5,848	\$5,860	\$5,884	\$5,927	\$5,982	\$6,038	\$6,122	\$6,214	\$6,311	\$6,466	\$6,647
	Double Cut	\$6,403	\$6,416	\$6,439	\$6,483	\$6,539	\$6,594	\$6,677	\$6,770	\$6,867	\$7,020	\$7,202
D - 15 1/16 W - 95 7/8 H - 40 CTN WT - 260 CU FT - 43												
FLT1690-40STVP	Laminate	\$3,583	\$3,594	\$3,619	\$3,661	\$3,717	\$3,771	\$3,856	\$3,949	\$4,044	\$4,199	\$4,380
	Flat Cut	\$5,681	\$5,693	\$5,717	\$5,759	\$5,816	\$5,870	\$5,957	\$6,048	\$6,146	\$6,298	\$6,481
FLV1690-40STVP	Double Cut	\$6,220	\$6,232	\$6,256	\$6,299	\$6,355	\$6,410	\$6,494	\$6,585	\$6,685	\$6,836	\$7,019
	Laminate	\$3,583	\$3,594	\$3,619	\$3,661	\$3,717	\$3,771	\$3,856	\$3,949	\$4,044	\$4,199	\$4,380
FLT1690-40PTVS	Flat Cut	\$5,681	\$5,693	\$5,717	\$5,759	\$5,816	\$5,870	\$5,957	\$6,048	\$6,146	\$6,298	\$6,481
	Double Cut	\$6,220	\$6,232	\$6,256	\$6,299	\$6,355	\$6,410	\$6,494	\$6,585	\$6,685	\$6,836	\$7,019
D - 15 1/16 W - 89 7/8 H - 40 CTN WT - 247 CU FT - 41												

Features:

- use with primary height credenzas
- sliding doors
- locking is standard on sliding doors in closed storage position
- one side, shelf section - two adjustable shelves
- flat screen monitor may be mounted in center section
- divided shelf with oval grommet in back panel
- extreme back panel allows for monitor bracket mounting and wire pass through
- 95 7/8" w cabinet = 48" w media section; monitor not to exceed 45" w x 29" h
- 89 7/8" w cabinet = 45" w media section; monitor not to exceed 42" w x 29" h

Options:

- must specify chassis grain direction on double cut veneer, see pages 11-13 for details
- veneer door fronts in paint available, specify paint color and add \$337 list; see page 14 for details
- on laminate units, contrasting door fronts available, no upcharge; specify color, see page 14 for details
- white glass doors with aluminum trim available, specify and add \$2,674 list for 96" w, \$2,544 list for 90" w; see page 31 for details
- markerboard laminate doors available, specify and add \$569 list; see page 31 for details
- tackboard included in work-in-process section
- com ydg: 95 7/8" w cabinet = 3; 89 7/8" w cabinet = 3

Description	① Model		List Price Per Tackboard Fabric Grade										
			COM	A	B	C	D	E	F	G	H	I	J
Center Monitor Cabinet with Side Storage and Side Work-in-Process Storage	FLT1684-40STVP	Laminate	\$3,481	\$3,496	\$3,519	\$3,563	\$3,618	\$3,671	\$3,758	\$3,849	\$3,947	\$4,099	\$4,282
		Flat Cut	\$5,521	\$5,533	\$5,558	\$5,601	\$5,655	\$5,712	\$5,796	\$5,888	\$5,984	\$6,138	\$6,320
	FLT1684-40STVP	Double Cut	\$6,044	\$6,056	\$6,081	\$6,123	\$6,179	\$6,234	\$6,319	\$6,411	\$6,508	\$6,661	\$6,843
		Laminate	\$3,481	\$3,496	\$3,519	\$3,563	\$3,618	\$3,671	\$3,758	\$3,849	\$3,947	\$4,099	\$4,282
	FLT1684-40PTVS	Flat Cut	\$5,521	\$5,533	\$5,558	\$5,601	\$5,655	\$5,712	\$5,796	\$5,888	\$5,984	\$6,138	\$6,320
		Double Cut	\$6,044	\$6,056	\$6,081	\$6,123	\$6,179	\$6,234	\$6,319	\$6,411	\$6,508	\$6,661	\$6,843
	D - 15 15/16 W - 83 7/8 H - 40 CTN WT - 234 CU FT - 38												

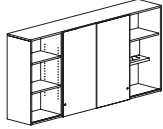
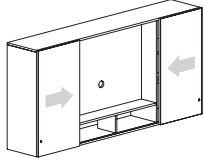

*STVP shown

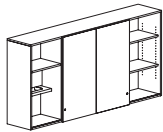

*PTVS

Features:

- use with primary height credenzas
- sliding doors
- locking is standard on sliding doors in closed storage position
- one side, shelf section - two adjustable shelves
- flat screen monitor may be mounted in center section
- divided shelf with oval grommet in back panel
- extreme back panel allows for monitor bracket mounting and wire pass through
- 42" w media section; monitor not to exceed 39" w x 29" h

Options:

- must specify chassis grain direction on double cut veneer, see pages 11-13 for details
- veneer door fronts in paint available, specify paint color and add \$337 list; see page 14 for details
- on laminate units, contrasting door fronts available, no upcharge; specify color, see page 14 for details
- white glass doors with aluminum trim available, specify and add \$2,415 list; see page 31 for details
- markerboard laminate doors available, specify and add \$569 list; see page 31 for details
- tackboard included in work-in-process section
- com ydg: 1

To Order, Specify:

① Model Number	② Fabric Selection	
	Vendor Pattern Color	Visit www.isifurniture.com/finishes-and-materials/textiles for our textiles program. See selection of standard and graded in manufacturers and patterns.

To Order, Specify:

① Laminate Model #	② Laminate Selection	③ Metal Color	④ Other Product Options
Laminate (FLT)	See Laminate Selection	See Metal Finish Color Options	See list of options for each specific unit; Specify and add accordingly.

① Veneer Model #	② Wood Species	③ Wood Finish	④ Metal Color	⑤ Other Product Options		
Veneer (FLV)	Flat Cut CH1 Cherry MA1 Maple WA1 Walnut BO1 Black Oak	See Flat Cut Wood Finish Options	See Metal Finish Color Options	See list of options for each specific unit; Specify and add accordingly.		
	Double Cut DC1 Double Cut	<table border="1"> <thead> <tr> <th>ⓐ Wood Finish</th> <th>ⓑ Chassis Grain Direction</th> </tr> </thead> <tbody> <tr> <td>See Double Cut Wood Finish Options</td> <td>For Double Cut Only: Vertical Horizontal</td> </tr> </tbody> </table>	ⓐ Wood Finish		ⓑ Chassis Grain Direction	See Double Cut Wood Finish Options
ⓐ Wood Finish	ⓑ Chassis Grain Direction					
See Double Cut Wood Finish Options	For Double Cut Only: Vertical Horizontal					

Description	Model	List Price Per Tackboard Fabric Grade												
		COM	A	B	C	D	E	F	G	H	I	J		
Monitor Cabinet with Work-in-Process Storage *PTV shown *TVP	FLT1696-40PTV Laminate	\$3,703	\$3,722	\$3,759	\$3,824	\$3,905	\$3,988	\$4,115	\$4,253	\$4,400	\$4,629	\$4,902		
	FLV1696-40PTV	Flat Cut	\$5,834	\$5,854	\$5,889	\$5,952	\$6,037	\$6,119	\$6,247	\$6,382	\$6,531	\$6,759	\$7,033	
		Double Cut	\$6,380	\$6,401	\$6,435	\$6,499	\$6,582	\$6,665	\$6,794	\$6,929	\$7,075	\$7,307	\$7,579	
	FLT1696-40TVP Laminate	\$3,703	\$3,722	\$3,759	\$3,824	\$3,905	\$3,988	\$4,115	\$4,253	\$4,400	\$4,629	\$4,902		
	FLV1696-40TVP	Flat Cut	\$5,834	\$5,854	\$5,889	\$5,952	\$6,037	\$6,119	\$6,247	\$6,382	\$6,531	\$6,759	\$7,033	
		Double Cut	\$6,380	\$6,401	\$6,435	\$6,499	\$6,582	\$6,665	\$6,794	\$6,929	\$7,075	\$7,307	\$7,579	
	D - 15 1/16 W - 95 7/8 H - 40 CTN WT - 257 CU FT - 43													
	FLT1690-40PTV Laminate	\$3,597	\$3,618	\$3,652	\$3,717	\$3,800	\$3,882	\$4,010	\$4,146	\$4,292	\$4,523	\$4,796		
	FLV1690-40PTV	Flat Cut	\$5,667	\$5,685	\$5,722	\$5,787	\$5,868	\$5,950	\$6,079	\$6,215	\$6,363	\$6,591	\$6,866	
		Double Cut	\$6,196	\$6,216	\$6,252	\$6,316	\$6,400	\$6,482	\$6,610	\$6,747	\$6,893	\$7,123	\$7,395	
FLT1690-40TVP Laminate	\$3,597	\$3,618	\$3,652	\$3,717	\$3,800	\$3,882	\$4,010	\$4,146	\$4,292	\$4,523	\$4,796			
FLV1690-40TVP	Flat Cut	\$5,667	\$5,685	\$5,722	\$5,787	\$5,868	\$5,950	\$6,079	\$6,215	\$6,363	\$6,591	\$6,866		
	Double Cut	\$6,196	\$6,216	\$6,252	\$6,316	\$6,400	\$6,482	\$6,610	\$6,747	\$6,893	\$7,123	\$7,395		
D - 15 1/16 W - 89 7/8 H - 40 CTN WT - 243 CU FT - 41														
FLT1684-40PTV Laminate	\$3,496	\$3,514	\$3,551	\$3,615	\$3,698	\$3,780	\$3,907	\$4,043	\$4,191	\$4,420	\$4,695			
FLV1684-40PTV	Flat Cut	\$5,503	\$5,525	\$5,559	\$5,623	\$5,707	\$5,789	\$5,917	\$6,053	\$6,199	\$6,429	\$6,702		
	Double Cut	\$6,018	\$6,039	\$6,075	\$6,138	\$6,222	\$6,303	\$6,431	\$6,567	\$6,715	\$6,945	\$7,216		
FLT1684-40TVP Laminate	\$3,496	\$3,514	\$3,551	\$3,615	\$3,698	\$3,780	\$3,907	\$4,043	\$4,191	\$4,420	\$4,695			
FLV1684-40TVP	Flat Cut	\$5,503	\$5,525	\$5,559	\$5,623	\$5,707	\$5,789	\$5,917	\$6,053	\$6,199	\$6,429	\$6,702		
	Double Cut	\$6,018	\$6,039	\$6,075	\$6,138	\$6,222	\$6,303	\$6,431	\$6,567	\$6,715	\$6,945	\$7,216		
D - 15 1/16 W - 83 7/8 H - 40 CTN WT - 231 CU FT - 38														
FLT1678-40PTV Laminate	\$3,394	\$3,410	\$3,440	\$3,495	\$3,564	\$3,632	\$3,738	\$3,852	\$3,975	\$4,165	\$4,395			
FLV1678-40PTV	Flat Cut	\$5,344	\$5,360	\$5,389	\$5,444	\$5,513	\$5,581	\$5,686	\$5,801	\$5,925	\$6,116	\$6,344		
	Double Cut	\$5,846	\$5,860	\$5,891	\$5,943	\$6,013	\$6,082	\$6,188	\$6,303	\$6,425	\$6,616	\$6,844		
FLT1678-40TVP Laminate	\$3,394	\$3,410	\$3,440	\$3,495	\$3,564	\$3,632	\$3,738	\$3,852	\$3,975	\$4,165	\$4,395			
FLV1678-40TVP	Flat Cut	\$5,344	\$5,360	\$5,389	\$5,444	\$5,513	\$5,581	\$5,686	\$5,801	\$5,925	\$6,116	\$6,344		
	Double Cut	\$5,846	\$5,860	\$5,891	\$5,943	\$6,013	\$6,082	\$6,188	\$6,303	\$6,425	\$6,616	\$6,844		
D - 15 1/16 W - 77 7/8 H - 40 CTN WT - 218 CU FT - 35														

Features:

- use with primary height credenzas
- sliding door
- locking is standard on sliding doors in closed storage position
- work section - dual hanging letter size file pocket shelf with tackable surface above; upper fixed shelf
- flat screen monitor may be mounted in media section
- divided shelf with oval grommet in back panel
- extreme back panel allows for monitor bracket mounting and wire pass through
- 95 7/8" w cabinet = 48" w media section; monitor not to exceed 45" w x 29" h
- 89 7/8" w cabinet = 45" w media section; monitor not to exceed 42" w x 29" h
- 83 7/8" w cabinet = 42" w media section; monitor not to exceed 39" w x 29" h
- 77 7/8" w cabinet = 39" w media section; monitor not to exceed 36" w x 29" h

Options:

- must specify chassis grain direction on double cut veneer, see pages 11-13 for details
- veneer door fronts in paint available, specify paint color and add \$337 list; see page 14 for details
- on laminate units, contrasting door fronts available, no upcharge; specify color, see page 14 for details
- white glass doors with aluminum trim available, specify and add \$2,603 list for 96" w, \$2,241 list for 90" w, \$2,112 list for 84" w, \$1,983 list for 78" w; see page 31 for details
- markerboard laminate doors available, specify and add \$495 list; see page 31 for details
- tackboard included in work-in-process section
- com ydg: 95 7/8" w cabinet = 1 1/2; 89 7/8" w cabinet = 1 1/2; 83 7/8" w cabinet = 1 1/2; 77 7/8" w cabinet = 1 1/4

To Order, Specify:

1 Model Number	2 Fabric Selection
Vendor Pattern Color	Visit www.jsifurniture.com/finishes-and-materials/textiles for our textiles program. See selection of standard and graded in manufacturers and patterns.

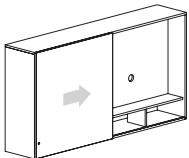
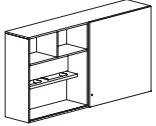
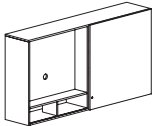
Description	Model		List Price Per Tackboard Fabric Grade											
			COM	A	B	C	D	E	F	G	H	I	J	
Monitor Cabinet with Work-in-Process Storage   *PTV shown  *TVP	FLT1672-40PTV	Laminate	\$3,355	\$3,372	\$3,401	\$3,457	\$3,525	\$3,593	\$3,700	\$3,815	\$3,938	\$4,129	\$4,357	
	FLV1672-40PTV	Flat Cut	\$5,287	\$5,302	\$5,334	\$5,386	\$5,456	\$5,525	\$5,630	\$5,746	\$5,867	\$6,056	\$6,286	
		Double Cut	\$5,781	\$5,797	\$5,828	\$5,882	\$5,950	\$6,018	\$6,125	\$6,240	\$6,363	\$6,552	\$6,782	
	FLT1672-40TVP	Laminate	\$3,355	\$3,372	\$3,401	\$3,457	\$3,525	\$3,593	\$3,700	\$3,815	\$3,938	\$4,129	\$4,357	
		Flat Cut	\$5,287	\$5,302	\$5,334	\$5,386	\$5,456	\$5,525	\$5,630	\$5,746	\$5,867	\$6,056	\$6,286	
	FLV1672-40TVP	Double Cut	\$5,781	\$5,797	\$5,828	\$5,882	\$5,950	\$6,018	\$6,125	\$6,240	\$6,363	\$6,552	\$6,782	
		D - 15 15/16 W - 71 7/8 H - 40 CTN WT - 205 CU FT - 33												
		FLT1666-40PTV	Laminate	\$3,316	\$3,333	\$3,365	\$3,417	\$3,488	\$3,554	\$3,660	\$3,775	\$3,898	\$4,088	\$4,318
			Flat Cut	\$5,228	\$5,242	\$5,273	\$5,328	\$5,397	\$5,465	\$5,570	\$5,685	\$5,809	\$5,998	\$6,228
		FLV1666-40PTV	Double Cut	\$5,717	\$5,734	\$5,761	\$5,817	\$5,887	\$5,955	\$6,059	\$6,175	\$6,298	\$6,489	\$6,717
			FLT1666-40TVP	Laminate	\$3,316	\$3,333	\$3,365	\$3,417	\$3,488	\$3,554	\$3,660	\$3,775	\$3,898	\$4,088
		Flat Cut		\$5,228	\$5,242	\$5,273	\$5,328	\$5,397	\$5,465	\$5,570	\$5,685	\$5,809	\$5,998	\$6,228
FLV1666-40TVP		Double Cut	\$5,717	\$5,734	\$5,761	\$5,817	\$5,887	\$5,955	\$6,059	\$6,175	\$6,298	\$6,489	\$6,717	
		D - 15 15/16 W - 65 7/8 H - 40 CTN WT - 191 CU FT - 30												
		FLT1660-40PTV	Laminate	\$3,278	\$3,292	\$3,315	\$3,358	\$3,414	\$3,468	\$3,554	\$3,645	\$3,743	\$3,895	\$4,078
			Flat Cut	\$5,171	\$5,184	\$5,209	\$5,251	\$5,306	\$5,361	\$5,446	\$5,538	\$5,635	\$5,789	\$5,971
		FLV1660-40PTV	Double Cut	\$5,657	\$5,671	\$5,693	\$5,737	\$5,792	\$5,848	\$5,932	\$6,023	\$6,121	\$6,275	\$6,456
			FLT1660-40TVP	Laminate	\$3,278	\$3,292	\$3,315	\$3,358	\$3,414	\$3,468	\$3,554	\$3,645	\$3,743	\$3,895
		Flat Cut		\$5,171	\$5,184	\$5,209	\$5,251	\$5,306	\$5,361	\$5,446	\$5,538	\$5,635	\$5,789	\$5,971
	FLV1660-40TVP	Double Cut	\$5,657	\$5,671	\$5,693	\$5,737	\$5,792	\$5,848	\$5,932	\$6,023	\$6,121	\$6,275	\$6,456	
		D - 15 15/16 W - 59 7/8 H - 40 CTN WT - 180 CU FT - 27												

Features:

- use with primary height credenzas
- sliding door
- locking is standard on sliding doors in closed storage position
- work section - lower file shelf with full height tackboard; fixed upper shelf
- flat screen monitor may be mounted in media section
- divided shelf with oval grommet in back panel
- extreme back panel allows for monitor bracket mounting and wire pass through
- 71 7/8" w cabinet = 36" w media section; monitor not to exceed 33" w x 29" h
- 65 7/8" w cabinet = 33" w media section; monitor not to exceed 30" w x 29" h
- 59 7/8" w cabinet = 30" w media section; monitor not to exceed 27" w x 29" h

Options:

- must specify chassis grain direction on double cut veneer, see pages 11-13 for details
- veneer door fronts in paint available, specify paint color and add \$337 list; see page 14 for details
- on laminate units, contrasting door fronts available, no upcharge; specify color, see page 14 for details
- white glass doors with aluminum trim available, specify and add \$1,854 list for 72" w, \$1,725 list for 66" w, \$1,597 list for 60" w; see page 31 for details
- markerboard laminate doors available, specify and add \$495 list; see page 31 for details
- tackboard included in work-in-process section
- com ydg: 71 7/8" w cabinet = 1 1/4; 65 7/8" w cabinet = 1 1/4; 59 7/8" w cabinet = 1

To Order, Specify:

1 Laminate Model #	2 Laminate Selection	3 Metal Color	4 Other Product Options	
Laminate (FLT)	See Laminate Selection	See Metal Finish Color Options	See list of options for each specific unit; Specify and add accordingly.	
1 Veneer Model #	2 Wood Species	3 Wood Finish	4 Metal Color	5 Other Product Options
Veneer (FLV)	Flat Cut CH1 Cherry MA1 Maple WA1 Walnut BO1 Black Oak	See Flat Cut Wood Finish Options	See Metal Finish Color Options	See list of options for each specific unit; Specify and add accordingly.
	Double Cut DC1 Double Cut	a Wood Finish See Double Cut Wood Finish Options b Chassis Grain Direction For Double Cut Only: Vertical Horizontal		

Description

Monitor Cabinet with Side Work-in-Process Storage

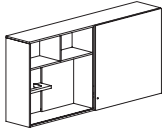
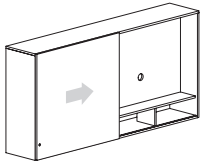

*PTTV shown

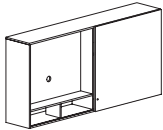

*TVPT

FLUX - PRIVATE OFFICE

List Price Per Tackboard Fabric Grade

Model	COM	A	B	C	D	E	F	G	H	I	J
FLT1696-40PTTV Laminate	\$3,716	\$3,728	\$3,752	\$3,794	\$3,850	\$3,905	\$3,990	\$4,081	\$4,178	\$4,332	\$4,515
Flat Cut	\$5,847	\$5,859	\$5,883	\$5,926	\$5,980	\$6,037	\$6,121	\$6,213	\$6,309	\$6,464	\$6,645
Double Cut	\$6,391	\$6,407	\$6,429	\$6,472	\$6,529	\$6,582	\$6,668	\$6,759	\$6,857	\$7,009	\$7,192
FLV1696-40PTTV Laminate	\$3,716	\$3,728	\$3,752	\$3,794	\$3,850	\$3,905	\$3,990	\$4,081	\$4,178	\$4,332	\$4,515
Flat Cut	\$5,847	\$5,859	\$5,883	\$5,926	\$5,980	\$6,037	\$6,121	\$6,213	\$6,309	\$6,464	\$6,645
Double Cut	\$6,391	\$6,407	\$6,429	\$6,472	\$6,529	\$6,582	\$6,668	\$6,759	\$6,857	\$7,009	\$7,192
D - 15 1/16 W - 95 7/8 H - 40 CTN WT - 252 CU FT - 43											
FLT1690-40PTTV Laminate	\$3,607	\$3,622	\$3,644	\$3,687	\$3,743	\$3,796	\$3,883	\$3,975	\$4,072	\$4,225	\$4,406
Flat Cut	\$5,677	\$5,688	\$5,714	\$5,756	\$5,812	\$5,867	\$5,951	\$6,044	\$6,140	\$6,295	\$6,476
Double Cut	\$6,208	\$6,222	\$6,243	\$6,288	\$6,343	\$6,399	\$6,483	\$6,575	\$6,671	\$6,824	\$7,006
FLV1690-40PTTV Laminate	\$3,607	\$3,622	\$3,644	\$3,687	\$3,743	\$3,796	\$3,883	\$3,975	\$4,072	\$4,225	\$4,406
Flat Cut	\$5,677	\$5,688	\$5,714	\$5,756	\$5,812	\$5,867	\$5,951	\$6,044	\$6,140	\$6,295	\$6,476
Double Cut	\$6,208	\$6,222	\$6,243	\$6,288	\$6,343	\$6,399	\$6,483	\$6,575	\$6,671	\$6,824	\$7,006
D - 15 1/16 W - 89 7/8 H - 40 CTN WT - 238 CU FT - 41											
FLT1684-40PTTV Laminate	\$3,504	\$3,518	\$3,541	\$3,585	\$3,639	\$3,696	\$3,780	\$3,873	\$3,967	\$4,122	\$4,302
Flat Cut	\$5,513	\$5,527	\$5,550	\$5,594	\$5,647	\$5,705	\$5,789	\$5,879	\$5,976	\$6,129	\$6,312
Double Cut	\$6,029	\$6,041	\$6,064	\$6,108	\$6,163	\$6,219	\$6,303	\$6,394	\$6,492	\$6,645	\$6,826
FLV1684-40PTTV Laminate	\$3,504	\$3,518	\$3,541	\$3,585	\$3,639	\$3,696	\$3,780	\$3,873	\$3,967	\$4,122	\$4,302
Flat Cut	\$5,513	\$5,527	\$5,550	\$5,594	\$5,647	\$5,705	\$5,789	\$5,879	\$5,976	\$6,129	\$6,312
Double Cut	\$6,029	\$6,041	\$6,064	\$6,108	\$6,163	\$6,219	\$6,303	\$6,394	\$6,492	\$6,645	\$6,826
D - 15 1/16 W - 83 7/8 H - 40 CTN WT - 226 CU FT - 38											

Features:

- use with primary height credenzas
- sliding door
- locking is standard on sliding doors in closed storage position
- work section - one hanging letter size file pocket shelf with full height tackable surface; upper fixed shelf
- flat screen monitor may be mounted in media section
- divided shelf with oval grommet in back panel
- extreme back panel allows for monitor bracket mounting and wire pass through
- 95 7/8" w cabinet = 48" w media section; monitor not to exceed 45" w x 29" h
- 89 7/8" w cabinet = 45" w media section; monitor not to exceed 42" w x 29" h
- 83 7/8" w cabinet = 42" w media section; monitor not to exceed 39" w x 29" h

Options:

- must specify chassis grain direction on double cut veneer, see pages 11-13 for details
- veneer door fronts in paint available, specify paint color and add \$337 list; see page 14 for details
- on laminate units, contrasting door fronts available, no upcharge; specify color, see page 14 for details
- white glass doors with aluminum trim available, specify and add \$2,603 list for 96" w, \$2,241 list for 90" w, \$2,112 list for 84" w; see page 31 for details
- markerboard laminate doors available, specify and add \$495 list; see page 31 for details
- tackboard included in work-in-process section
- com ydg: 95 7/8" w cabinet = 1; 89 7/8" w cabinet = 1; 83 7/8" w cabinet = 1

To Order, Specify:

1 Model Number	2 Fabric Selection
Vendor Pattern Color	Visit www.jsifurniture.com/finishes-and-materials/textiles for our textiles program. See selection of standard and graded in manufacturers and patterns.

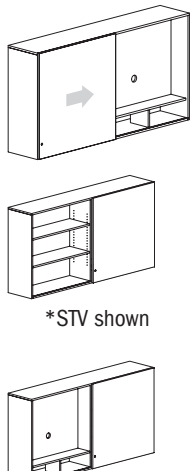
Description	D	W	H	CTN WT	CU FT	① Model	Laminate	Flat Cut Veneer	Double Cut Veneer
 <p>*STV shown</p> <p>*TVS</p>	15 15/16	77 7/8	40	207	35	FLT1678-40STV	\$3,258		
	15 15/16	77 7/8	40	207	35	FLV1678-40STV		\$5,339	\$5,871
	15 15/16	77 7/8	40	207	35	FLT1678-40TVS	\$3,258		
	15 15/16	77 7/8	40	207	35	FLV1678-40TVS		\$5,339	\$5,871
	15 15/16	71 7/8	40	209	33	FLT1672-40STV	\$3,225		
	15 15/16	71 7/8	40	209	33	FLV1672-40STV		\$5,284	\$5,812
	15 15/16	71 7/8	40	209	33	FLT1672-40TVS	\$3,225		
	15 15/16	71 7/8	40	209	33	FLV1672-40TVS		\$5,284	\$5,812
	15 15/16	65 7/8	40	195	30	FLT1666-40STV	\$3,193		
	15 15/16	65 7/8	40	195	30	FLV1666-40STV		\$5,231	\$5,754
	15 15/16	65 7/8	40	195	30	FLT1666-40TVS	\$3,193		
	15 15/16	65 7/8	40	195	30	FLV1666-40TVS		\$5,231	\$5,754
	15 15/16	59 7/8	40	184	27	FLT1660-40STV	\$3,161		
	15 15/16	59 7/8	40	184	27	FLV1660-40STV		\$5,179	\$5,695
	15 15/16	59 7/8	40	184	27	FLT1660-40TVS	\$3,161		
	15 15/16	59 7/8	40	184	27	FLV1660-40TVS		\$5,179	\$5,695

Features:

- use with primary height credenzas
- two adjustable shelves in storage section
- flat screen monitor may be mounted in media section
- divided shelf with oval grommet in back panel
- lock is standard on storage section only
- extreme back panel allows for monitor bracket mounting and wire pass through
- 77 7/8" w cabinet = 39" w media section; monitor not to exceed 36" w x 29" h
- 71 7/8" w cabinet = 36" w media section; monitor not to exceed 33" w x 29" h
- 65 7/8" w cabinet = 33" w media section; monitor not to exceed 30" w x 29" h
- 59 7/8" w cabinet = 30" w media section; monitor not to exceed 27" w x 29" h

Options:

- must specify chassis grain direction on double cut veneer, see pages 11-13 for details
- veneer door fronts in paint available, specify paint color and add \$337 list; see page 14 for details
- on laminate units, contrasting laminate door fronts available, no upcharge; specify laminate color, see page 14 for details
- white glass doors with aluminum trim available, specify and add \$1,983 list for 78" w, \$1,854 list for 72" w, \$1,725 list for 66" w, \$1,597 list for 60" w; see page 31 for details
- markerboard laminate doors available, specify and add \$482 list; see page 31 for details

To Order, Specify:

① Laminate Model #	② Laminate Selection	③ Metal Color	④ Other Product Options
Laminate (FLT)	See Laminate Selection	See Metal Finish Color Options	See list of options for each specific unit; Specify and add accordingly.

① Veneer Model #	② Wood Species	③ Wood Finish	④ Metal Color	⑤ Other Product Options
Veneer (FLV)	Flat Cut CH1 Cherry MA1 Maple WA1 Walnut BO1 Black Oak	See Flat Cut Wood Finish Options	See Metal Finish Color Options	See list of options for each specific unit; Specify and add accordingly.
	Double Cut DC1 Double Cut	ⓐ Wood Finish See Double Cut Wood Finish Options		

Description	D	W	H	CTN WT	CU FT	① Model	Laminate	Flat Cut Veneer	Double Cut Veneer
Bookcase	15	36	81	181	32	FLT1536-81FBC	\$1,557		
	15	36	81	181	32	FLV1536-81FBC		\$2,743	\$3,016
	15	30	81	169	27	FLT1530-81FBC	\$1,441		
	15	30	81	169	27	FLV1530-81FBC		\$2,575	\$2,834
	15	24	81	156	22	FLT1524-81FBC	\$1,329		
	15	24	81	156	22	FLV1524-81FBC		\$2,428	\$2,672

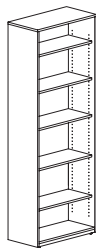

Features:

- square edge on top
- five adjustable shelves

Options:

- must specify chassis grain direction on double cut veneer, see pages 11-13 for details

Bookcase	15	36	69	155	27	FLT1536-69FBC	\$1,483		
	15	36	69	155	27	FLV1536-69FBC		\$2,311	\$2,542
	15	30	69	142	23	FLT1530-69FBC	\$1,369		
	15	30	69	142	23	FLV1530-69FBC		\$2,231	\$2,453
	15	24	69	130	19	FLT1524-69FBC	\$1,260		
	15	24	69	130	19	FLV1524-69FBC		\$2,147	\$2,362

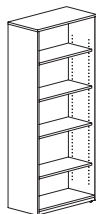

Features:

- square edge on top
- four adjustable shelves

Options:

- must specify chassis grain direction on double cut veneer, see pages 11-13 for details

FLUX - PRIVATE OFFICE

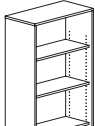
Description	D	W	H	CTN WT	CU FT	① Model	Laminate	Flat Cut Veneer	Double Cut Veneer
	15	36	55 3/8	115	22	FLT1536-55FBC	\$1,336		
	15	36	55 3/8	115	22	FLV1536-55FBC		\$2,081	\$2,290
	15	30	55 3/8	108	19	FLT1530-55FBC	\$1,233		
	15	30	55 3/8	108	19	FLV1530-55FBC		\$2,006	\$2,208
	15	24	55 3/8	101	15	FLT1524-55FBC	\$1,135		
	15	24	55 3/8	101	15	FLV1524-55FBC		\$1,933	\$2,127

Features:

- square edge on top
- three adjustable shelves

Options:

- must specify chassis grain direction on double cut veneer, see pages 11-13 for details

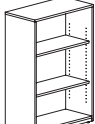
Description	D	W	H	CTN WT	CU FT	① Model	Laminate	Flat Cut Veneer	Double Cut Veneer
	15	36	41 1/16	81	17	FLT1536-42FBC	\$1,096		
	15	36	41 1/16	81	17	FLV1536-42FBC		\$1,710	\$1,882
	15	30	41 1/16	76	14	FLT1530-42FBC	\$1,008		
	15	30	41 1/16	76	14	FLV1530-42FBC		\$1,651	\$1,816
	15	24	41 1/16	71	12	FLT1524-42FBC	\$937		
	15	24	41 1/16	71	12	FLV1524-42FBC		\$1,589	\$1,746

Features:

- square edge on top
- two adjustable shelves

Options:

- must specify chassis grain direction on double cut veneer, see pages 11-13 for details

To Order, Specify:

① Laminate Model #	② Laminate Selection		③ Metal Color	④ Other Product Options	
Laminate (FLT)	See Laminate Selection		See Metal Finish Color Options	See list of options for each specific unit; Specify and add accordingly.	
① Veneer Model #	② Wood Species	③ Wood Finish		④ Metal Color	⑤ Other Product Options
Veneer (FLV)	Flat Cut CH1 Cherry MA1 Maple WA1 Walnut BO1 Black Oak	See Flat Cut Wood Finish Options		See Metal Finish Color Options	See list of options for each specific unit; Specify and add accordingly.
	Double Cut DC1 Double Cut	ⓐ Wood Finish See Double Cut Wood Finish Options	ⓑ Chassis Grain Direction For Double Cut Only: Vertical Horizontal		

Description	D	W	H	CTN WT	CU FT	① Model	Laminate	Flat Cut Veneer	Double Cut Veneer
Four Drawer Lateral File with Open Compartment	22	36	69	322	38	FLT2236-69F4LF0	\$3,163		
	22	36	69	322	38	FLV2236-69F4LF0		\$4,267	\$4,695
	22	30	69	305	32	FLT2230-69F4LF0	\$3,028		
	22	30	69	305	32	FLV2230-69F4LF0		\$4,052	\$4,461



Features:

- square edge on top
- four drawers with open upper storage
- anti-tip interlock mechanism
- pedestal front locking

Options:

- must specify chassis grain direction on double cut veneer, see pages 11-13 for details
- veneer drawer fronts in paint available, specify paint color and add \$337 list; see page 14 for details
- on laminate units, contrasting drawer fronts available, no upcharge; specify color, see page 14 for details
- ledge pulls standard; prism pulls available, specify and see page 9

Description	D	W	H	CTN WT	CU FT	① Model	Laminate	Flat Cut Veneer	Double Cut Veneer
Four Drawer Lateral File with Hinge Door Storage Compartment	22	36	69	338	38	FLT2236-69F4LFD	\$3,347		
	22	36	69	338	38	FLV2236-69F4LFD		\$4,536	\$4,989
	22	30	69	321	32	FLT2230-69F4LFD	\$3,201		
	22	30	69	321	32	FLV2230-69F4LFD		\$4,322	\$4,754

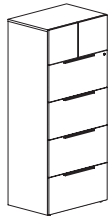

Features:

- square edge on top
- four drawers with hinged door upper compartment
- anti-tip interlock mechanism
- pedestal front locking

Options:

- must specify chassis grain direction on double cut veneer, see pages 11-13 for details
- veneer door and drawer fronts in paint available, specify paint color and add \$337 list; see page 14 for details
- on laminate units, contrasting door and drawer fronts available, no upcharge; specify color, see page 14 for details
- locking door available, specify and add \$142 list
- ledge pulls standard; prism pulls available, specify and see page 9

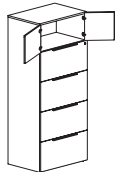

FLUX - PRIVATE OFFICE

Description	D	W	H	CTN WT	CU FT	① Model	Laminate	Flat Cut Veneer	Double Cut Veneer
Four Drawer Lateral File	22	36	55 3/8	287	31	FLT2236-55F4LF	\$2,510		
	22	36	55 3/8	287	31	FLV2236-55F4LF		\$3,387	\$3,725
	22	30	55 3/8	270	26	FLT2230-55F4LF	\$2,406		
	22	30	55 3/8	270	26	FLV2230-55F4LF		\$3,217	\$3,540



Features:

- four drawers
- anti-tip interlock mechanism
- pedestal front locking

Options:

- must specify chassis grain direction on double cut veneer, see pages 11-13 for details
- veneer drawer fronts in paint available, specify paint color and add \$337 list; see page 14 for details
- on laminate units, contrasting drawer fronts available, no upcharge; specify color, see page 14 for details
- ledge pulls standard; prism pulls available, specify and see page 9

Description	D	W	H	CTN WT	CU FT	① Model	Laminate	Flat Cut Veneer	Double Cut Veneer
Three Drawer Lateral File	22	36	41 1/16	232	26	FLT2236-41F3LF	\$2,419		
	22	36	41 1/16	232	26	FLV2236-41F3LF		\$2,916	\$3,207
	22	30	41 1/16	218	20	FLT2230-41F3LF	\$2,276		
	22	30	41 1/16	218	20	FLV2230-41F3LF		\$2,747	\$3,022

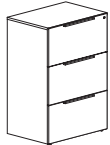

Features:

- three drawers
- anti-tip interlock mechanism
- pedestal front locking

Options:

- must specify chassis grain direction on double cut veneer, see pages 11-13 for details
- veneer drawer fronts in paint available, specify paint color and add \$337 list; see page 14 for details
- on laminate units, contrasting drawer fronts available, no upcharge; specify color, see page 14 for details
- ledge pulls standard; prism pulls available, specify and see page 9

FLUX - PRIVATE OFFICE

To Order, Specify:

① Laminate Model #	② Laminate Selection		③ Metal Color	④ Other Product Options	
Laminate (FLT)	See Laminate Selection		See Metal Finish Color Options	See list of options for each specific unit; Specify and add accordingly.	
① Veneer Model #	② Wood Species	③ Wood Finish		④ Metal Color	⑤ Other Product Options
Veneer (FLV)	Flat Cut CH1 Cherry MA1 Maple WA1 Walnut BO1 Black Oak	See Flat Cut Wood Finish Options		See Metal Finish Color Options	See list of options for each specific unit; Specify and add accordingly.
	Double Cut DC1 Double Cut	See Double Cut Wood Finish Options	③b Chassis Grain Direction For Double Cut Only: Vertical Horizontal		

Description	D	W	H	CTN WT	CU FT	① Model	Laminate	Flat Cut Veneer	Double Cut Veneer
81" h Wardrobe	22	18	81	168	24	FLT2218-81FDWR	\$1,834		
	22	18	81	168	24	FLV2218-81FDWR		\$3,256	\$3,583
	22	18	81	168	24	FLT2218-81FDWL	\$1,834		
	22	18	81	168	24	FLV2218-81FDWL		\$3,256	\$3,583

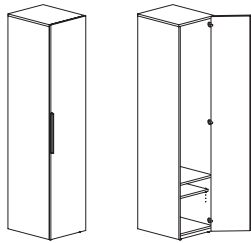

right shown

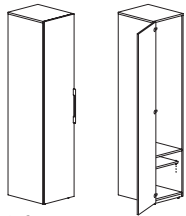

left

Features:

- lower adjustable shelf
- installed coat hooks

Options:

- must specify chassis grain direction on double cut veneer, see pages 11-13 for details
- veneer door front in paint available, specify paint color and add \$337 list; see page 14 for details
- on laminate units, contrasting doors fronts available, no upcharge; specify color, see page 14 for details
- locking door available, specify and add \$142 list
- ledge pulls standard, mounted vertical; prism pulls available, specify and see page 9
- vanity mirror available, specify and add \$141 list

81" h Storage Cabinet	22	18	81	188	24	FLT2218-81FDR	\$1,826		
	22	18	81	188	24	FLV2218-81FDR		\$3,247	\$3,573
	22	18	81	188	24	FLT2218-81FDL	\$1,826		
	22	18	81	188	24	FLV2218-81FDL		\$3,247	\$3,573

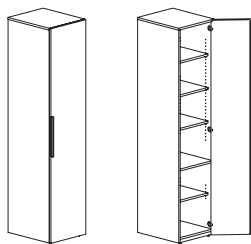

right shown

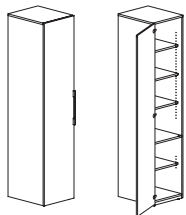

left

Features:

- five adjustable shelves

Options:

- must specify chassis grain direction on double cut veneer, see pages 11-13 for details
- veneer door front in paint available, specify paint color and add \$337 list; see page 14 for details
- on laminate units, contrasting doors fronts available, no upcharge; specify color, see page 14 for details
- locking door available, specify and add \$142 list
- ledge pulls standard, mounted vertical; prism pulls available, specify and see page 9
- vanity mirror available, specify and add \$141 list

Description	D	W	H	CTN WT	CU FT	① Model	Laminate	Flat Cut Veneer	Double Cut Veneer
69" h Wardrobe	22	18	69	149	20	FLT2218-69FDWR	\$1,643		
	22	18	69	149	20	FLV2218-69FDWR		\$2,981	\$3,278
	22	18	69	149	20	FLT2218-69FDWL	\$1,643		
	22	18	69	149	20	FLV2218-69FDWL		\$2,981	\$3,278

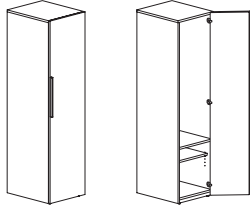

right shown

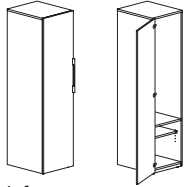

left

Features:

- lower adjustable shelf
- installed coat hooks

Options:

- must specify chassis grain direction on double cut veneer, see pages 11-13 for details
- veneer door front in paint available, specify paint color and add \$337 list; see page 14 for details
- on laminate units, contrasting doors fronts available, no upcharge; specify color, see page 14 for details
- locking door available, specify and add \$142 list
- ledge pulls standard, mounted vertical; prism pulls available, specify and see page 9
- vanity mirror available, specify and add \$141 list

69" h Storage Cabinet	D	W	H	CTN WT	CU FT	Model	Laminate	Flat Cut Veneer	Double Cut Veneer
69" h Storage Cabinet	22	18	69	168	20	FLT2218-69FDR	\$1,633		
	22	18	69	168	20	FLV2218-69FDR		\$2,973	\$3,270
	22	18	69	168	20	FLT2218-69FDL	\$1,633		
	22	18	69	168	20	FLV2218-69FDL		\$2,973	\$3,270

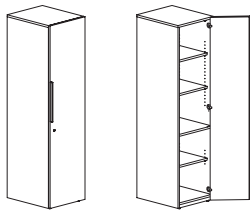

right shown

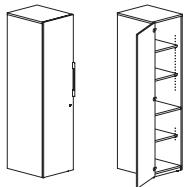

left

Features:

- four adjustable shelves

Options:

- must specify chassis grain direction on double cut veneer, see pages 11-13 for details
- veneer door front in paint available, specify paint color and add \$337 list; see page 14 for details
- on laminate units, contrasting doors fronts available, no upcharge; specify color, see page 14 for details
- locking door available, specify and add \$142 list
- ledge pulls standard, mounted vertical; prism pulls available, specify and see page 9
- vanity mirror available, specify and add \$141 list

To Order, Specify:

① Laminate Model #	② Laminate Selection		③ Metal Color	④ Other Product Options	
Laminate (FLT)	See Laminate Selection		See Metal Finish Color Options	See list of options for each specific unit; Specify and add accordingly.	
① Veneer Model #	② Wood Species	③ Wood Finish		④ Metal Color	⑤ Other Product Options
Veneer (FLV)	Flat Cut CH1 Cherry MA1 Maple WA1 Walnut BO1 Black Oak	See Flat Cut Wood Finish Options		See Metal Finish Color Options	See list of options for each specific unit; Specify and add accordingly.
	Double Cut DC1 Double Cut	Ⓒa Wood Finish See Double Cut Wood Finish Options	Ⓒb Chassis Grain Direction For Double Cut Only: Vertical Horizontal		

Description	D	W	H	CTN WT	CU FT	① Model	Laminate	Flat Cut Veneer	Double Cut Veneer
81" h File/File, Storage Cabinet with Side Wardrobe	22	24	81	274	30	FLT2224-81F2DWR	\$3,195		
	22	24	81	274	30	FLV2224-81F2DWR		\$5,046	\$5,550
	22	24	81	274	30	FLT2224-81F2DWL	\$3,195		
	22	24	81	274	30	FLV2224-81F2DWL		\$5,046	\$5,550

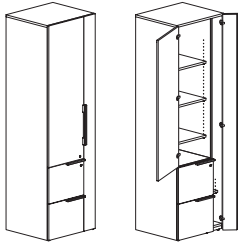

right shown

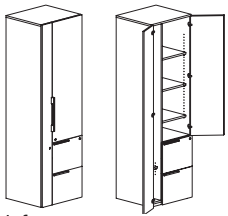

left

Features:

- aligns with primary height units
- pedestal front locking
- upper compartment has three adjustable shelves
- installed coat hook in wardrobe compartment

Options:

- must specify chassis grain direction on double cut veneer, see pages 11-13 for details
- veneer door and drawer front in paint available, specify paint color and add \$337; see page 14 for details
- on laminate units, contrasting door and drawer fronts available, no upcharge; specify color, see page 14 for details
- locking doors available, specify and add \$284 list
- ledge pulls standard; prism pulls available, specify and see page 9
- vanity mirror available, specify and add \$141 list

81" h Box/Box/File, Storage Cabinet with Side Wardrobe	22	24	81	276	30	FLT2224-81F1DWR	\$3,203		
	22	24	81	276	30	FLV2224-81F1DWR		\$5,053	\$5,559
	22	24	81	276	30	FLT2224-81F1DWL	\$3,203		
	22	24	81	276	30	FLV2224-81F1DWL		\$5,053	\$5,559

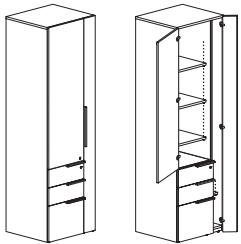

right shown

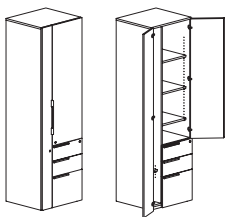

left

Features:

- aligns with primary height units
- pedestal front locking
- upper compartment has three adjustable shelves
- installed coat hook in wardrobe compartment

Options:

- must specify chassis grain direction on double cut veneer, see pages 11-13 for details
- veneer door and drawer front in paint available, specify paint color and add \$337; see page 14 for details
- on laminate units, contrasting door and drawer fronts available, no upcharge; specify color, see page 14 for details
- locking doors available, specify and add \$284 list
- ledge pulls standard; prism pulls available, specify and see page 9
- vanity mirror available, specify and add \$141 list

Description	D	W	H	CTN WT	CU FT	① Model	Laminate	Flat Cut Veneer	Double Cut Veneer
81" h File/File, Open Storage Cabinet with Side Wardrobe	22	24	81	253	30	FLT2224-81F20WR	\$3,087		
	22	24	81	253	30	FLV2224-81F20WR		\$4,888	\$5,377
	22	24	81	253	30	FLT2224-81F20WL	\$3,087		
	22	24	81	253	30	FLV2224-81F20WL		\$4,888	\$5,377

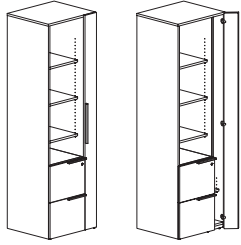

right shown

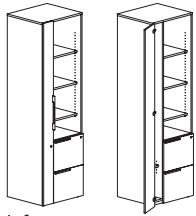

left

Features:

- aligns with primary height units
- pedestal front locking
- upper compartment has three adjustable shelves
- installed coat hook in wardrobe compartment

Options:

- must specify chassis grain direction on double cut veneer, see pages 11-13 for details
- veneer door and drawer front in paint available, specify paint color and add \$337; see page 14 for details
- on laminate units, contrasting door and drawer fronts available, no upcharge; specify color, see page 14 for details
- locking side door available, specify and add \$142 list
- ledge pulls standard; prism pulls available, specify and see page 9

81" h Box/Box/File, Open Storage Cabinet with Side Wardrobe	D	W	H	CTN WT	CU FT	① Model	Laminate	Flat Cut Veneer	Double Cut Veneer
	22	24	81	254	30	FLT2224-81F10WR	\$3,093		
	22	24	81	254	30	FLV2224-81F10WR		\$4,897	\$5,386
	22	24	81	254	30	FLT2224-81F10WL	\$3,093		
	22	24	81	254	30	FLV2224-81F10WL		\$4,897	\$5,386

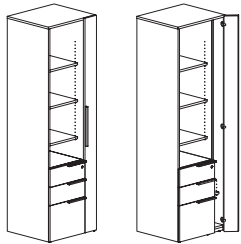

right shown

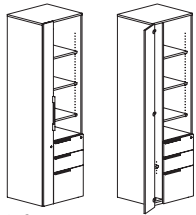

left

Features:

- aligns with primary height units
- pedestal front locking
- upper compartment has three adjustable shelves
- installed coat hook in wardrobe compartment

Options:

- must specify chassis grain direction on double cut veneer, see pages 11-13 for details
- veneer door and drawer front in paint available, specify paint color and add \$337; see page 14 for details
- on laminate units, contrasting door and drawer fronts available, no upcharge; specify color, see page 14 for details
- locking side door available, specify and add \$142 list
- ledge pulls standard; prism pulls available, specify and see page 9

To Order, Specify:

① Laminate Model #	② Laminate Selection		③ Metal Color	④ Other Product Options	
Laminate (FLT)	See Laminate Selection		See Metal Finish Color Options	See list of options for each specific unit; Specify and add accordingly.	
① Veneer Model #	② Wood Species	③ Wood Finish		④ Metal Color	⑤ Other Product Options
Veneer (FLV)	Flat Cut CH1 Cherry MA1 Maple WA1 Walnut BO1 Black Oak	See Flat Cut Wood Finish Options		See Metal Finish Color Options	See list of options for each specific unit; Specify and add accordingly.
	Double Cut DC1 Double Cut	See Double Cut Wood Finish Options	③b Chassis Grain Direction For Double Cut Only: Vertical Horizontal		

Description	D	W	H	CTN WT	CU FT	① Model	Laminate	Flat Cut Veneer	Double Cut Veneer
81" Lower and Upper Hinge Door Storage Cabinet with Side Wardrobe	22	24	81	254	30	FLT2224-81F7DWR	\$2,488		
	22	24	81	254	30	FLV2224-81F7DWR		\$4,266	\$4,693
	22	24	81	254	30	FLT2224-81F7DWL	\$2,488		
	22	24	81	254	30	FLV2224-81F7DWL		\$4,266	\$4,693

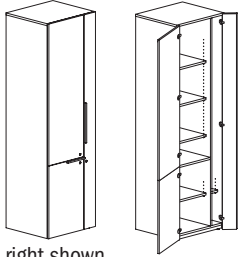

right shown

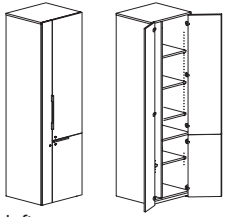

left

Features:

- aligns with primary height units
- upper compartment has three adjustable shelves, lower compartment has one adjustable shelf
- installed coat hook in wardrobe compartment

Options:

- must specify chassis grain direction on double cut veneer, see pages 11-13 for details
- veneer door fronts in paint available, specify paint color and add \$337 list; see page 14 for detail
- on laminate units, contrasting doors fronts available, no upcharge; specify color, see page 14 for details
- locking doors available, specify and add \$426 list
- ledge pulls standard; prism pulls available, specify and see page 9
- pull out trash can available, specify and add \$456 list; see page 36 for details

81" Lower Hinge Door, Open Storage Cabinet with Side Wardrobe	22	24	81	232	30	FLT2224-81F70WR	\$2,378		
	22	24	81	232	30	FLV2224-81F70WR		\$4,110	\$4,522
	22	24	81	232	30	FLT2224-81F70WL	\$2,378		
	22	24	81	232	30	FLV2224-81F70WL		\$4,110	\$4,522

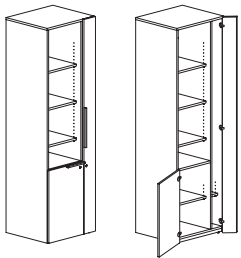

right shown

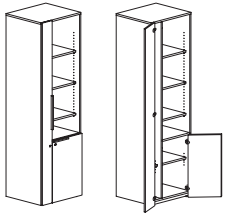

left

Features:

- aligns with primary height units
- upper compartment has three adjustable shelves, lower compartment has one adjustable shelf
- installed coat hook in wardrobe compartment

Options:

- must specify chassis grain direction on double cut veneer, see pages 11-13 for details
- veneer door fronts in paint available, specify paint color and add \$337 list; see page 14 for detail
- on laminate units, contrasting doors fronts available, no upcharge; specify color, see page 14 for details
- locking doors available, specify and add \$284 list
- ledge pulls standard; prism pulls available, specify and see page 9
- pull out trash can available, specify and add \$456 list; see page 36 for details

Description	D	W	H	CTN WT	CU FT	① Model	Laminate	Flat Cut Veneer	Double Cut Veneer
69" h File/File, Storage Cabinet with Side Wardrobe	22	24	69	239	26	FLT2224-69F2DWR	\$3,004		
	22	24	69	239	26	FLV2224-69F2DWR		\$4,771	\$5,247
	22	24	69	239	26	FLT2224-69F2DWL	\$3,004		
	22	24	69	239	26	FLV2224-69F2DWL		\$4,771	\$5,247

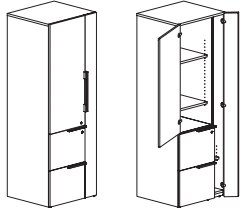

right shown

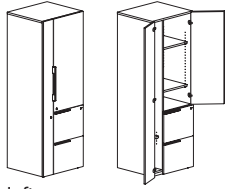

left

Features

- aligns with primary height units
- pedestal front locking
- upper compartment has two adjustable shelves
- installed coat hook in wardrobe compartment

Options:

- must specify chassis grain direction on double cut veneer, see pages 11-13 for details
- veneer door and drawer front in paint available, specify paint color and add \$337; see page 14 for details
- on laminate units, contrasting door and drawer fronts available, no upcharge; specify color, see page 14 for details
- locking doors available, specify and add \$284 list
- ledge pulls standard, mounted vertical; prism pulls available, specify and see page 9

69" h Box/Box/File, Storage Cabinet with Side Wardrobe	22	24	69	241	26	FLT2224-69F1DWR	\$3,010		
	22	24	69	241	26	FLV2224-69F1DWR		\$4,777	\$5,255
	22	24	69	241	26	FLT2224-69F1DWL	\$3,010		
	22	24	69	241	26	FLV2224-69F1DWL		\$4,777	\$5,255

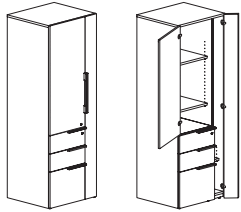

right shown

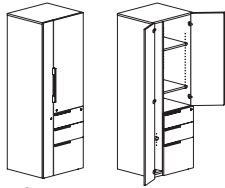

left

Features:

- aligns with primary height units
- pedestal front locking
- upper compartment has two adjustable shelves
- installed coat hook in wardrobe compartment

Options:

- must specify chassis grain direction on double cut veneer, see pages 11-13 for details
- veneer door and drawer front in paint available, specify paint color and add \$337; see page 14 for details
- on laminate units, contrasting door and drawer fronts available, no upcharge; specify color, see page 14 for details
- locking doors available, specify and add \$284 list
- ledge pulls standard, mounted vertical; prism pulls available, specify and see page 9

To Order, Specify:

① Laminate Model #	② Laminate Selection		③ Metal Color	④ Other Product Options	
Laminate (FLT)	See Laminate Selection		See Metal Finish Color Options	See list of options for each specific unit; Specify and add accordingly.	
① Veneer Model #	② Wood Species	③ Wood Finish		④ Metal Color	⑤ Other Product Options
Veneer (FLV)	Flat Cut CH1 Cherry MA1 Maple WA1 Walnut BO1 Black Oak	See Flat Cut Wood Finish Options		See Metal Finish Color Options	See list of options for each specific unit; Specify and add accordingly.
	Double Cut DC1 Double Cut	See Double Cut Wood Finish Options	③b Chassis Grain Direction For Double Cut Only: Vertical Horizontal		

Description	D	W	H	CTN WT	CU FT	① Model	Laminate	Flat Cut Veneer	Double Cut Veneer
69" h File/File, Open Storage Cabinet with Side Wardrobe	22	24	69	222	26	FLT2224-69F20WR	\$2,916		
	22	24	69	222	26	FLV2224-69F20WR		\$4,647	\$5,111
	22	24	69	222	26	FLT2224-69F20WL	\$2,916		
	22	24	69	222	26	FLV2224-69F20WL		\$4,647	\$5,111

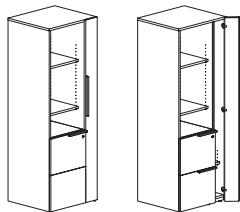

right shown

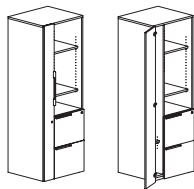

left

Features:

- aligns with primary height units
- pedestal front locking
- upper compartment has two adjustable shelves
- installed coat hook in wardrobe compartment

Options:

- must specify chassis grain direction on double cut veneer, see pages 11-13 for details
- veneer door and drawer front in paint available, specify paint color and add \$337; see page 14 for details
- on laminate units, contrasting door and drawer fronts available, no upcharge; specify color, see page 14 for details
- locking side door available, specify and add \$142 list
- ledge pulls standard, mounted vertical; prism pulls available, specify and see page 9

69" h Box/Box/File, Open Storage Cabinet with Side Wardrobe	22	24	69	224	26	FLT2224-69F10WR	\$2,925		
	22	24	69	224	26	FLV2224-69F10WR		\$4,654	\$5,118
	22	24	69	224	26	FLT2224-69F10WL	\$2,925		
	22	24	69	224	26	FLV2224-69F10WL		\$4,654	\$5,118

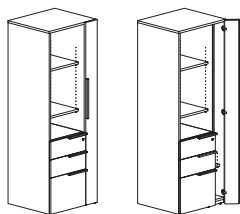

right shown

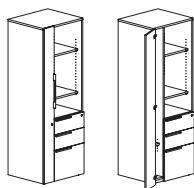

left

Features:

- aligns with primary height units
- pedestal front locking
- upper compartment has two adjustable shelves
- installed coat hook in wardrobe compartment

Options:

- must specify chassis grain direction on double cut veneer, see pages 11-13 for details
- veneer door and drawer front in paint available, specify paint color and add \$337; see page 14 for details
- on laminate units, contrasting door and drawer fronts available, no upcharge; specify color, see page 14 for details
- locking side door available, specify and add \$142 list
- ledge pulls standard, mounted vertical; prism pulls available, specify and see page 9

Description	D	W	H	CTN WT	CU FT	① Model	Laminate	Flat Cut Veneer	Double Cut Veneer
69" h Lower and Upper Hinge Door Storage Cabinet with Side Wardrobe	22	24	69	218	26	FLT2224-69F7DWR	\$2,295		
	22	24	69	218	26	FLV2224-69F7DWR		\$3,992	\$4,393
	22	24	69	218	26	FLT2224-69F7DWL	\$2,295		
	22	24	69	218	26	FLV2224-69F7DWL		\$3,992	\$4,393

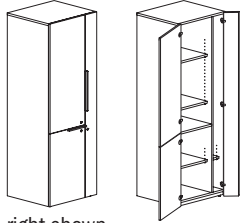

right shown

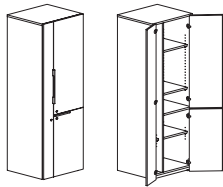

left

Features:

- aligns with primary height units
- upper compartment has two adjustable shelves, lower compartment has one adjustable shelf
- installed coat hook in wardrobe compartment

Options:

- must specify chassis grain direction on double cut veneer, see pages 11-13 for details
- veneer door fronts in paint available, specify paint color and add \$337 list; see page 14 for detail
- on laminate units, contrasting doors fronts available, no upcharge; specify color, see page 14 for details
- locking doors available, specify and add \$426 list
- ledge pulls standard, mounted vertical; prism pulls available, specify and see page 9
- pull out trash can available, specify and add \$456 list; see page 36 for details
- vanity mirror available, specify and add \$141 list

69" h Lower Hinge Door, Open Storage Cabinet with Side Wardrobe	22	24	69	201	26	FLT2224-69F7OWR	\$2,208		
	22	24	69	201	26	FLV2224-69F7OWR		\$3,867	\$4,253
	22	24	69	201	26	FLT2224-69F7OWL	\$2,208		
	22	24	69	201	26	FLV2224-69F7OWL		\$3,867	\$4,253

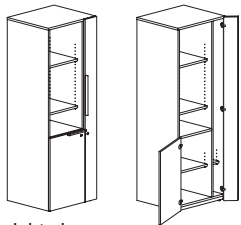

right shown

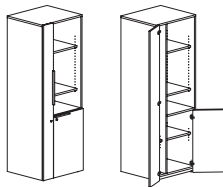

left

Features:

- aligns with primary height units
- upper compartment has two adjustable shelves, lower compartment has one adjustable shelf
- installed coat hook in wardrobe compartment

Options:

- must specify chassis grain direction on double cut veneer, see pages 11-13 for details
- veneer door fronts in paint available, specify paint color and add \$337 list; see page 14 for detail
- on laminate units, contrasting doors fronts available, no upcharge; specify color, see page 14 for details
- locking doors available, specify and add \$284 list
- ledge pulls standard, mounted vertical; prism pulls available, specify and see page 9
- pull out trash can available, specify and add \$456 list; see page 36 for details

To Order, Specify:

① Laminate Model #	② Laminate Selection	③ Metal Color	④ Other Product Options
Laminate (FLT)	See Laminate Selection	See Metal Finish Color Options	See list of options for each specific unit; Specify and add accordingly.

① Veneer Model #	② Wood Species	③ Wood Finish	④ Metal Color	⑤ Other Product Options
Veneer (FLV)	Flat Cut CH1 Cherry MA1 Maple WA1 Walnut BO1 Black Oak	See Flat Cut Wood Finish Options	See Metal Finish Color Options	See list of options for each specific unit; Specify and add accordingly.
		③a Wood Finish See Double Cut Wood Finish Options		

Description	D	W	H	CTN WT	CU FT	① Model	Laminate	Flat Cut Veneer	Double Cut Veneer
81" h Side Access Wardrobe with Open Shelves	15 $\frac{7}{8}$ "	36	81	211	32	FLT1636-81FSWR	\$2,390		
	15 $\frac{7}{8}$ "	36	81	211	32	FLV1636-81FSWR		\$3,819	\$4,203
	15 $\frac{7}{8}$ "	36	81	211	32	FLT1636-81FSWL	\$2,390		
	15 $\frac{7}{8}$ "	36	81	211	32	FLV1636-81FSWL		\$3,819	\$4,203
	15 $\frac{7}{8}$ "	30	81	185	27	FLT1630-81FSWR	\$2,203		
	15 $\frac{7}{8}$ "	30	81	185	27	FLV1630-81FSWR		\$3,524	\$3,877
	15 $\frac{7}{8}$ "	30	81	185	27	FLT1630-81FSWL	\$2,203		
	15 $\frac{7}{8}$ "	30	81	185	27	FLV1630-81FSWL		\$3,524	\$3,877

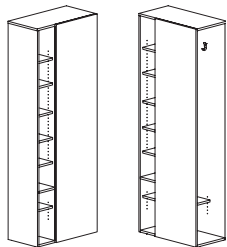

right shown

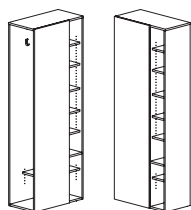

left

Features:

- attaching hardware included
- side entry wardrobe with two installed coat hooks and one lower adjustable shelf
- 8 $\frac{1}{4}$ " w open compartment with five adjustable shelves

Options:

- must specify chassis grain direction on double cut veneer, see pages 11-13 for details

Description	D	W	H	CTN WT	CU FT	① Model	Laminate	Flat Cut Veneer	Double Cut Veneer
69" h Side Access Wardrobe with Open Shelves	15 7/8	36	69	184	27	FLT1636-69FSWR	\$2,199		
	15 7/8	36	69	184	27	FLV1636-69FSWR		\$3,544	\$3,899
	15 7/8	36	69	184	27	FLT1636-69FSWL	\$2,199		
	15 7/8	36	69	184	27	FLV1636-69FSWL		\$3,544	\$3,899
	15 7/8	30	69	160	23	FLT1630-69FSWR	\$2,026		
	15 7/8	30	69	160	23	FLV1630-69FSWR		\$3,265	\$3,591
	15 7/8	30	69	160	23	FLT1630-69FSWL	\$2,026		
	15 7/8	30	69	160	23	FLV1630-69FSWL		\$3,265	\$3,591

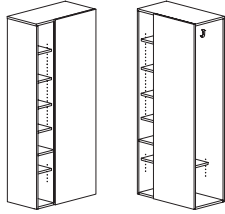

right shown

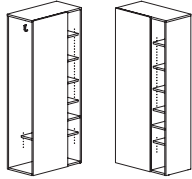

left

Features:

- attaching hardware included
- side entry wardrobe with two installed coat hooks and one lower adjustable shelf
- 8 1/4" w open compartment with four adjustable shelves

Options:

- must specify chassis grain direction on double cut veneer, see pages 11-13 for details

To Order, Specify:

① Laminate Model #		② Laminate Selection		③ Metal Color	④ Other Product Options
Laminate (FLT)		See Laminate Selection		See Metal Finish Color Options	See list of options for each specific unit; Specify and add accordingly.
① Veneer Model #	② Wood Species	③ Wood Finish		④ Metal Color	⑤ Other Product Options
Veneer (FLV)	Flat Cut CH1 Cherry MA1 Maple WA1 Walnut BO1 Black Oak	See Flat Cut Wood Finish Options		See Metal Finish Color Options	See list of options for each specific unit; Specify and add accordingly.
	Double Cut DC1 Double Cut	See Double Cut Wood Finish Options	③b Chassis Grain Direction For Double Cut Only: Vertical Horizontal		

Description	D	W	H	CTN WT	CU FT	① Model	Laminate	Flat Cut Veneer	Double Cut Veneer
81" h File/File Lateral, Storage Cabinet	22	36	81	326	44	FLT2236-81F4D	\$3,392		
	22	36	81	326	44	FLV2236-81F4D		\$5,361	\$5,898
	22	30	81	281	37	FLT2230-81F4D	\$3,212		
	22	30	81	281	37	FLV2230-81F4D		\$5,124	\$5,639

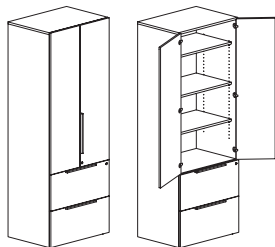

Features:

- aligns with primary height units
- pedestal front locking
- upper compartment has three adjustable shelves

Options:

- must specify chassis grain direction on double cut veneer, see pages 11-13 for details
- veneer door and drawer front in paint available, specify paint color and add \$337; see page 14 for details
- on laminate units, contrasting door and drawer fronts available, no upcharge; specify color, see page 14 for details
- locking upper doors available, specify and add \$142 list
- ledge pulls standard; prism pulls available, specify and see page 9

81" h Box/Box File Lateral, Storage Cabinet	22	36	81	326	44	FLT2236-81F3D	\$3,405		
	22	36	81	326	44	FLV2236-81F3D		\$5,374	\$5,910
	22	30	81	281	37	FLT2230-81F3D	\$3,222		
	22	30	81	281	37	FLV2230-81F3D		\$5,137	\$5,649

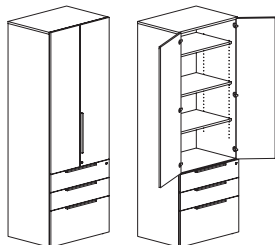

Features:

- aligns with primary height units
- pedestal front locking
- upper compartment has three adjustable shelves

Options:

- must specify chassis grain direction on double cut veneer, see pages 11-13 for details
- veneer door and drawer front in paint available, specify paint color and add \$337; see page 14 for details
- on laminate units, contrasting door and drawer fronts available, no upcharge; specify color, see page 14 for details
- locking upper doors available, specify and add \$142 list
- ledge pulls standard; prism pulls available, specify and see page 9

81" h Lower and Upper Hinge Door Storage Cabinet	22	36	81	310	44	FLT2236-81F7D	\$2,726		
	22	36	81	310	44	FLV2236-81F7D		\$4,658	\$5,123
	22	30	81	270	37	FLT2230-81F7D	\$2,560		
	22	30	81	270	37	FLV2230-81F7D		\$4,444	\$4,888

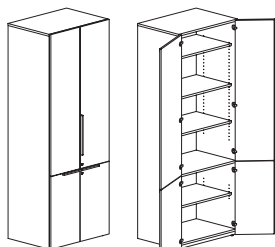

Features:

- aligns with primary height units
- upper compartment has three adjustable shelves, lower compartment has one adjustable shelf

Options:

- must specify chassis grain direction on double cut veneer, see pages 11-13 for details
- veneer door fronts in paint available, specify paint color and add \$337 list; see page 14 for details
- on laminate units, contrasting doors fronts available, no upcharge; specify color, see page 14 for details
- locking doors available, specify and add \$284 list
- ledge pulls standard, mounted vertical; prism pulls available, specify and see page 9

FLUX - PRIVATE OFFICE

Description	D	W	H	CTN WT	CU FT	① Model	Laminate	Flat Cut Veneer	Double Cut Veneer
81" h File/File Lateral, Open Storage Cabinet	22	36	81	282	44	FLT2236-81F40	\$3,194		
	22	36	81	282	44	FLV2236-81F40		\$5,099	\$5,608
	22	30	81	255	37	FLT2230-81F40	\$3,026		
	22	30	81	255	37	FLV2230-81F40		\$4,881	\$5,368

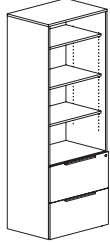

Features:

- aligns with primary height units
- pedestal front locking
- upper compartment has three adjustable shelves

Options:

- must specify chassis grain direction on double cut veneer, see pages 11-13 for details
- veneer drawer fronts in paint available, specify paint color and add \$337 list; see page 14 for details
- on laminate units, contrasting drawer fronts available, no upcharge; specify color, see page 14 for details
- ledge pulls standard; prism pulls available, specify and see page 9

81" h Box/Box/File Lateral, Open Storage Cabinet	22	36	81	282	44	FLT2236-81F30	\$3,205		
	22	36	81	282	44	FLV2236-81F30		\$5,112	\$5,623
	22	30	81	255	37	FLT2230-81F30	\$3,040		
	22	30	81	255	37	FLV2230-81F30		\$4,891	\$5,379

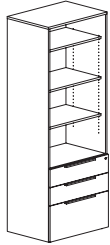

Features:

- aligns with primary height units
- pedestal front locking
- upper compartment has three adjustable shelves

Options:

- must specify chassis grain direction on double cut veneer, see pages 11-13 for details
- veneer drawer fronts in paint available, specify paint color and add \$337 list; see page 14 for details
- on laminate units, contrasting drawer fronts available, no upcharge; specify color, see page 14 for details
- ledge pulls standard; prism pulls available, specify and see page 9

81" h Lower Hinge Doors, Open Storage Cabinet	22	36	81	261	44	FLT2236-81F70	\$2,527		
	22	36	81	261	44	FLV2236-81F70		\$4,398	\$4,837
	22	30	81	233	37	FLT2230-81F70	\$2,373		
	22	30	81	233	37	FLV2230-81F70		\$4,199	\$4,619

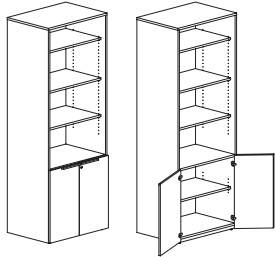

Features:

- aligns with primary height units
- upper compartment has three adjustable shelves, lower compartment has one adjustable shelf

Options:

- must specify chassis grain direction on double cut veneer, see pages 11-13 for details
- veneer door fronts in paint available, specify paint color and add \$337 list; see page 14 for details
- on laminate units, contrasting doors fronts available, no upcharge; specify color, see page 14 for details
- locking lower doors available specify and add \$142 list
- ledge pulls standard; prism pulls available, specify and see page 9

To Order, Specify:

① Laminate Model #	② Laminate Selection	③ Metal Color	④ Other Product Options
Laminate (FLT)	See Laminate Selection	See Metal Finish Color Options	See list of options for each specific unit; Specify and add accordingly.

① Veneer Model #	② Wood Species	③ Wood Finish	④ Metal Color	⑤ Other Product Options	
Veneer (FLV)	Flat Cut CH1 Cherry MA1 Maple WA1 Walnut BO1 Black Oak	See Flat Cut Wood Finish Options	See Metal Finish Color Options	See list of options for each specific unit; Specify and add accordingly.	
	Double Cut DC1 Double Cut	<table border="1"> <thead> <tr> <th>ⓐ Wood Finish</th> <th>ⓑ Chassis Grain Direction</th> </tr> </thead> <tbody> <tr> <td>See Double Cut Wood Finish Options</td> <td>For Double Cut Only: Vertical Horizontal</td> </tr> </tbody> </table>			ⓐ Wood Finish
ⓐ Wood Finish	ⓑ Chassis Grain Direction				
See Double Cut Wood Finish Options	For Double Cut Only: Vertical Horizontal				

Description	D	W	H	CTN WT	CU FT	① Model	Laminate	Flat Cut Veneer	Double Cut Veneer
69" h File/File Lateral, Storage Cabinet	22	36	69	305	38	FLT2236-69F4D	\$3,095		
	22	36	69	305	38	FLV2236-69F4D		\$4,937	\$5,429
	22	30	69	262	32	FLT2230-69F4D	\$2,943		
	22	30	69	262	32	FLV2230-69F4D		\$4,739	\$5,213

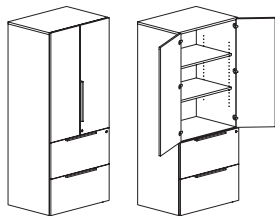

Features:

- aligns with primary height units
- upper compartment has two adjustable shelves

Options:

- must specify chassis grain direction on double cut veneer, see pages 11-13 for details
- veneer door and drawer front in paint available, specify paint color and add \$337; see page 14 for details
- on laminate units, contrasting door and drawer fronts available, no upcharge; specify color, see page 14 for details
- locking upper doors available, specify and add \$142 list
- ledge pulls standard; prism pulls available, specify and see page 9

69" h Box/Box/File Lateral, Storage Cabinet	22	36	69	303	38	FLT2236-69F3D	\$3,108		
	22	36	69	303	38	FLV2236-69F3D		\$4,950	\$5,445
	22	30	69	265	32	FLT2230-69F3D	\$2,955		
	22	30	69	265	32	FLV2230-69F3D		\$4,750	\$5,227

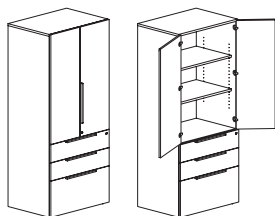

Features:

- aligns with primary height units
- pedestal front locking
- upper compartment has two adjustable shelves

Options:

- must specify chassis grain direction on double cut veneer, see pages 11-13 for details
- veneer door and drawer front in paint available, specify paint color and add \$337; see page 14 for details
- on laminate units, contrasting door and drawer fronts available, no upcharge; specify color, see page 14 for details
- locking upper doors available, specify and add \$142 list
- ledge pulls standard; prism pulls available, specify and see page 9

69" h Lower and Upper Hinge Door Storage Cabinet	22	36	69	267	38	FLT2236-69F7D	\$2,429		
	22	36	69	267	38	FLV2236-69F7D		\$4,234	\$4,658
	22	30	69	232	32	FLT2230-69F7D	\$2,290		
	22	30	69	232	32	FLV2230-69F7D		\$4,058	\$4,464

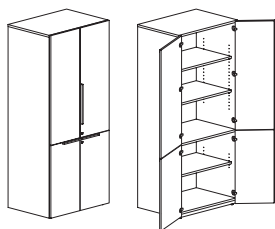

Features:

- aligns with primary height units
- upper compartment has two adjustable shelves, lower compartment has one adjustable shelf

Options:

- must specify chassis grain direction on double cut veneer, see pages 11-13 for details
- veneer door fronts in paint available, specify paint color and add \$337 list; see page 14 for details
- on laminate units, contrasting doors fronts available, no upcharge; specify color, see page 14 for details
- locking doors available, specify and add \$284 list
- ledge pulls standard; prism pulls available, specify and see page 9

FLUX - PRIVATE OFFICE

Description	D	W	H	CTN WT	CU FT	① Model	Laminate	Flat Cut Veneer	Double Cut Veneer
69" h File/File Lateral, Open Storage Cabinet	22	36	69	262	37	FLT2236-69F40	\$2,933		
	22	36	69	262	37	FLV2236-69F40		\$4,726	\$5,199
	22	30	69	225	32	FLT2230-69F40	\$2,790		
	22	30	69	225	32	FLV2230-69F40		\$4,726	\$5,199

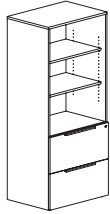

Features:

- aligns with primary height units
- pedestal front locking
- upper compartment has two adjustable shelves

Options:

- must specify chassis grain direction on double cut veneer, see pages 11-13 for details
- veneer drawer fronts in paint available, specify paint color and add \$337 list; see page 14 for details
- on laminate units, contrasting drawer fronts available, no upcharge; specify color, see page 14 for details
- ledge pulls standard; prism pulls available, specify and see page 9

69" h Box/Box/File Lateral, Open Storage Cabinet	22	36	69	261	37	FLT2236-69F30	\$2,943		
	22	36	69	261	37	FLV2236-69F30		\$4,736	\$5,212
	22	30	69	228	32	FLT2230-69F30	\$2,801		
	22	30	69	228	32	FLV2230-69F30		\$4,550	\$5,009

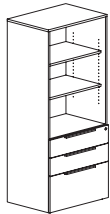

Features:

- aligns with primary height units
- pedestal front locking
- upper compartment has two adjustable shelves

Options:

- must specify chassis grain direction on double cut veneer, see pages 11-13 for details
- veneer drawer fronts in paint available, specify paint color and add \$337 list; see page 14 for details
- on laminate units, contrasting drawer fronts available, no upcharge; specify color, see page 14 for details
- ledge pulls standard; prism pulls available, specify and see page 9

69" h Lower Hinge Doors, Open Storage Cabinet	22	36	69	266	38	FLT2236-69F70	\$2,264		
	22	36	69	266	38	FLV2236-69F70		\$4,023	\$4,424
	22	30	69	204	32	FLT2230-69F70	\$2,135		
	22	30	69	204	32	FLV2230-69F70		\$3,857	\$4,246

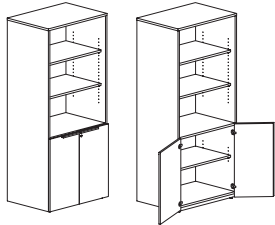

Features:

- aligns with primary height units
- upper compartment has two adjustable shelves, lower compartment has one adjustable shelf

Options:

- must specify chassis grain direction on double cut veneer, see pages 11-13 for details
- veneer door fronts in paint available, specify paint color and add \$337 list; see page 14 for details
- on laminate units, contrasting doors fronts available, no upcharge; specify color, see page 14 for details
- locking lower doors available specify and add \$142 list
- ledge pulls standard; prism pulls available, specify and see page 9

To Order, Specify:

① Laminate Model #		② Laminate Selection		③ Metal Color		④ Other Product Options			
Laminate (FLT)		See Laminate Selection		See Metal Finish Color Options		See list of options for each specific unit; Specify and add accordingly.			
① Veneer Model #		② Wood Species		③ Wood Finish		④ Metal Color		⑤ Other Product Options	
Veneer (FLV)		Flat Cut CH1 Cherry MA1 Maple WA1 Walnut BO1 Black Oak		See Flat Cut Wood Finish Options		See Metal Finish Color Options		See list of options for each specific unit; Specify and add accordingly.	
		Double Cut DC1 Double Cut		See Double Cut Wood Finish Options		③b Chassis Grain Direction			
						For Double Cut Only: Vertical Horizontal			

Description	D	W	H	CTN WT	CU FT	① Model	Laminate	Flat Cut Veneer	Double Cut Veneer
81" h File/File, Storage Cabinet	22	18	81	209	24	FLT2218-81F2DR	\$2,530		
	22	18	81	209	24	FLV2218-81F2DR		\$3,973	\$4,370
	22	18	81	209	24	FLT2218-81F2DL	\$2,530		
	22	18	81	209	24	FLV2218-81F2DL		\$3,973	\$4,370

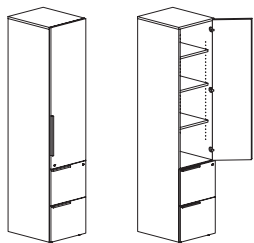

right shown

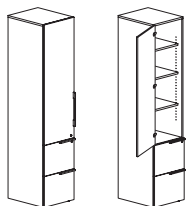

left

Features:

- aligns with primary height units
- pedestal front locking
- upper compartment has three adjustable shelves

Options:

- must specify chassis grain direction on double cut veneer, see pages 11-13 for details
- veneer door and drawer front in paint available, specify paint color and add \$337; see page 14 for details
- on laminate units, contrasting door and drawer fronts available, no upcharge; specify color, see page 14 for details
- locking upper door available, specify and add \$142 list
- ledge pulls standard; prism pulls available, specify and see page 9
- vanity mirror available, specify and add \$141 list

81" h Box/Box/File, Storage Cabinet	22	18	81	210	24	FLT2218-81F1DR	\$2,539		
	22	18	81	210	24	FLV2218-81F1DR		\$3,982	\$4,379
	22	18	81	210	24	FLT2218-81F1DL	\$2,539		
	22	18	81	210	24	FLV2218-81F1DL		\$3,982	\$4,379

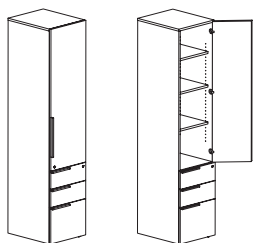

right shown

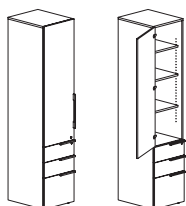

left

Features:

- aligns with primary height units
- pedestal front locking
- upper compartment has three adjustable shelves

Options:

- must specify chassis grain direction on double cut veneer, see pages 11-13 for details
- veneer door and drawer front in paint available, specify paint color and add \$337; see page 14 for details
- on laminate units, contrasting door and drawer fronts available, no upcharge; specify color, see page 14 for details
- locking upper door available, specify and add \$142 list
- ledge pulls standard; prism pulls available, specify and see page 9
- vanity mirror available, specify and add \$141 list

Description	D	W	H	CTN WT	CU FT	① Model	Laminate	Flat Cut Veneer	Double Cut Veneer
81" h File/File, Open Storage Cabinet	22	18	81	187	24	FLT2218-81F20	\$2,423		
	22	18	81	187	24	FLV2218-81F20		\$3,816	\$4,198

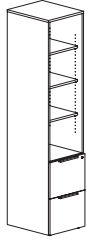

Features:

- aligns with primary height units
- pedestal front locking
- upper compartment has three adjustable shelves

Options:

- must specify chassis grain direction on double cut veneer, see pages 11-13 for details
- veneer drawer fronts in paint available, specify paint color and add \$337 list; see page 14 for details
- on laminate units, contrasting drawer fronts available, no upcharge; specify color, see page 14 for details
- ledge pulls standard; prism pulls available, specify and see page 9

81" h Box/Box/File, Open Storage Cabinet	22	18	81	187	24	FLT2218-81F10	\$2,430		
	22	18	81	187	24	FLV2218-81F10		\$3,825	\$4,207

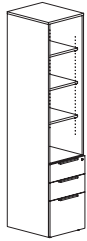

Features:

- aligns with primary height units
- pedestal front locking
- upper compartment has three adjustable shelves

Options:

- must specify chassis grain direction on double cut veneer, see pages 11-13 for details
- veneer drawer fronts in paint available, specify paint color and add \$337 list; see page 14 for details
- on laminate units, contrasting drawer fronts available, no upcharge; specify color, see page 14 for details
- ledge pulls standard; prism pulls available, specify and see page 9

To Order, Specify:

① Laminate Model #		② Laminate Selection		③ Metal Color	④ Other Product Options
Laminate (FLT)		See Laminate Selection		See Metal Finish Color Options	See list of options for each specific unit; Specify and add accordingly.
① Veneer Model #	② Wood Species	③ Wood Finish		④ Metal Color	⑤ Other Product Options
Veneer (FLV)	Flat Cut CH1 Cherry MA1 Maple WA1 Walnut BO1 Black Oak	See Flat Cut Wood Finish Options		See Metal Finish Color Options	See list of options for each specific unit; Specify and add accordingly.
		Double Cut DC1 Double Cut	ⓐ Wood Finish See Double Cut Wood Finish Options		

Description	D	W	H	CTN WT	CU FT	① Model	Laminate	Flat Cut Veneer	Double Cut Veneer
69" h File/File, Storage Cabinet	22	18	69	192	20	FLT2218-69F2DR	\$2,337		
	22	18	69	192	20	FLV2218-69F2DR		\$3,699	\$4,069
	22	18	69	192	20	FLT2218-69F2DL	\$2,337		
	22	18	69	192	20	FLV2218-69F2DL		\$3,699	\$4,069

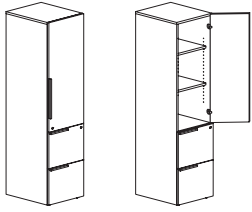

right shown

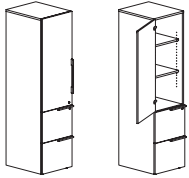

left

Features:

- aligns with primary height units
- pedestal front locking
- upper compartment has two adjustable shelves

Options:

- must specify chassis grain direction on double cut veneer, see pages 11-13 for details
- veneer door and drawer front in paint available, specify paint color and add \$337; see page 14 for details
- on laminate units, contrasting door and drawer fronts available, no upcharge; specify color, see page 14 for details
- locking upper door available, specify and add \$142 list
- ledge pulls standard; prism pulls available, specify and see page 9
- vanity mirror available, specify and add \$141 list

69" h Box/Box/File, Storage Cabinet	22	18	69	192	20	FLT2218-69F1DR	\$2,347		
	22	18	69	192	20	FLV2218-69F1DR		\$3,706	\$4,077
	22	18	69	192	20	FLT2218-69F1DL	\$2,347		
	22	18	69	192	20	FLV2218-69F1DL		\$3,706	\$4,077

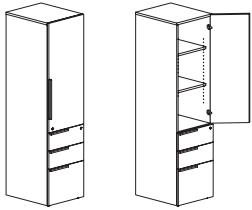

right shown

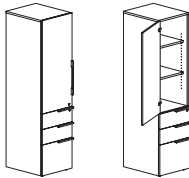

left

Features:

- aligns with primary height units
- pedestal front locking
- upper compartment has two adjustable shelves

Options:

- must specify chassis grain direction on double cut veneer, see pages 11-13 for details
- veneer door and drawer front in paint available, specify paint color and add \$337; see page 14 for details
- on laminate units, contrasting door and drawer fronts available, no upcharge; specify color, see page 14 for details
- locking upper door available, specify and add \$142 list
- ledge pulls standard; prism pulls available, specify and see page 9
- vanity mirror available, specify and add \$141 list

Description	D	W	H	CTN WT	CU FT	① Model	Laminate	Flat Cut Veneer	Double Cut Veneer
69" h File/File, Open Storage Cabinet	22	18	69	166	20	FLT2218-69F20	\$2,252		
	22	18	69	166	20	FLV2218-69F20		\$3,574	\$3,932

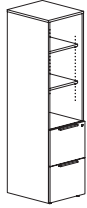

Features:

- aligns with primary height units
- pedestal front locking
- upper compartment has two adjustable shelves

Options:

- must specify chassis grain direction on double cut veneer, see pages 11-13 for details
- veneer drawer fronts in paint available, specify paint color and add \$337 list; see page 14 for details
- on laminate units, contrasting drawer fronts available, no upcharge; specify color, see page 14 for details
- ledge pulls standard; prism pulls available, specify and see page 9

69" h Box/Box/File, Open Storage Cabinet	22	18	69	166	20	FLT2218-69F10	\$2,260		
	22	18	69	166	20	FLV2218-69F10		\$3,583	\$3,941

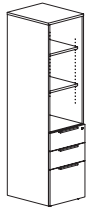

Features:

- aligns with primary height units
- pedestal front locking
- upper compartment has two adjustable shelves

Options:

- must specify chassis grain direction on double cut veneer, see pages 11-13 for details
- veneer drawer fronts in paint available, specify paint color and add \$337 list; see page 14 for details
- on laminate units, contrasting drawer fronts available, no upcharge; specify color, see page 14 for details
- ledge pulls standard; prism pulls available, specify and see page 9

To Order, Specify:

① Laminate Model #		② Laminate Selection			③ Metal Color		④ Other Product Options	
Laminate (FLT)		See Laminate Selection			See Metal Finish Color Options		See list of options for each specific unit; Specify and add accordingly.	
① Veneer Model #	② Wood Species	③ Wood Finish			④ Metal Color		⑤ Other Product Options	
Veneer (FLV)	Flat Cut CH1 Cherry MA1 Maple WA1 Walnut BO1 Black Oak	See Flat Cut Wood Finish Options			See Metal Finish Color Options		See list of options for each specific unit; Specify and add accordingly.	
	Double Cut DC1 Double Cut	See Double Cut Wood Finish Options	③b Chassis Grain Direction					
				For Double Cut Only: Vertical Horizontal				

Description	D	W	H	CTN WT	CU FT	① Model	Laminate	Flat Cut Veneer	Double Cut Veneer
81" h Lower and Upper Hinge Storage Cabinet	22	18	81	188	24	FLT2218-81F7DR	\$1,910		
	22	18	81	188	24	FLV2218-81F7DR		\$3,319	\$3,652
	22	18	81	188	24	FLT2218-81F7DL	\$1,910		
	22	18	81	188	24	FLV2218-81F7DL		\$3,319	\$3,652

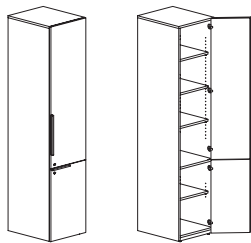

right shown

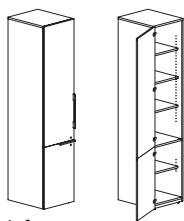

left

Features:

- aligns with primary height units
- upper compartment has three adjustable shelves, lower compartment has one adjustable shelf

Options:

- must specify chassis grain direction on double cut veneer, see pages 11-13 for details
- veneer door front in paint available, specify paint color and add \$337 list; see page 14 for details
- on laminate units, contrasting doors fronts available, no upcharge; specify color, see page 14 for details
- locking doors available, specify and add \$284 list
- ledge pulls standard, mounted vertical; prism pulls available, specify and see page 9
- pull out trash can available, specify and add \$456 list; see page 36 for details
- vanity mirror available, specify and add \$141 list

81" h Lower Hinge Door, Open Storage Cabinet	22	18	81	166	24	FLT2218-81F70R	\$1,803		
	22	18	81	166	24	FLV2218-81F70R		\$3,162	\$3,479
	22	18	81	166	24	FLT2218-81F70L	\$1,803		
	22	18	81	166	24	FLV2218-81F70L		\$3,162	\$3,479

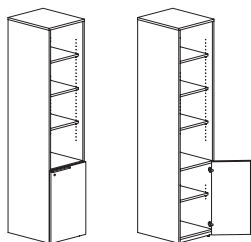

right shown

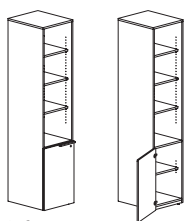

left

Features:

- aligns with primary height units
- upper compartment has three adjustable shelves, lower compartment has one adjustable shelf

Options:

- must specify chassis grain direction on double cut veneer, see pages 11-13 for details
- veneer door front in paint available, specify paint color and add \$337 list; see page 14 for details
- on laminate units, contrasting doors fronts available, no upcharge; specify color, see page 14 for details
- locking lower door available, specify and add \$142 list
- ledge pulls standard; prism pulls available, specify and see page 9
- pull out trash can available, specify and add \$456 list; see page 36 for details

Description	D	W	H	CTN WT	CU FT	① Model	Laminate	Flat Cut Veneer	Double Cut Veneer
69" h Lower and Upper Hinge Door Storage Cabinet	22	18	69	163	20	FLT2218-69F7DR	\$1,719		
	22	18	69	163	20	FLV2218-69F7DR		\$3,046	\$3,349
	22	18	69	163	20	FLT2218-69F7DL	\$1,719		
	22	18	69	163	20	FLV2218-69F7DL		\$3,046	\$3,349

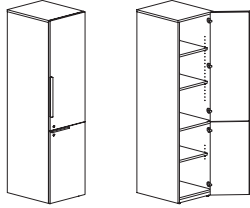

right shown

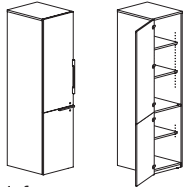

left

Features:

- aligns with primary height units
- upper compartment has two adjustable shelves, lower compartment has one adjustable shelf

Options:

- must specify chassis grain direction on double cut veneer, see pages 11-13 for details
- veneer door front in paint available, specify paint color and add \$337 list; see page 14 for details
- on laminate units, contrasting doors fronts available, no upcharge; specify color, see page 14 for details
- locking doors available, specify and add \$284 list
- ledge pulls standard, mounted vertical; prism pulls available, specify and see page 9
- pull out trash can available, specify and add \$456 list; see page 36 for details
- vanity mirror available, specify and add \$141 list

69" h Lower Hinge Door, Open Storage Cabinet	22	18	69	145	20	FLT2218-69F70R	\$1,630		
	22	18	69	145	20	FLV2218-69F70R		\$2,920	\$3,212
	22	18	69	145	20	FLT2218-69F70L	\$1,630		
	22	18	69	145	20	FLV2218-69F70L		\$2,920	\$3,212

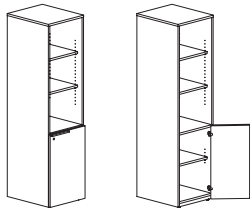

right shown

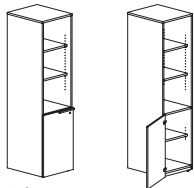

left

Features:

- aligns with primary height units
- upper compartment has two adjustable shelves

Options:

- must specify chassis grain direction on double cut veneer, see pages 11-13 for details
- veneer door front in paint available, specify paint color and add \$337 list; see page 14 for details
- on laminate units, contrasting doors fronts available, no upcharge; specify color, see page 14 for details
- locking lower door available, specify and add \$142 list
- ledge pulls standard; prism pulls available, specify and see page 9
- pull out trash can available, specify and add \$456 list; see page 36 for details

To Order, Specify:

① Laminate Model #	② Laminate Selection		③ Metal Color	④ Other Product Options	
Laminate (FLT)	See Laminate Selection		See Metal Finish Color Options	See list of options for each specific unit; Specify and add accordingly.	
① Veneer Model #	② Wood Species	③ Wood Finish		④ Metal Color	⑤ Other Product Options
Veneer (FLV)	Flat Cut CH1 Cherry MA1 Maple WA1 Walnut BO1 Black Oak	See Flat Cut Wood Finish Options		See Metal Finish Color Options	See list of options for each specific unit; Specify and add accordingly.
	Double Cut DC1 Double Cut	See Double Cut Wood Finish Options	③b Chassis Grain Direction For Double Cut Only: Vertical Horizontal		

Description	D	W	H	CTN WT	CU FT	① Model	Laminate	Flat Cut Veneer	Double Cut Veneer
81" h Pantry Drawer, Storage Cabinet	22	18	81	227	24	FLT2218-81FADR	\$2,674		
	22	18	81	227	24	FLV2218-81FADR		\$4,115	\$4,527
	22	18	81	227	24	FLT2218-81FADL	\$2,674		
	22	18	81	227	24	FLV2218-81FADL		\$4,115	\$4,527

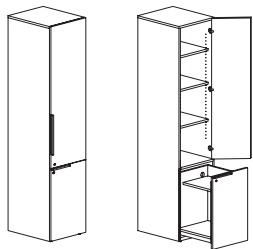

right shown

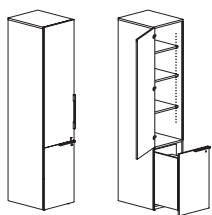

left

Features:

- aligns with primary height units
- concealed caster under drawer for added support
- upper compartment has three adjustable shelves
- oval back panel grommet standard with installed power unit
- pantry drawer front locking

Options:

- must specify chassis grain direction on double cut veneer, see pages 11-13 for details
- veneer door and drawer front in paint available, specify paint color and add \$337; see page 14 for details
- on laminate units, contrasting door and drawer fronts available, no upcharge; specify color, see page 14 for details
- locking door available, specify and add \$142 list
- ledge pulls standard; prism pulls available, specify and see page 9
- power unit (2 simplex and 2 USB charging ports) available, specify and add \$914 list; see page 36 for details
- vanity mirror available, specify and add \$141 list

81" h Pantry Drawer, Open Storage Cabinet	22	18	81	196	24	FLT2218-81FA0R	\$2,565		
	22	18	81	196	24	FLV2218-81FA0R		\$3,924	\$4,319
	22	18	81	196	24	FLT2218-81FA0L	\$2,565		
	22	18	81	196	24	FLV2218-81FA0L		\$3,924	\$4,319

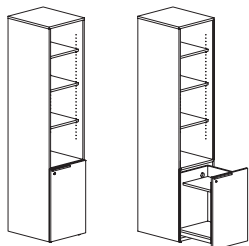

right shown

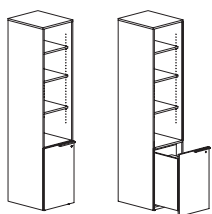

left

Features:

- aligns with primary height units
- concealed caster under drawer for added support
- upper compartment has three adjustable shelves
- oval back panel grommet standard with installed power unit
- pantry drawer front locking

Options:

- must specify chassis grain direction on double cut veneer, see pages 11-13 for details
- veneer drawer fronts in paint available, specify paint color and add \$337 list; see page 14 for details
- on laminate units, contrasting door front available, no upcharge; specify color, see page 14 for details
- ledge pulls standard; prism pulls available, specify and see page 9
- power unit (2 simplex and 2 USB charging ports) available, specify and add \$914 list; see page 36 for details

Description	D	W	H	CTN WT	CU FT	① Model	Laminate	Flat Cut Veneer	Double Cut Veneer
69" h Pantry Drawer, Storage Cabinet	22	18	69	192	20	FLT2218-69FADR	\$2,481		
	22	18	69	192	20	FLV2218-69FADR		\$3,841	\$4,225
	22	18	69	192	20	FLT2218-69FADL	\$2,481		
	22	18	69	192	20	FLV2218-69FADL		\$3,841	\$4,225

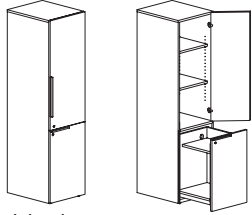

right shown

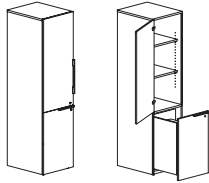

left

Features:

- aligns with primary height units
- concealed caster under drawer for added support
- upper compartment has two adjustable shelves
- oval back panel grommet standard with installed power unit
- pantry drawer front locking

Options:

- must specify chassis grain direction on double cut veneer, see pages 11-13 for details
- veneer door and drawer front in paint available, specify paint color and add \$337; see page 14 for details
- on laminate units, contrasting door and drawer fronts available, no upcharge; specify color, see page 14 for details
- locking door available, specify and add \$142 list
- ledge pulls standard, mounted vertical; prism pulls available, specify and see page 9
- power unit (2 simplex and 2 USB charging ports) available, specify and add \$914 list; see page 36 for details
- vanity mirror available, specify and add \$141 list

69" h Pantry Drawer, Open Storage Cabinet	22	18	69	173	20	FLT2218-69FA0R	\$2,393		
	22	18	69	173	20	FLV2218-69FA0R		\$3,717	\$4,089
	22	18	69	173	20	FLT2218-69FA0L	\$2,393		
	22	18	69	173	20	FLV2218-69FA0L		\$3,717	\$4,089

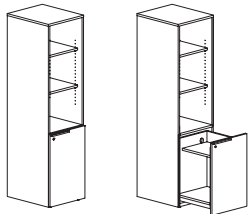

right shown

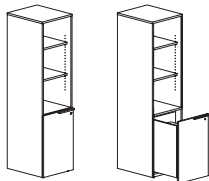

left

Features:

- aligns with primary height units
- concealed caster under drawer for added support
- upper compartment has two adjustable shelves
- oval back panel grommet standard with installed power unit
- pantry drawer front locking

Options:

- must specify chassis grain direction on double cut veneer, see pages 11-13 for details
- veneer drawer fronts in paint available, specify paint color and add \$337 list; see page 14 for details
- on laminate units, contrasting door front available, no upcharge; specify color, see page 14 for details
- ledge pulls standard; prism pulls available, specify and see page 9
- power unit (2 simplex and 2 USB charging ports) available, specify and add \$914 list; see page 36 for details

To Order, Specify:

① Laminate Model #		② Laminate Selection		③ Metal Color	④ Other Product Options
Laminate (FLT)		See Laminate Selection		See Metal Finish Color Options	See list of options for each specific unit; Specify and add accordingly.
① Veneer Model #	② Wood Species	③ Wood Finish		④ Metal Color	⑤ Other Product Options
Veneer (FLV)	Flat Cut CH1 Cherry MA1 Maple WA1 Walnut BO1 Black Oak	See Flat Cut Wood Finish Options		See Metal Finish Color Options	See list of options for each specific unit; Specify and add accordingly.
	Double Cut DC1 Double Cut	③a Wood Finish See Double Cut Wood Finish Options	③b Chassis Grain Direction For Double Cut Only: Vertical Horizontal		

Description	D	W	H	CTN WT	CU FT	① Model	Laminate	Flat Cut Veneer	Double Cut Veneer
81" h Box/File, Storage Cabinet with Side Wardrobe	22	24	81	275	30	FLT2224-81F5DWR	\$3,102		
	22	24	81	275	30	FLV2224-81F5DWR		\$4,954	\$5,450
	22	24	81	275	30	FLT2224-81F5DWL	\$3,102		
	22	24	81	275	30	FLV2224-81F5DWL		\$4,954	\$5,450

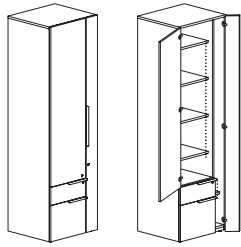

right shown

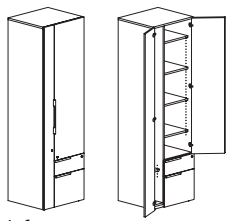

left

Features:

- aligns with secondary height units
- pedestal front locking
- upper compartment has four adjustable shelves
- installed coat hook in wardrobe compartment

Options:

- must specify chassis grain direction on double cut veneer, see pages 11-13 for details
- veneer door and drawer front in paint available, specify paint color and add \$337; see page 14 for details
- on laminate units, contrasting door and drawer fronts available, no upcharge; specify color, see page 14 for details
- locking doors available, specify and add \$284 list
- ledge pulls standard; prism pulls available, specify and see page 9

81" h Box/File, Open Storage Cabinet with Side Wardrobe	22	24	81	250	30	FLT2224-81F50WR	\$2,997		
	22	24	81	250	30	FLV2224-81F50WR		\$4,797	\$5,277
	22	24	81	250	30	FLT2224-81F50WL	\$2,997		
	22	24	81	250	30	FLV2224-81F50WL		\$4,797	\$5,277

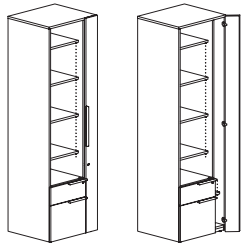

right shown

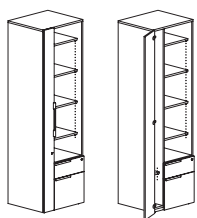

left

Features:

- aligns with secondary height units
- pedestal front locking
- upper compartment has four adjustable shelves
- installed coat hook in wardrobe compartment

Options:

- must specify chassis grain direction on double cut veneer, see pages 11-13 for details
- veneer door and drawer front in paint available, specify paint color and add \$337; see page 14 for details
- on laminate units, contrasting door and drawer fronts available, no upcharge; specify color, see page 14 for details
- locking door available, specify and add \$142 list
- ledge pulls standard; prism pulls available, specify and see page 9

Description	D	W	H	CTN WT	CU FT	① Model	Laminate	Flat Cut Veneer	Double Cut Veneer
81" h Lower and Upper Hinge Door Storage Cabinet with Side Wardrobe	22	24	81	260	30	FLT2224-81F8DWR	\$2,488		
	22	24	81	260	30	FLV2224-81F8DWR		\$4,266	\$4,693
	22	24	81	260	30	FLT2224-81F8DWL	\$2,488		
	22	24	81	260	30	FLV2224-81F8DWL		\$4,266	\$4,693

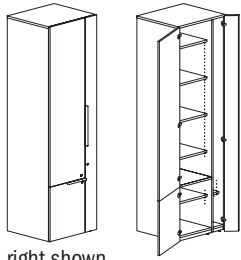

right shown

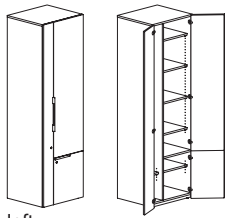

left

Features:

- aligns with secondary height units
- upper compartment has three adjustable shelves, lower compartment has one adjustable shelf
- installed coat hook in wardrobe compartment

Options:

- must specify chassis grain direction on double cut veneer, see pages 11-13 for details
- veneer door fronts in paint available, specify paint color and add \$337 list; see page 14 for detail
- on laminate units, contrasting doors fronts available, no upcharge; specify color, see page 14 for details
- locking doors available, specify and add \$426 list
- ledge pulls standard; prism pulls available, specify and see page 9
- vanity mirror available, specify and add \$141 list

81" h Lower Hinge Door, Open Storage Cabinet with Side Wardrobe	D	W	H	CTN WT	CU FT	Model	Laminate	Flat Cut Veneer	Double Cut Veneer
	22	24	81	236	30	FLT2224-81F80WR	\$2,378		
	22	24	81	236	30	FLV2224-81F80WR		\$4,110	\$4,522
	22	24	81	236	30	FLT2224-81F80WL	\$2,378		
	22	24	81	236	30	FLV2224-81F80WL		\$4,110	\$4,522

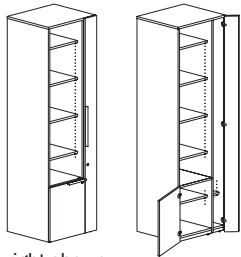

right shown

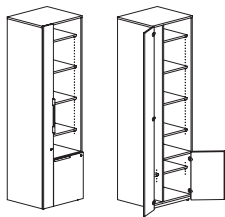

left

Features:

- aligns with secondary height units
- upper compartment has four adjustable shelves
- installed coat hook in wardrobe compartment

Options:

- must specify chassis grain direction on double cut veneer, see pages 11-13 for details
- veneer door fronts in paint available, specify paint color and add \$337 list; see page 14 for detail
- on laminate units, contrasting doors fronts available, no upcharge; specify color, see page 14 for details
- locking doors available, specify and add \$284 list
- ledge pulls standard; prism pulls available, specify and see page 9

To Order, Specify:

① Laminate Model #	② Laminate Type	③ Laminate Selection	④ Metal Color	⑤ Other Product Options
Laminate (FLT)	HPL	See Laminate Selection	See Metal Finish Color Options	See list of options for each specific unit; Specify and add accordingly.

① Veneer Model #	② Wood Species	③ Wood Finish - Finishes with an asterisk (*) have a coordinating laminate available	④ Metal Color	⑤ Other Product Options
Veneer (FLV)	Flat Cut CH1 Cherry MA1 Maple WA1 Walnut B01 Black Oak	See Flat Cut Wood Finish Options	See Metal Finish Color Options	See list of options for each specific unit; Specify and add accordingly.
		<table border="1"> <thead> <tr> <th>③a Wood Finish</th> <th>③b Chassis Grain Direction</th> </tr> </thead> <tbody> <tr> <td>See Double Cut Wood Finish Options</td> <td>For Double Cut Only: Vertical Horizontal</td> </tr> </tbody> </table>		
③a Wood Finish	③b Chassis Grain Direction			
See Double Cut Wood Finish Options	For Double Cut Only: Vertical Horizontal			

Description	D	W	H	CTN WT	CU FT	① Model	Laminate	Flat Cut Veneer	Double Cut Veneer
69" h Box/File, Storage Cabinet with Side Wardrobe	22	24	69	233	26	FLT2224-69F5DWR	\$2,910		
	22	24	69	233	26	FLV2224-69F5DWR		\$4,680	\$5,147
	22	24	69	233	26	FLT2224-69F5DWL	\$2,910		
	22	24	69	233	26	FLV2224-69F5DWL		\$4,680	\$5,147

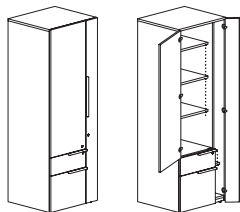

right shown

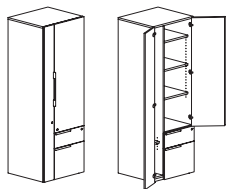

left

Features:

- aligns with secondary height units
- pedestal front locking
- upper compartment has three adjustable shelves
- installed coat hook in wardrobe compartment

Options:

- must specify chassis grain direction on double cut veneer, see pages 11-13 for details
- veneer door and drawer front in paint available, specify paint color and add \$337; see page 14 for details
- on laminate units, contrasting door and drawer fronts available, no upcharge; specify color, see page 14 for details
- locking doors available, specify and add \$284 list
- ledge pulls standard; prism pulls available, specify and see page 9
- vanity mirror available, specify and add \$141 list

69" h Box/File, Open Storage Cabinet with Side Wardrobe	22	24	69	214	26	FLT2224-69F50WR	\$2,825		
	22	24	69	214	26	FLV2224-69F50WR		\$4,555	\$5,012
	22	24	69	214	26	FLT2224-69F50WL	\$2,825		
	22	24	69	214	26	FLV2224-69F50WL		\$4,555	\$5,012

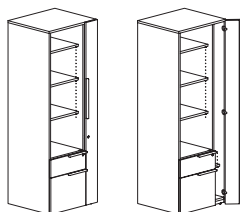

right shown

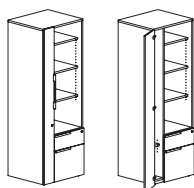

left

Features:

- aligns with secondary height units
- pedestal front locking
- upper compartment has three adjustable shelves
- installed coat hook in wardrobe compartment

Options:

- must specify chassis grain direction on double cut veneer, see pages 11-13 for details
- veneer door and drawer front in paint available, specify paint color and add \$337; see page 14 for details
- on laminate units, contrasting door and drawer fronts available, no upcharge; specify color, see page 14 for details
- locking side door available, specify and add \$142 list
- ledge pulls standard; prism pulls available, specify and see page 9

Description	D	W	H	CTN WT	CU FT	① Model	Laminate	Flat Cut Veneer	Double Cut Veneer
69" h Lower and Upper Hinge Door Storage Cabinet with Side Wardrobe	22	24	69	219	26	FLT2224-69F8DWR	\$2,295		
	22	24	69	219	26	FLV2224-69F8DWR		\$3,992	\$4,393
	22	24	69	219	26	FLT2224-69F8DWL	\$2,295		
	22	24	69	219	26	FLV2224-69F8DWL		\$3,992	\$4,393

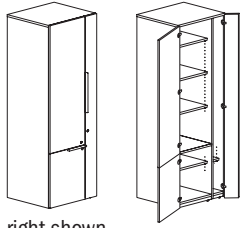

right shown

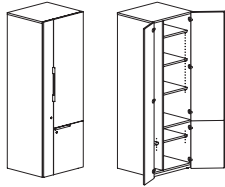

left

Features:

- aligns with secondary height units
- upper compartment has three adjustable shelves, lower compartment has one adjustable shelf
- installed coat hook in wardrobe compartment

Options:

- must specify chassis grain direction on double cut veneer, see pages 11-13 for details
- veneer door fronts in paint available, specify paint color and add \$337 list; see page 14 for detail
- on laminate units, contrasting door and drawer fronts available, no upcharge; specify color, see page 14 for details
- locking doors available, specify and add \$426 list
- ledge pulls standard; prism pulls available, specify and see page 9
- vanity mirror available, specify and add \$141 list

69" h Lower Hinge Door, Open Storage Cabinet with Side Wardrobe	22	24	69	199	26	FLT2224-69F8OWR	\$2,208		
	22	24	69	199	26	FLV2224-69F8OWR		\$3,867	\$4,253
	22	24	69	199	26	FLT2224-69F8OWL	\$2,208		
	22	24	69	199	26	FLV2224-69F8OWL		\$3,867	\$4,253

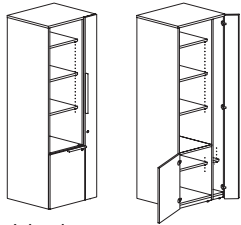

right shown

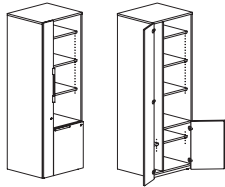

left

Features:

- aligns with secondary height units
- upper compartment has three adjustable shelves, lower compartment has one adjustable shelf
- installed coat hook in wardrobe compartment

Options:

- must specify chassis grain direction on double cut veneer, see pages 11-13 for details
- veneer door fronts in paint available, specify paint color and add \$337 list; see page 14 for detail
- on laminate units, contrasting doors fronts available, no upcharge; specify color, see page 14 for details
- locking doors available, specify and add \$284 list
- ledge pulls standard; prism pulls available, specify and see page 9

To Order, Specify:

① Laminate Model #		② Laminate Selection		③ Metal Color	④ Other Product Options
Laminate (FLT)		See Laminate Selection		See Metal Finish Color Options	See list of options for each specific unit; Specify and add accordingly.
① Veneer Model #	② Wood Species	③ Wood Finish		④ Metal Color	⑤ Other Product Options
Veneer (FLV)	Flat Cut CH1 Cherry MA1 Maple WA1 Walnut BO1 Black Oak	See Flat Cut Wood Finish Options		See Metal Finish Color Options	See list of options for each specific unit; Specify and add accordingly.
	Double Cut DC1 Double Cut	ⓐ Wood Finish See Double Cut Wood Finish Options	ⓑ Chassis Grain Direction For Double Cut Only: Vertical Horizontal		

Description	D	W	H	CTN WT	CU FT	① Model	Laminate	Flat Cut Veneer	Double Cut Veneer
81" h Box/ File Lateral, Storage Cabinet	22	36	81	342	44	FLT2236-81F6D	\$3,289		
	22	36	81	342	44	FLV2236-81F6D		\$5,258	\$5,784
	22	30	81	296	37	FLT2230-81F6D	\$3,108		
	22	30	81	296	37	FLV2230-81F6D		\$5,022	\$5,522

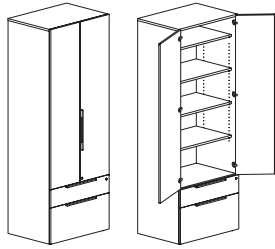

Features:

- aligns with secondary height units
- pedestal front locking
- upper compartment has four adjustable shelves

Options:

- must specify chassis grain direction on double cut veneer, see pages 11-13 for details
- veneer door and drawer front in paint available, specify paint color and add \$337; see page 14 for details
- on laminate units, contrasting door and drawer fronts available, no upcharge; specify color, see page 14 for details
- locking door available, specify and add \$142 list
- ledge pulls standard; prism pulls available, specify and see page 9

81" h Box/ File Lateral, Open Storage Cabinet	22	36	81	293	44	FLT2236-81F60	\$3,090		
	22	36	81	293	44	FLV2236-81F60		\$4,995	\$5,497
	22	30	81	255	37	FLT2230-81F60	\$2,925		
	22	30	81	255	37	FLV2230-81F60		\$4,775	\$5,253

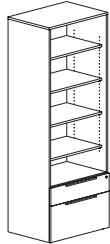

Features:

- aligns with secondary height units
- pedestal front locking
- upper compartment has four adjustable shelves

Options:

- must specify chassis grain direction on double cut veneer, see pages 11-13 for details
- veneer drawer fronts in paint available, specify paint color and add \$337 list; see page 14 for details
- on laminate units, contrasting drawer fronts available, no upcharge; specify color, see page 14 for details
- pedestal front locking
- ledge pulls standard; prism pulls available, specify and see page 9

FLUX - PRIVATE OFFICE

Description	D	W	H	CTN WT	CU FT	① Model	Laminate	Flat Cut Veneer	Double Cut Veneer
81" h Lower and Upper Hinge Door Storage Cabinet	22	36	81	324	44	FLT2236-81F8D	\$2,726		
	22	36	81	324	44	FLV2236-81F8D		\$4,658	\$5,123
	22	30	81	281	37	FLT2230-81F8D	\$2,560		
	22	30	81	281	37	FLV2230-81F8D		\$4,444	\$4,888

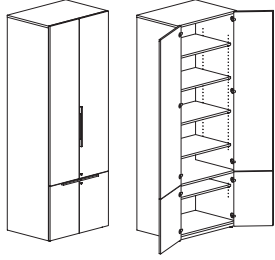

Features:

- aligns with secondary height units
- upper compartment has four adjustable shelves, lower compartment has one adjustable shelf

Options:

- must specify chassis grain direction on double cut veneer, see pages 11-13 for details
- veneer door fronts in paint available, specify paint color and add \$337 list; see page 14 for details
- on laminate units, contrasting doors fronts available, no upcharge; specify color, see page 14 for details
- locking doors available, specify and add \$284 list
- ledge pulls standard, mounted vertical; prism pulls available, specify and see page 9

81" h Lower Hinge Doors, Open Storage Cabinet	22	36	81	275	44	FLT2236-81F80	\$2,527		
	22	36	81	275	44	FLV2236-81F80		\$4,398	\$4,837
	22	30	81	240	37	FLT2230-81F80	\$2,373		
	22	30	81	240	37	FLV2230-81F80		\$4,199	\$4,619

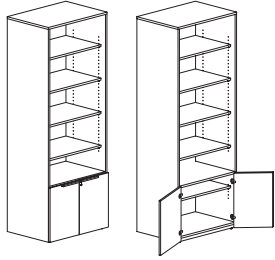

Features:

- aligns with secondary height units
- upper compartment has four adjustable shelves, lower compartment has one adjustable shelf

Options:

- must specify chassis grain direction on double cut veneer, see pages 11-13 for details
- veneer door fronts in paint available, specify paint color and add \$337 list; see page 14 for details
- on laminate units, contrasting doors fronts available, no upcharge; specify color, see page 14 for details
- locking doors available, specify and add \$142 list
- ledge pulls standard; prism pulls available, specify and see page 9

To Order, Specify:

① Laminate Model #		② Laminate Selection		③ Metal Color	④ Other Product Options
Laminate (FLT)		See Laminate Selection		See Metal Finish Color Options	See list of options for each specific unit; Specify and add accordingly.
① Veneer Model #	② Wood Species	③ Wood Finish		④ Metal Color	⑤ Other Product Options
Veneer (FLV)	Flat Cut CH1 Cherry MA1 Maple WA1 Walnut BO1 Black Oak	See Flat Cut Wood Finish Options		See Metal Finish Color Options	See list of options for each specific unit; Specify and add accordingly.
	Double Cut DC1 Double Cut	See Double Cut Wood Finish Options	③b Chassis Grain Direction For Double Cut Only: Vertical Horizontal		

Description	D	W	H	CTN WT	CU FT	① Model	Laminate	Flat Cut Veneer	Double Cut Veneer
69" h Box/File Lateral, Storage Cabinet	22	36	69	292	38	FLT2236-69F6D	\$2,993		
	22	36	69	292	38	FLV2236-69F6D		\$4,835	\$5,316
	22	30	69	205	32	FLT2230-69F6D	\$2,840		
	22	30	69	205	32	FLV2230-69F6D		\$4,636	\$5,099

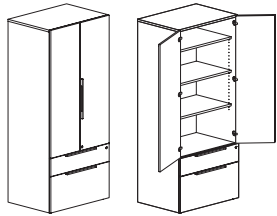

Features:

- aligns with secondary height units
- pedestal front locking
- upper compartment has three adjustable shelves

Options:

- must specify chassis grain direction on double cut veneer, see pages 11-13 for details
- veneer door and drawer front in paint available, specify paint color and add \$337; see page 14 for details
- on laminate units, contrasting door and drawer fronts available, no upcharge; specify color, see page 14 for details
- locking upper doors available, specify and add \$142 list
- ledge pulls standard; prism pulls available, specify and see page 9

69" h Box/File Lateral, Open Storage Cabinet	22	36	69	261	38	FLT2236-69F60	\$2,828		
	22	36	69	261	38	FLV2236-69F60		\$4,621	\$5,084
	22	30	69	235	32	FLT2230-69F60	\$2,685		
	22	36	69	235	32	FLV2230-69F60		\$4,437	\$4,881

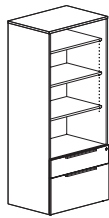

Features:

- aligns with secondary height units
- pedestal front locking
- upper compartment has three adjustable shelves

Options:

- must specify chassis grain direction on double cut veneer, see pages 11-13 for details
- veneer drawer fronts in paint available, specify paint color and add \$337 list; see page 14 for details
- on laminate units, contrasting drawer fronts available, no upcharge; specify color, see page 14 for details
- ledge pulls standard; prism pulls available, specify and see page 9

Description	D	W	H	CTN WT	CU FT	① Model	Laminate	Flat Cut Veneer	Double Cut Veneer
69" h Lower and Upper Hinge Door Storage Cabinet	22	36	69	235	38	FLT2236-69F8D	\$2,429		
	22	36	69	235	38	FLV2236-69F8D		\$4,234	\$4,658
	22	30	69	232	32	FLT2230-69F8D	\$2,290		
	22	30	69	232	32	FLV2230-69F8D		\$4,058	\$4,464

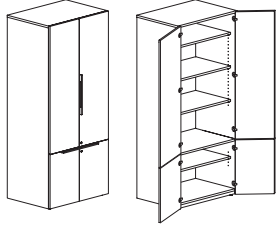

Features:

- aligns with secondary height units
- upper compartment has three adjustable shelves, lower compartment has one adjustable shelf

Options:

- must specify chassis grain direction on double cut veneer, see pages 11-13 for details
- veneer door fronts in paint available, specify paint color and add \$337 list; see page 14 for details
- on laminate units, contrasting doors fronts available, no upcharge; specify color, see page 14 for details
- locking doors available, specify and add \$284 list
- ledge pulls standard; prism pulls available, specify and see page 9

69" h Lower Hinge Doors, Open Storage Cabinet	22	36	69	216	38	FLT2236-69F80	\$2,264		
	22	36	69	216	38	FLV2236-69F80		\$4,023	\$4,424
	22	30	69	199	32	FLT2230-69F80	\$2,135		
	22	30	69	199	32	FLV2230-69F80		\$3,857	\$4,246

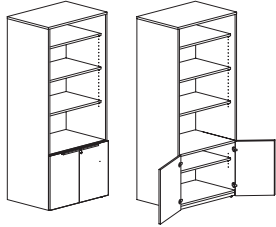

Features:

- aligns with secondary height units
- upper compartment has three adjustable shelves, lower compartment has one adjustable shelf

Options:

- must specify chassis grain direction on double cut veneer, see pages 11-13 for details
- veneer door fronts in paint available, specify paint color and add \$337 list; see page 14 for details
- on laminate units, contrasting doors fronts available, no upcharge; specify color, see page 14 for details
- locking lower doors available specify and add \$142 list
- ledge pulls standard; prism pulls available, specify and see page 9

To Order, Specify:

① Laminate Model #		② Laminate Selection		③ Metal Color	④ Other Product Options
Laminate (FLT)		See Laminate Selection		See Metal Finish Color Options	See list of options for each specific unit; Specify and add accordingly.
① Veneer Model #	② Wood Species	③ Wood Finish		④ Metal Color	⑤ Other Product Options
Veneer (FLV)	Flat Cut CH1 Cherry MA1 Maple WA1 Walnut BO1 Black Oak	See Flat Cut Wood Finish Options		See Metal Finish Color Options	See list of options for each specific unit; Specify and add accordingly.
	Double Cut DC1 Double Cut	See Double Cut Wood Finish Options	③b Chassis Grain Direction For Double Cut Only: Vertical Horizontal		

FLUX - PRIVATE OFFICE

Description	D	W	H	CTN WT	CU FT	① Model	Laminate	Flat Cut Veneer	Double Cut Veneer
81" h Box/File, Storage Cabinet	22	18	81	210	24	FLT2218-81F5DR	\$2,440		
	22	18	81	210	24	FLV2218-81F5DR		\$3,883	\$4,272
	22	18	81	210	24	FLT2218-81F5DL	\$2,440		
	22	18	81	210	24	FLV2218-81F5DL		\$3,883	\$4,272

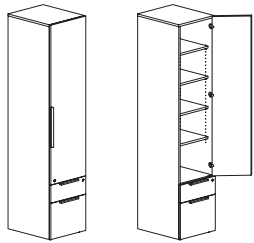

right shown

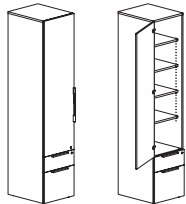

left

Features:

- aligns with secondary height units
- pedestal front locking
- upper compartment has four adjustable shelves

Options:

- must specify chassis grain direction on double cut veneer, see pages 11-13 for details
- veneer door and drawer front in paint available, specify paint color and add \$337; see page 14 for details
- on laminate units, contrasting door and drawer fronts available, no upcharge; specify color, see page 14 for details
- locking door available, specify and add \$142 list
- ledge pulls standard; prism pulls available, specify and see page 9
- vanity mirror available, specify and add \$141 list

81" h Box/File, Open Storage Cabinet	22	18	81	185	24	FLT2218-81F50	\$2,331		
	22	18	81	185	24	FLV2218-81F50		\$3,725	\$4,099

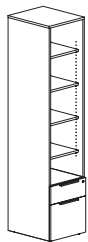

Features:

- aligns with secondary height units
- pedestal front locking
- upper compartment has four adjustable shelves

Options:

- must specify chassis grain direction on double cut veneer, see pages 11-13 for details
- veneer drawer fronts in paint available, specify paint color and add \$337 list; see page 14 for details
- on laminate units, contrasting drawer fronts available, no upcharge; specify color, see page 14 for details
- ledge pulls standard; prism pulls available, specify and see page 9

Description	D	W	H	CTN WT	CU FT	① Model	Laminate	Flat Cut Veneer	Double Cut Veneer
81" h Lower and Upper Hinge Door Storage Cabinet	22	18	81	188	24	FLT2218-81F8DR	\$1,910		
	22	18	81	188	24	FLV2218-81F8DR		\$3,319	\$3,652
	22	18	81	188	24	FLT2218-81F8DL	\$1,910		
	22	18	81	188	24	FLV2218-81F8DL		\$3,319	\$3,652

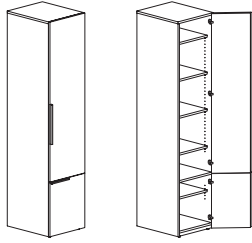

right shown

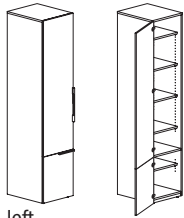

left

Features:

- aligns with secondary height units
- upper compartment has four adjustable shelves, lower compartment has one adjustable shelf

Options:

- must specify chassis grain direction on double cut veneer, see pages 11-13 for details
- veneer door fronts in paint available, specify paint color and add \$337 list; see page 14 for details
- on laminate units, contrasting doors fronts available, no upcharge; specify color, see page 14 for details
- locking doors available, specify and add \$284 list
- ledge pulls standard, mounted vertical; prism pulls available, specify and see page 9
- vanity mirror available, specify and add \$141 list

81" h Lower Hinge Door, Open Storage Cabinet	22	18	81	170	24	FLT2218-81F80R	\$1,803		
	22	18	81	170	24	FLV2218-81F80R		\$3,162	\$3,479
	22	18	81	170	24	FLT2218-81F80L	\$1,803		
	22	18	81	170	24	FLV2218-81F80L		\$3,162	\$3,479

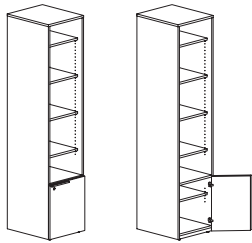

right shown

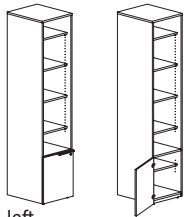

left

Features:

- aligns with secondary height units
- upper compartment has four adjustable shelves

Options:

- must specify chassis grain direction on double cut veneer, see pages 11-13 for details
- veneer door front in paint available, specify paint color and add \$337 list; see page 14 for details
- on laminate units, contrasting doors fronts available, no upcharge; specify color, see page 14 for details
- locking lower door available, specify and add \$142 list
- ledge pulls standard; prism pulls available, specify and see page 9

To Order, Specify:

① Laminate Model #		② Laminate Selection		③ Metal Color	④ Other Product Options
Laminate (FLT)		See Laminate Selection		See Metal Finish Color Options	See list of options for each specific unit; Specify and add accordingly.
① Veneer Model #	② Wood Species	③ Wood Finish		④ Metal Color	⑤ Other Product Options
Veneer (FLV)	Flat Cut CH1 Cherry MA1 Maple WA1 Walnut BO1 Black Oak	See Flat Cut Wood Finish Options		See Metal Finish Color Options	See list of options for each specific unit; Specify and add accordingly.
	Double Cut DC1 Double Cut	ⓐ Wood Finish See Double Cut Wood Finish Options	ⓑ Chassis Grain Direction For Double Cut Only: Vertical Horizontal		

Description	D	W	H	CTN WT	CU FT	① Model	Laminate	Flat Cut Veneer	Double Cut Veneer
69" h Box/File, Storage Cabinet	22	18	69	183	20	FLT2218-69F5DR	\$2,247		
	22	18	69	183	20	FLV2218-69F5DR		\$3,607	\$3,968
	22	18	69	183	20	FLT2218-69F5DL	\$2,247		
	22	18	69	183	20	FLV2218-69F5DL		\$3,607	\$3,968

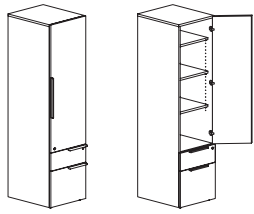

right shown

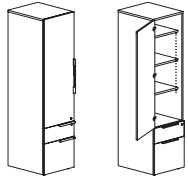

left

Features:

- aligns with secondary height units
- pedestal front locking
- upper compartment has three adjustable shelves

Options:

- must specify chassis grain direction on double cut veneer, see pages 11-13 for details
- veneer door and drawer front in paint available, specify paint color and add \$337; see page 14 for details
- on laminate units, contrasting door and drawer fronts available, no upcharge; specify color, see page 14 for details
- locking upper door available, specify and add \$142 list
- ledge pulls standard; prism pulls available, specify and see page 9
- vanity mirror available, specify and add \$141 list

69" h Box/File, Open Storage Cabinet	22	18	69	163	20	FLT2218-69F50	\$2,161		
	22	18	69	163	20	FLV2218-69F50		\$3,482	\$3,832

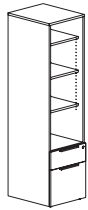

Features:

- aligns with secondary height units
- pedestal front locking
- upper compartment has three adjustable shelves

Options:

- must specify chassis grain direction on double cut veneer, see pages 11-13 for details
- veneer drawer fronts in paint available, specify paint color and add \$337 list; see page 14 for details
- on laminate units, contrasting drawer fronts available, no upcharge; specify color, see page 14 for details
- ledge pulls standard; prism pulls available, specify and see page 9

Description	D	W	H	CTN WT	CU FT	① Model	Laminate	Flat Cut Veneer	Double Cut Veneer
69" h Lower and Upper Hinge Door Storage Cabinet	22	18	69	168	20	FLT2218-69F8DR	\$1,719		
	22	18	69	168	20	FLV2218-69F8DR		\$3,046	\$3,349
	22	18	69	168	20	FLT2218-69F8DL	\$1,719		
	22	18	69	168	20	FLV2218-69F8DL		\$3,046	\$3,349

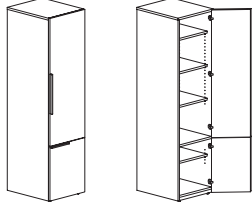

right shown

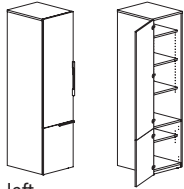

left

Features:

- aligns with secondary height units
- upper compartment has three adjustable shelves, lower compartment has one adjustable shelf

Options:

- must specify chassis grain direction on double cut veneer, see pages 11-13 for details
- veneer door fronts in paint available, specify paint color and add \$337 list; see page 14 for details
- on laminate units, contrasting doors fronts available, no upcharge; specify color, see page 14 for details
- locking doors available, specify and add \$284 list
- ledge pulls standard; prism pulls available, specify and see page 9

69" h Lower Hinge Door, Open Storage Cabinet	22	18	69	148	20	FLT2218-69F8OR	\$1,630		
	22	18	69	148	20	FLV2218-69F8OR		\$2,920	\$3,212
	22	18	69	148	20	FLT2218-69F8OL	\$1,630		
	22	18	69	148	20	FLV2218-69F8OL		\$2,920	\$3,212

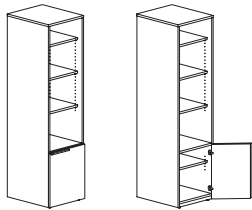

right shown

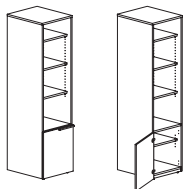

left

Features:

- aligns with secondary height units
- upper compartment has three adjustable shelves

Options:

- must specify chassis grain direction on double cut veneer, see pages 11-13 for details
- veneer door front in paint available, specify paint color and add \$337 list; see page 14 for details
- on laminate units, contrasting doors fronts available, no upcharge; specify color, see page 14 for details
- locking door available, specify and add \$142 list
- ledge pulls standard; prism pulls available, specify and see page 9

To Order, Specify:

① Laminate Model #		② Laminate Selection		③ Metal Color	④ Other Product Options
Laminate (FLT)		See Laminate Selection		See Metal Finish Color Options	See list of options for each specific unit; Specify and add accordingly.
① Veneer Model #	② Wood Species	③ Wood Finish		④ Metal Color	⑤ Other Product Options
Veneer (FLV)	Flat Cut CH1 Cherry MA1 Maple WA1 Walnut BO1 Black Oak	See Flat Cut Wood Finish Options		See Metal Finish Color Options	See list of options for each specific unit; Specify and add accordingly.
	Double Cut DC1 Double Cut	ⓐ Wood Finish See Double Cut Wood Finish Options	ⓑ Chassis Grain Direction For Double Cut Only: Vertical Horizontal		

Description	D	W	H	CTN WT	CU FT	① Model	Laminate	Flat Cut Veneer	Double Cut Veneer
81" h Wardrobe	22	18	81	161	24	FLT2218-81LDWR	\$2,517		
	22	18	81	161	24	FLV2218-81LDWR		\$3,488	\$3,834
	22	18	81	161	24	FLT2218-81LDWL	\$2,517		
	22	18	81	161	24	FLV2218-81LDWL		\$3,488	\$3,834

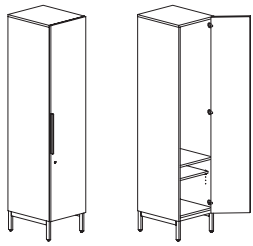

right shown



left

Features:

- lower adjustable shelf
- installed coat hooks

Options:

- must specify chassis grain direction on double cut veneer, see pages 11-13 for details
- veneer door front in paint available, specify paint color and add \$337 list; see page 14 for details
- on laminate units, contrasting doors fronts available, no upcharge; specify color, see page 14 for details
- locking door available, specify and add \$142 list
- ledge pulls standard, mounted vertical; prism pulls available, specify and see page 9
- vanity mirror available, specify and add \$141 list

81" h Storage Cabinet	22	18	81	187	24	FLT2218-81LDR	\$2,507		
	22	18	81	187	24	FLV2218-81LDR		\$3,478	\$3,827
	22	18	81	187	24	FLT2218-81LDL	\$2,507		
	22	18	81	187	24	FLV2218-81LDL		\$3,478	\$3,827

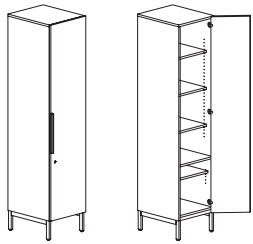

right shown

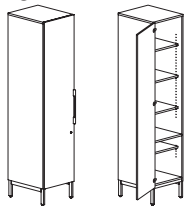

left

Features:

- five adjustable shelves

Options:

- must specify chassis grain direction on double cut veneer, see pages 11-13 for details
- veneer door fronts in paint available, specify paint color and add \$337 list; see page 14 for details
- on laminate units, contrasting doors fronts available, no upcharge; specify color, see page 14 for details
- locking door available, specify and add \$142 list
- ledge pulls standard, mounted vertical; prism pulls available, specify and see page 9
- vanity mirror available, specify and add \$141 list

Description	D	W	H	CTN WT	CU FT	① Model	Laminate	Flat Cut Veneer	Double Cut Veneer
69" h Wardrobe	22	18	69	147	20	FLT2218-69LDWR	\$2,323		
	22	18	69	147	20	FLV2218-69LDWR		\$3,211	\$3,532
	22	18	69	147	20	FLT2218-69LDWL	\$2,323		
	22	18	69	147	20	FLV2218-69LDWL		\$3,211	\$3,532

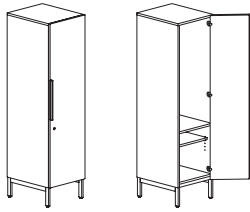

right shown

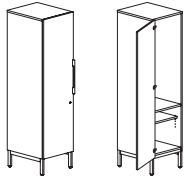

left

Features:

- lower adjustable shelf
- installed coat hooks

Options:

- must specify chassis grain direction on double cut veneer, see pages 11-13 for details
- veneer door front in paint available, specify paint color and add \$337 list; see page 14 for details
- on laminate units, contrasting doors fronts available, no upcharge; specify color, see page 14 for details
- locking door available, specify and add \$142 list
- ledge pulls standard, mounted vertical; prism pulls available, specify and see page 9
- vanity mirror available, specify and add \$141 list

69" h Storage Cabinet	22	18	69	159	20	FLT2218-69LDR	\$2,316		
	22	18	69	159	20	FLV2218-69LDR		\$3,203	\$3,524
	22	18	69	159	20	FLT2218-69LDL	\$2,316		
	22	18	69	159	20	FLV2218-69LDL		\$3,203	\$3,524

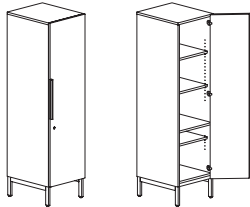

right shown

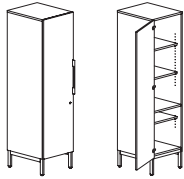

left

Features:

- four adjustable shelves

Options:

- must specify chassis grain direction on double cut veneer, see pages 11-13 for details
- veneer door front in paint available, specify paint color and add \$337 list; see page 14 for details
- on laminate units, contrasting doors fronts available, no upcharge; specify color, see page 14 for details
- locking door available, specify and add \$142 list
- ledge pulls standard, mounted vertical; prism pulls available, specify and see page 9
- vanity mirror available, specify and add \$141 list

To Order, Specify:

① Laminate Model #		② Laminate Selection		③ Metal Color		④ Other Product Options			
Laminate (FLT)		See Laminate Selection		See Metal Finish Color Options		See list of options for each specific unit; Specify and add accordingly.			
① Veneer Model #		② Wood Species		③ Wood Finish		④ Metal Color		⑤ Other Product Options	
Veneer (FLV)		Flat Cut CH1 Cherry MA1 Maple WA1 Walnut BO1 Black Oak		See Flat Cut Wood Finish Options		See Metal Finish Color Options		See list of options for each specific unit; Specify and add accordingly.	
		Double Cut DC1 Double Cut		See Double Cut Wood Finish Options		③b Chassis Grain Direction			
						For Double Cut Only: Vertical Horizontal			

Description	D	W	H	CTN WT	CU FT	① Model	Laminate	Flat Cut Veneer	Double Cut Veneer
81" h Box/File, Storage Cabinet with Side Wardrobe	22	24	81	260	30	FLT2224-81L5DWR	\$3,803		
	22	24	81	260	30	FLV2224-81L5DWR		\$5,205	\$5,725
	22	24	81	260	30	FLT2224-81L5DWL	\$3,803		
	22	24	81	260	30	FLV2224-81L5DWL		\$5,205	\$5,725

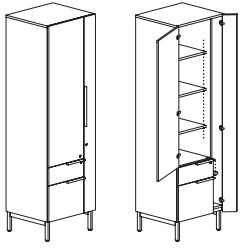

right shown



left

Features:

- aligns with primary height units
- pedestal front locking
- upper compartment has three adjustable shelves
- installed coat hook in wardrobe compartment

Options:

- must specify chassis grain direction on double cut veneer, see pages 11-13 for details
- veneer door and drawer front in paint available, specify paint color and add \$337; see page 14 for details
- on laminate units, contrasting door and drawer fronts available, no upcharge; specify color, see page 14 for details
- locking doors available, specify and add \$284 list
- ledge pulls standard; prism pulls available, specify and see page 9
- vanity mirror available, specify and add \$141 list

81" h Box/File, Open Storage Cabinet with Side Wardrobe	22	24	81	241	30	FLT2224-81L50WR	\$3,695		
	22	24	81	241	30	FLV2224-81L50WR		\$5,048	\$5,553
	22	24	81	241	30	FLT2224-81L50WL	\$3,695		
	22	24	81	241	30	FLV2224-81L50WL		\$5,048	\$5,553

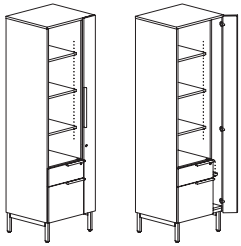

right shown

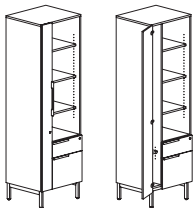

left

Features:

- aligns with primary height units
- pedestal front locking
- upper compartment has three adjustable shelves
- installed coat hook in wardrobe compartment

Options:

- must specify chassis grain direction on double cut veneer, see pages 11-13 for details
- veneer door and drawer front in paint available, specify paint color and add \$337; see page 14 for details
- on laminate units, contrasting door and drawer fronts available, no upcharge; specify color, see page 14 for details
- locking door available, specify and add \$142 list
- ledge pulls standard; prism pulls available, specify and see page 9

Description	D	W	H	CTN WT	CU FT	① Model	Laminate	Flat Cut Veneer	Double Cut Veneer
81" Lower and Upper Hinge Door Storage Cabinet with Side Wardrobe	22	24	81	253	30	FLT2224-81L8DWR	\$3,184		
	22	24	81	253	30	FLV2224-81L8DWR		\$4,517	\$4,970
	22	24	81	253	30	FLT2224-81L8DWL	\$3,184		
	22	24	81	253	30	FLV2224-81L8DWL		\$4,517	\$4,970



right shown

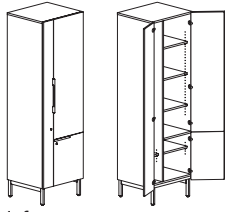

left

Features:

- aligns with primary height units
- upper compartment has three adjustable shelves, lower compartment has one adjustable shelf
- installed coat hook in wardrobe compartment

Options:

- must specify chassis grain direction on double cut veneer, see pages 11-13 for details
- veneer door fronts in paint available, specify paint color and add \$337 list; see page 14 for detail
- on laminate units, contrasting doors fronts available, no upcharge; specify color, see page 14 for details
- locking doors available, specify and add \$426 list
- ledge pulls standard; prism pulls available, specify and see page 9
- vanity mirror available, specify and add \$141 list

81" h Lower Hinge Door, Open Storage Cabinet with Side Wardrobe	22	24	81	226	30	FLT2224-81L80WR	\$3,078		
	22	24	81	226	30	FLV2224-81L80WR		\$4,360	\$4,796
	22	24	81	226	30	FLT2224-81L80WL	\$3,078		
	22	24	81	226	30	FLV2224-81L80WL		\$4,360	\$4,796

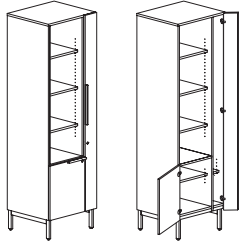

right shown

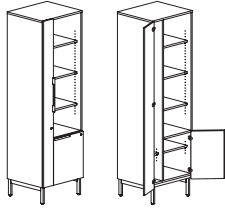

left

Features:

- aligns with primary height units
- upper compartment has two adjustable shelves, lower compartment has one adjustable shelf
- installed coat hook in wardrobe compartment

Options:

- must specify chassis grain direction on double cut veneer, see pages 11-13 for details
- veneer door fronts in paint available, specify paint color and add \$337 list; see page 14 for detail
- on laminate units, contrasting doors fronts available, no upcharge; specify color, see page 14 for details
- locking doors available, specify and add \$284 list
- ledge pulls standard; prism pulls available, specify and see page 9

To Order, Specify:

① Laminate Model #	② Laminate Type	③ Laminate Selection	④ Metal Color	⑤ Other Product Options
Laminate (FLT)	HPL	See Laminate Selection	See Metal Finish Color Options	See list of options for each specific unit; Specify and add accordingly.

① Veneer Model #	② Wood Species	③ Wood Finish - Finishes with an asterisk (*) have a coordinating laminate available	④ Metal Color	⑤ Other Product Options
Veneer (FLV)	Flat Cut CH1 Cherry MA1 Maple WA1 Walnut BO1 Black Oak	See Flat Cut Wood Finish Options	See Metal Finish Color Options	See list of options for each specific unit; Specify and add accordingly.
		③a Wood Finish See Double Cut Wood Finish Options		

Description	D	W	H	CTN WT	CU FT	① Model	Laminate	Flat Cut Veneer	Double Cut Veneer
69" h Box/File, Storage Cabinet with Side Wardrobe	22	24	69	236	26	FLT2224-69L5DWR	\$3,608		
	22	24	69	236	26	FLV2224-69L5DWR		\$4,929	\$5,423
	22	24	69	236	26	FLT2224-69L5DWL	\$3,608		
	22	24	69	236	26	FLV2224-69L5DWL		\$4,929	\$5,423

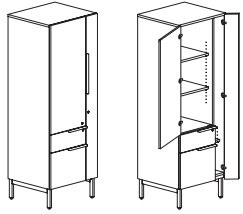

right shown

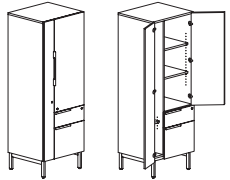

left

Features:

- aligns with primary height units
- pedestal front locking
- upper compartment has two adjustable shelves
- installed coat hook in wardrobe compartment

Options:

- must specify chassis grain direction on double cut veneer, see pages 11-13 for details
- veneer door and drawer front in paint available, specify paint color and add \$337; see page 14 for details
- on laminate units, contrasting door and drawer fronts available, no upcharge; specify color, see page 14 for details
- locking doors available, specify and add \$284 list
- ledge pulls standard; prism pulls available, specify and see page 9
- vanity mirror available, specify and add \$141 list

69" h Box/File, Open Storage Cabinet with Side Wardrobe	22	24	69	208	26	FLT2224-69L50WR	\$3,523		
	22	24	69	208	26	FLV2224-69L50WR		\$4,806	\$5,287
	22	24	69	208	26	FLT2224-69L50WL	\$3,523		
	22	24	69	208	26	FLV2224-69L50WL		\$4,806	\$5,287

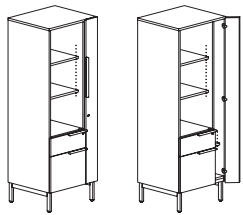

right shown

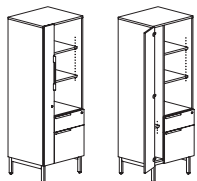

left

Features:

- aligns with primary height units
- pedestal front locking
- upper compartment has two adjustable shelves
- installed coat hook in wardrobe compartment

Options:

- must specify chassis grain direction on double cut veneer, see pages 11-13 for details
- veneer door and drawer front in paint available, specify paint color and add \$337; see page 14 for details
- on laminate units, contrasting door and drawer fronts available, no upcharge; specify color, see page 14 for details
- locking door available, specify and add \$142 list
- ledge pulls standard; prism pulls available, specify and see page 9

Description	D	W	H	CTN WT	CU FT	① Model	Laminate	Flat Cut Veneer	Double Cut Veneer
69" h Lower and Upper Hinge Door Storage Cabinet with Side Wardrobe	22	24	69	224	26	FLT2224-69L8DWR	\$2,993		
	22	24	69	224	26	FLV2224-69L8DWR		\$4,243	\$4,665
	22	24	69	224	26	FLT2224-69L8DWL	\$2,993		
	22	24	69	224	26	FLV2224-69L8DWL		\$4,243	\$4,665

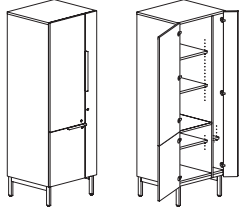

right shown

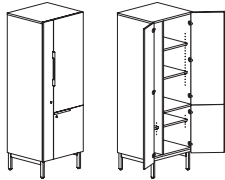

left

Features:

- aligns with primary height units
- upper compartment has two adjustable shelves, lower compartment has one adjustable shelf
- installed coat hook in wardrobe compartment

Options:

- must specify chassis grain direction on double cut veneer, see pages 11-13 for details
- veneer door fronts in paint available, specify paint color and add \$337 list; see page 14 for detail
- on laminate units, contrasting doors fronts available, no upcharge; specify color, see page 14 for details
- locking doors available, specify and add \$426 list
- ledge pulls standard; prism pulls available, specify and see page 9
- vanity mirror available, specify and add \$141 list

69" h Lower Hinge Door, Open Storage Cabinet with Side Wardrobe	22	24	69	202	26	FLT2224-69L8OWR	\$2,905		
	22	24	69	202	26	FLV2224-69L8OWR		\$4,116	\$4,528
	22	24	69	202	26	FLT2224-69L8OWL	\$2,905		
	22	24	69	202	26	FLV2224-69L8OWL		\$4,116	\$4,528

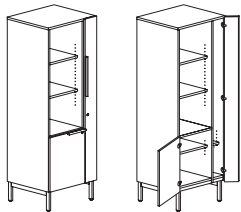

right shown

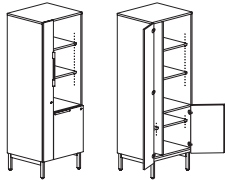

left

Features:

- aligns with primary height units
- upper compartment has two adjustable shelves, lower compartment has one adjustable shelf
- installed coat hook in wardrobe compartment

Options:

- must specify chassis grain direction on double cut veneer, see pages 11-13 for details
- veneer door fronts in paint available, specify paint color and add \$337 list; see page 14 for detail
- on laminate units, contrasting doors fronts available, no upcharge; specify color, see page 14 for details
- locking doors available, specify and add \$284 list
- ledge pulls standard; prism pulls available, specify and see page 9

To Order, Specify:

① Laminate Model #	② Laminate Selection	③ Metal Color	④ Other Product Options
Laminate (FLT)	See Laminate Selection	See Metal Finish Color Options	See list of options for each specific unit; Specify and add accordingly.

① Veneer Model #	② Wood Species	③ Wood Finish	④ Metal Color	⑤ Other Product Options
Veneer (FLV)	Flat Cut CH1 Cherry MA1 Maple WA1 Walnut BO1 Black Oak	See Flat Cut Wood Finish Options	See Metal Finish Color Options	See list of options for each specific unit; Specify and add accordingly.
		3a Wood Finish See Double Cut Wood Finish Options		

Description	D	W	H	CTN WT	CU FT	① Model	Laminate	Flat Cut Veneer	Double Cut Veneer
81" h Side Access Wardrobe with Open Shelves	15 7/8	36	81	203	32	FLT1636-81LSWR	\$2,728		
	15 7/8	36	81	203	32	FLV1636-81LSWR		\$4,172	\$4,589
	15 7/8	36	81	203	32	FLT1636-81LSWL	\$2,728		
	15 7/8	36	81	203	32	FLV1636-81LSWL		\$4,172	\$4,589
	15 7/8	30	81	178	27	FLT1630-81LSWR	\$2,541		
	15 7/8	30	81	178	27	FLV1630-81LSWR		\$3,861	\$4,248
	15 7/8	30	81	178	27	FLT1630-81LSWL	\$2,541		
	15 7/8	30	81	178	27	FLV1630-81LSWL		\$3,861	\$4,248

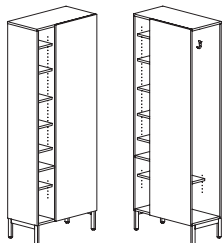

right shown

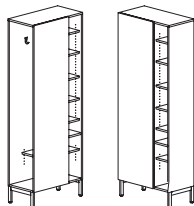

left

Features:

- side entry wardrobe with two installed coat hooks and one lower adjustable shelf
- 8 1/4" w open compartment with five adjustable shelves

Options:

- must specify chassis grain direction on double cut veneer, see pages 11-13 for details

Description	D	W	H	CTN WT	CU FT	① Model	Laminate	Flat Cut Veneer	Double Cut Veneer
69" h Side Access Wardrobe with Open Shelves	15 7/8	36	69	172	27	FLT1636-69LSWR	\$2,537		
	15 7/8	36	69	172	27	FLV1636-69LSWR		\$3,895	\$4,287
	15 7/8	36	69	172	27	FLT1636-69LSWL	\$2,537		
	15 7/8	36	69	172	27	FLV1636-69LSWL		\$3,895	\$4,287
	15 7/8	30	69	147	23	FLT1630-69LSWR	\$2,365		
	15 7/8	30	69	147	23	FLV1630-69LSWR		\$3,602	\$3,963
	15 7/8	30	69	147	23	FLT1630-69LSWL	\$2,365		
	15 7/8	30	69	147	23	FLV1630-69LSWL		\$3,602	\$3,963

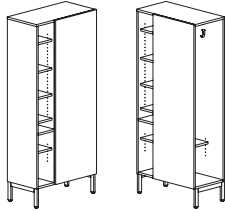

right shown

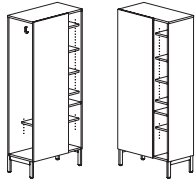

left

Features:

- side entry wardrobe with two installed coat hooks and one lower adjustable shelf
- 8 1/4" w open compartment with four adjustable shelves

Options:

- must specify chassis grain direction on double cut veneer, see pages 11-13 for details

To Order, Specify:

① Laminate Model #		② Laminate Selection		③ Metal Color	④ Other Product Options
Laminate (FLT)		See Laminate Selection		See Metal Finish Color Options	See list of options for each specific unit; Specify and add accordingly.
① Veneer Model #	② Wood Species	③ Wood Finish		④ Metal Color	⑤ Other Product Options
Veneer (FLV)	Flat Cut CH1 Cherry MA1 Maple WA1 Walnut BO1 Black Oak	See Flat Cut Wood Finish Options		See Metal Finish Color Options	See list of options for each specific unit; Specify and add accordingly.
	Double Cut DC1 Double Cut	See Double Cut Wood Finish Options	③b Chassis Grain Direction For Double Cut Only: Vertical Horizontal		

Description	D	W	H	CTN WT	CU FT	① Model	Laminate	Flat Cut Veneer	Double Cut Veneer
81" h Box/File Lateral, Storage Cabinet	22	36	81	305	44	FLT2236-81L6D	\$3,987		
	22	36	81	305	44	FLV2236-81L6D		\$5,509	\$6,059
	22	30	81	284	37	FLT2230-81L6D	\$3,806		
	22	30	81	284	37	FLV2230-81L6D		\$5,272	\$5,799

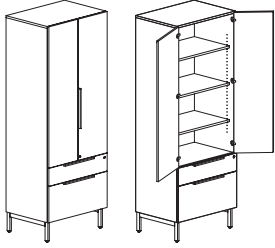

Features:

- aligns with primary height units
- pedestal front locking
- upper compartment has three adjustable shelves

Options:

- must specify chassis grain direction on double cut veneer, see pages 11-13 for details
- veneer door and drawer front in paint available, specify paint color and add \$337; see page 14 for details
- on laminate units, contrasting door and drawer fronts available, no upcharge; specify color, see page 14 for details
- locking door available, specify and add \$142 list
- ledge pulls standard; prism pulls available, specify and see page 9

81" h Box/File Lateral, Open Storage Cabinet	22	36	81	270	44	FLT2236-81L60	\$3,788		
	22	36	81	270	44	FLV2236-81L60		\$5,247	\$5,774
	22	30	81	247	37	FLT2230-81L60	\$3,622		
	22	30	81	247	37	FLV2230-81L60		\$5,027	\$5,530

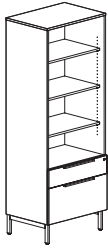

Features:

- aligns with primary height units
- pedestal front locking
- upper compartment has three adjustable shelves

Options:

- must specify chassis grain direction on double cut veneer, see pages 11-13 for details
- veneer drawer fronts in paint available, specify paint color and add \$337 list; see page 14 for details
- on laminate units, contrasting drawer fronts available, no upcharge; specify color, see page 14 for details
- ledge pulls standard; prism pulls available, specify and see page 9

FLUX - PRIVATE OFFICE

Description	D	W	H	CTN WT	CU FT	① Model	Laminate	Flat Cut Veneer	Double Cut Veneer
81" h Lower and Upper Hinge Door Storage Cabinet	22	36	81	265	44	FLT2236-81L8D	\$3,423		
	22	36	81	265	44	FLV2236-81L8D		\$4,909	\$5,401
	22	30	81	248	37	FLT2230-81L8D	\$3,256		
	22	30	81	248	37	FLV2230-81L8D		\$4,695	\$5,163

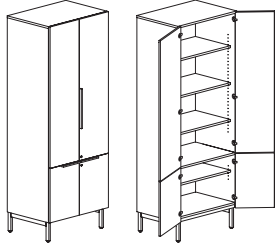

Features:

- aligns with primary height units
- upper compartment has three adjustable shelves, lower compartment has one adjustable shelf

Options:

- must specify chassis grain direction on double cut veneer, see pages 11-13 for details
- veneer door fronts in paint available, specify paint color and add \$337 list; see page 14 for details
- on laminate units, contrasting doors fronts available, no upcharge; specify color, see page 14 for details
- locking doors available, specify and add \$284 list
- ledge pulls standard; prism pulls available, specify and see page 9

81" h Lower Hinge Doors, Open Storage Cabinet	22	36	81	241	44	FLT2236-81L80	\$3,224		
	22	36	81	241	44	FLV2236-81L80		\$4,648	\$5,112
	22	30	81	224	37	FLT2230-81L80	\$3,070		
	22	30	81	224	37	FLV2230-81L80		\$4,448	\$4,896

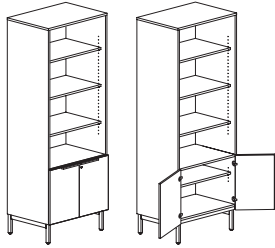

Features:

- aligns with primary height units
- upper compartment has three adjustable shelves, lower compartment has one adjustable shelf

Options:

- must specify chassis grain direction on double cut veneer, see pages 11-13 for details
- veneer door fronts in paint available, specify paint color and add \$337 list; see page 14 for details
- on laminate units, contrasting doors fronts available, no upcharge; specify color, see page 14 for details
- locking door available, specify and add \$142 list
- ledge pulls standard; prism pulls available, specify and see page 9

FLUX - PRIVATE OFFICE

To Order, Specify:

① Laminate Model #		② Laminate Selection		③ Metal Color	④ Other Product Options
Laminate (FLT)		See Laminate Selection		See Metal Finish Color Options	See list of options for each specific unit; Specify and add accordingly.
① Veneer Model #	② Wood Species	③ Wood Finish		④ Metal Color	⑤ Other Product Options
Veneer (FLV)	Flat Cut CH1 Cherry MA1 Maple WA1 Walnut BO1 Black Oak	See Flat Cut Wood Finish Options		See Metal Finish Color Options	See list of options for each specific unit; Specify and add accordingly.
	Double Cut DC1 Double Cut	See Double Cut Wood Finish Options	③b Chassis Grain Direction For Double Cut Only: Vertical Horizontal		

Description	D	W	H	CTN WT	CU FT	① Model	Laminate	Flat Cut Veneer	Double Cut Veneer
69" h Box/ File Lateral, Storage Cabinet	22	36	69	261	38	FLT2236-69L6D	\$3,692		
	22	36	69	261	38	FLV2236-69L6D		\$5,084	\$5,594
	22	30	69	239	32	FLT2230-69L6D	\$3,536		
	22	30	69	239	32	FLV2230-69L6D		\$4,886	\$5,375

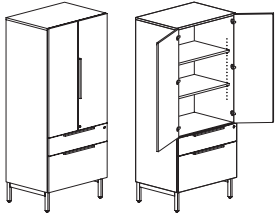

Features:

- aligns with primary height units
- pedestal front locking
- upper compartment has two adjustable shelves

Options:

- must specify chassis grain direction on double cut veneer, see pages 11-13 for details
- veneer door and drawer front in paint available, specify paint color and add \$337; see page 14 for details
- on laminate units, contrasting door and drawer fronts available, no upcharge; specify color, see page 14 for details
- locking door available, specify and add \$142 list
- ledge pulls standard; prism pulls available, specify and see page 9

69" h Box/ File Lateral, Open Storage Cabinet	22	36	69	241	38	FLT2236-69L60	\$3,526		
	22	36	69	241	38	FLV2236-69L60		\$4,874	\$5,361
	22	30	69	219	32	FLT2230-69L60	\$3,382		
	22	30	69	219	32	FLV2230-69L60		\$4,686	\$5,156

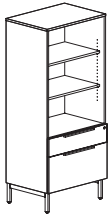

Features:

- aligns with primary height units
- pedestal front locking
- upper compartment has two adjustable shelves

Options:

- must specify chassis grain direction on double cut veneer, see pages 11-13 for details
- veneer drawer fronts in paint available, specify paint color and add \$337 list; see page 14 for details
- on laminate units, contrasting drawer fronts available, no upcharge; specify color, see page 14 for details
- ledge pulls standard; prism pulls available, specify and see page 9

Description	D	W	H	CTN WT	CU FT	① Model	Laminate	Flat Cut Veneer	Double Cut Veneer
69" h Lower and Upper Hinge Door Storage Cabinet	22	36	69	240	37	FLT2236-69L8D	\$3,128		
	22	36	69	240	37	FLV2236-69L8D		\$4,484	\$4,932
	22	30	69	223	32	FLT2230-69L8D	\$2,986		
	22	30	69	223	32	FLV2230-69L8D		\$4,311	\$4,740

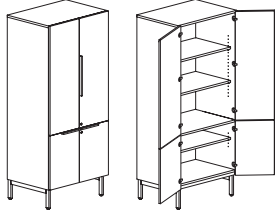

Features:

- aligns with primary height units
- upper compartment has two adjustable shelves, lower compartment has one adjustable shelf

Options:

- must specify chassis grain direction on double cut veneer, see pages 11-13 for details
- veneer door fronts in paint available, specify paint color and add \$337 list; see page 14 for details
- on laminate units, contrasting doors fronts available, no upcharge; specify color, see page 14 for details
- locking doors available, specify and add \$284 list
- ledge pulls standard; prism pulls available, specify and see page 9

69" h Lower Hinge Doors, Open Storage Cabinet	22	36	69	221	38	FLT2236-69L80	\$2,964		
	22	36	69	221	38	FLV2236-69L80		\$4,275	\$4,701
	22	30	69	204	32	FLT2230-69L80	\$2,832		
	22	30	69	204	32	FLV2230-69L80		\$4,110	\$4,522

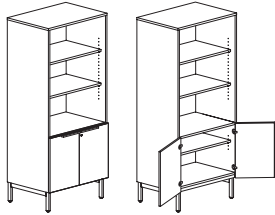

Features:

- aligns with primary height units
- upper compartment has two adjustable shelves, lower compartment has one adjustable shelf

Options:

- must specify chassis grain direction on double cut veneer, see pages 11-13 for details
- veneer door fronts in paint available, specify paint color and add \$337 list; see page 14 for details
- on laminate units, contrasting doors fronts available, no upcharge; specify color, see page 14 for details
- locking door available, specify and add \$142 list
- ledge pulls standard; prism pulls available, specify and see page 9

To Order, Specify:

① Laminate Model #		② Laminate Selection		③ Metal Color	④ Other Product Options
Laminate (FLT)		See Laminate Selection		See Metal Finish Color Options	See list of options for each specific unit; Specify and add accordingly.
① Veneer Model #	② Wood Species	③ Wood Finish		④ Metal Color	⑤ Other Product Options
Veneer (FLV)	Flat Cut CH1 Cherry MA1 Maple WA1 Walnut BO1 Black Oak	See Flat Cut Wood Finish Options		See Metal Finish Color Options	See list of options for each specific unit; Specify and add accordingly.
	Double Cut DC1 Double Cut	See Double Cut Wood Finish Options	③b Chassis Grain Direction For Double Cut Only: Vertical Horizontal		

Description	D	W	H	CTN WT	CU FT	① Model	Laminate	Flat Cut Veneer	Double Cut Veneer
81" h Box/File, Storage Cabinet	22	18	81	209	24	FLT2218-81L5DR	\$3,121		
	22	18	81	209	24	FLV2218-81L5DR		\$4,113	\$4,525
	22	18	81	209	24	FLT2218-81L5DL	\$3,121		
	22	18	81	209	24	FLV2218-81L5DL		\$4,113	\$4,525

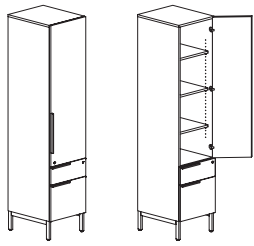

right shown

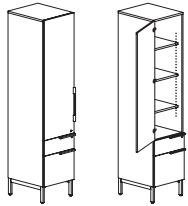

left

Features:

- aligns with primary height units
- pedestal front locking
- upper compartment has three adjustable shelves

Options:

- must specify chassis grain direction on double cut veneer, see pages 11-13 for details
- veneer door and drawer front in paint available, specify paint color and add \$337; see page 14 for details
- on laminate units, contrasting door and drawer fronts available, no upcharge; specify color, see page 14 for details
- locking door available, specify and add \$142 list
- ledge pulls standard; prism pulls available, specify and see page 9
- vanity mirror available, specify and add \$141 list

81" h Box/File, Open Storage Cabinet	22	18	81	182	24	FLT2218-81L50	\$3,012		
	22	18	81	182	24	FLV2218-81L50		\$3,957	\$4,353

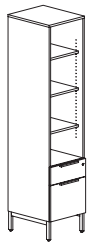

Features:

- aligns with primary height units
- pedestal front locking
- upper compartment has three adjustable shelves

Options:

- must specify chassis grain direction on double cut veneer, see pages 11-13 for details
- veneer drawer fronts in paint available, specify paint color and add \$337 list; see page 14 for details
- on laminate units, contrasting drawer fronts available, no upcharge; specify color, see page 14 for details
- ledge pulls standard; prism pulls available, specify and see page 9

Description	D	W	H	CTN WT	CU FT	① Model	Laminate	Flat Cut Veneer	Double Cut Veneer
81" h Lower and Upper Hinge Door Storage Cabinet	22	18	81	187	24	FLT2218-81L8DR	\$2,590		
	22	18	81	187	24	FLV2218-81L8DR		\$3,550	\$3,904
	22	18	81	187	24	FLT2218-81L8DL	\$2,590		
	22	18	81	187	24	FLV2218-81L8DL		\$3,550	\$3,904

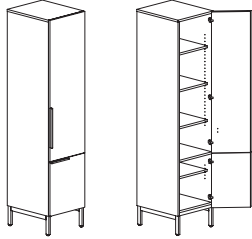

right shown

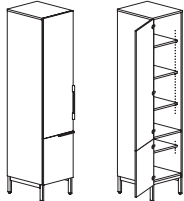

left

Features:

- aligns with primary height units
- upper compartment has two adjustable shelves, lower compartment has one adjustable shelf

Options:

- must specify chassis grain direction on double cut veneer, see pages 11-13 for details
- veneer door fronts in paint available, specify paint color and add \$337 list; see page 14 for details
- on laminate units, contrasting doors fronts available, no upcharge; specify color, see page 14 for details
- locking doors available, specify and add \$284 list
- ledge pulls standard; prism pulls available, specify and see page 9
- vanity mirror available, specify and add \$141 list

81" h Lower Hinge Door, Open Storage Cabinet	22	18	81	165	24	FLT2218-81L8OR	\$2,482		
	22	18	81	165	24	FLV2218-81L8OR		\$3,392	\$3,731
	22	18	81	165	24	FLT2218-81L8OL	\$2,482		
	22	18	81	165	24	FLV2218-81L8OL		\$3,392	\$3,731

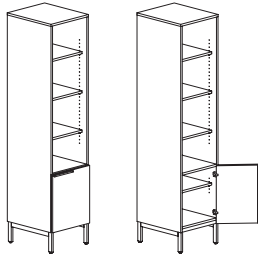

right shown

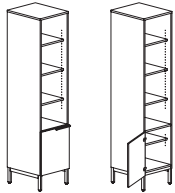

left

Features:

- aligns with primary height units
- upper compartment has three adjustable shelves, lower compartment has one adjustable shelf

Options:

- must specify chassis grain direction on double cut veneer, see pages 11-13 for details
- veneer door front in paint available, specify paint color and add \$337 list; see page 14 for details
- on laminate units, contrasting doors fronts available, no upcharge; specify color, see page 14 for details
- locking door available, specify and add \$142 list
- ledge pulls standard; prism pulls available, specify and see page 9

To Order, Specify:

① Laminate Model #		② Laminate Selection		③ Metal Color	④ Other Product Options
Laminate (FLT)		See Laminate Selection		See Metal Finish Color Options	See list of options for each specific unit; Specify and add accordingly.
① Veneer Model #	② Wood Species	③ Wood Finish		④ Metal Color	⑤ Other Product Options
Veneer (FLV)	Flat Cut CH1 Cherry MA1 Maple WA1 Walnut BO1 Black Oak	See Flat Cut Wood Finish Options		See Metal Finish Color Options	See list of options for each specific unit; Specify and add accordingly.
	Double Cut DC1 Double Cut	ⓐ Wood Finish See Double Cut Wood Finish Options	ⓑ Chassis Grain Direction For Double Cut Only: Vertical Horizontal		

Description	D	W	H	CTN WT	CU FT	① Model	Laminate	Flat Cut Veneer	Double Cut Veneer
69" h Box/File, Storage Cabinet	22	18	69	181	20	FLT2218-69L5DR	\$2,930		
	22	18	69	181	20	FLV2218-69L5DR		\$3,839	\$4,222
	22	18	69	181	20	FLT2218-69L5DL	\$2,930		
	22	18	69	181	20	FLV2218-69L5DL		\$3,839	\$4,222

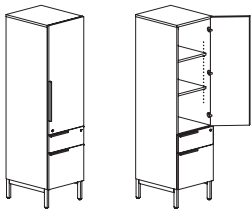

right shown

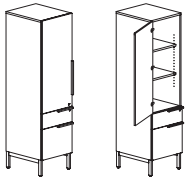

left

Features:

- aligns with primary height units
- pedestal front locking
- upper compartment has two adjustable shelves

Options:

- must specify chassis grain direction on double cut veneer, see pages 11-13 for details
- veneer door and drawer front in paint available, specify paint color and add \$337; see page 14 for details
- on laminate units, contrasting door and drawer fronts available, no upcharge; specify color, see page 14 for details
- locking door available, specify and add \$142 list
- ledge pulls standard; prism pulls available, specify and see page 9
- vanity mirror available, specify and add \$141 list

69" h Box/File, Open Storage Cabinet	22	18	69	160	20	FLT2218-69L50	\$2,841		
	22	18	69	160	20	FLV2218-69L50		\$3,715	\$4,087

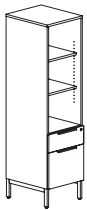

Features:

- aligns with primary height units
- pedestal front locking
- upper compartment has two adjustable shelves

Options:

- must specify chassis grain direction on double cut veneer, see pages 11-13 for details
- veneer drawer fronts in paint available, specify paint color and add \$337 list; see page 14 for details
- on laminate units, contrasting drawer fronts available, no upcharge; specify color, see page 14 for details
- ledge pulls standard; prism pulls available, specify and see page 9

Description	D	W	H	CTN WT	CU FT	① Model	Laminate	Flat Cut Veneer	Double Cut Veneer
69" Lower and Upper Hinge Door Storage Cabinet	22	18	69	161	20	FLT2218-69L8DR	\$2,397		
	22	18	69	161	20	FLV2218-69L8DR		\$3,274	\$3,602
	22	18	69	161	20	FLT2218-69L8DL	\$2,397		
	22	18	69	161	20	FLV2218-69L8DL		\$3,274	\$3,602

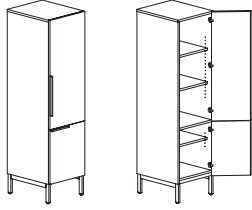

right shown

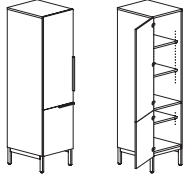

left

Features:

- aligns with primary height units
- upper compartment has two adjustable shelves, lower compartment has one adjustable shelf

Options:

- must specify chassis grain direction on double cut veneer, see pages 11-13 for details
- veneer door fronts in paint available, specify paint color and add \$337 list; see page 14 for details
- on laminate units, contrasting doors fronts available, no upcharge; specify color, see page 14 for details
- locking doors available, specify and add \$284 list
- ledge pulls standard; prism pulls available, specify and see page 9
- vanity mirror available, specify and add \$141 list

69" Lower Hinge Door, Open Storage Cabinet	22	18	69	144	20	FLT2218-69L8OR	\$2,311		
	22	18	69	144	20	FLV2218-69L8OR		\$3,150	\$3,464
	22	18	69	144	20	FLT2218-69L8OL	\$2,311		
	22	18	69	144	20	FLV2218-69L8OL		\$3,150	\$3,464

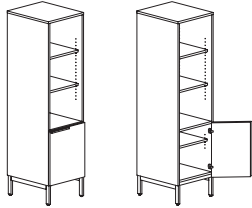

right shown

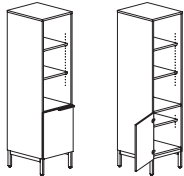

left

Features:

- aligns with primary height units
- upper compartment has two adjustable shelves, lower compartment has one adjustable shelf

Options:

- must specify chassis grain direction on double cut veneer, see pages 11-13 for details
- veneer door front in paint available, specify paint color and add \$337 list; see page 14 for details
- on laminate units, contrasting doors fronts available, no upcharge; specify color, see page 14 for details
- locking door available, specify and add \$142 list
- ledge pulls standard; prism pulls available, specify and see page 9

To Order, Specify:

① Laminate Model #		② Laminate Selection		③ Metal Color	④ Other Product Options
Laminate (FLT)		See Laminate Selection		See Metal Finish Color Options	See list of options for each specific unit; Specify and add accordingly.
① Veneer Model #	② Wood Species	③ Wood Finish		④ Metal Color	⑤ Other Product Options
Veneer (FLV)	Flat Cut CH1 Cherry MA1 Maple WA1 Walnut BO1 Black Oak	See Flat Cut Wood Finish Options		See Metal Finish Color Options	See list of options for each specific unit; Specify and add accordingly.
	Double Cut DC1 Double Cut	See Double Cut Wood Finish Options	③b Chassis Grain Direction For Double Cut Only: Vertical Horizontal		

Description	D	W	H	CTN WT	CU FT	① Model	Laminate	Flat Cut Veneer	Double Cut Veneer
81" h File Drawer, Storage Cabinet with Side Wardrobe	22	24	81	260	30	FLT2224-81SL5DWR	\$3,702		
	22	24	81	260	30	FLV2224-81SL5DWR		\$5,106	\$5,616
	22	24	81	260	30	FLT2224-81SL5DWL	\$3,702		
	22	24	81	260	30	FLV2224-81SL5DWL		\$5,106	\$5,616

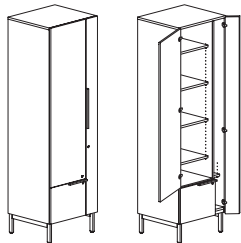

right shown

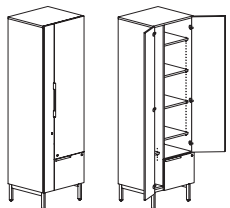

left

Features:

- aligns with secondary height units
- pedestal front locking
- upper compartment has four adjustable shelves
- installed coat hook in wardrobe compartment

Options:

- must specify chassis grain direction on double cut veneer, see pages 11-13 for details
- veneer door and drawer front in paint available, specify paint color and add \$337; see page 14 for details
- on laminate units, contrasting door and drawer fronts available, no upcharge; specify color, see page 14 for details
- locking doors available, specify and add \$284 list
- ledge pulls standard; prism pulls available, specify and see page 9
- vanity mirror available, specify and add \$141 list

81" h File Drawer, Open Storage Cabinet with Side Wardrobe	22	24	81	230	30	FLT2224-81SL50WR	\$3,594		
	22	24	81	230	30	FLV2224-81SL50WR		\$4,950	\$5,445
	22	24	81	230	30	FLT2224-81SL50WL	\$3,594		
	22	24	81	230	30	FLV2224-81SL50WL		\$4,950	\$5,445



right shown

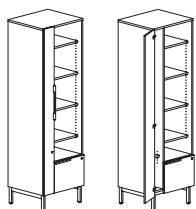

left

Features:

- aligns with secondary height units
- pedestal front locking
- upper compartment has four adjustable shelves
- installed coat hook in wardrobe compartment

Options:

- must specify chassis grain direction on double cut veneer, see pages 11-13 for details
- veneer door and drawer front in paint available, specify paint color and add \$337; see page 14 for details
- on laminate units, contrasting door and drawer fronts available, no upcharge; specify color, see page 14 for details
- locking door available, specify and add \$142 list
- ledge pulls standard; prism pulls available, specify and see page 9

Description	D	W	H	CTN WT	CU FT	① Model	Laminate	Flat Cut Veneer	Double Cut Veneer
81" h Upper and Lower Hinge Door Storage Cabinet with Side Wardrobe	22	24	81	249	30	FLT2224-81SL8DWR	\$3,184		
	22	24	81	246	30	FLV2224-81SL8DWR		\$4,517	\$4,970
	22	24	81	246	30	FLT2224-81SL8DWL	\$3,184		
	22	24	81	246	30	FLV2224-81SL8DWL		\$4,517	\$4,970

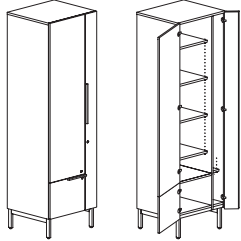

right shown

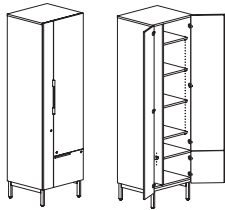

left

Features:

- aligns with secondary height units
- upper compartment has four adjustable shelves
- installed coat hook in wardrobe compartment

Options:

- must specify chassis grain direction on double cut veneer, see pages 11-13 for details
- veneer door fronts in paint available, specify paint color and add \$337 list; see page 14 for details
- on laminate units, contrasting doors fronts available, no upcharge; specify color, see page 14 for details
- locking doors available, specify and add \$284 list
- ledge pulls standard; prism pulls available, specify and see page 9
- vanity mirror available, specify and add \$141 list

81" h Lower Hinge Door, Open Storage Cabinet with Side Wardrobe	22	24	81	217	30	FLT2224-81SL80WR	\$3,078		
	22	24	81	217	30	FLV2224-81SL80WR		\$4,360	\$4,796
	22	24	81	217	30	FLT2224-81SL80WL	\$3,078		
	22	24	81	217	30	FLV2224-81SL80WL		\$4,360	\$4,796

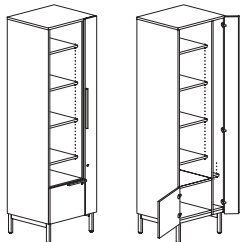

right shown

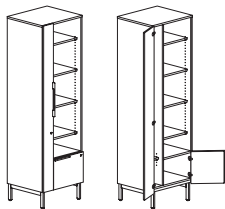

left

Features:

- aligns with secondary height units
- upper compartment has four adjustable shelves
- installed coat hook in wardrobe compartment

Options:

- must specify chassis grain direction on double cut veneer, see pages 11-13 for details
- veneer door fronts in paint available, specify paint color and add \$337 list; see page 14 for detail
- on laminate units, contrasting doors fronts available, no upcharge; specify color, see page 14 for details
- locking doors available, specify and add \$284 list
- ledge pulls standard; prism pulls available, specify and see page 9

To Order, Specify:

① Laminate Model #	② Laminate Type	③ Laminate Selection	④ Metal Color	⑤ Other Product Options
Laminate (FLT)	HPL	See Laminate Selection	See Metal Finish Color Options	See list of options for each specific unit; Specify and add accordingly.

① Veneer Model #	② Wood Species	③ Wood Finish - Finishes with an asterisk (*) have a coordinating laminate available	④ Metal Color	⑤ Other Product Options		
Veneer (FLV)	Flat Cut CH1 Cherry MA1 Maple WA1 Walnut BO1 Black Oak	See Flat Cut Wood Finish Options	See Metal Finish Color Options	See list of options for each specific unit; Specify and add accordingly.		
	Double Cut DC1 Double Cut	<table border="1"> <thead> <tr> <th>ⓐ Wood Finish</th> <th>ⓑ Chassis Grain Direction</th> </tr> </thead> <tbody> <tr> <td>See Double Cut Wood Finish Options</td> <td>For Double Cut Only: Vertical Horizontal</td> </tr> </tbody> </table>	ⓐ Wood Finish		ⓑ Chassis Grain Direction	See Double Cut Wood Finish Options
ⓐ Wood Finish	ⓑ Chassis Grain Direction					
See Double Cut Wood Finish Options	For Double Cut Only: Vertical Horizontal					

Description	D	W	H	CTN WT	CU FT	① Model	Laminate	Flat Cut Veneer	Double Cut Veneer
69" h File Drawer, Upper Hinge	22	24	69	229	26	FLT2224-69SL5DWR	\$3,510		
Door Storage Cabinet with Side Wardrobe	22	24	69	229	26	FLV2224-69SL5DWR		\$4,832	\$5,314
	22	24	69	229	26	FLT2224-69SL5DWL	\$3,510		
	22	24	69	229	26	FLV2224-69SL5DWL		\$4,832	\$5,314

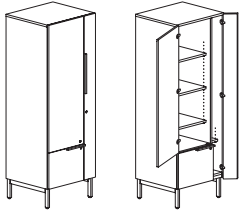

right shown

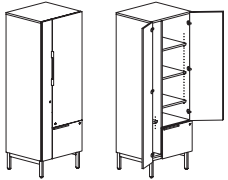

left

Features:

- aligns with secondary height units
- pedestal front locking
- upper compartment has three adjustable shelves
- installed coat hook in wardrobe compartment

Options:

- must specify chassis grain direction on double cut veneer, see pages 11-13 for details
- veneer door and drawer front in paint available, specify paint color and add \$337; see page 14 for details
- on laminate units, contrasting door and drawer fronts available, no upcharge; specify color, see page 14 for details
- locking doors available, specify and add \$284 list
- ledge pulls standard; prism pulls available, specify and see page 9
- vanity mirror available, specify and add \$141 list

69" h File Drawer, Open Storage Cabinet with Side Wardrobe	22	24	69	204	26	FLT2224-69SL50WR	\$3,423		
	22	24	69	204	26	FLV2224-69SL50WR		\$4,706	\$5,178
	22	24	69	204	26	FLT2224-69SL50WL	\$3,423		
	22	24	69	204	26	FLV2224-69SL50WL		\$4,706	\$5,178

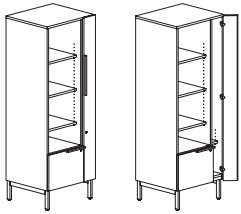

right shown

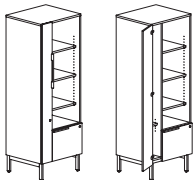

left

Features:

- aligns with secondary height units
- pedestal front locking
- upper compartment has three adjustable shelves
- installed coat hook in wardrobe compartment

Options:

- must specify chassis grain direction on double cut veneer, see pages 11-13 for details
- veneer door and drawer front in paint available, specify paint color and add \$337; see page 14 for details
- on laminate units, contrasting door and drawer fronts available, no upcharge; specify color, see page 14 for details
- locking door available, specify and add \$142 list
- ledge pulls standard; prism pulls available, specify and see page 9

Description	D	W	H	CTN WT	CU FT	① Model	Laminate	Flat Cut Veneer	Double Cut Veneer
69" h Lower and Upper Hinge Door Storage Cabinet with Side Wardrobe	22	24	69	215	26	FLT2224-69SL8DWR	\$2,993		
	22	24	69	215	26	FLV2224-69SL8DWR		\$4,243	\$4,665
	22	24	69	215	26	FLT2224-69SL8DWL	\$2,993		
	22	24	69	215	26	FLV2224-69SL8DWL		\$4,243	\$4,665

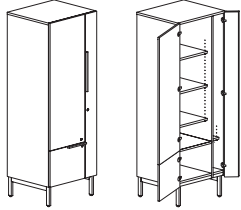

right shown

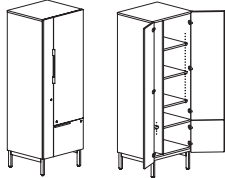

left

Features:

- aligns with secondary height units
- upper compartment has three adjustable shelves
- installed coat hook in wardrobe compartment

Options:

- must specify chassis grain direction on double cut veneer, see pages 11-13 for details
- veneer door fronts in paint available, specify paint color and add \$337 list; see page 14 for detail
- on laminate units, contrasting doors fronts available, no upcharge; specify color, see page 14 for details
- locking doors available, specify and add \$426 list
- ledge pulls standard; prism pulls available, specify and see page 9
- vanity mirror available, specify and add \$141 list

69" h Lower Hinge Door, Open Storage Cabinet with Side Wardrobe	22	24	69	191	26	FLT2224-69SL80WR	\$2,905		
	22	24	69	191	26	FLV2224-69SL80WR		\$4,116	\$4,528
	22	24	69	191	26	FLT2224-69SL80WL	\$2,905		
	22	24	69	191	26	FLV2224-69SL80WL		\$4,116	\$4,528

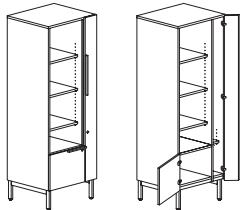

right shown

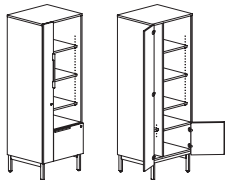

left

Features:

- aligns with secondary height units
- upper compartment has three adjustable shelves
- installed coat hook in wardrobe compartment

Options:

- must specify chassis grain direction on double cut veneer, see pages 11-13 for details
- veneer door fronts in paint available, specify paint color and add \$337 list; see page 14 for detail
- on laminate units, contrasting doors fronts available, no upcharge; specify color, see page 14 for details
- locking doors available, specify and add \$284 list
- ledge pulls standard; prism pulls available, specify and see page 9

To Order, Specify:

① Laminate Model #	② Laminate Selection		③ Metal Color	④ Other Product Options	
Laminate (FLT)	See Laminate Selection		See Metal Finish Color Options	See list of options for each specific unit; Specify and add accordingly.	
① Veneer Model #	② Wood Species	③ Wood Finish		④ Metal Color	⑤ Other Product Options
Veneer (FLV)	Flat Cut CH1 Cherry MA1 Maple WA1 Walnut BO1 Black Oak	See Flat Cut Wood Finish Options		See Metal Finish Color Options	See list of options for each specific unit; Specify and add accordingly.
	Double Cut DC1 Double Cut	See Double Cut Wood Finish Options	③b Chassis Grain Direction For Double Cut Only: Vertical Horizontal		

Description	D	W	H	CTN WT	CU FT	① Model	Laminate	Flat Cut Veneer	Double Cut Veneer
81" h File Drawer, Storage Cabinet	22	36	81	259	44	FLT2236-81SL6D	\$3,874		
	22	36	81	259	44	FLV2236-81SL6D		\$5,394	\$5,933
	22	30	81	237	37	FLT2230-81SL6D	\$3,692		
	22	30	81	237	37	FLV2230-81SL6D		\$5,157	\$5,673

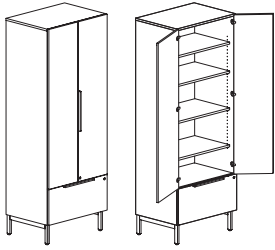

Features:

- aligns with secondary height units
- pedestal front locking
- upper compartment has four adjustable shelves

Options:

- must specify chassis grain direction on double cut veneer, see pages 11-13 for details
- veneer door and drawer front in paint available, specify paint color and add \$337; see page 14 for details
- on laminate units, contrasting door and drawer fronts available, no upcharge; specify color, see page 14 for details
- locking door available, specify and add \$142 list
- ledge pulls standard, mounted vertical; prism pulls available, specify and see page 9

81" h Lateral File Drawer, Open Storage Cabinet	22	36	81	239	44	FLT2236-81SL60	\$3,674		
	22	36	81	239	44	FLV2236-81SL60		\$5,133	\$5,645
	22	30	81	217	37	FLT2230-81SL60	\$3,505		
	22	30	81	217	37	FLV2230-81SL60		\$4,912	\$5,403

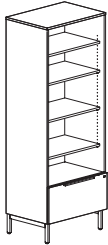

Features:

- aligns with secondary height units
- pedestal front locking
- upper compartment has four adjustable shelves

Options:

- must specify chassis grain direction on double cut veneer, see pages 11-13 for details
- veneer drawer fronts in paint available, specify paint color and add \$337 list; see page 14 for details
- on laminate units, contrasting door front available, no upcharge; specify color, see page 14 for details
- ledge pulls standard; prism pulls available, specify and see page 9

Description	D	W	H	CTN WT	CU FT	① Model	Laminate	Flat Cut Veneer	Double Cut Veneer
81" Lower and Upper Hinge Door Storage Cabinet	22	36	81	240	44	FLT2236-81SL8D	\$3,308		
	22	36	81	240	44	FLV2236-81SL8D		\$4,793	\$5,273
	22	30	81	223	37	FLT2230-81SL8D	\$3,139		
	22	30	81	223	37	FLV2230-81SL8D		\$4,579	\$5,036

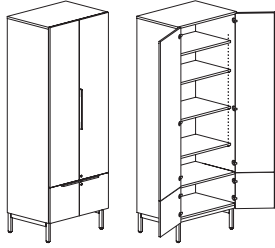

Features:

- aligns with secondary height units
- upper compartment has four adjustable shelves

Options:

- must specify chassis grain direction on double cut veneer, see pages 11-13 for details
- veneer door fronts in paint available, specify paint color and add \$337 list; see page 14 for details
- on laminate units, contrasting doors fronts available, no upcharge; specify color, see page 14 for details
- locking doors available, specify and add \$284 list
- ledge pulls standard; prism pulls available, specify and see page 9

81" Lower Hinge Doors, Open Storage Cabinet	22	36	81	219	44	FLT2236-81SL80	\$3,109		
	22	36	81	219	44	FLV2236-81SL80		\$4,532	\$4,985
	22	30	81	202	37	FLT2230-81SL80	\$2,956		
	22	30	81	202	37	FLV2230-81SL80		\$4,333	\$4,768

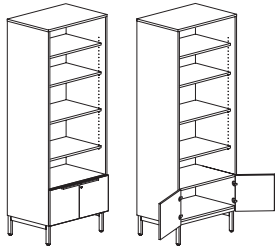

Features:

- aligns with secondary height units
- upper compartment has four adjustable shelves

Options:

- must specify chassis grain direction on double cut veneer, see pages 11-13 for details
- veneer door fronts in paint available, specify paint color and add \$337 list; see page 14 for details
- on laminate units, contrasting doors fronts available, no upcharge; specify color, see page 14 for details
- locking door available, specify and add \$142 list
- ledge pulls standard; prism pulls available, specify and see page 9

To Order, Specify:

① Laminate Model #		② Laminate Selection		③ Metal Color	④ Other Product Options
Laminate (FLT)		See Laminate Selection		See Metal Finish Color Options	See list of options for each specific unit; Specify and add accordingly.
① Veneer Model #	② Wood Species	③ Wood Finish		④ Metal Color	⑤ Other Product Options
Veneer (FLV)	Flat Cut CH1 Cherry MA1 Maple WA1 Walnut BO1 Black Oak	See Flat Cut Wood Finish Options		See Metal Finish Color Options	See list of options for each specific unit; Specify and add accordingly.
	Double Cut DC1 Double Cut	ⓐ Wood Finish See Double Cut Wood Finish Options	ⓑ Chassis Grain Direction For Double Cut Only: Vertical Horizontal		

Description	D	W	H	CTN WT	CU FT	① Model	Laminate	Flat Cut Veneer	Double Cut Veneer
69" h Lateral File Drawer, Storage Cabinet	22	36	69	259	38	FLT2236-69SL6D	\$3,575		
	22	36	69	259	38	FLV2236-69SL6D		\$4,970	\$5,466
	22	30	69	237	32	FLT2230-69SL6D	\$3,422		
	22	30	69	237	32	FLV2230-69SL6D		\$4,771	\$5,247

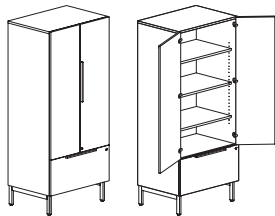

Features:

- aligns with secondary height units
- pedestal front locking
- upper compartment has three adjustable shelves

Options:

- must specify chassis grain direction on double cut veneer, see pages 11-13 for details
- veneer door and drawer front in paint available, specify paint color and add \$337; see page 14 for details
- on laminate units, contrasting door and drawer fronts available, no upcharge; specify color, see page 14 for details
- locking door available, specify and add \$142 list
- ledge pulls standard; prism pulls available, specify and see page 9

Description	D	W	H	CTN WT	CU FT	① Model	Laminate	Flat Cut Veneer	Double Cut Veneer
69" h Lateral File Drawer, Open Storage Cabinet	22	36	69	239	38	FLT2236-69SL60	\$3,412		
	22	36	69	239	38	FLV2236-69SL60		\$4,761	\$5,233
	22	30	69	217	32	FLT2230-69SL60	\$3,267		
	22	30	69	217	32	FLV2230-69SL60		\$4,572	\$5,029



Features:

- aligns with secondary height units
- pedestal front locking
- upper compartment has three adjustable shelves

Options:

- must specify chassis grain direction on double cut veneer, see pages 11-13 for details
- veneer drawer fronts in paint available, specify paint color and add \$337 list; see page 14 for details
- on laminate units, contrasting door front available, no upcharge; specify color, see page 14 for details
- ledge pulls standard; prism pulls available, specify and see page 9

FLUX - PRIVATE OFFICE

Description	D	W	H	CTN WT	CU FT	① Model	Laminate	Flat Cut Veneer	Double Cut Veneer
69" Lower and Upper Hinge Door Storage Cabinet	22	36	69	240	38	FLT2236-69SL8D	\$3,128		
	22	36	69	240	38	FLV2236-69SL8D		\$4,484	\$4,932
	22	30	69	223	32	FLT2230-69SL8D	\$2,986		
	22	30	69	223	32	FLV2230-69SL8D		\$4,311	\$4,740

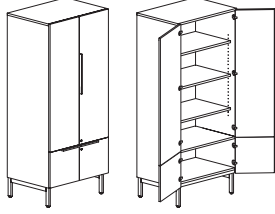

Features:

- aligns with secondary height units
- upper compartment has three adjustable shelves

Options:

- must specify chassis grain direction on double cut veneer, see pages 11-13 for details
- veneer door fronts in paint available, specify paint color and add \$337 list; see page 14 for details
- on laminate units, contrasting doors fronts available, no upcharge; specify color, see page 14 for details
- locking doors available, specify and add \$284 list
- ledge pulls standard; prism pulls available, specify and see page 9

69" Lower Hinge Doors, Open Storage Cabinet	22	36	69	219	38	FLT2236-69SL80	\$2,964		
	22	36	69	219	38	FLV2236-69SL80		\$4,275	\$4,701
	22	30	69	202	32	FLT2230-69SL80	\$2,832		
	22	30	69	202	32	FLV2230-69SL80		\$4,110	\$4,522

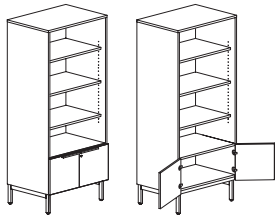

Features:

- aligns with secondary height units
- upper compartment has three adjustable shelves

Options:

- must specify chassis grain direction on double cut veneer, see pages 11-13 for details
- veneer door fronts in paint available, specify paint color and add \$337 list; see page 14 for details
- on laminate units, contrasting doors fronts available, no upcharge; specify color, see page 14 for details
- locking door available, specify and add \$142 list
- ledge pulls standard; prism pulls available, specify and see page 9

To Order, Specify:

① Laminate Model #		② Laminate Selection		③ Metal Color	④ Other Product Options
Laminate (FLT)		See Laminate Selection		See Metal Finish Color Options	See list of options for each specific unit; Specify and add accordingly.
① Veneer Model #	② Wood Species	③ Wood Finish		④ Metal Color	⑤ Other Product Options
Veneer (FLV)	Flat Cut CH1 Cherry MA1 Maple WA1 Walnut BO1 Black Oak	See Flat Cut Wood Finish Options		See Metal Finish Color Options	See list of options for each specific unit; Specify and add accordingly.
	Double Cut DC1 Double Cut	See Double Cut Wood Finish Options	③b Chassis Grain Direction For Double Cut Only: Vertical Horizontal		

FLUX - PRIVATE OFFICE

Description	D	W	H	CTN WT	CU FT	① Model	Laminate	Flat Cut Veneer	Double Cut Veneer
81" h File Drawer, Storage Cabinet	22	18	81	201	24	FLT2218-81SL5DR	\$3,020		
	22	18	81	201	24	FLV2218-81SL5DR		\$4,013	\$4,415
	22	18	81	201	24	FLT2218-81SL5DL	\$3,020		
	22	18	81	201	24	FLV2218-81SL5DL		\$4,013	\$4,415

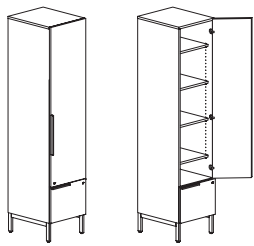

right shown

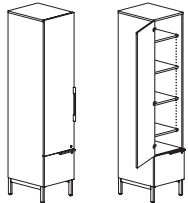

left

Features:

- aligns with secondary height units
- upper compartment has four adjustable shelves

Options:

- must specify chassis grain direction on double cut veneer, see pages 11-13 for details
- veneer door and drawer front in paint available, specify paint color and add \$337; see page 14 for details
- on laminate units, contrasting door and drawer fronts available, no upcharge; specify color, see page 14 for details
- locking door available, specify and add \$142 list
- ledge pulls standard; prism pulls available, specify and see page 9
- vanity mirror available, specify and add \$141 list

81" h File Drawer, Open Storage Cabinet	22	18	81	176	23	FLT2218-81SL50	\$2,911		
	22	18	81	176	23	FLV2218-81SL50		\$3,856	\$4,740

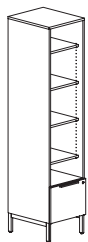

Features:

- aligns with secondary height units
- pedestal front locking
- upper compartment has four adjustable shelves

Options:

- must specify chassis grain direction on double cut veneer, see pages 11-13 for details
- veneer drawer fronts in paint available, specify paint color and add \$337 list; see page 14 for details
- on laminate units, contrasting door front available, no upcharge; specify color, see page 14 for details
- ledge pulls standard; prism pulls available, specify and see page 9

Description	D	W	H	CTN WT	CU FT	① Model	Laminate	Flat Cut Veneer	Double Cut Veneer
81" h Lower and Upper Hinge Door Storage Cabinet	22	18	81	187	24	FLT2218-81SL8DR	\$2,590		
	22	18	81	187	24	FLV2218-81SL8DR		\$3,550	\$3,904
	22	18	81	187	24	FLT2218-81SL8DL	\$2,590		
	22	18	81	187	24	FLV2218-81SL8DL		\$3,550	\$3,904

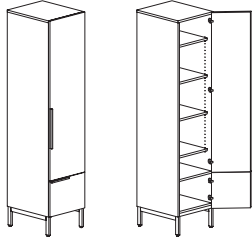

right shown

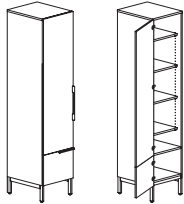

left

Features:

- aligns with secondary height units
- upper compartment has four adjustable shelves

Options:

- must specify chassis grain direction on double cut veneer, see pages 11-13 for details
- veneer door fronts in paint available, specify paint color and add \$337 list; see page 14 for details
- on laminate units, contrasting doors fronts available, no upcharge; specify color, see page 14 for details
- locking doors available, specify and add \$284 list; ledge pulls standard; prism pulls available, specify and see page 9
- vanity mirror available, specify and add \$141 list

81" h Lower Hinge Door, Open Storage Cabinet	22	18	81	163	24	FLT2218-81SL80R	\$2,482		
	22	18	81	163	24	FLV2218-81SL80R		\$3,392	\$3,731
	22	18	81	163	24	FLT2218-81SL80L	\$2,482		
	22	18	81	163	24	FLV2218-81SL80L		\$3,392	\$3,731

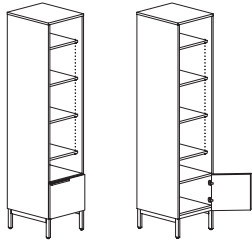

right shown

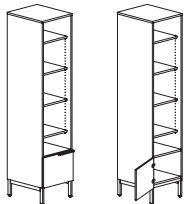

left

Features:

- aligns with secondary height units
- upper compartment has four adjustable shelves

Options:

- must specify chassis grain direction on double cut veneer, see pages 11-13 for details
- veneer door front in paint available, specify paint color and add \$337 list; see page 14 for details
- on laminate units, contrasting doors fronts available, no upcharge; specify color, see page 14 for details
- locking lower door available, specify and add \$142 list
- ledge pulls standard; prism pulls available, specify and see page 9

To Order, Specify:

① Laminate Model #		② Laminate Selection		③ Metal Color		④ Other Product Options			
Laminate (FLT)		See Laminate Selection		See Metal Finish Color Options		See list of options for each specific unit; Specify and add accordingly.			
① Veneer Model #		② Wood Species		③ Wood Finish		④ Metal Color		⑤ Other Product Options	
Veneer (FLV)		Flat Cut CH1 Cherry MA1 Maple WA1 Walnut BO1 Black Oak		See Flat Cut Wood Finish Options		See Metal Finish Color Options		See list of options for each specific unit; Specify and add accordingly.	
		Double Cut DC1 Double Cut		③a Wood Finish See Double Cut Wood Finish Options		③b Chassis Grain Direction For Double Cut Only: Vertical Horizontal			

Description	D	W	H	CTN WT	CU FT	① Model	Laminate	Flat Cut Veneer	Double Cut Veneer
69" h File Drawer, Storage Cabinet	22	18	69	179	20	FLT2218-69SL5DR	\$3,020		
	22	18	69	179	20	FLV2218-69SL5DR		\$4,013	\$4,415
	22	18	69	179	20	FLT2218-69SL5DL	\$3,020		
	22	18	69	179	20	FLV2218-69SL5DL		\$4,013	\$4,415

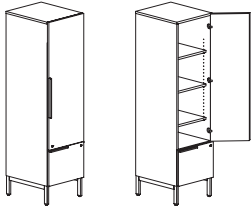

right shown

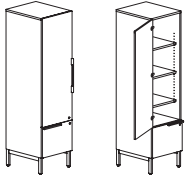

left

Features:

- aligns with secondary height units
- pedestal front locking
- upper compartment has three adjustable shelves

Options:

- must specify chassis grain direction on double cut veneer, see pages 11-13 for details
- veneer door and drawer front in paint available, specify paint color and add \$337; see page 14 for details
- on laminate units, contrasting door and drawer fronts available, no upcharge; specify color, see page 14 for details
- locking door available, specify and add \$142 list
- ledge pulls standard; prism pulls available, specify and see page 9
- vanity mirror available, specify and add \$141 list

69" h File Drawer, Open Storage Cabinet	22	18	69	154	20	FLT2218-69SL50	\$2,911		
	22	18	69	154	20	FLV2218-69SL50		\$3,856	\$4,244

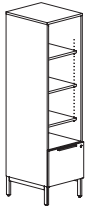

Features:

- aligns with secondary height units
- pedestal front locking
- upper compartment has three adjustable shelves

Options:

- must specify chassis grain direction on double cut veneer, see pages 11-13 for details
- veneer drawer fronts in paint available, specify paint color and add \$337 list; see page 14 for details
- on laminate units, contrasting door front available, no upcharge; specify color, see page 14 for details
- ledge pulls standard; prism pulls available, specify and see page 9

Description	D	W	H	CTN WT	CU FT	① Model	Laminate	Flat Cut Veneer	Double Cut Veneer
69" h Lower and Upper Hinge Door Storage Cabinet	22	18	69	166	20	FLT2218-69SL8DR	\$2,590		
	22	18	69	166	20	FLV2218-69SL8DR		\$3,550	\$3,904
	22	18	69	166	20	FLT2218-69SL8DL	\$2,590		
	22	18	69	166	20	FLV2218-69SL8DL		\$3,550	\$3,904

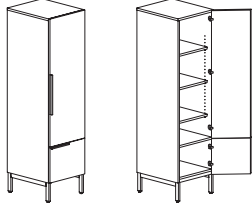

right shown

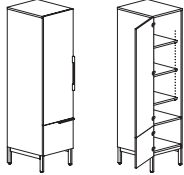

left

Features:

- aligns with secondary height units
- upper compartment has three adjustable shelves, lower compartment has one adjustable shelf

Options:

- must specify chassis grain direction on double cut veneer, see pages 11-13 for details
- veneer door fronts in paint available, specify paint color and add \$337 list; see page 14 for details
- on laminate units, contrasting doors fronts available, no upcharge; specify color, see page 14 for details
- locking doors available, specify and add \$284 list
- ledge pulls standard; prism pulls available, specify and see page 9
- vanity mirror available, specify and add \$141 list

69" h Lower Hinge Door, Open Storage Cabinet	22	18	69	141	20	FLT2218-69SL80R	\$2,482		
	22	18	69	141	20	FLV2218-69SL80R		\$3,392	\$3,731
	22	18	69	141	20	FLT2218-69SL80L	\$2,482		
	22	18	69	141	20	FLV2218-69SL80L		\$3,392	\$3,731

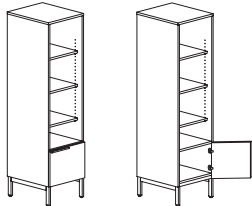

right shown

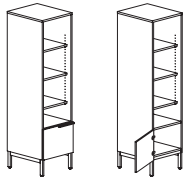

left

Features:

- aligns with secondary height units
- upper compartment has three adjustable shelves, lower compartment has one adjustable shelf

Options:

- must specify chassis grain direction on double cut veneer, see pages 11-13 for details
- veneer drawer fronts in paint available, specify paint color and add \$337 list; see page 14 for details
- on laminate units, contrasting door front available, no upcharge; specify color, see page 14 for details
- locking door available, specify and add \$142 list
- ledge pulls standard; prism pulls available, specify and see page 9

To Order, Specify:

① Laminate Model #		② Laminate Selection		③ Metal Color	④ Other Product Options
Laminate (FLT)		See Laminate Selection		See Metal Finish Color Options	See list of options for each specific unit; Specify and add accordingly.
① Veneer Model #	② Wood Species	③ Wood Finish		④ Metal Color	⑤ Other Product Options
Veneer (FLV)	Flat Cut CH1 Cherry MA1 Maple WA1 Walnut BO1 Black Oak	See Flat Cut Wood Finish Options		See Metal Finish Color Options	See list of options for each specific unit; Specify and add accordingly.
	Double Cut DC1 Double Cut	ⓐ Wood Finish See Double Cut Wood Finish Options	ⓑ Chassis Grain Direction For Double Cut Only: Vertical Horizontal		

Description	D	W	H	CTN WT	CU FT	① Model	Laminate	Flat Cut Veneer	Double Cut Veneer
48" h Pantry Drawer with Filing and Wardrobe, Single User	30	18	48	254	23	FLT3018-48PTAR	\$2,744		
	30	18	48	254	23	FLV3018-48PTAR		\$3,531	\$3,868
	30	18	48	254	23	FLT3018-48PTAL	\$2,744		
	30	18	48	254	23	FLV3018-48PTAL		\$3,531	\$3,868

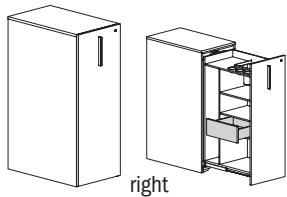

right

Features:

- filing brackets, accessory trays, fixed shelf, box drawer and wardrobe coat hook
- may not be used with Mid Support bracket to support Bench or Table Surfaces
- drawer extends 26"

Options:

- must specify drawer interior color, Designer White or Slate Grey
- must specify chassis grain direction on double cut veneer, see pages 11-13 for details
- veneer door and drawer fronts available in contrasting paint color, specify paint color and add \$337 list; see pages 14 for details
- laminate door and drawer fronts available in contrasting color, no upcharge, specify color; see pages 14 for details
- ledge pulls standard; prism pulls available, specify and see page 9
- locking door available, specify and add \$142 list
- wire pass-thru grommets available, specify and add \$114 list
- markerboard available on drawer back panel, specify and add \$510 list
- power jumper available; specify and add \$45 list. (wire pass-thru grommet option must also be specified.)

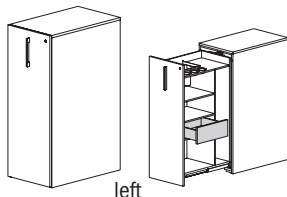

left

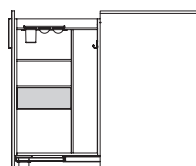

side view

FLUX - PRIVATE OFFICE

48" h Pantry Drawer with Paper Sorter and Wardrobe, Single User	30	18	48	234	23	FLT3018-48PTBR	\$2,621		
	30	18	48	234	23	FLV3018-48PTBR		\$3,409	\$3,733
	30	18	48	234	23	FLT3018-48PTBL	\$2,621		
	30	18	48	234	23	FLV3018-48PTBL		\$3,409	\$3,733
	24	18	48	169	18	FLT2418-48PTBR	\$2,551		
	24	18	48	169	18	FLV2418-48PTBR		\$3,316	\$3,599
	24	18	48	169	18	FLT2418-48PTBL	\$2,551		
	24	18	48	169	18	FLV2418-48PTBL		\$3,316	\$3,599

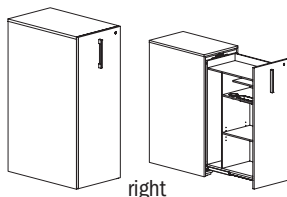

right

Features:

- paper shelves, accessory trays, fixed shelves and wardrobe coat hook
- may not be used with Mid Support bracket to support Bench or Table Surfaces
- drawer extends 26" on 30"d units, 20" on 24"d units

Options:

- must specify drawer interior color, Designer White or Slate Grey
- must specify chassis grain direction on double cut veneer, see pages 11-13 for details
- veneer door and drawer fronts available in contrasting paint color, specify paint color and add \$337 list; see pages 14 for details
- laminate door and drawer fronts available in contrasting color, no upcharge, specify color; see pages 14 for details
- ledge pulls standard; prism pulls available, specify and see page 9
- locking door available, specify and add \$142 list
- wire pass-thru grommets available, specify and add \$114 list
- markerboard available on drawer back panel, specify and add \$510 list
- power jumper available; specify and add \$45 list. (wire pass-thru grommet option must also be specified.)

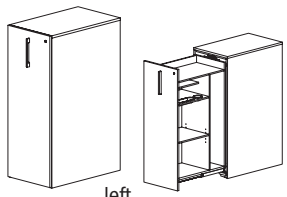

left

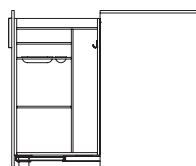

side view

Description	D	W	H	CTN WT	CU FT	① Model	Laminate	Flat Cut Veneer	Double Cut Veneer
48" h Pantry Drawer with Filing, Single User	30	18	48	218	23	FLT3018-48PTCR	\$2,657		
	30	18	48	218	23	FLV3018-48PTCR		\$3,458	\$3,786
	30	18	48	218	23	FLT3018-48PTCL	\$2,657		
	30	18	48	218	23	FLV3018-48PTCL		\$3,458	\$3,786
	24	18	48	192	18	FLT2418-48PTCR	\$2,588		
	24	18	48	192	18	FLV2418-48PTCR		\$3,366	\$3,652
	24	18	48	192	18	FLT2418-48PTCL	\$2,588		
	24	18	48	192	18	FLV2418-48PTCL		\$3,366	\$3,652

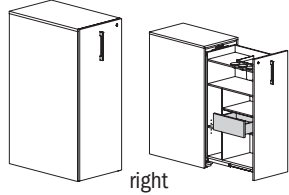

right

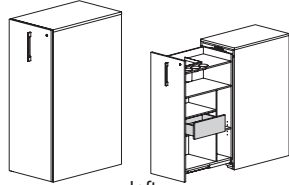

left

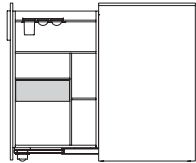

side view

Features:

- filing brackets, accessory trays, fixed shelves and box drawer
- may not be used with Mid Support bracket to support Bench or Table Surfaces
- drawer extends 26" on 30"d units, 20" on 24"d units

Options:

- must specify drawer interior color, Designer White or Slate Grey
- must specify chassis grain direction on double cut veneer, see pages 11-13 for details
- veneer door and drawer fronts available in contrasting paint color, specify paint color and add \$337 list; see pages 14 for details
- laminate door and drawer fronts available in contrasting color, no upcharge, specify color; see pages 14 for details
- ledge pulls standard; prism pulls available, specify and see page 9
- locking door available, specify and add \$142 list
- wire pass-thru grommets available, specify and add \$114 list
- markerboard available on drawer back panel, specify and add \$510 list
- power jumper available; specify and add \$45 list. (wire pass-thru grommet option must also be specified.)

To Order, Specify:

① Laminate Model #	② Laminate Selection	③ Metal Color	④ Other Product Options		
Laminate (FLT)	See Laminate Selection	See Metal Finish Color Options	See list of options for each specific unit; Specify and add accordingly.		
① Veneer Model #	② Wood Species	③ Wood Finish	④ Metal Color	⑤ Other Product Options	
Veneer (FLV)	Flat Cut CH1 Cherry MA1 Maple WA1 Walnut BO1 Black Oak	See Flat Cut Wood Finish Options	See Metal Finish Color Options	See list of options for each specific unit; Specify and add accordingly.	
	Double Cut DC1 Double Cut	<table border="1"> <tr> <th>ⓐ Wood Finish</th> <th>ⓑ Chassis Grain Direction</th> </tr> <tr> <td>See Double Cut Wood Finish Options</td> <td>For Double Cut Only: Vertical Horizontal</td> </tr> </table>			ⓐ Wood Finish
ⓐ Wood Finish	ⓑ Chassis Grain Direction				
See Double Cut Wood Finish Options	For Double Cut Only: Vertical Horizontal				

Description	D	W	H	CTN WT	CU FT	① Model	Laminate	Flat Cut Veneer	Double Cut Veneer
48" h Pantry Drawer with Paper Sorter, Single User	30	18	48	209	23	FLT3018-48PTDR	\$2,596		
	30	18	48	209	23	FLV3018-48PTDR		\$3,377	\$3,699
	30	18	48	209	23	FLT3018-48PTDL	\$2,596		
	30	18	48	209	23	FLV3018-48PTDL		\$3,377	\$3,699
	24	18	48	163	18	FLT2418-48PTDR	\$2,528		
	24	18	48	163	18	FLV2418-48PTDR		\$3,285	\$3,566
	24	18	48	163	18	FLT2418-48PTDL	\$2,528		
	24	18	48	163	18	FLV2418-48PTDL		\$3,285	\$3,566

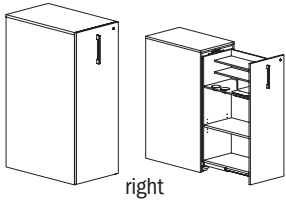

right

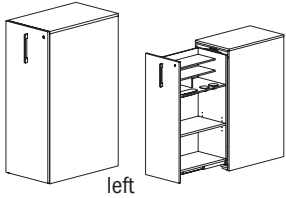

left

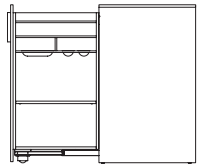

side view

Features:

- paper shelves, accessory trays and fixed shelves
- may not be used with Mid Support bracket to support Bench or Table Surfaces
- drawer extends 26" on 30"d units, 20" on 24"d units

Options:

- must specify drawer interior color, Designer White or Slate Grey
- must specify chassis grain direction on double cut veneer, see pages 11-13 for details
- veneer door and drawer fronts available in contrasting paint color, specify paint color and add \$337 list; see pages 14 for details
- laminate door and drawer fronts available in contrasting color, no upcharge, specify color; see pages 14 for details
- ledge pulls standard; prism pulls available, specify and see page 9
- locking door available, specify and add \$142 list
- wire pass-thru grommets available, specify and add \$114 list
- markerboard available on drawer back panel, specify and add \$510 list
- power jumper available; specify and add \$45 list. (wire pass-thru grommet option must also be specified.)

48" h Pantry Drawer, Dual User	30	18	48	225	23	FLT3018-48PTE	\$2,782		
	30	18	48	225	23	FLV3018-48PTE		\$3,623	\$3,967
	24	18	48	184	18	FLT2418-48PTE	\$2,710		
	24	18	48	184	18	FLV2418-48PTE		\$3,524	\$3,860

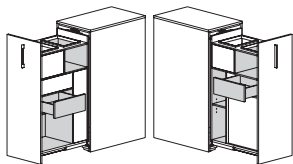
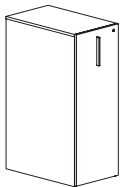

side view

Features:

- filing brackets, fixed shelves and box drawer for each side
- may not be used with Mid Support bracket to support Bench or Table Surfaces
- drawer extends 26" on 30"d units, 20" on 24"d units

Options:

- must specify drawer interior color, Designer White or Slate Grey
- must specify chassis grain direction on double cut veneer, see pages 11-13 for details
- veneer door and drawer fronts available in contrasting paint color, specify paint color and add \$337 list; see pages 14 for details
- laminate door and drawer fronts available in contrasting color, no upcharge, specify color; see pages 14 for details
- ledge pulls standard; prism pulls available, specify and see page 9
- locking door available, specify and add \$142 list
- wire pass-thru grommets available, specify and add \$114 list
- power jumper available; specify and add \$45 list. (wire pass-thru grommet option must also be specified.)

Description	D	W	H	CTN WT	CU FT	① Model	List Price
Tack Panel	½	28⅞	17½	13	2	FLB30-18B1-FTK	\$183
	½	23⅞	17½	12	2	FLB24-18B1-FTK	\$150

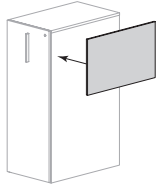

Features:

- mounts to sides of 48”h Storage Cabinets
- sizes coordinate with depth of Storage Cabinets

Options:

- select color, ash grey or silver grey

To Order, Specify:

① Laminate Model #	② Laminate Type	③ Laminate Selection	④ Metal Color	⑤ Other Product Options
Laminate (FLT)	HPL	See Laminate Selection	See Metal Finish Color Options	See list of options for each specific unit; Specify and add accordingly.

① Veneer Model #	② Wood Species	③ Wood Finish - Finishes with an asterisk (*) have a coordinating laminate available	④ Metal Color	⑤ Other Product Options	
Veneer (FLV)	Flat Cut CH1 Cherry MA1 Maple WA1 Walnut BO1 Black Oak	See Flat Cut Wood Finish Options	See Metal Finish Color Options	See list of options for each specific unit; Specify and add accordingly.	
	Double Cut DC1 Double Cut	<table border="1"> <thead> <tr> <th>③a Wood Finish</th> <th>③b Chassis Grain Direction</th> </tr> </thead> <tbody> <tr> <td>See Double Cut Wood Finish Options</td> <td>For Double Cut Only: Vertical Horizontal</td> </tr> </tbody> </table>			③a Wood Finish
③a Wood Finish	③b Chassis Grain Direction				
See Double Cut Wood Finish Options	For Double Cut Only: Vertical Horizontal				

Description	D	W	H	CTN WT	CU FT	① Model	List Price
42" h Locker - Open Shelves	22	12	42	77	11	FLT2212-42FLK-E	\$1,073
	18	12	42	65	9	FLT1812-42FLK-E	\$1,013

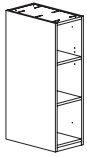

Features:

- must be connected to another locker with a common top, this unit is not freestanding; see pages 450-452 for modular tops
- one adjustable shelf and one fixed shelf (lower)
- unfinished back; modular common top & finished back panels available

42" h Locker - Storage Cabinet	22	12	42	98	11	FLT2212-42FLK-EDR	\$1,271
	22	12	42	98	11	FLT2212-42FLK-EDL	\$1,271
	18	12	42	86	9	FLT1812-42FLK-EDR	\$1,204
	18	12	42	86	9	FLT1812-42FLK-EDL	\$1,204

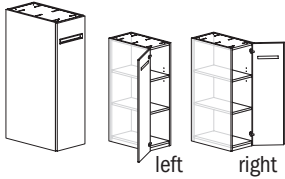

Features:

- must be connected to another locker with a common top, this unit is not freestanding; see pages 450-452 for modular tops
- one adjustable shelf and one fixed shelf (lower)
- unfinished back; modular common top & finished back panels available

Options:

- laminate door fronts available in contrasting color, no upcharge, specify color
- specify pull; see page 452
- locking options available; see page 452 for details and upcharge
- number plate available, order separately; see page 453

42" h Locker - Storage Cabinet with Wardrobe Hooks	22	12	42	96	11	FLT2212-42FLK-BDR	\$1,324
	22	12	42	96	11	FLT2212-42FLK-BDL	\$1,324
	18	12	42	85	9	FLT1812-42FLK-BDR	\$1,258
	18	12	42	85	9	FLT1812-42FLK-BDL	\$1,258

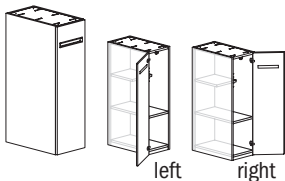

Features:

- must be connected to another locker with a common top, this unit is not freestanding; see pages 450-452 for modular tops
- one full depth fixed shelf, one shallow adjustable shelf and two coat hooks
- unfinished back; modular common top & finished back panels available

Options:

- laminate door fronts available in contrasting color, no upcharge, specify color
- specify pull; see page 452
- locking options available; see page 452 for details and upcharge
- number plate available, order separately; see page 453

42" h Locker - Wardrobe	22	12	42	89	11	FLT2212-42FLK-CDR	\$1,265
	22	12	42	89	11	FLT2212-42FLK-CDL	\$1,265
	18	12	42	79	9	FLT1812-42FLK-CDR	\$1,200
	18	12	42	79	9	FLT1812-42FLK-CDL	\$1,200

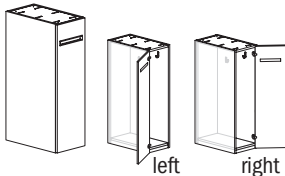

Features:

- must be connected to another locker with a common top, this unit is not freestanding; see pages 450-452 for modular tops
- one wardrobe bar in 22" d units; two coat hooks in 18" d units
- unfinished back; modular common top & finished back panels available

Options:

- laminate door fronts available in contrasting color, no upcharge, specify color
- specify pull; see page 452
- locking options available; see page 452 for details and upcharge
- number plate available, order separately; see page 453

Description	D	W	H	CTN WT	CU FT	① Model	List Price
48" h Locker - Open Shelves	22	12	48	84	13	FLT2212-48FLK-E	\$1,123
	18	12	48	65	11	FLT1812-48FLK-E	\$1,062

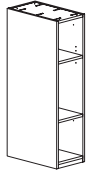

Features:

- must be connected to another locker with a common top, this unit is not freestanding; see pages 450-452 for modular tops
- one adjustable shelf and one fixed shelf (lower)
- unfinished back; modular common top & finished back panels available

48" h Locker - Storage Cabinet	22	12	48	107	13	FLT2212-48FLK-EDR	\$1,330
	22	12	48	107	13	FLT2212-48FLK-EDL	\$1,330
	18	12	48	86	11	FLT1812-48FLK-EDR	\$1,260
	18	12	48	86	11	FLT1812-48FLK-EDL	\$1,260

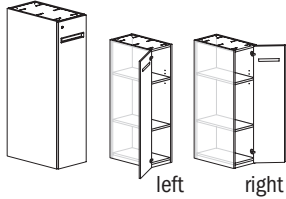

Features:

- must be connected to another locker with a common top, this unit is not freestanding; see pages 450-452 for modular tops
- one adjustable shelf and one fixed shelf (lower)
- unfinished back; modular common top & finished back panels available

Options:

- laminate door fronts available in contrasting color, no upcharge, specify color
- specify pull; see page 452
- locking options available; see page 452 for details and upcharge
- number plate available, order separately; see page 453

48" h Locker - Storage Cabinet with Wardrobe Hooks	22	12	48	106	13	FLT2212-48FLK-BDR	\$1,382
	22	12	48	106	13	FLT2212-48FLK-BDL	\$1,382
	18	12	48	94	11	FLT1812-48FLK-BDR	\$1,314
	18	12	48	94	11	FLT1812-48FLK-BDL	\$1,314

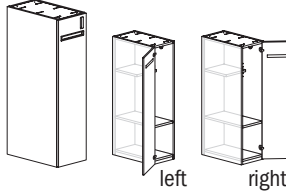

Features:

- must be connected to another locker with a common top, this unit is not freestanding; see pages 450-452 for modular tops
- one full depth fixed shelf, one shallow adjustable shelf and two coat hooks
- unfinished back; modular common top & finished back panels available

Options:

- laminate door fronts available in contrasting color, no upcharge, specify color
- specify pull; see page 452
- locking options available; see page 452 for details and upcharge
- number plate available, order separately; see page 453

To Order, Specify:

① Laminate Model #	② Laminate Type	③ Laminate Selection	④ Metal Color	⑤ Other Product Options
Laminate (FLT)	HPL	See Laminate Selection	See Metal Finish Color Options	See list of options for each specific unit; Specify and add accordingly.

① Veneer Model #	② Wood Species	③ Wood Finish - Finishes with an asterisk (*) have a coordinating laminate available	④ Metal Color	⑤ Other Product Options		
Veneer (FLV)	Flat Cut CH1 Cherry MA1 Maple WA1 Walnut BO1 Black Oak	See Flat Cut Wood Finish Options	See Metal Finish Color Options	See list of options for each specific unit; Specify and add accordingly.		
	Double Cut DC1 Double Cut	<table border="1"> <thead> <tr> <th>③a Wood Finish</th> <th>③b Chassis Grain Direction</th> </tr> </thead> <tbody> <tr> <td>See Double Cut Wood Finish Options</td> <td>For Double Cut Only: Vertical Horizontal</td> </tr> </tbody> </table>	③a Wood Finish		③b Chassis Grain Direction	See Double Cut Wood Finish Options
③a Wood Finish	③b Chassis Grain Direction					
See Double Cut Wood Finish Options	For Double Cut Only: Vertical Horizontal					

Description	D	W	H	CTN WT	CU FT	① Model	List Price
48" h Locker - Wardrobe	22	12	48	99	13	FLT2212-48FLK-CDR	\$1,326
	22	12	48	99	13	FLT2212-48FLK-CDL	\$1,326
	18	12	48	88	11	FLT1812-48FLK-CDR	\$1,258
	18	12	48	88	11	FLT1812-48FLK-CDL	\$1,258

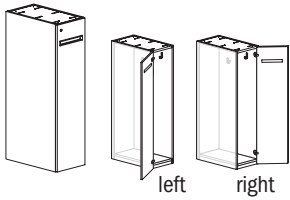

Features:

- must be connected to another locker with a common top, this unit is not freestanding; see pages 450-452 for modular tops
- one wardrobe bar in 22" d units; two coat hooks in 18" d units
- unfinished back; modular common top & finished back panels available

Options:

- laminate door fronts available in contrasting color, no upcharge, specify color
- specify pull; see page 452
- locking options available; see page 452 for details and upcharge
- number plate available, order separately; see page 453

69" h Locker - Open Shelves	22	12	69	116	13	FLT2212-69FLK-F	\$1,257
	18	12	69	98	11	FLT1812-69FLK-F	\$1,188

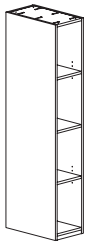

Features:

- must be connected to another locker with a common top, this unit is not freestanding; see pages 450-452 for modular tops
- two adjustable shelves and one fixed shelf (center)
- unfinished back; modular common top & finished back panels available

69" h Locker - Storage Cabinet	22	12	69	150	18	FLT2212-69FLK-FDR	\$1,490
	22	12	69	150	18	FLT2212-69FLK-FDL	\$1,490
	18	12	69	133	15	FLT1812-69FLK-FDR	\$1,412
	18	12	69	133	15	FLT1812-69FLK-FDL	\$1,412

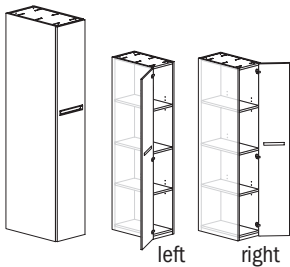

Features:

- must be connected to another locker with a common top, this unit is not freestanding; see pages 450-452 for modular tops
- two adjustable shelves and one fixed shelf (center)
- unfinished back; modular common top & finished back panels available

Options:

- laminate door fronts available in contrasting color, no upcharge, specify color
- specify pull; see page 452
- locking options available; see page 452 for details and upcharge
- number plate available, order separately; see page 453

69" h Locker - Storage Cabinet with Wardrobe Hooks	22	12	69	146	18	FLT2212-69FLK-GDR	\$1,548
	22	12	69	146	18	FLT2212-69FLK-GDL	\$1,548
	18	12	69	130	15	FLT1812-69FLK-GDR	\$1,472
	18	12	69	130	15	FLT1812-69FLK-GDL	\$1,472

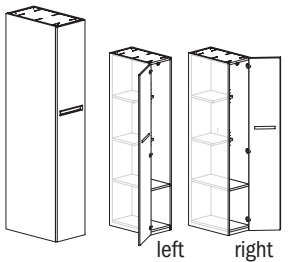

Features:

- must be connected to another locker with a common top, this unit is not freestanding; see pages 450-452 for modular tops
- one full depth fixed shelf, two shallow adjustable shelves and two coat hooks
- unfinished back; modular common top & finished back panels available

Options:

- laminate door fronts available in contrasting color, no upcharge, specify color
- specify pull; see page 452
- locking options available; see page 452 for details and upcharge
- number plate available, order separately; see page 453

Description	D	W	H	CTN WT	CU FT	① Model	List Price
69" h Locker - Wardrobe	22	12	69	141	18	FLT2212-69FLK-HDR	\$1,510
	22	12	69	141	18	FLT2212-69FLK-HDL	\$1,510
	18	12	69	125	15	FLT1812-69FLK-HDR	\$1,433
	18	12	69	125	15	FLT1812-69FLK-HDL	\$1,433

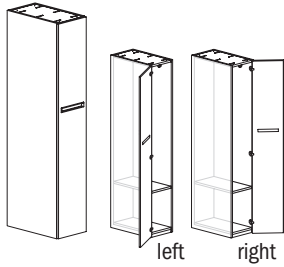

Features:

- must be connected to another locker with a common top, this unit is not freestanding; see pages 450-452 for modular tops
- one full depth fixed shelf and one wardrobe bar in 22" d units; two coat hooks in 18" d units
- unfinished back; modular common top & finished back panels available

Options:

- laminate door fronts available in contrasting color, no upcharge, specify color
- specify pull; see page 452
- locking options available; see page 452 for details and upcharge
- number plate available, order separately; see page 453

69" h Dual Locker - Storage Cabinet	22	12	69	151	18	FLT2212-69FLK-F2DR	\$1,531
	22	12	69	151	18	FLT2212-69FLK-F2DL	\$1,531
	18	12	69	133	15	FLT1812-69FLK-F2DR	\$1,452
	18	12	69	133	15	FLT1812-69FLK-F2DL	\$1,452

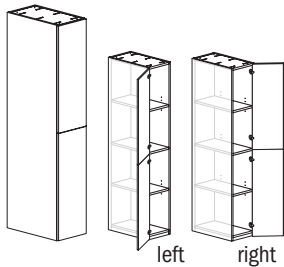

Features:

- must be connected to another locker with a common top, this unit is not freestanding; see pages 450-452 for modular tops
- one adjustable shelf per compartment
- unfinished back; modular common top & finished back panels available

Options:

- laminate door fronts available in contrasting color, no upcharge, specify color
- specify pull; see page 452
- locking options available; see page 452 for details and upcharge
- number plate available, order separately; see page 453

69" h Triple Locker - Storage Cabinet	22	12	69	160	18	FLT2212-69FLK-J3DR	\$1,569
	22	12	69	160	18	FLT2212-69FLK-J3DL	\$1,569
	18	12	69	140	15	FLT1812-69FLK-J3DR	\$1,492
	18	12	69	140	15	FLT1812-69FLK-J3DL	\$1,492

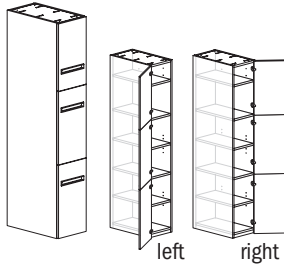

Features:

- must be connected to another locker with a common top, this unit is not freestanding; see pages 450-452 for modular tops
- one adjustable shelf per compartment
- unfinished back; modular common top & finished back panels available

Options:

- laminate door fronts available in contrasting color, no upcharge, specify color
- specify pull; see page 452
- locking options available; see page 452 for details and upcharge
- number plate available, order separately; see page 453

To Order, Specify:

① Laminate Model #	② Laminate Type	③ Laminate Selection	④ Metal Color	⑤ Other Product Options
Laminate (FLT)	HPL	See Laminate Selection	See Metal Finish Color Options	See list of options for each specific unit; Specify and add accordingly.

① Veneer Model #	② Wood Species	③ Wood Finish - Finishes with an asterisk (*) have a coordinating laminate available	④ Metal Color	⑤ Other Product Options		
Veneer (FLV)	Flat Cut CH1 Cherry MA1 Maple WA1 Walnut BO1 Black Oak	See Flat Cut Wood Finish Options	See Metal Finish Color Options	See list of options for each specific unit; Specify and add accordingly.		
	Double Cut DC1 Double Cut	<table border="1"> <thead> <tr> <th>③a Wood Finish</th> <th>③b Chassis Grain Direction</th> </tr> </thead> <tbody> <tr> <td>See Double Cut Wood Finish Options</td> <td>For Double Cut Only: Vertical Horizontal</td> </tr> </tbody> </table>	③a Wood Finish		③b Chassis Grain Direction	See Double Cut Wood Finish Options
③a Wood Finish	③b Chassis Grain Direction					
See Double Cut Wood Finish Options	For Double Cut Only: Vertical Horizontal					

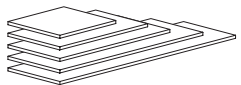
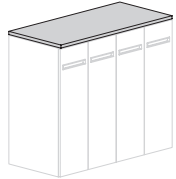
Description	D	W	H	CTN WT	CU FT	① Model	List Price
Modular Top - Single Depth Locker   in application	22	96 1/8	1 3/16	78	5	FLT2296LKMT	\$764
	22	84 1/8	1 3/16	69	5	FLT2284LKMT	\$670
	22	72 1/8	1 3/16	60	4	FLT2272LKMT	\$574
	22	60 1/8	1 3/16	50	4	FLT2260LKMT	\$479
	22	48 1/8	1 3/16	42	3	FLT2248LKMT	\$385
	22	36 1/8	1 3/16	33	2	FLT2236LKMT	\$289
	22	24 1/8	1 3/16	24	2	FLT2224LKMT	\$226
	18	96 1/8	1 3/16	65	5	FLT1896LKMT	\$750
	18	84 1/8	1 3/16	56	4	FLT1884LKMT	\$655
	18	72 1/8	1 3/16	50	4	FLT1872LKMT	\$562
	18	61 1/8	1 3/16	44	3	FLT1860LKMT	\$469
	18	48 1/8	1 3/16	35	3	FLT1848LKMT	\$377
	18	36 1/8	1 3/16	28	2	FLT1836LKMT	\$282
	18	24 1/8	1 3/16	20	2	FLT1824LKMT	\$221

Features:

- use with modular Locker Storage Cabinets
- eased edge profile user side

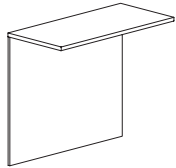
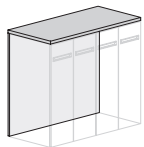
42" h Modular Top & Common Back - Single Depth Locker   in application	22 3/4	60 1/8	42	105	44	FLT2360-42LKMTB	\$1,141
	22 3/4	48 1/8	42	85	36	FLT2348-42LKMTB	\$914
	22 3/4	36 1/8	42	65	28	FLT2336-42LKMTB	\$687
	22 3/4	24 1/8	42	45	20	FLT2324-42LKMTB	\$537
	18 3/4	60 1/8	42	97	38	FLT1960-42LKMTB	\$1,132
	18 3/4	48 1/8	42	85	31	FLT1948-42LKMTB	\$907
	18 3/4	36 1/8	42	60	24	FLT1936-42LKMTB	\$681
	18 3/4	24 1/8	42	42	17	FLT1924-42LKMTB	\$533

Features:

- use with modular Locker Storage Cabinets to create a finished back
- eased edge profile user side

Description	D	W	H	CTN WT	CU FT	① Model	List Price
48" h Modular Top & Common Back - Single Depth Locker	22 3/4	60 1/8	48	113	50	FLT2360-48LKMTB	\$1,236
	22 3/4	48 1/8	48	91	41	FLT2348-48LKMTB	\$991
	22 3/4	36 1/8	48	69	32	FLT2336-48LKMTB	\$745
	22 3/4	24 1/8	48	49	23	FLT2324-48LKMTB	\$582
	18 3/4	60 1/8	48	104	43	FLT1960-48LKMTB	\$1,228
	18 3/4	48 1/8	48	85	35	FLT1948-48LKMTB	\$981
	18 3/4	36 1/8	48	65	27	FLT1936-48LKMTB	\$738
	18 3/4	24 1/8	48	45	19	FLT1924-48LKMTB	\$578

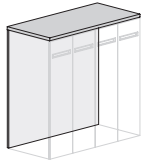
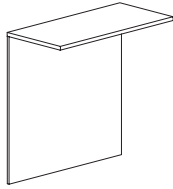

in application

Features:

- use with modular Locker Storage Cabinets to create a finished back
- eased edge profile user side

Description	D	W	H	CTN WT	CU FT	① Model	List Price
69" h Modular Top & Common Back - Single Depth Locker	22 3/4	60 1/8	69	140	71	FLT2360-69LKMTB	\$1,566
	22 3/4	48 1/8	69	113	58	FLT2348-69LKMTB	\$1,255
	22 3/4	36 1/8	69	80	45	FLT2336-69LKMTB	\$945
	22 3/4	24 1/8	69	59	31	FLT2324-69LKMTB	\$737
	18 3/4	60 1/8	69	132	60	FLT1960-69LKMTB	\$1,560
	18 3/4	48 1/8	69	107	49	FLT1948-69LKMTB	\$1,248
	18 3/4	36 1/8	69	80	38	FLT1936-69LKMTB	\$936
	18 3/4	24 1/8	69	56	27	FLT1924-69LKMTB	\$733

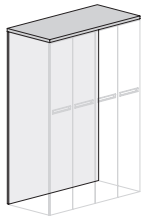
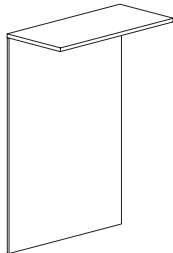

Features:

- use with modular Locker Storage Cabinets to create a finished back
- eased edge profile user side

To Order, Specify:

① Laminate Model #	② Laminate Type	③ Laminate Selection	④ Metal Color	⑤ Other Product Options
Laminate (FLT)	HPL	See Laminate Selection	See Metal Finish Color Options	See list of options for each specific unit; Specify and add accordingly.

① Veneer Model #	② Wood Species	③ Wood Finish - Finishes with an asterisk (*) have a coordinating laminate available	④ Metal Color	⑤ Other Product Options
Veneer (FLV)	Flat Cut CH1 Cherry MA1 Maple WA1 Walnut BO1 Black Oak	See Flat Cut Wood Finish Options	See Metal Finish Color Options	See list of options for each specific unit; Specify and add accordingly.
		③a Wood Finish See Double Cut Wood Finish Options		

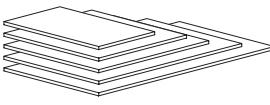
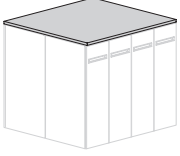
Description	D	W	H	CTN WT	CU FT	① Model	List Price	
Modular Top - Back to Back Lockers 	44	96 1/8	1 3/16	150	9	FLT4496LKMT	\$1,515	
	44	84 1/8	1 3/16	133	8	FLT4484LKMT	\$1,328	
	44	72 1/8	1 3/16	114	7	FLT4472LKMT	\$1,141	
	44	60 1/8	1 3/16	96	6	FLT4460LKMT	\$945	
	44	48 1/8	1 3/16	78	5	FLT4448LKMT	\$671	
	44	36 1/8	1 3/16	60	4	FLT4436LKMT	\$576	
	44	24 1/8	1 3/16	42	3	FLT4424LKMT	\$345	
	 in application	36	96 1/8	1 3/16	124	8	FLT3696LKMT	\$1,245
		36	84 1/8	1 3/16	109	7	FLT3684LKMT	\$1,092
		36	72 1/8	1 3/16	95	6	FLT3672LKMT	\$936
36		61 1/8	1 3/16	80	5	FLT3660LKMT	\$782	
36		48 1/8	1 3/16	65	4	FLT3648LKMT	\$631	
36		36 1/8	1 3/16	35	3	FLT3636LKMT	\$486	
36		24 1/8	1 3/16	35	3	FLT3624LKMT	\$296	

Features:

- use with modular Locker Storage Cabinets to span back-to-back units
- eased edge profile user side

Description	D	W	H	CTN WT	CU FT	① Model	List Price
Locker Number Plate	1/8	1	1	1	1	FLB-NUMPLT	\$37

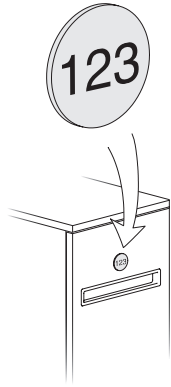

Features:

- helvetica font, 1-3 character

Options:

- select silver with black numerals or black with silver numerals

Lock & Key				1	1	FLB-LOCKCORE-A	\$30
------------	--	--	--	---	---	----------------	------

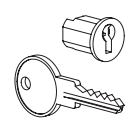

Features:

- key #'s start at 100

Options:

- select key #'s
- select Silver or Black

Digital lock master key				1	1	FLB-MASTKEY-B	\$98
-------------------------	--	--	--	---	---	---------------	------

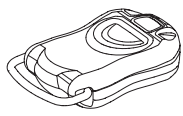

Keyless radial lock master key				1	1	FLB-MASTKEY-C	\$98
--------------------------------	--	--	--	---	---	---------------	------

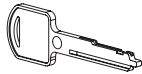

To Order, Specify:

① Laminate Model #	② Laminate Type	③ Laminate Selection	④ Metal Color	⑤ Other Product Options
Laminate (FLT)	HPL	See Laminate Selection	See Metal Finish Color Options	See list of options for each specific unit; Specify and add accordingly.

① Veneer Model #	② Wood Species	③ Wood Finish - Finishes with an asterisk (*) have a coordinating laminate available	④ Metal Color	⑤ Other Product Options	
Veneer (FLV)	Flat Cut CH1 Cherry MA1 Maple WA1 Walnut BO1 Black Oak	See Flat Cut Wood Finish Options	See Metal Finish Color Options	See list of options for each specific unit; Specify and add accordingly.	
	Double Cut DC1 Double Cut	<table border="1"> <thead> <tr> <th>③a Wood Finish</th> <th>③b Chassis Grain Direction</th> </tr> </thead> <tbody> <tr> <td>See Double Cut Wood Finish Options</td> <td>For Double Cut Only: Vertical Horizontal</td> </tr> </tbody> </table>			③a Wood Finish
③a Wood Finish	③b Chassis Grain Direction				
See Double Cut Wood Finish Options	For Double Cut Only: Vertical Horizontal				

FLUX - PRIVATE OFFICE

Description	D	W	H	CTN WT	CU FT	① Model	List Price
-------------	---	---	---	-----------	----------	---------	------------

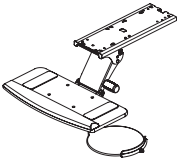
	Articulating Keyboard Tray	13	24	7	14	2	AK2	\$520
<ul style="list-style-type: none"> · articulating keyboard tray - black color · mouse tray included · 16" glide track · easy one-handed adjustment; vertical range of motion of 5.1" below glide track · tray tilt range +10 degree to -20 degree · unit swivels side-to-side · tray size is 19.4" wide x 9.4" deep · tray includes palm rest · tray is made with recyclable high density polyethylene 								

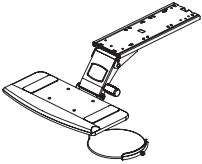
	Articulating Keyboard Tray	13	24	7	12	2	AK3	\$550
<ul style="list-style-type: none"> · articulating keyboard tray - black color · mouse tray included · 17" glide track · easy one-handed adjustment; vertical range of motion of 8.9"; (6.5" below the glide track and an additional 2.38" above) · tray tilt range +10 degree to -20 degree · unit swivels side-to-side · tray size is 19.4" wide x 9.4" deep · tray includes palm rest · tray is made with recyclable high density polyethylene 								

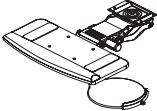
	Articulating Keyboard Tray	11	23	3	11	2	AK5	\$535
<ul style="list-style-type: none"> · articulating keyboard tray - wood finish tray with black mechanism · mouse tray included · use when depth under work surface for mounting is limited; minimum of 9.38" depth recommended · easy one-handed adjustment; vertical range of motion of 5.73 · tray tilt range +10 degree to -20 degree · unit swivels side-to-side · tray size is 21.75" wide x 11" deep · wood tray requires finish selection; see component finishes for the selection 								

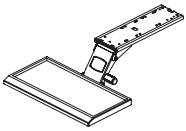
	Articulating Keyboard Tray	14	23	7	15	2	AK4	\$580
<ul style="list-style-type: none"> · trackless articulating keyboard tray - black color · mouse tray included · use when depth under work surface for mounting is limited; minimum of 9.38" depth recommended · easy one-handed adjustment; vertical range of motion of 5.73 · tray tilt range +10 degree to -15 degree · unit swivels side-to-side · tray size is 19.4" wide x 9.4" deep · tray includes palm rest · tray is made with recyclable high density polyethylene 								

	Keyboard Tray Mouse Pad	8	8	1/4	2		MT4	\$195
<ul style="list-style-type: none"> · adjusts for user comfort · 8" x 8" · for left or right hand operation · compatible with AK4 Keyboard Drawer only 								

FLUX - ACCESSORIES

Description	D	W	H	CTN WT	CU FT	① Model	List Price
-------------	---	---	---	-----------	----------	---------	------------

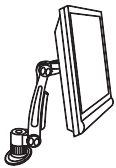
 <p>Monitor Support Arm</p> <ul style="list-style-type: none"> · 360 degree swivel · adjusts height, tilt and distance of monitor screen to user · integrated cable management · grommet and edge clamp mount included · black finish · monitor not included · will fit monitors made to the VESA standard of 75 mm or 100 mm hole spacing in a square configuration 	12	6	17	9		AMA3B	\$646
---	----	---	----	---	--	-------	-------

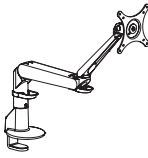
 <p>Monitor Arm - Edge Mount</p> <p>Features:</p> <ul style="list-style-type: none"> · mounts to edge of worksurface <p>Options:</p> <ul style="list-style-type: none"> · silver or black 				9	1	GP5901MA	\$688
---	--	--	--	---	---	----------	-------

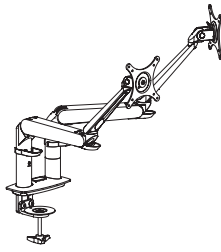
 <p>Dual Monitor Arm - Edge Mount</p> <p>Features:</p> <ul style="list-style-type: none"> · mounts to edge of worksurface · supports two monitors <p>Options:</p> <ul style="list-style-type: none"> · silver or black 				18	2	GP5902MA	\$1,239
--	--	--	--	----	---	----------	---------

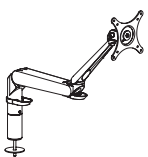
 <p>Monitor Arm</p> <p>Features:</p> <ul style="list-style-type: none"> · mounts through hole in worksurface · field drilled and field installed · supports up to 12 lbs and/or 27" monitor <p>Options:</p> <ul style="list-style-type: none"> · silver or black 				9	1	GP5905MA	\$767
--	--	--	--	---	---	----------	-------

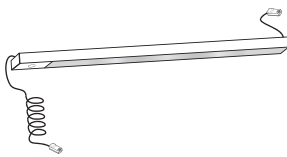
 <p>LED Tasklight</p> <p>Features:</p> <ul style="list-style-type: none"> · low profile LED tasklight · toggle on and off switch · 4000K cool white · recommended tasklight length for each cabinet size; see chart on page 31 · 13ft cord 	1/2	60	3/4	3	1	TL60LEDF	\$337
	1/2	45	3/4	3	1	TL45LEDF	\$290
	1/2	39	3/4	3	1	TL39LEDF	\$257
	1/2	27	3/4	3	1	TL27LEDF	\$327

To Order, Specify:

① Model Number	
----------------	--

FLUX - ACCESSORIES

Description	D	W	H	CTN WT	CU FT	① Model	List Price
-------------	---	---	---	-----------	----------	---------	------------

Center Drawer	16	22	1 1/2	8	3	1622CD	\$316
---------------	----	----	-------	---	---	--------	-------

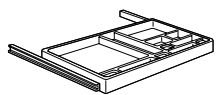

- non-locking

Wide Pencil Drawer	19 1/4	22	1 7/8	5	1	GP2219CD	\$125
--------------------	--------	----	-------	---	---	----------	-------

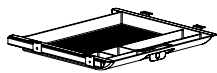

- plastic

Pencil Drawer	19 1/4	16 1/8	2 3/8	4	1	GP1619CD	\$115
---------------	--------	--------	-------	---	---	----------	-------



- plastic

Center Nook Drawer	8 1/4	15 1/4	2	2	1	GP1509CD	\$110
--------------------	-------	--------	---	---	---	----------	-------

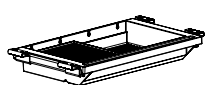

- plastic

Worksurface Power	2 5/8	6 3/8	3	3	1	EC26	\$516
-------------------	-------	-------	---	---	---	------	-------

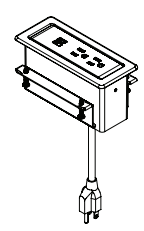

- two power receptacles - 120 volt; 15 amp dual powered USB
- 120" power cord with molded plug
- White (W) or Black (B) finish available, specify when ordering
- UL recognized
- meets UL spill requirements

Edge Mount Power	3 1/2	5 1/2	7 1/2	3	1	EC28	\$414
------------------	-------	-------	-------	---	---	------	-------

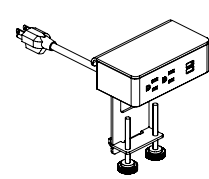

- two power receptacles - 120 volt; 15 amp dual powered USB
- 72" power cord with molded plug
- White (W) or Black (B) finish available, specify when ordering
- UL recognized

FLUX - ACCESSORIES

Description	D	W	H	CTN WT	CU FT	① Model	List Price
Wireless Charging Unit	3½	3½	1	3	1	EC33	\$337

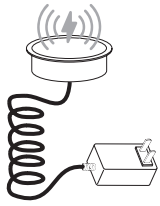

- Features:**
- wireless charging for use with Q enabled devices
 - 72" power cord
 - black
 - UL Listed
 - CE / FCC certified

Under Surface Convenience Power Unit	3½	7½	2½	3	1	EC34	\$294
--------------------------------------	----	----	----	---	---	------	-------

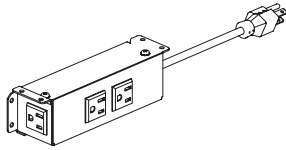

- Features:**
- three outlets
 - 120" power cord
 - black
 - ETL Listed for US

To Order, Specify:

① Model Number

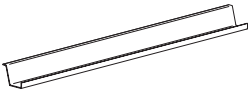
Description	D	W	H	CTN WT	CU FT	① Model	List Price
 <p>Metal Wire Manager</p>	3 3/16	80	2 13/16	10	6	FLB0480MWM	\$546
	3 3/16	74	2 13/16	9	6	FLB0474MWM	\$535
	3 3/16	68	2 13/16	9	5	FLB0468MWM	\$488
	3 3/16	62	2 13/16	8	4	FLB0462MWM	\$474
	3 3/16	56	2 13/16	7	4	FLB0456MWM	\$449
	3 3/16	50	2 13/16	7	4	FLB0450MWM	\$397
	3 3/16	44	2 13/16	6	4	FLB0444MWM	\$377
	3 3/16	38	2 13/16	5	3	FLB0438MWM	\$369
	3 3/16	32	2 13/16	4	2	FLB0432MWM	\$362

Features:

- to be used with peninsula and runoff desks; see chart on pages 48-49 for appropriate size to be used
- 3 gauge steel mounting plate

FLUX - ACCESSORIES

Flexible Wire Manager - Surface to Surface	1	2	30	4	1	GP230VWM	\$196
---	---	---	----	---	---	----------	-------



- 30" flexible vertical wire manager with one vertical mounting bracket and one magnetic attachment bracket
- black with silver accents

Flexible Wire Manager - Surface to Surface	1	2	40	4	1	GP240VWM	\$252
---	---	---	----	---	---	----------	-------



- 40" flexible vertical wire manager with one vertical mounting bracket and one magnetic attachment bracket
- black with silver accents

Flexible Wire Manager - Surface to Floor	1	2	50	12	1	GP250VWM	\$302
---	---	---	----	----	---	----------	-------



- 50" flexible vertical wire manager with one vertical mounting bracket and one counter weight base
- black with silver accents

Description	D	W	H	CTN WT	CU FT	❶ Model	List Price
Portable Slide on Screen	1	24	21 ½	10	2	GPB2422PDP	\$831

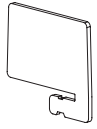

Features:

- works with any surface material
- works in any location, with the exception of where tilt release paddle is located on tilting tables

Options:

- Specify Ash Grey (ASH) or Silver Grey (SIL)

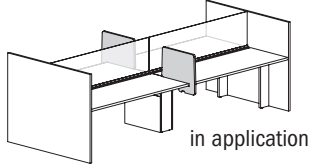

To Order, Specify:

❶ Model Number