

# ANTHOLOGY

---

planning guide +  
pricelist

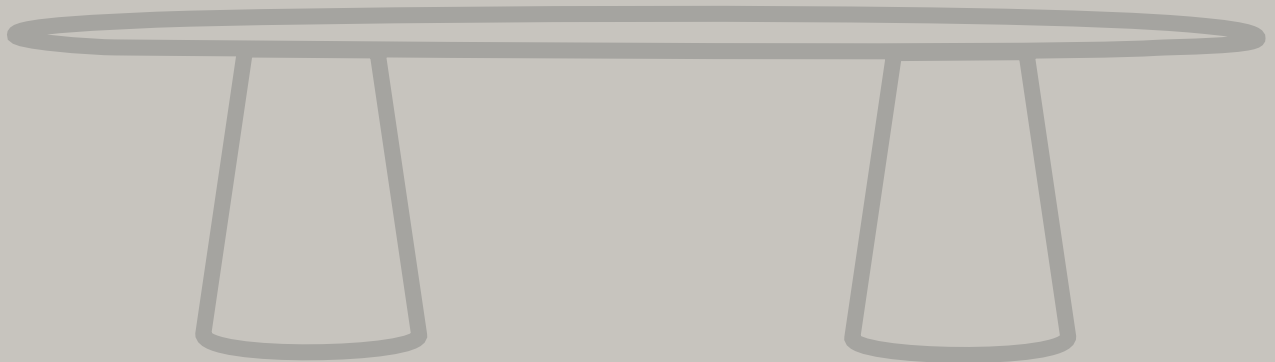

# Statement of Line

## Table Tops



Rectangular



Soft Rectangular



Arc Rectangular



Boat

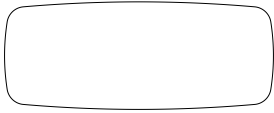

Arc Boat



Racetrack

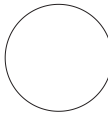

Round

## Table Base Kits

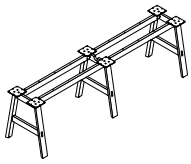

Bridge

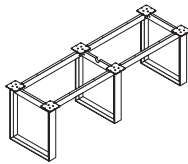

Bevel

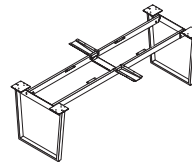

Frame BridgeLine

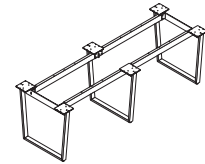

Frame

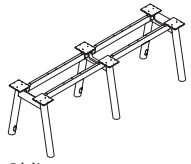

Oblique

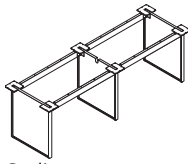

Outline

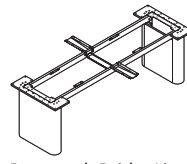

Racetrack BridgeLine

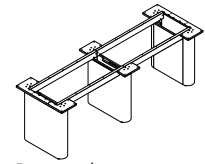

Racetrack

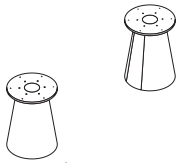

Conical

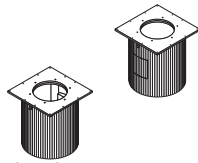

Fluted

## Single Table Bases



Conical

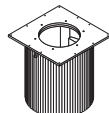

Fluted

## Power Table Bases

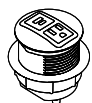

Node

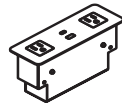

Electrolite



Ellora

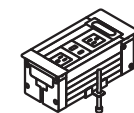

Vault Z23



M2X

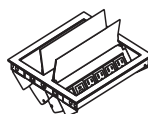

Ellora Double

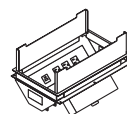

Oasis

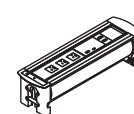

Vault BTC

# Statement of Line

## Credenzas

---

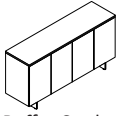

Buffet Credenza with Base

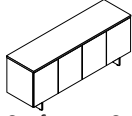

Conference Credenza with Base

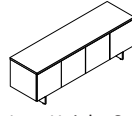

Low Height Credenza with Base

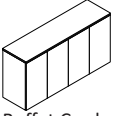

Buffet Credenza

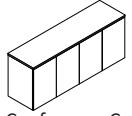

Conference Credenza

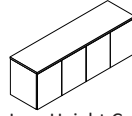

Low Height Credenza

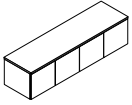

Wall Mount Credenza

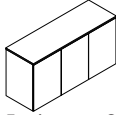

Equipment Credenza

## Power Credenzas

---

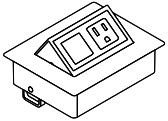

Glenbeigh

## Table of Contents: Planning Guide

Pg. 5	<b>Specification Overview</b>
Pg. 6	<b>Table Top Specification</b>
Pg. 7	<b>Base Specification - Bevel Base Kit</b>
Pg. 8	<b>Base Specification - Bridge Base Kit</b>
Pg. 9	<b>Base Specification - Conical Single Base &amp; Conical Base Kit</b>
Pg. 10	<b>Base Specification - Fluted Cylinder Single Base &amp; Fluted Cylinder Base Kit</b>
Pg. 11	<b>Base Specification - Frame Base Kit</b>
Pg. 12	<b>Base Specification - Frame BridgeLine Base Kit</b>
Pg. 13	<b>Base Specification - Oblique Base Kit</b>
Pg. 14	<b>Base Specification - Outline Base Kit</b>
Pg. 15	<b>Base Specification - Racetrack Base Kit</b>
Pg. 16	<b>Base Specification - Racetrack BridgeLine Base Kit</b>
Pg. 17	<b>Seating Capacity</b>
Pg. 18	<b>Base Placement Dimensions</b>
Pg. 20	<b>Table Top Overview</b>
Pg. 21	<b>Power Types &amp; Cutout Locations</b>
Pg. 22	<b>Cutout Location Guide: Grommet Dimension Center</b>
Pg. 23	<b>Cutout Location Guide: Grommet Dimension Ends</b>
Pg. 24	<b>Cutout Location Guide: Grommet Dimension Center &amp; Ends</b>
Pg. 25	<b>Cutout Location Guide: Grommet Dimension Mid</b>



## Table of Contents: Planning Guide

Pg. 26	<b>Cutout Location Guide: Grommet Dimension Center &amp; Mid</b>
Pg. 27	<b>Table Top Power Options - Bevel Base Kit, Bridge Base Kit, Outline Base Kit</b>
Pg. 28	<b>Table Top Power Options - Bridge Base Kit</b>
Pg. 29	<b>Table Top Power Options - Conical</b>
Pg. 30	<b>Table Top Power Options - Conical Base Kit</b>
Pg. 32	<b>Table Top Power Options - Fluted Cylinder Base</b>
Pg. 33	<b>Table Top Power Options - Fluted Cylinder Base Kit</b>
Pg. 35	<b>Table Top Power Options - Oblique Base Kit</b>
Pg. 38	<b>Table Top Power Options - Frame Base Kit, Racetrack Base Kit</b>
Pg. 39	<b>Table Top Power Options - Frame BridgeLine Base Kit, Racetrack BridgeLine Base Kit</b>
Pg. 40	<b>Wire Management Accessories</b>
Pg. 41	<b>Credenza Model Types and Features</b>
Pg. 44	<b>Credenza Specification Overview</b>
Pg. 46	<b>Credenza: Exterior Components</b>
Pg. 47	<b>Credenza: Interior Dimensions</b>

## Table of Contents: Price List

Pg. 12	<b>Table Tops</b>
Pg. 37	<b>Table Base Kits</b>
Pg. 58	<b>Power Table Bases</b>
Pg. 71	<b>Credenzas</b>
Pg. 77	<b>Power Credenzas</b>

## Product and Finish Information

### Exterior Wood Materials

Exterior surfaces are made from the finest selected veneers to achieve clarity and consistency in the Anthology Veneer product line. To attain a pleasing, symmetrical pattern, all cherry, maple, walnut veneers in Anthology Veneer are book-matched. All exterior solid lumber is matched to coordinate with the veneer.

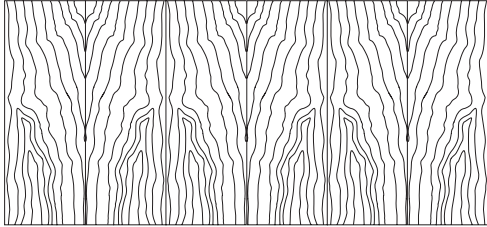

*Book-Matched Example*

Alternating pieces of veneer are flipped over so they face each other like the pages within a book

Anthology Veneer is available in flat cut cherry, maple, walnut and black oak veneer. A wide range of wood stains have been formulated to enhance the beauty of the veneer.

Double Cut veneer is another choice on Anthology Veneer product. This veneer is a processed product that has at least two cuttings to create the final veneers. These cuts of veneer strands are dyed and layered into a block to create variation of patterns from a very tight grain pattern to an exotic figure grain pattern. The diagram below show the tight pattern used on Anthology Veneer. Use the appropriate pricing column when specifying Double Cut veneer.

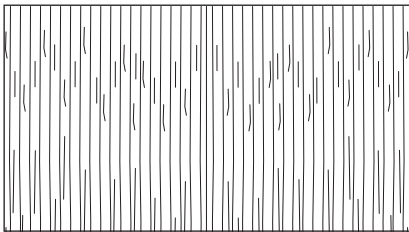

### Protective Top Coat

DuraTex™ offers exceptional hardness along with abrasion and impact resistance, it has been formulated to eliminate hazardous and harmful gases that are normally associated with wood finish.

### DuraTex™ Features

Safety- Significantly reduces hazardous formaldehyde emissions which help improve the quality of the of the indoor air we breathe.  
 Quality- Developed to be tough and durable with special attention to appearance. The DuraTex™ finish preserves the natural beauty of wood.  
 Durability- Designed to meet a wide range of demanding performance and environmental standards to withstand even the highest wear and tear.

### Finish Sheen

All veneer finishes are standard in 35-sheen, with the exception of Raven. Raven is only offered in 15-sheen. All other finishes are available in 15-sheen.

### Custom/Special Finishes

JSI, upon request, will accommodate special finishes. A written request is required to proceed with custom finish orders. A sample reference is required for first-time matches and must be included with the written request.

There is a one-time charge of **\$400 list per order** for any non-standard wood finish.

Orders will be entered noting the special finish. A sample match will be provided to the customer. Written approval is needed before the finish process can be started. Delays in approval may have an impact on lead times.

Every effort will be made to create the requested match; however, an acceptable match may not be possible because of natural variations of wood. These natural variations can also cause minor differences in the final finish product.

Use standard pricing and option pricing for each line item with a special finish, unless additional modifications have been specified. For items available in both Essential and Artisan veneers, apply the Essentials pricing.

## Product and Finish Information

---

### Laminates

Anthology Laminate features TFL (thermally fused laminate) chassis and components.

Edges of the worksurface are impact resistant (PVC) on TFL tops. The laminate is offered in 19 wood grain patterns and 7 solid colors. The wood grain laminate features an embossed grain to hide finger prints and light scratches. The solid laminate is smooth to the touch with a semi-matte finish.

### Credenza Top Surfaces

Tops have a  $\frac{3}{4}$ " top panel thickness and a .5mm edgeband.

### TFL features on Surfaces\*

- fused to the 45 pound density substrate of the top for a durable wear resistance surface
- tops are laminated on both sides
- available in all the wood grain and solid patterns

### Credenza Case Construction

Outside panels are  $\frac{3}{4}$ " and joined together with dowels reinforced with screws, and metal fasteners for increased stability. Tops are secured to the chassis with screws through pre-bored stretcher rails and pocket holes.

Cabinet doors have 110° swing hinges to allow adequate access into the interior of the cabinet.

Unfinished back, includes cutout in back side for wire management pass through.

### Locking

Locks are available per door set for \$51.

When locks are ordered, units are shipped randomly keyed as standard. Key alike units are available upon request for no additional charges. Removable cores for in-field re-keying are standard.

## Product and Finish Information

### Credenzas

#### TFL Laminates

ALB	Alabaster
BEL	Belair
BLK	Black
BRK	Brickdust
BBL	Bridal Blanco
CSK	Cask
CLY	Clay
DWH	Designer White
EGR	Egret
FAW	Fawn
FLN	Flint
FLO	Florence Walnut
LOF	Loft
MES	Mesa
MIN	Mineral
MCH	Mocha
OBK	Outback
PIL	Pilsner
PIN	Pinnacle Walnut
SHD	Shadow
SLG	Slate Grey
UMB	Umber
VAL	Valley
WLH	Walnut Heights
WEA	Weathered Ash
ZEN	Zen Grey

#### Veneer

##### ESS Essentials Veneer

BRK	Brickdust
CSK	Cask
CLY	Clay
FAW	Fawn
FLX	Flax
FLN	Flint
LOF	Loft
MES	Mesa
MIN	Mineral
MCH	Mocha
OBK	Outback
PIL	Pilsner
SIE	Sienna
TRF	Truffle
UMB	Umber
VAL	Valley

##### ART Artisan Veneer

BAR	Barrel
BUF	Buff
CND	Cinder
EGR	Egret
RAV	Raven
RYE	Rye
SAB	Sable
SAD	Saddle

##### Paint - Door Fronts ONLY-

BKD	Backdrop
BFX	Black Fox
BRV	Bravado Red
BWH	Bright White
BRF	Broccoflower
BTT	Butternut
CCY	Canyon Clay
CHT	Chatroom
DEN	Denim
GAL	Gale Force
GRV	Greek Villa
KGR	Kendal Green
NWH	Nonchalant White
NVL	Novel Lilac
PPL	Patchwork Plum
PGR	Pewter Green
QAL	Queen Anne Lilac
RPT	Redend Point
ROS	Rose Tan
SAU	Saucy Gold
SVP	Silverplate
SKS	Skyline Steel
STM	Storm
TRC	Tricorn Black
UKH	Universal Khaki
WBL	Windy Blue

#### Solid Wood

BAR	Barrel
BRK	Brickdust
BUF	Buff
CSK	Cask
CND	Cinder
CLY	Clay
EGR	Egret
FAW	Fawn
FLX	Flax
FLN	Flint
FLO	Florence Walnut
LOF	Loft
MES	Mesa
MIN	Mineral
MCH	Mocha
OBK	Outback
PIL	Pilsner
PIN	Pinnacle Walnut
RAV	Raven
RYE	Rye
SAB	Sable
SAD	Saddle
SIE	Sienna
TRF	Truffle
UMB	Umber
VAL	Valley
WLH	Walnut Heights

#### Metal Inset Base

ABZ	Aged Bronze
ASL	Arctic Silver
BWH	Bright White
GLD	Gold
MBK	Matte Black
PEW	Pewter
SBZ	Soft Bronze
SNK	Soft Nickel
CHR	Chrome - upcharge applies

#### Additional Metal Colors - upcharge applies

BRD	Beige Red (RAL3012)
CAR	Carmine Red (RAL3002)
COP	Copper Brown (RAL8004)
HYL	Honey Yellow (RAL1005)
LGR	Leaf Green (RAL6002)
MHB	Mahogany Brown (RAL8016)
MTQ	Mint Turquoise (RAL6033)
OGR	Olive Green (RAL6003)
PPV	Purple Violet (RAL4007)
QZG	Quartz Grey (RAL7039)
SAL	Salmon Orange (RAL2012)
SPB	Sapphire Blue (RAL5003)
SGR	Signal Green (RAL6032)
SIG	Signal Orange (RAL2010)
SGY	Silk Grey (RAL7044)
SKY	Sky Blue (RAL5015)
TBL	Traffice Blue (RAL5017)
TRD	Traffic Red (RAL3020)
TQP	Turquoise Pastel (RAL6034)
ZYL	Zinc Yellow (RAL1018)

## Product and Finish Information

### Laminate

#### Table Top Models

The Anthology suffix T, H or KH is used to designate laminate material.

#### Laminate Tops

Anthology features 1 1/8" thick TFL (thermally fused laminate) and 1 3/8" thick HPL (high pressure laminate) table top surfaces with PVC rim; see table top specification [ANPG\\_6](#).

#### Top Profile

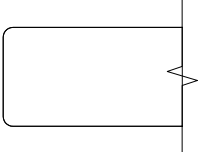

**Eased (R3)**  
suffix **T**

#### TFL Laminates

ALB	Alabaster
BBL	Bridal Blanco
BEL	Belair
BLK	Black
BRK	Brickdust
CSK	Cask
CLY	Clay
DWH	Designer White
EGR	Egret
FAW	Fawn
FLN	Flint
FLO	Florence Walnut
LOF	Loft
MES	Mesa
MIN	Mineral
MCH	Mocha
OBK	Outback
PIL	Pilsner
PIN	Pinnacle Walnut
SHD	Shadow
SLG	Slate Grey
UMB	Umber
VAL	Valley
WLH	Walnut Heights
WEA	Weathered Ash
ZEN	Zen Grey

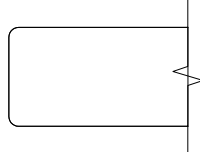

**Eased (R3)**  
suffix **H**

#### Tier 1 - HPL Laminates

ALB	Alabaster
BBL	Bridal Blanco
BEL	Belair
BLK	Black
BRK	Brickdust
CSK	Cask
CLY	Clay
DWH	Designer White
EGR	Egret
FAW	Fawn
FLN	Flint
FLO	Florence Walnut
LOF	Loft
MES	Mesa
MIN	Mineral
MCH	Mocha
OBK	Outback
PIL	Pilsner
PIN	Pinnacle Walnut
SHD	Shadow
SLG	Slate Grey
UMB	Umber
VAL	Valley
WLH	Walnut Heights
WEA	Weathered Ash
ZEN	Zen Grey

**Tier 2 Formica**  
[see page 7](#)

**Tier 2 Wilsonart**  
[see page 8](#)

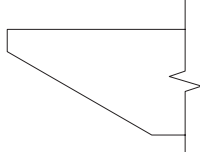

**Reverse Bevel (K9)**  
suffix **KH**

#### Tier 1 - HPL Laminates

ALB	Alabaster
BBL	Bridal Blanco
BEL	Belair
BLK	Black
BRK	Brickdust
CSK	Cask
CLY	Clay
DWH	Designer White
EGR	Egret
FAW	Fawn
FLN	Flint
FLO	Florence Walnut
LOF	Loft
MES	Mesa
MIN	Mineral
MCH	Mocha
OBK	Outback
PIL	Pilsner
PIN	Pinnacle Walnut
SHD	Shadow
SLG	Slate Grey
UMB	Umber
VAL	Valley
WLH	Walnut Heights
WEA	Weathered Ash
ZEN	Zen Grey

**Tier 2 Formica**  
[see page 7](#)

**Tier 2 Wilsonart**  
[see page 8](#)

Tier 2 Laminates require the additional specification of a PVC edge band. Choose from one of the following JSI standard options, [see page 8](#).



# Formica Laminate

**Anthology Table Tops** offer an extensive program for laminates beyond our Standard Program. Always reference below the most current listing and tier pricing when using a Graded-In Laminate; on page 8 select the color of the PVC edge color.

Laminate	Pattern-Sheen	Tier	Laminate	Pattern-Sheen	Tier	Laminate	Pattern-Sheen	Tier	Laminate	Pattern-Sheen	Tier
Acajou Mahogany	7008-58	2	Dark Chocolate	2200-58	2	Mineral Spa	6920-58	2	Slate Noir	3711-58	2
Aged Ash	8844-58	2	Denim	8822-58	2	Mission White	933-58	2	Smoke	3245-58	2
Algae	8796-58	2	Desert Beige	899-58	2	Mocha Travertine	3456-58	2	Smoke Onyx	3710-58	2
Almond	920-58	2	Dover White	7197-58	2	Mojave	8751-58	2	Smoke Quarstone	6220-58	2
Aluminum	9318-58	2	Earth	5342-58	2	Moonstone	7872-58	2	Smokey Brown Pear	5488-58	2
Amber Kashmir	6227-58	2	Earth Wash	7213-58	2	Mouse	928-58	2	Solar Orange	8235-58	2
Amber Maple	7012-58	2	Earthen Twill	8828-58	2	Muslin Fabric	6127-58	2	Sorrel Cherry	5886-58	2
Antique White	932-58	2	Earthen Warp	5880-58	2	Natural Ash	8843-58	2	Spectrum Blue	851-58	2
Argento Romano	6697-58	2	Earthenware	8241-58	2	Natural Birch	7481-58	2	Spectrum Green	7897-58	2
Artichoke	800-58	2	Earthenware	6999-58	2	Natural Canvas	7022-58	2	Spectrum Red	845-58	2
Ashwood Beige	5785-58	2	Brushstroke		2	Natural Gray Felt	4971-58	2	Stainless	9319-58	2
Ashwood Bone	5784-58	2	Ebony	9012-58	2	Natural Maple	756-58	2	Star Dune	9309-58	2
Ashwood Oak	5786-58	2	Ebony Oxide	299-58	2	Natural Oak	346-58	2	Starched Paperfold	8678-58	2
Basalt Slate	3690-58	2	Elemental Concrete	8830-58	2	Natural Recycled Kraft	9684-58	2	Stone Grafix	503-58	2
Beige Elm	5794-58	2	Elemental Stone	8831-58	2	Natural Riftwood	9282-58	2	Stop Red	839-58	2
Belmonte Granite	3496-58	2	Espresso Pear	5489-58	2	Natural Teak	8849-58	2	Storm	912-58	2
Birchbark	8684-58	2	Finnish Oak	118-58	2	Navy Blue	969-58	2	Storm Solidz	3505-58	2
Black	909-58	2	Flax Gauze	7708-58	2	Navy Grafix	7018-58	2	Storm Teakwood	8908-58	2
Black Bardiglio	5019-58	2	Flint Crystal	3518-58	2	Neo Cloud	6314-58	2	Sugar Glass	3705-58	2
Black Birchply	8552-58	2	Fog	961-58	2	Neutral Twill	8826-58	2	Surf	923-58	2
Black Recycled Kraft	9685-58	2	Folkstone	927-58	2	Neutral Weft	5875-58	2	Swede Rift Oak	8676-58	2
Black Riftwood	6414-58	2	Folkstone Celesta	692-58	2	Neutral White	918-58	2	Taupe Walnut	5787-58	2
Black Shalestone	9527-58	2	Folkstone Grafix	507-58	2	New Burgundy	7966-58	2	Terril	2297-58	2
Black Walnut	3485-58	2	Formal Walnut	5782-58	2	Night Forest	8244-58	2	Thermo Walnut	6402-58	2
Blackened Fiberwood	8916-58	2	Fossil	5349-58	2	Night Shade	8243-58	2	Travertine	3526-58	2
Blackened Legno	8848-58	2	Fox Teakwood	8907-58	2	Noble Mahogany	9236-58	2	Tula Oak	8589-58	2
Blackened Steel	8918-58	2	Geriba Gray	9308-58	2	Nocturne	5323-58	2	Venetian Gold Granite	6223-58	2
Blackstone	271-58	2	Ginger Root Maple	7288-58	2	Noir Cedar	1547-58	2	Vibrant Green	6901-58	2
Bleached Legno	8845-58	2	Glamour Cherry	6208-58	2	Noir Envision	7500-58	2	Walnut Butcherblock	3712-58	2
Blond Cedar	8576-58	2	Glass Cloth	8683-58	2	Nut Brown Cherry	5790-58	2	Walnut Fiberwood	8915-58	2
Blossom Cherrywood	758-58	2	Gold Braze	1193-58	2	Oiled Legno	8846-58	2	Walnut Riftwood	9283-58	2
Blue Felt	9320-58	2	Graphite	837-58	2	Oiled Walnut	5487-58	2	Walnut Softwood	4925-58	2
Blush	8238-58	2	Graphite Elm	5796-58	2	Orange Felt	4973-58	2	Washi Paperfold	8680-58	2
Brazilian Brown Granite	6222-58	2	Graphite Grafix	515-58	2	Origami Paperfold	8679-58	2	Waxed Maple	8905-58	2
Brite White	459-58	2	Graphite Twill	8829-58	2	Otter	3202-58	2	Weathered Ash	8842-58	2
Bronzed Steel	8919-58	2	Gray Fabric	6129-58	2	Oxidized Beamwood	9484-58	2	Weathered Fiberwood	8914-58	2
Bubble Art	8958-58	2	Gray Grafix	9300-58	2	Oyster Grey	929-58	2	Wenge Strand	6306-58	2
Buff Elm	5793-58	2	Gray Onyx	7409-58	2	Pale Brushstroke	6997-58	2	Wheat Strand	6212-58	2
Burnished Coin	3708-58	2	Grayed Oak	5791-58	2	Paloma Polar	6698-58	2	White	949-58	2
Burnished Iron	3709-58	2	Graystone	464-58	2	Patine Bronze	3707-58	2	White Ash	8841-58	2
Burnt Strand	6307-58	2	Green Felt	4974-58	2	Patine Concrete	3706-58	2	White Bardiglio	9306-58	2
Butterum Granite	7732-58	2	Green Slate	8793-58	2	Pearl	934-58	2	White Drops	8824-58	2
Camel Elm	5795-58	2	Greige Softwood	4924-58	2	Pecan Walnut	6996-58	2	White Ice Granite	9476-58	2
Cardboard Solidz	7813-58	2	Gull Grey	9242-58	2	Pecan Woodline	5883-58	2	White Marble	9310-58	2
Carrara Bianco	6696-58	2	Hard Rock Maple	86992-58	2	Pencil Wood	7747-58	2	Herringbone		2
Carrara Envision	7494-58	2	Hazel Walnut	5788-58	2	Perlato Granite	3522-58	2	White Onyx	827-58	2
Cascara Teakwood	8909-58	2	Ice Onyx	7408-58	2	Planked Coffee Oak	7413-58	2	White Painted Wood	8902-58	2
Cassia	6903-58	2	Inked Oak	5792-58	2	Planked Deluxe Pear	6206-58	2	White Pearl Cascade	3720-58	2
Ceruse Gray Walnut	6994-58	2	Ivory Kashmir	6226-58	2	Planked Raw Oak	7412-58	2	White Shalestone	9525-58	2
Chambray Fabric	6130-58	2	Jadeite	1198-58	2	Planked Urban Oak	9312-58	2	White Twill	9285-58	2
Charcoal Boomerang	6942-58	2	Jamocho Granite	7734-58	2	Platinum	902-58	2	White Washed	6372-58	2
Chelsea Maple	9238-58	2	Just Rose	8858-58	2	Portico Marble	7735-58	2	Birchply		2
Cherry Heartwood	9240-58	2	Labrador Granite	3692-58	2	Prestige Walnut	6209-58	2	Wild Cherry	5904-58	2
Cherry Walnut	6995-58	2	Layered Black Sand	9510-58	2	Pumice	858-58	2	Winter Sky	8792-58	2
Chestnut Woodline	5884-58	2	Layered Sand	9511-58	2	Purple Dye	1196-58	2	Wood Brushstroke	6998-58	2
Chrome Yellow	1485-58	2	Layered White Sand	9512-58	2	Raw Birchply	8910-58	2	Woolen Cloth	8682-58	2
Cinnamon Cherry	8955-58	2	Lime Stone	7264-58	2	Raw Cedar	1545-58	2	Yellow Felt	4972-58	2
Citadel	1097-58	2	Liquid Glass	8240-58	2	Sail White	463-58	2			
Citadel Warp	5882-58	2	Luxe Mango	8685-58	2	Sand Crystal	3517-58	2			
Classic White	9244-58	2	Macchiato Walnut	6932-58	2	Sand Maple	9237-58	2			
Clementine	2962-58	2	Maple Woodline	6925-58	2	Sarum Grey	2770-58	2			
Clove Spice Cherry	5789-58	2	Marine Blue	914-58	2	Sarum Twill	8827-58	2			
Cocoa Maple	7739-58	2	Marmara Beige	7406-58	2	Scandi Rift Oak	8677-58	2			
Cocoa Oak	9374-58	2	Marmara Gray	7407-58	2	Sea Salt	9529-58	2			
Cognac Maple	7738-58	2	Matrix Blue	8795-58	2	Seasoned Planked Elm	6477-58	2			
Concrete Formwood	6362-58	2	Mdf Solidz	7812-58	2	Select Cherry	7759-58	2			
Concrete Stone	7267-58	2	Midnight Stone	6280-58	2	Sheer Fabric	6126-58	2			
Cotton Cloth	8681-58	2	Milk	9634-58	2	Silver Quartzite	9497-58	2			
Cream Softwood	4923-58	2	Millennium Oak	5887-58	2	Silver Riftwood	6413-58	2			
Danish Maple	8906-58	2	Mineral Jet	3450-58	2	Silver Shalestone	9307-58	2			

## Wilsonart Laminate

**Anthology Table Tops** offer an extensive program for laminates beyond our Standard Program. Always reference below the most current listing and tier pricing when using a Graded-In Laminate; see below on the PVC edge color selection.

Laminate	Pattern-Sheen	Tier	Laminate	Pattern-Sheen	Tier	Laminate	Pattern-Sheen	Tier	Laminate	Pattern-Sheen	Tier
Almond Leather	2932-60	2	Florence Walnut	7993-38	2	Lowell Ash	7994-38	2	Port	D14-60	2
Anitique White	1572-60	2	Fonthill Pear	10745-60	2	Mangalore Mango	7984-38	2	Pressed Linen	4991-38	2
Anzio Marble	5037-38	2	Forged Steel	4995-60	2	Manitoba Maple	7911-60	2	Raw Cotton	4947-38	2
Atlantis	D25-60	2	Fossil Shale	D504-60	2	Midnight	D505-60	2	River Cherry	7937-38	2
Bannister Oak	7806-60	2	French Linen	5016-38	2	Mission Maple	7990-38	2	Rustic Slate	4888-38	2
Beige	1530-60	2	French Pear	8220-38	2	Misted Zephyr	4843-60	2	Sable Soapstone	4883-38	2
Beigewood	7850-60	2	Frosty White	1573-60	2	Monticello Maple	7925-38	2	Sap Walnut	8221-38	2
Boardwalk Oak	7983-38	2	Fusion Maple	7909-60	2	Morelia Maple	7985-38	2	Shadow Zephyr	4857-60	2
Brazilwood	7946-38	2	Graphite	10657-60	2	Morro Zephyr	4846-60	2	Sheer Mesh	4876-38	2
Brittany Blue	D321-60	2	Graphite Nebula	4623-60	2	Natural Almond	D30-60	2	Sierra Cascade	5005-38	2
Bronze Legacy	4656-60	2	Green Tigris	4667-60	2	Natural Cotton	4946-38	2	Silicon Ev	4811-60	2
Buka Bark	7982-38	2	Grey	1500-60	2	Natural Recon	7996-38	2	Solar Oak	7816-60	2
Burnished Chestnut	4796-60	2	Grey Glace	4142-60	2	Natural Rift	7954-38	2	Steel Mesh	4879-38	2
Candy Apple	13096-60	2	Grey Mesh	4877-38	2	Natural Tigris	4669-60	2	Sterling Ash	7995-38	2
Canyon Zephyr	4842-60	2	Grey Nebula	4622-60	2	Navy Legacy	4651-60	2	Sunny Side Up	13089-60	2
Carbon Ev	4820-60	2	Grey Pampas	4168-60	2	Neo Walnut	7991-38	2	Tailored Linen	4992-38	2
Carbon Mesh	4880-60	2	Gumball	13102-60	2	Neutral Glace	4143-60	2	Titanium EV	4810-60	2
Castle Oak	7928-38	2	Handspun Chestnut	5036-38	2	New Age Oak	7938-38	2	Tungsten EV	4814-60	2
Casual Linen	4944-38	2	Handspun Dove	5034-38	2	Nordic Linen	5015-38	2	Tuscan Walnut	7921-38	2
Catalina	13092-60	2	Handspun Pearl	5033-38	2	Nori	13091-60	2	Twilight Zephyr	4845-60	2
Cement	D503-60	2	Hanspun Slate	5035-38	2	North Sea	D90-60	2	Wallaby	D439-60	2
Centizo Cherry	8239-38	2	Harvest Maple	7953-38	2	Norwegian Ash	8241-38	2	Washi Crystal	5017-38	2
Classic Linen	4843-38	2	high Rise	4996-38	2	Oiled Soapstone	4882-38	2	Washi Pewter	5018-38	2
Cloud Nebula	4830-60	2	Hollyberry	D307-60	2	Orange Grove	D501-60	2	White	1570-60	2
Cloud Zephyr	4856-60	2	Huntington Mplae	7929-38	2	Organic Cotton	4945-38	2	White Carrara	4924-38	2
Coffee Bean	D495-60	2	Indigo	D379-60	2	Palisades Oak	7987-38	2	White Cascade	5003-38	2
Crisp Linen	4942-38	2	Invory Birch	8219-38	2	Pampas	4170-60	2	White Nebula	4621-60	2
Crystal	D388-60	2	Jubilee Oak	8242-38	2	Pasadena Oak	7966-38	2	White Sand	D403-60	2
Desert Zephyr	4841-60	2	Kensington Maple	10776-60	2	Pearl Soapstone	4886-38	2	White Tigris	4783-60	2
Dove Grey	D92-60	2	Khaki Brown	D50-60	2	Pepperdust	D327-60	2	Wild Cherry	7054-60	2
Dragon Fly	13088-60	2	Kingswood Walnut	8218-38	2	Pewter	D73-60	2	Windswept Pewter	4795-60	2
Ebony Recon	7997-38	2	Lapis Blue	D417-60	2	Pewter Brush	4779-60	2	Woolamai Brush	4746-60	2
Evening Tigris	4674-60	2	Limber Maple	10734-60	2	Pewter Mesh	4878-38	2			
Fashion Grey	D381-60	2	Linen	D427-60	2	Pinnacle Walnut	7992-38	2			
Flax Linen	4930-38	2	Loden Zephyr	4844-60	2	Platinum	D315-60	2			

### PVC Edge Selection

Tier 2 Laminates require the additional specification of a PVC edge band. Choose from one of the following JSI standard options.

ALB	Alabaster	MES	Mesa
BEL	Belair	MIN	Mineral
BLK	Black	MCH	Mocha
BRK	Brickdust	OBK	Outback
BBL	Bridal Blanco	PIL	Pilsner
CSK	Cask	PIN	Pinnacle Walnut
CLY	Clay	SHD	Shadow
DWH	Designer White	SLG	Slate Grey
EGR	Egret	UMB	Umber
FAW	Fawn	VAL	Valley
FLN	Flint	WLH	Walnut Heights
FLO	Florence Walnut	WEA	Weathered Ash
LOF	Loft	ZEN	Zen Grey



# Product and Finish Information

## Veneer

### Table Models

The Anthology suffix V or KV is used to designate veneer material.

### Veneer Tops

Anthology features 1 3/8" thick veneer table top surfaces in several rim and finish options; see table top specification [ANPG\\_6](#).

### Top Profile

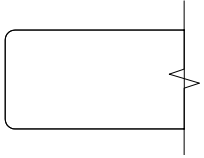

Eased (R3)

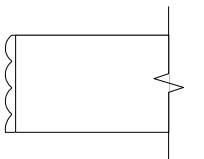

Reeded (H3)

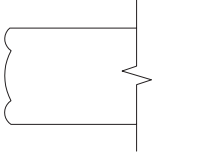

Transitional (C3)  
suffix V

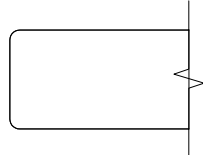

Eased (R3)

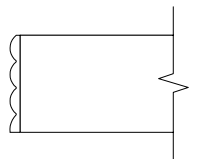

Reeded (H3)

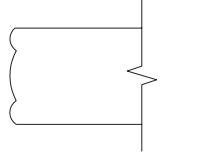

Transitional (C3)  
suffix V

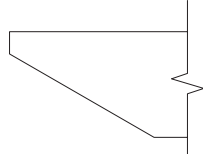

Reverse Bevel (K9)  
suffix KV

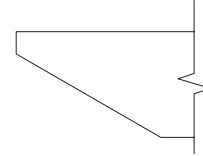

Reverse Bevel (K9)  
suffix KV

### ESS Essentials Veneer

BRK	Brickdust
CSK	Cask
CLY	Clay
FAW	Fawn
FLX	Flax
FLN	Flint
LOF	Loft
MES	Mesa
MIN	Mineral
MCH	Mocha
OBK	Outback
PIL	Pilsner
SIE	Sienna
TRF	Truffle
UMB	Umber
VAL	Valley

### ART Artisan Veneer

BAR	Barrel
BUF	Buff
CND	Cinder
EGR	Egret
RAV	Raven
RYE	Rye
SAB	Sable
SAD	Saddle

### ESS Essentials Veneer

BRK	Brickdust
CSK	Cask
CLY	Clay
FAW	Fawn
FLX	Flax
FLN	Flint
LOF	Loft
MES	Mesa
MIN	Mineral
MCH	Mocha
OBK	Outback
PIL	Pilsner
SIE	Sienna
TRF	Truffle
UMB	Umber
VAL	Valley

### ART Artisan Veneer

BAR	Barrel
BUF	Buff
CND	Cinder
EGR	Egret
RAV	Raven
RYE	Rye
SAB	Sable
SAD	Saddle

## Specification Overview

### TABLE TOPS, BASES, AND POWER COMPONENTS ARE ORDERED SEPARATELY

#### SELECT TOP MATERIAL

Choose between TFL with eased pvc rim, HPL with eased or reverse bevel pvc rim, and Veneer with eased, reeded, transitional, or reverse bevel veneer edge band.

#### SELECT TOP SIZE AND SHAPE

Options include, rectangular, soft rectangular, arc rectangular, boat, arc boat, racetrack, and round. Sizes range from 36" –60" depth and 72" –240" width in 6" increments to accommodate various room sizes.

#### SELECT BASE STYLE AND FINISH

- Bevel, Bridge, and Fluted Cylinder solid wood bases.
- Conical and Racetrack HPL and Veneer bases.
- Outline TFL and Veneer bases.
- Oblique Metal powdercoat bases.
- Frame and Frame BridgeLine metal powdercoat and chrome bases.
- Racetrack and Racetrack BridgeLine HPL and Veneer bases.

**For ease of specification bases are sold in kits aligned to specific top sizes. The base kit is a complete set of bases, mounting brackets, screws, along with stretcher rails and undersurface metal support as required for applicable top sizes.**

#### SELECT THE POWER MODULES

Options for power include:

Electrolite, Ellora, Ellora Double, M2X, Node, Oasis, Vault Z23 Retractable, and Vault BTC Rotating. A broad selection of performance features support small to large power requirements including USB A+C.

Selected models are available with corded plug, hardwire, or one-, two-, three-, and four-unit kits linked together with a single plug. Kits include power units, jumpers, power infeed, and all applicable parts to simplify specification. Kits are specific to table width.

**Anthology tops and bases are designed to be specified together as per the application guidelines listed in the pricing section. They are not to be used with tops and bases from other series.**

## Table Top Specification

### PRODUCT SPECIFICATIONS

Top shapes are available in rectangular, soft rectangular, arc rectangular, boat, arc boat, racetrack, and round. Sizes range from 36" – 60" depth and 72" – 240" width in 6" increments.

### TOPS ARE BALANCED CONSTRUCTION AVAILABLE IN

- TFL (thermally fused laminate) 1 1/8" thick particle board core with 3mm PVC Eased (R3) rim.
- HPL (high pressure laminate) 1 3/16" thick particle board core with 3mm PVC Eased (R3) rim.
- HPL (high pressure laminate) 1 3/16" thick MDF core with 1mm PVC Reverse Bevel (K9) rim. Underside of bevel is painted to match PVC rim.
- Veneer 1 3/16" thick particle board core with 3mm veneer edge band in Eased (R3), Reeded (H3), or Transitional (C3) rims.
- Veneer 1 3/16" thick MDF with 1mm edge band Reverse Bevel (K9). Underside of bevel is finished to match surface and edge band.
- Tops are rimmed on all sides.
- TFL and HPL tops are standard with PVC rim to match the top color.
- Veneer tops are standard with edge band stained to match top.
- HPL tops are available with an extended laminate offering (Tier 2) from Formica and Wilsonart. Customer will select the PVC edge color.
- Grain direction for TFL, HPL, and Veneer runs with the width of the top (left to right).
- Great care is taken to align multi-piece laminate woodgrain tops as closely as possible at the seams. However; due to the natural pattern variations and manufacturing tolerances, a perfect grain match cannot be guaranteed.
- See pricing pages for top sections by model.
  - 72" – 96" widths – one piece top
  - 102" – 120" widths – one- and two-piece tops
  - 126" – 192" – two-piece tops
  - 198 – 240" – 3 equal piece tops
- Multiple piece tops ship with joint connectors and biscuits to align and draw table sections together at the seams. Hardware to attach tops to bases, ship with the base or base kits.

## Base Specification

### BEVEL BASE KIT

Available in maple, oak, and walnut solid wood. Wood species aligns with respective finish.

1. Base is 27 7/8" high, 29" with 1 1/8" top.
2. Base kits are specific to top depth and width, and come in two-, three-, and four-base configurations. Supports top sizes 36"-60" depth and 72"-240" width.
3. Base depths are 18", 24", and 30". Individual base dimensions are 4" wide x 1 3/8" thick.
4. Metal mounting plates, with hardwood end and center rails.
5. Center bases have a 2" diameter cord pass through for routing cords base to base under the table top.
6. Veneer side stretcher rails, 3" high x 1 1/8" deep will match base finish.
7. Base includes levelers.
8. Attachment hardware for top ships with base.
9. Order cord management to floor separately.

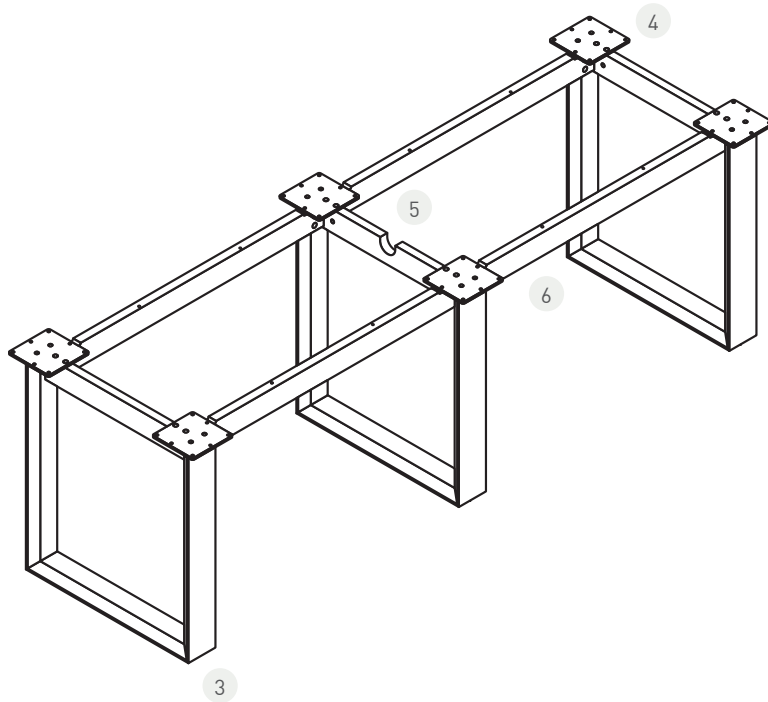

## Base Specification

### BRIDGE BASE KIT

Available in maple, oak, and walnut solid wood. Wood species aligns with respective finish.

1. Base is 27 7/8" high, 29" with 1 1/8" top.
2. Base kits are specific to top depth and width, and come in two-, three-, and four-base configurations. Supports top sizes 36"-60" depth and 72"-240" width.
3. Base depths are:
  - 24" at bottom, 14 3/8" at top
  - 30" at bottom, 20 3/8" at top
  - 36" at bottom, 26 3/8" at top
4. Individual base dimensions are 3" wide, 3/8" thick. Horizontal rail is 3" high x 1" thick.
5. Center bases have a 2" diameter cord pass through for routing cords base to base under the table top.
6. Veneer side stretcher rails, 3" high x 1 1/8" deep will match base finish.
7. Metal mounting plates, with hardwood end and center rails.
8. Attachment hardware for top ships with base.
9. Base includes levelers.
10. Order cord management to floor separately.

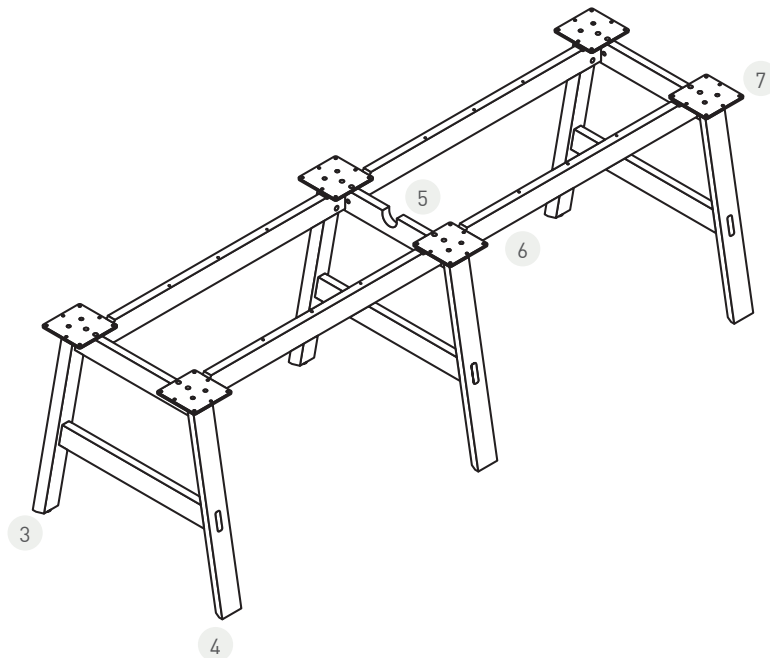

## Base Specification

### CONICAL SINGLE BASE & CONICAL BASE KIT

Available in HPL and Veneer surfaces. Grain runs vertical.

1. Base is 27 7/8" high, 29" with 1 1/8" top.
2. Single bases are for use with round tops from 36" -60". Available with or without access for cable management.
3. Base kits are specific to top depth and width, and come in two-, three-, and four-base configurations. Supports top sizes 42"-60" depth and 102" -240" width. Base kits come standard with a combination of access and non access doors. Access base can be in any base location to accommodate floor power.
  - 2 base kits include 1 access and 1 non access base
  - 3 base kits include 1 access and 2 non access bases
  - 4 base kits include 2 access and 2 non access bases
4. All 20" diameter bases are 20" at bottom and taper to 12" at top. Cable management opening is 6" at top and 9" at bottom.
5. All 24" diameter bases are 24" at bottom and taper to 16" at top. Cable management opening is 9" at the top and bottom.
6. All models have a cord pass through at upper side of base for routing cords base to base under the table top. Opening is 1 5/8" wide x 2 1/4" high (not visible on line art below.)
7. Quick release removable access panel.
8. The counterweight will be included and will ship with the following bases:
  - Single base for 36" -60" round tops.
  - Base kits for 42" -48" depth and 102" -240" width tops.
9. Black particle board mounting pad with a attachment hardware for top ships with base.
10. Base includes levelers.
11. Selected models ship with metal support that runs with width of base where required.

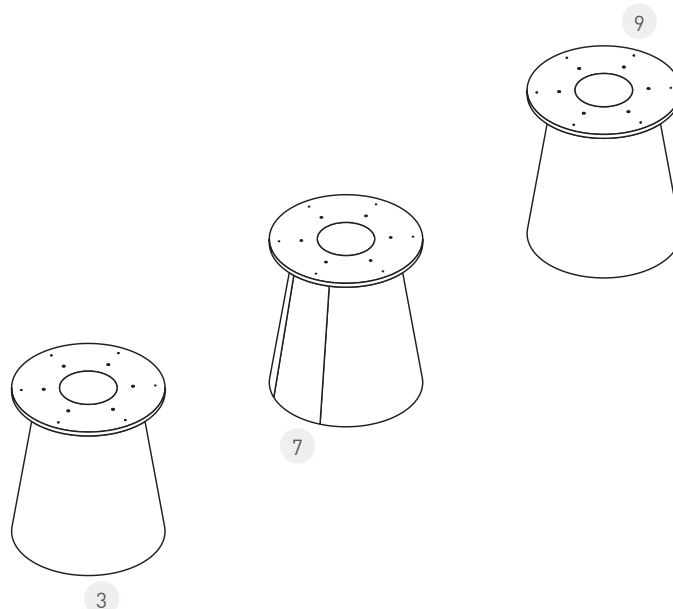

## Base Specification

### FLUTED CYLINDER SINGLE BASE & FLUTED CYLINDER BASE KIT

Available in maple, oak, and walnut fluted solid wood. Wood species will align to respective finish. Grain runs vertical.

1. Base is 27 7/8" high, 29" with 1 1/8" top.
2. Single bases are for use with round tops from 36" -60". Available with or without access for cable management.
3. Base kits are specific to top depth and width, and come in two-, three-, and four-base configurations. Supports top sizes 42"-60" depth and 102" -240" width. Base kits come standard with a combination of access and non access doors. Access base can be in any base location to accommodate floor power.
  - 2 base kits include 1 access and 1 non access base
  - 3 base kits include 1 access and 2 non access bases
  - 4 base kits include 2 access and 2 non access bases
4. All 18 model bases are 19 1/8" diameter with fluted profile. Cable management opening is 11 1/2" diameter at top 7" diameter at bottom.
5. All 24 model bases are 24 5/8" diameter with fluted profile. Cable management opening is 15" diameter at the top and 9" diameter at bottom.
6. All models have a cord pass through at upper side of base for routing cords base to base under the table top. Opening is 1 5/8" wide x 2 1/4" height.
7. Access base has a 10" x 10" square hinged door.
8. The counterweight will be included and will ship with the following bases:
  - Single base for 36" -60" round tops.
  - Base kits for 42" -48" depth and 102" -240" width tops.
9. Black particle board mounting pad with a attachment hardware for top ships with base.
10. Base includes levelers.
11. Selected models ship with metal support that runs with width of base where required.

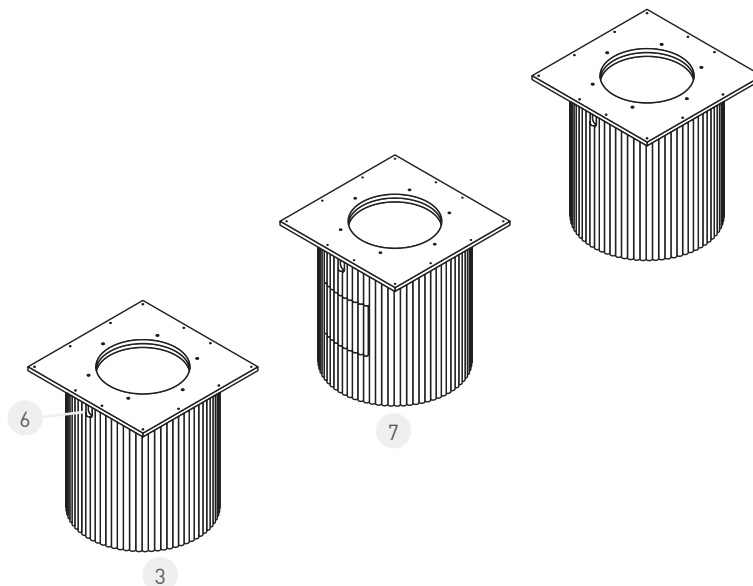

## Base Specification

### FRAME BASE KIT

Available in metal powdercoat paint and chrome finishes.

1. Base is 27 7/8" high, 29" with 1 1/8" top.
2. Base kits are specific to top depth and width, and come in two-, three-, and four-base configurations. Supports top sizes 36"-60" depth and 72"-240" width.
3. The bottom and sides of each base are 14 gauge, 2" x 1" rectangle tube.
4. Bases are tapered in design.
  - 18" depth bottom, tapers to 22 7/8" at top.
  - 24" depth bottom, tapers to 28 7/8" at top.
  - 30" depth bottom, tapers to 34 7/8" at top.
5. Metal mounting plates, and end rails are painted to match base.
6. Side stretcher rails, 3" high x 1 1/8" deep Black TFL.
7. Base includes levelers.
8. Attachment hardware for top ships with base.
9. Magnetic Metal Wire Manager sold separately.

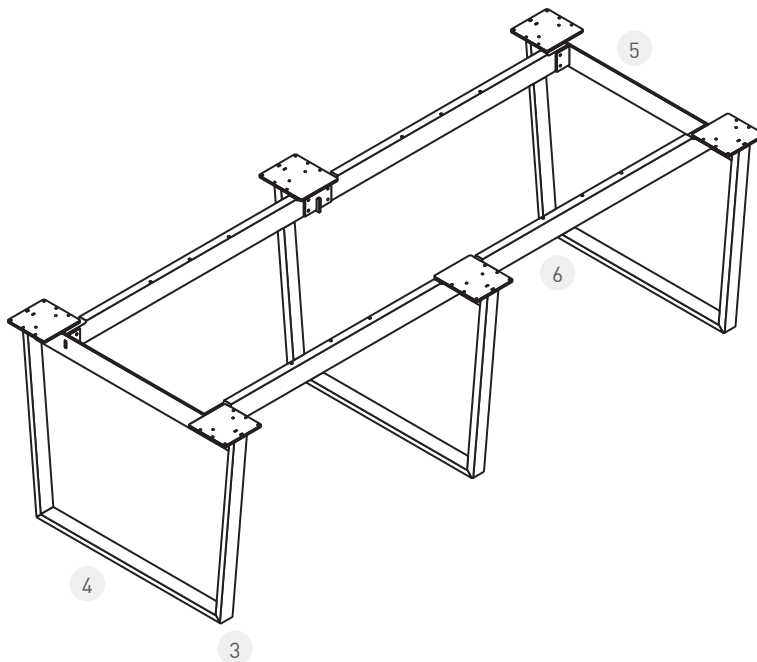



## Base Specification

### FRAME BRIDGELINE BASE KIT

Available in metal powdercoat paint and chrome finishes.

1. Base is 27 7/8" high, 29" with 1 1/8" top.
2. Base kits are specific to top depth and width, and come in two-base configurations. Supports top sizes 48", 54", 60" depth and 120" -192" width.
3. Bottom and sides of each base are 14 gauge, 2" x 1" rectangle tube.
4. Bases are tapered in design.
  - 24" depth bottom, tapers to 28 7/8" at top.
  - 30" depth bottom, tapers to 34 7/8" at top.
5. Metal mounting plates and center support structure are black. End rails are painted to match the base.
6. Two metal side beams are black 14-gauge tube, 3" high x 1" in.
7. Base includes levelers.
8. Attachment hardware for top ships with base.
9. Magnetic metal wire manager sold separately.

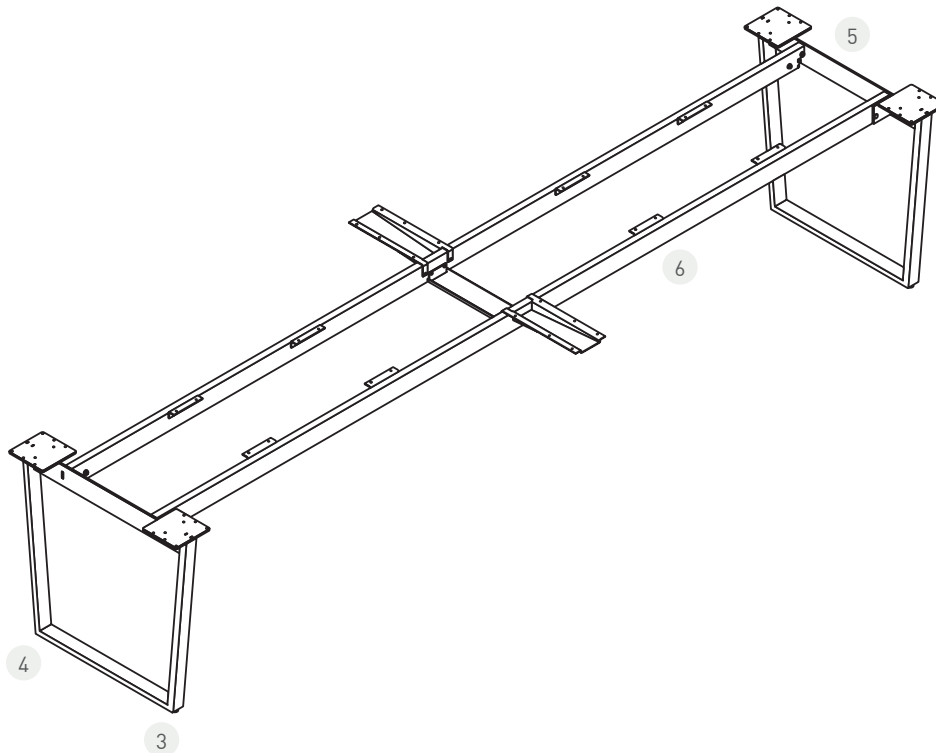

## Base Specification

### OBLIQUE BASE KIT

Available in metal standard and additional powdercoat finishes.

1. Base is 27 7/8" high, 29" with 1 1/8" top.
2. Base kits are specific to top depth and width, and come in two-, three-, and four-base configurations. Supports top sizes 36"-60" depth and 72"-240" width.
3. Legs are 14 gauge, 3" round tube.
4. Base depths are:
  - 24" models are 27" at bottom, 17 3/8" at top.
  - 30" models are 33" at bottom, 23 3/8" at top.
  - 36" models are 39" at bottom, 29 3/8" at top.
5. Center bases allow cord pass through for routing cords base to base under the table top.
6. Metal mounting plates, and end rails are painted to match the base.
7. Side stretcher rails, 3" high x 1 1/8" deep Black TFL.
8. Base includes levelers.
9. Attachment hardware for top ships with base

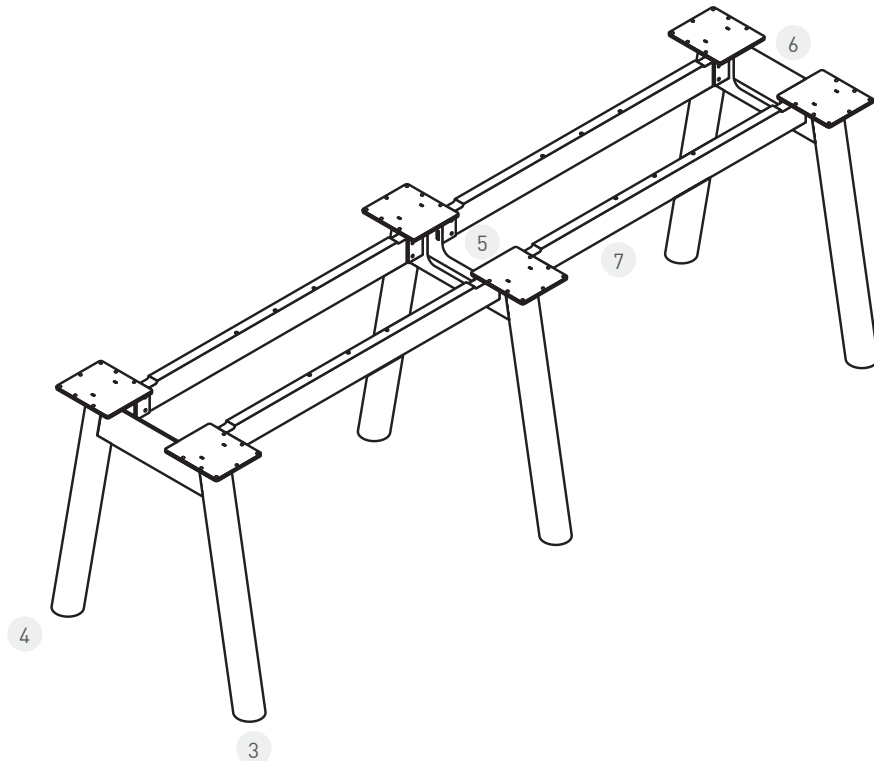

## Base Specification

### OUTLINE BASE KIT

Available in TFL and Veneer surfaces with powdercoat or chrome metal accent trim. Grain runs vertical.

1. Base is 27 7/8" high, 29" with 1 1/8" top.
2. Base kits are specific to top depth and width, and come in two-, three-, and four-base configurations. Supports top sizes 36"-60" depth and 72"-240" width.
3. Individual base depths are 18", 24", and 30". Base width is 1 1/2".
4. Base design features a 1 1/8" thick panel with a 3/4" x 1 1/2", 14-gauge metal accent trim at sides and bottom.
5. Metal mounting plates.
6. Side stretcher rails, 3" high x 1 1/8" deep and match base finish.
7. Center bases have a 1 5/8" wide x 2" high cord pass through for routing cords base to base under the table top.
8. Base includes levelers.
9. Attachment hardware for top ships with base
10. Order cord management to floor separately.

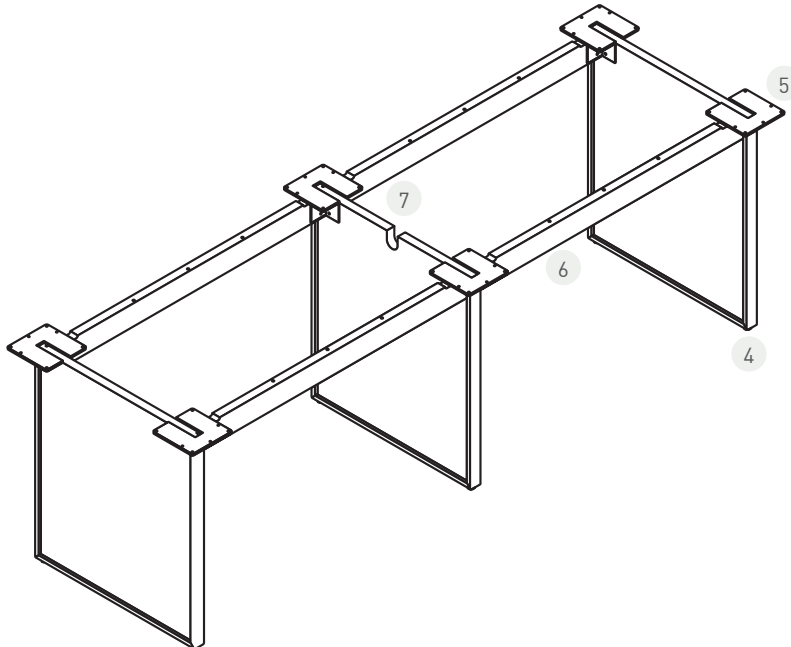

## Base Specification

### RACETRACK BASE KIT

Available in HPL and Veneer surfaces. Grain runs vertical.

1. Base is 27 7/8" high, 29" with 1 1/8" top.
2. Base kits are specific to top depth and width, and come in two-, three-, and four-base configurations. Supports top sizes 36"-60" depth and 72"-240" width.
3. Individual base depths are 18", 24", and 30". Base width is 6".
4. Interior clearances for cable management are as follows:
  - Top opening is 3 3/8" wide, bottom opening is 2 1/2" wide.
  - Top and bottom depth opening is:
    - 9 1/2" for 18" base
    - 15 1/2" for 24" base
    - 21 1/2" for 30" base
5. All bases in the kit feature a removable access panel on inside of each base. The center base can have removable access positioned in either direction.
6. Side stretcher rails, 3" high x 1 1/8" deep and match base finish.
7. Attachment hardware for top ships with base
8. Base includes levelers.

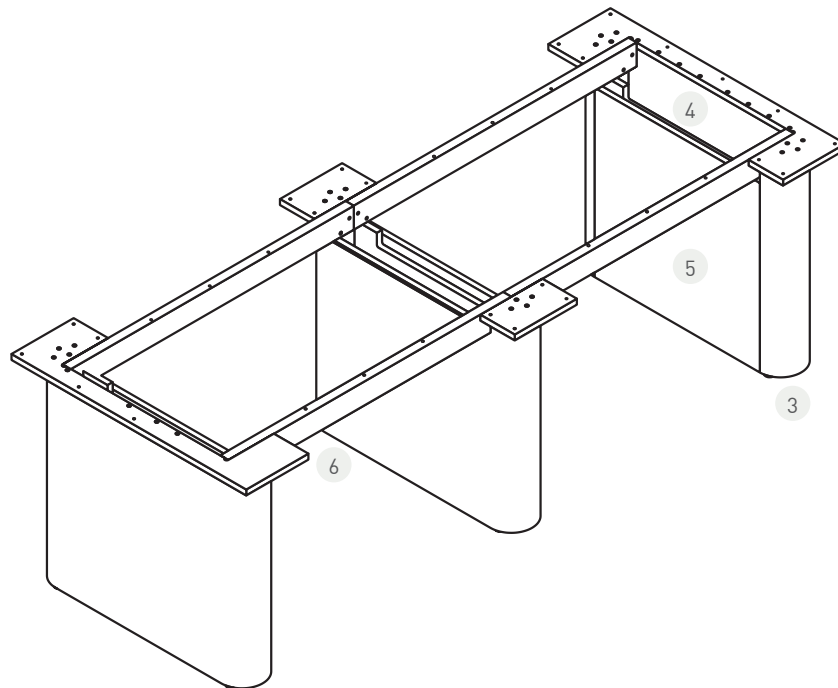

## Base Specification

### RACETRACK BRIDGELINE BASE KIT

Available in HPL and Veneer surfaces. Grain runs vertical.

1. BridgeLine Base Kits feature a patent-pending 2 base support structure.
2. Base is 27 7/8" high, 29" with 1 1/8" top.
3. Base kits are specific to top depth and width, and come in 2-base configurations. Supports top sizes 48", 54", 60" depth and 120" –192" width.
4. Individual base depths are 24" and 30". Base width is 6".
5. Interior clearances for cable management are as follows:
  - Top opening is 3 3/8" wide, bottom opening is 2 1/2" wide.
  - Top and bottom depth opening is:
    - 15 1/2" for 24" base
    - 21 1/2" for 30" base
6. Each base in the kit features a removable access door on inside of the base.
7. Mounting pads: metal center support structure and rails are black.
8. Two metal side beams are black 14-gauge tube, 3" high x 1".
9. Base includes levelers.
10. Attachment hardware for top ships with base.

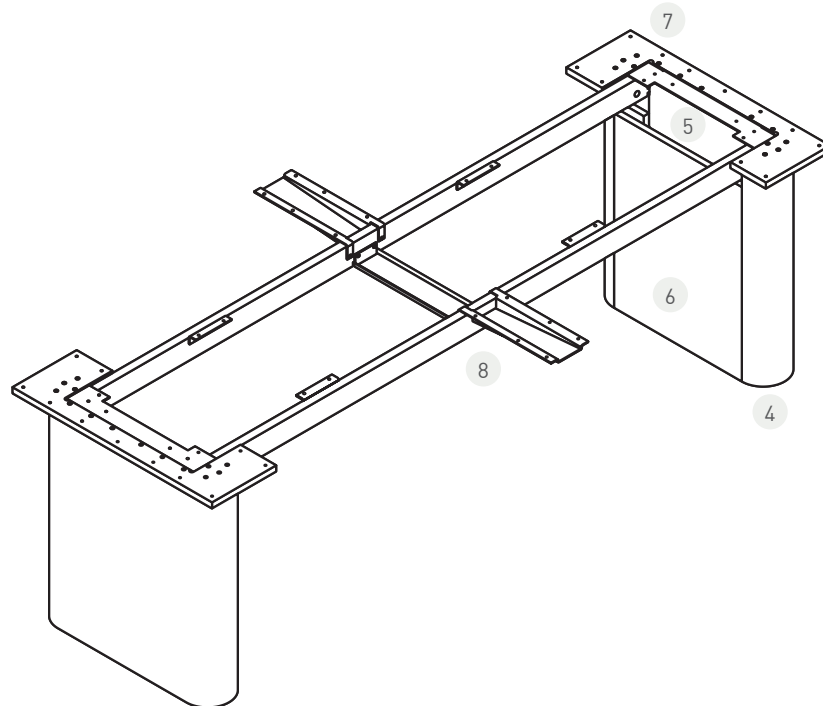

## Seating Capacity

### RECOMMENDED SEATING CAPACITY

Applies to rectangular, soft rectangular, arc rectangular, boat, arc boat, racetrack, and round.

Top Width	Depth				
	36"	42"	48"	54"	60"
36	3				
42		4			
48			4		
54				6	
60					8
72 - 90	6	6	6		
96	8	8	8		
102 - 114		8	8		
120		8	8	8	10
126 - 132			8	8	10
138 - 144			10	10	10
150 - 162			10	10	12
168 - 174			12	12	12
180 - 186			12	12	14
192 - 216			14	14	16
222			16	16	16
228 - 240			16	16	18

# Base Placement Dimensions

## BASE LOCATIONS

Base Type: Bevel, Bridge, Outline, Oblique, Frame, Frame BridgeLine, Racetrack, Racetrack BridgeLine

Applies to all top shapes and depths.

1—, Left and Right End base dimension are from the outside end of top to the outside end of base.

2—, 3—, and 4— base dimensions are to the center of the base.

Top Width	Base Quantity	1 Left and Right to Outside End of Base	2 Center of Center Base	3 Center of Mid Base	4 Center of Mid Base
72	2	12			
78	2	12			
84	2	15			
90	2	15			
96	2	18			
102	2	18			
108	2	18			
114	2	18			
120	3	18	60		
126	3	18	63		
132	3	18	66		
138	3	18	69		
144	3	18	72		
150	3	18	75		
156	3	18	78		
162	3	18	81		
168	3	18	84		
174	3	18	87		
180	3	18	90		
186	3	18	93		
192	3	18	96		
198	4	18		66	132
204	4	18		68	136
210	4	18		70	140
216	4	18		72	144
222	4	18		74	148
228	4	18		76	152
234	4	18		78	146
240	4	18		80	160

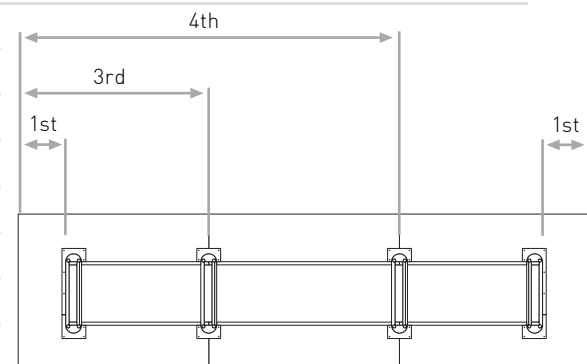
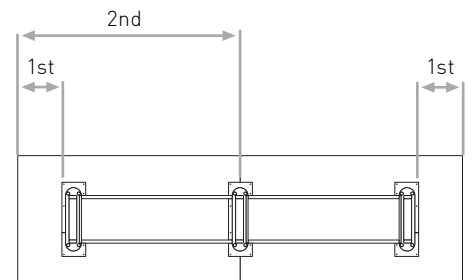
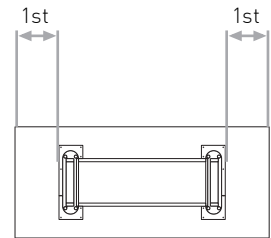

# Base Placement Dimensions

## BASE LOCATIONS

Base Type: Conical, Fluted

Applies to all top shapes and depths.

1—, Left and Right End base dimension are from the outside end of top to the center of base.

2—, 3—, and 4— base dimensions are to the center of the base.

Top Width	Base Quantity	1 Left and Right to Center End of Base	2 Center of Center Base	3 Center of Mid Base	4 Center of Mid Base
102	2	27	51		
108	2	27	54		
114	2	27	57		
120	2	27	60		
126	2	27	63		
132	2	27	66		
138	2	27	69		
144	2	27	72		
150	3	27	75		
156	3	27	78		
162	3	27	81		
168	3	27	84		
174	3	27	87		
180	3	27	90		
186	3	27	93		
192	3	27	96		
198	4	27		75	123
204	4	27		77	127
210	4	27		79	131
216	4	27		81	135
222	4	27		83	139
228	4	27		85	143
234	4	27		87	147
240	4	27		89	151

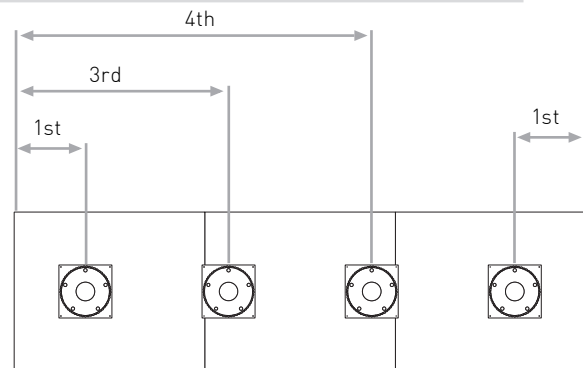
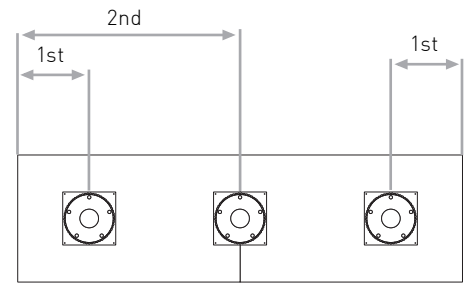
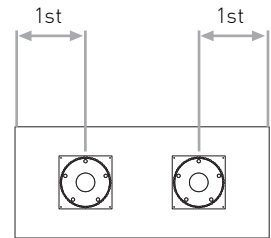



## Table Top Power Overview

Anthology Power Modules offer a broad selection of performance features to support small to large power requirements including USB A+C. Models are available as single specified units. Selected models are available as modular component system kits with a single plug.

Power modules can be integrated into table tops to provide convenient electrical access for devices. There are two main ways to connect them to the building's power:

### **DIRECT PLUG-IN:**

The power module can be connected directly to a floor monument. There must be one power outlet per single corded unit. Dual corded modules require two outlets per unit. This method requires several floor outlets to power multiple units.

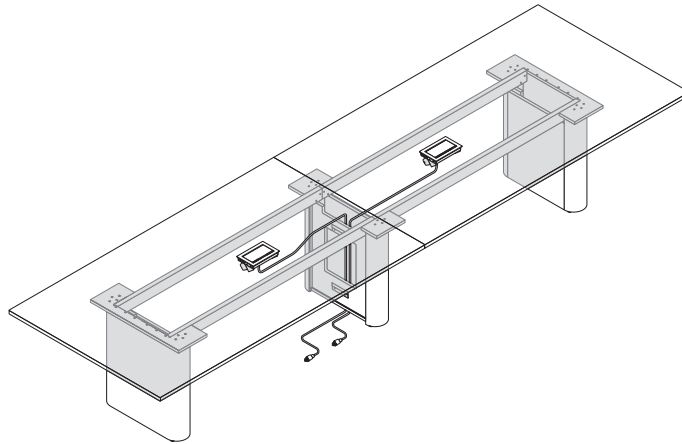

### **SINGLE PLUG-IN MODULAR COMPONENT SYSTEM:**

Several power modules are linked with a single-circuit power system. Multiple power unit kits are linked together and connect to a floor monument with a single connection. Linking systems reduces the need for multiple floor outlets and simplify installation.

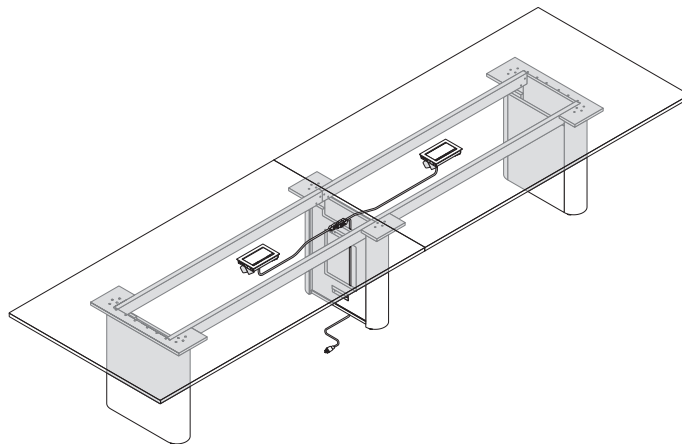

# Power Types & Top Cutout Locations

PRE-DETERMINED CUTOUT LOCATIONS ARE AVAILABLE BASED ON TOP SIZE AND BASE STYLE. REFERENCE PAGES 27 -39 FOR CUTOUT LOCATION BY TOP SIZE AND BASE STYLE.

## POWER TYPES



Cutout CA Node



Cutout CB Electrolite



Cutout CD Ellora

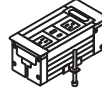

Cutout CE Vault Retractable Z23



Cutout CF M2X

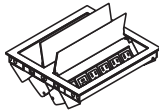

Cutout CG Ellora Double

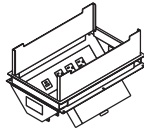

Cutout CH Oasis Two Sided

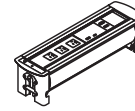

Cutout CJ Vault BTC Rotating

## LOCATION CODES

One Cutout Center	Two Cutouts Ends (over bases)	Two Cutouts Mid (between bases)	Three Cutouts Center + Ends	Three Cutouts Center + Mid	Four Cutouts Mid + Ends
CA1C	N/A	N/A	N/A	N/A	N/A
CB1C	CB2E	CB2M	CB3CE	CB3CM	CB4ME
CD1C	CD2E	CD2M	CD3CE	CD3CM	CD4ME
CE1C	CE2E	CE2M	CE3CE	CE3CM	CE4ME
CF1C	CF2E	CF2M	CF3CE	CF3CM	N/A
CG1C	CG2E	CG2M	CG3CE	CG3CM	N/A
CH1C	N/A	CH2M	CH3CE	CH3CM	N/A
CJ1C	CJ2E	CJ2M	CJ3CE	CJ3CM	N/A

QUANTITY OF UNITS TO ORDER, FOR SINGLE UNITS OR ORDER ONE KIT BASED ON NUMBER OF CUTOUTS.

1	2	2	3	3	4

# Cutout Location Guide: Grommet Dimension Center

CENTER POWER LOCATIONS FOR ALL TOP DEPTHS AND POWER CUTOUT TYPE.

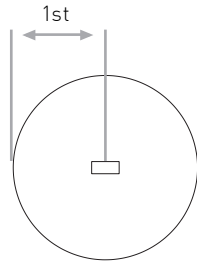

Top Diameter	Center of 1st Power Unit
36	18
42	21
48	24
54	27
60	30

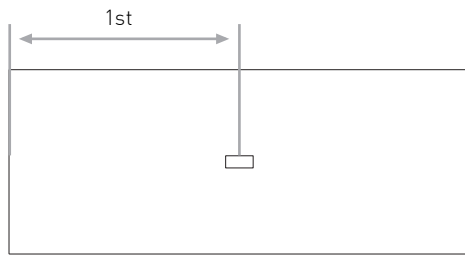

Top Width	Center of 1st Power Unit
72	36
78	39
84	42
90	45
96	48
102	51
108	54
114	57
120	60

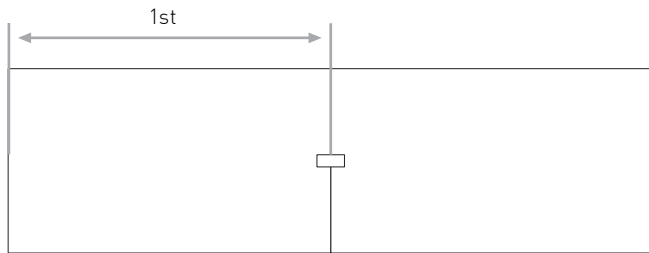

126	63
132	66
138	69
144	72
150	75
156	78
162	81
168	84
174	87
180	90
186	93
192	96

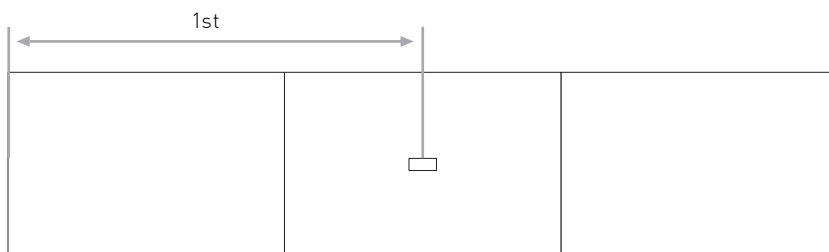

198	99
204	102
210	105
216	108
222	111
228	114
234	117
240	120

# Cutout Location Guide: Grommet Dimension Ends

CENTER POWER LOCATIONS FOR ALL TOP DEPTHS AND POWER CUTOUT TYPE.

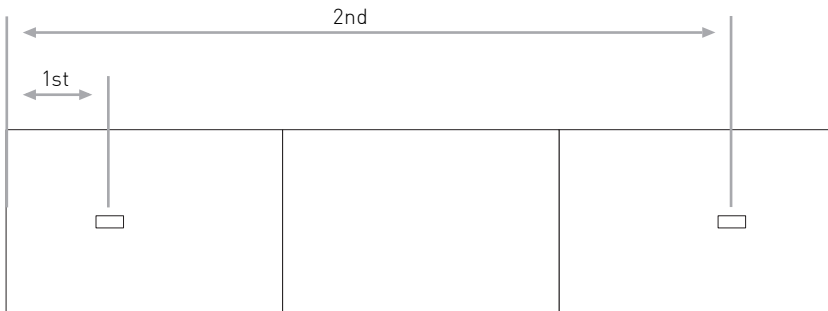
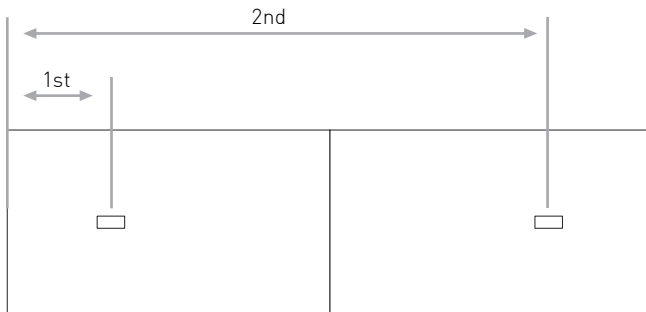
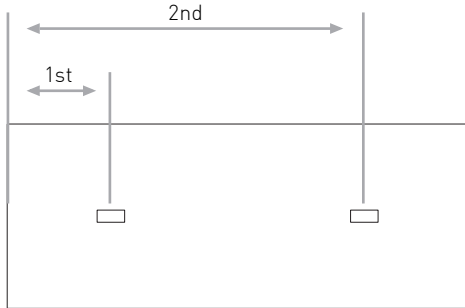

Top Width	Center of 1st Power Unit	Center of 2nd Power Unit
72	21	51
78	21	57
84	24	60
90	24	66
96	27	69
102	27	75
108	27	81
114	27	87
120	27	93
126	27	99
132	27	105
138	27	111
144	27	117
150	27	123
156	27	129
162	27	135
168	27	141
174	27	147
180	27	153
186	27	159
192	27	165
198	27	171
204	27	177
210	27	183
216	27	189
222	27	195
228	27	201
234	27	207
240	27	213

# Cutout Location Guide: Grommet Dimension Center & Ends

CENTER AND END POWER LOCATIONS FOR ALL TOP DEPTHS AND POWER CUTOUT TYPE.

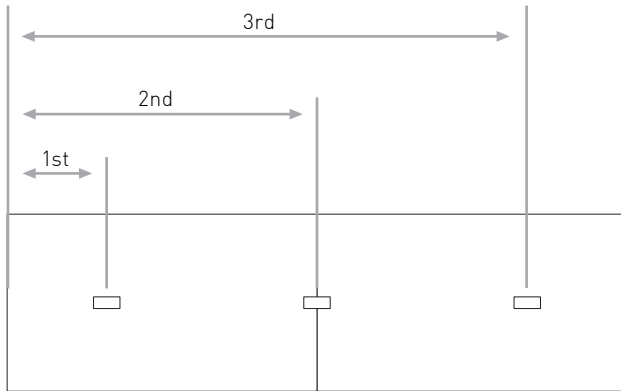

Top Width	Center of 1st Power Unit	Center of 2nd Power Unit	Center of 3rd Power Unit
102	27	51	75
108	27	54	81
114	27	57	87
120	27	60	93
126	27	63	99
132	27	66	105
138	27	69	111
144	27	72	117
150	27	75	123
156	27	78	129
162	27	81	135
168	27	84	141
174	27	87	147
180	27	90	153
186	27	93	159
192	27	96	165
198	27	99	171
204	27	102	177
210	27	105	183
216	27	108	189
222	27	111	195
228	27	114	201
234	27	117	207
240	27	120	213

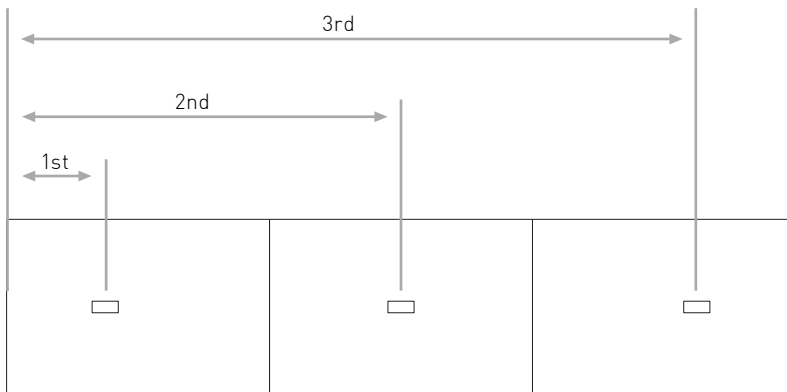

## Cutout Location Guide: Grommet Dimension Mid

MID POWER LOCATIONS FOR ALL TOP DEPTHS AND POWER CUTOUT TYPE.

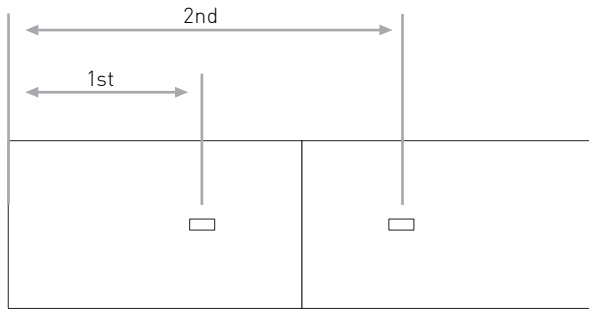

Top Width	Center of 1st Power Unit	Center of 2nd Power Unit
120	43.5	76.5
126	45	81
132	46.5	85.5
138	48	90
144	49.5	94.5
150	51	99
156	52.5	103.5
162	54	108
168	55.5	112.5
174	57	117
180	58.5	121.5
186	60	126
192	61.5	130.5
198	63	135
204	64.5	140
210	66	145
216	67.5	150
222	69	155
228	70.5	160
234	72	165
240	73.5	170

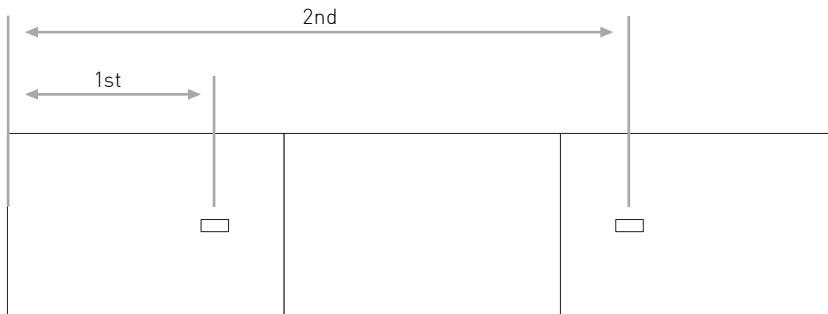

## Cutout Location Guide: Grommet Dimension Center & Mid

CENTER & MID POWER LOCATIONS FOR ALL TOP DEPTHS AND POWER CUTOUT TYPE.

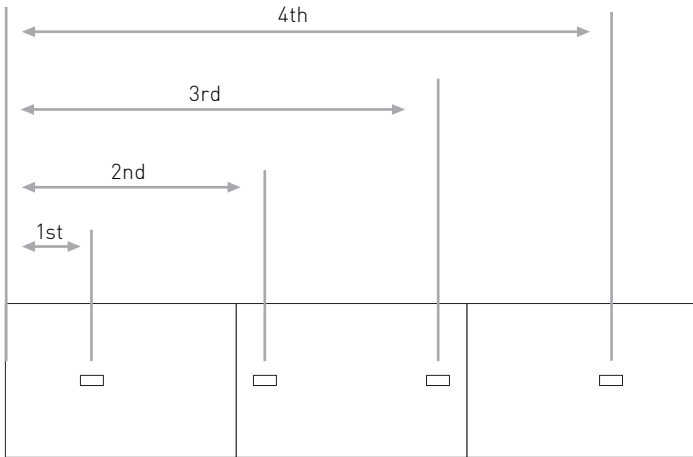

Top Width	Center of 1st Power Unit	Center of 2nd Power Unit	Center of 3rd Power Unit	Center of 4th Power Unit
198	27	75	123	171
204	27	77	127	177
210	27	79	131	183
216	27	81	135	189
222	27	83	139	195
228	27	85	143	201
234	27	87	147	207
240	27	89	151	213

# Table Top Power Options

**BASE TYPE: BEVEL BASE KIT, BRIDGE BASE KIT, OUTLINE BASE KIT**

Top Shape: Rectangular, Soft Rectangular, Racetrack, Boat, Arc Boat, Arc Rectangular

Top Depth: 48", 54", 60"

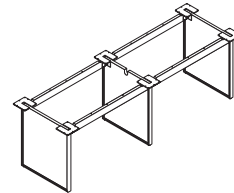
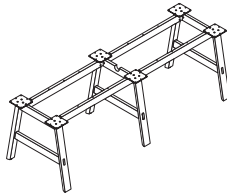
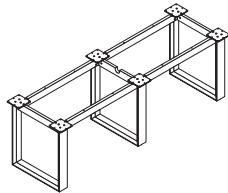

Top Width	Cutout CB Electrolite	Cutout CD Ellora	Cutout CE Vault Z23 Retractable	Cutout CF M2X	Cutout CG Ellora Double	Cutout CH Oasis	Cutout CJ Vault BTC Rotating
72" - 78"	CB1C	CD1C	CE1C	CF1C	N/A	N/A	N/A
84" - 96"	CB1C CB2E	CD1C	CE1C CE2E	CF1C	N/A	N/A	N/A
102"	CB1C CB2E	CD1C	CE1C CE2E CE3CE	CF1C	CG1C	CH1C	CJ1C
108" - 114"	CB1C CB2E CB3CE	CD1C	CE1C CE2E CE3CE	CF1C	CG1C	CH1C	CJ1C
120" - 174"	CB2E CB2M	CD2M	CE2M	CF2M	CG2M	CH2M	CJ2M
180" - 192"	CB2E CB2M	CD2M	N/A	CF2M	CG2M	CH2M	CJ2M
198" - 234"	CB1C CB2E CB2M CB3CE CB3CM CB4ME	CG1C CG2M CG3CM	CE1C CE3CM CE4ME	CF1C CF2M CF3CM	CG1C CG2M CG3CM	CH1C CH2M CH3CM	CJ1C CJ2M CJ3CM
240"	CB1C CB2E CB2M CB3CE CB3CM CB4ME	CG1C CG2M CG3CM	CE1C	CF1C CF2M CF3CM	CG1C CG2M CG3CM	CH1C CH2M CH3CM	CJ1C CJ2M CJ3CM







# Table Top Power Options

**BASE TYPE: BRIDGE BASE KIT**

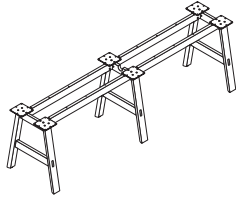
Top Shape: Rectangular, Soft Rectangular, Racetrack, Boat, Arc Boat, Arc Rectangular

Top Depth: 36", 42"



Top Width	Cutout CB Electrolite	Cutout CD Ellora	Cutout CE Vault Z23 Retractable	Cutout CJ Vault BTC Rotating
72" -78"	 CB1C	 CD1C	 CE1C	N/A
84" -96"	CB1C CB2E	CD1C	CE1C CE2E	N/A
102" -114"	CB1C CB2E	CD1C	CE1C CE2E CE3CE	CJ1C
120"	CB2E CB2M	CD2M	CE2M	CJ2M

## Table Top Power Options

**BASE TYPE: CONICAL**

Top Shape: Round

Top Size: 36", 42", 48", 54", 60"



Top Width	Cutout CA Node
	
36" -60"	CA1C

# Table Top Power Options

**BASE TYPE: CONICAL BASE KIT**

Top Shape: Rectangular, Soft Rectangular, Racetrack, Boat, Arc Boat

Top Size: 42", 48"

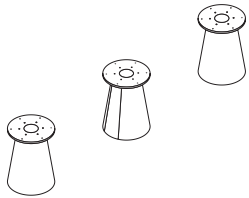

Top Width	Cutout CB Electrolite	Cutout CD Ellora	Cutout CE Vault Z23 Retract- ah	Cutout CF M2X	Cutout CG Ellora Double	Cutout CH Oasis	Cutout CJ Vault BTC Rotating
102" -144"	CB1C	CD1C	CE1C	CF1C	CG1C	CH1C	CJ1C
150" -174"	CB2M	CD2M	CE2M	CF2M	CG2M	CH2M	CJ2M
180" -192"	CB2M	CD2M	N/A	CF2M	CG2M	CH2M	CJ2M
198" -234"	CB1C	CD1C	CE1C	CF1C	CG1C	CH1C	CJ1C
	CB2M	CD2M	CE3CM	CF2M	CG2M	CH2M	CJ2M
	CB3CM	CD3CM		CF3CM	CG3CM	CH3CM	CJ3CM
240"	CB1C	CD1C	CE1C	CF1C	CG1C	CH1C	CJ1C
	CB2M	CD2M		CF2M	CG2M	CH2M	CJ2M
	CB3CM	CD3CM		CF3CM	CG3CM	CH3CM	CJ3CM

# Table Top Power Options

**BASE TYPE: CONICAL BASE KIT**

Top Shape: Rectangular, Soft Rectangular, Racetrack, Boat, Arc Boat, Arc Rectangular

Top Size: 54", 60"

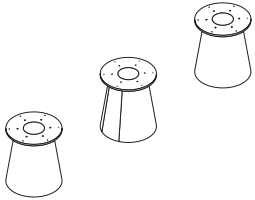

Top Width	Cutout CB Electrolite	Cutout CD Ellora	Cutout CE Vault Z23 Retractable	Cutout CF M2X	Cutout CG Ellora Double	Cutout CH Oasis	Cutout CJ Vault BTC Rotating
120" -144"	CB1C	CD1C	CE1C	CF1C	CG1C	CH1C	CJ1C
150" -174"	CB2M	CD2M	CE2M	CF2M	CG2M	CH2M	CJ2M
180" -192"	CB2M	CD2M	N/A	CF2M	CG2M	CH2M	CJ2M
198" -234"	CB1C	CD1C	CE1C	CF1C	CG1C	CH1C	CJ1C
	CB2M	CD2M	CE3CM	CF2M	CG2M	CH2M	CJ2M
	CB3CM	CD3CM		CF3CM	CG3CM	CH3CM	CJ3CM
240"	CB1C	CD1C		CF1C	CG1C	CH1C	CJ1C
	CB2M	CD2M	CE1C	CF2M	CG2M	CH2M	CJ2M
	CB3CM	CD3CM		CF3CM	CG3CM	CH3CM	CJ3CM









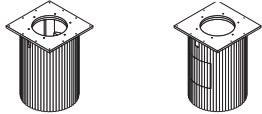

# Table Top Power Options

**BASE TYPE: FLUTED CYLINDER BASE**

Top Shape: Round

Top Size: 36", 42", 48", 54", 60"

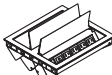

Top Width						
For 18" base	Cutout CA NODE	Cutout CB Electrolite	Cutout CD ELLORA	Cutout CE VAULT Z23 Retractable	Cutout CF M2X	Cutout CG Ellora Double
36", 42"	CA1C	CB1C	N/A	CE1C	N/A	N/A
Top Width						
For 24" base	Cutout CA NODE	Cutout CB Electrolite	Cutout CD ELLORA	Cutout CE VAULT Z23 Retractable	Cutout CF M2X	Cutout CG Ellora Double
48", 54", 60"	CA1C	CB1C	CD1C	CE1C	CF1C	CG1C

# Table Top Power Options

**BASE TYPE: FLUTED CYLINDER BASE KIT**

Top Shape: Rectangular, Soft Rectangular, Racetrack, Boat, Arc Boat, Arc Rectangular

Top Depth: 42", 48"

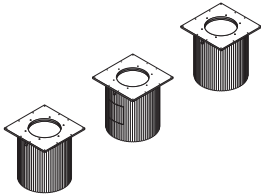

Top Width	Cutout CB Electrolite	Cutout CD Ellora	Cutout CE Vault Z23 Retractable	Cutout CF M2X	Cutout CG Ellora Double	Cutout CH Oasis	Cutout CJ Vault BTC Rotating
102" -114"	CB1C CB2E	CD1C CD2E	CE1C CE2E	CF1C CF2E	CG1C	CH1C	CJ1C
120"	CB1C CB2E CB2M CB3CE	CD1C CD2E CD2M CD3CE	CE1C CE2M	CF1C CF2E CF2M CF3CE	CG1C CG2M	CH1C	CJ1C
126" -144"	CB1C CB2E CB2M CB3CE	CD1C CD2E CD2M CD3CE	CE1C CE2M CE3CE	CF1C CF2E CF2M CF3CE	CG1C CG2M	CH1C	CJ1C
150" -174"	CB1C CB2E CB2M CB3CE	CD1C CD2E CD2M CD3CE	CE1C CE2M CE3CE	CF1C CF2E CF2M CF3CE	CG2M	CH2M	CJ2M
180" -192"	CB1C CB2E CB2M CB3CE	CD1C CD2E CD2M CD3CE	CE1C	CF1C CF2E CF2M CF3CE	CG2M	CH2M	CJ2M
198" -234"	CB1C CB2E CB2M CB3CE CB3CM	CD1C CD2E CD2M CD3CE CD3CM	CE1C CE3CM	CF1C CF2E CF2M CF3CE CF3CM	CG1C CG2M	CH1C CH2M CH3CM	CJ1C CJ2M CJ3CM
240"	CB1C CB2E CB2M CB3CE CB3CM	CD1C CD2E CD2M CD3CE CD3CM	CE1C	CF1C CF2E CF2M CF3CE CF3CM	CG1C CG2M	CH1C CH2M CH3CM	CJ1C CJ2M CJ3CM

# Table Top Power Options

**BASE TYPE: FLUTED CYLINDER BASE KIT**

Top Shape: Rectangular, Soft Rectangular, Racetrack, Boat, Arc Boat, Arc Rectangular

Top Depth: 54", 60"

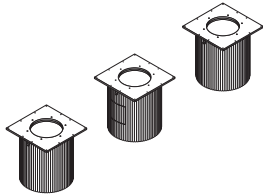

Top Width	Cutout CB Electrolite	Cutout CD Ellora	Cutout CE Vault Z23 Retractable	Cutout CF M2X	Cutout CG Ellora Double	Cutout CH Oasis	Cutout CJ Vault BTC Rotating
120" - 138"	CB1C CB2E CB2M CB3CE	CD1C CD2E CD3CE	CE1C CE3CE	CF1C CF2E	CG1C CG2E	CH1C	CJ1C
144" - 174"	CB1C CB2E CB2M CB3CE	CD1C CD2E CD2M CD3CE	CE1C CE3CE	CF1C CF2E CF2M CF3CE	CG1C CG2E CG2M CG3CE	CH2M	CJ2M
180" - 192"	CB1C CB2E CB2M CB3CE	CD1C CD2E CD2M CD3CE	CE1C	CF1C CF2E CF2M CF3CE	CG1C CG2E CG2M CG3CE	CH2M	CJ2M
198" - 234"	CB1C CB2E CB2M CB3CE CB3CM	CD1C CD2E CD2M CD3CE CD3CM	CE1C CE3CM	CF1C CF2E CF2M CF3CE CF3CM	CG1C CG2E CG2M CG3CE CG3CM	CH1C CH2M CH3CM	CJ1C CJ2M CJ3CM
240"	CB1C CB2E CB2M CB3CE CB3CM	CD1C CD2E CD2M CD3CE CD3CM	CE1C	CF1C CF2E CF2M CF3CE CF3CM	CG1C CG2E CG2M CG3CE CG3CM	CH1C CH2M CH3CM	CJ1C CJ2M CJ3CM

# Table Top Power Options

**BASE TYPE: OBLIQUE BASE KIT**

Top Shape: Rectangular, Soft Rectangular, Racetrack, Boat, Arc Boat, Arc Rectangular

Top Depth: 36", 42"

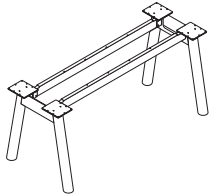

Top Width	Cutout CB Electrolite	Cutout CD Ellora	Cutout CE Vault Z23 Retractable	Cutout CF M2X	Cutout CJ Vault BTC Rotating
72" -78"	CB1C	CD1C	CE1C	CF1C	N/A
84" -96"	CB1C CB2E	CD1C CD2E	CE1C CE2E	CF1C	N/A
102" -114"	CB1C CB2E CB3CE	CD1C CD2E	CE1C CE2E CE3CE	CF1C	CJ1C
120"	CB1C CB2E CB2M CB3CE	CD1C CD2E CD2M CD3CE	CE1C CE2M CE3CE	CF2M	CJ2M



# Table Top Power Options

**BASE TYPE: OBLIQUE BASE KIT**

Top Shape: Rectangular, Soft Rectangular, Racetrack, Boat, Arc Boat, Arc Rectangular

Top Depth: 48"

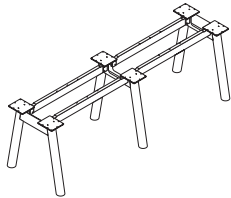

Top Width	Cutout CB Electrolite	Cutout CD Ellora	Cutout CE Vault Z23 Retractable	Cutout CF M2X	Cutout CG Ellora Double	Cutout CH Oasis	Cutout CJ Vault BTC Rotating
72" -96"	CB1C	CD1C	CE1C	CF1C	N/A	N/A	N/A
102" -114"	CB1C CB2E CB3CE	CD1C	CE1C CE2E CE3CE	CF1C	CG1C	CH1C	CJ1C
120" -174"	CB1C CB2E CB2M CB3CE	CD1C CD2E CD2M CD3CE	CE1C CE2M CE3CE	CF1C CF2E CF2M	CG1C CG2E CG2M	CH2M	CJ2M
180" -192"	CB1C CB2E CB2M CB3CE	CD1C CD2E CD2M CD3CE	CE1C	CF1C CF2E CF2M CF3CE	CG1C CG2E CG2M CG3CE	CH2M	CJ2M
198" -234"	CB1C CB2E CB2M CB3CE CB3CM CB4ME	CD1C CD2E CD2M CD3CE CD3CM CD4ME	CE1C CE3CM CE4ME	CF1C CF2E CF2M CF3CE CF3CM	CG1C CG2E CG2M CG3CE CG3CM	CH1C CH2M CH3CM	CJ1C CJ2M CJ3CM
240"	CB1C CB2E CB2M CB3CE CB3CM CB4ME	CD1C CD2E CD2M CD3CE CD3CM CD4ME	CE1C	CF1C CF2E CF2M CF3CE CF3CM	CG1C CG2E CG2M CG3CE CG3CM	CH1C CH2M CH3CM	CJ1C CJ2M CJ3CM

# Table Top Power Options

**BASE TYPE: OBLIQUE BASE KIT**

Top Shape: Rectangular, Soft Rectangular, Racetrack, Boat, Arc Boat, Arc Rectangular

Top Depth: 54", 60"

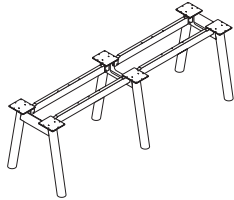

Top Width	Cutout CB Electrolite	Cutout CD Ellora	Cutout CE Vault Z23 Retractable	Cutout CF M2X	Cutout CG Ellora Double	Cutout CH Oasis	Cutout CJ Vault BTC Rotating
120" -138"	CB1C	CD1C	CE1C	CF1C	CG1C		CJ2M
	CB2E	CD2E	CE2M	CF2E	CG2E	CH2M	
	CB2M	CD2M	CE3CE	CF2M	CG2M		
	CB3CE	CD3CE					
144" -174"	CB1C	CD1C	CE1C	CF1C	CG1C		CJ2M
	CB2E	CD2E	CE2M	CF2E	CG2E	CH2M	
	CB2M	CD2M	CE3CE	CF2M	CG2M		
	CB3CE	CD3CE		CF3CE	CG3CE		
180" -192"	CB1C	CD1C		CF1C	CG1C		CJ2M
	CB2E	CD2E	CE1C	CF2E	CG2E	CH2M	
	CB2M	CD2M		CF2M	CG2M		
	CB3CE	CD3CE		CF3CE	CG3CE		
198" -234"	CB1C	CD1C		CF1C	CG1C		CJ1C
	CB2E	CD2E	CE1C	CF2E	CG2E	CH1C	CJ2M
	CB2M	CD2M	CE3CM	CF2M	CG2M	CH2M	CJ3CM
	CB3CE	CD3CE	CE4ME	CF3CE	CG3CE	CH3CM	
	CB3CM	CD3CM		CF3CM	CG3CM		
	CB4ME	CD4ME					
240"	CB1C	CD1C		CF1C	CG1C		CJ1C
	CB2E	CD2E		CF2E	CG2E	CH1C	CJ2M
	CB2M	CD2M	CE1C	CF2M	CG2M	CH2M	CJ3CM
	CB3CE	CD3CE		CF3CE	CG3CE	CH3CM	
	CB3CM	CD3CM		CF3CM	CG3CM		
	CB4ME	CD4ME					

# Table Top Power Options

**BASE TYPE: FRAME BASE KIT, RACETRACK BASE KIT**

Top Shape: Rectangular, Soft Rectangular, Racetrack, Boat, Arc Boat, Arc Rectangular

Top Depth: 36", 42", 48", 54", 60"

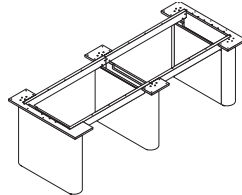
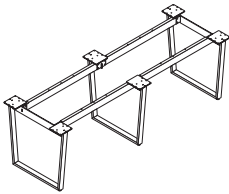

Top Width	Cutout CB Electrolite	Cutout CD Ellora	Cutout CE Vault Z23 Retractable	Cutout CF M2X	Cutout CG Ellora Double	Cutout CH Oasis	Cutout CJ Vault BTC Rotating
<b>72" -78"</b>	CB1C	CD1C	CE1C	CF1C	N/A	N/A	N/A
<b>84" -96"</b>	CB1C CB2E	CD1C CD2E	CE1C CE2E	CF1C	N/A	N/A	N/A
<b>102" -114"</b>	CB1C CB2E CB3CE	CD1C CD2E	CE1C CE2E CE3CE	CF1C	CG1C	CH1C	CJ1C
<b>120" -174"</b>	CB1C CB2E CB2M CB3CE	CD1C CD2E CD2M CD3CE	CE1C CE2M	CF1C CF2E CF2M	CG1C CG2E CG2M	CH2M	CJ2M
<b>180" -192"</b>	CB1C CB2E CB2M CB3CE	CD1C CD2E CD2M CD3CE	CE1C	CF1C CF2E CF2M CF3CE	CG1C CG2E CG2M CG3CE	CH2M	CJ2M
<b>198" -234"</b>	CB1C CB2E CB2M CB3CE CB3CM CB4ME	CD1C CD2E CD2M CD3CE CD3CM CD4ME	CE1C CE3CM CE4ME	CF1C CF2E CF2M CF3CE CF3CM	CG1C CG2E CG2M CG3CE CG3CM	CH1C CH2M CH3CM	CJ1C CJ2M CJ3CM
<b>240"</b>	CB1C CB2E CB2M CB3CE CB3CM CB4ME	CD1C CD2E CD2M CD3CE CD3CM CD4ME	CE1C	CF1C CF2E CF2M CF3CE CF3CM	CG1C CG2E CG2M CG3CE CG3CM	CH1C CH2M CH3CM	CJ1C CJ2M CJ3CM

# Table Top Power Options

**BASE TYPE: FRAME BRIDGELINE BASE KIT, RACETRACK BRIDGELINE BASE KIT**

Top Shape: Rectangular, Soft Rectangular, Racetrack, Boat, Arc Boat, Arc Rectangular

Top Depth: 48", 54", 60"

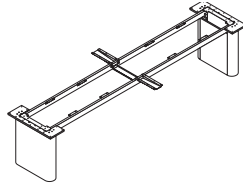
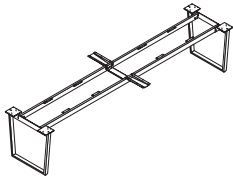

Top Width	Cutout CB Electrolite	Cutout CD Ellora	Cutout CE Vault Z23 Retractable	Cutout CF M2X	Cutout CG Ellora Double	Cutout CH Oasis	Cutout CJ Vault BTC Rotating
120" -174"	CB1C	CD1C		CF1C	CG1C		
	CB2E	CD2E		CF2E	CG2E	CH2M	CJ2M
	CB2M	CD2M	CE2M	CF2M	CG2M		
	CB3CE	CD3CE		CF3CE	CG3CE		
180" -192"	CB1C	CD1C		CF1C	CG1C		
	CB2E	CD2E		CF2E	CG2E	CH2M	CJ2M
	CB2M	CD2M	N/A	CF2M	CG2M		
	CB3CE	CD3CE		CF3CE	CG3CE		

## Wire Management Accessories

Anthology features several bases which offer integrated wire management through the base.

Conical, Fluted, and Racetrack bases provide a pass-through for cords to the floor. All feature access to the interior of the base by a removeable panel or hinged door. Racetrack shown below.

The Frame base is available with a magnetic wire manager that is sold separately.

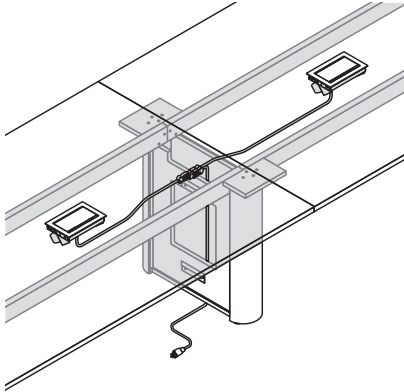

For bases without integrated wire management a Wire Management Chase is available in TFL (65T7228WCV) or Veneer (65T7228FWM) finishes that can be specified between bases to conceal cords to the floor.

A Flexible Wire Manager (9P26FWM) is available to support cords between bases and attaches to underside of top.

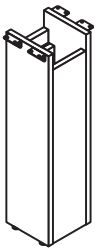

Additional cord manager accessories from other series can also be utilized such as Flexible Floor Manager GP250VWM.

# Credenza Model Types and Features

## WALL MOUNT CREDENZAS

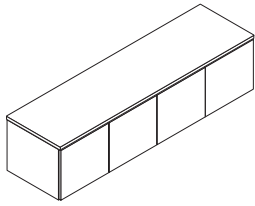

20" D  
17" H  
36", 60", 72", 90" W

- Separate models for laminate and veneer.
- Bottom cut-out for wire management pass-through.

## LOW HEIGHT CREDENZAS

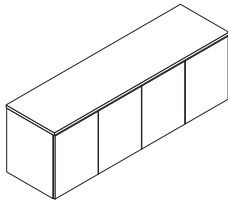

20" D  
24" H  
36", 60", 72", 90" W

- Separate models for laminate and veneer.
- Cut-out in back for wire management pass-through.

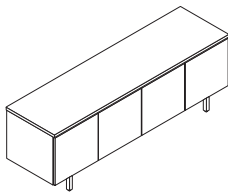

**Metal inset base**

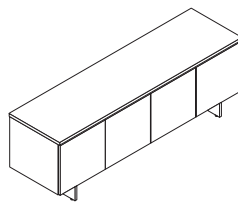

**Panel inset base**

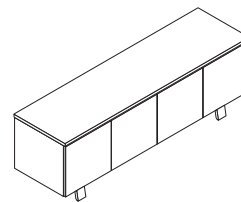

**Wood inset base**

## Credenza Model Types and Features Continued

### CONFERENCE CREDENZAS

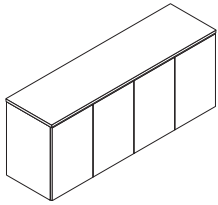

20" D  
28 15/26" H  
36", 60", 72", 90" W

- Separate models for laminate and veneer.
- Cut-out in back for wire management pass-through.

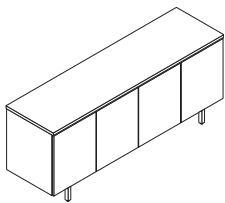

**Metal inset base**

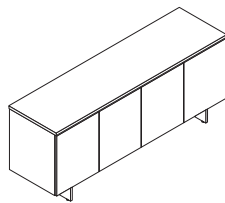

**Panel inset base**

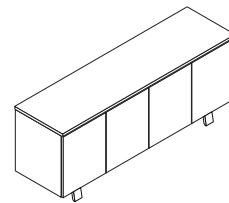

**Wood inset base**

### BUFFET CREDENZAS

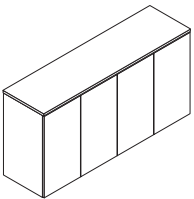

20" D  
35 15/16" H  
36", 60", 72", 90" W

- Separate models for laminate and veneer.
- Cut-out in back for wire management pass-through.
- Utility drawer models available in laminate (65C1727UDT) or veneer (65C1727UDV).

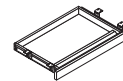

**Utility Drawer**

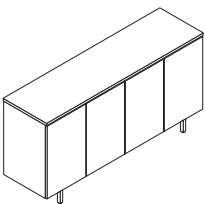

**Metal inset base**

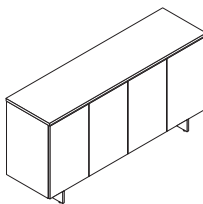

**Panel inset base**

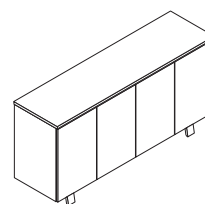

**Wood inset base**

# Credenza Model Types and Features Continued

## EQUIPMENT CREDENZAS

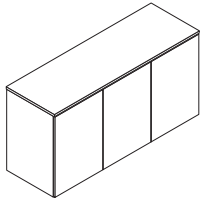

24" D  
 35 15/16" H  
 48", 72", W

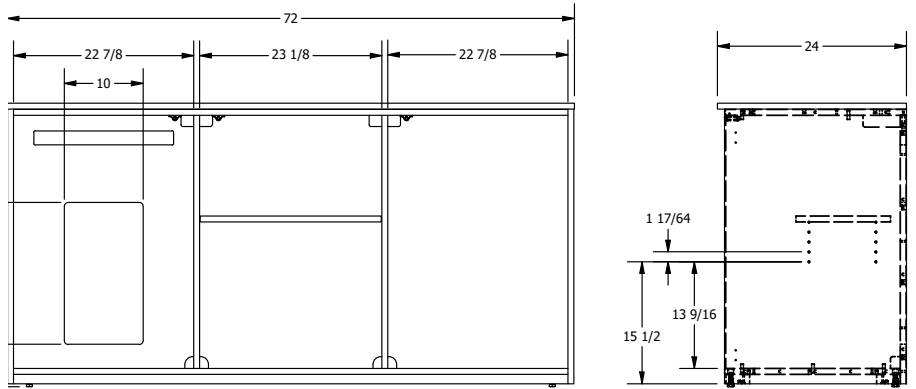

- Separate models for laminate and veneer.
- Cut-out in back for wire management pass-through.
- Inside bottom is a black HPL moisture resistant material.

Back View

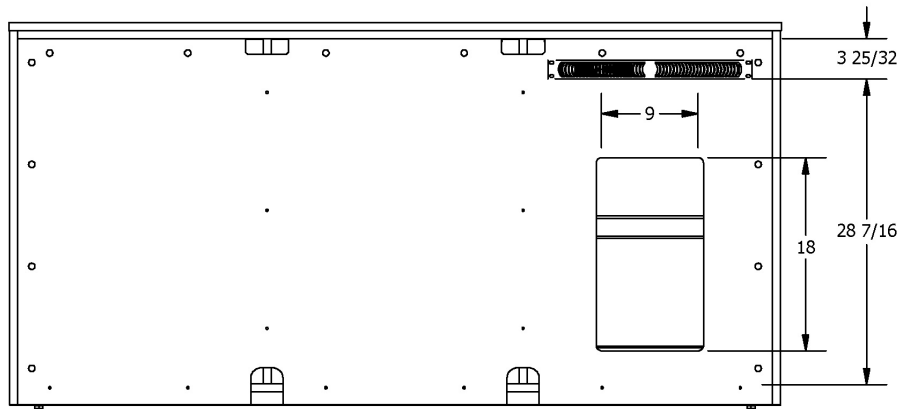

Thermostat Control Fan

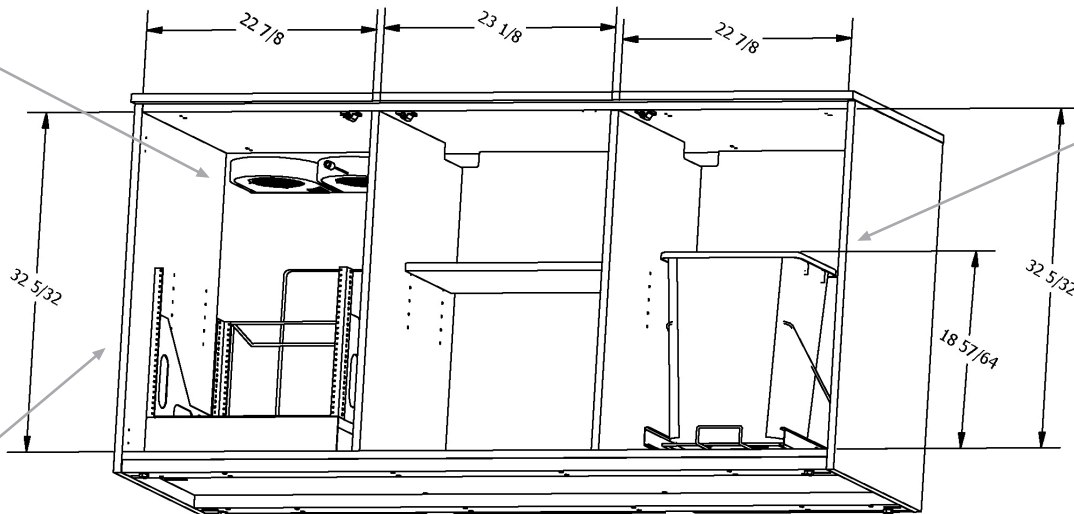

Dual Waste/Recycle Unit

Rotating AV Rack



# Credenza Specification Overview

## ANTHOLOGY CREDENZA

Self Edge Rim

1. Choose model by case only or inset base, finish or paint, and material and size
2. Choose base material as an option within the model number

### CREDENZAS – LAMINATE SPECS

#### CASE ONLY

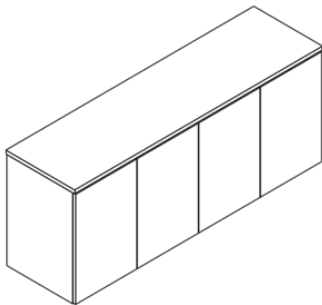

Top Surface TFL Laminate  
Chassis Laminate  
Door Laminate

#### METAL LEG

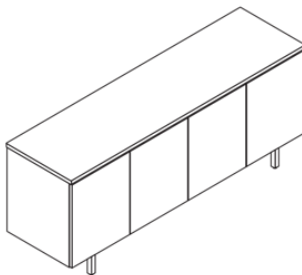

Top Surface TFL Laminate  
Chassis Laminate  
Door Laminate  
Metal Base – Metal Paint

#### PANEL LEG

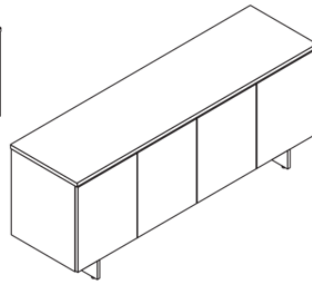

Top Surface TFL Laminate  
Chassis Laminate  
Door Laminate  
Panel Base – matches Chassis

#### WOOD LEG

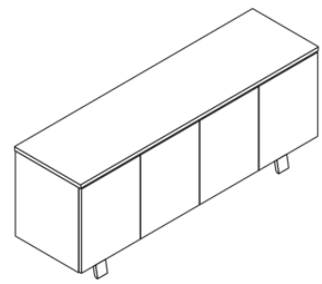

Top Surface TFL Laminate  
Chassis Laminate  
Door Laminate  
Wood Base – Solid Wood Finish

### CREDENZAS – VENEER SPECS

#### CASE ONLY

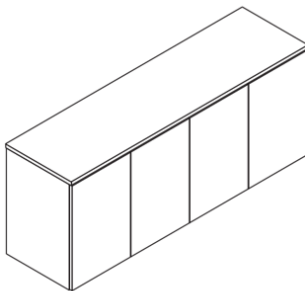

Top Surface + Chassis + Doors – Essentials/Artisan Veneer Finish  
Door Fronts – can be contrasted with Wood Paint

#### METAL LEG

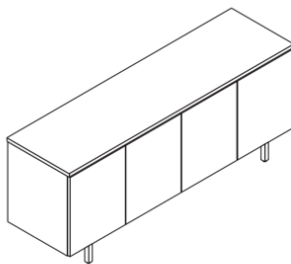

Top Surface + Chassis + Doors – Essentials/Artisan Veneer Finish  
Door Fronts – can be contrasted with Wood Paint  
Metal Base – Metal Paint

#### PANEL LEG

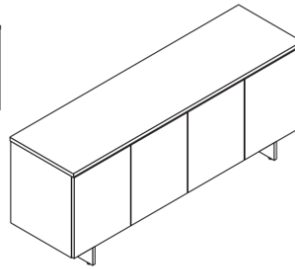

Top Surface + Chassis + Doors + Panel Base – Essentials/Artisan Veneer Finish  
Door Fronts – can be contrasted with Wood Paint

#### WOOD LEG

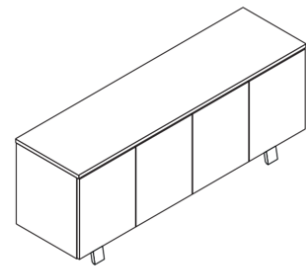

Top Surface + Chassis + Doors – Essentials/Artisan Veneer Finish  
Door Fronts – can be contrasted with Wood Paint  
Wood Base – Solid Wood Finish

## Credenza Specification Overview Continued

3. Choose lock, grommet cutout, and power as options with separate model numbers.

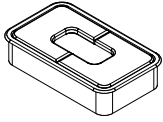

Choose a separate model for power below:  
Locking is an option upcharge

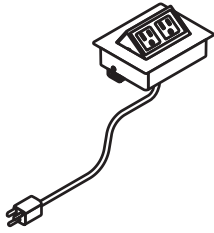

Glenbeigh  
Power, Corded  
(9PCK2C)

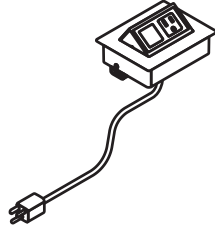

Glenbeigh  
Power + Open, Corded  
(9PCK1C)

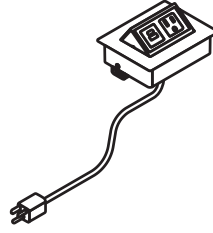

Glenbeigh  
Power + USB, Corded  
(9PCK11C)

4. Buffet Credenza models can have a utility drawer specified in laminate or veneer.

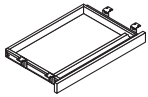

**UTILITY DRAWER**  
-Laminate (65C1727UDT)  
-Veneer (65C1727UDV)

5. Equipment Credenza models can have the following accessories (separate models):

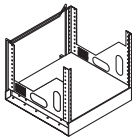

**PULL OUT ROTATING AV RACK**  
-(65C19PAV)



**DUAL WASTE/ RECYCLE UNITS**  
-8 GAL  
-(65C2214PDW)



**THERMOSTAT CONTROL FAN**  
-(65C1019TCF)

## Credenza: Exterior Components

### MATERIALS AND BASES

LAMINATE AND VENEER

3/4 top panel thickness

.5 mm edgeband

### DOOR STYLE

Touch latch doors, no pulls

### BASE STYLES

Metal inset, Panel inset, Wood inset

### VENTILATION AND CUTOUTS

Thermostat Control Fan 65C1019TCF

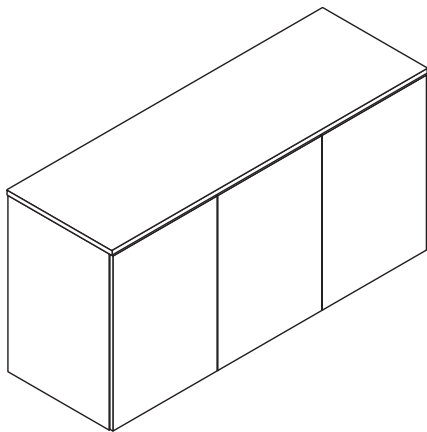

Front View

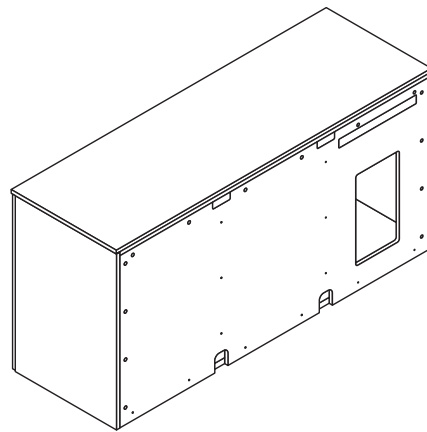

Back View

## Credenza: Interior Dimensions

### WALL MOUNT CREDENZA

Width	Inside Dimension Overall	Compartment Dimension (L & R)	Compartment Dimension (Middle)
36	17 19/32" D x 34 3/8" W x 14 11/16" H		
60		17 19/32" D x 28 13/16" W x 14 11/16" H	
72		17 19/32" D x 34 13/16" W x 14 11/16" H	
90		17 19/32" D x 34 13/16" W x 14 11/16" H	17 19/32" D x 17 7/32" W x 14 11/16" H

### LOW HEIGHT CREDENZA

-CASE ONLY

Width	Inside Dimension Overall	Compartment Dimension (L & R)	Compartment Dimension (Middle)
36	18 9/32" D x 34 3/8" W x 20 5/32" H		
60		18 9/32" D x 28 13/16" W x 20 5/32" H	
72		18 9/32" D x 34 13/16" W x 20 5/32" H	
90		18 9/32" D x 34 13/16" W x 20 5/32" H	18 9/32" D x 17 7/32" W x 20 5/32" H

### LOW HEIGHT CREDENZA

-WITH INSET BASE

Width	Inside Dimension Overall	Compartment Dimension (L & R)	Compartment Dimension (Middle)
36	18 9/32" D x 34 3/8" W x 15 1/4" H		
60		18 9/32" D x 28 13/16" W x 15 1/4" H	
72		18 9/32" D x 34 13/16" W x 15 1/4" H	
90		18 9/32" D x 34 13/16" W x 15 1/4" H	18 9/32" D x 17 7/32" W x 15 1/4" H

## Credenza: Interior Dimensions Continued

### CONFERENCE CREDENZA

-CASE ONLY

Width	Inside Dimension Overall	Compartment Dimension (L & R)	Compartment Dimension (Middle)
36	18 9/32" D x 34 3/8" W x 25 5/32" H		
60		18 9/32" D x 28 13/16" W x 25 5/32" H	
72		18 9/32" D x 34 13/16" W x 25 5/32" H	
90		18 9/32" D x 34 13/16" W x 25 5/32" H	18 9/32" D x 17 7/32" W x 25 5/32" H

### CONFERENCE CREDENZA

-WITH INSET BASE

Width	Inside Dimension Overall	Compartment Dimension (L & R)	Compartment Dimension (Middle)
36	18 9/32" D x 34 3/8" W x 20 1/4" H		
60		18 9/32" D x 28 13/16" W x 20 1/4" H	
72		18 9/32" D x 34 13/16" W x 20 1/4" H	
90		18 9/32" D x 34 13/16" W x 20 1/4" H	18 9/32" D x 17 7/32" W x 20 1/4" H

### BUFFET CREDENZA

-CASE ONLY

Width	Inside Dimension Overall	Compartment Dimension (L & R)	Compartment Dimension (Middle)
36	18 9/32" D x 34 3/8" W x 32 5/32" H		
60		18 9/32" D x 28 13/16" W x 32 5/32" H	
72		18 9/32" D x 34 13/16" W x 32 5/32" H	
90		18 9/32" D x 34 13/16" W x 32 5/32" H	18 9/32" D x 17 7/32" W x 32 5/32" H

## Credenza: Interior Dimensions Continued

### BUFFET CREDENZA -WITH INSET BASE

Width	Inside Dimension Overall	Compartment Dimension (L & R)	Compartment Dimension (Middle)
36	18 9/32" D x 34 3/8" W x 27 1/4" H		
60		18 9/32" D x 28 13/16" W x 27 1/4" H	
72		18 9/32" D x 34 13/16" W x 27 1/4" H	
90		18 9/32" D x 34 13/16" W x 27 1/4" H	18 9/32" D x 17 7/32" W x 27 1/4" H

### EQUIPMENT CREDENZA

Width	Inside Dimension Overall	Compartment Dimension (L & R)	Compartment Dimension (Middle)
48		22 3/16" D x 22 13/16" W x 32 5/32" H	
48		22 3/16" D x 22 13/16" W x 32 5/32" H	
72		22 3/16" D x 22 7/8" W x 32 5/32" H	22 3/16" D x 23 1/8" W x 32 5/32" H
72	22 3/16" D x 70 3/8" W x 32 5/32" H	22 3/16" D x 22 7/8" W x 32 5/32" H	22 3/16" D x 23 1/8" W x 32 5/32" H

## Product and Finish Information

### How to Order Tops - Suffix

When specifying a top your suffix at the end will determine if it is TFL or HPL Laminate or Veneer.

① Model	W	D	Top Pieces	Edge Profiles									
				R3 TFL	R3 HPL Tier 1	R3 HPL Tier 2	K9 HPL Tier 1	K9 HPL Tier 2	R3 H3 C3 ESS Veneer	R3 H3 C3 ART Veneer	K9 ESS Veneer	K9 ART Veneer	
				T	H	H	KH	KH	V	V	KV	KV	
65T3672TT_	72	36	1	\$491	\$802	\$842	\$1,172	\$1,230	\$2,122	\$2,334	\$2,491	\$2,740	
65T4272TT_	72	42	1	\$590	\$861	\$904	\$1,254	\$1,317	\$2,356	\$2,592	\$2,903	\$3,193	
65T4872TT_	72	48	1	\$675	\$866	\$909	\$1,258	\$1,321	\$2,628	\$2,891	\$3,154	\$3,470	

### Example

#### 65T36TT\_

65T36TTI- TFL Laminate- Eased Edge (R3)

65T36TTH- HPL Laminate- Tier 1 or 2- Eased Edge (R3)

65T36TTKH- HPL Laminate- Tier 1 or 2- Reverse Bevel Edge (K9)

65T36TTV- Essentials or Artisan Veneer- Eased (R3), Reeded (H3) or Transitional (C3) Edge

65T36TTKV- Essentials or Artisan Veneer- Eased (R3), Reeded (H3) or Transitional (C3) Edge

## Product and Finish Information

### Bases

#### TFL/HPL Laminates

ALB	Alabaster
BEL	Belair
BLK	Black
BRK	Brickdust
BBL	Bridal Blanco
CSK	Cask
CLY	Clay
DWH	Designer White
EGR	Egret
FAW	Fawn
FLN	Flint
FLO	Florence Walnut
LOF	Loft
MES	Mesa
MIN	Mineral
MCH	Mocha
OBK	Outback
PIL	Pilsner
PIN	Pinnacle Walnut
SHD	Shadow
SLG	Slate Grey
UMB	Umber
VAL	Valley
WLH	Walnut Heights
WEA	Weathered Ash
ZEN	Zen Grey

#### Veneer

##### ESS Essentials Veneer

BRK	Brickdust
CSK	Cask
CLY	Clay
FAW	Fawn
FLX	Flax
FLN	Flint
LOF	Loft
MES	Mesa
MIN	Mineral
MCH	Mocha
OBK	Outback
PIL	Pilsner
SIE	Sienna
TRF	Truffle
UMB	Umber
VAL	Valley

##### ART Artisan Veneer

BAR	Barrel
BUF	Buff
CND	Cinder
EGR	Egret
RAV	Raven
RYE	Rye
SAB	Sable
SAD	Saddle

#### Solid Wood

BAR	Barrel
BRK	Brickdust
BUF	Buff
CSK	Cask
CND	Cinder
CLY	Clay
EGR	Egret
FAW	Fawn
FLX	Flax
FLN	Flint
FLO	Florence Walnut
LOF	Loft
MES	Mesa
MIN	Mineral
MCH	Mocha
OBK	Outback
PIL	Pilsner
PIN	Pinnacle Walnut
RAV	Raven
RYE	Rye
SAB	Sable
SAD	Saddle
SIE	Sienna
TRF	Truffle
UMB	Umber
VAL	Valley
WLH	Walnut Heights

#### Metal

ABZ	Aged Bronze
ASL	Arctic Silver
BWH	Bright White
GLD	Gold
MBK	Matte Black
PEW	Pewter
SBZ	Soft Bronze
SNK	Soft Nickel
CHR	Chrome - upcharge applies available on Frame and Outline bases only

#### Additional Metal Colors - upcharge applies

available on Oblique bases only

BRD	Beige Red (RAL3012)
CAR	Carmine Red (RAL3002)
COP	Copper Brown (RAL8004)
HYL	Honey Yellow (RAL1005)
LGR	Leaf Green (RAL6002)
MHB	Mahogany Brown (RAL8016)
MTQ	Mint Turquoise (RAL6033)
OGR	Olive Green (RAL6003)
PPV	Purple Violet (RAL4007)
QZG	Quartz Grey (RAL7039)
SAL	Salmon Orange (RAL2012)
SPB	Sapphire Blue (RAL5003)
SGR	Signal Green (RAL6032)
SIG	Signal Orange (RAL2010)
SGY	Silk Grey (RAL7044)
SKY	Sky Blue (RAL5015)
TBL	Traffic Blue (RAL5017)
TRD	Traffic Red (RAL3020)
TQP	Turquoise Pastel (RAL6034)
ZYL	Zinc Yellow (RAL1018)



## Power and Cutout Information

### Power Types

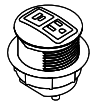

Cutout CA Node

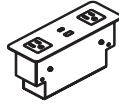

Cutout CB Electrolite



Cutout CD Ellora

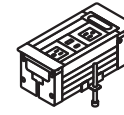

Cutout CE Vault Retractable



Cutout CF M2X Two Sided

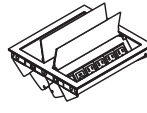

Cutout CG Ellora Double

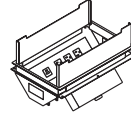

Cutout CH Oasis Two Sided

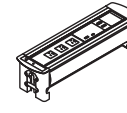

Cutout CJ Vault BTC Rotating

Anthology Power Modules offer a broad selection of performance features to support small to large power requirements including USB A+C. Models are available as single specified units, with selected models available in kits linked together with a single plug. Price list pages \_\_\_ - \_\_\_ for power unit specifications.

Pre-determined cutout locations are available based on top size and base style.

Cutouts are \$33 per cutout.

Two cutouts	\$66
Three cutouts	\$99
Four cutouts	\$132

To order: specify code associated with power module and location.

CD2M = Ellora- 2 cutouts- Mid Location

Planning location codes [ANPG\\_21](#).

**Rectangular Table Tops**

- planning top specification [ANPG\\_6](#)
- base guide [pages 38-57](#)
- planning power guide [ANPG\\_20- ANPG\\_40](#)

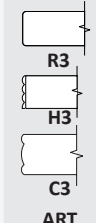
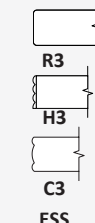
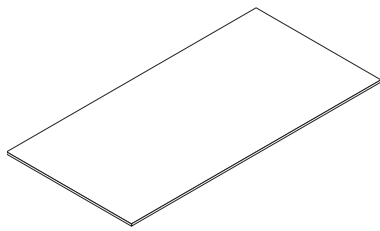

Model	W	D	Top Pieces	R3 TFL T	R3 HPL Tier 1 H	R3 HPL Tier 2 H	K9 HPL Tier 1 KH	K9 HPL Tier 2 KH	R3 H3 C3 ESS Veneer V	R3 H3 C3 ART Veneer V	K9 ESS Veneer KV	K9 ART Veneer KV
65T3672TT_	72	36	1	\$491	\$802	\$842	\$1,172	\$1,230	\$2,122	\$2,334	\$2,491	\$2,740
65T4272TT_	72	42	1	\$590	\$861	\$904	\$1,254	\$1,317	\$2,356	\$2,592	\$2,903	\$3,193
65T4872TT_	72	48	1	\$675	\$866	\$909	\$1,258	\$1,321	\$2,628	\$2,891	\$3,154	\$3,470
65T3678TT_	78	36	1	\$551	\$917	\$963	\$1,201	\$1,262	\$2,280	\$2,508	\$2,697	\$2,967
65T4278TT_	78	42	1	\$649	\$952	\$1,000	\$1,301	\$1,366	\$2,530	\$2,783	\$3,039	\$3,343
65T4878TT_	78	48	1	\$735	\$956	\$1,004	\$1,306	\$1,371	\$2,822	\$3,104	\$3,369	\$3,705
65T3684TT_	84	36	1	\$610	\$935	\$981	\$1,219	\$1,280	\$2,427	\$2,670	\$2,903	\$3,193
65T4284TT_	84	42	1	\$709	\$978	\$1,027	\$1,315	\$1,380	\$2,696	\$2,966	\$3,315	\$3,646
65T4884TT_	84	48	1	\$795	\$982	\$1,031	\$1,320	\$1,386	\$3,010	\$3,311	\$3,645	\$4,009
65T3690TT_	90	36	1	\$670	\$951	\$999	\$1,235	\$1,297	\$2,579	\$2,836	\$3,109	\$3,420
65T4290TT_	90	42	1	\$769	\$1,004	\$1,054	\$1,324	\$1,390	\$2,864	\$3,150	\$3,592	\$3,951
65T4890TT_	90	48	1	\$854	\$1,008	\$1,058	\$1,328	\$1,395	\$3,201	\$3,521	\$3,889	\$4,278
65T3696TT_	96	36	1	\$730	\$968	\$1,016	\$1,252	\$1,315	\$2,728	\$3,001	\$3,315	\$3,646
65T4296TT_	96	42	1	\$829	\$1,030	\$1,082	\$1,332	\$1,399	\$3,029	\$3,332	\$3,869	\$4,256
65T4896TT_	96	48	1	\$914	\$1,035	\$1,086	\$1,336	\$1,403	\$3,349	\$3,684	\$3,869	\$4,256
65T42102TT1_	102	42	1	\$860	\$1,513	\$1,588	\$2,058	\$2,161	\$3,466	\$3,813	\$3,895	\$4,284
65T48102TT1_	102	48	1	\$925	\$1,521	\$1,597	\$2,082	\$2,186	\$3,787	\$4,165	\$4,557	\$5,013
65T42102TT2_	102	42	2	\$1,066	\$1,627	\$1,708	\$2,214	\$2,325	\$3,728	\$4,101	\$4,187	\$4,606
65T48102TT2_	102	48	2	\$1,174	\$1,635	\$1,717	\$2,239	\$2,351	\$4,072	\$4,479	\$4,900	\$5,390
65T42108TT1_	108	42	1	\$906	\$1,536	\$1,613	\$2,063	\$2,166	\$3,623	\$3,985	\$4,130	\$4,543
65T48108TT1_	108	48	1	\$985	\$1,543	\$1,621	\$2,106	\$2,211	\$3,943	\$4,338	\$4,792	\$5,271
65T42108TT2_	108	42	2	\$1,119	\$1,652	\$1,734	\$2,218	\$2,329	\$3,896	\$4,286	\$4,440	\$4,884
65T48108TT2_	108	48	2	\$1,233	\$1,660	\$1,743	\$2,264	\$2,378	\$4,240	\$4,664	\$5,153	\$5,668
65T42114TT1_	114	42	1	\$952	\$1,560	\$1,638	\$2,087	\$2,191	\$3,799	\$4,179	\$4,396	\$4,835
65T48114TT1_	114	48	1	\$1,045	\$1,567	\$1,645	\$2,130	\$2,236	\$4,163	\$4,579	\$4,396	\$4,835
65T42114TT2_	114	42	2	\$1,173	\$1,677	\$1,761	\$2,243	\$2,355	\$4,085	\$4,494	\$4,726	\$5,199
65T48114TT2_	114	48	2	\$1,293	\$1,686	\$1,770	\$2,289	\$2,404	\$4,476	\$4,923	\$5,438	\$5,982

Model	TFL Top Surface	HPL Top Surface	Top Profile	Veneer Top Material	Top Surface Power Cutout
	<a href="#">see Anthology TFL Top Surface Finishes</a>	<a href="#">see Anthology HPL Top Surface Finishes</a>	<a href="#">see Anthology Top Profile Finishes</a> (when applicable)	<a href="#">see Anthology Veneer Top Material Finishes</a>	<a href="#">see Anthology Top Surface Power Cutout</a>

**Rectangular Table Tops (continued)**

- planning top specification [ANPG\\_6](#)
- base guide [pages 38-57](#)
- planning power guide [ANPG\\_20- ANPG\\_40](#)

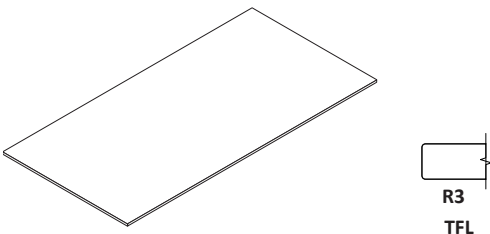

① Model	W	D	Top Pieces	R3 TFL	R3 HPL Tier 1 H	R3 HPL Tier 2 H	K9 HPL Tier 1 KH	K9 HPL Tier 2 KH	ESS Veneer V	ART Veneer V	ESS Veneer KV	ART Veneer KV
65T42120TT1_	120	42	1	\$999	\$1,583	\$1,662	\$2,109	\$2,215	\$3,976	\$4,374	\$4,660	\$5,126
65T48120TT1_	120	48	1	\$1,105	\$1,591	\$1,670	\$2,152	\$2,260	\$4,381	\$4,819	\$5,324	\$5,856
65T54120TT1_	120	54	1	\$1,210	\$1,788	\$1,877	\$2,425	\$2,546	\$4,830	\$5,313	\$5,834	\$6,418
65T60120TT1_	120	60	1	\$1,315	\$1,806	\$1,896	\$2,450	\$2,572	\$5,477	\$6,025	\$6,659	\$7,325
65T42120TT2_	120	42	2	\$1,226	\$1,702	\$1,787	\$2,268	\$2,381	\$4,275	\$4,702	\$5,011	\$5,513
65T48120TT2_	120	48	2	\$1,353	\$1,710	\$1,796	\$2,315	\$2,431	\$4,711	\$5,182	\$5,724	\$6,297
65T54120TT2_	120	54	2	\$1,480	\$1,922	\$2,019	\$2,607	\$2,738	\$5,194	\$5,713	\$6,273	\$6,900
65T60120TT2_	120	60	2	\$1,606	\$1,942	\$2,039	\$2,634	\$2,766	\$5,889	\$6,478	\$7,160	\$7,876
65T48126TT_	126	48	2	\$1,409	\$1,751	\$1,839	\$2,414	\$2,534	\$4,947	\$5,441	\$6,013	\$6,614
65T54126TT_	126	54	2	\$1,538	\$2,028	\$2,129	\$2,863	\$3,006	\$5,427	\$5,969	\$6,556	\$7,212
65T60126TT_	126	60	2	\$1,673	\$2,049	\$2,152	\$2,893	\$3,037	\$6,184	\$6,802	\$7,516	\$8,268
65T48132TT_	132	48	2	\$1,464	\$1,793	\$1,882	\$2,513	\$2,638	\$5,182	\$5,701	\$6,301	\$6,931
65T54132TT_	132	54	2	\$1,600	\$2,134	\$2,240	\$3,119	\$3,275	\$5,658	\$6,224	\$6,840	\$7,524
65T60132TT_	132	60	2	\$1,740	\$2,155	\$2,263	\$3,151	\$3,309	\$6,477	\$7,125	\$7,873	\$8,660
65T48138TT_	138	48	2	\$1,519	\$1,834	\$1,926	\$2,613	\$2,743	\$5,417	\$5,959	\$6,587	\$7,246
65T54138TT_	138	54	2	\$1,662	\$2,138	\$2,245	\$3,126	\$3,282	\$5,891	\$6,480	\$7,286	\$8,014
65T60138TT_	138	60	2	\$1,807	\$2,159	\$2,267	\$3,157	\$3,315	\$6,772	\$7,449	\$8,232	\$9,055
65T48144TT_	144	48	2	\$1,573	\$1,874	\$1,968	\$2,710	\$2,846	\$5,653	\$6,218	\$6,872	\$7,559
65T54144TT_	144	54	2	\$1,724	\$2,143	\$2,250	\$3,131	\$3,287	\$6,122	\$6,734	\$7,732	\$8,505
65T60144TT_	144	60	2	\$1,874	\$2,165	\$2,273	\$3,163	\$3,321	\$7,066	\$7,773	\$8,592	\$9,451
65T48150TT_	150	48	2	\$1,629	\$1,957	\$2,055	\$2,781	\$2,921	\$5,889	\$6,478	\$7,158	\$7,874
65T54150TT_	150	54	2	\$1,784	\$2,349	\$2,466	\$3,314	\$3,480	\$6,353	\$6,988	\$8,017	\$8,819
65T60150TT_	150	60	2	\$1,941	\$2,374	\$2,492	\$3,340	\$3,507	\$7,361	\$8,097	\$8,947	\$9,842
65T48156TT_	156	48	2	\$1,684	\$2,043	\$2,145	\$2,853	\$2,995	\$6,124	\$6,736	\$7,443	\$8,188
65T54156TT_	156	54	2	\$1,845	\$2,557	\$2,685	\$3,482	\$3,656	\$6,582	\$7,240	\$8,303	\$9,134
65T60156TT_	156	60	2	\$2,008	\$2,583	\$2,712	\$3,517	\$3,693	\$7,655	\$8,421	\$9,303	\$10,234

Model	TFL Top Surface	HPL Top Surface	Top Profile	Veneer Top Material	Top Surface Power Cutout
	see Anthology TFL Top Surface Finishes	see Anthology HPL Top Surface Finishes	see Anthology Top Profile Finishes (when applicable)	see Anthology Veneer Top Material Finishes	see Anthology Top Surface Power Cutout

**Rectangular Table Tops (continued)**

- planning top specification [ANPG\\_6](#)
- base guide [pages 38-57](#)
- planning power guide [ANPG\\_20- ANPG\\_40](#)

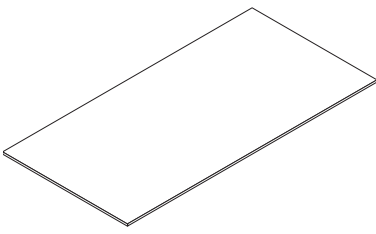

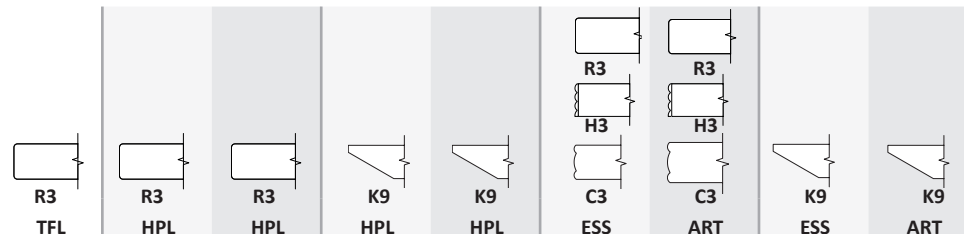
① Model	W	D	Top Pieces										
				T	H	H	KH	KH	V	V	KV	KV	
65T48162TT_	162	48	2	\$1,739	\$2,121	\$2,227	\$2,923	\$3,069	\$6,360	\$6,996	\$7,730	\$8,503	
65T54162TT_	162	54	2	\$1,906	\$2,560	\$2,688	\$3,487	\$3,661	\$6,982	\$7,680	\$8,662	\$9,528	
65T60162TT_	162	60	2	\$2,075	\$2,586	\$2,715	\$3,523	\$3,699	\$7,950	\$8,745	\$9,663	\$10,629	
65T48168TT_	168	48	2	\$1,794	\$2,203	\$2,313	\$2,993	\$3,142	\$6,596	\$7,255	\$8,014	\$8,815	
65T54168TT_	168	54	2	\$1,967	\$2,564	\$2,692	\$3,494	\$3,669	\$7,383	\$8,121	\$9,021	\$9,923	
65T60168TT_	168	60	2	\$2,142	\$2,591	\$2,720	\$3,530	\$3,707	\$8,244	\$9,068	\$10,022	\$11,025	
65T48174TT_	174	48	2	\$1,848	\$2,207	\$2,317	\$2,999	\$3,149	\$6,830	\$7,513	\$8,303	\$9,134	
65T54174TT_	174	54	2	\$2,028	\$2,566	\$2,695	\$3,499	\$3,674	\$7,638	\$8,402	\$9,307	\$10,237	
65T60174TT_	174	60	2	\$2,209	\$2,593	\$2,723	\$3,535	\$3,712	\$8,538	\$9,392	\$10,378	\$11,415	
65T48180TT_	180	48	2	\$1,903	\$2,210	\$2,320	\$3,004	\$3,154	\$7,066	\$7,773	\$8,592	\$9,451	
65T54180TT_	180	54	2	\$2,088	\$2,574	\$2,703	\$3,507	\$3,682	\$7,893	\$8,683	\$9,592	\$10,551	
65T60180TT_	180	60	2	\$2,276	\$2,601	\$2,731	\$3,543	\$3,720	\$8,833	\$9,716	\$10,734	\$11,807	
65T48186TT_	186	48	2	\$1,959	\$2,214	\$2,325	\$3,011	\$3,162	\$7,302	\$8,032	\$8,877	\$9,765	
65T54186TT_	186	54	2	\$2,150	\$2,579	\$2,707	\$3,512	\$3,687	\$8,133	\$8,947	\$9,948	\$10,943	
65T60186TT_	186	60	2	\$2,343	\$2,604	\$2,735	\$3,548	\$3,725	\$9,127	\$10,040	\$11,094	\$12,203	
65T48192TT_	192	48	2	\$2,014	\$2,219	\$2,330	\$3,017	\$3,168	\$7,537	\$8,291	\$9,162	\$10,079	
65T54192TT_	192	54	2	\$2,212	\$2,583	\$2,712	\$3,517	\$3,693	\$8,375	\$9,213	\$10,305	\$11,335	
65T60192TT_	192	60	2	\$2,411	\$2,608	\$2,739	\$3,554	\$3,732	\$9,422	\$10,364	\$11,453	\$12,598	
65T48198TT_	198	48	2	\$2,087	\$3,089	\$3,244	\$4,170	\$4,378	\$8,604	\$9,464	\$10,406	\$11,446	
65T54198TT_	198	54	2	\$2,291	\$3,517	\$3,693	\$4,790	\$5,029	\$9,574	\$10,532	\$11,521	\$12,673	
65T60198TT_	198	60	2	\$2,497	\$3,554	\$3,732	\$4,838	\$5,080	\$10,746	\$11,821	\$12,933	\$14,226	
65T48204TT_	204	48	2	\$2,159	\$3,132	\$3,288	\$4,251	\$4,464	\$8,856	\$9,742	\$10,658	\$11,724	
65T54204TT_	204	54	2	\$2,371	\$3,525	\$3,701	\$4,796	\$5,036	\$9,899	\$10,889	\$11,912	\$13,104	
65T60204TT_	204	60	2	\$2,584	\$3,562	\$3,740	\$4,846	\$5,088	\$11,070	\$12,177	\$13,326	\$14,658	
65T48210TT_	210	48	2	\$2,233	\$3,136	\$3,293	\$4,259	\$4,471	\$9,115	\$10,026	\$10,970	\$12,067	
65T54210TT_	210	54	2	\$2,450	\$3,529	\$3,706	\$4,802	\$5,042	\$10,222	\$11,244	\$12,304	\$13,534	
65T60210TT_	210	60	2	\$2,670	\$3,565	\$3,744	\$4,852	\$5,094	\$11,394	\$12,534	\$13,717	\$15,089	

Model	TFL Top Surface	HPL Top Surface	Top Profile	Veneer Top Material	Top Surface Power Cutout
	<a href="#">see Anthology TFL Top Surface Finishes</a>	<a href="#">see Anthology HPL Top Surface Finishes</a>	<a href="#">see Anthology Top Profile Finishes</a> (when applicable)	<a href="#">see Anthology Veneer Top Material Finishes</a>	<a href="#">see Anthology Top Surface Power Cutout</a>

**Rectangular Table Tops (continued)**

- planning top specification [ANPG\\_6](#)
- base guide [pages 38-57](#)
- planning power guide [ANPG\\_20- ANPG\\_40](#)

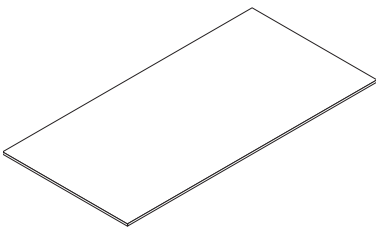

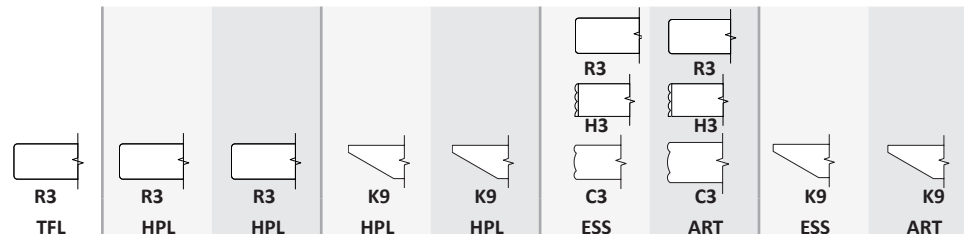
① Model	W	D	Top Pieces										
				T	H	H	KH	KH	V	V	KV	KV	
65T48216TT_	216	48	3	\$2,305	\$3,140	\$3,297	\$4,266	\$4,479	\$9,375	\$10,312	\$11,282	\$12,410	
65T54216TT_	216	54	3	\$2,529	\$3,533	\$3,710	\$4,808	\$5,048	\$10,547	\$11,601	\$12,695	\$13,965	
65T60216TT_	216	60	3	\$2,757	\$3,569	\$3,748	\$4,857	\$5,100	\$11,718	\$12,890	\$14,108	\$15,519	
65T48222TT_	222	48	3	\$2,378	\$3,144	\$3,301	\$4,271	\$4,484	\$9,636	\$10,600	\$11,597	\$12,757	
65T54222TT_	222	54	3	\$2,608	\$3,588	\$3,767	\$4,884	\$5,128	\$10,808	\$11,889	\$13,010	\$14,311	
65T60222TT_	222	60	3	\$2,843	\$3,625	\$3,806	\$4,934	\$5,181	\$12,045	\$13,250	\$14,500	\$15,950	
65T48228TT_	228	48	3	\$2,451	\$3,148	\$3,306	\$4,277	\$4,491	\$9,899	\$10,889	\$11,912	\$13,104	
65T54228TT_	228	54	3	\$2,688	\$3,643	\$3,825	\$4,959	\$5,207	\$11,070	\$12,177	\$13,326	\$14,658	
65T60228TT_	228	60	3	\$2,930	\$3,681	\$3,865	\$5,010	\$5,261	\$12,372	\$13,609	\$14,891	\$16,380	
65T48234TT_	234	48	3	\$2,524	\$3,271	\$3,434	\$4,340	\$4,557	\$10,157	\$11,173	\$12,225	\$13,447	
65T54234TT_	234	54	3	\$2,767	\$3,648	\$3,830	\$4,965	\$5,213	\$11,394	\$12,534	\$13,717	\$15,089	
65T60234TT_	234	60	3	\$3,016	\$3,686	\$3,870	\$5,017	\$5,267	\$12,695	\$13,965	\$15,283	\$16,811	
65T48240TT_	240	48	3	\$2,597	\$3,394	\$3,564	\$4,403	\$4,623	\$10,417	\$11,459	\$12,537	\$13,790	
65T54240TT_	240	54	3	\$2,849	\$3,653	\$3,835	\$4,972	\$5,221	\$11,718	\$12,890	\$14,108	\$15,519	
65T60240TT_	240	60	3	\$3,103	\$3,691	\$3,876	\$5,023	\$5,274	\$13,020	\$14,322	\$15,675	\$17,242	

Model	TFL Top Surface	HPL Top Surface	Top Profile	Veneer Top Material	Top Surface Power Cutout
	see Anthology TFL Top Surface Finishes	see Anthology HPL Top Surface Finishes	see Anthology Top Profile Finishes (when applicable)	see Anthology Veneer Top Material Finishes	see Anthology Top Surface Power Cutout

**Soft Rectangular Table Tops**

- 3" radius corners
- planning top specification [ANPG\\_6](#)
- base guide [pages 38-57](#)
- planning power guide [ANPG\\_20- ANPG\\_40](#)

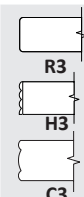
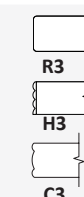
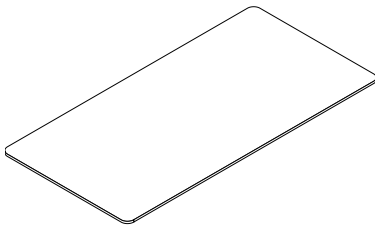

Model	W	D	Top Pieces	TFL T	HPL Tier 1 H	HPL Tier 2 H	HPL Tier 1 KH	HPL Tier 2 KH	ESS Veneer V	ART Veneer V	ESS Veneer KV	ART Veneer KV
65T3672SR_	72	36	1	\$491	\$802	\$842	\$1,172	\$1,230	\$2,122	\$2,334	\$2,491	\$2,740
65T4272SR_	72	42	1	\$590	\$861	\$904	\$1,254	\$1,317	\$2,356	\$2,592	\$2,903	\$3,193
65T4872SR_	72	48	1	\$675	\$866	\$909	\$1,258	\$1,321	\$2,628	\$2,891	\$3,154	\$3,470
65T3678SR_	78	36	1	\$551	\$917	\$963	\$1,201	\$1,262	\$2,280	\$2,508	\$2,697	\$2,967
65T4278SR_	78	42	1	\$649	\$952	\$1,000	\$1,301	\$1,366	\$2,530	\$2,783	\$3,039	\$3,343
65T4878SR_	78	48	1	\$735	\$956	\$1,004	\$1,306	\$1,371	\$2,822	\$3,104	\$3,369	\$3,705
65T3684SR_	84	36	1	\$610	\$935	\$981	\$1,219	\$1,280	\$2,427	\$2,670	\$2,903	\$3,193
65T4284SR_	84	42	1	\$709	\$978	\$1,027	\$1,315	\$1,380	\$2,696	\$2,966	\$3,315	\$3,646
65T4884SR_	84	48	1	\$795	\$982	\$1,031	\$1,320	\$1,386	\$3,010	\$3,311	\$3,645	\$4,009
65T3690SR_	90	36	1	\$670	\$951	\$999	\$1,235	\$1,297	\$2,579	\$2,836	\$3,109	\$3,420
65T4290SR_	90	42	1	\$769	\$1,004	\$1,054	\$1,324	\$1,390	\$2,864	\$3,150	\$3,592	\$3,951
65T4890SR_	90	48	1	\$854	\$1,008	\$1,058	\$1,328	\$1,395	\$3,201	\$3,521	\$3,889	\$4,278
65T3696SR_	96	36	1	\$730	\$968	\$1,016	\$1,252	\$1,315	\$2,728	\$3,001	\$3,315	\$3,646
65T4296SR_	96	42	1	\$829	\$1,030	\$1,082	\$1,332	\$1,399	\$3,029	\$3,332	\$3,869	\$4,256
65T4896SR_	96	48	1	\$914	\$1,035	\$1,086	\$1,336	\$1,403	\$3,349	\$3,684	\$4,134	\$4,547
65T42102SR1_	102	42	1	\$860	\$3,029	\$3,180	\$2,058	\$2,161	\$3,466	\$3,813	\$3,895	\$4,284
65T48102SR1_	102	48	1	\$925	\$3,349	\$3,516	\$2,082	\$2,186	\$3,787	\$4,165	\$4,557	\$5,013
65T42102SR2_	102	42	2	\$1,066	\$1,627	\$1,708	\$2,214	\$2,325	\$3,728	\$4,101	\$4,187	\$4,606
65T48102SR2_	102	48	2	\$1,174	\$1,635	\$1,717	\$2,239	\$2,351	\$4,072	\$4,479	\$4,900	\$5,390
65T42108SR1_	108	42	1	\$906	\$1,536	\$1,613	\$2,063	\$2,166	\$3,623	\$3,985	\$4,130	\$4,543
65T48108SR1_	108	48	1	\$985	\$1,543	\$1,621	\$2,106	\$2,211	\$3,943	\$4,338	\$4,792	\$5,271
65T42108SR2_	108	42	2	\$1,119	\$1,652	\$1,734	\$2,218	\$2,329	\$3,896	\$4,286	\$4,440	\$4,884
65T48108SR2_	108	48	2	\$1,233	\$1,660	\$1,743	\$2,264	\$2,378	\$4,240	\$4,664	\$5,153	\$5,668
65T42114SR1_	114	42	1	\$952	\$1,560	\$1,638	\$2,087	\$2,191	\$3,799	\$4,179	\$4,396	\$4,835
65T48114SR1_	114	48	1	\$1,045	\$1,567	\$1,645	\$2,130	\$2,236	\$4,163	\$4,579	\$5,057	\$5,562
65T42114SR2_	114	42	2	\$1,173	\$1,677	\$1,761	\$2,243	\$2,355	\$4,085	\$4,494	\$4,726	\$5,199
65T48114SR2_	114	48	2	\$1,293	\$1,686	\$1,770	\$2,289	\$2,404	\$4,476	\$4,923	\$5,438	\$5,982

Model	TFL Top Surface	HPL Top Surface	Top Profile	Veneer Top Material	Top Surface Power Cutout
	<a href="#">see Anthology TFL Top Surface Finishes</a>	<a href="#">see Anthology HPL Top Surface Finishes</a>	<a href="#">see Anthology Top Profile Finishes</a> (when applicable)	<a href="#">see Anthology Veneer Top Material Finishes</a>	<a href="#">see Anthology Top Surface Power Cutout</a>

**Soft Rectangular Table Tops (continued)**

- 3" radius corners
- planning top specification [ANPG\\_6](#)
- base guide [pages 38-57](#)
- planning power guide [ANPG\\_20- ANPG\\_40](#)

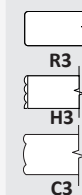
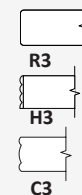
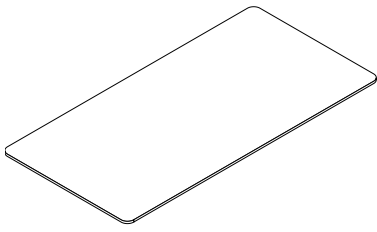

Model	W	D	Top Pieces	TFL R3 T	HPL Tier 1 R3 H	HPL Tier 2 R3 H	HPL Tier 1 K9 KH	HPL Tier 2 K9 KH	ESS Veneer R3 H3 C3 V	ART Veneer R3 H3 C3 V	ESS Veneer K9 KV	ART Veneer K9 KV
65T42120SR1_	120	42	1	\$999	\$1,583	\$1,662	\$2,109	\$2,215	\$3,976	\$4,374	\$4,660	\$5,126
65T48120SR1_	120	48	1	\$1,105	\$1,591	\$1,670	\$2,152	\$2,260	\$4,381	\$4,819	\$5,324	\$5,856
65T54120SR1_	120	54	1	\$1,210	\$1,788	\$1,877	\$2,425	\$2,546	\$4,830	\$5,313	\$5,834	\$6,418
65T60120SR1_	120	60	1	\$1,315	\$1,806	\$1,896	\$2,450	\$2,572	\$5,477	\$6,025	\$6,659	\$7,325
65T42120SR2_	120	42	2	\$1,226	\$1,702	\$1,787	\$2,268	\$2,381	\$4,275	\$4,702	\$5,011	\$5,513
65T48120SR2_	120	48	2	\$1,353	\$1,710	\$1,796	\$2,315	\$2,431	\$4,711	\$5,182	\$5,724	\$6,297
65T54120SR2_	120	54	2	\$1,480	\$1,922	\$2,019	\$2,607	\$2,738	\$5,194	\$5,713	\$6,273	\$6,900
65T60120SR2_	120	60	2	\$1,606	\$1,942	\$2,039	\$2,634	\$2,766	\$5,889	\$6,478	\$7,160	\$7,876
65T48126SR_	126	48	2	\$1,409	\$1,751	\$1,839	\$2,414	\$2,534	\$4,947	\$5,441	\$6,013	\$6,614
65T54126SR_	126	54	2	\$1,538	\$2,028	\$2,129	\$2,863	\$3,006	\$5,427	\$5,969	\$6,556	\$7,212
65T60126SR_	126	60	2	\$1,673	\$2,049	\$2,152	\$2,893	\$3,037	\$6,184	\$6,802	\$7,516	\$8,268
65T48132SR_	132	48	2	\$1,464	\$1,793	\$1,882	\$2,513	\$2,638	\$5,182	\$5,701	\$6,301	\$6,931
65T54132SR_	132	54	2	\$1,600	\$2,134	\$2,240	\$3,119	\$3,275	\$5,658	\$6,224	\$6,840	\$7,524
65T60132SR_	132	60	2	\$1,740	\$2,155	\$2,263	\$3,151	\$3,309	\$6,477	\$7,125	\$7,873	\$8,660
65T48138SR_	138	48	2	\$1,519	\$1,834	\$1,926	\$2,613	\$2,743	\$5,417	\$5,959	\$6,587	\$7,246
65T54138SR_	138	54	2	\$1,662	\$2,138	\$2,245	\$3,126	\$3,282	\$5,891	\$6,480	\$7,286	\$8,014
65T60138SR_	138	60	2	\$1,807	\$2,159	\$2,267	\$3,157	\$3,315	\$6,772	\$7,449	\$8,232	\$9,055
65T48144SR_	144	48	2	\$1,573	\$1,874	\$1,968	\$2,710	\$2,846	\$5,653	\$6,218	\$6,872	\$7,559
65T54144SR_	144	54	2	\$1,724	\$2,143	\$2,250	\$3,131	\$3,287	\$6,122	\$6,734	\$7,732	\$8,505
65T60144SR_	144	60	2	\$1,874	\$2,165	\$2,273	\$3,163	\$3,321	\$7,066	\$7,773	\$8,592	\$9,451
65T48150SR_	150	48	2	\$1,629	\$1,957	\$2,055	\$2,781	\$2,921	\$5,889	\$6,478	\$7,158	\$7,874
65T54150SR_	150	54	2	\$1,784	\$2,349	\$2,466	\$3,314	\$3,480	\$6,353	\$6,988	\$8,017	\$8,819
65T60150SR_	150	60	2	\$1,941	\$2,374	\$2,492	\$3,340	\$3,507	\$7,361	\$8,097	\$8,947	\$9,842
65T48156SR_	156	48	2	\$1,684	\$2,043	\$2,145	\$2,853	\$2,995	\$6,124	\$6,736	\$7,443	\$8,188
65T54156SR_	156	54	2	\$1,845	\$2,557	\$2,685	\$3,482	\$3,656	\$6,582	\$7,240	\$8,303	\$9,134
65T60156SR_	156	60	2	\$2,008	\$2,583	\$2,712	\$3,517	\$3,693	\$7,655	\$8,421	\$9,303	\$10,234

Model	TFL Top Surface	HPL Top Surface	Top Profile	Veneer Top Material	Top Surface Power Cutout
	see Anthology TFL Top Surface Finishes	see Anthology HPL Top Surface Finishes	see Anthology Top Profile Finishes (when applicable)	see Anthology Veneer Top Material Finishes	see Anthology Top Surface Power Cutout



**Soft Rectangular Table Tops (continued)**

- 3" radius corners
- planning top specification [ANPG\\_6](#)
- base guide [pages 38-57](#)
- planning power guide [ANPG\\_20- ANPG\\_40](#)

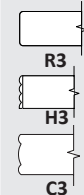
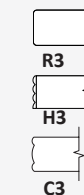
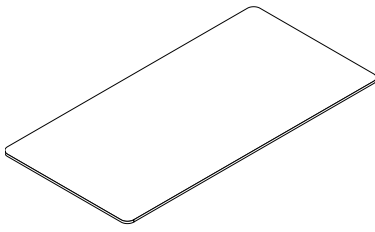

① Model	W	D	Top Pieces	R3 TFL T	R3 HPL Tier 1 H	R3 HPL Tier 2 H	K9 HPL Tier 1 KH	K9 HPL Tier 2 KH	R3 H3 C3 ESS Veneer V	R3 H3 C3 ART Veneer V	K9 ESS Veneer KV	K9 ART Veneer KV
65T48162SR_	162	48	2	\$1,739	\$2,121	\$2,227	\$2,923	\$3,069	\$6,360	\$6,996	\$7,730	\$8,503
65T54162SR_	162	54	2	\$1,906	\$2,560	\$2,688	\$3,487	\$3,661	\$6,982	\$7,680	\$8,662	\$9,528
65T60162SR_	162	60	2	\$2,075	\$2,586	\$2,715	\$3,523	\$3,699	\$7,950	\$8,745	\$9,663	\$10,629
65T48168SR_	168	48	2	\$1,794	\$2,203	\$2,313	\$2,993	\$3,142	\$6,596	\$7,255	\$8,014	\$8,815
65T54168SR_	168	54	2	\$1,967	\$2,564	\$2,692	\$3,494	\$3,669	\$7,383	\$8,121	\$9,021	\$9,923
65T60168SR_	168	60	2	\$2,142	\$2,591	\$2,720	\$3,530	\$3,707	\$8,244	\$9,068	\$10,022	\$11,025
65T48174SR_	174	48	2	\$1,848	\$2,207	\$2,317	\$2,999	\$3,149	\$6,830	\$7,513	\$8,303	\$9,134
65T54174SR_	174	54	2	\$2,028	\$2,566	\$2,695	\$3,499	\$3,674	\$7,638	\$8,402	\$9,307	\$10,237
65T60174SR_	174	60	2	\$2,209	\$2,593	\$2,723	\$3,535	\$3,712	\$8,538	\$9,392	\$10,378	\$11,415
65T48180SR_	180	48	2	\$1,903	\$2,210	\$2,320	\$3,004	\$3,154	\$7,066	\$7,773	\$8,592	\$9,451
65T54180SR_	180	54	2	\$2,088	\$2,574	\$2,703	\$3,507	\$3,682	\$7,893	\$8,683	\$9,592	\$10,551
65T60180SR_	180	60	2	\$2,276	\$2,601	\$2,731	\$3,543	\$3,720	\$8,833	\$9,716	\$10,734	\$11,807
65T48186SR_	186	48	2	\$1,959	\$2,214	\$2,325	\$3,011	\$3,162	\$7,302	\$8,032	\$8,877	\$9,765
65T54186SR_	186	54	2	\$2,150	\$2,579	\$2,707	\$3,512	\$3,687	\$8,133	\$8,947	\$9,948	\$10,943
65T60186SR_	186	60	2	\$2,343	\$2,604	\$2,735	\$3,548	\$3,725	\$9,127	\$10,040	\$11,094	\$12,203
65T48192SR_	192	48	2	\$2,014	\$2,219	\$2,330	\$3,017	\$3,168	\$7,537	\$8,291	\$9,162	\$10,079
65T54192SR_	192	54	2	\$2,212	\$2,583	\$2,712	\$3,517	\$3,693	\$8,375	\$9,213	\$10,305	\$11,335
65T60192SR_	192	60	2	\$2,411	\$2,608	\$2,739	\$3,554	\$3,732	\$9,422	\$10,364	\$11,453	\$12,598
65T48198SR_	198	48	3	\$2,087	\$2,583	\$2,712	\$4,170	\$4,378	\$8,604	\$9,464	\$10,406	\$11,446
65T54198SR_	198	54	3	\$2,291	\$3,517	\$3,693	\$4,790	\$5,029	\$9,574	\$10,532	\$11,521	\$12,673
65T60198SR_	198	60	3	\$2,497	\$3,554	\$3,732	\$4,838	\$5,080	\$10,746	\$11,821	\$12,933	\$14,226
65T48204SR_	204	48	3	\$2,159	\$3,132	\$3,288	\$4,251	\$4,464	\$8,856	\$9,742	\$10,658	\$11,724
65T54204SR_	204	54	3	\$2,371	\$3,525	\$3,701	\$4,796	\$5,036	\$9,899	\$10,889	\$11,912	\$13,104
65T60204SR_	204	60	3	\$2,584	\$3,562	\$3,740	\$4,846	\$5,088	\$11,070	\$12,177	\$13,326	\$14,658
65T48210SR_	210	48	3	\$2,233	\$3,136	\$3,293	\$4,259	\$4,471	\$9,115	\$10,026	\$10,970	\$12,067
65T54210SR_	210	54	3	\$2,450	\$3,529	\$3,706	\$4,802	\$5,042	\$10,222	\$11,244	\$12,304	\$13,534
65T60210SR_	210	60	3	\$2,670	\$3,565	\$3,744	\$4,852	\$5,094	\$11,394	\$12,534	\$13,717	\$15,089

Model	TFL Top Surface	HPL Top Surface	Top Profile	Veneer Top Material	Top Surface Power Cutout
	see Anthology TFL Top Surface Finishes	see Anthology HPL Top Surface Finishes	see Anthology Top Profile Finishes (when applicable)	see Anthology Veneer Top Material Finishes	see Anthology Top Surface Power Cutout



**Soft Rectangular Table Tops (continued)**

- 3" radius corners
- planning top specification [ANPG\\_6](#)
- base guide [pages 38-57](#)
- planning power guide [ANPG\\_20- ANPG\\_40](#)

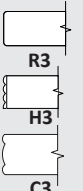
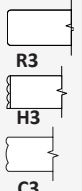
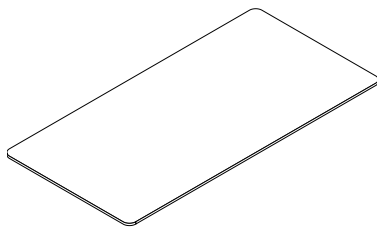

① Model	W	D	Top Pieces	R3 TFL T	R3 HPL Tier 1 H	R3 HPL Tier 2 H	K9 HPL Tier 1 KH	K9 HPL Tier 2 KH	R3 H3 C3 ESS Veneer V	R3 H3 C3 ART Veneer V	K9 ESS Veneer KV	K9 ART Veneer KV
65T48216SR_	216	48	3	\$2,305	\$3,140	\$3,297	\$4,266	\$4,479	\$9,375	\$10,312	\$11,282	\$12,410
65T54216SR_	216	54	3	\$2,529	\$3,533	\$3,710	\$4,808	\$5,048	\$10,547	\$11,601	\$12,695	\$13,965
65T60216SR_	216	60	3	\$2,757	\$3,569	\$3,748	\$4,857	\$5,100	\$11,718	\$12,890	\$14,108	\$15,519
65T48222SR_	222	48	3	\$2,378	\$3,144	\$3,301	\$4,271	\$4,484	\$9,636	\$10,600	\$11,597	\$12,757
65T54222SR_	222	54	3	\$2,608	\$3,588	\$3,767	\$4,884	\$5,128	\$10,808	\$11,889	\$13,010	\$14,311
65T60222SR_	222	60	3	\$2,843	\$3,625	\$3,806	\$4,934	\$5,181	\$12,045	\$13,250	\$14,500	\$15,950
65T48228SR_	228	48	3	\$2,451	\$3,148	\$3,306	\$4,277	\$4,491	\$9,899	\$10,889	\$11,912	\$13,104
65T54228SR_	228	54	3	\$2,688	\$3,643	\$3,825	\$4,959	\$5,207	\$11,070	\$12,177	\$13,326	\$14,658
65T60228SR_	228	60	3	\$2,930	\$3,681	\$3,865	\$5,010	\$5,261	\$12,372	\$13,609	\$14,891	\$16,380
65T48234SR_	234	48	3	\$2,524	\$3,271	\$3,434	\$4,340	\$4,557	\$10,157	\$11,173	\$12,225	\$13,447
65T54234SR_	234	54	3	\$2,767	\$3,648	\$3,830	\$4,965	\$5,213	\$11,394	\$12,534	\$13,717	\$15,089
65T60234SR_	234	60	3	\$3,016	\$3,686	\$3,870	\$5,017	\$5,267	\$12,695	\$13,965	\$15,283	\$16,811
65T48240SR_	240	48	3	\$2,597	\$3,394	\$3,564	\$4,403	\$4,623	\$10,417	\$11,459	\$12,537	\$13,790
65T54240SR_	240	54	3	\$2,849	\$3,653	\$3,835	\$4,972	\$5,221	\$11,718	\$12,890	\$14,108	\$15,519
65T60240SR_	240	60	3	\$3,103	\$3,691	\$3,876	\$5,023	\$5,274	\$13,020	\$14,322	\$15,675	\$17,242

Model	TFL Top Surface	HPL Top Surface	Top Profile	Veneer Top Material	Top Surface Power Cutout
	<a href="#">see Anthology TFL Top Surface Finishes</a>	<a href="#">see Anthology HPL Top Surface Finishes</a>	<a href="#">see Anthology Top Profile Finishes</a> (when applicable)	<a href="#">see Anthology Veneer Top Material Finishes</a>	<a href="#">see Anthology Top Surface Power Cutout</a>

**Arc Rectangular Table Tops**

- planning top specification [ANPG\\_6](#)
- base guide [pages 38-57](#)
- planning power guide [ANPG\\_20- ANPG\\_40](#)

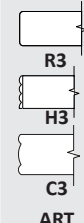
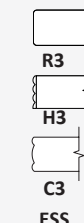
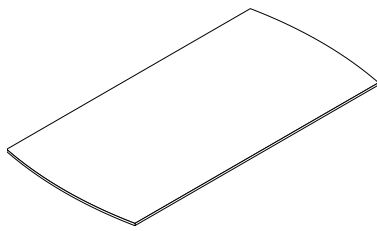

Model	W	D	Top Pieces	R3 TFL T	R3 HPL Tier 1 H	R3 HPL Tier 2 H	K9 HPL Tier 1 KH	K9 HPL Tier 2 KH	R3 H3 C3 ESS Veneer V	R3 H3 C3 ART Veneer V	K9 ESS Veneer KV	K9 ART Veneer KV
65T3672AR_	72	36	1	\$491	\$802	\$842	\$1,172	\$1,230	\$2,122	\$2,334	\$2,491	\$2,740
65T4272AR_	72	42	1	\$590	\$861	\$904	\$1,254	\$1,317	\$2,356	\$2,592	\$2,903	\$3,193
65T4872AR_	72	48	1	\$675	\$866	\$909	\$1,258	\$1,321	\$2,628	\$2,891	\$3,154	\$3,470
65T3678AR_	78	36	1	\$551	\$917	\$963	\$1,201	\$1,262	\$2,280	\$2,508	\$2,697	\$2,967
65T4278AR_	78	42	1	\$649	\$952	\$1,000	\$1,301	\$1,366	\$2,530	\$2,783	\$3,039	\$3,343
65T4878AR_	78	48	1	\$735	\$956	\$1,004	\$1,306	\$1,371	\$2,822	\$3,104	\$3,369	\$3,705
65T3684AR_	84	36	1	\$610	\$935	\$981	\$1,219	\$1,280	\$2,427	\$2,670	\$2,903	\$3,193
65T4284AR_	84	42	1	\$709	\$978	\$1,027	\$1,315	\$1,380	\$2,696	\$2,966	\$3,315	\$3,646
65T4884AR_	84	48	1	\$795	\$982	\$1,031	\$1,320	\$1,386	\$3,010	\$3,311	\$3,645	\$4,009
65T3690AR_	90	36	1	\$670	\$951	\$999	\$1,235	\$1,297	\$2,579	\$2,836	\$3,109	\$3,420
65T4290AR_	90	42	1	\$769	\$1,004	\$1,054	\$1,324	\$1,390	\$2,864	\$3,150	\$3,592	\$3,951
65T4890AR_	90	48	1	\$854	\$1,008	\$1,058	\$1,328	\$1,395	\$3,201	\$3,521	\$3,592	\$3,951
65T3696AR_	96	36	1	\$730	\$968	\$1,016	\$1,252	\$1,315	\$2,728	\$3,001	\$3,315	\$3,646
65T4296AR_	96	42	1	\$829	\$1,030	\$1,082	\$1,332	\$1,399	\$3,029	\$3,332	\$3,869	\$4,256
65T4896AR_	96	48	1	\$914	\$1,035	\$1,086	\$1,336	\$1,403	\$3,349	\$3,684	\$3,869	\$4,256
65T42102AR1_	102	42	1	\$860	\$1,513	\$1,588	\$2,058	\$2,161	\$3,466	\$3,813	\$3,895	\$4,284
65T48102AR1_	102	48	1	\$925	\$1,521	\$1,597	\$2,082	\$2,186	\$3,787	\$4,165	\$4,557	\$5,013
65T42102AR2_	102	42	2	\$1,066	\$1,627	\$1,708	\$2,214	\$2,325	\$3,728	\$4,101	\$4,187	\$4,606
65T48102AR2_	102	48	2	\$1,174	\$1,635	\$1,717	\$2,239	\$2,351	\$4,072	\$4,479	\$4,900	\$5,390
65T42108AR1_	108	42	1	\$906	\$1,536	\$1,613	\$2,063	\$2,166	\$3,623	\$3,985	\$4,130	\$4,543
65T48108AR1_	108	48	1	\$985	\$1,543	\$1,621	\$2,106	\$2,211	\$3,943	\$4,338	\$4,792	\$5,271
65T42108AR2_	108	42	2	\$1,119	\$1,652	\$1,734	\$2,218	\$2,329	\$3,896	\$4,286	\$4,440	\$4,884
65T48108AR2_	108	48	2	\$1,233	\$1,660	\$1,743	\$2,264	\$2,378	\$4,240	\$4,664	\$5,153	\$5,668
65T42114AR1_	114	42	1	\$952	\$1,560	\$1,638	\$2,087	\$2,191	\$3,799	\$4,179	\$4,396	\$4,835
65T48114AR1_	114	48	1	\$1,045	\$1,567	\$1,645	\$2,130	\$2,236	\$4,163	\$4,579	\$5,057	\$5,562
65T42114AR2_	114	42	2	\$1,173	\$1,677	\$1,761	\$2,243	\$2,355	\$4,085	\$4,494	\$4,726	\$5,199
65T48114AR2_	114	48	2	\$1,293	\$1,686	\$1,770	\$2,289	\$2,404	\$4,476	\$4,923	\$5,438	\$5,982

Model	TFL Top Surface	HPL Top Surface	Top Profile	Veneer Top Material	Top Surface Power Cutout
	<a href="#">see Anthology TFL Top Surface Finishes</a>	<a href="#">see Anthology HPL Top Surface Finishes</a>	<a href="#">see Anthology Top Profile Finishes</a> (when applicable)	<a href="#">see Anthology Veneer Top Material Finishes</a>	<a href="#">see Anthology Top Surface Power Cutout</a>

**Arc Rectangular Table Tops (continued)**

- planning top specification [ANPG\\_6](#)
- base guide [pages 38-57](#)
- planning power guide [ANPG\\_20- ANPG\\_40](#)

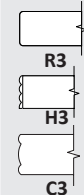
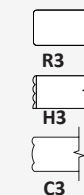
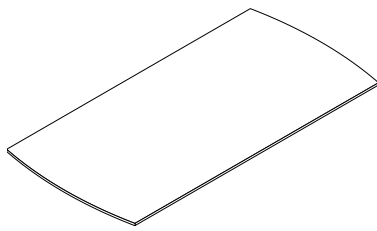

① Model	W	D	Top Pieces	R3 TFL T	R3 HPL Tier 1 H	R3 HPL Tier 2 H	K9 HPL Tier 1 KH	K9 HPL Tier 2 KH	R3 H3 C3 ESS Veneer V	R3 H3 C3 ART Veneer V	K9 ESS Veneer KV	K9 ART Veneer KV
65T42120AR1_	120	42	1	\$999	\$1,583	\$1,662	\$2,109	\$2,215	\$3,976	\$4,374	\$4,660	\$5,126
65T48120AR1_	120	48	1	\$1,105	\$1,591	\$1,670	\$2,152	\$2,260	\$4,381	\$4,819	\$5,324	\$5,856
65T54120AR1_	120	54	1	\$1,210	\$1,788	\$1,877	\$2,425	\$2,546	\$4,830	\$5,313	\$5,834	\$6,418
65T60120AR1_	120	60	1	\$1,315	\$1,806	\$1,896	\$2,450	\$2,572	\$5,477	\$6,025	\$6,659	\$7,325
65T42120AR2_	120	42	2	\$1,226	\$1,702	\$1,787	\$2,268	\$2,381	\$4,275	\$4,702	\$5,011	\$5,513
65T48120AR2_	120	48	2	\$1,353	\$1,710	\$1,796	\$2,315	\$2,431	\$4,711	\$5,182	\$5,724	\$6,297
65T54120AR2_	120	54	2	\$1,480	\$1,922	\$2,019	\$2,607	\$2,738	\$5,194	\$5,713	\$6,273	\$6,900
65T60120AR2_	120	60	2	\$1,606	\$1,942	\$2,039	\$2,634	\$2,766	\$5,889	\$6,478	\$7,160	\$7,876
65T48126AR_	126	48	2	\$1,409	\$1,751	\$1,839	\$2,414	\$2,534	\$4,947	\$5,441	\$6,013	\$6,614
65T54126AR_	126	54	2	\$1,538	\$2,028	\$2,129	\$2,863	\$3,006	\$5,427	\$5,969	\$6,556	\$7,212
65T60126AR_	126	60	2	\$1,673	\$2,049	\$2,152	\$2,893	\$3,037	\$6,184	\$6,802	\$7,516	\$8,268
65T48132AR_	132	48	2	\$1,464	\$1,793	\$1,882	\$2,513	\$2,638	\$5,182	\$5,701	\$6,301	\$6,931
65T54132AR_	132	54	2	\$1,600	\$2,134	\$2,240	\$3,119	\$3,275	\$5,658	\$6,224	\$6,840	\$7,524
65T60132AR_	132	60	2	\$1,740	\$2,155	\$2,263	\$3,151	\$3,309	\$6,477	\$7,125	\$7,873	\$8,660
65T48138AR_	138	48	2	\$1,519	\$1,834	\$1,926	\$2,613	\$2,743	\$5,417	\$5,959	\$6,587	\$7,246
65T54138AR_	138	54	2	\$1,662	\$2,138	\$2,245	\$3,126	\$3,282	\$5,891	\$6,480	\$7,286	\$8,014
65T60138AR_	138	60	2	\$1,807	\$2,159	\$2,267	\$3,157	\$3,315	\$6,772	\$7,449	\$8,232	\$9,055
65T48144AR_	144	48	2	\$1,573	\$1,874	\$1,968	\$2,710	\$2,846	\$5,653	\$6,218	\$6,872	\$7,559
65T54144AR_	144	54	2	\$1,724	\$2,143	\$2,250	\$3,131	\$3,287	\$6,122	\$6,734	\$7,732	\$8,505
65T60144AR_	144	60	2	\$1,874	\$2,165	\$2,273	\$3,163	\$3,321	\$7,066	\$7,773	\$8,592	\$9,451
65T48150AR_	150	48	2	\$1,629	\$1,957	\$2,055	\$2,781	\$2,921	\$5,889	\$6,478	\$7,158	\$7,874
65T54150AR_	150	54	2	\$1,784	\$2,349	\$2,466	\$3,314	\$3,480	\$6,353	\$6,988	\$8,017	\$8,819
65T60150AR_	150	60	2	\$1,941	\$2,374	\$2,492	\$3,340	\$3,507	\$7,361	\$8,097	\$8,947	\$9,842
65T48156AR_	156	48	2	\$1,684	\$2,043	\$2,145	\$2,853	\$2,995	\$6,124	\$6,736	\$7,443	\$8,188
65T54156AR_	156	54	2	\$1,845	\$2,557	\$2,685	\$3,482	\$3,656	\$6,582	\$7,240	\$8,303	\$9,134
65T60156AR_	156	60	2	\$2,008	\$2,583	\$2,712	\$3,517	\$3,693	\$7,655	\$8,421	\$9,303	\$10,234

Model	TFL Top Surface	HPL Top Surface	Top Profile	Veneer Top Material	Top Surface Power Cutout
	see Anthology TFL Top Surface Finishes	see Anthology HPL Top Surface Finishes	see Anthology Top Profile Finishes (when applicable)	see Anthology Veneer Top Material Finishes	see Anthology Top Surface Power Cutout

**Arc Rectangular Table Tops (continued)**

- planning top specification [ANPG\\_6](#)
- base guide [pages 38-57](#)
- planning power guide [ANPG\\_20- ANPG\\_40](#)

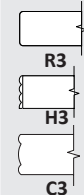
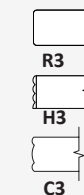
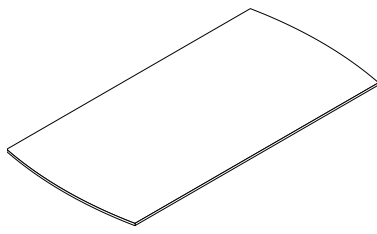

① Model	W	D	Top Pieces	R3 TFL T	R3 HPL Tier 1 H	R3 HPL Tier 2 H	K9 HPL Tier 1 KH	K9 HPL Tier 2 KH	R3 H3 C3 ESS Veneer V	R3 H3 C3 ART Veneer V	K9 ESS Veneer KV	K9 ART Veneer KV
65T48162AR_	162	48	2	\$1,739	\$2,121	\$2,227	\$2,923	\$3,069	\$6,360	\$6,996	\$7,730	\$8,503
65T54162AR_	162	54	2	\$1,906	\$2,560	\$2,688	\$3,487	\$3,661	\$6,982	\$7,680	\$8,662	\$9,528
65T60162AR_	162	60	2	\$2,075	\$2,586	\$2,715	\$3,523	\$3,699	\$7,950	\$8,745	\$9,663	\$10,629
65T48168AR_	168	48	2	\$1,794	\$2,203	\$2,313	\$2,993	\$3,142	\$6,596	\$7,255	\$8,014	\$8,815
65T54168AR_	168	54	2	\$1,967	\$2,564	\$2,692	\$3,494	\$3,669	\$7,383	\$8,121	\$9,021	\$9,923
65T60168AR_	168	60	2	\$2,142	\$2,591	\$2,720	\$3,530	\$3,707	\$8,244	\$9,068	\$10,022	\$11,025
65T48174AR_	174	48	2	\$2,142	\$2,207	\$2,317	\$2,999	\$3,149	\$6,830	\$7,513	\$8,303	\$9,134
65T54174AR_	174	54	2	\$2,028	\$2,566	\$2,695	\$3,499	\$3,674	\$7,638	\$8,402	\$9,307	\$10,237
65T60174AR_	174	60	2	\$2,209	\$2,593	\$2,723	\$3,535	\$3,712	\$8,538	\$9,392	\$10,378	\$11,415
65T48180AR_	180	48	2	\$1,903	\$2,210	\$2,320	\$3,004	\$3,154	\$7,066	\$7,773	\$8,592	\$9,451
65T54180AR_	180	54	2	\$2,088	\$2,574	\$2,703	\$3,507	\$3,682	\$7,893	\$8,683	\$9,592	\$10,551
65T60180AR_	180	60	2	\$2,276	\$2,601	\$2,731	\$3,543	\$3,720	\$8,833	\$9,716	\$10,734	\$11,807
65T48186AR_	186	48	2	\$1,959	\$2,214	\$2,325	\$3,011	\$3,162	\$7,302	\$8,032	\$8,877	\$9,765
65T54186AR_	186	54	2	\$2,150	\$2,579	\$2,707	\$3,512	\$3,687	\$8,133	\$8,947	\$9,948	\$10,943
65T60186AR_	186	60	2	\$2,343	\$2,604	\$2,735	\$3,548	\$3,725	\$9,127	\$10,040	\$11,094	\$12,203
65T48192AR_	192	48	2	\$2,014	\$2,219	\$2,330	\$3,017	\$3,168	\$7,537	\$8,291	\$9,162	\$10,079
65T54192AR_	192	54	2	\$2,212	\$2,583	\$2,712	\$3,517	\$3,693	\$8,375	\$9,213	\$10,305	\$11,335
65T60192AR_	192	60	2	\$2,411	\$2,608	\$2,739	\$3,554	\$3,732	\$9,422	\$10,364	\$11,453	\$12,598
65T48198AR_	198	48	3	\$2,087	\$3,089	\$3,244	\$4,170	\$4,378	\$8,604	\$9,464	\$10,406	\$11,446
65T54198AR_	198	54	3	\$2,291	\$3,517	\$3,693	\$4,790	\$5,029	\$9,574	\$10,532	\$11,521	\$12,673
65T60198AR_	198	60	3	\$2,497	\$3,554	\$3,732	\$4,838	\$5,080	\$10,746	\$11,821	\$12,933	\$14,226
65T48204AR_	204	48	3	\$2,159	\$3,132	\$3,288	\$4,251	\$4,464	\$8,856	\$9,742	\$10,658	\$11,724
65T54204AR_	204	54	3	\$2,371	\$3,525	\$3,701	\$4,796	\$5,036	\$9,899	\$10,889	\$11,912	\$13,104
65T60204AR_	204	60	3	\$2,584	\$3,562	\$3,740	\$4,846	\$5,088	\$11,070	\$12,177	\$13,326	\$14,658
65T48210AR_	210	48	3	\$2,233	\$3,136	\$3,293	\$4,259	\$4,471	\$9,115	\$10,026	\$10,970	\$12,067
65T54210AR_	210	54	3	\$2,450	\$3,529	\$3,706	\$4,802	\$5,042	\$10,222	\$11,244	\$12,304	\$13,534
65T60210AR_	210	60	3	\$2,670	\$3,565	\$3,744	\$4,852	\$5,094	\$11,394	\$12,534	\$13,717	\$15,089

Model	TFL Top Surface	HPL Top Surface	Top Profile	Veneer Top Material	Top Surface Power Cutout
	see Anthology TFL Top Surface Finishes	see Anthology HPL Top Surface Finishes	see Anthology Top Profile Finishes (when applicable)	see Anthology Veneer Top Material Finishes	see Anthology Top Surface Power Cutout

**Arc Rectangular Table Tops (continued)**

- planning top specification [ANPG\\_6](#)
- base guide [pages 38-57](#)
- planning power guide [ANPG\\_20- ANPG\\_40](#)

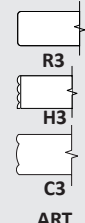
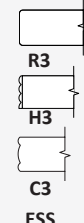
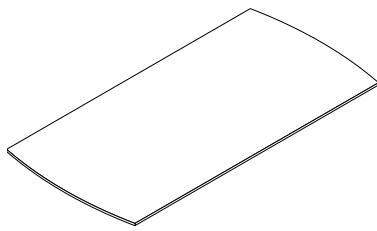

① Model	W	D	Top Pieces	R3 TFL T	R3 HPL Tier 1 H	R3 HPL Tier 2 H	K9 HPL Tier 1 KH	K9 HPL Tier 2 KH	R3 H3 C3 ESS Veneer V	R3 H3 C3 ART Veneer V	K9 ESS Veneer KV	K9 ART Veneer KV
65T48216AR_	216	48	3	\$2,305	\$3,140	\$3,297	\$4,266	\$4,479	\$9,375	\$10,312	\$11,282	\$12,410
65T54216AR_	216	54	3	\$2,529	\$3,533	\$3,710	\$4,808	\$5,048	\$10,547	\$11,601	\$12,695	\$13,965
65T60216AR_	216	60	3	\$2,757	\$3,569	\$3,748	\$4,857	\$5,100	\$11,718	\$12,890	\$14,108	\$15,519
65T48222AR_	222	48	3	\$2,378	\$3,144	\$3,301	\$4,271	\$4,484	\$9,636	\$10,600	\$11,597	\$12,757
65T54222AR_	222	54	3	\$2,608	\$3,588	\$3,767	\$4,884	\$5,128	\$10,808	\$11,889	\$13,010	\$14,311
65T60222AR_	222	60	3	\$2,843	\$3,625	\$3,806	\$4,934	\$5,181	\$12,045	\$13,250	\$14,500	\$15,950
65T48228AR_	228	48	3	\$2,451	\$3,148	\$3,306	\$4,277	\$4,491	\$9,899	\$10,889	\$11,912	\$13,104
65T54228AR_	228	54	3	\$2,688	\$3,643	\$3,825	\$4,959	\$5,207	\$11,070	\$12,177	\$13,326	\$14,658
65T60228AR_	228	60	3	\$2,930	\$3,681	\$3,865	\$5,010	\$5,261	\$12,372	\$13,609	\$14,891	\$16,380
65T48234AR_	234	48	3	\$2,524	\$3,271	\$3,434	\$4,340	\$4,557	\$10,157	\$11,173	\$12,225	\$13,447
65T54234AR_	234	54	3	\$2,767	\$3,648	\$3,830	\$4,965	\$5,213	\$11,394	\$12,534	\$13,717	\$15,089
65T60234AR_	234	60	3	\$3,016	\$3,686	\$3,870	\$5,017	\$5,267	\$12,695	\$13,965	\$15,283	\$16,811
65T48240AR_	240	48	3	\$2,597	\$3,394	\$3,564	\$4,403	\$4,623	\$10,417	\$11,459	\$12,537	\$13,790
65T54240AR_	240	54	3	\$2,849	\$3,653	\$3,835	\$4,972	\$5,221	\$11,718	\$12,890	\$14,108	\$15,519
65T60240AR_	240	60	3	\$3,103	\$3,691	\$3,876	\$5,023	\$5,274	\$13,020	\$14,322	\$15,675	\$17,242

Model	TFL Top Surface	HPL Top Surface	Top Profile	Veneer Top Material	Top Surface Power Cutout
	see Anthology TFL Top Surface Finishes	see Anthology HPL Top Surface Finishes	see Anthology Top Profile Finishes (when applicable)	see Anthology Veneer Top Material Finishes	see Anthology Top Surface Power Cutout

**Boat Table Tops**

- ends are 6" narrower than overall center dimension
- planning top specification [ANPG\\_6](#)
- base guide [pages 38-57](#)
- planning power guide [ANPG\\_20- ANPG\\_40](#)

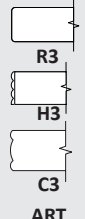
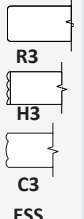
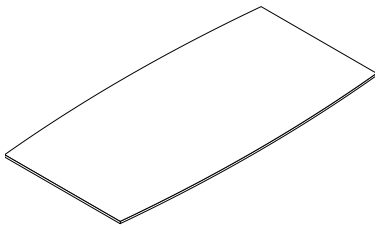

Model	W	D	Top Pieces	TFL T	HPL Tier 1 H	HPL Tier 2 H	HPL Tier 1 KH	HPL Tier 2 KH	ESS Veneer V	ART Veneer V	ESS Veneer KV	ART Veneer KV
65T3672BT_	72	36	1	\$491	\$802	\$842	\$1,172	\$1,230	\$2,122	\$2,334	\$2,491	\$2,740
65T4272BT_	72	42	1	\$590	\$861	\$904	\$1,254	\$1,317	\$2,356	\$2,592	\$2,903	\$3,193
65T4872BT_	72	48	1	\$675	\$866	\$909	\$1,258	\$1,321	\$2,628	\$2,891	\$3,154	\$3,470
65T3678BT_	78	36	1	\$551	\$917	\$963	\$1,201	\$1,262	\$2,280	\$2,508	\$2,697	\$2,967
65T4278BT_	78	42	1	\$649	\$952	\$1,000	\$1,301	\$1,366	\$2,530	\$2,783	\$3,039	\$3,343
65T4878BT_	78	48	1	\$735	\$956	\$1,004	\$1,306	\$1,371	\$2,822	\$3,104	\$3,369	\$3,705
65T3684BT_	84	36	1	\$610	\$935	\$981	\$1,219	\$1,280	\$2,427	\$2,670	\$2,903	\$3,193
65T4284BT_	84	42	1	\$709	\$978	\$1,027	\$1,315	\$1,380	\$2,696	\$2,966	\$3,315	\$3,646
65T4884BT_	84	48	1	\$795	\$982	\$1,031	\$1,320	\$1,386	\$3,010	\$3,311	\$3,645	\$4,009
65T3690BT_	90	36	1	\$670	\$951	\$999	\$1,235	\$1,297	\$2,579	\$2,836	\$3,109	\$3,420
65T4290BT_	90	42	1	\$769	\$1,004	\$1,054	\$1,324	\$1,390	\$2,864	\$3,150	\$3,592	\$3,951
65T4890BT_	90	48	1	\$854	\$1,008	\$1,058	\$1,328	\$1,395	\$3,201	\$3,521	\$3,889	\$4,278
65T3696BT_	96	36	1	\$730	\$968	\$1,016	\$1,252	\$1,315	\$2,728	\$3,001	\$3,315	\$3,646
65T4296BT_	96	42	1	\$829	\$1,030	\$1,082	\$1,332	\$1,399	\$3,029	\$3,332	\$3,869	\$4,256
65T4896BT_	96	48	1	\$914	\$1,035	\$1,086	\$1,336	\$1,403	\$3,349	\$3,684	\$4,134	\$4,547
65T42102BT1_	102	42	1	\$860	\$1,513	\$1,588	\$2,058	\$2,161	\$3,466	\$3,813	\$3,895	\$4,284
65T48102BT1_	102	48	1	\$925	\$1,521	\$1,597	\$2,082	\$2,186	\$3,787	\$4,165	\$4,557	\$5,013
65T42102BT2_	102	42	2	\$1,066	\$1,627	\$1,708	\$2,214	\$2,325	\$3,728	\$4,101	\$4,187	\$4,606
65T48102BT2_	102	48	2	\$1,174	\$1,635	\$1,717	\$2,239	\$2,351	\$4,072	\$4,479	\$4,900	\$5,390
65T42108BT1_	108	42	1	\$906	\$1,536	\$1,613	\$2,063	\$2,166	\$3,623	\$3,985	\$4,130	\$4,543
65T48108BT1_	108	48	1	\$985	\$1,543	\$1,621	\$2,106	\$2,211	\$3,943	\$4,338	\$4,792	\$5,271
65T42108BT2_	108	42	2	\$1,119	\$1,652	\$1,734	\$2,218	\$2,329	\$3,896	\$4,286	\$4,440	\$4,884
65T48108BT2_	108	48	2	\$1,233	\$1,660	\$1,743	\$2,264	\$2,378	\$4,240	\$4,664	\$5,153	\$5,668
65T42114BT1_	114	42	1	\$952	\$1,560	\$1,638	\$2,087	\$2,191	\$3,799	\$4,179	\$4,396	\$4,835
65T48114BT1_	114	48	1	\$1,045	\$1,567	\$1,645	\$2,130	\$2,236	\$4,163	\$4,579	\$5,057	\$5,562
65T42114BT2_	114	42	2	\$1,173	\$1,677	\$1,761	\$2,243	\$2,355	\$4,085	\$4,494	\$4,726	\$5,199
65T48114BT2_	114	48	2	\$1,293	\$1,686	\$1,770	\$2,289	\$2,404	\$4,476	\$4,923	\$5,438	\$5,982

Model	TFL Top Surface	HPL Top Surface	Top Profile	Veneer Top Material	Top Surface Power Cutout
	<a href="#">see Anthology TFL Top Surface Finishes</a>	<a href="#">see Anthology HPL Top Surface Finishes</a>	<a href="#">see Anthology Top Profile Finishes</a> (when applicable)	<a href="#">see Anthology Veneer Top Material Finishes</a>	<a href="#">see Anthology Top Surface Power Cutout</a>

**Boat Table Tops (continued)**

- ends are 6" narrower than overall center dimension
- planning top specification [ANPG\\_6](#)
- base guide [pages 38-57](#)
- planning power guide [ANPG\\_20- ANPG\\_40](#)

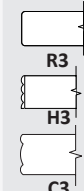
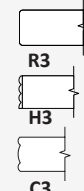
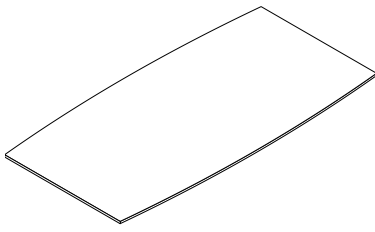

Model	W	D	Top Pieces	TFL T	HPL Tier 1 H	HPL Tier 2 H	HPL Tier 1 KH	HPL Tier 2 KH	ESS Veneer V	ART Veneer V	ESS Veneer KV	ART Veneer KV
65T42120BT1_	120	42	1	\$999	\$1,583	\$1,662	\$2,109	\$2,215	\$3,976	\$4,374	\$4,660	\$5,126
65T48120BT1_	120	48	1	\$1,105	\$1,591	\$1,670	\$2,152	\$2,260	\$4,381	\$4,819	\$5,324	\$5,856
65T54120BT1_	120	54	1	\$1,210	\$1,788	\$1,877	\$2,425	\$2,546	\$4,830	\$5,313	\$5,834	\$6,418
65T60120BT1_	120	60	1	\$1,315	\$1,806	\$1,896	\$2,450	\$2,572	\$5,477	\$6,025	\$6,659	\$7,325
65T42120BT2_	120	42	2	\$1,226	\$1,702	\$1,787	\$2,268	\$2,381	\$4,275	\$4,702	\$5,011	\$5,513
65T48120BT2_	120	48	2	\$1,353	\$1,710	\$1,796	\$2,315	\$2,431	\$4,711	\$5,182	\$5,724	\$6,297
65T54120BT2_	120	54	2	\$1,480	\$1,922	\$2,019	\$2,607	\$2,738	\$5,194	\$5,713	\$6,273	\$6,900
65T60120BT2_	120	60	2	\$1,606	\$1,942	\$2,039	\$2,634	\$2,766	\$5,889	\$6,478	\$7,160	\$7,876
65T48126BT_	126	48	2	\$1,409	\$1,751	\$1,839	\$2,414	\$2,534	\$4,947	\$5,441	\$6,013	\$6,614
65T54126BT_	126	54	2	\$1,538	\$2,028	\$2,129	\$2,863	\$3,006	\$5,427	\$5,969	\$6,556	\$7,212
65T60126BT_	126	60	2	\$1,673	\$2,049	\$2,152	\$2,893	\$3,037	\$6,184	\$6,802	\$7,516	\$8,268
65T48132BT_	132	48	2	\$1,464	\$1,793	\$1,882	\$2,513	\$2,638	\$5,182	\$5,701	\$6,301	\$6,931
65T54132BT_	132	54	2	\$1,600	\$2,134	\$2,240	\$3,119	\$3,275	\$5,658	\$6,224	\$6,840	\$7,524
65T60132BT_	132	60	2	\$1,740	\$2,155	\$2,263	\$3,151	\$3,309	\$6,477	\$7,125	\$7,873	\$8,660
65T48138BT_	138	48	2	\$1,519	\$1,834	\$1,926	\$2,613	\$2,743	\$5,417	\$5,959	\$6,587	\$7,246
65T54138BT_	138	54	2	\$1,662	\$2,138	\$2,245	\$3,126	\$3,282	\$5,891	\$6,480	\$7,286	\$8,014
65T60138BT_	138	60	2	\$1,807	\$2,159	\$2,267	\$3,157	\$3,315	\$6,772	\$7,449	\$8,232	\$9,055
65T48144BT_	144	48	2	\$1,573	\$1,874	\$1,968	\$2,710	\$2,846	\$5,653	\$6,218	\$6,872	\$7,559
65T54144BT_	144	54	2	\$1,724	\$2,143	\$2,250	\$3,131	\$3,287	\$6,122	\$6,734	\$7,732	\$8,505
65T60144BT_	144	60	2	\$1,874	\$2,165	\$2,273	\$3,163	\$3,321	\$7,066	\$7,773	\$8,592	\$9,451
65T48150BT_	150	48	2	\$1,629	\$1,957	\$2,055	\$2,781	\$2,921	\$5,889	\$6,478	\$7,158	\$7,874
65T54150BT_	150	54	2	\$1,784	\$2,349	\$2,466	\$3,314	\$3,480	\$6,353	\$6,988	\$8,017	\$8,819
65T60150BT_	150	60	2	\$1,941	\$2,374	\$2,492	\$3,340	\$3,507	\$7,361	\$8,097	\$8,947	\$9,842
65T48156BT_	156	48	2	\$1,684	\$2,043	\$2,145	\$2,853	\$2,995	\$6,124	\$6,736	\$7,443	\$8,188
65T54156BT_	156	54	2	\$1,845	\$2,557	\$2,685	\$3,482	\$3,656	\$6,582	\$7,240	\$8,303	\$9,134
65T60156BT_	156	60	2	\$2,008	\$2,583	\$2,712	\$3,517	\$3,693	\$7,655	\$8,421	\$9,303	\$10,234

Model	TFL Top Surface	HPL Top Surface	Top Profile	Veneer Top Material	Top Surface Power Cutout
	see Anthology TFL Top Surface Finishes	see Anthology HPL Top Surface Finishes	see Anthology Top Profile Finishes (when applicable)	see Anthology Veneer Top Material Finishes	see Anthology Top Surface Power Cutout



**Boat Table Tops (continued)**

- ends are 6" narrower than overall center dimension
- planning top specification [ANPG\\_6](#)
- base guide [pages 38-57](#)
- planning power guide [ANPG\\_20- ANPG\\_40](#)

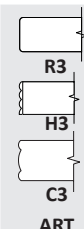
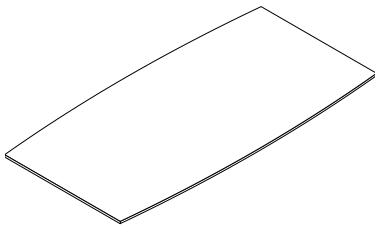

① Model	W	D	Top Pieces	R3 TFL T	R3 HPL Tier 1 H	R3 HPL Tier 2 H	K9 HPL Tier 1 KH	K9 HPL Tier 2 KH	R3 H3 C3 ESS Veneer V	R3 H3 C3 ART Veneer V	K9 ESS Veneer KV	K9 ART Veneer KV
65T48162BT_	162	48	2	\$1,739	\$2,121	\$2,227	\$2,923	\$3,069	\$6,360	\$6,996	\$7,730	\$8,503
65T54162BT_	162	54	2	\$1,906	\$2,560	\$2,688	\$3,487	\$3,661	\$6,982	\$7,680	\$8,662	\$9,528
65T60162BT_	162	60	2	\$2,075	\$2,586	\$2,715	\$3,523	\$3,699	\$7,950	\$8,745	\$9,663	\$10,629
65T48168BT_	168	48	2	\$1,794	\$2,203	\$2,313	\$2,993	\$3,142	\$6,596	\$7,255	\$8,014	\$8,815
65T54168BT_	168	54	2	\$1,967	\$2,564	\$2,692	\$3,494	\$3,669	\$7,383	\$8,121	\$9,021	\$9,923
65T60168BT_	168	60	2	\$2,142	\$2,591	\$2,720	\$3,530	\$3,707	\$8,244	\$9,068	\$10,022	\$11,025
65T48174BT_	174	48	2	\$1,848	\$2,207	\$2,317	\$2,999	\$3,149	\$6,830	\$7,513	\$8,303	\$9,134
65T54174BT_	174	54	2	\$2,028	\$2,566	\$2,695	\$3,499	\$3,674	\$7,638	\$8,402	\$9,307	\$10,237
65T60174BT_	174	60	2	\$2,209	\$2,593	\$2,723	\$3,535	\$3,712	\$8,538	\$9,392	\$10,378	\$11,415
65T48180BT_	180	48	2	\$1,903	\$2,210	\$2,320	\$3,004	\$3,154	\$7,066	\$7,773	\$8,592	\$9,451
65T54180BT_	180	54	2	\$2,088	\$2,574	\$2,703	\$3,507	\$3,682	\$7,893	\$8,683	\$9,592	\$10,551
65T60180BT_	180	60	2	\$2,276	\$2,601	\$2,731	\$3,543	\$3,720	\$8,833	\$9,716	\$10,734	\$11,807
65T48186BT_	186	48	2	\$1,959	\$2,214	\$2,325	\$3,011	\$3,162	\$7,302	\$8,032	\$8,877	\$9,765
65T54186BT_	186	54	2	\$2,150	\$2,579	\$2,707	\$3,512	\$3,687	\$8,133	\$8,947	\$9,948	\$10,943
65T60186BT_	186	60	2	\$2,343	\$2,604	\$2,735	\$3,548	\$3,725	\$9,127	\$10,040	\$11,094	\$12,203
65T48192BT_	192	48	2	\$2,014	\$2,219	\$2,330	\$3,017	\$3,168	\$7,537	\$8,291	\$9,162	\$10,079
65T54192BT_	192	54	2	\$2,212	\$2,583	\$2,712	\$3,517	\$3,693	\$8,375	\$9,213	\$10,305	\$11,335
65T60192BT_	192	60	2	\$2,411	\$2,608	\$2,739	\$3,554	\$3,732	\$9,422	\$10,364	\$11,453	\$12,598
65T48198BT_	198	48	2	\$2,087	\$3,089	\$3,244	\$4,170	\$4,378	\$8,604	\$9,464	\$10,406	\$11,446
65T54198BT_	198	54	2	\$2,291	\$3,517	\$3,693	\$4,790	\$5,029	\$9,574	\$10,532	\$11,521	\$12,673
65T60198BT_	198	60	2	\$2,497	\$3,554	\$3,732	\$4,838	\$5,080	\$10,746	\$11,821	\$12,933	\$14,226
65T48204BT_	204	48	3	\$2,159	\$3,132	\$3,288	\$4,251	\$4,464	\$8,856	\$9,742	\$10,658	\$11,724
65T54204BT_	204	54	3	\$2,371	\$3,525	\$3,701	\$4,796	\$5,036	\$9,899	\$10,889	\$11,912	\$13,104
65T60204BT_	204	60	3	\$2,584	\$3,562	\$3,740	\$4,846	\$5,088	\$11,070	\$12,177	\$13,326	\$14,658
65T48210BT_	210	48	3	\$2,233	\$3,136	\$3,293	\$4,259	\$4,471	\$9,115	\$10,026	\$10,970	\$12,067
65T54210BT_	210	54	3	\$2,450	\$3,529	\$3,706	\$4,802	\$5,042	\$10,222	\$11,244	\$12,304	\$13,534
65T60210BT_	210	60	3	\$2,670	\$3,565	\$3,744	\$4,852	\$5,094	\$11,394	\$12,534	\$13,717	\$15,089

Model	TFL Top Surface	HPL Top Surface	Top Profile	Veneer Top Material	Top Surface Power Cutout
	see Anthology TFL Top Surface Finishes	see Anthology HPL Top Surface Finishes	see Anthology Top Profile Finishes (when applicable)	see Anthology Veneer Top Material Finishes	see Anthology Top Surface Power Cutout



**Boat Table Tops (continued)**

- ends are 6" narrower than overall center dimension
- planning top specification [ANPG\\_6](#)
- base guide [pages 38-57](#)
- planning power guide [ANPG\\_20- ANPG\\_40](#)

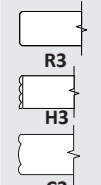
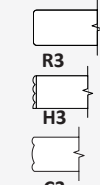
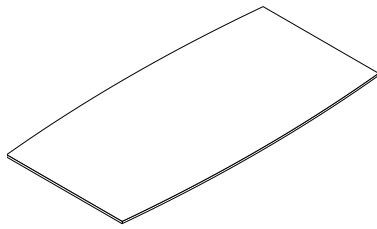

① Model	W	D	Top Pieces	R3 TFL T	R3 HPL Tier 1 H	R3 HPL Tier 2 H	K9 HPL Tier 1 KH	K9 HPL Tier 2 KH	R3 H3 C3 ESS Veneer V	R3 H3 C3 ART Veneer V	K9 ESS Veneer KV	K9 ART Veneer KV
65T48216BT_	216	48	3	\$2,305	\$3,140	\$3,297	\$4,266	\$4,479	\$9,375	\$10,312	\$11,282	\$12,410
65T54216BT_	216	54	3	\$2,529	\$3,533	\$3,710	\$4,808	\$5,048	\$10,547	\$11,601	\$12,695	\$13,965
65T60216BT_	216	60	3	\$2,757	\$3,569	\$3,748	\$4,857	\$5,100	\$11,718	\$12,890	\$14,108	\$15,519
65T48222BT_	222	48	3	\$2,378	\$3,144	\$3,301	\$4,271	\$4,484	\$9,636	\$10,600	\$11,597	\$12,757
65T54222BT_	222	54	3	\$2,608	\$3,588	\$3,767	\$4,884	\$5,128	\$10,808	\$11,889	\$13,010	\$14,311
65T60222BT_	222	60	3	\$2,843	\$3,625	\$3,806	\$4,934	\$5,181	\$12,045	\$13,250	\$14,500	\$15,950
65T48228BT_	228	48	3	\$2,451	\$3,148	\$3,306	\$4,277	\$4,491	\$9,899	\$10,889	\$11,912	\$13,104
65T54228BT_	228	54	3	\$2,688	\$3,643	\$3,825	\$4,959	\$5,207	\$11,070	\$12,177	\$13,326	\$14,658
65T60228BT_	228	60	3	\$2,930	\$3,681	\$3,865	\$5,010	\$5,261	\$12,372	\$13,609	\$14,891	\$16,380
65T48234BT_	234	48	3	\$2,524	\$3,271	\$3,434	\$4,340	\$4,557	\$10,157	\$11,173	\$12,225	\$13,447
65T54234BT_	234	54	3	\$2,767	\$3,648	\$3,830	\$4,965	\$5,213	\$11,394	\$12,534	\$13,717	\$15,089
65T60234BT_	234	60	3	\$3,016	\$3,686	\$3,870	\$5,017	\$5,267	\$12,695	\$13,965	\$15,283	\$16,811
65T48240BT_	240	48	3	\$2,597	\$3,394	\$3,564	\$4,403	\$4,623	\$10,417	\$11,459	\$12,537	\$13,790
65T54240BT_	240	54	3	\$2,849	\$3,653	\$3,835	\$4,972	\$5,221	\$11,718	\$12,890	\$14,108	\$15,519
65T60240BT_	240	60	3	\$3,103	\$3,691	\$3,876	\$5,023	\$5,274	\$13,020	\$14,322	\$15,675	\$17,242

Model	TFL Top Surface	HPL Top Surface	Top Profile	Veneer Top Material	Top Surface Power Cutout
	see Anthology TFL Top Surface Finishes	see Anthology HPL Top Surface Finishes	see Anthology Top Profile Finishes (when applicable)	see Anthology Veneer Top Material Finishes	see Anthology Top Surface Power Cutout

**Arc Boat Table Tops**

- ends are 6" narrower than overall center dimension with 8" radius corners
- planning top specification [ANPG\\_6](#)
- base guide [pages 38-57](#)
- planning power guide [ANPG\\_20- ANPG\\_40](#)

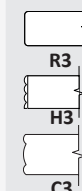
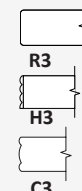
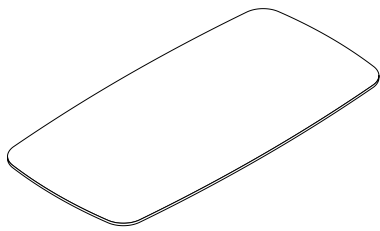

Model	W	D	Top Pieces	TFL T	HPL Tier 1 H	HPL Tier 2 H	HPL Tier 1 KH	HPL Tier 2 KH	ESS Veneer V	ART Veneer V	ESS Veneer KV	ART Veneer KV
65T3672AB_	72	36	1	\$491	\$802	\$842	\$1,172	\$1,230	\$2,122	\$2,334	\$2,491	\$2,740
65T4272AB_	72	42	1	\$590	\$861	\$904	\$1,254	\$1,317	\$2,356	\$2,592	\$2,903	\$3,193
65T4872AB_	72	48	1	\$675	\$866	\$909	\$1,258	\$1,321	\$2,628	\$2,891	\$3,154	\$3,470
65T3678AB_	78	36	1	\$551	\$917	\$963	\$1,201	\$1,262	\$2,280	\$2,508	\$2,697	\$2,967
65T4278AB_	78	42	1	\$649	\$952	\$1,000	\$1,301	\$1,366	\$2,530	\$2,783	\$3,039	\$3,343
65T4878AB_	78	48	1	\$735	\$956	\$1,004	\$1,306	\$1,371	\$2,822	\$3,104	\$3,369	\$3,705
65T3684AB_	84	36	1	\$610	\$935	\$981	\$1,219	\$1,280	\$2,427	\$2,670	\$2,903	\$3,193
65T4284AB_	84	42	1	\$709	\$978	\$1,027	\$1,315	\$1,380	\$2,696	\$2,966	\$3,315	\$3,646
65T4884AB_	84	48	1	\$795	\$982	\$1,031	\$1,320	\$1,386	\$3,010	\$3,311	\$3,645	\$4,009
65T3690AB_	90	36	1	\$670	\$951	\$999	\$1,235	\$1,297	\$2,579	\$2,836	\$3,109	\$3,420
65T4290AB_	90	42	1	\$769	\$1,004	\$1,054	\$1,324	\$1,390	\$2,864	\$3,150	\$3,592	\$3,951
65T4890AB_	90	48	1	\$854	\$1,008	\$1,058	\$1,328	\$1,395	\$3,201	\$3,521	\$3,889	\$4,278
65T3696AB_	96	36	1	\$730	\$968	\$1,016	\$1,252	\$1,315	\$2,728	\$3,001	\$3,315	\$3,646
65T4296AB_	96	42	1	\$829	\$1,030	\$1,082	\$1,332	\$1,399	\$3,029	\$3,332	\$3,869	\$4,256
65T4896AB_	96	48	1	\$914	\$1,035	\$1,086	\$1,336	\$1,403	\$3,349	\$3,684	\$4,134	\$4,547
65T42102AB1_	102	42	1	\$860	\$1,513	\$1,588	\$2,058	\$2,161	\$3,466	\$3,813	\$3,895	\$4,284
65T48102AB1_	102	48	1	\$925	\$1,521	\$1,597	\$2,082	\$2,186	\$3,787	\$4,165	\$4,557	\$5,013
65T42102AB2_	102	42	2	\$1,066	\$1,627	\$1,708	\$2,214	\$2,325	\$3,728	\$4,101	\$4,187	\$4,606
65T48102AB2_	102	48	2	\$1,174	\$1,635	\$1,717	\$2,239	\$2,351	\$4,072	\$4,479	\$4,900	\$5,390
65T42108AB1_	108	42	1	\$906	\$1,536	\$1,613	\$2,063	\$2,166	\$3,623	\$3,985	\$4,130	\$4,543
65T48108AB1_	108	48	1	\$985	\$1,536	\$1,613	\$2,106	\$2,211	\$3,943	\$4,338	\$4,792	\$5,271
65T42108AB2_	108	42	2	\$1,119	\$1,652	\$1,734	\$2,218	\$2,329	\$3,896	\$4,286	\$4,440	\$4,884
65T48108AB2_	108	48	2	\$1,233	\$1,660	\$1,743	\$2,264	\$2,378	\$4,240	\$4,664	\$5,153	\$5,668
65T42114AB1_	114	42	1	\$952	\$1,560	\$1,638	\$2,087	\$2,191	\$3,799	\$4,179	\$4,396	\$4,835
65T48114AB1_	114	48	1	\$1,045	\$1,567	\$1,645	\$2,130	\$2,236	\$4,163	\$4,579	\$5,057	\$5,562
65T42114AB2_	114	42	2	\$1,173	\$1,677	\$1,761	\$2,243	\$2,355	\$4,085	\$4,494	\$4,726	\$5,199
65T48114AB2_	114	48	2	\$1,293	\$1,686	\$1,770	\$2,289	\$2,404	\$4,476	\$4,923	\$5,438	\$5,982

Model	TFL Top Surface	HPL Top Surface	Top Profile	Veneer Top Material	Top Surface Power Cutout
	<a href="#">see Anthology TFL Top Surface Finishes</a>	<a href="#">see Anthology HPL Top Surface Finishes</a>	<a href="#">see Anthology Top Profile Finishes</a> (when applicable)	<a href="#">see Anthology Veneer Top Material Finishes</a>	<a href="#">see Anthology Top Surface Power Cutout</a>

**Arc Boat Table Tops (continued)**

- ends are 6" narrower than overall center dimension with 8" radius corners
- planning top specification [ANPG\\_6](#)
- base guide [pages 38-57](#)
- planning power guide [ANPG\\_20- ANPG\\_40](#)

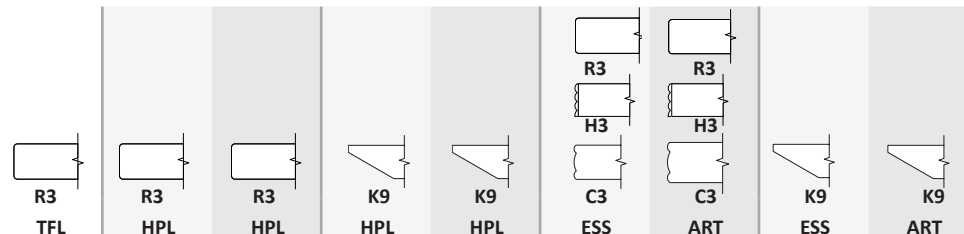
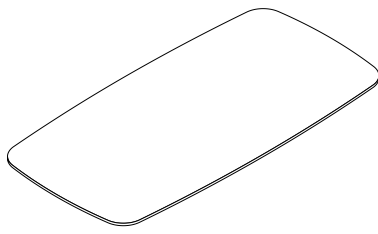

Model	W	D	Top Pieces	R3 TFL T	R3 HPL Tier 1 H	R3 HPL Tier 2 H	K9 HPL Tier 1 KH	K9 HPL Tier 2 KH	ESS Veneer V	ART Veneer V	ESS Veneer KV	ART Veneer KV
65T42120AB1_	120	42	1	\$999	\$1,583	\$1,662	\$2,109	\$2,215	\$3,976	\$4,374	\$4,660	\$5,126
65T48120AB1_	120	48	1	\$1,105	\$1,591	\$1,670	\$2,152	\$2,260	\$4,381	\$4,819	\$5,324	\$5,856
65T54120AB1_	120	54	1	\$1,210	\$1,788	\$1,877	\$2,425	\$2,546	\$4,830	\$5,313	\$5,834	\$6,418
65T60120AB1_	120	60	1	\$1,315	\$1,806	\$1,896	\$2,450	\$2,572	\$5,477	\$6,025	\$6,659	\$7,325
65T42120AB2_	120	42	2	\$1,226	\$1,702	\$1,787	\$2,268	\$2,381	\$4,275	\$4,702	\$5,011	\$5,513
65T48120AB2_	120	48	2	\$1,353	\$1,710	\$1,796	\$2,315	\$2,431	\$4,711	\$5,182	\$5,724	\$6,297
65T54120AB2_	120	54	2	\$1,480	\$1,922	\$2,019	\$2,607	\$2,738	\$5,194	\$5,713	\$6,273	\$6,900
65T60120AB2_	120	60	2	\$1,606	\$1,942	\$2,039	\$2,634	\$2,766	\$5,889	\$6,478	\$7,160	\$7,876
65T48126AB_	126	48	2	\$1,409	\$1,751	\$1,839	\$2,414	\$2,534	\$4,947	\$5,441	\$6,013	\$6,614
65T54126AB_	126	54	2	\$1,538	\$2,028	\$2,129	\$2,863	\$3,006	\$5,427	\$5,969	\$6,556	\$7,212
65T60126AB_	126	60	2	\$1,673	\$2,049	\$2,152	\$2,893	\$3,037	\$6,184	\$6,802	\$7,516	\$8,268
65T48132AB_	132	48	2	\$1,464	\$1,793	\$1,882	\$2,513	\$2,638	\$5,182	\$5,701	\$6,301	\$6,931
65T54132AB_	132	54	2	\$1,600	\$2,134	\$2,240	\$3,119	\$3,275	\$5,658	\$6,224	\$6,840	\$7,524
65T60132AB_	132	60	2	\$1,740	\$2,155	\$2,263	\$3,151	\$3,309	\$6,477	\$7,125	\$7,873	\$8,660
65T48138AB_	138	48	2	\$1,519	\$1,834	\$1,926	\$2,613	\$2,743	\$5,417	\$5,959	\$6,587	\$7,246
65T54138AB_	138	48	2	\$1,519	\$1,834	\$1,926	\$2,613	\$2,743	\$5,417	\$5,959	\$6,587	\$7,246
65T60138AB_	138	60	2	\$1,807	\$2,159	\$2,267	\$3,157	\$3,315	\$6,772	\$7,449	\$8,232	\$9,055
65T48144AB_	144	48	2	\$1,573	\$1,874	\$1,968	\$2,710	\$2,846	\$5,653	\$6,218	\$6,872	\$7,559
65T54144AB_	144	54	2	\$1,724	\$2,143	\$2,250	\$3,131	\$3,287	\$6,122	\$6,734	\$7,732	\$8,505
65T60144AB_	144	60	2	\$1,874	\$2,165	\$2,273	\$3,163	\$3,321	\$7,066	\$7,773	\$8,592	\$9,451
65T48150AB_	150	48	2	\$1,629	\$1,957	\$2,055	\$2,781	\$2,921	\$5,889	\$6,478	\$7,158	\$7,874
65T54150AB_	150	54	2	\$1,784	\$2,349	\$2,466	\$3,314	\$3,480	\$6,353	\$6,988	\$8,017	\$8,819
65T60150AB_	150	60	2	\$1,941	\$2,374	\$2,492	\$3,340	\$3,507	\$7,361	\$8,097	\$8,947	\$9,842
65T48156AB_	156	48	2	\$1,684	\$2,043	\$2,145	\$2,853	\$2,995	\$6,124	\$6,736	\$7,443	\$8,188
65T54156AB_	156	54	2	\$1,845	\$2,557	\$2,685	\$3,482	\$3,656	\$6,582	\$7,240	\$8,303	\$9,134
65T60156AB_	156	60	2	\$2,008	\$2,583	\$2,712	\$3,517	\$3,693	\$7,655	\$8,421	\$9,303	\$10,234

Model	TFL Top Surface	HPL Top Surface	Top Profile	Veneer Top Material	Top Surface Power Cutout
	see Anthology TFL Top Surface Finishes	see Anthology HPL Top Surface Finishes	see Anthology Top Profile Finishes (when applicable)	see Anthology Veneer Top Material Finishes	see Anthology Top Surface Power Cutout

**Arc Boat Table Tops (continued)**

- ends are 6" narrower than overall center dimension with 8" radius corners
- planning top specification [ANPG\\_6](#)
- base guide [pages 38-57](#)
- planning power guide [ANPG\\_20- ANPG\\_40](#)

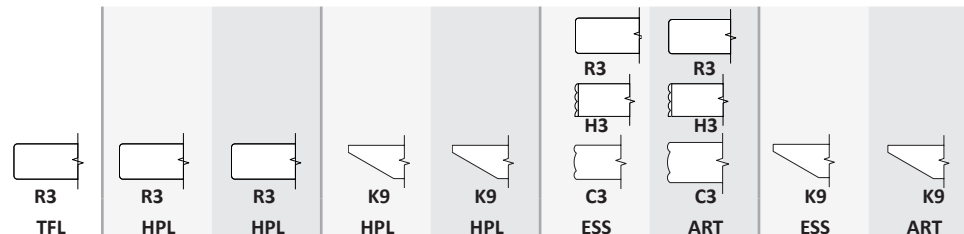
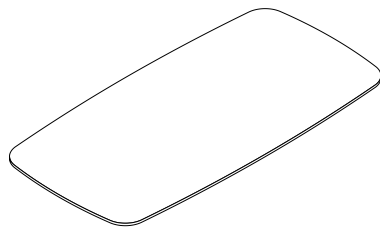

Model	W	D	Top Pieces	R3 TFL T	R3 HPL Tier 1 H	R3 HPL Tier 2 H	K9 HPL Tier 1 KH	K9 HPL Tier 2 KH	ESS Veneer V	ART Veneer V	ESS Veneer KV	ART Veneer KV
65T48162AB_	162	48	2	\$1,739	\$2,121	\$2,227	\$2,923	\$3,069	\$6,360	\$6,996	\$7,730	\$8,503
65T54162AB_	162	54	2	\$1,906	\$2,560	\$2,688	\$3,487	\$3,661	\$6,982	\$7,680	\$8,662	\$9,528
65T60162AB_	162	60	2	\$2,075	\$2,586	\$2,715	\$3,523	\$3,699	\$7,950	\$8,745	\$9,663	\$10,629
65T48168AB_	168	48	2	\$1,794	\$2,203	\$2,313	\$2,993	\$3,142	\$6,596	\$7,255	\$8,014	\$8,815
65T54168AB_	168	54	2	\$1,967	\$2,564	\$2,692	\$3,494	\$3,669	\$7,383	\$8,121	\$9,021	\$9,923
65T60168AB_	168	60	2	\$2,142	\$2,591	\$2,720	\$3,530	\$3,707	\$8,244	\$9,068	\$10,022	\$11,025
65T48174AB_	174	48	2	\$1,848	\$2,207	\$2,317	\$2,999	\$3,149	\$6,830	\$7,513	\$8,303	\$9,134
65T54174AB_	174	54	2	\$2,028	\$2,566	\$2,695	\$3,499	\$3,674	\$7,638	\$8,402	\$9,307	\$10,237
65T60174AB_	174	60	2	\$2,209	\$2,593	\$2,723	\$3,535	\$3,712	\$8,538	\$9,392	\$10,378	\$11,415
65T48180AB_	180	48	2	\$1,903	\$2,210	\$2,320	\$3,004	\$3,154	\$7,066	\$7,773	\$8,592	\$9,451
65T54180AB_	180	54	2	\$2,088	\$2,574	\$2,703	\$3,507	\$3,682	\$7,893	\$8,683	\$9,592	\$10,551
65T60180AB_	180	60	2	\$2,276	\$2,601	\$2,731	\$3,543	\$3,720	\$8,833	\$9,716	\$10,734	\$11,807
65T48186AB_	186	48	2	\$1,959	\$2,214	\$2,325	\$3,011	\$3,162	\$7,302	\$8,032	\$8,877	\$9,765
65T54186AB_	186	54	2	\$2,150	\$2,579	\$2,707	\$3,512	\$3,687	\$8,133	\$8,947	\$9,948	\$10,943
65T60186AB_	186	60	2	\$2,343	\$2,604	\$2,735	\$3,548	\$3,725	\$9,127	\$10,040	\$11,094	\$12,203
65T48192AB_	192	48	2	\$2,014	\$2,219	\$2,330	\$3,017	\$3,168	\$7,537	\$8,291	\$9,162	\$10,079
65T54192AB_	192	54	2	\$2,212	\$2,583	\$2,712	\$3,517	\$3,693	\$8,375	\$9,213	\$10,305	\$11,335
65T60192AB_	192	60	2	\$2,411	\$2,608	\$2,739	\$3,554	\$3,732	\$9,422	\$10,364	\$11,453	\$12,598
65T48198AB_	198	48	2	\$2,087	\$3,089	\$3,244	\$4,170	\$4,378	\$8,604	\$9,464	\$10,406	\$11,446
65T54198AB_	198	54	2	\$2,291	\$3,517	\$3,693	\$4,790	\$5,029	\$9,574	\$10,532	\$11,521	\$12,673
65T60198AB_	198	60	2	\$2,497	\$3,554	\$3,732	\$4,838	\$5,080	\$10,746	\$11,821	\$12,933	\$14,226
65T48204AB_	204	48	3	\$2,159	\$3,132	\$3,288	\$4,251	\$4,464	\$8,856	\$9,742	\$10,658	\$11,724
65T54204AB_	204	54	3	\$2,371	\$3,525	\$3,701	\$4,796	\$5,036	\$9,899	\$10,889	\$11,912	\$13,104
65T60204AB_	204	60	3	\$2,584	\$3,562	\$3,740	\$4,846	\$5,088	\$11,070	\$12,177	\$13,326	\$14,658
65T48210AB_	210	48	3	\$2,233	\$3,136	\$3,293	\$4,259	\$4,471	\$9,115	\$10,026	\$10,970	\$12,067
65T54210AB_	210	54	3	\$2,450	\$3,529	\$3,706	\$4,802	\$5,042	\$10,222	\$11,244	\$12,304	\$13,534
65T60210AB_	210	60	3	\$2,670	\$3,565	\$3,744	\$4,852	\$5,094	\$11,394	\$12,534	\$13,717	\$15,089

Model	TFL Top Surface	HPL Top Surface	Top Profile	Veneer Top Material	Top Surface Power Cutout
	see Anthology TFL Top Surface Finishes	see Anthology HPL Top Surface Finishes	see Anthology Top Profile Finishes (when applicable)	see Anthology Veneer Top Material Finishes	see Anthology Top Surface Power Cutout

**Arc Boat Table Tops (continued)**

- ends are 6" narrower than overall center dimension with 8" radius corners
- planning top specification [ANPG\\_6](#)
- base guide [pages 38-57](#)
- planning power guide [ANPG\\_20- ANPG\\_40](#)

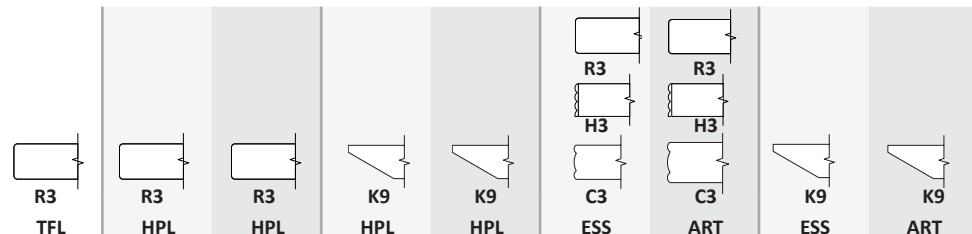
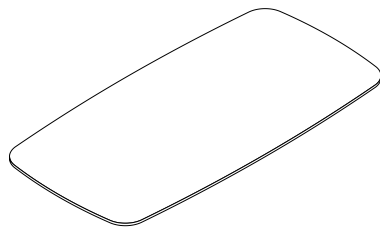

① Model	W	D	Top Pieces	R3 TFL T	R3 HPL Tier 1 H	R3 HPL Tier 2 H	K9 HPL Tier 1 KH	K9 HPL Tier 2 KH	R3 H3 C3 ESS Veneer V	R3 H3 C3 ART Veneer V	K9 ESS Veneer KV	K9 ART Veneer KV
65T48216AB_	216	48	3	\$2,305	\$3,140	\$3,297	\$4,266	\$4,479	\$9,375	\$10,312	\$11,282	\$12,410
65T54216AB_	216	54	3	\$2,529	\$3,533	\$3,710	\$4,808	\$5,048	\$10,547	\$11,601	\$12,695	\$13,965
65T60216AB_	216	60	3	\$2,757	\$3,569	\$3,748	\$4,857	\$5,100	\$11,718	\$12,890	\$14,108	\$15,519
65T48222AB_	222	48	3	\$2,378	\$3,144	\$3,301	\$4,271	\$4,484	\$9,636	\$10,600	\$11,597	\$12,757
65T54222AB_	222	54	3	\$2,608	\$3,588	\$3,767	\$4,884	\$5,128	\$10,808	\$11,889	\$13,010	\$14,311
65T60222AB_	222	60	3	\$2,843	\$3,625	\$3,806	\$4,934	\$5,181	\$12,045	\$13,250	\$14,500	\$15,950
65T48228AB_	228	48	3	\$2,451	\$3,148	\$3,306	\$4,277	\$4,491	\$9,899	\$10,889	\$11,912	\$13,104
65T54228AB_	228	54	3	\$2,688	\$3,643	\$3,825	\$4,959	\$5,207	\$11,070	\$12,177	\$13,326	\$14,658
65T60228AB_	228	60	3	\$2,930	\$3,681	\$3,865	\$5,010	\$5,261	\$12,372	\$13,609	\$14,891	\$16,380
65T48234AB_	234	48	3	\$2,524	\$3,271	\$3,434	\$4,340	\$4,557	\$10,157	\$11,173	\$12,225	\$13,447
65T54234AB_	234	54	3	\$2,767	\$3,648	\$3,830	\$4,965	\$5,213	\$11,394	\$12,534	\$13,717	\$15,089
65T60234AB_	234	60	3	\$3,016	\$3,686	\$3,870	\$5,017	\$5,267	\$12,695	\$13,965	\$15,283	\$16,811
65T48240AB_	240	48	3	\$2,597	\$3,394	\$3,564	\$4,403	\$4,623	\$10,417	\$11,459	\$12,537	\$13,790
65T54240AB_	240	54	3	\$2,849	\$3,653	\$3,835	\$4,972	\$5,221	\$11,718	\$12,890	\$14,108	\$15,519
65T60240AB_	240	60	3	\$3,103	\$3,691	\$3,876	\$5,023	\$5,274	\$13,020	\$14,322	\$15,675	\$17,242

Model	TFL Top Surface	HPL Top Surface	Top Profile	Veneer Top Material	Top Surface Power Cutout
	<a href="#">see Anthology TFL Top Surface Finishes</a>	<a href="#">see Anthology HPL Top Surface Finishes</a>	<a href="#">see Anthology Top Profile Finishes</a> (when applicable)	<a href="#">see Anthology Veneer Top Material Finishes</a>	<a href="#">see Anthology Top Surface Power Cutout</a>

**Racetrack Table Tops**

- planning top specification [ANPG\\_6](#)
- base guide [pages 38-57](#)
- planning power guide [ANPG\\_20- ANPG\\_40](#)

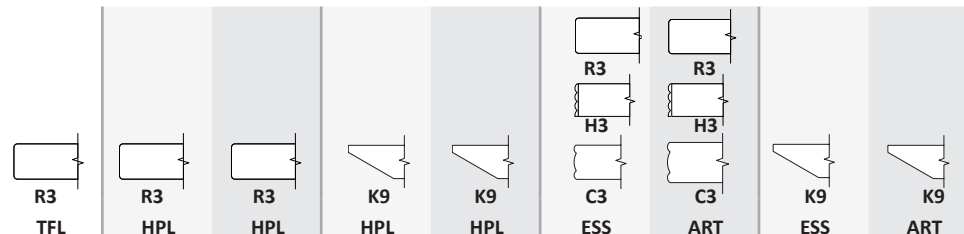
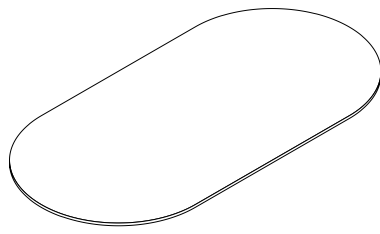

Model	W	D	Top Pieces	R3 TFL T	R3 HPL Tier 1 H	R3 HPL Tier 2 H	K9 HPL Tier 1 KH	K9 HPL Tier 2 KH	ESS Veneer V	ART Veneer V	ESS Veneer KV	ART Veneer KV
65T3672RK_	72	36	1	\$491	\$802	\$842	\$1,172	\$1,230	\$2,122	\$2,334	\$2,491	\$2,740
65T4272RK_	72	42	1	\$590	\$861	\$904	\$1,254	\$1,317	\$2,356	\$2,592	\$2,903	\$3,193
65T4872RK_	72	48	1	\$675	\$866	\$909	\$1,258	\$1,321	\$2,628	\$2,891	\$3,154	\$3,470
65T3678RK_	78	36	1	\$551	\$917	\$963	\$1,201	\$1,262	\$2,280	\$2,508	\$2,697	\$2,967
65T4278RK_	78	42	1	\$649	\$952	\$1,000	\$1,301	\$1,366	\$2,530	\$2,783	\$3,039	\$3,343
65T4878RK_	78	48	1	\$735	\$956	\$1,004	\$1,306	\$1,371	\$2,822	\$3,104	\$3,369	\$3,705
65T3684RK_	84	36	1	\$610	\$935	\$981	\$1,219	\$1,280	\$2,427	\$2,670	\$2,903	\$3,193
65T4284RK_	84	42	1	\$709	\$978	\$1,027	\$1,315	\$1,380	\$2,696	\$2,966	\$3,315	\$3,646
65T4884RK_	84	48	1	\$795	\$982	\$1,031	\$1,320	\$1,386	\$3,010	\$3,311	\$3,645	\$4,009
65T3690RK_	90	36	1	\$670	\$951	\$999	\$1,235	\$1,297	\$2,579	\$2,836	\$3,109	\$3,420
65T4290RK_	90	42	1	\$769	\$1,004	\$1,054	\$1,324	\$1,390	\$2,864	\$3,150	\$3,592	\$3,951
65T4890RK_	90	48	1	\$854	\$1,008	\$1,058	\$1,328	\$1,395	\$3,201	\$3,521	\$3,889	\$4,278
65T3696RK_	96	36	1	\$730	\$968	\$1,016	\$1,252	\$1,315	\$2,728	\$3,001	\$3,315	\$3,646
65T4296RK_	96	42	1	\$829	\$1,030	\$1,082	\$1,332	\$1,399	\$3,029	\$3,332	\$3,869	\$4,256
65T4896RK_	96	48	1	\$914	\$1,035	\$1,086	\$1,336	\$1,403	\$3,349	\$3,684	\$4,134	\$4,547
65T42102RK1_	102	42	1	\$860	\$1,513	\$1,588	\$2,058	\$2,161	\$3,466	\$3,813	\$3,895	\$4,284
65T48102RK1_	102	48	1	\$925	\$1,521	\$1,597	\$2,082	\$2,186	\$3,787	\$4,165	\$4,557	\$5,013
65T42102RK2_	102	42	2	\$1,066	\$1,627	\$1,708	\$2,214	\$2,325	\$3,728	\$4,101	\$4,187	\$4,606
65T48102RK2_	102	48	2	\$1,174	\$1,635	\$1,717	\$2,239	\$2,351	\$4,072	\$4,479	\$4,900	\$5,390
65T42108RK1_	108	42	1	\$906	\$1,536	\$1,613	\$2,063	\$2,166	\$3,623	\$3,985	\$4,130	\$4,543
65T48108RK1_	108	48	1	\$985	\$1,543	\$1,621	\$2,106	\$2,211	\$3,943	\$4,338	\$4,792	\$5,271
65T42108RK2_	108	42	2	\$1,119	\$1,652	\$1,734	\$2,218	\$2,329	\$3,896	\$4,286	\$4,440	\$4,884
65T48108RK2_	108	48	2	\$1,233	\$1,660	\$1,743	\$2,264	\$2,378	\$4,240	\$4,664	\$5,153	\$5,668
65T42114RK1_	114	42	2	\$952	\$1,560	\$1,638	\$2,087	\$2,191	\$3,799	\$4,179	\$4,396	\$4,835
65T48114RK1_	114	48	2	\$1,045	\$1,567	\$1,645	\$2,130	\$2,236	\$4,163	\$4,579	\$5,057	\$5,562
65T42114RK2_	114	42	2	\$1,173	\$1,677	\$1,761	\$2,243	\$2,355	\$4,085	\$4,494	\$4,726	\$5,199
65T48114RK2_	114	48	2	\$1,293	\$1,686	\$1,770	\$2,289	\$2,404	\$4,476	\$4,923	\$5,438	\$5,982

Model	TFL Top Surface	HPL Top Surface	Top Profile	Veneer Top Material	Top Surface Power Cutout
	<a href="#">see Anthology TFL Top Surface Finishes</a>	<a href="#">see Anthology HPL Top Surface Finishes</a>	<a href="#">see Anthology Top Profile Finishes</a> (when applicable)	<a href="#">see Anthology Veneer Top Material Finishes</a>	<a href="#">see Anthology Top Surface Power Cutout</a>

**Racetrack Table Tops (continued)**

- planning top specification [ANPG\\_6](#)
- base guide [pages 38-57](#)
- planning power guide [ANPG\\_20- ANPG\\_40](#)

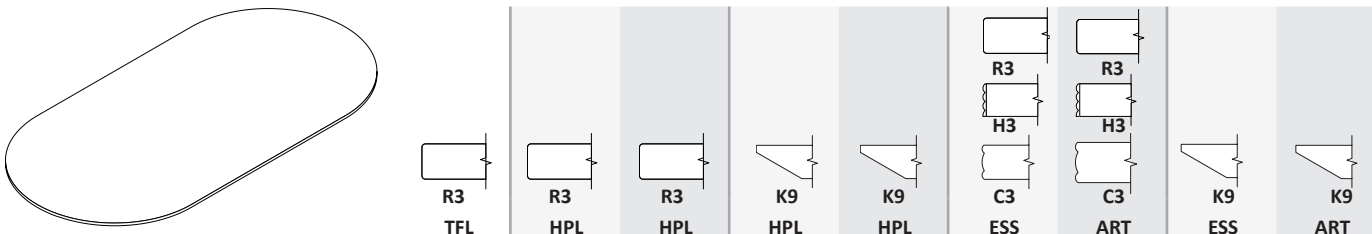

Model	W	D	Top Pieces	R3 TFL	R3 HPL Tier 1 H	R3 HPL Tier 2 H	K9 HPL Tier 1 KH	K9 HPL Tier 2 KH	C3 ESS Veneer V	C3 ART Veneer V	K9 ESS Veneer KV	K9 ART Veneer KV
65T42120RK1_	120	42	1	\$999	\$1,583	\$1,662	\$2,109	\$2,215	\$3,976	\$4,374	\$4,660	\$5,126
65T48120RK1_	120	48	1	\$1,105	\$1,591	\$1,670	\$2,152	\$2,260	\$4,381	\$4,819	\$5,324	\$5,856
65T54120RK1_	120	54	1	\$1,210	\$1,788	\$1,877	\$2,425	\$2,546	\$4,830	\$5,313	\$5,834	\$6,418
65T60120RK1_	120	60	1	\$1,315	\$1,806	\$1,896	\$2,450	\$2,572	\$5,477	\$6,025	\$6,659	\$7,325
65T42120RK2_	120	42	2	\$1,226	\$1,702	\$1,787	\$2,268	\$2,381	\$4,275	\$4,702	\$5,011	\$5,513
65T48120RK2_	120	48	2	\$1,226	\$1,710	\$1,796	\$2,315	\$2,431	\$4,711	\$5,182	\$5,724	\$6,297
65T54120RK2_	120	54	2	\$1,480	\$1,922	\$2,019	\$2,607	\$2,738	\$5,194	\$5,713	\$6,273	\$6,900
65T60120RK2_	120	60	2	\$1,606	\$1,942	\$2,039	\$2,634	\$2,766	\$5,889	\$6,478	\$7,160	\$7,876
65T48126RK_	126	48	2	\$1,409	\$1,751	\$1,839	\$2,414	\$2,534	\$4,947	\$5,441	\$6,013	\$6,614
65T54126RK_	126	54	2	\$1,538	\$2,028	\$2,129	\$2,863	\$3,006	\$5,427	\$5,969	\$6,556	\$7,212
65T60126RK_	126	60	2	\$1,673	\$2,049	\$2,152	\$2,893	\$3,037	\$6,184	\$6,802	\$7,516	\$8,268
65T48132RK_	132	48	2	\$1,464	\$1,793	\$1,882	\$2,513	\$2,638	\$5,182	\$5,701	\$6,301	\$6,931
65T54132RK_	132	54	2	\$1,600	\$2,134	\$2,240	\$3,119	\$3,275	\$5,658	\$6,224	\$6,840	\$7,524
65T60132RK_	132	60	2	\$1,740	\$2,155	\$2,263	\$3,151	\$3,309	\$6,477	\$7,125	\$7,873	\$8,660
65T48138RK_	138	48	2	\$1,519	\$1,834	\$1,926	\$2,613	\$2,743	\$5,417	\$5,959	\$6,587	\$7,246
65T54138RK_	138	54	2	\$1,662	\$2,138	\$2,245	\$3,126	\$3,282	\$5,891	\$6,480	\$7,286	\$8,014
65T60138RK_	138	60	2	\$1,807	\$2,159	\$2,267	\$3,157	\$3,315	\$6,772	\$7,449	\$8,232	\$9,055
65T48144RK_	144	48	2	\$1,573	\$1,874	\$1,968	\$2,710	\$2,846	\$5,653	\$6,218	\$6,872	\$7,559
65T54144RK_	144	54	2	\$1,724	\$2,143	\$2,250	\$3,131	\$3,287	\$6,122	\$6,734	\$7,732	\$8,505
65T60144RK_	144	60	2	\$1,874	\$2,165	\$2,273	\$3,163	\$3,321	\$7,066	\$7,773	\$8,592	\$9,451
65T48150RK_	150	48	2	\$1,629	\$1,957	\$2,055	\$2,781	\$2,921	\$5,889	\$6,478	\$7,158	\$7,874
65T54150RK_	150	54	2	\$1,784	\$2,349	\$2,466	\$3,314	\$3,480	\$6,353	\$6,988	\$8,017	\$8,819
65T60150RK_	150	60	2	\$1,941	\$2,374	\$2,492	\$3,340	\$3,507	\$7,361	\$8,097	\$8,947	\$9,842
65T48156RK_	156	48	2	\$1,684	\$2,043	\$2,145	\$2,853	\$2,995	\$6,124	\$6,736	\$7,443	\$8,188
65T54156RK_	156	54	2	\$1,845	\$2,557	\$2,685	\$3,482	\$3,656	\$6,582	\$7,240	\$8,303	\$9,134
65T60156RK_	156	60	2	\$2,008	\$2,583	\$2,712	\$3,517	\$3,693	\$7,655	\$8,421	\$9,303	\$10,234

Model	TFL Top Surface	HPL Top Surface	Top Profile	Veneer Top Material	Top Surface Power Cutout
	see Anthology TFL Top Surface Finishes	see Anthology HPL Top Surface Finishes	see Anthology Top Profile Finishes (when applicable)	see Anthology Veneer Top Material Finishes	see Anthology Top Surface Power Cutout



**Racetrack Table Tops (continued)**

- planning top specification [ANPG\\_6](#)
- base guide [pages 38-57](#)
- planning power guide [ANPG\\_20- ANPG\\_40](#)

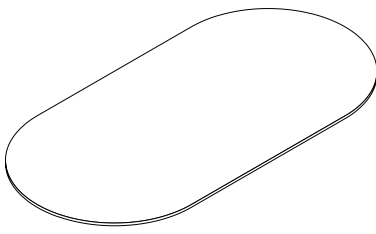

① Model	W	D	Top Pieces	R3		K9		ESS		ART		
				TFL	HPL Tier 1	HPL Tier 2	HPL Tier 1	HPL Tier 2	Veneer V	Veneer V	Veneer KV	Veneer KV
65T48162RK_	162	48	2	\$1,739	\$2,121	\$2,227	\$2,923	\$3,069	\$6,360	\$6,996	\$7,730	\$8,503
65T54162RK_	162	54	2	\$1,906	\$2,560	\$2,688	\$3,487	\$3,661	\$6,982	\$7,680	\$8,662	\$9,528
65T60162RK_	162	60	2	\$2,075	\$2,586	\$2,715	\$3,523	\$3,699	\$7,950	\$8,745	\$9,663	\$10,629
65T48168RK_	168	48	2	\$1,794	\$2,203	\$2,313	\$2,993	\$3,142	\$6,596	\$7,255	\$8,014	\$8,815
65T54168RK_	168	54	2	\$1,967	\$2,564	\$2,692	\$3,494	\$3,669	\$7,383	\$8,121	\$9,021	\$9,923
65T60168RK_	168	60	2	\$2,142	\$2,591	\$2,720	\$3,530	\$3,707	\$8,244	\$9,068	\$10,022	\$11,025
65T48174RK_	174	48	2	\$1,848	\$2,207	\$2,317	\$2,999	\$3,149	\$6,830	\$7,513	\$8,303	\$9,134
65T54174RK_	174	54	2	\$2,028	\$2,566	\$2,695	\$3,499	\$3,674	\$7,638	\$8,402	\$9,307	\$10,237
65T60174RK_	174	60	2	\$2,209	\$2,593	\$2,723	\$3,535	\$3,712	\$8,538	\$9,392	\$10,378	\$11,415
65T48180RK_	180	48	2	\$1,903	\$2,210	\$2,320	\$3,004	\$3,154	\$7,066	\$7,773	\$8,592	\$9,451
65T54180RK_	180	54	2	\$2,088	\$2,574	\$2,703	\$3,507	\$3,682	\$7,893	\$8,683	\$9,592	\$10,551
65T60180RK_	180	60	2	\$2,276	\$2,601	\$2,731	\$3,543	\$3,720	\$8,833	\$9,716	\$10,734	\$11,807
65T48186RK_	186	48	2	\$1,959	\$2,214	\$2,325	\$3,011	\$3,162	\$7,302	\$8,032	\$8,877	\$9,765
65T54186RK_	186	54	2	\$2,150	\$2,579	\$2,707	\$3,512	\$3,687	\$8,133	\$8,947	\$9,948	\$10,943
65T60186RK_	186	60	2	\$2,343	\$2,604	\$2,735	\$3,548	\$3,725	\$9,127	\$10,040	\$11,094	\$12,203
65T48192RK_	192	48	2	\$2,014	\$2,219	\$2,330	\$3,017	\$3,168	\$7,537	\$8,291	\$9,162	\$10,079
65T54192RK_	192	54	2	\$2,212	\$2,583	\$2,712	\$3,517	\$3,693	\$8,375	\$9,213	\$10,305	\$11,335
65T60192RK_	192	60	2	\$2,411	\$2,608	\$2,739	\$3,554	\$3,732	\$9,422	\$10,364	\$11,453	\$12,598
65T48198RK_	198	48	2	\$2,087	\$3,089	\$3,244	\$4,170	\$4,378	\$8,604	\$9,464	\$10,406	\$11,446
65T54198RK_	198	54	2	\$2,291	\$3,517	\$3,693	\$4,790	\$5,029	\$9,574	\$10,532	\$11,521	\$12,673
65T60198RK_	198	60	2	\$2,497	\$3,554	\$3,732	\$4,838	\$5,080	\$10,746	\$11,821	\$12,933	\$14,226
65T48204RK_	204	48	3	\$2,159	\$3,132	\$3,288	\$4,251	\$4,464	\$8,856	\$9,742	\$10,658	\$11,724
65T54204RK_	204	54	3	\$2,371	\$3,525	\$3,701	\$4,796	\$5,036	\$9,899	\$10,889	\$11,912	\$13,104
65T60204RK_	204	60	3	\$2,584	\$3,562	\$3,740	\$4,846	\$5,088	\$11,070	\$12,177	\$13,326	\$14,658
65T48210RK_	210	48	3	\$2,233	\$3,136	\$3,293	\$4,259	\$4,471	\$9,115	\$10,026	\$10,970	\$12,067
65T54210RK_	210	54	3	\$2,450	\$3,529	\$3,706	\$4,802	\$5,042	\$10,222	\$11,244	\$12,304	\$13,534
65T60210RK_	210	60	3	\$2,670	\$3,565	\$3,744	\$4,852	\$5,094	\$11,394	\$12,534	\$13,717	\$15,089

Model	TFL Top Surface	HPL Top Surface	Top Profile	Veneer Top Material	Top Surface Power Cutout
	see Anthology TFL Top Surface Finishes	see Anthology HPL Top Surface Finishes	see Anthology Top Profile Finishes (when applicable)	see Anthology Veneer Top Material Finishes	see Anthology Top Surface Power Cutout



**Racetrack Table Tops (continued)**

- planning top specification [ANPG\\_6](#)
- base guide [pages 38-57](#)
- planning power guide [ANPG\\_20- ANPG\\_40](#)

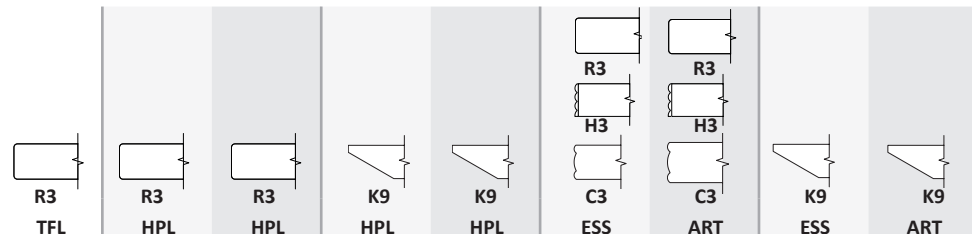
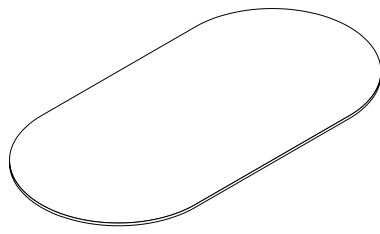

① Model	W	D	Top Pieces	R3 TFL T	R3 HPL Tier 1 H	R3 HPL Tier 2 H	K9 HPL Tier 1 KH	K9 HPL Tier 2 KH	R3 H3 C3 ESS Veneer V	R3 H3 C3 ART Veneer V	K9 ESS Veneer KV	K9 ART Veneer KV
65T48216RK_	216	48	3	\$2,305	\$3,140	\$3,297	\$4,266	\$4,479	\$9,375	\$10,312	\$11,282	\$12,410
65T54216RK_	216	54	3	\$2,529	\$3,533	\$3,710	\$4,808	\$5,048	\$10,547	\$11,601	\$12,695	\$13,965
65T60216RK_	216	60	3	\$2,757	\$3,569	\$3,748	\$4,857	\$5,100	\$11,718	\$12,890	\$14,108	\$15,519
65T48222RK_	222	48	3	\$2,378	\$3,144	\$3,301	\$4,271	\$4,484	\$9,636	\$10,600	\$11,597	\$12,757
65T54222RK_	222	54	3	\$2,608	\$3,588	\$3,767	\$4,884	\$5,128	\$10,808	\$11,889	\$13,010	\$14,311
65T60222RK_	222	60	3	\$2,843	\$3,625	\$3,806	\$4,934	\$5,181	\$12,045	\$13,250	\$14,500	\$15,950
65T48228RK_	228	48	3	\$2,451	\$3,148	\$3,306	\$4,277	\$4,491	\$9,899	\$10,889	\$11,912	\$13,104
65T54228RK_	228	54	3	\$2,688	\$3,643	\$3,825	\$4,959	\$5,207	\$11,070	\$12,177	\$13,326	\$14,658
65T60228RK_	228	60	3	\$2,930	\$3,681	\$3,865	\$5,010	\$5,261	\$12,372	\$13,609	\$14,891	\$16,380
65T48234RK_	234	48	3	\$2,524	\$3,271	\$3,434	\$4,340	\$4,557	\$10,157	\$11,173	\$12,225	\$13,447
65T54234RK_	234	54	3	\$2,767	\$3,648	\$3,830	\$4,965	\$5,213	\$11,394	\$12,534	\$13,717	\$15,089
65T60234RK_	234	60	3	\$3,016	\$3,686	\$3,870	\$5,017	\$5,267	\$12,695	\$13,965	\$15,283	\$16,811
65T48240RK_	240	48	3	\$2,597	\$3,394	\$3,564	\$4,403	\$4,623	\$10,417	\$11,459	\$12,537	\$13,790
65T54240RK_	240	54	3	\$2,849	\$3,653	\$3,835	\$4,972	\$5,221	\$11,718	\$12,890	\$14,108	\$15,519
65T60240RK_	240	60	3	\$3,103	\$3,691	\$3,876	\$5,023	\$5,274	\$13,020	\$14,322	\$15,675	\$17,242

Model	TFL Top Surface	HPL Top Surface	Top Profile	Veneer Top Material	Top Surface Power Cutout
	see Anthology TFL Top Surface Finishes	see Anthology HPL Top Surface Finishes	see Anthology Top Profile Finishes (when applicable)	see Anthology Veneer Top Material Finishes	see Anthology Top Surface Power Cutout

**Round Table Tops**

- planning top specification [ANPG\\_6](#)
- base guide [pages 38-57](#)
- planning power guide [ANPG\\_20- ANPG\\_40](#)

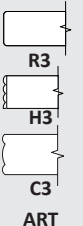
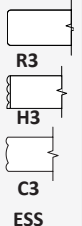
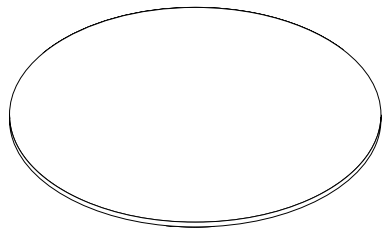

① Model	W	D	Top Pieces	R3 TFL T	R3 HPL Tier 1 H	R3 HPL Tier 2 H	K9 HPL Tier 1 KH	K9 HPL Tier 2 KH	R3 H3 C3 ESS Veneer V	R3 H3 C3 ART Veneer V	K9 ESS Veneer KV	K9 ART Veneer KV
65T36RD_	36	36	1	\$398	\$403	\$423	\$684	\$718	\$1,938	\$2,132	\$2,503	\$2,753
65T42RD_	42	42	1	\$505	\$562	\$590	\$787	\$826	\$2,467	\$2,713	\$3,128	\$3,440
65T48RD_	48	48	1	\$556	\$562	\$590	\$800	\$840	\$2,958	\$3,253	\$3,757	\$4,133
65T54RD_	54	54	1	\$695	\$712	\$747	\$1,039	\$1,091	\$3,697	\$4,066	\$4,697	\$5,167
65T60RD_	60	60	1	\$734	\$748	\$785	\$1,073	\$1,126	\$4,927	\$5,419	\$6,260	\$6,886

Model	TFL Top Surface	HPL Top Surface	Top Profile	Veneer Top Material	Top Surface Power Cutout
	<a href="#">see Anthology TFL Top Surface Finishes</a>	<a href="#">see Anthology HPL Top Surface Finishes</a>	<a href="#">see Anthology Top Profile Finishes</a> (when applicable)	<a href="#">see Anthology Veneer Top Material Finishes</a>	<a href="#">see Anthology Top Surface Power Cutout</a>

**Bridge Base Kit**

- available in Maple, Oak and Walnut solid wood
- top shapes: Rectangular, Soft Rectangular, Arc Rectangular, Boat, Arc Boat and Racetrack
- planning base specification [ANPG\\_8](#)
- planning base location [ANPG\\_18](#)
- planning power guide [ANPG\\_20- ANPG\\_40](#)

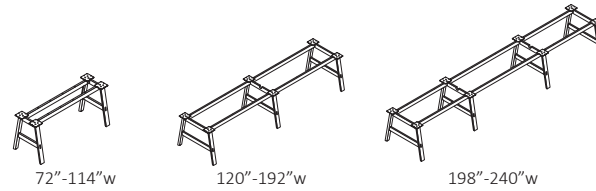

D	W	H	CTN WT	CU FT	Model	Description	List Price
<b>Bridge Base Kit for 36/42" deep Table</b>							
24	48	27½	54	7	<b>65T2472BGBW</b>	Bridge Solid Wood Base Kit for 36/42"d x 72"w Top Surfaces	<b>\$2,242</b>
24	54	27½	54	7	<b>65T2478BGBW</b>	Bridge Solid Wood Base Kit for 36/42"d x 78"w Top Surfaces	<b>\$2,255</b>
24	54	27½	54	7	<b>65T2484BGBW</b>	Bridge Solid Wood Base Kit for 36/42"d x 84"w Top Surfaces	<b>\$2,268</b>
24	60	27½	55	7	<b>65T2490BGBW</b>	Bridge Solid Wood Base Kit for 36/42"d x 90"w Top Surfaces	<b>\$2,281</b>
24	60	27½	55	7	<b>65T2496BGBW</b>	Bridge Solid Wood Base Kit for 36/42"d x 90"w Top Surfaces	<b>\$2,294</b>
<b>Bridge Base Kit for 42" deep Table</b>							
24	66	27½	56	7	<b>65T24102BGBW</b>	Bridge Solid Wood Base Kit for 42"d x 102"w Top Surfaces	<b>\$2,307</b>
24	72	27½	56	7	<b>65T24108BGBW</b>	Bridge Solid Wood Base Kit for 42"d x 108"w Top Surfaces	<b>\$2,320</b>
24	78	27½	56	7	<b>65T24114BGBW</b>	Bridge Solid Wood Base Kit for 42"d x 114"w Top Surfaces	<b>\$2,333</b>
24	84	27½	76	10	<b>65T24120BGBW</b>	Bridge Solid Wood Base Kit for 42"d x 120"w Top Surfaces	<b>\$2,346</b>
<b>Bridge Base Kit for 48" deep Table</b>							
30	48	27½	56	9	<b>65T3072BGBW</b>	Bridge Solid Wood Base Kit for 48"d x 72"w Top Surfaces	<b>\$2,360</b>
30	54	27½	56	9	<b>65T3078BGBW</b>	Bridge Solid Wood Base Kit for 48"d x 78"w Top Surfaces	<b>\$2,373</b>
30	54	27½	56	9	<b>65T3084BGBW</b>	Bridge Solid Wood Base Kit for 48"d x 84"w Top Surfaces	<b>\$2,386</b>
30	60	27½	56	9	<b>65T3090BGBW</b>	Bridge Solid Wood Base Kit for 48"d x 90"w Top Surfaces	<b>\$2,399</b>
30	60	27½	57	10	<b>65T3096BGBW</b>	Bridge Solid Wood Base Kit for 48"d x 96"w Top Surfaces	<b>\$2,413</b>
30	66	27½	57	10	<b>65T30102BGBW</b>	Bridge Solid Wood Base Kit for 48"d x 102"w Top Surfaces	<b>\$2,680</b>
30	72	27½	57	10	<b>65T30108BGBW</b>	Bridge Solid Wood Base Kit for 48"d x 108"w Top Surfaces	<b>\$2,947</b>
30	78	27½	57	10	<b>65T30114BGBW</b>	Bridge Solid Wood Base Kit for 48"d x 114"w Top Surfaces	<b>\$3,214</b>
30	84	27½	77	15	<b>65T30120BGBW</b>	Bridge Solid Wood Base Kit for 48"d x 120"w Top Surfaces	<b>\$3,481</b>
30	90	27½	77	15	<b>65T30126BGBW</b>	Bridge Solid Wood Base Kit for 48"d x 126"w Top Surfaces	<b>\$3,487</b>
30	96	27½	77	15	<b>65T30132BGBW</b>	Bridge Solid Wood Base Kit for 48"d x 132"w Top Surfaces	<b>\$3,493</b>
30	102	27½	77	15	<b>65T30138BGBW</b>	Bridge Solid Wood Base Kit for 48"d x 138"w Top Surfaces	<b>\$3,499</b>
30	108	27½	78	15	<b>65T30144BGBW</b>	Bridge Solid Wood Base Kit for 48"d x 144"w Top Surfaces	<b>\$3,506</b>
30	114	27½	78	15	<b>65T30150BGBW</b>	Bridge Solid Wood Base Kit for 48"d x 150"w Top Surfaces	<b>\$3,512</b>
30	120	27½	78	15	<b>65T30156BGBW</b>	Bridge Solid Wood Base Kit for 48"d x 156"w Top Surfaces	<b>\$3,518</b>
30	126	27½	78	15	<b>65T30162BGBW</b>	Bridge Solid Wood Base Kit for 48"d x 162"w Top Surfaces	<b>\$3,524</b>
30	132	27½	79	15	<b>65T30168BGBW</b>	Bridge Solid Wood Base Kit for 48"d x 168"w Top Surfaces	<b>\$3,530</b>
30	138	27½	79	15	<b>65T30174BGBW</b>	Bridge Solid Wood Base Kit for 48"d x 174"w Top Surfaces	<b>\$3,536</b>
30	144	27½	79	15	<b>65T30180BGBW</b>	Bridge Solid Wood Base Kit for 48"d x 180"w Top Surfaces	<b>\$3,542</b>
30	150	27½	80	15	<b>65T30186BGBW</b>	Bridge Solid Wood Base Kit for 48"d x 186"w Top Surfaces	<b>\$3,548</b>
30	156	27½	80	15	<b>65T30192BGBW</b>	Bridge Solid Wood Base Kit for 48"d x 192"w Top Surfaces	<b>\$3,555</b>
30	162	27½	101	19	<b>65T30198BGBW</b>	Bridge Solid Wood Base Kit for 48"d x 198"w Top Surfaces	<b>\$3,679</b>
30	168	27½	101	19	<b>65T30204BGBW</b>	Bridge Solid Wood Base Kit for 48"d x 204"w Top Surfaces	<b>\$3,803</b>
30	174	27½	102	19	<b>65T30210BGBW</b>	Bridge Solid Wood Base Kit for 48"d x 210"w Top Surfaces	<b>\$3,927</b>
30	180	27½	102	20	<b>65T30216BGBW</b>	Bridge Solid Wood Base Kit for 48"d x 216"w Top Surfaces	<b>\$4,051</b>
30	186	27½	105	20	<b>65T30222BGBW</b>	Bridge Solid Wood Base Kit for 48"d x 222"w Top Surfaces	<b>\$4,175</b>
30	192	27½	105	20	<b>65T30228BGBW</b>	Bridge Solid Wood Base Kit for 48"d x 228"w Top Surfaces	<b>\$4,299</b>
30	198	27½	107	20	<b>65T30234BGBW</b>	Bridge Solid Wood Base Kit for 48"d x 234"w Top Surfaces	<b>\$4,423</b>
30	204	27½	107	20	<b>65T30240BGBW</b>	Bridge Solid Wood Base Kit for 48"d x 240"w Top Surfaces	<b>\$4,545</b>

**Model Base Wood**

[see Anthology Solid Wood Finishes](#)

**Bridge Base Kit**

- available in Maple, Oak and Walnut solid wood
- top shapes: Rectangular, Soft Rectangular, Arc Rectangular, Boat, Arc Boat and Racetrack
- planning base specification [ANPG\\_8](#)
- planning base location [ANPG\\_18](#)
- planning power guide [ANPG\\_20- ANPG\\_40](#)

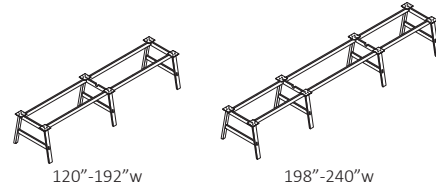

D	W	H	CTN WT	CU FT	Model	Description	List Price
<b>Bridge Base Kit for 54/60"deep Table</b>							
36	84	27 $\frac{7}{8}$	93	19	<b>65T36120BGBW</b>	Bridge Solid Wood Base Kit for 54/60"d x 120"w Top Surfaces	<b>\$3,533</b>
36	90	27 $\frac{7}{8}$	93	19	<b>65T36126BGBW</b>	Bridge Solid Wood Base Kit for 54/60"d x 126"w Top Surfaces	<b>\$3,539</b>
36	96	27 $\frac{7}{8}$	94	19	<b>65T36132BGBW</b>	Bridge Solid Wood Base Kit for 54/60"d x 132"w Top Surfaces	<b>\$3,545</b>
36	102	27 $\frac{7}{8}$	94	19	<b>65T36138BGBW</b>	Bridge Solid Wood Base Kit for 54/60"d x 138"w Top Surfaces	<b>\$3,551</b>
36	108	27 $\frac{7}{8}$	95	19	<b>65T36144BGBW</b>	Bridge Solid Wood Base Kit for 54/60"d x 144"w Top Surfaces	<b>\$3,558</b>
36	114	27 $\frac{7}{8}$	95	19	<b>65T36150BGBW</b>	Bridge Solid Wood Base Kit for 54/60"d x 150"w Top Surfaces	<b>\$3,564</b>
36	120	27 $\frac{7}{8}$	95	19	<b>65T36156BGBW</b>	Bridge Solid Wood Base Kit for 54/60"d x 156"w Top Surfaces	<b>\$3,570</b>
36	126	27 $\frac{7}{8}$	97	19	<b>65T36162BGBW</b>	Bridge Solid Wood Base Kit for 54/60"d x 162"w Top Surfaces	<b>\$3,576</b>
36	132	27 $\frac{7}{8}$	97	19	<b>65T36168BGBW</b>	Bridge Solid Wood Base Kit for 54/60"d x 168"w Top Surfaces	<b>\$3,582</b>
36	138	27 $\frac{7}{8}$	97	19	<b>65T36174BGBW</b>	Bridge Solid Wood Base Kit for 54/60"d x 174"w Top Surfaces	<b>\$3,589</b>
36	144	27 $\frac{7}{8}$	99	19	<b>65T36180BGBW</b>	Bridge Solid Wood Base Kit for 54/60"d x 180"w Top Surfaces	<b>\$3,595</b>
36	150	27 $\frac{7}{8}$	99	19	<b>65T36186BGBW</b>	Bridge Solid Wood Base Kit for 54/60"d x 186"w Top Surfaces	<b>\$3,601</b>
36	156	27 $\frac{7}{8}$	99	19	<b>65T36192BGBW</b>	Bridge Solid Wood Base Kit for 54/60"d x 192"w Top Surfaces	<b>\$3,608</b>
36	162	27 $\frac{7}{8}$	116	23	<b>65T36198BGBW</b>	Bridge Solid Wood Base Kit for 54/60"d x 198"w Top Surfaces	<b>\$3,734</b>
36	168	27 $\frac{7}{8}$	116	23	<b>65T36204BGBW</b>	Bridge Solid Wood Base Kit for 54/60"d x 204"w Top Surfaces	<b>\$3,860</b>
36	174	27 $\frac{7}{8}$	116	23	<b>65T36210BGBW</b>	Bridge Solid Wood Base Kit for 54/60"d x 210"w Top Surfaces	<b>\$3,986</b>
36	180	27 $\frac{7}{8}$	118	24	<b>65T36216BGBW</b>	Bridge Solid Wood Base Kit for 54/60"d x 216"w Top Surfaces	<b>\$4,112</b>
36	186	27 $\frac{7}{8}$	118	24	<b>65T36222BGBW</b>	Bridge Solid Wood Base Kit for 54/60"d x 222"w Top Surfaces	<b>\$4,238</b>
36	192	27 $\frac{7}{8}$	120	24	<b>65T36228BGBW</b>	Bridge Solid Wood Base Kit for 54/60"d x 228"w Top Surfaces	<b>\$4,364</b>
36	198	27 $\frac{7}{8}$	120	24	<b>65T36234BGBW</b>	Bridge Solid Wood Base Kit for 54/60"d x 234"w Top Surfaces	<b>\$4,490</b>
36	204	27 $\frac{7}{8}$	120	42	<b>65T36240BGBW</b>	Bridge Solid Wood Base Kit for 54/60"d x 240"w Top Surfaces	<b>\$4,615</b>

**Model Base Wood**

[see Anthology Solid Wood Finishes](#)

**Bevel Base Kit**

- available in Maple, Oak and Walnut solid wood
- top shapes: Rectangular, Soft Rectangular, Arc Rectangular, Boat, Arc Boat and Racetrack
- planning base specification [ANPG\\_7](#)
- planning base location [ANPG\\_18](#)
- planning power guide [ANPG\\_20- ANPG\\_40](#)

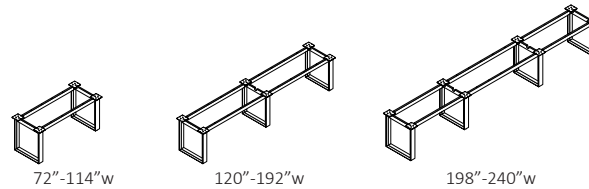

D	W	H	CTN WT	CU FT	Model	Description	List Price
<b>Bevel Base Kit for 36"deep Table</b>							
18	48	27 $\frac{7}{8}$	54	7	<b>65T1872BVBW</b>	Bevel Solid Wood Base Kit for 36"d x 72"w Top Surfaces	<b>\$2,244</b>
18	54	27 $\frac{7}{8}$	54	7	<b>65T1878BVBW</b>	Bevel Solid Wood Base Kit for 36"d x 78"w Top Surfaces	<b>\$2,250</b>
18	54	27 $\frac{7}{8}$	54	7	<b>65T1884BVBW</b>	Bevel Solid Wood Base Kit for 36"d x 84"w Top Surfaces	<b>\$2,256</b>
18	60	27 $\frac{7}{8}$	55	7	<b>65T1890BVBW</b>	Bevel Solid Wood Base Kit for 36"d x 90"w Top Surfaces	<b>\$2,262</b>
18	60	27 $\frac{7}{8}$	55	7	<b>65T1896BVBW</b>	Bevel Solid Wood Base Kit for 36"d x 96"w Top Surfaces	<b>\$2,268</b>
<b>Bevel Base Kit for 42/48"deep Table</b>							
24	48	27 $\frac{7}{8}$	56	9	<b>65T2472BVBW</b>	Bevel Solid Wood Base Kit for 42/48"d x 72"w Top Surfaces	<b>\$2,244</b>
24	54	27 $\frac{7}{8}$	56	9	<b>65T2478BVBW</b>	Bevel Solid Wood Base Kit for 42/48"d x 78"w Top Surfaces	<b>\$2,250</b>
24	54	27 $\frac{7}{8}$	56	9	<b>65T2484BVBW</b>	Bevel Solid Wood Base Kit for 42/48"d x 84"w Top Surfaces	<b>\$2,256</b>
24	60	27 $\frac{7}{8}$	56	9	<b>65T2490BVBW</b>	Bevel Solid Wood Base Kit for 42/48"d x 90"w Top Surfaces	<b>\$2,262</b>
24	60	27 $\frac{7}{8}$	57	10	<b>65T2496BVBW</b>	Bevel Solid Wood Base Kit for 42/48"d x 96"w Top Surfaces	<b>\$2,268</b>
24	66	27 $\frac{7}{8}$	57	10	<b>65T24102BVBW</b>	Bevel Solid Wood Base Kit for 42/48"d x 102"w Top Surfaces	<b>\$2,512</b>
24	72	27 $\frac{7}{8}$	57	10	<b>65T24108BVBW</b>	Bevel Solid Wood Base Kit for 42/48"d x 108"w Top Surfaces	<b>\$2,756</b>
24	78	27 $\frac{7}{8}$	57	10	<b>65T24114BVBW</b>	Bevel Solid Wood Base Kit for 42/48"d x 114"w Top Surfaces	<b>\$3,000</b>
24	84	27 $\frac{7}{8}$	77	15	<b>65T24120BVBW</b>	Bevel Solid Wood Base Kit for 42/48"d x 120"w Top Surfaces	<b>\$3,450</b>
<b>Bevel Base Kit for 48"deep Table</b>							
24	90	27 $\frac{7}{8}$	77	15	<b>65T24126BVBW</b>	Bevel Solid Wood Base Kit for 48"d x 126"w Top Surfaces	<b>\$3,494</b>
24	96	27 $\frac{7}{8}$	77	15	<b>65T24132BVBW</b>	Bevel Solid Wood Base Kit for 48"d x 132"w Top Surfaces	<b>\$3,500</b>
24	102	27 $\frac{7}{8}$	77	15	<b>65T24138BVBW</b>	Bevel Solid Wood Base Kit for 48"d x 138"w Top Surfaces	<b>\$3,506</b>
24	108	27 $\frac{7}{8}$	78	15	<b>65T24144BVBW</b>	Bevel Solid Wood Base Kit for 48"d x 144"w Top Surfaces	<b>\$3,513</b>
24	114	27 $\frac{7}{8}$	78	15	<b>65T24150BVBW</b>	Bevel Solid Wood Base Kit for 48"d x 150"w Top Surfaces	<b>\$3,519</b>
24	120	27 $\frac{7}{8}$	78	15	<b>65T24156BVBW</b>	Bevel Solid Wood Base Kit for 48"d x 156"w Top Surfaces	<b>\$3,525</b>
24	126	27 $\frac{7}{8}$	78	15	<b>65T24162BVBW</b>	Bevel Solid Wood Base Kit for 48"d x 162"w Top Surfaces	<b>\$3,531</b>
24	132	27 $\frac{7}{8}$	79	15	<b>65T24168BVBW</b>	Bevel Solid Wood Base Kit for 48"d x 168"w Top Surfaces	<b>\$3,537</b>
24	138	27 $\frac{7}{8}$	79	15	<b>65T24174BVBW</b>	Bevel Solid Wood Base Kit for 48"d x 174"w Top Surfaces	<b>\$3,543</b>
24	144	27 $\frac{7}{8}$	79	15	<b>65T24180BVBW</b>	Bevel Solid Wood Base Kit for 48"d x 180"w Top Surfaces	<b>\$3,549</b>
24	150	27 $\frac{7}{8}$	80	15	<b>65T24186BVBW</b>	Bevel Solid Wood Base Kit for 48"d x 186"w Top Surfaces	<b>\$3,555</b>
24	156	27 $\frac{7}{8}$	80	15	<b>65T24192BVBW</b>	Bevel Solid Wood Base Kit for 48"d x 192"w Top Surfaces	<b>\$3,562</b>
24	162	27 $\frac{7}{8}$	101	19	<b>65T24198BVBW</b>	Bevel Solid Wood Base Kit for 48"d x 198"w Top Surfaces	<b>\$3,686</b>
24	168	27 $\frac{7}{8}$	101	19	<b>65T24204BVBW</b>	Bevel Solid Wood Base Kit for 48"d x 204"w Top Surfaces	<b>\$3,810</b>
24	174	27 $\frac{7}{8}$	102	19	<b>65T24210BVBW</b>	Bevel Solid Wood Base Kit for 48"d x 210"w Top Surfaces	<b>\$3,934</b>
24	180	27 $\frac{7}{8}$	102	20	<b>65T24216BVBW</b>	Bevel Solid Wood Base Kit for 48"d x 216"w Top Surfaces	<b>\$4,058</b>
24	186	27 $\frac{7}{8}$	105	20	<b>65T24222BVBW</b>	Bevel Solid Wood Base Kit for 48"d x 222"w Top Surfaces	<b>\$4,182</b>
24	192	27 $\frac{7}{8}$	105	20	<b>65T24228BVBW</b>	Bevel Solid Wood Base Kit for 48"d x 228"w Top Surfaces	<b>\$4,306</b>
24	198	27 $\frac{7}{8}$	107	20	<b>65T24234BVBW</b>	Bevel Solid Wood Base Kit for 48"d x 234"w Top Surfaces	<b>\$4,430</b>
24	204	27 $\frac{7}{8}$	107	20	<b>65T24240BVBW</b>	Bevel Solid Wood Base Kit for 48"d x 240"w Top Surfaces	<b>\$4,554</b>

**Model Base Wood**

[see Anthology Solid Wood Finishes](#)

**Bevel Base Kit**

- available in Maple, Oak and Walnut solid wood
- top shapes: Rectangular, Soft Rectangular, Arc Rectangular, Boat, Arc Boat and Racetrack
- planning base specification [ANPG\\_7](#)
- planning base location [ANPG\\_18](#)
- planning power guide [ANPG\\_20- ANPG\\_40](#)

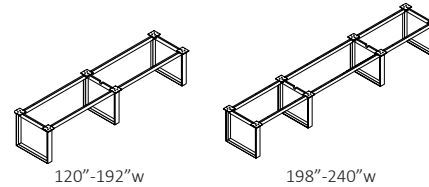

D	W	H	CTN WT	CU FT	Model	Description	List Price
<b>Bevel Base Kit for 54/60"deep Table</b>							
30	84	27 $\frac{7}{8}$	93	19	<b>65T30120BVBW</b>	Bevel Solid Wood Base Kit for 54/60"d x 120"w Top Surfaces	<b>\$3,607</b>
30	90	27 $\frac{7}{8}$	93	19	<b>65T30126BVBW</b>	Bevel Solid Wood Base Kit for 54/60"d x 126"w Top Surfaces	<b>\$3,612</b>
30	96	27 $\frac{7}{8}$	94	19	<b>65T30132BVBW</b>	Bevel Solid Wood Base Kit for 54/60"d x 132"w Top Surfaces	<b>\$3,617</b>
30	102	27 $\frac{7}{8}$	94	19	<b>65T30138BVBW</b>	Bevel Solid Wood Base Kit for 54/60"d x 138"w Top Surfaces	<b>\$3,622</b>
30	108	27 $\frac{7}{8}$	95	19	<b>65T30144BVBW</b>	Bevel Solid Wood Base Kit for 54/60"d x 144"w Top Surfaces	<b>\$3,631</b>
30	114	27 $\frac{7}{8}$	95	19	<b>65T30150BVBW</b>	Bevel Solid Wood Base Kit for 54/60"d x 150"w Top Surfaces	<b>\$3,637</b>
30	120	27 $\frac{7}{8}$	95	19	<b>65T30156BVBW</b>	Bevel Solid Wood Base Kit for 54/60"d x 156"w Top Surfaces	<b>\$3,643</b>
30	126	27 $\frac{7}{8}$	97	19	<b>65T30162BVBW</b>	Bevel Solid Wood Base Kit for 54/60"d x 162"w Top Surfaces	<b>\$3,649</b>
30	132	27 $\frac{7}{8}$	97	19	<b>65T30168BVBW</b>	Bevel Solid Wood Base Kit for 54/60"d x 168"w Top Surfaces	<b>\$3,655</b>
30	138	27 $\frac{7}{8}$	97	19	<b>65T30174BVBW</b>	Bevel Solid Wood Base Kit for 54/60"d x 174"w Top Surfaces	<b>\$3,662</b>
30	144	27 $\frac{7}{8}$	99	19	<b>65T30180BVBW</b>	Bevel Solid Wood Base Kit for 54/60"d x 180"w Top Surfaces	<b>\$3,668</b>
30	150	27 $\frac{7}{8}$	99	19	<b>65T30186BVBW</b>	Bevel Solid Wood Base Kit for 54/60"d x 186"w Top Surfaces	<b>\$3,674</b>
30	156	27 $\frac{7}{8}$	99	19	<b>65T30192BVBW</b>	Bevel Solid Wood Base Kit for 54/60"d x 192"w Top Surfaces	<b>\$3,681</b>
30	162	27 $\frac{7}{8}$	116	23	<b>65T30198BVBW</b>	Bevel Solid Wood Base Kit for 54/60"d x 198"w Top Surfaces	<b>\$3,810</b>
30	168	27 $\frac{7}{8}$	116	23	<b>65T30204BVBW</b>	Bevel Solid Wood Base Kit for 54/60"d x 204"w Top Surfaces	<b>\$3,939</b>
30	174	27 $\frac{7}{8}$	116	23	<b>65T30210BVBW</b>	Bevel Solid Wood Base Kit for 54/60"d x 210"w Top Surfaces	<b>\$4,068</b>
30	180	27 $\frac{7}{8}$	118	24	<b>65T30216BVBW</b>	Bevel Solid Wood Base Kit for 54/60"d x 216"w Top Surfaces	<b>\$4,197</b>
30	186	27 $\frac{7}{8}$	118	24	<b>65T30222BVBW</b>	Bevel Solid Wood Base Kit for 54/60"d x 222"w Top Surfaces	<b>\$4,326</b>
30	192	27 $\frac{7}{8}$	120	24	<b>65T30228BVBW</b>	Bevel Solid Wood Base Kit for 54/60"d x 228"w Top Surfaces	<b>\$4,455</b>
30	198	27 $\frac{7}{8}$	120	24	<b>65T30234BVBW</b>	Bevel Solid Wood Base Kit for 54/60"d x 234"w Top Surfaces	<b>\$4,584</b>
30	204	27 $\frac{7}{8}$	120	42	<b>65T30240BVBW</b>	Bevel Solid Wood Base Kit for 54/60"d x 240"w Top Surfaces	<b>\$4,712</b>

**Model** | **Base Wood**

[see Anthology Solid Wood Finishes](#)

**Frame Base Kit**

- available in metal powdercoat paint and chrome finishes
- top shapes: Rectangular, Soft Rectangular, Arc Rectangular, Boat, Arc Boat and Racetrack
- planning base specification [ANPG\\_11](#)
- planning base location [ANPG\\_18](#)
- planning power guide [ANPG\\_20- ANPG\\_40](#)
- magnetic wire manager [page 58](#)

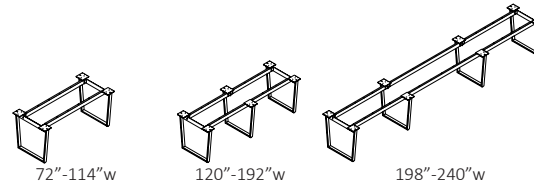

D	W	H	CTN WT	CU FT	Model	Description	List Price
<b>Frame Base Kit for 36"deep Table</b>							
22 7/8	48	27 7/8	70	11	<b>65T1872FRBM</b>	Frame Metal Base Kit for 36"d x 72"w Top Surfaces	<b>\$1,323</b>
22 7/8	54	27 7/8	71	11	<b>65T1878FRBM</b>	Frame Metal Base Kit for 36"d x 78"w Top Surfaces	<b>\$1,329</b>
22 7/8	54	27 7/8	71	11	<b>65T1884FRBM</b>	Frame Metal Base Kit for 36"d x 84"w Top Surfaces	<b>\$1,335</b>
22 7/8	60	27 7/8	72	11	<b>65T1890FRBM</b>	Frame Metal Base Kit for 36"d x 90"w Top Surfaces	<b>\$1,341</b>
22 7/8	60	27 7/8	72	11	<b>65T1896FRBM</b>	Frame Metal Base Kit for 36"d x 96"w Top Surfaces	<b>\$1,347</b>
<b>Frame Base Kit for 42/48"deep Table</b>							
28 7/8	48	27 7/8	75	11	<b>65T2472FRBM</b>	Frame Metal Base Kit for 42/48"d x 72"w Top Surfaces	<b>\$1,353</b>
28 7/8	54	27 7/8	76	11	<b>65T2478FRBM</b>	Frame Metal Base Kit for 42/48"d x 78"w Top Surfaces	<b>\$1,359</b>
28 7/8	54	27 7/8	76	11	<b>65T2484FRBM</b>	Frame Metal Base Kit for 42/48"d x 84"w Top Surfaces	<b>\$1,365</b>
28 7/8	60	27 7/8	77	11	<b>65T2490FRBM</b>	Frame Metal Base Kit for 42/48"d x 90"w Top Surfaces	<b>\$1,370</b>
28 7/8	60	27 7/8	77	11	<b>65T2496FRBM</b>	Frame Metal Base Kit for 42/48"d x 96"w Top Surfaces	<b>\$1,370</b>
28 7/8	66	27 7/8	78	11	<b>65T24102FRBM</b>	Frame Metal Base Kit for 42/48"d x 102"w Top Surfaces	<b>\$1,597</b>
28 7/8	72	27 7/8	79	12	<b>65T24108FRBM</b>	Frame Metal Base Kit for 42/48"d x 108"w Top SurfacesL	<b>\$1,824</b>
28 7/8	78	27 7/8	80	12	<b>65T24114FRBM</b>	Frame Metal Base Kit for 42/48"d x 114"w Top Surfaces	<b>\$2,051</b>
28 7/8	84	27 7/8	110	19	<b>65T24120FRBM</b>	Frame Metal Base Kit for 42/48"d x 120"w Top Surfaces	<b>\$2,281</b>
<b>Frame Base Kit for 48"deep Table</b>							
28 7/8	90	27 7/8	111	19	<b>65T24126FRBM</b>	Frame Metal Base Kit for 48"d x 126"w Top Surfaces	<b>\$2,285</b>
28 7/8	96	27 7/8	112	19	<b>65T24132FRBM</b>	Frame Metal Base Kit for 48"d x 132"w Top Surfaces	<b>\$2,289</b>
28 7/8	102	27 7/8	113	19	<b>65T24138FRBM</b>	Frame Metal Base Kit for 48"d x 138"w Top Surfaces	<b>\$2,293</b>
28 7/8	108	27 7/8	114	19	<b>65T24144FRBM</b>	Frame Metal Base Kit for 48"d x 144"w Top Surfaces	<b>\$2,297</b>
28 7/8	114	27 7/8	116	20	<b>65T24150FRBM</b>	Frame Metal Base Kit for 48"d x 150"w Top SurfacesL	<b>\$2,310</b>
28 7/8	120	27 7/8	117	20	<b>65T24156FRBM</b>	Frame Metal Base Kit for 48"d x 156"w Top Surfaces	<b>\$2,323</b>
28 7/8	126	27 7/8	118	20	<b>65T24162FRBM</b>	Frame Metal Base Kit for 48"d x 162"w Top Surfaces	<b>\$2,336</b>
28 7/8	132	27 7/8	119	20	<b>65T24168FRBM</b>	Frame Metal Base Kit for 48"d x 168"w Top Surfaces	<b>\$2,349</b>
28 7/8	138	27 7/8	120	20	<b>65T24174FRBM</b>	Frame Metal Base Kit for 48"d x 174"w Top Surfaces	<b>\$2,360</b>
28 7/8	144	27 7/8	121	20	<b>65T24180FRBM</b>	Frame Metal Base Kit for 48"d x 180"w Top Surfaces	<b>\$2,371</b>
28 7/8	150	27 7/8	122	20	<b>65T24186FRBM</b>	Frame Metal Base Kit for 48"d x 186"w Top Surfaces	<b>\$2,382</b>
28 7/8	156	27 7/8	123	20	<b>65T24192FRBM</b>	Frame Metal Base Kit for 48"d x 192"w Top Surfaces	<b>\$2,393</b>
28 7/8	162	27 7/8	153	26	<b>65T24198FRBM</b>	Frame Metal Base Kit for 48"d x 198"w Top Surfaces	<b>\$2,488</b>
28 7/8	168	27 7/8	154	26	<b>65T24204FRBM</b>	Frame Metal Base Kit for 48"d x 204"w Top Surfaces	<b>\$2,583</b>
28 7/8	174	27 7/8	155	26	<b>65T24210FRBM</b>	Frame Metal Base Kit for 48"d x 210"w Top Surfaces	<b>\$2,678</b>
28 7/8	180	27 7/8	156	26	<b>65T24216FRBM</b>	Frame Metal Base Kit for 48"d x 216"w Top Surfaces	<b>\$2,773</b>
28 7/8	186	27 7/8	158	27	<b>65T24222FRBM</b>	Frame Metal Base Kit for 48"d x 222"w Top Surfaces	<b>\$2,868</b>
28 7/8	192	27 7/8	159	27	<b>65T24228FRBM</b>	Frame Metal Base Kit for 48"d x 228"w Top Surfaces	<b>\$2,963</b>
28 7/8	198	27 7/8	160	27	<b>65T24234FRBM</b>	Frame Metal Base Kit for 48"d x 234"w Top Surfaces	<b>\$3,058</b>
28 7/8	204	27 7/8	161	27	<b>65T24240FRBM</b>	Frame Metal Base Kit for 48"d x 240"w Top Surfaces	<b>\$3,155</b>

**Model Metal Finish**

[see Anthology Metal Finishes](#)

**Chrome Metal Base Upcharge**  
 2 bases 72" - 114" - add \$1,880  
 3 bases 120" - 192" - add \$2,820  
 4 bases 198" - 240" - add \$3,760



**Frame Base Kit**

- available in metal powdercoat paint and chrome finishes
- top shapes: Rectangular, Soft Rectangular, Arc Rectangular, Boat, Arc Boat and Racetrack
- planning base specification [ANPG\\_11](#)
- planning base location [ANPG\\_18](#)
- planning power guide [ANPG\\_20- ANPG\\_40](#)
- magnetic wire manager [page 58](#)

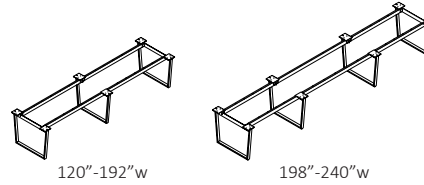

D	W	H	CTN WT	CU FT	① Model	Description	List Price
<b>Frame Base Kit for 54/60"deep Table</b>							
34 $\frac{7}{8}$	84	27 $\frac{7}{8}$	115	22	<b>65T30120FRBM</b>	Frame Metal Base Kit for 54/60"d x 120"w Top Surfaces	<b>\$2,386</b>
34 $\frac{7}{8}$	90	27 $\frac{7}{8}$	116	23	<b>65T30126FRBM</b>	Frame Metal Base Kit for 54/60"d x 126"w Top Surfaces	<b>\$2,390</b>
34 $\frac{7}{8}$	96	27 $\frac{7}{8}$	117	23	<b>65T30132FRBM</b>	Frame Metal Base Kit for 54/60"d x 132"w Top Surfaces	<b>\$2,394</b>
34 $\frac{7}{8}$	102	27 $\frac{7}{8}$	119	23	<b>65T30138FRBM</b>	Frame Metal Base Kit for 54/60"d x 138"w Top Surfaces	<b>\$2,398</b>
34 $\frac{7}{8}$	108	27 $\frac{7}{8}$	120	23	<b>65T30144FRBM</b>	Frame Metal Base Kit for 54/60"d x 144"w Top Surfaces	<b>\$2,402</b>
34 $\frac{7}{8}$	114	27 $\frac{7}{8}$	121	23	<b>65T30150FRBM</b>	Frame Metal Base Kit for 54/60"d x 150"w Top Surfaces	<b>\$2,414</b>
34 $\frac{7}{8}$	120	27 $\frac{7}{8}$	122	23	<b>65T30156FRBM</b>	Frame Metal Base Kit for 54/60"d x 156"w Top Surfaces	<b>\$2,426</b>
34 $\frac{7}{8}$	126	27 $\frac{7}{8}$	123	23	<b>65T30162FRBM</b>	Frame Metal Base Kit for 54/60"d x 162"w Top Surfaces	<b>\$2,438</b>
34 $\frac{7}{8}$	132	27 $\frac{7}{8}$	124	23	<b>65T30168FRBM</b>	Frame Metal Base Kit for 54/60"d x 168"w Top Surfaces	<b>\$2,450</b>
34 $\frac{7}{8}$	138	27 $\frac{7}{8}$	125	23	<b>65T30174FRBM</b>	Frame Metal Base Kit for 54/60"d x 174"w Top Surfaces	<b>\$2,462</b>
34 $\frac{7}{8}$	144	27 $\frac{7}{8}$	126	23	<b>65T30180FRBM</b>	Frame Metal Base Kit for 54/60"d x 180"w Top Surfaces	<b>\$2,474</b>
34 $\frac{7}{8}$	150	27 $\frac{7}{8}$	127	24	<b>65T30186FRBM</b>	Frame Metal Base Kit for 54/60"d x 186"w Top Surfaces	<b>\$2,486</b>
34 $\frac{7}{8}$	156	27 $\frac{7}{8}$	129	24	<b>65T30192FRBM</b>	Frame Metal Base Kit for 54/60"d x 192"w Top Surfaces	<b>\$2,498</b>
34 $\frac{7}{8}$	162	27 $\frac{7}{8}$	160	31	<b>65T30198FRBM</b>	Frame Metal Base Kit for 54/60"d x 198"w Top Surfaces	<b>\$2,584</b>
34 $\frac{7}{8}$	168	27 $\frac{7}{8}$	161	31	<b>65T30204FRBM</b>	Frame Metal Base Kit for 54/60"d x 204"w Top Surfaces	<b>\$2,670</b>
34 $\frac{7}{8}$	174	27 $\frac{7}{8}$	162	31	<b>65T30210FRBM</b>	Frame Metal Base Kit for 54/60"d x 210"w Top Surfaces	<b>\$2,756</b>
34 $\frac{7}{8}$	180	27 $\frac{7}{8}$	164	31	<b>65T30216FRBM</b>	Frame Metal Base Kit for 54/60"d x 216"w Top Surfaces	<b>\$2,842</b>
34 $\frac{7}{8}$	186	27 $\frac{7}{8}$	165	31	<b>65T30222FRBM</b>	Frame Metal Base Kit for 54/60"d x 222"w Top Surfaces	<b>\$2,928</b>
34 $\frac{7}{8}$	192	27 $\frac{7}{8}$	166	31	<b>65T30228FRBM</b>	Frame Metal Base Kit for 54/60"d x 228"w Top Surfaces	<b>\$3,014</b>
34 $\frac{7}{8}$	198	27 $\frac{7}{8}$	167	31	<b>65T30234FRBM</b>	Frame Metal Base Kit for 54/60"d x 234"w Top Surfaces	<b>\$3,100</b>
34 $\frac{7}{8}$	204	27 $\frac{7}{8}$	168	31	<b>65T30240FRBM</b>	Frame Metal Base Kit for 54/60"d x 240"w Top Surfaces	<b>\$3,185</b>

Model	Metal Finish
	<a href="#">see Anthology Metal Finishes</a>  <b>Chrome Metal Base Upcharge</b> 2 bases 72" - 114" - add \$1,880 3 bases 120" - 192" - add \$2,820 4 bases 198" - 240" - add \$3,760



**Frame BridgeLine Base Kit**

- available in metal powdercoat paint and chrome finishes
- top shapes: Rectangular, Soft Rectangular, Arc Rectangular, Boat, Arc Boat and Racetrack
- planning base specification [ANPG\\_12](#)
- planning base location [ANPG\\_18](#)
- planning power guide [ANPG\\_20- ANPG\\_40](#)
- magnetic wire manager [page 58](#)

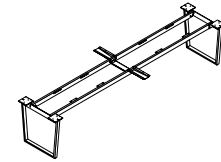

120"-192" w

D	W	H	CTN WT	CU FT	Model	Description	List Price
<b>Frame BridgeLine Base Kit for 48"deep Table</b>							
22	84	27½	106	15	<b>65T24120FR2BM</b>	Frame BridgeLine Base Kit for 48"d x 120"w Top Surfaces	<b>\$2,077</b>
23	90	27½	109	15	<b>65T24126FR2BM</b>	Frame BridgeLine Base Kit for 48"d x 126"w Top Surfaces	<b>\$2,083</b>
24	96	27½	111	16	<b>65T24132FR2BM</b>	Frame BridgeLine Base Kit for 48"d x 132"w Top Surfaces	<b>\$2,089</b>
25	102	27½	114	16	<b>65T24138FR2BM</b>	Frame BridgeLine Base Kit for 48"d x 138"w Top Surfaces	<b>\$2,095</b>
26	108	27½	116	16	<b>65T24144FR2BM</b>	Frame BridgeLine Base Kit for 48"d x 144"w Top Surfaces	<b>\$2,101</b>
27	114	27½	118	16	<b>65T24150FR2BM</b>	Frame BridgeLine Base Kit for 48"d x 150"w Top Surfaces	<b>\$2,107</b>
28	120	27½	121	16	<b>65T24156FR2BM</b>	Frame BridgeLine Base Kit for 48"d x 156"w Top Surfaces	<b>\$2,113</b>
29	126	27½	124	16	<b>65T24162FR2BM</b>	Frame BridgeLine Base Kit for 48"d x 162"w Top Surfaces	<b>\$2,119</b>
30	132	27½	127	17	<b>65T24168FR2BM</b>	Frame BridgeLine Base Kit for 48"d x 168"w Top Surfaces	<b>\$2,125</b>
31	138	27½	129	17	<b>65T24174FR2BM</b>	Frame BridgeLine Base Kit for 48"d x 174"w Top Surfaces	<b>\$2,131</b>
32	144	27½	132	17	<b>65T24180FR2BM</b>	Frame BridgeLine Base Kit for 48"d x 180"w Top Surfaces	<b>\$2,137</b>
33	150	27½	134	17	<b>65T24186FR2BM</b>	Frame BridgeLine Base Kit for 48"d x 186"w Top Surfaces	<b>\$2,143</b>
34	156	27½	137	17	<b>65T24192FR2BM</b>	Frame BridgeLine Base Kit for 48"d x 192"w Top Surfaces	<b>\$2,149</b>
<b>Frame BridgeLine Base Kit for 54/60"deep Table</b>							
35	84	27½	110	17	<b>65T30120FR2BM</b>	Frame BridgeLine Base Kit for 54/60"d x 120"w Top Surfaces	<b>\$2,080</b>
36	90	27½	113	18	<b>65T30126FR2BM</b>	Frame BridgeLine Base Kit for 54/60"d x 126"w Top Surfaces	<b>\$2,091</b>
37	96	27½	115	18	<b>65T30132FR2BM</b>	Frame BridgeLine Base Kit for 54/60"d x 132"w Top Surfaces	<b>\$2,102</b>
38	102	27½	118	18	<b>65T30138FR2BM</b>	Frame BridgeLine Base Kit for 54/60"d x 138"w Top Surfaces	<b>\$2,112</b>
39	108	27½	120	18	<b>65T30144FR2BM</b>	Frame BridgeLine Base Kit for 54/60"d x 144"w Top Surfaces	<b>\$2,123</b>
40	114	27½	123	18	<b>65T30150FR2BM</b>	Frame BridgeLine Base Kit for 54/60"d x 150"w Top Surfaces	<b>\$2,134</b>
41	120	27½	125	18	<b>65T30156FR2BM</b>	Frame BridgeLine Base Kit for 54/60"d x 156"w Top Surfaces	<b>\$2,145</b>
42	126	27½	129	19	<b>65T30162FR2BM</b>	Frame BridgeLine Base Kit for 54/60"d x 162"w Top Surfaces	<b>\$2,156</b>
43	132	27½	131	19	<b>65T30168FR2BM</b>	Frame BridgeLine Base Kit for 54/60"d x 168"w Top Surfaces	<b>\$2,167</b>
44	138	27½	133	19	<b>65T30174FR2BM</b>	Frame BridgeLine Base Kit for 54/60"d x 174"w Top Surfaces	<b>\$2,178</b>
45	144	27½	136	19	<b>65T30180FR2BM</b>	Frame BridgeLine Base Kit for 54/60"d x 180"w Top Surfaces	<b>\$2,188</b>
46	150	27½	138	19	<b>65T30186FR2BM</b>	Frame BridgeLine Base Kit for 54/60"d x 186"w Top Surfaces	<b>\$2,198</b>
47	156	27½	141	19	<b>65T30192FR2BM</b>	Frame BridgeLine Base Kit for 54/60"d x 192"w Top Surfaces	<b>\$2,208</b>

Model	Metal Finish
	<a href="#">see Anthology Metal Finishes</a> Chrome Metal Base Upcharge 2 bases 120" - 192" - add \$1,880

**Oblique Base Kit**

- available in metal standard and additional powdercoat finishes
- top shapes: Rectangular, Soft Rectangular, Arc Rectangular, Boat, Arc Boat and Racetrack
- planning base specification [ANPG\\_13](#)
- planning base location [ANPG\\_18](#)
- planning power guide [ANPG\\_20- ANPG\\_40](#)

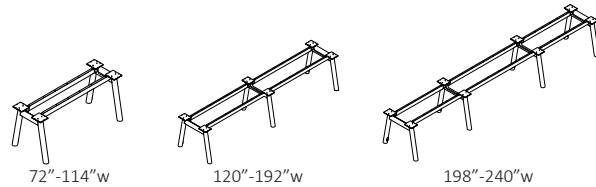

D	W	H	CTN WT	CU FT	Model	Description	List Price
<b>Oblique Base Kit for 36/42"deep Table</b>							
27	48	27½	80	12	<b>65T2472QUBM</b>	Oblique Metal Base Kit for 36/42"d x 72"w Top Surfaces	<b>\$1,440</b>
27	54	27½	81	12	<b>65T2478QUBM</b>	Oblique Metal Base Kit for 36/42"d x 78"w Top Surfaces	<b>\$1,443</b>
27	54	27½	81	12	<b>65T2484QUBM</b>	Oblique Metal Base Kit for 36/42"d x 84"w Top Surfaces	<b>\$1,446</b>
27	60	27½	82	12	<b>65T2490QUBM</b>	Oblique Metal Base Kit for 36/42"d x 90"w Top Surfaces	<b>\$1,448</b>
27	60	27½	82	12	<b>65T2496QUBM</b>	Oblique Metal Base Kit for 36/42"d x 96"w Top Surfaces	<b>\$1,452</b>
<b>Oblique Base Kit for 42"deep Table</b>							
27	66	27½	83	13	<b>65T24102QUBM</b>	Oblique Metal Base Kit for 42"d x 102"w Top Surfaces	<b>\$1,455</b>
27	72	27½	85	13	<b>65T24108QUBM</b>	Oblique Metal Base Kit for 42"d x 108"w Top Surfaces	<b>\$1,458</b>
27	78	27½	86	13	<b>65T24114QUBM</b>	Oblique Metal Base Kit for 42"d x 114"w Top Surfaces	<b>\$1,461</b>
27	84	27½	118	18	<b>65T24120QUBM</b>	Oblique Metal Base Kit for 42"d x 120"w Top Surfaces	<b>\$2,271</b>
<b>Oblique Base Kit for 48"deep Table</b>							
33	48	27½	85	14	<b>65T3072QUBM</b>	Oblique Metal Base Kit for 48"d x 72"w Top Surfaces	<b>\$1,462</b>
33	54	27½	86	15	<b>65T3078QUBM</b>	Oblique Metal Base Kit for 48"d x 78"w Top Surfaces	<b>\$1,465</b>
33	54	27½	86	15	<b>65T3084QUBM</b>	Oblique Metal Base Kit for 48"d x 84"w Top Surfaces	<b>\$1,468</b>
33	60	27½	87	15	<b>65T3090QUBM</b>	Oblique Metal Base Kit for 48"d x 90"w Top Surfaces	<b>\$1,470</b>
33	60	27½	87	15	<b>65T3096QUBM</b>	Oblique Metal Base Kit for 48"d x 96"w Top Surfaces	<b>\$1,472</b>
33	66	27½	88	15	<b>65T30102QUBM</b>	Oblique Metal Base Kit for 48"d x 102"w Top Surfaces	<b>\$1,475</b>
33	72	27½	89	15	<b>65T30108QUBM</b>	Oblique Metal Base Kit for 48"d x 108"w Top Surfaces	<b>\$1,478</b>
33	78	27½	90	15	<b>65T30114QUBM</b>	Oblique Metal Base Kit for 48"d x 114"w Top Surfaces	<b>\$1,481</b>
33	84	27½	125	21	<b>65T30120QUBM</b>	Oblique Metal Base Kit for 48"d x 120"w Top Surfaces	<b>\$2,292</b>
33	90	27½	126	21	<b>65T30126QUBM</b>	Oblique Metal Base Kit for 48"d x 126"w Top Surfaces	<b>\$2,296</b>
33	96	27½	127	21	<b>65T30132QUBM</b>	Oblique Metal Base Kit for 48"d x 132"w Top Surfaces	<b>\$2,299</b>
33	102	27½	129	21	<b>65T30138QUBM</b>	Oblique Metal Base Kit for 48"d x 138"w Top Surfaces	<b>\$2,303</b>
33	108	27½	130	21	<b>65T30144QUBM</b>	Oblique Metal Base Kit for 48"d x 144"w Top Surfaces	<b>\$2,306</b>
33	114	27½	131	22	<b>65T30150QUBM</b>	Oblique Metal Base Kit for 48"d x 150"w Top Surfaces	<b>\$2,322</b>
33	120	27½	132	22	<b>65T30156QUBM</b>	Oblique Metal Base Kit for 48"d x 156"w Top Surfaces	<b>\$2,337</b>
33	126	27½	133	22	<b>65T30162QUBM</b>	Oblique Metal Base Kit for 48"d x 162"w Top Surfaces	<b>\$2,353</b>
33	132	27½	134	22	<b>65T30168QUBM</b>	Oblique Metal Base Kit for 48"d x 168"w Top Surfaces	<b>\$2,369</b>
33	138	27½	135	22	<b>65T30174QUBM</b>	Oblique Metal Base Kit for 48"d x 174"w Top Surfaces	<b>\$2,384</b>
33	144	27½	136	22	<b>65T30180QUBM</b>	Oblique Metal Base Kit for 48"d x 180"w Top Surfaces	<b>\$2,400</b>
33	150	27½	137	22	<b>65T30186QUBM</b>	Oblique Metal Base Kit for 48"d x 186"w Top Surfaces	<b>\$2,415</b>
33	156	27½	139	22	<b>65T30192QUBM</b>	Oblique Metal Base Kit for 48"d x 192"w Top Surfaces	<b>\$2,431</b>
33	162	27½	173	28	<b>65T30198QUBM</b>	Oblique Metal Base Kit for 48"d x 198"w Top Surfaces	<b>\$3,162</b>
33	168	27½	175	28	<b>65T30204QUBM</b>	Oblique Metal Base Kit for 48"d x 204"w Top Surfaces	<b>\$3,166</b>
33	174	27½	176	29	<b>65T30210QUBM</b>	Oblique Metal Base Kit for 48"d x 210"w Top Surfaces	<b>\$3,170</b>
33	180	27½	177	29	<b>65T30216QUBM</b>	Oblique Metal Base Kit for 48"d x 216"w Top Surfaces	<b>\$3,178</b>
33	186	27½	178	29	<b>65T30222QUBM</b>	Oblique Metal Base Kit for 48"d x 222"w Top Surfaces	<b>\$3,182</b>
33	192	27½	179	29	<b>65T30228QUBM</b>	Oblique Metal Base Kit for 48"d x 228"w Top Surfaces	<b>\$3,186</b>
33	198	27½	180	29	<b>65T30234QUBM</b>	Oblique Metal Base Kit for 48"d x 234"w Top Surfaces	<b>\$3,190</b>
33	204	27½	181	29	<b>65T30240QUBM</b>	Oblique Metal Base Kit for 48"d x 240"w Top Surfaces	<b>\$3,194</b>

Model	Metal Frame
	<p><b>Standard Metal Frame Colors</b>  <a href="#">see Anthology Standard Metal Frame Colors</a></p> <p><b>Additional Metal Frame Colors</b>  <a href="#">see Anthology Additional Metal Frame Colors</a></p> <p><b>Chrome Metal Base Upcharge</b>                      2 bases 72" - 114" - add \$184                      3 bases 120" - 192" - add \$272                      4 bases 198" - 240" - add \$363</p>

**Oblique Base Kit**

- available in metal standard and additional powdercoat finishes
- top shapes: Rectangular, Soft Rectangular, Arc Rectangular, Boat, Arc Boat and Racetrack
- planning base specification [ANPG\\_13](#)
- planning base location [ANPG\\_18](#)
- planning power guide [ANPG\\_20- ANPG\\_40](#)

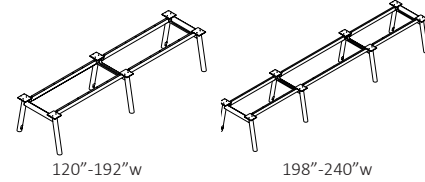

D	W	H	CTN WT	CU FT	Model	Description	List Price
<b>Oblique Base Kit for 54/60"deep Table</b>							
39	84	27 $\frac{7}{8}$	132	24	<b>65T36120QUBM</b>	Oblique Metal Base Kit for 54/60"d x 120"w Top Surfaces	<b>\$2,378</b>
39	90	27 $\frac{7}{8}$	133	24	<b>65T36126QUBM</b>	Oblique Metal Base Kit for 54/60"d x 126"w Top Surfaces	<b>\$2,382</b>
39	96	27 $\frac{7}{8}$	134	24	<b>65T36132QUBM</b>	Oblique Metal Base Kit for 54/60"d x 132"w Top Surfaces	<b>\$2,386</b>
39	102	27 $\frac{7}{8}$	136	25	<b>65T36138QUBM</b>	Oblique Metal Base Kit for 54/60"d x 138"w Top Surfaces	<b>\$2,390</b>
39	108	27 $\frac{7}{8}$	137	25	<b>65T36144QUBM</b>	Oblique Metal Base Kit for 54/60"d x 144"w Top Surfaces	<b>\$2,394</b>
39	114	27 $\frac{7}{8}$	138	25	<b>65T36150QUBM</b>	Oblique Metal Base Kit for 54/60"d x 150"w Top Surfaces	<b>\$2,407</b>
39	120	27 $\frac{7}{8}$	139	25	<b>65T36156QUBM</b>	Oblique Metal Base Kit for 54/60"d x 156"w Top Surfaces	<b>\$2,421</b>
39	126	27 $\frac{7}{8}$	140	25	<b>65T36162QUBM</b>	Oblique Metal Base Kit for 54/60"d x 162"w Top Surfaces	<b>\$2,434</b>
39	132	27 $\frac{7}{8}$	141	25	<b>65T36168QUBM</b>	Oblique Metal Base Kit for 54/60"d x 168"w Top Surfaces	<b>\$2,447</b>
39	138	27 $\frac{7}{8}$	142	25	<b>65T36174QUBM</b>	Oblique Metal Base Kit for 54/60"d x 174"w Top Surfaces	<b>\$2,460</b>
39	144	27 $\frac{7}{8}$	143	25	<b>65T36180QUBM</b>	Oblique Metal Base Kit for 54/60"d x 180"w Top Surfaces	<b>\$2,474</b>
39	150	27 $\frac{7}{8}$	145	26	<b>65T36186QUBM</b>	Oblique Metal Base Kit for 54/60"d x 186"w Top Surfaces	<b>\$2,487</b>
39	156	27 $\frac{7}{8}$	146	26	<b>65T36192QUBM</b>	Oblique Metal Base Kit for 54/60"d x 192"w Top Surfaces	<b>\$2,500</b>
39	162	27 $\frac{7}{8}$	183	33	<b>65T36198QUBM</b>	Oblique Metal Base Kit for 54/60"d x 198"w Top Surfaces	<b>\$3,194</b>
39	168	27 $\frac{7}{8}$	184	33	<b>65T36204QUBM</b>	Oblique Metal Base Kit for 54/60"d x 204"w Top Surfaces	<b>\$3,198</b>
39	174	27 $\frac{7}{8}$	185	33	<b>65T36210QUBM</b>	Oblique Metal Base Kit for 54/60"d x 210"w Top Surfaces	<b>\$3,202</b>
39	180	27 $\frac{7}{8}$	186	33	<b>65T36216QUBM</b>	Oblique Metal Base Kit for 54/60"d x 216"w Top Surfaces	<b>\$3,206</b>
39	186	27 $\frac{7}{8}$	187	33	<b>65T36222QUBM</b>	Oblique Metal Base Kit for 54/60"d x 222"w Top Surfaces	<b>\$3,210</b>
39	192	27 $\frac{7}{8}$	188	33	<b>65T36228QUBM</b>	Oblique Metal Base Kit for 54/60"d x 228"w Top Surfaces	<b>\$3,214</b>
39	198	27 $\frac{7}{8}$	190	33	<b>65T36234QUBM</b>	Oblique Metal Base Kit for 54/60"d x 234"w Top Surfaces	<b>\$3,218</b>
39	204	27 $\frac{7}{8}$	191	34	<b>65T36240QUBM</b>	Oblique Metal Base Kit for 54/60"d x 240"w Top Surfaces	<b>\$3,222</b>

Model	Metal Frame
	<p><b>Standard Metal Frame Colors</b>  <a href="#">see Anthology Standard Metal Frame Colors</a></p> <p><b>Additional Metal Frame Colors</b>  <a href="#">see Anthology Additional Metal Frame Colors</a></p> <p><b>Chrome Metal Base Upcharge</b>                      2 bases 72" - 114" - add \$184                      3 bases 120" - 192" - add \$272                      4 bases 198" - 240" - add \$363</p>

**Outline Base Kit**

- available in TFL and Veneer surfaces with powdercoat or chrome metal accent trim
- top shapes: Rectangular, Soft Rectangular, Arc Rectangular, Boat, Arc Boat and Racetrack
- planning base specification [ANPG\\_14](#)
- planning base location [ANPG\\_18](#)
- planning power guide [ANPG\\_20- ANPG\\_40](#)

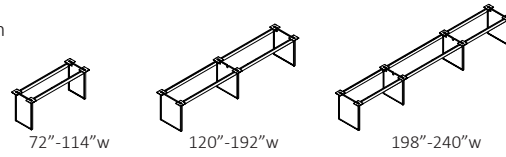

D	W	H	CTN WT	CU FT	① Model	Description	TFL Laminate T	ESS Veneer V	ART Veneer V
<b>Outline Base Kit for 36" deep Table</b>									
18	48	27 7/8	45	10	<b>65T1872ULB_</b>	Outline Metal Base Kit for 36" d x 72" w Top Surfaces	\$1,569	\$2,179	\$2,397
18	54	27 7/8	46	11	<b>65T1878ULB_</b>	Outline Metal Base Kit for 36" d x 78" w Top Surfaces	\$1,584	\$2,190	\$2,409
18	54	27 7/8	46	11	<b>65T1884ULB_</b>	Outline Metal Base Kit for 36" d x 84" w Top Surfaces	\$1,599	\$2,201	\$2,421
18	60	27 7/8	47	11	<b>65T1890ULB_</b>	Outline Metal Base Kit for 36" d x 90" w Top Surfaces	\$1,614	\$2,212	\$2,433
18	54	27 7/8	46	11	<b>65T1896ULB_</b>	Outline Metal Base Kit for 36" d x 96" w Top Surfaces	\$1,629	\$2,223	\$2,445
<b>Outline Base Kit for 42/48" deep Table</b>									
24	48	27 7/8	46	13	<b>65T2472ULB_</b>	Outline Metal Base Kit for 42/48" d x 72" w Top Surfaces	\$1,646	\$2,234	\$2,457
24	54	27 7/8	47	13	<b>65T2478ULB_</b>	Outline Metal Base Kit for 42/48" d x 78" w Top Surfaces	\$1,662	\$2,244	\$2,468
24	54	27 7/8	47	13	<b>65T2484ULB_</b>	Outline Metal Base Kit for 42/48" d x 84" w Top Surfaces	\$1,678	\$2,254	\$2,479
24	60	27 7/8	48	13	<b>65T2490ULB_</b>	Outline Metal Base Kit for 42/48" d x 90" w Top Surfaces	\$1,694	\$2,264	\$2,490
24	60	27 7/8	48	13	<b>65T2496ULB_</b>	Outline Metal Base Kit for 42/48" d x 96" w Top Surfaces	\$1,711	\$2,275	\$2,503
24	66	27 7/8	49	13	<b>65T24102ULB_</b>	Outline Metal Base Kit for 42/48" d x 102" w Top Surfaces	\$2,005	\$2,671	\$2,938
24	72	27 7/8	50	13	<b>65T24108ULB_</b>	Outline Metal Base Kit for 42/48" d x 108" w Top Surfaces	\$2,299	\$3,067	\$3,374
24	78	27 7/8	51	13	<b>65T24114ULB_</b>	Outline Metal Base Kit for 42/48" d x 114" w Top Surfaces	\$2,592	\$3,463	\$3,809
24	84	27 7/8	70	18	<b>65T24120ULB_</b>	Outline Metal Base Kit for 42/48" d x 120" w Top Surfaces	\$2,885	\$3,859	\$4,245
<b>Outline Base Kit for 48" deep Table</b>									
24	90	27 7/8	72	18	<b>65T24126ULB_</b>	Outline Metal Base Kit for 48" d x 126" w Top Surfaces	\$2,894	\$3,870	\$4,257
24	96	27 7/8	73	19	<b>65T24132ULB_</b>	Outline Metal Base Kit for 48" d x 132" w Top Surfaces	\$2,903	\$3,881	\$4,269
24	102	27 7/8	74	19	<b>65T24138ULB_</b>	Outline Metal Base Kit for 48" d x 138" w Top Surfaces	\$2,912	\$3,892	\$4,281
24	108	27 7/8	75	19	<b>65T24144ULB_</b>	Outline Metal Base Kit for 48" d x 144" w Top Surfaces	\$2,922	\$3,903	\$4,293
24	114	27 7/8	76	19	<b>65T24150ULB_</b>	Outline Metal Base Kit for 48" d x 150" w Top Surfaces	\$2,931	\$3,914	\$4,305
24	120	27 7/8	77	19	<b>65T24156ULB_</b>	Outline Metal Base Kit for 48" d x 156" w Top Surfaces	\$2,940	\$3,925	\$4,318
24	126	27 7/8	78	19	<b>65T24162ULB_</b>	Outline Metal Base Kit for 48" d x 162" w Top Surfaces	\$2,949	\$3,936	\$4,330
24	132	27 7/8	79	19	<b>65T24168ULB_</b>	Outline Metal Base Kit for 48" d x 168" w Top Surfaces	\$2,959	\$3,947	\$4,342
24	138	27 7/8	80	19	<b>65T24174ULB_</b>	Outline Metal Base Kit for 48" d x 174" w Top Surfaces	\$2,969	\$3,958	\$4,354
24	144	27 7/8	82	19	<b>65T24180ULB_</b>	Outline Metal Base Kit for 48" d x 180" w Top Surfaces	\$2,978	\$3,969	\$4,366
24	150	27 7/8	83	20	<b>65T24186ULB_</b>	Outline Metal Base Kit for 48" d x 186" w Top Surfaces	\$2,987	\$3,980	\$4,378
24	156	27 7/8	84	20	<b>65T24192ULB_</b>	Outline Metal Base Kit for 48" d x 192" w Top Surfaces	\$2,997	\$3,992	\$4,391
24	162	27 7/8	95	25	<b>65T24198ULB_</b>	Outline Metal Base Kit for 48" d x 198" w Top Surfaces	\$3,117	\$4,169	\$4,586
24	168	27 7/8	96	25	<b>65T24204ULB_</b>	Outline Metal Base Kit for 48" d x 204" w Top Surfaces	\$3,237	\$4,347	\$4,782
24	174	27 7/8	97	25	<b>65T24210ULB_</b>	Outline Metal Base Kit for 48" d x 210" w Top Surfaces	\$3,357	\$4,524	\$4,976
24	180	27 7/8	98	25	<b>65T24216ULB_</b>	Outline Metal Base Kit for 48" d x 216" w Top Surfaces	\$3,477	\$4,701	\$5,171
24	186	27 7/8	99	25	<b>65T24222ULB_</b>	Outline Metal Base Kit for 48" d x 222" w Top Surfaces	\$3,597	\$4,879	\$5,367
24	192	27 7/8	101	25	<b>65T24228ULB_</b>	Outline Metal Base Kit for 48" d x 228" w Top Surfaces	\$3,717	\$5,056	\$5,562
24	198	27 7/8	102	26	<b>65T24234ULB_</b>	Outline Metal Base Kit for 48" d x 234" w Top Surfaces	\$3,837	\$5,233	\$5,756
24	204	27 7/8	103	26	<b>65T24240ULB_</b>	Outline Metal Base Kit for 48" d x 240" w Top Surfaces	\$3,958	\$5,411	\$5,952

Model	Laminate	Veneer	Metal Finish
	<a href="#">see Anthology Laminate Selection</a>	<a href="#">see Anthology Veneer Selection</a>	<a href="#">see Anthology Metal Finishes</a>  <b>Chrome Metal Base Upcharge</b> 2 bases 72" - 114" - add \$1,950 3 bases 120" - 192" - add \$2,925 4 bases 198" - 240" - add \$3,900

**Outline Base Kit**

- available in TFL and Veneer surfaces with powdercoat or chrome metal accent trim
- top shapes: Rectangular, Soft Rectangular, Arc Rectangular, Boat, Arc Boat and Racetrack
- planning base specification [ANPG\\_14](#)
- planning base location [ANPG\\_18](#)
- planning power guide [ANPG\\_20- ANPG\\_40](#)

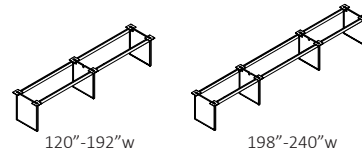

D	W	H	CTN WT	CU FT	① Model	Description	TFL Laminate T	ESS Veneer V	ART Veneer V
<b>Outline Base Kit for 54/60"deep Table</b>									
30	84	27 $\frac{7}{8}$	74	22	<b>65T30120ULB_</b>	Outline Metal Base Kit for 54/60"d x 120"w Top Surfaces	<b>\$2,938</b>	<b>\$3,936</b>	<b>\$4,330</b>
30	90	27 $\frac{7}{8}$	75	22	<b>65T30126ULB_</b>	Outline Metal Base Kit for 54/60"d x 126"w Top Surfaces	<b>\$2,947</b>	<b>\$3,947</b>	<b>\$4,342</b>
30	96	27 $\frac{7}{8}$	76	22	<b>65T30132ULB_</b>	Outline Metal Base Kit for 54/60"d x 132"w Top Surfaces	<b>\$2,956</b>	<b>\$3,958</b>	<b>\$4,354</b>
30	102	27 $\frac{7}{8}$	77	22	<b>65T30138ULB_</b>	Outline Metal Base Kit for 54/60"d x 138"w Top Surfaces	<b>\$2,965</b>	<b>\$3,969</b>	<b>\$4,366</b>
30	108	27 $\frac{7}{8}$	78	22	<b>65T30144ULB_</b>	Outline Metal Base Kit for 54/60"d x 144"w Top Surfaces	<b>\$2,975</b>	<b>\$3,981</b>	<b>\$4,379</b>
30	114	27 $\frac{7}{8}$	80	22	<b>65T30150ULB_</b>	Outline Metal Base Kit for 54/60"d x 150"w Top Surfaces	<b>\$2,984</b>	<b>\$3,992</b>	<b>\$4,391</b>
30	120	27 $\frac{7}{8}$	81	22	<b>65T30156ULB_</b>	Outline Metal Base Kit for 54/60"d x 156"w Top Surfaces	<b>\$2,993</b>	<b>\$4,003</b>	<b>\$4,403</b>
30	126	27 $\frac{7}{8}$	82	22	<b>65T30162ULB_</b>	Outline Metal Base Kit for 54/60"d x 162"w Top Surfaces	<b>\$3,002</b>	<b>\$4,014</b>	<b>\$4,415</b>
30	132	27 $\frac{7}{8}$	83	22	<b>65T30168ULB_</b>	Outline Metal Base Kit for 54/60"d x 168"w Top Surfaces	<b>\$3,012</b>	<b>\$4,025</b>	<b>\$4,428</b>
30	138	27 $\frac{7}{8}$	84	22	<b>65T30174ULB_</b>	Outline Metal Base Kit for 54/60"d x 174"w Top Surfaces	<b>\$3,021</b>	<b>\$4,036</b>	<b>\$4,440</b>
30	144	27 $\frac{7}{8}$	85	22	<b>65T30180ULB_</b>	Outline Metal Base Kit for 54/60"d x 180"w Top Surfaces	<b>\$3,030</b>	<b>\$4,047</b>	<b>\$4,452</b>
30	150	27 $\frac{7}{8}$	86	23	<b>65T30186ULB_</b>	Outline Metal Base Kit for 54/60"d x 186"w Top Surfaces	<b>\$3,039</b>	<b>\$4,058</b>	<b>\$4,464</b>
30	156	27 $\frac{7}{8}$	87	23	<b>65T30192ULB_</b>	Outline Metal Base Kit for 54/60"d x 192"w Top Surfaces	<b>\$3,049</b>	<b>\$4,069</b>	<b>\$4,476</b>
30	162	27 $\frac{7}{8}$	100	29	<b>65T30198ULB_</b>	Outline Metal Base Kit for 54/60"d x 198"w Top Surfaces	<b>\$3,170</b>	<b>\$4,247</b>	<b>\$4,672</b>
30	168	27 $\frac{7}{8}$	101	29	<b>65T30204ULB_</b>	Outline Metal Base Kit for 54/60"d x 204"w Top Surfaces	<b>\$3,291</b>	<b>\$4,426</b>	<b>\$4,869</b>
30	174	27 $\frac{7}{8}$	102	29	<b>65T30210ULB_</b>	Outline Metal Base Kit for 54/60"d x 210"w Top Surfaces	<b>\$3,412</b>	<b>\$4,604</b>	<b>\$5,064</b>
30	180	27 $\frac{7}{8}$	103	29	<b>65T30216ULB_</b>	Outline Metal Base Kit for 54/60"d x 216"w Top Surfaces	<b>\$3,533</b>	<b>\$4,783</b>	<b>\$5,261</b>
30	186	27 $\frac{7}{8}$	104	30	<b>65T30222ULB_</b>	Outline Metal Base Kit for 54/60"d x 222"w Top Surfaces	<b>\$3,654</b>	<b>\$4,961</b>	<b>\$5,457</b>
30	192	27 $\frac{7}{8}$	105	30	<b>65T30228ULB_</b>	Outline Metal Base Kit for 54/60"d x 228"w Top Surfaces	<b>\$3,775</b>	<b>\$5,140</b>	<b>\$5,654</b>
30	198	27 $\frac{7}{8}$	106	30	<b>65T30234ULB_</b>	Outline Metal Base Kit for 54/60"d x 234"w Top Surfaces	<b>\$3,896</b>	<b>\$5,319</b>	<b>\$5,851</b>
30	204	27 $\frac{7}{8}$	108	30	<b>65T30240ULB_</b>	Outline Metal Base Kit for 54/60"d x 240"w Top Surfaces	<b>\$4,017</b>	<b>\$5,497</b>	<b>\$6,047</b>

Model	Laminate	Veneer	Metal Finish
	<a href="#">see Anthology Laminate Selection</a>	<a href="#">see Anthology Veneer Selection</a>	<a href="#">see Anthology Metal Finishes</a>  <b>Chrome Metal Base Upcharge</b> 2 bases 72" - 114" - <b>add \$1,950</b> 3 bases 120" - 192" - <b>add \$2,925</b> 4 bases 198" - 240" - <b>add \$3,900</b>

**Racetrack Base Kit**

- available in HPL and Veneer surfaces
- top shapes: Rectangular, Soft Rectangular, Arc Rectangular, Boat, Arc Boat and Racetrack
- planning base specification [ANPG\\_15](#)
- planning base location [ANPG\\_18](#)
- planning power guide [ANPG\\_20- ANPG\\_40](#)

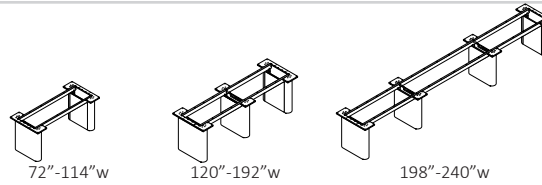

D	W	H	CTN WT	CU FT	① Model	Description	HPL Laminate H	ESS Veneer V	ART Veneer V
<b>Racetrack Base Kit for 36"deep Table</b>									
18	48	27½	87	11	<b>65T1872RKB_</b>	Racetrack Base Kit for 36"d x 72"w Top Surfaces	\$5,566	\$5,752	\$6,328
18	54	27½	87	11	<b>65T1878RKB_</b>	Racetrack Base Kit for 36"d x 78"w Top Surfaces	\$5,570	\$5,756	\$6,332
18	54	27½	87	11	<b>65T1884RKB_</b>	Racetrack Base Kit for 36"d x 84"w Top Surfaces	\$5,574	\$5,760	\$6,336
18	60	27½	99	12	<b>65T1890RKB_</b>	Racetrack Base Kit for 36"d x 90"w Top Surfaces	\$5,578	\$5,764	\$6,341
18	60	27½	99	12	<b>65T1896RKB_</b>	Racetrack Base Kit for 36"d x 96"w Top Surfaces	\$5,582	\$5,768	\$6,345
<b>Racetrack Base Kit for 42/48"deep Table</b>									
24	48	27½	102	13	<b>65T2472RKB_</b>	Racetrack Base Kit for 42/48"d x 72"w Top Surfaces	\$5,795	\$5,925	\$6,518
24	54	27½	102	13	<b>65T2478RKB_</b>	Racetrack Base Kit for 42/48"d x 78"w Top Surfaces	\$5,863	\$6,012	\$6,614
24	54	27½	103	13	<b>65T2484RKB_</b>	Racetrack Base Kit for 42/48"d x 84"w Top Surfaces	\$5,931	\$6,098	\$6,708
24	60	27½	103	14	<b>65T2490RKB_</b>	Racetrack Base Kit for 42/48"d x 90"w Top Surfaces	\$5,999	\$6,184	\$6,803
24	60	27½	104	14	<b>65T2496RKB_</b>	Racetrack Base Kit for 42/48"d x 96"w Top Surfaces	\$6,067	\$6,270	\$6,897
24	66	27½	104	15	<b>65T24102RKB_</b>	Racetrack Base Kit for 42/48"d x 102"w Top Surfaces	\$6,158	\$6,386	\$7,025
24	72	27½	105	15	<b>65T24108RKB_</b>	Racetrack Base Kit for 42/48"d x 108"w Top Surfaces	\$6,248	\$6,501	\$7,152
24	78	27½	105	15	<b>65T24114RKB_</b>	Racetrack Base Kit for 42/48"d x 114"w Top Surfaces	\$6,338	\$6,616	\$7,278
24	84	27½	140	20	<b>65T24120RKB_</b>	Racetrack Base Kit for 42/48"d x 120"w Top Surfaces	\$10,198	\$10,706	\$11,777
<b>Racetrack Base Kit for 48"deep Table</b>									
24	90	27½	140	20	<b>65T24126RKB_</b>	Racetrack Base Kit for 48"d x 126"w Top Surfaces	\$10,203	\$10,710	\$11,781
24	96	27½	140	20	<b>65T24132RKB_</b>	Racetrack Base Kit for 48"d x 132"w Top Surfaces	\$10,206	\$10,716	\$11,788
24	102	27½	143	20	<b>65T24138RKB_</b>	Racetrack Base Kit for 48"d x 138"w Top Surfaces	\$10,210	\$10,722	\$11,795
24	108	27½	143	21	<b>65T24144RKB_</b>	Racetrack Base Kit for 48"d x 144"w Top Surfaces	\$10,213	\$10,728	\$11,801
24	114	27½	143	21	<b>65T24150RKB_</b>	Racetrack Base Kit for 48"d x 150"w Top Surfaces	\$10,217	\$10,731	\$11,805
24	120	27½	143	21	<b>65T24156RKB_</b>	Racetrack Base Kit for 48"d x 156"w Top Surfaces	\$10,221	\$10,737	\$11,811
24	126	27½	145	22	<b>65T24162RKB_</b>	Racetrack Base Kit for 48"d x 162"w Top Surfaces	\$10,224	\$10,743	\$11,818
24	132	27½	145	22	<b>65T24168RKB_</b>	Racetrack Base Kit for 48"d x 168"w Top Surfaces	\$10,227	\$10,749	\$11,824
24	138	27½	145	22	<b>65T24174RKB_</b>	Racetrack Base Kit for 48"d x 174"w Top Surfaces	\$10,231	\$10,755	\$11,831
24	144	27½	147	23	<b>65T24180RKB_</b>	Racetrack Base Kit for 48"d x 180"w Top Surfaces	\$10,235	\$10,761	\$11,838
24	150	27½	147	23	<b>65T24186RKB_</b>	Racetrack Base Kit for 48"d x 186"w Top Surfaces	\$10,238	\$10,767	\$11,844
24	156	27½	147	23	<b>65T24192RKB_</b>	Racetrack Base Kit for 48"d x 192"w Top Surfaces	\$10,242	\$10,773	\$11,851
24	162	27½	196	29	<b>65T24198RKB_</b>	Racetrack Base Kit for 48"d x 198"w Top Surfaces	\$13,125	\$14,005	\$15,406
24	168	27½	220	29	<b>65T24204RKB_</b>	Racetrack Base Kit for 48"d x 204"w Top Surfaces	\$13,130	\$14,010	\$15,411
24	174	27½	220	29	<b>65T24210RKB_</b>	Racetrack Base Kit for 48"d x 210"w Top Surfaces	\$13,135	\$14,015	\$15,417
24	180	27½	225	30	<b>65T24216RKB_</b>	Racetrack Base Kit for 48"d x 216"w Top Surfaces	\$13,140	\$14,020	\$15,422
24	186	27½	225	30	<b>65T24222RKB_</b>	Racetrack Base Kit for 48"d x 222"w Top Surfaces	\$13,145	\$14,025	\$15,428
24	192	27½	230	30	<b>65T24228RKB_</b>	Racetrack Base Kit for 48"d x 228"w Top Surfaces	\$13,150	\$14,040	\$15,444
24	198	27½	230	31	<b>65T24234RKB_</b>	Racetrack Base Kit for 48"d x 234"w Top Surfaces	\$13,155	\$14,035	\$15,439
24	204	27½	235	31	<b>65T24240RKB_</b>	Racetrack Base Kit for 48"d x 240"w Top Surfaces	\$13,160	\$14,140	\$15,554

Model	Laminate	Veneer
	<a href="#">see Anthology Laminate Finishes</a>	<a href="#">see Anthology Veneer Finishes</a>



**Racetrack Base Kit**

- available in HPL and Veneer surfaces
- top shapes: Rectangular, Soft Rectangular, Arc Rectangular, Boat, Arc Boat and Racetrack
- planning base specification [ANPG\\_15](#)
- planning base location [ANPG\\_18](#)
- planning power guide [ANPG\\_20- ANPG\\_40](#)

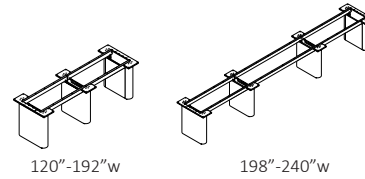

D	W	H	CTN WT	CU FT	① Model	Description	HPL Laminate H	ESS Veneer V	ART Veneer V
<b>Racetrack Base Kit for 54/60"deep Table</b>									
30	84	27 $\frac{7}{8}$	154	32	<b>65T30120RKB_</b>	Racetrack Base Kit for 54/60"d x 120"w Top Surfaces	<b>\$11,020</b>	<b>\$11,114</b>	<b>\$12,226</b>
30	90	27 $\frac{7}{8}$	154	32	<b>65T30126RKB_</b>	Racetrack Base Kit for 54/60"d x 126"w Top Surfaces	<b>\$11,025</b>	<b>\$11,121</b>	<b>\$12,234</b>
30	96	27 $\frac{7}{8}$	154	32	<b>65T30132RKB_</b>	Racetrack Base Kit for 54/60"d x 132"w Top Surfaces	<b>\$11,030</b>	<b>\$11,126</b>	<b>\$12,239</b>
30	102	27 $\frac{7}{8}$	157	33	<b>65T30138RKB_</b>	Racetrack Base Kit for 54/60"d x 138"w Top Surfaces	<b>\$11,035</b>	<b>\$11,132</b>	<b>\$12,246</b>
30	108	27 $\frac{7}{8}$	157	33	<b>65T30144RKB_</b>	Racetrack Base Kit for 54/60"d x 144"w Top Surfaces	<b>\$11,040</b>	<b>\$11,137</b>	<b>\$12,251</b>
30	114	27 $\frac{7}{8}$	157	33	<b>65T30150RKB_</b>	Racetrack Base Kit for 54/60"d x 150"w Top Surfaces	<b>\$11,090</b>	<b>\$11,141</b>	<b>\$12,256</b>
30	120	27 $\frac{7}{8}$	157	34	<b>65T30156RKB_</b>	Racetrack Base Kit for 54/60"d x 156"w Top Surfaces	<b>\$11,140</b>	<b>\$11,147</b>	<b>\$12,262</b>
30	126	27 $\frac{7}{8}$	159	34	<b>65T30162RKB_</b>	Racetrack Base Kit for 54/60"d x 162"w Top Surfaces	<b>\$11,190</b>	<b>\$11,153</b>	<b>\$12,269</b>
30	132	27 $\frac{7}{8}$	159	34	<b>65T30168RKB_</b>	Racetrack Base Kit for 54/60"d x 168"w Top Surfaces	<b>\$11,240</b>	<b>\$11,158</b>	<b>\$12,274</b>
30	138	27 $\frac{7}{8}$	159	35	<b>65T30174RKB_</b>	Racetrack Base Kit for 54/60"d x 174"w Top Surfaces	<b>\$11,290</b>	<b>\$11,164</b>	<b>\$12,281</b>
30	144	27 $\frac{7}{8}$	161	35	<b>65T30180RKB_</b>	Racetrack Base Kit for 54/60"d x 180"w Top Surfaces	<b>\$11,340</b>	<b>\$11,170</b>	<b>\$12,287</b>
30	150	27 $\frac{7}{8}$	161	35	<b>65T30186RKB_</b>	Racetrack Base Kit for 54/60"d x 186"w Top Surfaces	<b>\$11,390</b>	<b>\$11,175</b>	<b>\$12,293</b>
30	156	27 $\frac{7}{8}$	161	36	<b>65T30192RKB_</b>	Racetrack Base Kit for 54/60"d x 192"w Top Surfaces	<b>\$11,440</b>	<b>\$11,181</b>	<b>\$12,300</b>
30	162	27 $\frac{7}{8}$	196	36	<b>65T30198RKB_</b>	Racetrack Base Kit for 54/60"d x 198"w Top Surfaces	<b>\$15,204</b>	<b>\$16,220</b>	<b>\$17,842</b>
30	168	27 $\frac{7}{8}$	220	36	<b>65T30204RKB_</b>	Racetrack Base Kit for 54/60"d x 204"w Top Surfaces	<b>\$15,209</b>	<b>\$16,225</b>	<b>\$17,848</b>
30	174	27 $\frac{7}{8}$	220	37	<b>65T30210RKB_</b>	Racetrack Base Kit for 54/60"d x 210"w Top Surfaces	<b>\$15,214</b>	<b>\$16,230</b>	<b>\$17,853</b>
30	180	27 $\frac{7}{8}$	225	37	<b>65T30216RKB_</b>	Racetrack Base Kit for 54/60"d x 216"w Top Surfaces	<b>\$15,219</b>	<b>\$16,235</b>	<b>\$17,859</b>
30	186	27 $\frac{7}{8}$	225	37	<b>65T30222RKB_</b>	Racetrack Base Kit for 54/60"d x 222"w Top Surfaces	<b>\$15,224</b>	<b>\$16,240</b>	<b>\$17,864</b>
30	192	27 $\frac{7}{8}$	244	38	<b>65T30228RKB_</b>	Racetrack Base Kit for 54/60"d x 228"w Top Surfaces	<b>\$15,229</b>	<b>\$16,245</b>	<b>\$17,870</b>
30	198	27 $\frac{7}{8}$	244	38	<b>65T30234RKB_</b>	Racetrack Base Kit for 54/60"d x 234"w Top Surfaces	<b>\$15,234</b>	<b>\$16,250</b>	<b>\$17,875</b>
30	204	27 $\frac{7}{8}$	249	38	<b>65T30240RKB_</b>	Racetrack Base Kit for 54/60"d x 240"w Top Surfaces	<b>\$15,239</b>	<b>\$16,255</b>	<b>\$17,881</b>

Model	Laminate	Veneer
	<a href="#">see Anthology Laminate Finishes</a>	<a href="#">see Anthology Veneer Finishes</a>

**Racetrack BridgeLine Base Kit**

- available in HPL and Veneer surfaces
- top shapes: Rectangular, Soft Rectangular, Arc Rectangular, Boat, Arc Boat and Racetrack
- planning base specification [ANPG\\_16](#)
- planning base location [ANPG\\_18](#)
- planning power guide [ANPG\\_20- ANPG\\_40](#)

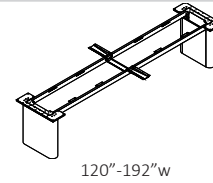

D	W	H	CTN WT	CU FT	① Model	Description	HPL Laminate H	ESS Veneer V	ART Veneer V
<b>Racetrack BridgeLine Base Kit for 48"deep Table</b>									
24	84	27%	154	18	<b>65T24120RK2B_</b>	Racetrack BridgeLine Base Kit for 48"d x 120"w Top Surfaces	<b>\$7,131</b>	<b>\$7,326</b>	<b>\$8,059</b>
24	90	27%	156	18	<b>65T24126RK2B_</b>	Racetrack BridgeLine Base Kit for 48"d x 126"w Top Surfaces	<b>\$7,140</b>	<b>\$7,335</b>	<b>\$8,069</b>
24	96	27%	158	18	<b>65T24132RK2B_</b>	Racetrack BridgeLine Base Kit for 48"d x 132"w Top Surfaces	<b>\$7,149</b>	<b>\$7,343</b>	<b>\$8,078</b>
24	102	27%	161	19	<b>65T24138RK2B_</b>	Racetrack BridgeLine Base Kit for 48"d x 138"w Top Surfaces	<b>\$7,158</b>	<b>\$7,351</b>	<b>\$8,087</b>
24	108	27%	163	19	<b>65T24144RK2B_</b>	Racetrack BridgeLine Base Kit for 48"d x 144"w Top Surfaces	<b>\$7,166</b>	<b>\$7,361</b>	<b>\$8,098</b>
24	114	27%	166	19	<b>65T24150RK2B_</b>	Racetrack BridgeLine Base Kit for 48"d x 150"w Top Surfaces	<b>\$7,179</b>	<b>\$7,372</b>	<b>\$8,110</b>
24	120	27%	168	19	<b>65T24156RK2B_</b>	Racetrack BridgeLine Base Kit for 48"d x 156"w Top Surfaces	<b>\$7,190</b>	<b>\$7,383</b>	<b>\$8,122</b>
24	126	27%	171	19	<b>65T24162RK2B_</b>	Racetrack BridgeLine Base Kit for 48"d x 162"w Top Surfaces	<b>\$7,201</b>	<b>\$7,395</b>	<b>\$8,135</b>
24	132	27%	174	19	<b>65T24168RK2B_</b>	Racetrack BridgeLine Base Kit for 48"d x 168"w Top Surfaces	<b>\$7,213</b>	<b>\$7,406</b>	<b>\$8,147</b>
24	138	27%	177	20	<b>65T24174RK2B_</b>	Racetrack BridgeLine Base Kit for 48"d x 174"w Top Surfaces	<b>\$7,224</b>	<b>\$7,419</b>	<b>\$8,161</b>
24	144	27%	179	20	<b>65T24180RK2B_</b>	Racetrack BridgeLine Base Kit for 48"d x 180"w Top Surfaces	<b>\$7,236</b>	<b>\$7,430</b>	<b>\$8,173</b>
24	150	27%	182	20	<b>65T24186RK2B_</b>	Racetrack BridgeLine Base Kit for 48"d x 186"w Top Surfaces	<b>\$7,247</b>	<b>\$7,442</b>	<b>\$8,187</b>
24	156	27%	184	20	<b>65T24192RK2B_</b>	Racetrack BridgeLine Base Kit for 48"d x 192"w Top Surfaces	<b>\$7,259</b>	<b>\$7,453</b>	<b>\$8,199</b>
<b>Racetrack BridgeLine Base Kit for 54/60"deep Table</b>									
30	84	27%	179	21	<b>65T30120RK2B_</b>	Racetrack BridgeLine Base Kit for 54/60"d x 120"w Top Surfaces	<b>\$7,469</b>	<b>\$7,718</b>	<b>\$8,490</b>
30	90	27%	182	21	<b>65T30126RK2B_</b>	Racetrack BridgeLine Base Kit for 54/60"d x 126"w Top Surfaces	<b>\$7,502</b>	<b>\$7,751</b>	<b>\$8,527</b>
30	96	27%	184	21	<b>65T30132RK2B_</b>	Racetrack BridgeLine Base Kit for 54/60"d x 132"w Top Surfaces	<b>\$7,534</b>	<b>\$7,783</b>	<b>\$8,562</b>
30	102	27%	187	21	<b>65T30138RK2B_</b>	Racetrack BridgeLine Base Kit for 54/60"d x 138"w Top Surfaces	<b>\$7,566</b>	<b>\$7,816</b>	<b>\$8,598</b>
30	108	27%	189	22	<b>65T30144RK2B_</b>	Racetrack BridgeLine Base Kit for 54/60"d x 144"w Top Surfaces	<b>\$7,599</b>	<b>\$7,848</b>	<b>\$8,633</b>
30	114	27%	192	22	<b>65T30150RK2B_</b>	Racetrack BridgeLine Base Kit for 54/60"d x 150"w Top Surfaces	<b>\$7,616</b>	<b>\$7,866</b>	<b>\$8,653</b>
30	120	27%	194	22	<b>65T30156RK2B_</b>	Racetrack BridgeLine Base Kit for 54/60"d x 156"w Top Surfaces	<b>\$7,633</b>	<b>\$7,883</b>	<b>\$8,672</b>
30	126	27%	197	22	<b>65T30162RK2B_</b>	Racetrack BridgeLine Base Kit for 54/60"d x 162"w Top Surfaces	<b>\$7,650</b>	<b>\$7,899</b>	<b>\$8,689</b>
30	132	27%	200	22	<b>65T30168RK2B_</b>	Racetrack BridgeLine Base Kit for 54/60"d x 168"w Top Surfaces	<b>\$7,666</b>	<b>\$7,916</b>	<b>\$8,708</b>
30	138	27%	202	22	<b>65T30174RK2B_</b>	Racetrack BridgeLine Base Kit for 54/60"d x 174"w Top Surfaces	<b>\$7,683</b>	<b>\$7,933</b>	<b>\$8,727</b>
30	144	27%	205	23	<b>65T30180RK2B_</b>	Racetrack BridgeLine Base Kit for 54/60"d x 180"w Top Surfaces	<b>\$7,700</b>	<b>\$7,949</b>	<b>\$8,744</b>
30	150	27%	207	23	<b>65T30186RK2B_</b>	Racetrack BridgeLine Base Kit for 54/60"d x 186"w Top Surfaces	<b>\$7,716</b>	<b>\$7,966</b>	<b>\$8,763</b>
30	156	27%	210	23	<b>65T30192RK2B_</b>	Racetrack BridgeLine Base Kit for 54/60"d x 192"w Top Surfaces	<b>\$7,733</b>	<b>\$7,982</b>	<b>\$8,781</b>

Model	Laminate	Veneer
	<a href="#">see Anthology Laminate Finishes</a>	<a href="#">see Anthology Veneer Finishes</a>



**Conical Single Base**

- available in HPL and Veneer surfaces
- top shape: Round
- specify 20" base for 36" and 42" tops
- specify 24" base for 48", 54" and 60" tops
- planning base specification [ANPG\\_9](#)
- planning power guide [ANPG\\_20- ANPG\\_40](#)

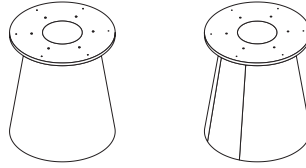

D	W	H	CTN WT	CU FT	① Model	Description	HPL Laminate H	ESS Veneer V	ART Veneer V
<b>Conical Single Base</b>									
20	20	27 $\frac{7}{8}$	144	10	<b>65T2028CNB_</b>	Conical Single Base	<b>\$4,135</b>	<b>\$4,758</b>	<b>\$5,234</b>
24	24	27 $\frac{7}{8}$	114	13	<b>65T2428CNB_</b>	Conical Single Base	<b>\$4,497</b>	<b>\$5,086</b>	<b>\$5,595</b>
<b>Conical Single Access Base</b>									
20	20	27 $\frac{7}{8}$	144	10	<b>65T2028CNAB_</b>	Conical Single Access Base	<b>\$4,776</b>	<b>\$5,398</b>	<b>\$5,938</b>
24	24	27 $\frac{7}{8}$	114	13	<b>65T2428CNAB_</b>	Conical Single Access Base	<b>\$5,209</b>	<b>\$5,798</b>	<b>\$6,378</b>

Model	Laminate	Veneer
	<a href="#">see Anthology Laminate Finishes</a>	<a href="#">see Anthology Veneer Finishes</a>

**Conical Base Kit**

- available in HPL and Veneer surfaces
- top shapes: Rectangular, Soft Rectangular, Arc Rectangular, Boat, Arc Boat and Racetrack
- planning base specification [ANPG\\_9](#)
- planning base location [ANPG\\_19](#)
- planning power guide [ANPG\\_20- ANPG\\_40](#)

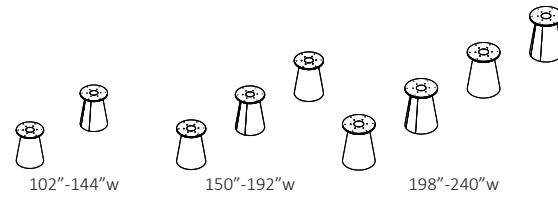

D	W	H	CTN WT	CU FT	① Model	Description	HPL Laminate H	ESS Veneer V	ART Veneer V
<b>Conical Base Kit for 42/48"deep Table</b>									
20	68	27 $\frac{7}{8}$	271	20	<b>65T20102CNB_</b>	Conical Base Kit for 42/48" d x 102" w Top Surfaces	\$9,800	\$10,809	\$11,890
20	74	27 $\frac{7}{8}$	271	20	<b>65T20108CNB_</b>	Conical Base Kit for 42/48" d x 108" w Top Surfaces	\$9,800	\$10,809	\$11,890
20	80	27 $\frac{7}{8}$	271	20	<b>65T20114CNB_</b>	Conical Base Kit for 42/48" d x 114" w Top Surfaces	\$9,800	\$10,809	\$11,890
20	86	27 $\frac{7}{8}$	291	20	<b>65T20120CNB_</b>	Conical Base Kit for 42/48" d x 120" w Top Surfaces	\$9,800	\$10,809	\$11,890
20	92	27 $\frac{7}{8}$	291	22	<b>65T20126CNB_</b>	Conical Base Kit for 42/48" d x 126" w Top Surfaces	\$9,954	\$10,963	\$12,060
20	98	27 $\frac{7}{8}$	291	22	<b>65T20132CNB_</b>	Conical Base Kit for 42/48" d x 132" w Top Surfaces	\$9,954	\$10,963	\$12,060
20	104	27 $\frac{7}{8}$	291	22	<b>65T20138CNB_</b>	Conical Base Kit for 42/48" d x 138" w Top Surfaces	\$9,954	\$10,963	\$12,060
20	110	27 $\frac{7}{8}$	291	22	<b>65T20144CNB_</b>	Conical Base Kit for 42/48" d x 144" w Top Surfaces	\$9,954	\$10,963	\$12,060
20	116	27 $\frac{7}{8}$	261	30	<b>65T20150CNB_</b>	Conical Base Kit for 42/48" d x 150" w Top Surfaces	\$14,273	\$15,599	\$17,159
20	122	27 $\frac{7}{8}$	261	30	<b>65T20156CNB_</b>	Conical Base Kit for 42/48" d x 156" w Top Surfaces	\$14,273	\$15,599	\$17,159
20	128	27 $\frac{7}{8}$	261	30	<b>65T20162CNB_</b>	Conical Base Kit for 42/48" d x 162" w Top Surfaces	\$14,273	\$15,599	\$17,159
20	134	27 $\frac{7}{8}$	261	30	<b>65T20168CNB_</b>	Conical Base Kit for 42/48" d x 168" w Top Surfaces	\$14,273	\$15,599	\$17,159
20	140	27 $\frac{7}{8}$	261	30	<b>65T20174CNB_</b>	Conical Base Kit for 42/48" d x 174" w Top Surfaces	\$14,273	\$15,599	\$17,159
20	146	27 $\frac{7}{8}$	281	32	<b>65T20180CNB_</b>	Conical Base Kit for 42/48" d x 180" w Top Surfaces	\$14,543	\$15,868	\$17,455
20	152	27 $\frac{7}{8}$	281	32	<b>65T20186CNB_</b>	Conical Base Kit for 42/48" d x 186" w Top Surfaces	\$14,543	\$15,868	\$17,455
20	158	27 $\frac{7}{8}$	281	32	<b>65T20192CNB_</b>	Conical Base Kit for 42/48" d x 192" w Top Surfaces	\$14,543	\$15,868	\$17,455
20	164	27 $\frac{7}{8}$	298	52	<b>65T20198CNB_</b>	Conical Base Kit for 42/48" d x 198" w Top Surfaces	\$19,459	\$21,101	\$23,212
20	170	27 $\frac{7}{8}$	298	52	<b>65T20204CNB_</b>	Conical Base Kit for 42/48" d x 204" w Top Surfaces	\$19,459	\$21,101	\$23,212
20	176	27 $\frac{7}{8}$	298	52	<b>65T20210CNB_</b>	Conical Base Kit for 42/48" d x 210" w Top Surfaces	\$19,459	\$21,101	\$23,212
20	182	27 $\frac{7}{8}$	298	52	<b>65T20216CNB_</b>	Conical Base Kit for 42/48" d x 216" w Top Surfaces	\$19,459	\$21,101	\$23,212
20	188	27 $\frac{7}{8}$	318	54	<b>65T20222CNB_</b>	Conical Base Kit for 42/48" d x 222" w Top Surfaces	\$19,842	\$21,484	\$23,633
20	194	27 $\frac{7}{8}$	318	54	<b>65T20228CNB_</b>	Conical Base Kit for 42/48" d x 228" w Top Surfaces	\$19,842	\$21,484	\$23,633
20	200	27 $\frac{7}{8}$	318	54	<b>65T20234CNB_</b>	Conical Base Kit for 42/48" d x 234" w Top Surfaces	\$19,842	\$21,484	\$23,633
20	206	27 $\frac{7}{8}$	318	54	<b>65T20240CNB_</b>	Conical Base Kit for 42/48" d x 240" w Top Surfaces	\$19,842	\$21,484	\$23,633

Model	Laminate	Veneer
	<a href="#">see Anthology Laminate Finishes</a>	<a href="#">see Anthology Veneer Finishes</a>

**Conical Base Kit**

- available in HPL and Veneer surfaces
- top shapes: Rectangular, Soft Rectangular, Arc Rectangular, Boat, Arc Boat and Racetrack
- planning base specification [ANPG\\_9](#)
- planning base location [ANPG\\_19](#)
- planning power guide [ANPG\\_20- ANPG\\_40](#)

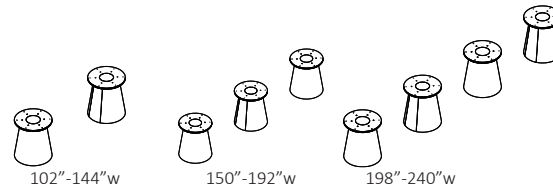

D	W	H	CTN WT	CU FT	① Model	Description	HPL Laminate H	ESS Veneer V	ART Veneer V
<b>Conical Base Kit for 54/60"deep Table</b>									
24	90	27 $\frac{7}{8}$	78	26	<b>65T24120CNB_</b>	Conical Base Kit for 54/60"d x 120"w Top Surfaces	<b>\$10,646</b>	<b>\$11,581</b>	<b>\$12,740</b>
24	96	27 $\frac{7}{8}$	98	28	<b>65T24126CNB_</b>	Conical Base Kit for 54/60"d x 126"w Top Surfaces	<b>\$10,800</b>	<b>\$11,735</b>	<b>\$12,909</b>
24	102	27 $\frac{7}{8}$	98	28	<b>65T24132CNB_</b>	Conical Base Kit for 54/60"d x 132"w Top Surfaces	<b>\$10,800</b>	<b>\$11,735</b>	<b>\$12,909</b>
24	108	27 $\frac{7}{8}$	98	28	<b>65T24138CNB_</b>	Conical Base Kit for 54/60"d x 138"w Top Surfaces	<b>\$10,800</b>	<b>\$11,735</b>	<b>\$12,909</b>
24	114	27 $\frac{7}{8}$	98	28	<b>65T24144CNB_</b>	Conical Base Kit for 54/60"d x 144"w Top Surfaces	<b>\$10,800</b>	<b>\$11,735</b>	<b>\$12,909</b>
24	120	27 $\frac{7}{8}$	117	39	<b>65T24150CNB_</b>	Conical Base Kit for 54/60"d x 150"w Top Surfaces	<b>\$15,530</b>	<b>\$16,745</b>	<b>\$18,420</b>
24	126	27 $\frac{7}{8}$	117	39	<b>65T24156CNB_</b>	Conical Base Kit for 54/60"d x 156"w Top Surfaces	<b>\$14,566</b>	<b>\$16,745</b>	<b>\$18,420</b>
24	132	27 $\frac{7}{8}$	117	39	<b>65T24162CNB_</b>	Conical Base Kit for 54/60"d x 162"w Top Surfaces	<b>\$14,566</b>	<b>\$16,745</b>	<b>\$18,420</b>
24	138	27 $\frac{7}{8}$	117	39	<b>65T24168CNB_</b>	Conical Base Kit for 54/60"d x 168"w Top Surfaces	<b>\$14,566</b>	<b>\$16,745</b>	<b>\$18,420</b>
24	144	27 $\frac{7}{8}$	117	39	<b>65T24174CNB_</b>	Conical Base Kit for 54/60"d x 174"w Top Surfaces	<b>\$14,566</b>	<b>\$16,745</b>	<b>\$18,420</b>
24	150	27 $\frac{7}{8}$	137	41	<b>65T24180CNB_</b>	Conical Base Kit for 54/60"d x 180"w Top Surfaces	<b>\$15,800</b>	<b>\$17,015</b>	<b>\$18,717</b>
24	156	27 $\frac{7}{8}$	137	41	<b>65T24186CNB_</b>	Conical Base Kit for 54/60"d x 186"w Top Surfaces	<b>\$15,800</b>	<b>\$17,015</b>	<b>\$18,717</b>
24	162	27 $\frac{7}{8}$	137	41	<b>65T24192CNB_</b>	Conical Base Kit for 54/60"d x 192"w Top Surfaces	<b>\$15,800</b>	<b>\$17,015</b>	<b>\$18,717</b>
24	168	27 $\frac{7}{8}$	152	52	<b>65T24198CNB_</b>	Conical Base Kit for 54/60"d x 198"w Top Surfaces	<b>\$21,207</b>	<b>\$22,758</b>	<b>\$25,034</b>
24	174	27 $\frac{7}{8}$	152	52	<b>65T24204CNB_</b>	Conical Base Kit for 54/60"d x 204"w Top Surfaces	<b>\$21,207</b>	<b>\$22,758</b>	<b>\$25,034</b>
24	180	27 $\frac{7}{8}$	152	52	<b>65T24210CNB_</b>	Conical Base Kit for 54/60"d x 210"w Top Surfaces	<b>\$21,207</b>	<b>\$22,758</b>	<b>\$25,034</b>
24	186	27 $\frac{7}{8}$	152	52	<b>65T24216CNB_</b>	Conical Base Kit for 54/60"d x 216"w Top Surfaces	<b>\$21,207</b>	<b>\$22,758</b>	<b>\$25,034</b>
24	192	27 $\frac{7}{8}$	172	54	<b>65T24222CNB_</b>	Conical Base Kit for 54/60"d x 222"w Top Surfaces	<b>\$21,589</b>	<b>\$23,084</b>	<b>\$25,393</b>
24	198	27 $\frac{7}{8}$	172	54	<b>65T24228CNB_</b>	Conical Base Kit for 54/60"d x 228"w Top Surfaces	<b>\$21,589</b>	<b>\$23,084</b>	<b>\$25,393</b>
24	204	27 $\frac{7}{8}$	172	54	<b>65T24234CNB_</b>	Conical Base Kit for 54/60"d x 234"w Top Surfaces	<b>\$21,589</b>	<b>\$23,084</b>	<b>\$25,393</b>
24	210	27 $\frac{7}{8}$	172	54	<b>65T24240CNB_</b>	Conical Base Kit for 54/60"d x 240"w Top Surfaces	<b>\$21,589</b>	<b>\$23,084</b>	<b>\$25,393</b>

Model	Laminate	Veneer
	<a href="#">see Anthology Laminate Finishes</a>	<a href="#">see Anthology Veneer Finishes</a>

**Fluted Cylinder Single Base**

- available in fluted solid wood
- top shape: Round
- specify 19" base for 36" and 42" tops
- specify 24" base for 48", 54" and 60" tops
- planning base specification [ANPG\\_10](#)
- planning power guide [ANPG\\_20- ANPG\\_40](#)

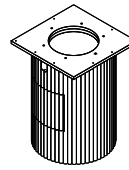
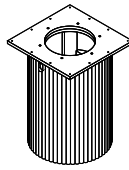

D	W	H	CTN WT	CU FT	Model	Description	List Price
<b>Fluted Cylinder Single Base</b>							
19½	19½	27⅞	142	10	<b>65T1828FCYBW</b>	Fluted Solid Wood Single Base	<b>\$7,762</b>
24½	24½	27⅞	129	13	<b>65T2428FCYBW</b>	Fluted Solid Wood Single Base	<b>\$8,974</b>
<b>Fluted Cylinder Single Access Base</b>							
19½	19½	27⅞	142	10	<b>65T1828FCYABW</b>	Fluted Solid Wood Single Access Base	<b>\$8,475</b>
24½	24½	27⅞	129	13	<b>65T2428FCYABW</b>	Fluted Solid Wood Single Access Base	<b>\$9,686</b>

Model	Base Wood
	<a href="#">see Anthology Solid Wood Finishes</a>

**Fluted Cylinder Base Kit**

- available in fluted solid wood
- top shapes: Rectangular, Soft Rectangular, Arc Rectangular, Boat, Arc Boat and Racetrack
- planning base specification [ANPG\\_10](#)
- planning base location [ANPG\\_19](#)
- planning power guide [ANPG\\_20- ANPG\\_40](#)

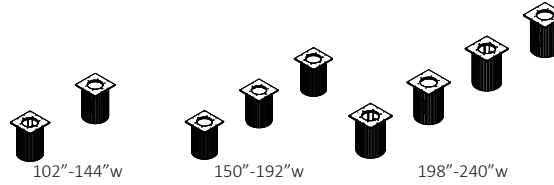

D	W	H	CTN WT	CU FT	Model	Description	List Price
<b>Fluted Cylinder Base Kit for 42/48"deep Table</b>							
19 1/8"	67 1/8"	27 7/8"	218	20	<b>65T18102FCYBW</b>	Fluted Cylinder Base Kit for 42/84"d x 102"w Top Surfaces	<b>\$15,806</b>
19 1/8"	73 1/8"	27 7/8"	218	20	<b>65T18108FCYBW</b>	Fluted Cylinder Base Kit for 42/84"d x 108"w Top Surfaces	<b>\$15,806</b>
19 1/8"	79 1/8"	27 7/8"	218	20	<b>65T18114FCYBW</b>	Fluted Cylinder Base Kit for 42/84"d x 114"w Top Surfaces	<b>\$15,806</b>
19 1/8"	85 1/8"	27 7/8"	218	20	<b>65T18120FCYBW</b>	Fluted Cylinder Base Kit for 42/84"d x 120"w Top Surfaces	<b>\$15,806</b>
<b>Fluted Cylinder Base Kit for 48"deep Table</b>							
19 1/8"	91 1/8"	27 7/8"	238	20	<b>65T18126FCYBW</b>	Fluted Cylinder Base Kit for 48"d x 126"w Top Surfaces	<b>\$15,944</b>
19 1/8"	97 1/8"	27 7/8"	238	22	<b>65T18132FCYBW</b>	Fluted Cylinder Base Kit for 48"d x 132"w Top Surfaces	<b>\$15,944</b>
19 1/8"	103 1/8"	27 7/8"	238	22	<b>65T18138FCYBW</b>	Fluted Cylinder Base Kit for 48"d x 138"w Top Surfaces	<b>\$15,944</b>
19 1/8"	109 1/8"	27 7/8"	238	22	<b>65T18144FCYBW</b>	Fluted Cylinder Base Kit for 48"d x 144"w Top Surfaces	<b>\$15,944</b>
19 1/8"	115 1/8"	27 7/8"	327	30	<b>65T18150FCYBW</b>	Fluted Cylinder Base Kit for 48"d x 150"w Top Surfaces	<b>\$23,120</b>
19 1/8"	121 1/8"	27 7/8"	327	30	<b>65T18156FCYBW</b>	Fluted Cylinder Base Kit for 48"d x 156"w Top Surfaces	<b>\$23,120</b>
19 1/8"	127 1/8"	27 7/8"	327	30	<b>65T18162FCYBW</b>	Fluted Cylinder Base Kit for 48"d x 162"w Top Surfaces	<b>\$23,120</b>
19 1/8"	133 1/8"	27 7/8"	327	30	<b>65T18168FCYBW</b>	Fluted Cylinder Base Kit for 48"d x 168"w Top Surfaces	<b>\$23,120</b>
19 1/8"	139 1/8"	27 7/8"	327	30	<b>65T18174FCYBW</b>	Fluted Cylinder Base Kit for 48"d x 174"w Top Surfaces	<b>\$23,120</b>
19 1/8"	145 1/8"	27 7/8"	347	32	<b>65T18180FCYBW</b>	Fluted Cylinder Base Kit for 48"d x 180"w Top Surfaces	<b>\$23,362</b>
19 1/8"	151 1/8"	27 7/8"	347	32	<b>65T18186FCYBW</b>	Fluted Cylinder Base Kit for 48"d x 186"w Top Surfaces	<b>\$23,362</b>
19 1/8"	157 1/8"	27 7/8"	347	32	<b>65T18192FCYBW</b>	Fluted Cylinder Base Kit for 48"d x 192"w Top Surfaces	<b>\$23,362</b>
19 1/8"	163 1/8"	27 7/8"	328	40	<b>65T18198FCYBW</b>	Fluted Cylinder Base Kit for 48"d x 198"w Top Surfaces	<b>\$31,199</b>
19 1/8"	169 1/8"	27 7/8"	328	40	<b>65T18204FCYBW</b>	Fluted Cylinder Base Kit for 48"d x 204"w Top Surfaces	<b>\$31,199</b>
19 1/8"	175 1/8"	27 7/8"	328	40	<b>65T18210FCYBW</b>	Fluted Cylinder Base Kit for 48"d x 210"w Top Surfaces	<b>\$31,199</b>
19 1/8"	181 1/8"	27 7/8"	328	40	<b>65T18216FCYBW</b>	Fluted Cylinder Base Kit for 48"d x 216"w Top Surfaces	<b>\$31,199</b>
19 1/8"	187 1/8"	27 7/8"	348	42	<b>65T18222FCYBW</b>	Fluted Cylinder Base Kit for 48"d x 222"w Top Surfaces	<b>\$31,543</b>
19 1/8"	193 1/8"	27 7/8"	348	42	<b>65T18228FCYBW</b>	Fluted Cylinder Base Kit for 48"d x 228"w Top Surfaces	<b>\$31,543</b>
19 1/8"	199 1/8"	27 7/8"	348	42	<b>65T18234FCYBW</b>	Fluted Cylinder Base Kit for 48"d x 234"w Top Surfaces	<b>\$31,543</b>
19 1/8"	205 1/8"	27 7/8"	348	42	<b>65T18240FCYBW</b>	Fluted Cylinder Base Kit for 48"d x 240"w Top Surfaces	<b>\$31,543</b>

**Model Base Wood**

[see Anthology Solid Wood Finishes](#)

**Fluted Cylinder Base Kit**

- available in fluted solid wood
- top shapes: Rectangular, Soft Rectangular, Arc Rectangular, Boat, Arc Boat and Racetrack
- planning base specification [ANPG\\_10](#)
- planning base location [ANPG\\_19](#)
- planning power guide [ANPG\\_20- ANPG\\_40](#)

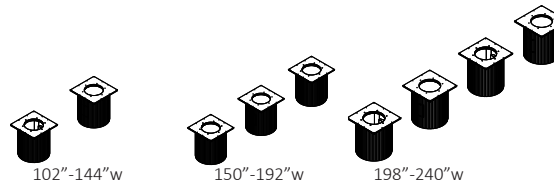

D	W	H	CTN WT	CU FT	Model	Description	List Price
<b>Fluted Cylinder Base Kit for 54/60"deep Table</b>							
24%	90%	27%	78	26	<b>65T24120FCYBW</b>	Fluted Cylinder Base Kit for 54/60"d x 120"w Top Surfaces	<b>\$18,194</b>
24%	96%	27%	98	28	<b>65T24126FCYBW</b>	Fluted Cylinder Base Kit for 54/60"d x 126"w Top Surfaces	<b>\$18,333</b>
24%	102%	27%	98	28	<b>65T24132FCYBW</b>	Fluted Cylinder Base Kit for 54/60"d x 132"w Top Surfaces	<b>\$18,333</b>
24%	108%	27%	98	28	<b>65T24138FCYBW</b>	Fluted Cylinder Base Kit for 54/60"d x 138"w Top Surfaces	<b>\$18,333</b>
24%	114%	27%	98	28	<b>65T24144FCYBW</b>	Fluted Cylinder Base Kit for 54/60"d x 144"w Top Surfaces	<b>\$18,333</b>
24%	120%	27%	99	39	<b>65T24150FCYBW</b>	Fluted Cylinder Base Kit for 54/60"d x 150"w Top Surfaces	<b>\$26,728</b>
24%	126%	27%	99	39	<b>65T24156FCYBW</b>	Fluted Cylinder Base Kit for 54/60"d x 156"w Top Surfaces	<b>\$26,728</b>
24%	132%	27%	99	39	<b>65T24162FCYBW</b>	Fluted Cylinder Base Kit for 54/60"d x 162"w Top Surfaces	<b>\$26,728</b>
24%	138%	27%	99	39	<b>65T24168FCYBW</b>	Fluted Cylinder Base Kit for 54/60"d x 168"w Top Surfaces	<b>\$26,728</b>
24%	144%	27%	99	39	<b>65T24174FCYBW</b>	Fluted Cylinder Base Kit for 54/60"d x 174"w Top Surfaces	<b>\$26,728</b>
24%	150%	27%	119	41	<b>65T24180FCYBW</b>	Fluted Cylinder Base Kit for 54/60"d x 180"w Top Surfaces	<b>\$26,971</b>
24%	156%	27%	119	41	<b>65T24186FCYBW</b>	Fluted Cylinder Base Kit for 54/60"d x 186"w Top Surfaces	<b>\$26,971</b>
24%	162%	27%	119	41	<b>65T24192FCYBW</b>	Fluted Cylinder Base Kit for 54/60"d x 192"w Top Surfaces	<b>\$26,971</b>
24%	168%	27%	132	52	<b>65T24198FCYBW</b>	Fluted Cylinder Base Kit for 54/60"d x 198"w Top Surfaces	<b>\$36,028</b>
24%	174%	27%	132	52	<b>65T24204FCYBW</b>	Fluted Cylinder Base Kit for 54/60"d x 204"w Top Surfaces	<b>\$36,028</b>
24%	180%	27%	132	52	<b>65T24210FCYBW</b>	Fluted Cylinder Base Kit for 54/60"d x 210"w Top Surfaces	<b>\$36,028</b>
24%	186%	27%	132	52	<b>65T24216FCYBW</b>	Fluted Cylinder Base Kit for 54/60"d x 216"w Top Surfaces	<b>\$36,028</b>
24%	192%	27%	152	54	<b>65T24222FCYBW</b>	Fluted Cylinder Base Kit for 54/60"d x 222"w Top Surfaces	<b>\$36,372</b>
24%	198%	27%	152	54	<b>65T24228FCYBW</b>	Fluted Cylinder Base Kit for 54/60"d x 228"w Top Surfaces	<b>\$36,372</b>
24%	204%	27%	152	54	<b>65T24234FCYBW</b>	Fluted Cylinder Base Kit for 54/60"d x 234"w Top Surfaces	<b>\$36,372</b>
24%	210%	27%	152	54	<b>65T24240FCYBW</b>	Fluted Cylinder Base Kit for 54/60"d x 240"w Top Surfaces	<b>\$36,372</b>

**Model Base Wood**

[see Anthology Solid Wood Finishes](#)

Description	D	W	H	CTN WT	CU FT	① Model	List Price
<b>Flexible Wire Manager</b>	1 3/4	5 3/4	1 3/8			<b>9P26FWM</b>	<b>\$31</b>

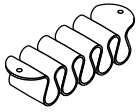

- black
- mounts to underside of top to support cords

<b>Frame Base Magnetic Metal Wire Manager</b>						<b>65T22WMM</b>	<b>\$248</b>
---	--	--	--	--	--	-----------------	--------------



- use with Frame and Frame BridgeLine bases only
- magnetic attachment to inside of base frame over cords to floor
- specify metal base colors

<b>Wire Management Velcro Straps (set of 4)</b>	1 3/4	3 1/2	1/4			<b>04WVS</b>	<b>\$61</b>
---	-------	-------	-----	--	--	--------------	-------------

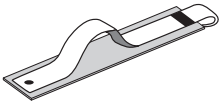

- set of four
- field installed with adhesive tape provided
- mounts under surface or on vertical panels
- black

<b>TFL Wire Management Chase</b>	7	7	27 7/8			<b>65T728WCT</b>	<b>\$1,095</b>
----------------------------------	---	---	--------	--	--	------------------	----------------

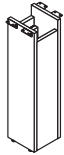

- mounts to underside of table top to conceal cords to floor outlet
- can be specified between bases where cord concealment to floor is required
- not for structural support

Description	D	W	H	CTN WT	CU FT	① Model	Essentials Veneer	Artisan Veneer
<b>Veneer Wire Management Chase</b>	7	7	27 7/8			<b>65T728WCV</b>	<b>\$1,125</b>	<b>\$1,238</b>

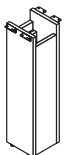

- mounts to underside of table top to conceal cords to floor outlet
- can be specified between bases where cord concealment to floor is required
- not for structural support

Model	Laminate for Wire Chase	Veneer for Wire Chase	Metal Color
	<a href="#">see Anthology Laminate Finishes</a>	<a href="#">see Anthology Veneer Finishes</a>	<a href="#">see Anthology Metal Colors</a>

Description	D	W	H	CTN WT	CU FT	① Model	List Price
<b>Node Electrical Single Unit Power + Open - Corded</b>	4	4	3 ¼	3	1	<b>9PCA1C</b>	<b>\$265</b>

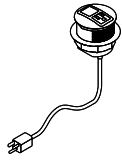

- flush mount design with one spill-proof black power outlet
- one open data port, 12 pack data adapter kit included. Accepts TCP300 series Telecom ports ordered separately
- 10' cord with 15 amp three-prong molded plug
- powdercoat aluminum
- UL listed

<b>Node Electrical Single Unit Power - Corded</b>	4	4	3 ¼	3	1	<b>9PCA2C</b>	<b>\$274</b>
---	---	---	-----	---	---	---------------	--------------

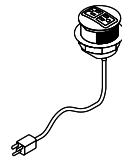

- flush mount design with two spill-proof, black power outlets
- 10' cord with 15 amp three-prong molded plug
- powdercoat aluminum
- UL listed

<b>Node Electrical Single Unit Power + USB - Corded</b>	4	4	3 ¼	3	1	<b>9PCA11C</b>	<b>\$405</b>
---	---	---	-----	---	---	----------------	--------------

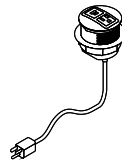

- flush mount design with one power and one 20 watt USB A+C (10 watt each)
- spill-proof design, black outlets
- 10' cord with 15 amp three-prong molded plug
- powdercoat aluminum
- UL listed

<b>Electrolite Electrical Single Unit Power + USB - Corded</b>	2 ½	7 ¾	3 ¾	4	1	<b>9PCB21C</b>	<b>\$689</b>
--	-----	-----	-----	---	---	----------------	--------------

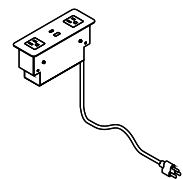

- In-Surface flush mount design with two power and one 72 watt USB A (12 watt) + C (60 watt)
- tamper resistant, black outlets
- 9' strain relief cord with 15 amp three-prong molded plug
- available in black body and face only
- ETL listed

**Model Metal Finish**

- B Black
- S Silver



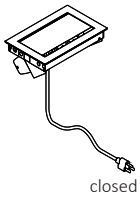

closed

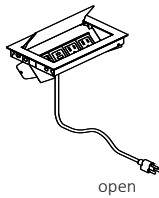

open

- In-Surface Aluminum frame with soft closing lid and cord routing slot
- 4 port unit with two power, one 20 watt USB A+C (10 watt each), and one open data port
- open port accepts TCP300 series Telecom ports ordered separately. 12 pack data adapter kit included
- 10' cord with 15 amp three-prong molded plug
- powdercoat aluminum frame and lid
- inside face plate and power/data outlets are black
- UL Listed

D	W	H	CTN WT	CU FT	① Model	Description	List Price
5 3/8	8 3/8	3 1/2	3	1	<b>9PCD21C</b>	Ellora Electrical Single Unit, Single Sided Power + USB - Corded	<b>\$678</b>

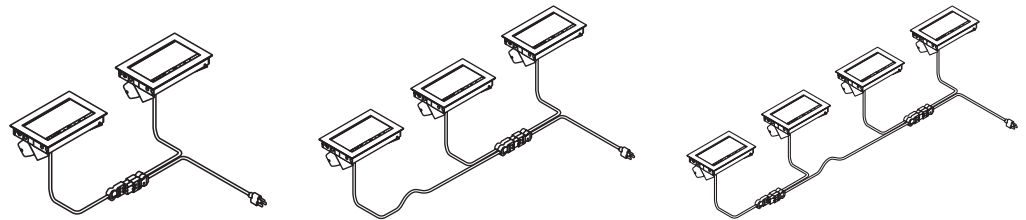

**Pattern Modular Component System with Ellora One Sided Power Units**

- available in 2-, 3-, and 4-unit kit models which include all components required: Ellora In-Surface Aluminum frame with soft closing lid and cord routing slot power units, single end power infeed, jumpers, distribution block, and mounting hardware
- Pattern Single Circuit Linking Power System is non-sequential and supports multiple Ellora units connected with one 10' cord and 15 amp molded plug
- each individual power unit features two power, one 20 watt USB A+C (10 watt each), and one open data port. Open port accepts TCP300 series Telecom ports ordered separately. 12 pack data adapter kit included
- powdercoat Aluminum; inside face plate and power/data outlets are black
- ETL Listed modular solution
- specify the model for number of kits, top width range and cutout locations to provide required jumper lengths and connection components

D	W	H	CTN WT	CU FT	① Model	Description	List Price
<b>End Location</b>							
5 3/8	8 3/8	3 1/2	3	1	<b>9PCD21K2EAC</b>	Ellora Electrical 2 Unit Kit, Single Sided Power + USB- Corded, for 84- 114 Surfaces	<b>\$2,052</b>
5 3/8	8 3/8	3 1/2	3	1	<b>9PCD21K2EBC</b>	Ellora Electrical 2 Unit Kit, Single Sided Power + USB- Corded, for 120- 174 Surfaces	<b>\$2,176</b>
5 3/8	8 3/8	3 1/2	3	1	<b>9PCD21K2ECC</b>	Ellora Electrical 2 Unit Kit, Single Sided Power + USB- Corded, for 180- 192 Surfaces	<b>\$2,119</b>
5 3/8	8 3/8	3 1/2	3	1	<b>9PCD21K2EDC</b>	Ellora Electrical 2 Unit Kit, Single Sided Power + USB- Corded, for 198- 240 Surfaces	<b>\$2,165</b>
<b>Mid Location</b>							
5 3/8	8 3/8	3 1/2	3	1	<b>9PCD21K2MBC</b>	Ellora Electrical 2 Unit Kit, Single Sided Power + USB- Corded, for 120- 174 Surfaces	<b>\$2,080</b>
5 3/8	8 3/8	3 1/2	3	1	<b>9PCD21K2MCC</b>	Ellora Electrical 2 Unit Kit, Single Sided Power + USB- Corded, for 180- 192 Surfaces	<b>\$2,204</b>
5 3/8	8 3/8	3 1/2	3	1	<b>9PCD21K2MDC</b>	Ellora Electrical 2 Unit Kit, Single Sided Power + USB- Corded, for 198- 240 Surfaces	<b>\$2,165</b>
<b>Center + End Location</b>							
5 3/8	8 3/8	3 1/2	3	1	<b>9PCD21K3CEBC</b>	Ellora Electrical 3 Unit Kit, Single Sided Power + USB- Corded, for 120- 174 Surfaces	<b>\$2,932</b>
5 3/8	8 3/8	3 1/2	3	1	<b>9PCD21K3CECC</b>	Ellora Electrical 3 Unit Kit, Single Sided Power + USB- Corded, for 180- 192 Surfaces	<b>\$2,932</b>
5 3/8	8 3/8	3 1/2	3	1	<b>9PCD21K3CEDC</b>	Ellora Electrical 3 Unit Kit, Single Sided Power + USB- Corded, for 198- 240 Surfaces	<b>\$3,080</b>
<b>Center + Mid Location</b>							
5 3/8	8 3/8	3 1/2	3	1	<b>9PCD21K3CMDC</b>	Ellora Electrical 3 Unit Kit, Single Sided Power + USB- Corded, for 198- 240 Surfaces	<b>\$2,946</b>
<b>Mid + End Location</b>							
5 3/8	8 3/8	3 1/2	3	1	<b>9PCD21K4MEDC</b>	Ellora Electrical 4 Unit Kit, Single Sided Power + USB- Corded, for 198- 240 Surfaces	<b>\$3,804</b>

Model	Metal Finish
B	Black
S	Silver

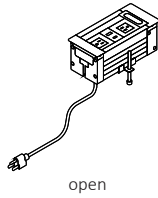
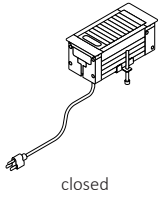

- In-surface with sliding, retractable door to access outlets
- two power, one USB A (10 watt) + C (15 watt)
- 10' cord with 15 amp three-prong molded plug
- black trim with gray retractable door and black outlet face
- ETL Listed

D	W	H	CTN WT	CU FT	① Model	Description	List Price
3½	8½	5	3	1	<b>9PCE21C</b>	Vault Z23 Electrical Single Unit, Retractable Door Power + USB- Corded	<b>\$677</b>

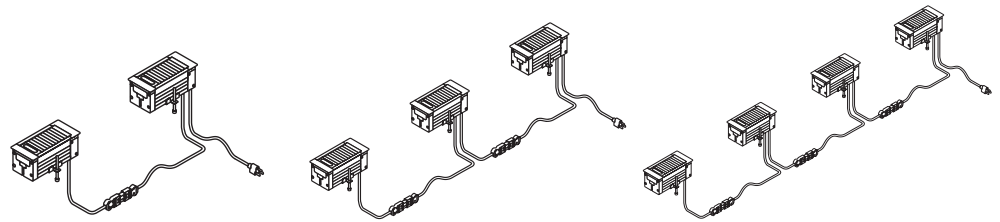

**Modular Connection System with Vault Z23 Retractable Power Units**

- available in 2-, 3-, and 4-unit kit models which include all connection required: Z23 In-Surface with sliding retractable door, single end power infeed, jumpers and mounting hardware
- Sequential single circuit connection kit supports multiple Z23 units connected with one 9' cord and 15 amp molded plug
- Each individual power unit features two power, one USB A (10 watt) + C (15 watt)
- Black trim with dark gray retractable door and black outlet face
- ETL Listed modular solution
- specify the model for number of kits, top width range and cutout locations to provide required jumper lengths and connection components

D	W	H	CTN WT	CU FT	① Model	Description	List Price
<b>End Location</b>							
3½	8½	5	3	1	<b>9PCE21K2EAC</b>	Vault Z23 Electrical 2 Unit Kit, Retractable Door Power + USB- Corded for 84- 114 Surfaces	<b>\$1,235</b>
<b>Mid Location</b>							
3½	8½	5	3	1	<b>9PCE21K2MBC</b>	Vault Z23 Electrical 2 Unit Kit, Retractable Door Power + USB- Corded for 120- 174 Surfaces	<b>\$1,235</b>
<b>Center + End Location</b>							
3½	8½	5	3	1	<b>9PCE21K3CEAC</b>	Vault Z23 Electrical 3 Unit Kit, Retractable Door Power + USB- Corded for 102- 114 Surfaces	<b>\$1,762</b>
3½	8½	5	3	1	<b>9PCE21K3CEBC</b>	Vault Z23 Electrical 3 Unit Kit, Retractable Door Power + USB- Corded for 120- 174 Surfaces	<b>\$1,762</b>
<b>Center + Mid Location</b>							
3½	8½	5	3	1	<b>9PCE21K3CMDC</b>	Vault Z23 Electrical 3 Unit Kit, Retractable Door Power + USB- Corded for 198- 234 Surfaces	<b>\$1,762</b>
<b>Mid + End Location</b>							
3½	8½	5	3	1	<b>9PCE21K4MEDC</b>	Vault Z23 Electrical 4 Unit Kit, Retractable Door Power + USB- Corded for 198- 234 Surfaces	<b>\$2,290</b>

Model

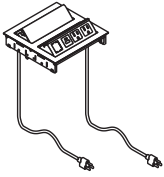

- two-Sided, In-Surface Aluminum frame with retractable one touch doors
- each side has 4 ports with two power, one 20 watt USB A+C (10 watt each), and one open data port
- unit total is four power, two 20 watt USB A+C (10 watt each) and two open data ports
- 12 pack data adapter kit included. Open ports accept TCP300 series Telecom ports ordered separately
- two 10' cord with 15 amp three-prong molded plug, one per side
- powdercoat Aluminum frame
- inside face plate and power/data outlets are black
- UL Listed

D	W	H	CTN WT	CU FT	① Model	Description	List Price
8 1/8	8 1/4	1 1/2	6	1	<b>9PCF42C</b>	M2X Electrical Single Unit, Two Sided Power + USB- Corded	<b>\$1,189</b>

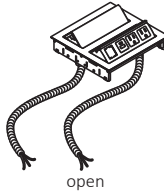
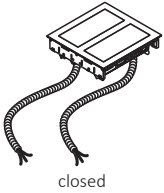

- two-Sided, In-Surface Aluminum frame with retractable one touch doors
- each side has 4 ports with two power, one 20 watt USB A+C (10 watt each), and one open data port
- unit total is four power, two 20 watt USB A+C (10 watt each) and two open data ports
- 12 pack data adapter kit included. Open ports accept TCP300 series Telecom ports ordered separately
- two 10' Chicago hardwire, one per side
- powdercoat Aluminum frame
- inside face plate and power/data outlets are black
- UL Listed

D	W	H	CTN WT	CU FT	① Model	Description	List Price
8 1/8	8 1/4	1 1/2	9	1	<b>9PCF42H</b>	M2X Electrical Single Unit, Two Sided Power + USB- Hardwire	<b>\$1,361</b>

Model	Metal Finish
B	Black
S	Silver

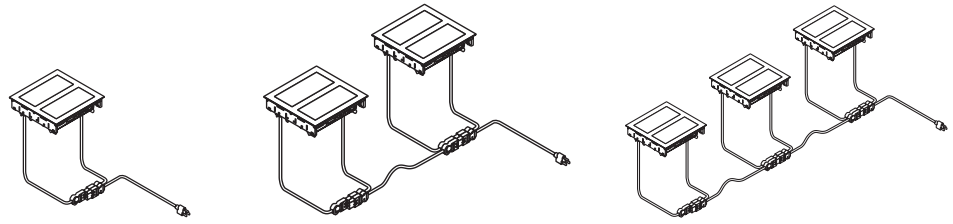

**Pattern Modular Component System with M2X Two Sided Power Units**

- available in 1-, 2-, and 3-unit kit models which include all components required: M2X In-Surface aluminum frame with retractable one touch doors, single end power infeed, jumpers, distribution block, and mounting hardware
- Pattern Single Circuit Linking Power System is non-sequential and supports multiple M2X units connected with one 10' cord and 15 amp molded plug
- each individual power unit features four power, two 20 watt USB A+C (10 watt each) and two open data port
- 12 pack data adapter kit included. Open port accepts TCP300 series Telecom ports ordered separately
- powdercoat aluminum. Inside face plate and power/data outlets are black
- ETL Listed modular solution
- specify the model for number of kits, top width range and cutout locations to provide required jumper lengths and connection components

D	W	H	CTN WT	CU FT	① Model	Description	List Price
<b>Center Location</b>							
8 1/8	8 1/4	1 1/2	6	1	<b>9PCF42K1C</b>	M2X Electrical 1 Unit Kit, Two Sided Power + USB- Hardware	<b>\$1,854</b>
<b>End Location</b>							
8 1/8	8 1/4	1 1/2	6	1	<b>9PCF42K2EBC</b>	M2X Electrical 2 Unit Kit, Two Sided Power + USB- Corded for 120- 174 Surfaces	<b>\$3,345</b>
8 1/8	8 1/4	1 1/2	6	1	<b>9PCF42K2ECC</b>	M2X Electrical 2 Unit Kit, Two Sided Power + USB- Corded for 180- 192 Surfaces	<b>\$3,374</b>
8 1/8	8 1/4	1 1/2	6	1	<b>9PCF42K2EDC</b>	M2X Electrical 2 Unit Kit, Two Sided Power + USB- Corded for 198- 240 Surfaces	<b>\$3,462</b>
<b>Mid Location</b>							
8 1/8	8 1/4	1 1/2	6	1	<b>9PCF42K2MBC</b>	M2X Electrical 2 Unit Kit, Two Sided Power + USB- Corded for 120- 174 Surfaces	<b>\$3,250</b>
8 1/8	8 1/4	1 1/2	6	1	<b>9PCF42K2MCC</b>	M2X Electrical 2 Unit Kit, Two Sided Power + USB- Corded for 180- 192 Surfaces	<b>\$3,289</b>
8 1/8	8 1/4	1 1/2	6	1	<b>9PCF42K2MDC</b>	M2X Electrical 2 Unit Kit, Two Sided Power + USB- Corded for 198- 240 Surfaces	<b>\$3,359</b>
<b>Center + End Location</b>							
8 1/8	8 1/4	1 1/2	6	1	<b>9PCF42K3CEBC</b>	M2X Electrical 3 Unit Kit, Two Sided Power + USB- Corded for 120- 174 Surfaces	<b>\$4,589</b>
8 1/8	8 1/4	1 1/2	6	1	<b>9PCF42K3CECC</b>	M2X Electrical 3 Unit Kit, Two Sided Power + USB- Corded for 180- 192 Surfaces	<b>\$4,720</b>
8 1/8	8 1/4	1 1/2	6	1	<b>9PCF42K3CEDC</b>	M2X Electrical 3 Unit Kit, Two Sided Power + USB- Corded for 198- 240 Surfaces	<b>\$4,730</b>
<b>Center + Mid Location</b>							
8 1/8	8 1/4	1 1/2	6	1	<b>9PCF42K3CMDC</b>	M2X Electrical 3 Unit Kit, Two Sided Power + USB- Corded for 198- 240 Surfaces	<b>\$4,680</b>

**Model | Metal Finish**

- B** Black
- S** Silver

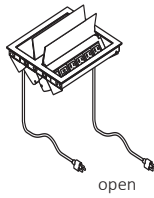
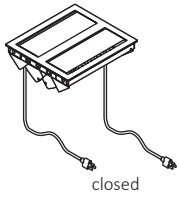

- two-Sided, In-Surface Aluminum frame with soft closing lid and cord routing slot
- each side has 6 ports with four power, one 20 watt USB A+C (10 watt each) and one open data port
- unit total is eight power, two 20 watt USB A+C (10 watt each), and two open data ports
- 12 pack data adapter kit included. Open ports accept TCP300 series Telecom ports ordered separately
- two 10' cord with 15 amp three-prong molded plug, one per side
- powdercoat Aluminum frame and lid
- inside face plate and power/data outlets are black
- UL Listed

D	W	H	CTN WT	CU FT	① Model	Description	List Price
10 ¼	11 ¾	3 ½	9	1	<b>9PCG82C</b>	Ellora Double Electrical Single Unit, Two Sided Power + USB- Corded	<b>\$1,651</b>

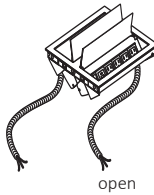
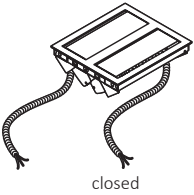

- two-Sided, In-Surface Aluminum frame with soft closing lid and cord routing slot
- each side has 6 ports with four power, one 20 watt USB A+C (10 watt each) and one open data port
- unit total is eight power, two 20 watt USB A+C (10 watt each) and two open data ports
- 12 pack data adapter kit included. Open ports accept TCP300 series Telecom ports ordered separately
- two 10' Chicago hardwire, one per side
- powdercoat Aluminum frame and lid
- inside face plate and power/data outlets are black
- UL Listed

D	W	H	CTN WT	CU FT	① Model	Description	List Price
10 ¼	11 ¾	3 ½	12	1	<b>9PCG82H</b>	Ellora Double Electrical Single Unit, Two Sided Power + USB- Hardwire	<b>\$1,664</b>

**Model** | **Metal Finish**

- B** Black
- S** Silver

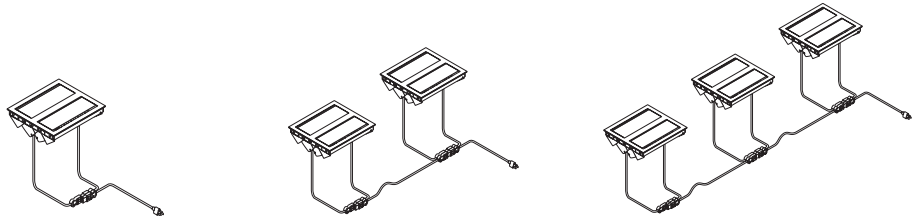

**Pattern Modular Component System with Ellora Double Power Units**

- available in 1-, 2- , and 3-unit kit models which include all components required: Ellora Double In-Surface Aluminum frame with soft closing lid and cord routing slot power units, single end power infeed, jumpers, distribution block, and mounting hardware
- Pattern Single Circuit Linking Power System is non-sequential and supports multiple Ellora Double units connected with one 10’ cord and 15 amp molded plug
- each individual power unit features eight power, two 20 watt USB A+C (10 watt each) and two open data port. 12 pack data adapter kit included. Open port accepts TCP300 series Telecom ports ordered separately
- powdercoat aluminum. Inside face plate and power/data outlets are black
- ETL Listed modular solution
- specify the model for number of kits, top width range and cutout locations to provide required jumper lengths and connection components lengths and connection components

D	W	H	CTN WT	CU FT	① Model	Description	List Price
<b>Center Location</b>							
10 ¼	11 ¾	3 ½	9	1	<b>9PCG82K1C</b>	Ellora Double Electrical 1 Unit Kit, Two Sided Power + USB- Corded	<b>\$2,393</b>
<b>End Location</b>							
10 ¼	11 ¾	3 ½	9	1	<b>9PCG82K2EBC</b>	Ellora Double Electrical 2 Unit Kit, Two Sided Power + USB- Corded for 120- 174 Surfaces	<b>\$4,006</b>
10 ¼	11 ¾	3 ½	9	1	<b>9PCG82K2ECC</b>	Ellora Double Electrical 2 Unit Kit, Two Sided Power + USB- Corded for 180- 192 Surfaces	<b>\$4,106</b>
10 ¼	11 ¾	3 ½	9	1	<b>9PCG82K2EDC</b>	Ellora Double Electrical 2 Unit Kit, Two Sided Power + USB- Corded for 198- 240 Surfaces	<b>\$4,206</b>
<b>Mid Location</b>							
10 ¼	11 ¾	3 ½	9	1	<b>9PCG82K2MBC</b>	Ellora Double Electrical 2 Unit Kit, Two Sided Power + USB- Corded, for 120- 174 Surfaces	<b>\$4,006</b>
10 ¼	11 ¾	3 ½	9	1	<b>9PCG82K2MCC</b>	Ellora Double Electrical 2 Unit Kit, Two Sided Power + USB- Corded, for 180- 192 Surfaces	<b>\$4,106</b>
10 ¼	11 ¾	3 ½	9	1	<b>9PCG82K2MDC</b>	Ellora Double Electrical 2 Unit Kit, Two Sided Power + USB- Corded, for 198- 240 Surfaces	<b>\$4,206</b>
<b>Center + Ends Location</b>							
10 ¼	11 ¾	3 ½	9	1	<b>9PCG82K3CEBC</b>	Ellora Double Electrical 3 Unit Kit, Two Sided Power + USB- Corded, for 120- 174 Surfaces	<b>\$6,308</b>
10 ¼	11 ¾	3 ½	9	1	<b>9PCG82K3CECC</b>	Ellora Double Electrical 3 Unit Kit, Two Sided Power + USB- Corded, for 180- 192 Surfaces	<b>\$6,336</b>
10 ¼	11 ¾	3 ½	9	1	<b>9PCG82K3CEDC</b>	Ellora Double Electrical 3 Unit Kit, Two Sided Power + USB- Corded, for 198- 240 Surfaces	<b>\$6,432</b>
<b>Center + Mid Location</b>							
10 ¼	11 ¾	3 ½	9	1	<b>9PCG82K3CMDC</b>	Ellora Double Electrical 3 Unit Kit, Two Sided Power + USB- Corded, for 198- 240 Surfaces	<b>\$6,301</b>

**Model Metal Finish**

- B** Black
- S** Silver

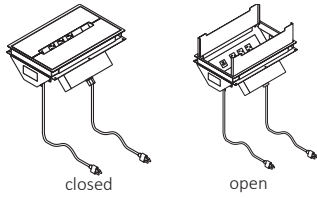

- In-Surface with metal hinged lids that flip up from center and cord routing slots when closed
- six power (three per face), two 72 watt USB A(12 watt) + C(60 watt). Two faceplate openings (one each end). Open ports accept TCP100 Telecom ports ordered separately. Data adapter kit included
- tamper resistant
- two 9' cords with 15 amp three-prong molded plug
- available in seven standard exterior trim finishes with interior and outlet faces in black
- UL Listed

D	W	H	CTN WT	CU FT	① Model	Description	List Price
9	14 3/8	5 1/8	9	1	<b>9PCH62C</b>	Oasis Electrical Single Unit, Two Sided Power + USB- Corded	<b>\$1,712</b>

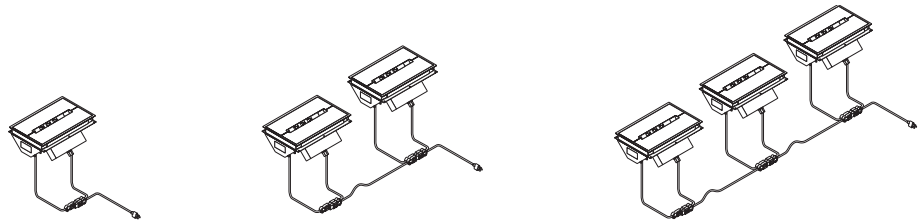

**PURL Modular Component System with Oasis Power Units**

- available in 1-, 2-, and 3-unit kit models which include all components required: Oasis In-Surface power units, single end power infeed, jumpers, splitters and mounting hardware
- PURL Single Circuit Linking Power System is non-sequential and supports multiple Oasis power units connected with one 9' cord and 15 amp molded plug
- each individual power unit features six power (three per face), two 72 watt USB A(12 watt) + C(60 watt). Two faceplate openings (one each end). Open ports accept TCP100 series Telecom ports ordered separately.
- available in seven standard exterior trim finishes with interior and outlet faces in black
- UL Listed modular solution
- specify the model for number of kits, top width range and cutout locations to provide required jumper lengths and connection components lengths and connection components

D	W	H	CTN WT	CU FT	① Model	Description	List Price
<b>Center Location</b>							
9	14 3/8	5 1/8	9	1	<b>9PCH62K1C</b>	Oasis Electrical 1 Unit Kit, Two Sided Power + USB- Corded	<b>\$1,875</b>
<b>Mid Location</b>							
9	14 3/8	5 1/8	9	1	<b>9PCH62K2MBC</b>	Oasis Electrical 2 Unit Kit, Two Sided Power + USB- Corded, for 120- 174 Surfaces	<b>\$3,393</b>
9	14 3/8	5 1/8	9	1	<b>9PCH62K2MCC</b>	Oasis Electrical 2 Unit Kit, Two Sided Power + USB- Corded, for 180- 192 Surfaces	<b>\$3,376</b>
9	14 3/8	5 1/8	9	1	<b>9PCH62K2MDC</b>	Oasis Electrical 2 Unit Kit, Two Sided Power + USB- Corded, for 198- 240 Surfaces	<b>\$3,395</b>
<b>Center + Mid Location</b>							
9	14 3/8	5 1/8	9	1	<b>9PCH62K3CMDC</b>	Oasis Electrical 3 Unit Kit, Two Sided Power + USB- Corded, for 198- 240 Surfaces	<b>\$4,663</b>

**Model | Metal Finish**

<b>ABZ</b>	Aged Bronze
<b>ASL</b>	Arctic Silver
<b>GLD</b>	Gold
<b>MBK</b>	Matte Black
<b>PEW</b>	Pewter
<b>SBZ</b>	Soft Bronze
<b>SNK</b>	Soft Nickel

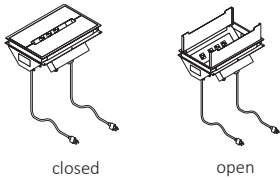

- In-Surface with metal hinged lids that flip up from center and cord routing slot when closed
- eight power (four per face), two faceplate openings (one each end). Open ports accept TCP100 series Telecom ports ordered separately. Data adapter kit included
- tamper resistant
- one 9' cord with 15 amp three-prong molded plug
- available in seven standard exterior trim finishes with interior and outlet faces in black
- UL Listed

D	W	H	CTN WT	CU FT	① Model	Description	List Price
9	14 3/8	5 1/8	9	1	<b>9PCH8C</b>	<b>Oasis Electrical Single Unit, Two Sided Power - Corded</b>	<b>\$1,495</b>

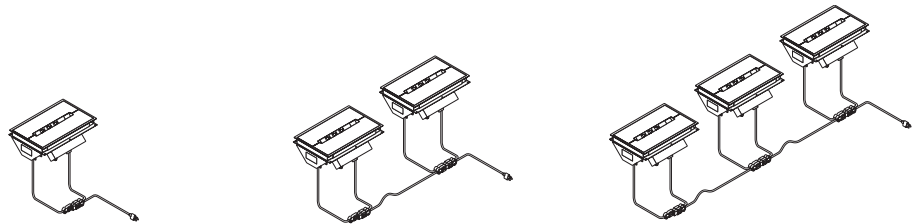

**PURL Modular Component System with Oasis Power Units**

- available in 1-, 2-, and 3-unit kit models which include all components required: Oasis In-Surface power units, single end power infeed, jumpers, splitters and mounting hardware.
- PURL Single Circuit Linking Power System is non-sequential and supports multiple Oasis power units connected with one 9' cord and 15 amp molded plug
- each individual power unit features eight power (four per face), two faceplate openings (one each end). Open ports accept TCP100 series Telecom ports ordered separately.
- available in seven standard exterior trim finishes with interior and outlet faces in black
- UL Listed modular solution
- specify the model for number of kits, top width range and cutout locations to provide required jumper lengths and connection components lengths and connection components

D	W	H	CTN WT	CU FT	① Model	Description	List Price
<b>Center Location</b>							
9	14 3/8	5 1/8	9	1	<b>9PCH8K1C</b>	Oasis Electrical 1 Unit Kit, Two Sided Power- Corded	<b>\$1,657</b>
<b>Mid Location</b>							
9	14 3/8	5 1/8	9	1	<b>9PCH8K2MBC</b>	Oasis Electrical 2 Unit Kit, Two Sided Power- Corded, for 120- 174 Surfaces	<b>\$2,885</b>
9	14 3/8	5 1/8	9	1	<b>9PCH8K2MCC</b>	Oasis Electrical 2 Unit Kit, Two Sided Power- Corded, for 180- 192 Surfaces	<b>\$3,031</b>
9	14 3/8	5 1/8	9	1	<b>9PCH8K2MDC</b>	Oasis Electrical 2 Unit Kit, Two Sided Power- Corded, for 180- 192 Surfaces	<b>\$2,963</b>
<b>Center + Mid Location</b>							
9	14 3/8	5 1/8	9	1	<b>9PCH8K3CMDC</b>	Oasis Electrical 3 Unit Kit, Two Sided Power- Corded, for 198- 240 Surfaces	<b>\$4,010</b>

**Model | Metal Finish**

- ABZ Aged Bronze
- ASL Arctic Silver
- GLD Gold
- MBK Matte Black
- PEW Pewter
- SBZ Soft Bronze
- SNK Soft Nickel



Description	D	W	H	CTN WT	CU FT	Model	List Price
<b>Vault BTC Electrical Single Unit, Rotating Power + USB + HDMI - Corded</b>	4 1/4	16	5	7	1	<b>9PCJ321C</b>	<b>\$1,678</b>

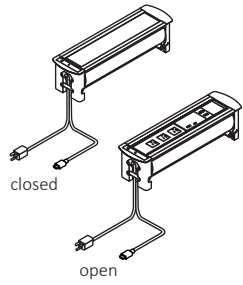

- In-Surface, one touch open to close mechanism, 180 degree motorized pivot rotation
- safety stop rotation sensors prevent closure when outlets in use or obstruction detected
- three power, one USB A (15 watt) + C (45 watt), one HDMI, plus one 15-watt USB-A
- 12' cord with 15 amp three-prong molded plug
- anodized aluminum with black outlet face
- UL Listed

---

Model

---

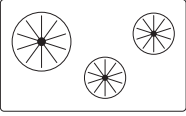
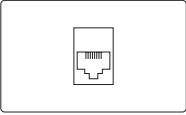
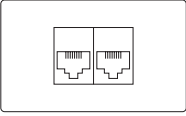
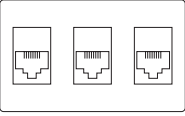
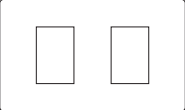
Description	D	W	H	CTN WT	CU FT	Model	List Price
<b>Blank Cap Data Plate, Type 1</b>  <ul style="list-style-type: none"> <li>• blank data plate</li> <li>• black</li> <li>• for use with Oasis power units</li> </ul>		1 3/4	3 1/8			<b>TCP101</b>	<b>\$18</b>
<b>Three Cord Bushing Data Plate, Type 1</b>  <ul style="list-style-type: none"> <li>• cord minder- three cord bushing</li> <li>• black</li> <li>• for use with Oasis power units</li> </ul>		1 3/4	3 1/8			<b>TCP102</b>	<b>\$83</b>
<b>One Jack Data Plate, Type 1</b>  <ul style="list-style-type: none"> <li>• one RJ-45 CAT6 Jack</li> <li>• black</li> <li>• for use with Oasis power units</li> </ul>		1 3/4	3 1/8			<b>TCP104</b>	<b>\$104</b>
<b>Two Jack Data Plate, Type 1</b>  <ul style="list-style-type: none"> <li>• two RJ-45 CAT6 Jacks</li> <li>• black</li> <li>• for use with Oasis power units</li> </ul>		1 3/4	3 1/8			<b>TCP105</b>	<b>\$175</b>
<b>Three Jack Data Plate, Type 1</b>  <ul style="list-style-type: none"> <li>• three RJ-45 CAT6 Jacks</li> <li>• black</li> <li>• for use with Oasis power units</li> </ul>		1 3/4	3 1/8			<b>TCP106</b>	<b>\$246</b>
<b>Two Open Data Ports, Type 1</b>  <ul style="list-style-type: none"> <li>• use with two Type 3 Telecom Jacks</li> <li>• black</li> <li>• for use with Oasis power units</li> </ul>		1 3/4	3 1/8			<b>TCP110</b>	<b>\$18</b>

Model

Description	D	W	H	CTN WT	CU FT	① Model	List Price
<b>HDMI Data Plate, Type 1</b>		1 3/4	3 1/8			<b>TCP107</b>	<b>\$232</b>

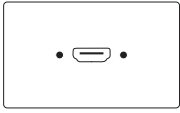

- one HDMI female to female connection with 36" cord
- black
- for use with Oasis power units

<b>HDMI and Data Jack Plate, Type 1</b>		1 3/4	3 1/8			<b>TCP113</b>	<b>\$272</b>
---	--	-------	-------	--	--	---------------	--------------

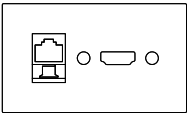

- one HDMI female to female connection with 36" cord one RJ45 CAT6 punch down jack
- black
- for use with Oasis power units

<b>HDMI Connector Accessory, Type 3</b>						<b>TCP301</b>	<b>\$119</b>
---	--	--	--	--	--	---------------	--------------

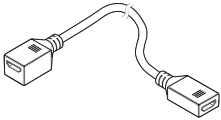

- one HDMI coupler female to female connection with 18" cord
- use 12 pack data adapter kit CCC adapter trim shaped with unit
- black
- for use with Node, Ellora, M2X, Ellora Double and Glenbeigh power units

<b>Network Jack Accessory, Type 3</b>						<b>TCP303</b>	<b>\$110</b>
---------------------------------------	--	--	--	--	--	---------------	--------------

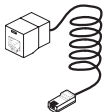

- one RJ45 CAT5e coupler female to female connection with 18" cord
- use 12 pack data adapter kit FFF adapter trim shipped with unit
- black
- for use with Node, Ellora, M2X, Ellora Double and Glenbeigh power units

Model

## Data Adapter Applications

12 Pack Data Adapter Kit ships with Power Units: Node, Ellora, Ellora Double and M2X with open ports.

Black plastic adapter trims are marked on the back surface with letter designators that indicate the data jack manufacturer, series and style. Manufactures websites are listed below for quick reference to verify data jack series and style.

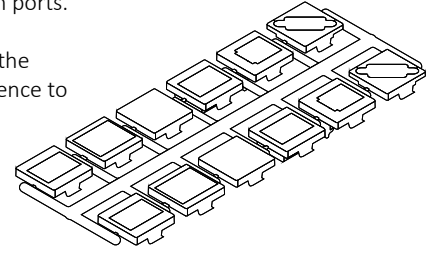

Adapter	Manufacturer	Website
BBB*	L-Com Keystone Modular	<a href="http://www.L-Com.com">www.L-Com.com</a>
BBB*	NETCONNECT, and 110 Connect Series Modular Jack	<a href="http://www.Anixter.com">www.Anixter.com</a>
BBB	Siemon ZMAX Style	<a href="http://www.Siemon.com">www.Siemon.com</a>
BBB*	Allen Tel Versa Tap Series	<a href="http://www.Graybar.com">www.Graybar.com</a>
BBB*	Leviton Quick Port® Series	<a href="http://www.Leviton.com">www.Leviton.com</a>
BBB*	Belden REVConnect	<a href="http://www.Belden.com">www.Belden.com</a>
CCC	HDMI Adapter Cable	<a href="http://www.Byrne.com">www.Byrne.com</a>
CCC	Hubbell Nextspeed™ Keystone Series	<a href="http://www.Hubbell-premise.com">www.Hubbell-premise.com</a>
CCC	ADC Truenet series	<a href="http://www.Anixter.com">www.Anixter.com</a>
DDD	Blank (no coupler/jack)	
EEE	Ortronics TracJack Series	<a href="http://www.Ortronics.com">www.Ortronics.com</a>
FFF	Panduit Mini-Com Series	<a href="http://www.Panduit.com">www.Panduit.com</a>
HHH	Video Monitor Jack/DB-15, panel mount solder style	<a href="http://www.Bryne.com">www.Bryne.com</a>

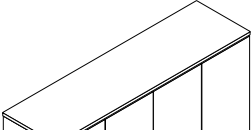
Description	D	W	H	CTN WT	CU FT	① Model	Laminate T	ESS Veneer V	ART Veneer V
	20	36	35 1/6	139	21	<b>65C203636CB_</b>	<b>\$1,994</b>	<b>\$2,657</b>	<b>\$2,922</b>
	20	60	35 1/6	224	33	<b>65C206036CB_</b>	<b>\$2,523</b>	<b>\$3,417</b>	<b>\$3,758</b>
	20	72	35 1/6	266	39	<b>65C207236CB_</b>	<b>\$2,744</b>	<b>\$3,586</b>	<b>\$3,945</b>
	20	90	35 1/6	342	49	<b>65C209036CB_</b>	<b>\$3,173</b>	<b>\$4,150</b>	<b>\$4,565</b>

- 110° hinge doors
- touch latch doors
- one adjustable shelf per compartment
- unfinished back, includes cutout in back side for wire management pass through
- utility drawer 65C1727UD\_ available specify and order separately

Laminate

Model	Top Surface TFL Laminate	Chassis Laminate	Door Laminate	Locking	Grommet	Electrical Cutout
	<a href="#">see Anthology Top Surface TFL Laminate Finishes</a>	<a href="#">see Anthology Chassis Laminate Finishes</a>	<a href="#">see Anthology Laminate Finishes</a>	NLK No Locking YLK Locking - <b>add \$51</b> ASL Arctic Silver MBK Matte Black	NGR No Grommet YGR Two Grommets - <b>add \$112</b> ASL Arctic Silver MBK Matte Black	NECU No Electrical Cutout YECU Electrical Cutout - <b>add \$33</b>

Veneer

Model	Top Surface/Chassis/Door Front	Locking	Grommet	Electrical Cutout
	<a href="#">see Anthology Top Surface/Chassis/Door Front Finishes</a>  <a href="#">see Contrasting Painted Door Front Colors</a>  Painted Door Front Upcharge - <b>add \$354</b>	NLK No Locking YLK Locking - <b>add \$51</b> ASL Arctic Silver MBK Matte Black	NGR No Grommet YGR Two Grommets - <b>add \$112</b> ASL Arctic Silver MBK Matte Black	NECU No Electrical Cutout YECU Electrical Cutout - <b>add \$33</b>

Description	D	W	H	CTN WT	CU FT	① Model	Laminate T	ESS Veneer V	ART Veneer V
Equipment Credenza	24	48	35 15/16	223	32	65C244836CER_	\$2,337	\$3,028	\$3,330
	24	48	35 15/16	295	32	65C244836CEL_	\$2,336	\$3,027	\$3,330
	24	72	35 15/16	223	46	65C247236CER_	\$3,190	\$4,198	\$4,618
	24	72	35 15/16	295	46	65C247236CEL_	\$3,190	\$4,198	\$4,618

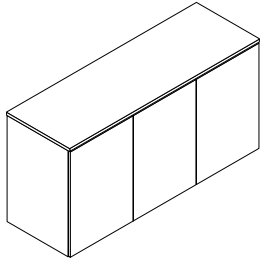

- 110° hinge doors
- touch latch doors
- one adjustable shelf per compartment
- unfinished back, includes cutout in back side for wire management pass through
- thermostat control fan 65C1019TCF available specify and order separately
- pull out rotating AV rack 65C19PAV available specify and order separately
- pull out dual waste, recycle unit 65C2214PDW available order separately

Laminate

Model	Top Surface TFL Laminate	Chassis Laminate	Door Laminate	Locking	Grommet	Electrical Cutout	Accessories
	<a href="#">see Anthology Top Surface TFL Laminate Finishes</a>	<a href="#">see Anthology Chassis Laminate Finishes</a>	<a href="#">see Anthology Door Laminate Finishes</a>	<b>NLK</b> No Locking <b>YLK</b> Locking - <b>add \$51</b> <b>ASL</b> Arctic Silver <b>MBK</b> Matte Black	<b>NGR</b> No Grommet <b>YGR</b> Two Grommets - <b>add \$112</b> <b>ASL</b> Arctic Silver <b>MBK</b> Matte Black	<b>NECU</b> No Electrical Cutout <b>YECU</b> Electrical Cutout - <b>add \$33</b>	Control Fan AV Rack Pull Out Dual Waste, Recycle Unit order separately

Veneer

Model	Top Surface/Chassis/Door Front	Locking	Grommet	Electrical Cutout	Accessories
	<a href="#">see Anthology Top Surface/Chassis/Door Front Finishes</a>  <a href="#">see Contrasting Painted Door Front Colors</a>  Painted Door Front Upcharge - <b>add \$354</b>	<b>NLK</b> No Locking <b>YLK</b> Locking - <b>add \$51</b> <b>ASL</b> Arctic Silver <b>MBK</b> Matte Black	<b>NGR</b> No Grommet <b>YGR</b> Two Grommets - <b>add \$112</b> <b>ASL</b> Arctic Silver <b>MBK</b> Matte Black	<b>NECU</b> No Electrical Cutout <b>YECU</b> Electrical Cutout - <b>add \$33</b>	Control Fan AV Rack Pull Out Dual Waste, Recycle Unit  order separately

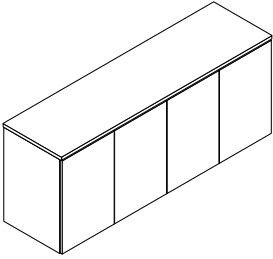
Description	D	W	H	CTN WT	CU FT	① Model	Laminate T	ESS Veneer V	ART Veneer V
	20	36	28 <sup>15</sup> / <sub>16</sub>	123	17	<b>65C203629CC_</b>	<b>\$1,918</b>	<b>\$2,568</b>	<b>\$2,824</b>
	20	60	28 <sup>15</sup> / <sub>16</sub>	205	27	<b>65C206029CC_</b>	<b>\$2,472</b>	<b>\$3,329</b>	<b>\$3,661</b>
	20	72	28 <sup>15</sup> / <sub>16</sub>	237	32	<b>65C207229CC_</b>	<b>\$2,504</b>	<b>\$3,346</b>	<b>\$3,681</b>
	20	90	28 <sup>15</sup> / <sub>16</sub>	308	40	<b>65C209029CC_</b>	<b>\$2,836</b>	<b>\$3,551</b>	<b>\$3,907</b>

- 110° hinge doors
- touch latch doors
- one adjustable shelf per compartment
- unfinished back, includes cutout in back side for wire management pass through

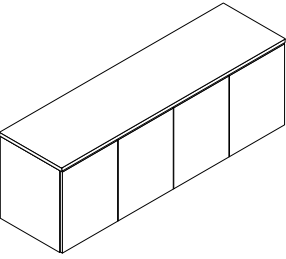
Description	D	W	H	CTN WT	CU FT	① Model	Laminate T	ESS Veneer V	ART Veneer V
	20	36	23 <sup>15</sup> / <sub>16</sub>	110	14	<b>65C203624CL_</b>	<b>\$1,802</b>	<b>\$2,514</b>	<b>\$2,765</b>
	20	60	23 <sup>15</sup> / <sub>16</sub>	184	23	<b>65C206024CL_</b>	<b>\$2,370</b>	<b>\$3,203</b>	<b>\$3,523</b>
	20	72	23 <sup>15</sup> / <sub>16</sub>	212	27	<b>65C207224CL_</b>	<b>\$2,414</b>	<b>\$3,116</b>	<b>\$3,428</b>
	20	90	23 <sup>15</sup> / <sub>16</sub>	281	34	<b>65C209024CL_</b>	<b>\$2,749</b>	<b>\$3,403</b>	<b>\$3,744</b>

- 110° hinge doors
- touch latch doors
- one adjustable shelf per compartment
- unfinished back, includes cutout in back side for wire management pass through

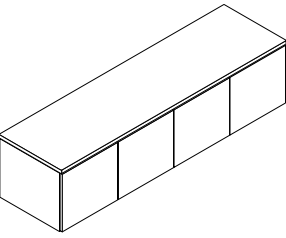
Description	D	W	H	CTN WT	CU FT	① Model	Laminate T	ESS Veneer V	ART Veneer V
	20	36	17	73	11	<b>65C203617CW_</b>	<b>\$1,649</b>	<b>\$2,273</b>	<b>\$2,501</b>
	20	60	17	123	17	<b>65C206017CW_</b>	<b>\$2,079</b>	<b>\$2,790</b>	<b>\$3,069</b>
	20	72	17	145	20	<b>65C207217CW_</b>	<b>\$2,215</b>	<b>\$3,007</b>	<b>\$3,308</b>
	20	90	17	186	25	<b>65C209017CW_</b>	<b>\$2,351</b>	<b>\$3,382</b>	<b>\$3,720</b>

- 110° hinge doors
- touch latch doors
- unfinished back
- unfinished back, includes cutout in back side for wire management pass through

Laminate

Model	Top Surface TFL Laminate	Chassis Laminate	Door Laminate	Locking	Grommet	Electrical Cutout
	<a href="#">see Anthology Top Surface TFL Laminate Finishes</a>	<a href="#">see Anthology Chassis Laminate Finishes</a>	<a href="#">see Anthology Laminate Finishes</a>	NLK No Locking YLK Locking - add \$51 ASL Arctic Silver MBK Matte Black	NGR No Grommet YGR Two Grommets - add \$112 ASL Arctic Silver MBK Matte Black	NECU No Electrical Cutout YECU Electrical Cutout - add \$33

Veneer

Model	Top Surface/Chassis/Door Front	Locking	Grommet	Electrical Cutout
	<a href="#">see Anthology Top Surface/Chassis/Door Front Finishes</a>  <a href="#">see Contrasting Painted Door Front Colors</a>  Painted Door Front Upcharge - add \$354	NLK No Locking YLK Locking - add \$51 ASL Arctic Silver MBK Matte Black	NGR No Grommet YGR Two Grommets - add \$112 ASL Arctic Silver MBK Matte Black	NECU No Electrical Cutout YECU Electrical Cutout - add \$33

Description	D	W	H	CTN WT	CU FT	① Model	Laminate T	ESS Veneer V	ART Veneer V
<b>Buffet Credenza on Inset Panel Base</b>	20	36	35 15/16	137	21	<b>65C203636CBP_</b>	<b>\$2,095</b>	<b>\$2,829</b>	<b>\$3,111</b>
	20	60	35 15/16	221	33	<b>65C206036CBP_</b>	<b>\$2,725</b>	<b>\$3,620</b>	<b>\$3,982</b>
	20	72	35 15/16	262	39	<b>65C207236CBP_</b>	<b>\$2,825</b>	<b>\$3,734</b>	<b>\$4,108</b>
	20	90	35 15/16	327	49	<b>65C209036CBP_</b>	<b>\$3,101</b>	<b>\$4,079</b>	<b>\$4,487</b>

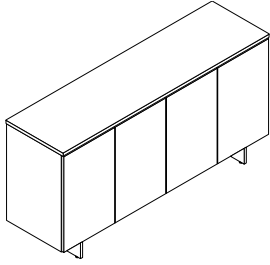

- 110° hinge doors
- touch latch doors
- one adjustable shelf per compartment
- unfinished back, includes cutout in back side for wire management pass through
- utility drawer 65C1727UD\_ available order separately

<b>Conference Credenza on Inset Panel Base</b>	20	36	28 15/16	128	17	<b>65C203629CCP_</b>	<b>\$2,048</b>	<b>\$2,775</b>	<b>\$3,052</b>
	20	60	28 15/16	195	27	<b>65C206029CCP_</b>	<b>\$2,622</b>	<b>\$3,497</b>	<b>\$3,847</b>
	20	72	28 15/16	230	32	<b>65C207229CCP_</b>	<b>\$2,728</b>	<b>\$3,642</b>	<b>\$4,007</b>
	20	90	28 15/16	287	40	<b>65C209029CCP_</b>	<b>\$3,005</b>	<b>\$4,015</b>	<b>\$4,416</b>

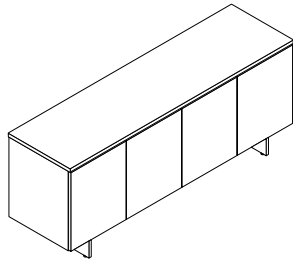

- 110° hinge doors
- touch latch doors
- one adjustable shelf per compartment
- unfinished back, includes cutout in back side for wire management pass through

<b>Low Height Credenza on Inset Panel Base</b>	20	36	23 15/16	107	14	<b>65C203624CLP_</b>	<b>\$1,950</b>	<b>\$3,623</b>	<b>\$3,985</b>
	20	60	23 15/16	176	23	<b>65C206024CLP_</b>	<b>\$2,293</b>	<b>\$3,046</b>	<b>\$3,350</b>
	20	72	23 15/16	205	27	<b>65C207224CLP_</b>	<b>\$2,421</b>	<b>\$3,335</b>	<b>\$3,669</b>
	20	90	23 15/16	261	34	<b>65C209024CLP_</b>	<b>\$2,549</b>	<b>\$3,626</b>	<b>\$3,988</b>

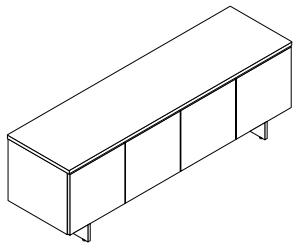

- 110° hinge doors
- touch latch doors
- unfinished back, includes cutout in back side for wire management pass through

Laminate

Model	Top Surface TFL Laminate	Chassis Laminate	Door Laminate	Locking	Grommet	Electrical Cutout
	<a href="#">see Anthology Top Surface TFL Laminate Finishes</a>	<a href="#">see Anthology Chassis Laminate Finishes</a>	<a href="#">see Anthology Laminate Finishes</a>	NLK No Locking YLK Locking - add \$51 ASL Arctic Silver MBK Matte Black	NGR No Grommet YGR Two Grommets - add \$112 ASL Arctic Silver MBK Matte Black	NECU No Electrical Cutout YECU Electrical Cutout - add \$33

Veneer

Model	Top Surface/Chassis/Door Front	Locking	Grommet	Electrical Cutout
	<a href="#">see Anthology Top Surface/Chassis/Door Front Finishes</a>  <a href="#">see Contrasting Painted Door Front Colors</a>  Painted Door Front Upcharge - add \$354	NLK No Locking YLK Locking - add \$51 ASL Arctic Silver MBK Matte Black	NGR No Grommet YGR Two Grommets - add \$112 ASL Arctic Silver MBK Matte Black	NECU No Electrical Cutout YECU Electrical Cutout - add \$33

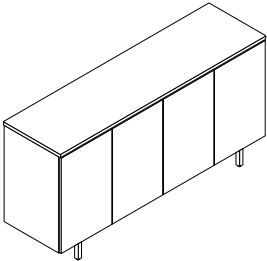

Description	D	W	H	CTN WT	CU FT	① Model	Laminate T	ESS Veneer V	ART Veneer V
<b>Buffet Credenza on Inset Metal Base</b> 	20	36	35 15/16	143	21	<b>65C203636CBM_</b>	<b>\$3,571</b>	<b>\$3,846</b>	<b>\$4,231</b>
	20	60	35 15/16	225	33	<b>65C206036CBM_</b>	<b>\$4,325</b>	<b>\$5,220</b>	<b>\$5,741</b>
	20	72	35 15/16	264	39	<b>65C207236CBM_</b>	<b>\$4,553</b>	<b>\$5,490</b>	<b>\$6,039</b>
	20	90	35 15/16	328	49	<b>65C209036CBM_</b>	<b>\$4,781</b>	<b>\$5,761</b>	<b>\$6,336</b>

- 110° hinge doors
- touch latch doors
- one adjustable shelf per compartment
- unfinished back, includes cutout in back side for wire management pass through
- utility drawer 65C1727UD\_ available order separately

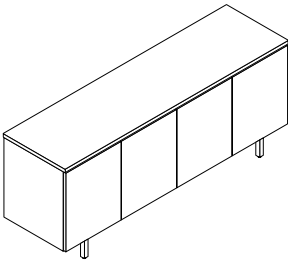
<b>Conference Credenza on Inset Metal Base</b> 	20	36	28 15/16	134	17	<b>65C203629CCM_</b>	<b>\$3,524</b>	<b>\$4,706</b>	<b>\$5,177</b>
	20	60	28 15/16	199	27	<b>65C206029CCM_</b>	<b>\$4,342</b>	<b>\$5,098</b>	<b>\$5,608</b>
	20	72	28 15/16	232	32	<b>65C207229CCM_</b>	<b>\$4,453</b>	<b>\$5,397</b>	<b>\$5,937</b>
	20	90	28 15/16	288	40	<b>65C209029CCM_</b>	<b>\$4,686</b>	<b>\$5,696</b>	<b>\$6,265</b>

- 110° hinge doors
- touch latch doors
- one adjustable shelf per compartment
- unfinished back, includes cutout in back side for wire management pass through

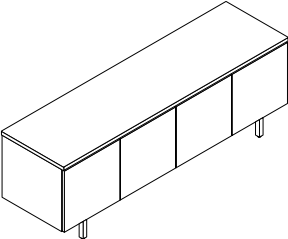
<b>Low Height Credenza on Inset Metal Base</b> 	20	36	23 15/16	113	14	<b>65C203624CLM_</b>	<b>\$3,426</b>	<b>\$4,187</b>	<b>\$4,606</b>
	20	60	23 15/16	180	23	<b>65C206024CLM_</b>	<b>\$3,894</b>	<b>\$4,646</b>	<b>\$5,111</b>
	20	72	23 15/16	207	27	<b>65C207224CLM_</b>	<b>\$4,061</b>	<b>\$4,976</b>	<b>\$5,474</b>
	20	90	23 15/16	262	34	<b>65C209024CLM_</b>	<b>\$4,653</b>	<b>\$5,307</b>	<b>\$5,837</b>

- 110° hinge doors
- touch latch doors
- unfinished back, includes cutout in back side for wire management pass through

Laminate

Model	Top Surface Laminate	Door Laminate	Locking	Metal Frame Colors	Grommet	Electrical Cutout
	<a href="#">see Anthology Laminate Finishes</a>	<a href="#">see Anthology Laminate Finishes</a>	<b>NLK</b> No Locking <b>YLK</b> Locking - <b>add \$51</b> <b>ASL</b> Arctic Silver <b>MBK</b> Matte Black	<b>Standard Metal Frame Colors</b> <a href="#">see Anthology Standard Metal Frame Colors</a>  <b>Additional Metal Frame Colors - add \$162</b> <a href="#">see Anthology Additional Metal Frame Colors</a>  Chrome Metal Base Upcharge - add \$750	<b>NGR</b> No Grommet <b>YGR</b> Two Grommets - <b>add \$112</b> <b>ASL</b> Arctic Silver <b>MBK</b> Matte Black	<b>NECU</b> No Electrical Cutout <b>YECU</b> Electrical Cutout - <b>add \$33</b>

Veneer

Model	Top Surface/Chassis/Door Front	Locking	Metal Frame Colors	Grommet	Electrical Cutout
	<a href="#">see Anthology Top Surface/Chassis/Door Front Finishes</a>  <a href="#">see Contrasting Painted Door Front Colors</a>  Painted Door Front Upcharge - add \$354	<b>NLK</b> No Locking <b>YLK</b> Locking - <b>add \$51</b> <b>ASL</b> Arctic Silver <b>MBK</b> Matte Black	<b>Standard Metal Frame Colors</b> <a href="#">see Anthology Standard Metal Frame Colors</a>  <b>Additional Metal Frame Colors</b> <a href="#">see Anthology Additional Metal Frame Colors</a>  Chrome Metal Base Upcharge - add \$750	<b>NGR</b> No Grommet <b>YGR</b> Two Grommets - <b>add \$112</b> <b>ASL</b> Arctic Silver <b>MBK</b> Matte Black	<b>NECU</b> No Electrical Cutout <b>YECU</b> Electrical Cutout - <b>add \$33</b>

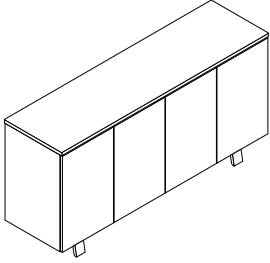
Description	D	W	H	CTN WT	CU FT	Model	Laminate T	ESS Veneer V	ART Veneer V
<b>Buffet Credenza on Inset Wood Base</b> 	20	36	35 1/16	142	21	<b>65C203636CBW_</b>	\$2,780	\$3,592	\$3,951
	20	60	35 1/16	224	33	<b>65C206036CBW_</b>	\$3,409	\$4,706	\$5,177
	20	72	35 1/16	263	39	<b>65C207236CBW_</b>	\$3,096	\$3,938	\$4,332
	20	90	35 1/16	326	49	<b>65C209036CBW_</b>	\$3,785	\$4,757	\$5,232

- 110° hinge doors
- touch latch doors
- one adjustable shelf per compartment
- unfinished back, includes cutout in back side for wire management pass through
- utility drawer 65C1727UD\_ available order separately

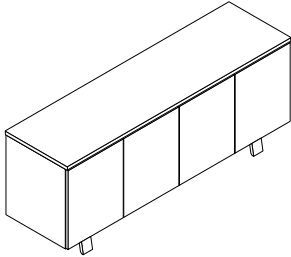
<b>Conference Credenza on Inset Wood Base</b> 	20	36	28 1/16	133	17	<b>65C203629CCW_</b>	\$2,732	\$3,537	\$3,890
	20	60	28 1/16	198	27	<b>65C206029CCW_</b>	\$3,306	\$4,175	\$4,592
	20	72	28 1/16	231	32	<b>65C207229CCW_</b>	\$3,299	\$4,434	\$4,878
	20	90	28 1/16	286	40	<b>65C209029CCW_</b>	\$3,689	\$4,693	\$5,163

- 110° hinge doors
- touch latch doors
- one adjustable shelf per compartment
- unfinished back, includes cutout in back side for wire management pass through

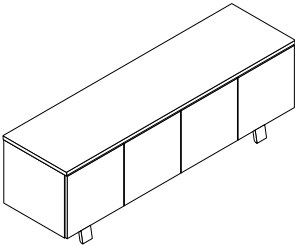
<b>Low Height Credenza on Inset Wood Base</b> 	20	36	23 1/16	112	14	<b>65C203624CLW_</b>	\$2,635	\$3,474	\$3,822
	20	60	23 1/16	179	23	<b>65C206024CLW_</b>	\$2,978	\$3,724	\$4,097
	20	72	23 1/16	206	27	<b>65C207224CLW_</b>	\$3,014	\$3,892	\$4,282
	20	90	23 1/16	260	34	<b>65C209024CLW_</b>	\$3,233	\$4,839	\$5,323

- 110° hinge doors
- touch latch doors
- unfinished back, includes cutout in back side for wire management pass through

Laminate

Model	Top Surface Laminate	Door Laminate	Base Finish	Locking	Grommet	Electrical Cutout
	see Anthology Laminate Finishes	see Anthology Laminate Finishes	see Anthology Base Wood Finishes	<b>NLK</b> No Locking <b>YLK</b> Locking - add \$51 <b>ASL</b> Arctic Silver <b>MBK</b> Matte Black	<b>NGR</b> No Grommet <b>YGR</b> Two Grommets - add \$112 <b>ASL</b> Arctic Silver <b>MBK</b> Matte Black	<b>NECU</b> No Electrical Cutout <b>YECU</b> Electrical Cutout - add \$33

Veneer

Model	Top Surface/Chassis/Door Front	Base Finish	Locking	Grommet	Electrical Cutout
	see Anthology Top Surface/Chassis/Door Front Finishes  see Contrasting Painted Door Front Colors  Painted Door Front Upcharge - add \$354	see Anthology Base Wood Finishes	<b>NLK</b> No Locking <b>YLK</b> Locking - add \$51 <b>ASL</b> Arctic Silver <b>MBK</b> Matte Black	<b>NGR</b> No Grommet <b>YGR</b> Two Grommets - add \$112 <b>ASL</b> Arctic Silver <b>MBK</b> Matte Black	<b>NECU</b> No Electrical Cutout <b>YECU</b> Electrical Cutout - add \$33

Description	D	W	H	CTN WT	CU FT	Model	List Price
<b>Glenbeigh Electrical Single Unit Power + Open - Corded</b>	4 ¼	5 ¼	1 7/8	3	1	<b>9PCK1C</b>	<b>\$383</b>

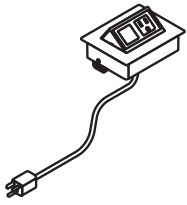

- In-Surface metal frame with retractable one touch doors
- one power and one open data port. Accepts TCP300 Telecom ports ordered separately. 12 pack data adapter kit included
- 10' cord with 15 amp three-prong molded plug
- powdercoat Silver or Black
- UL Listed

<b>Glenbeigh Electrical Single Unit Power - Corded</b>	4 ¼	5 ¼	1 7/8	3	1	<b>9PCK2C</b>	<b>\$389</b>
--	-----	-----	-------	---	---	---------------	--------------

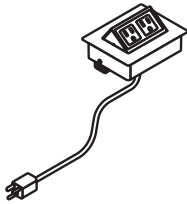

- In-Surface metal frame with retractable one touch doors
- two Power
- 10' cord with 15 amp three-prong molded plug
- powdercoat Silver or Black
- UL Listed

<b>Glenbeigh Electrical Single Unit Power + USB - Corded</b>	4 ¼	5 ¼	1 7/8	3	1	<b>9PCK11C</b>	<b>\$459</b>
--	-----	-----	-------	---	---	----------------	--------------

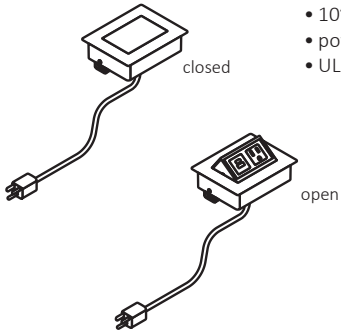

- In-Surface metal frame with retractable one touch doors
- one Power, one USB A + C (10 watt each)
- 10' cord with 15 amp three-prong molded plug
- powdercoat Silver or Black
- UL Listed

**Model** | **Metal Finish**

- B** Black
- S** Silver

Description	D	W	H	CTN WT	CU FT	① Model	List Price
<b>Thermostat Control Fan</b>	10 7/8	19	1 3/4	5	1	<b>65C1019TCF</b>	<b>\$1,606</b>

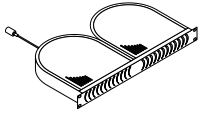

- black brushed and anodized
- quiet blower panel airflow: 100CFM
- current draw: 840mA
- sound level: 32dBA
- static pressure: 0.31 IN H2O
- includes UL Listed 12V DC power supply and temperature probe with a 9' cord
- blower panel activates at 87°F, full speed reach at 95°F, switch off at 85°F
- use with the Equipment Credenza models

<b>Rotating Pull Out AV Rack</b>	19 1/4	19 3/8	24	55	5	<b>65C19PAV</b>	<b>\$3,128</b>
----------------------------------	--------	--------	----	----	---	-----------------	----------------

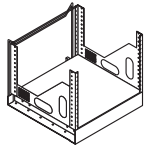

- black metal
- features slide out and rotating base
- recommended to use in conjunction with the thermostat control fan
- use with the Equipment Credenza models

<b>Pull Out Dual Waste, Recycle Unit</b>	14 1/4	21 3/4	19	18	6	<b>65C2214PDW</b>	<b>\$284</b>
--	--------	--------	----	----	---	-------------------	--------------

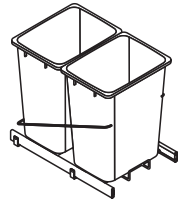

- dual 36 quart, plastic grey
- bottom mounted, soft close, steel, chrome
- use with the Equipment Credenza models

<b>Laminate Utility Drawer</b>	17 1/4	27	2 1/2	12	2	<b>65C1727UDT</b>	<b>\$363</b>
--------------------------------	--------	----	-------	----	---	-------------------	--------------

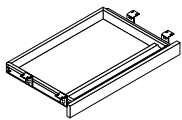

- use with Buffet Credenza models

Description	D	W	H	CTN WT	CU FT	① Model	Essentials Veneer	Artisan Veneer
<b>Veneer Utility Drawer</b>	17 3/8	27	2 1/2	12	2	<b>65C1727UDV</b>	<b>\$444</b>	<b>\$448</b>

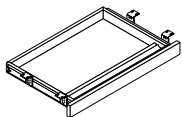

- use with Buffet Credenza models

Model	Laminate for Utility Drawer	Veneer for Utility Drawer
	<a href="#">see Anthology Laminate Finishes</a>	<a href="#">see Anthology Veneer Finishes</a>