

*price list* effective May 3, 2021

# FLUX

---

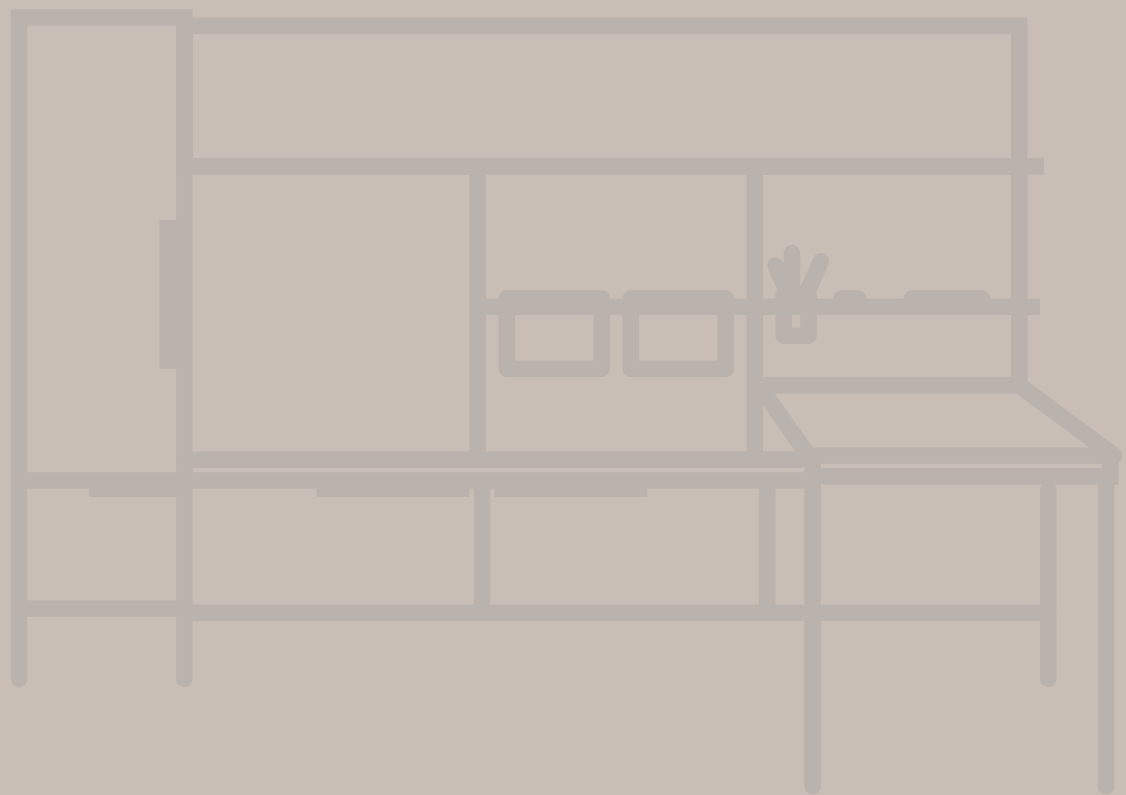

## Casegoods Price List | Flux Series

### General Information

Environmental Mission . . . . .	4
Warranty. . . . .	5
Laminate and Veneer Characteristics . . . . .	5
Samples. . . . .	6
Order Procedures . . . . .	6
Quickship Program. . . . .	6
Delivery . . . . .	6
Freight Damage . . . . .	7
Repairs and Returns . . . . .	7
Care and Maintenance. . . . .	7
Fire Retardancy / CAL 133 . . . . .	8
Textile Information / COM and COL Policy. . . . .	9

### Textile and Leather Swatch Card Programs

Maharam . . . . .	10-11
Momentum . . . . .	12-16
Spradling . . . . .	17
Stinson . . . . .	17
Ultrafabrics . . . . .	18
Wollsdorf . . . . .	19

### Fabric Grading

Arc-Com. . . . .	20
Designtex . . . . .	21
Maharam . . . . .	22

### Fabric Grading (cont.)

Mayer . . . . .	23
Momentum . . . . .	24
Stinson . . . . .	25
Ultrafabrics . . . . .	26

### Leather Grading

Wollsdorf . . . . .	27
---------------------	----

### Specification Tools. . . . .

Specification Tools. . . . .	28
GSA Terms and Conditions . . . . .	29-31

## Flux - Private Office

### Product Information

Overview . . . . .	32-33
--------------------	-------

### General Options

Material Offerings . . . . .	35
Desk Pedestal Configurations . . . . .	36
File Drawer Configurations . . . . .	37
Top Edge Details. . . . .	38
Pull Options/Details . . . . .	39
Casters . . . . .	40
Modesty Panels . . . . .	40

### Applied Materials

Laminate Grain Directions . . . . .	41
Veneer Grain Directions . . . . .	42-43
Color Scheme . . . . .	44

### Product Details

Pedestal Desks . . . . .	45
Peninsula Desks w/Secondary Creds. . . . .	46-48
Run-off Desks . . . . .	49
Adjustable Height Desks & Tables . . . . .	50-51
Standard and Secondary Heights . . . . .	52
Credenza Options . . . . .	53
Credenza Compartment Dimensions . . . . .	54-55
Overhead Cabinet & Wall Panel Stack-ups . . . . .	56
Wall Panel Installation . . . . .	57

### Product Details (cont.)

Overhead Cabinet Stack-ups . . . . .	58-60
Overhead Cabinet Door Options . . . . .	61
Tasklight Size Chart . . . . .	61
Monitor Cabinets . . . . .	62-63
Vertical Storage . . . . .	64-66
Modular Components . . . . .	67

### Technology

Power and Data Wiring Examples. . . . .	68-69
Grommets and Power Units . . . . .	70
Grommet and Power Unit Locations . . . . .	71-77
Wire Manager Size Chart . . . . .	78-79

### Typicals. . . . .

Typicals. . . . .	80-83
-------------------	-------

### Pricing Pages

Tables . . . . .	84
Pedestal Desks . . . . .	88
Peninsula Desks . . . . .	120
Run-off Desks . . . . .	144
Returns & Bridges . . . . .	154
Primary Height Credenzas . . . . .	160
Modular Credenzas/Pedestals . . . . .	182
Kneespace Credenzas . . . . .	186
Peninsula Credenzas. . . . .	196

### Pricing Pages (cont.)

Primary Height Credenzas . . . . .	200
Secondary Height Credenzas. . . . .	222
Cushions . . . . .	246
Adjustable Height Units . . . . .	248
Modular Units . . . . .	284
Primary Height Overhead Cabinets . . . . .	302
Primary Height Panels/Markerboards. . . . .	324
Secondary Height Overhead Cabinets . . . . .	328
Secondary Height Panels/Markerboards. . . . .	338
Wall Mount Overhead Cabinets. . . . .	342
Wall Mount Cubbies . . . . .	362
Wall Mount Panels/Tackboards. . . . .	368
Workwall Panels . . . . .	384
Storage Towers. . . . .	394
Monitor Cabinets . . . . .	400
Bookcases. . . . .	408
Lateral Filing. . . . .	410
Wardrobes/Vertical Cabinets . . . . .	412
Wardrobes/Vertical Cabinets with Legs . . . . .	446

### Accessories

Casegoods Task Lights . . . . .	474
Casegoods Keyboard Accessories . . . . .	474
Casegoods Power and Data . . . . .	476
Casegoods Wire Management . . . . .	477

## Flux - Open Plan

### Product Information

Overview . . . . .	478-479
--------------------	---------

### General Options

Material Offerings . . . . .	481
Drawer Information . . . . .	482
Pull Options/Details . . . . .	483
Locker Pulls & Lock Options . . . . .	484
Wireless Charging . . . . .	485
How to Specify. . . . .	486-487

### Typicals. . . . .

Typicals. . . . .	488-491
-------------------	---------

### Pricing Pages

Bench Surfaces . . . . .	492
Runoff Returns. . . . .	497
End Supports . . . . .	500
End Support Storage Cabinets . . . . .	501
End Support Storage Credenzas . . . . .	502
Mid Supports . . . . .	503
Fixed Height Privacy Screens . . . . .	512
Center Mount Storage Cabinets . . . . .	514
Tack Panels & Markerboards . . . . .	515
Adjustable Height Bench Surfaces . . . . .	516
Adjustable Height End & Mid Supports. . . . .	518
Adjustable Height Privacy Screens . . . . .	519
Adjustable Height H-Frame Benches . . . . .	532
Adjustable Height H-Frame Priv. Screens . . . . .	534
Adjustable Height Tables . . . . .	542

### Pricing Pages (cont.)

Storage Cabinets . . . . .	544
Pantry Drawer Storage Cabinets . . . . .	548
Lateral File Credenzas . . . . .	552
Privacy Hoods . . . . .	554
Portable Slide on Screen. . . . .	555
Slat Wall Accessories. . . . .	556
Mobile Pedestals . . . . .	557, 569
Monitor Arms . . . . .	558
Electrical/Power Items . . . . .	559
Lockers . . . . .	561
Locker Tops . . . . .	565
Locker Keys & Number Plate . . . . .	568
Storage Credenzas . . . . .	570
Secondary Height Cushions. . . . .	582
Index . . . . .	584

## Flux Open Plan Overview

### Bench Surfaces Page 492-496

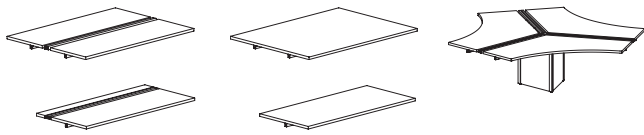

### Center Mount Storage Cabinets Page 514-515

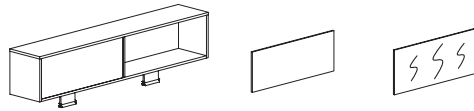

### Runoff Returns Page 497-499

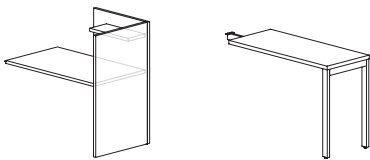

### Adjustable Height Bench Surfaces Page 516-517

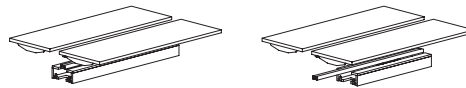

### End Supports Page 500-501

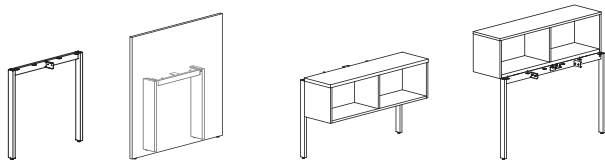

### Adjustable Height End & Mid Supports Page 518

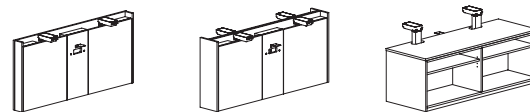

### End Supports with Storage Page 502



### Primary Height Privacy Screens Page 532

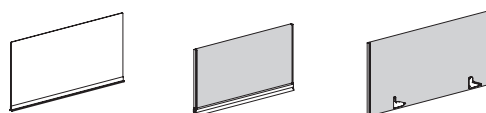

### Mid Supports Page 503

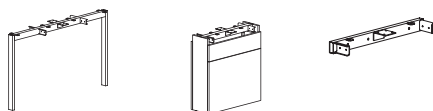

### Adjustable Height H-Frame Benches Page 542

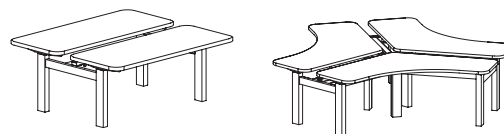

### Fixed Height Privacy Screens Page 504-513

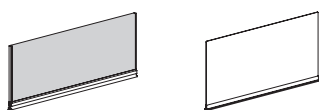

### Adjustable Height H-Frame Screens Page 534-541

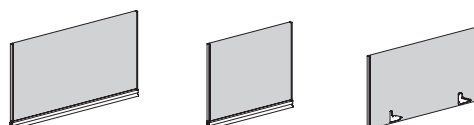

# Flux Open Plan Overview

## Adjustable Height Tables Page 542

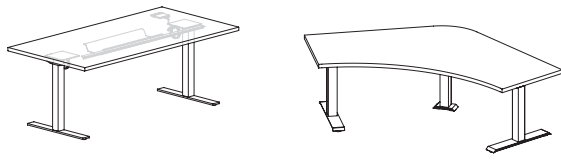

## Slat Wall Accessories Page 556

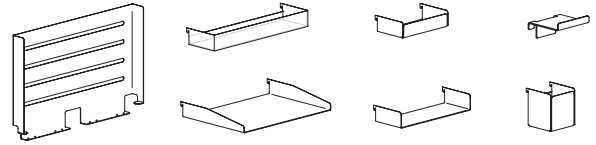

## Adjustable Height Tables Screens Page 543

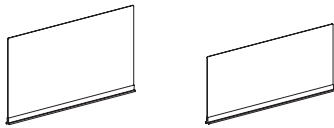

## Monitor Arms / Power and Data Page 558-560

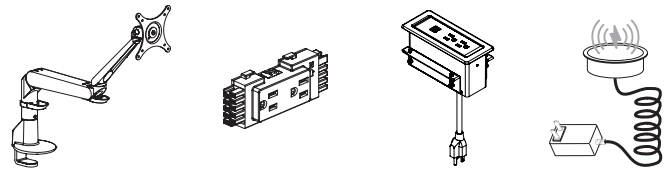

## Storage Cabinets Page 544-548

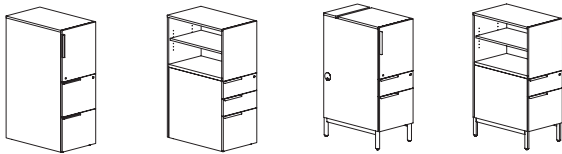

## Lockers Page 561-564

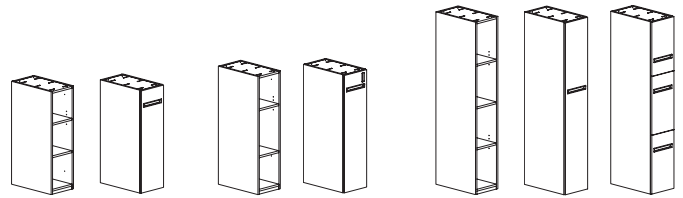

## Pantry Drawer Storage Cabinets Page 548-551

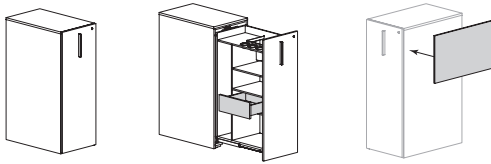

## Locker Tops Page 565-567

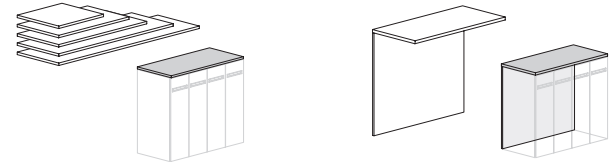

## Lateral File Credenzas Page 552-553

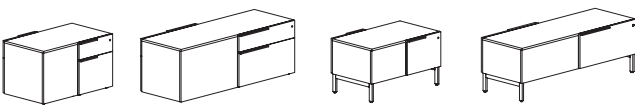

## Locker Keys and Number Plates Page 568



## Privacy Hoods & Portable Screen Page 554-555

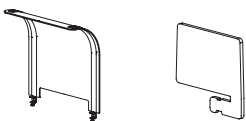

## Storage Credenzas Page 570-581

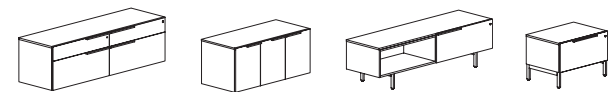



## Flux Open Plan General Options

### Laminate Products

Flux Open Plan Laminate features TFL (thermally fused laminate) chassis and components. Main worksurfaces\* are available in a HPL (high pressure laminate).

Eased edges of the worksurface are impact resistant (PVC) on HPL tops. The laminate is offered in wood grain patterns and solid colors. The wood grain laminate features an embossed grain to hide finger prints and light scratches. The solid laminate is smooth to the touch with a semi-matte finish. All Flux Laminate products are indoor-air certified by GreenGuard.

### Laminate Worksurface Construction

Worksurfaces have a 3-ply balanced construction. Tops are 1 3/16" thick with coordinating PVC edges. Primary worksurfaces feature 3mm PVC edges on the approach and user sides. Main worksurfaces are offered in HPL. Bridge, return, and primary height credenza worksurfaces are profiled with a 3mm PVC edge on the user side only. Remaining edges are banded with 1mm PVC which creates a seamless appearance when units are mated end-to-end or back-to-back.

### HPL Features on Main Worksurfaces\*

- fusion of multiple layers create a higher impact resistant surface
- tops are 3-ply balanced construction
- matched to the TFL wood grain and solid patterns

### Case Construction

Panels for chassis consist of a 3/4" thick substrate with TFL surfaces and PVC bands on exposed edges. Pedestal and cabinets are constructed with dowels reinforced with screw and interior plates for increased stability. Leveling glides are set into metal housing corner plate to allow for maximum leveling.

\*Main Worksurfaces include tops on desks, primary height credenzas, returns, bridges and transaction tops. Refer to pricing pages to confirm availability.

### Veneer Products

Exterior wood surfaces are made from the finest selected veneers to achieve clarity and consistency in the Flux Open Plan Veneer product line. To attain a pleasing, symmetrical pattern, all cherry, maple, and walnut veneers in Flux Open Plan Veneer are book-matched. All exterior solid lumber is matched to coordinate with the veneer.

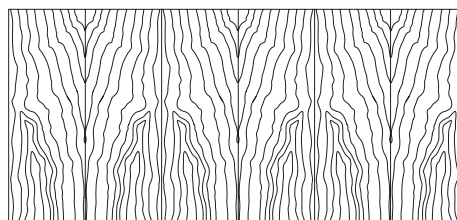

Veneer Book-Matched Example

Alternating pieces of veneer are flipped over so they face each other like the pages within a book.

Flux Open Plan Veneer is available in flat cut cherry, maple and walnut veneer. A wide range of wood stains have been formulated to enhance the beauty of the veneer.

Double Cut veneer is another choice on Flux Open Plan Veneer product. This veneer is a processed product that has at least two cuttings to create the final veneers. These cuts of veneer strands are dyed and layered into a block to create a wide variety of patterns, from a very tight grain pattern to an exotic figure grain pattern. Double Cut veneer can be run vertical or horizontal. Please specify the grain direction.

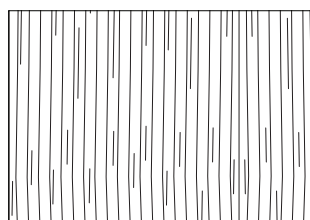

Double Cut Veneer - Tight Grain Pattern

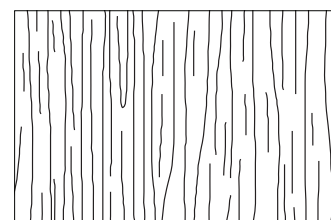

Double Cut Veneer - Natural Grain Example

### Veneer Worksurface Construction

Tops are 5-ply balanced construction, 1 3/16" thick with solid matching hardwood edges. Surfaces are available in wood veneer or high pressure laminate. No additional charge for using our coordinating high pressure laminate with a veneer grain pattern with finish wood edges.

### Protective Top Coat

DuraTex™ offers exceptional hardness along with abrasion and impact resistance. It has been formulated to eliminate hazardous and harmful gases that are normally associated with wood finish.

### DuraTex™ Features

- Safety - Significantly reduces hazardous formaldehyde emissions which help improve the quality of the indoor air we breathe.
- Quality - Developed to be tough and durable with special attention to appearance. The DuraTex™ finish preserves the natural beauty of wood.
- Durability - Designed to meet a wide range of demanding performance and environmental standards to withstand even the highest wear and tear.

### Special Finishes

Special finishes can be requested by following the instruction in the general introduction section, page 5. There is a one-time charge of \$299 list per order.

## Flux Open Plan General Options

### Flux Open Plan Standard Laminate Offering

The chart below lists the laminates available on Flux.

#### Laminate Options

Wood Grain Laminate		Solid Laminate	
AGA	Aged Ash	ALB	Alabaster
ALL	Ale Light	BBL	Bridal Blanco
BLO	Blond Echo	DWH	Designer White
BOL	Bourbon Light	SHD	Shadow
BZW	Brazilwood	SLG	Slate Grey
BGL	Brighton Light		
CLL	Collectors		
FLO	Florence Walnut		
GRH	Graphite		
HGL	High Line		
OAT	Oatmeal Cookie		
PIN	Pinnacle Walnut		
STU	Studio Teak		
VIN	Vintage		
WLH	Walnut Heights		
WEA	Weathered Ash		

Laminates available on the **NOW!** quickship program include the following: Aged Ash (AGA), Ale Light (ALL), Bourbon Light (BOL), Brighton Light (BGL), Collectors (CLL), Designer White (DWH), Florence Walnut (FLO), Graphite (GRH), Pinnacle Walnut (PIN), Slate Grey (SLG), Studio Teak (STU), Vintage (VIN) and Walnut Heights (WLH).

### Flux Open Plan Color Scheme – Accent Colors

Metal Accents	
ASL	Arctic Silver
MBK	Matte Black
PEW	Pewter
SNK	Soft Nickel

Items below are available in any of the four color schemes listed above:



drawer pulls

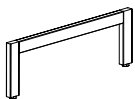

legs, end frames,  
and post frames

### Flux Open Plan Standard Veneer Finish Offering

The charts below list the veneer stains and paints available on Flux Open Plan.

#### Finish/Stain Colors

Cherry Flat Cut Veneer		Walnut Flat Cut Veneer	
CH1	Cherry Flat Cut Veneer	WA1	Walnut Flat Cut Veneer
BRL	Barley	AUB	Auburn
BBM	Bourbon Medium	ESP	Espresso
BRM	Brighton Medium	MCH	Mocha
CLA	Classic	NTO	Night Owl
CLL	Collectors	SIE	Sienna
EAR	Earthy	TOF	Toffee
HRV	Harvest	TRF	Truffle
LGC	Legacy		
PRL	Praline		
SAF	Saffron		
MA1	Maple Flat Cut Veneer	DC1	Double Cut Veneer
ALM	Ale Medium	COF	Coffee
BUT	Butterscotch	CRM	Cremello
CIN	Cinnamon	FOS	Fossil
FLX	Flax	GRH	Graphite
VEN	Venetian	KHK	Khaki
		STU	Studio Teak

Flux Veneer species available on the **NOW!** quickship program include Maple, Walnut and the following Double Cut veneers: Graphite (GRH), Khaki (KHK) and Studio Teak (STU).

#### Paint Colors

Paint (Maple Flat Cut Veneer)	
PNT	Paint (Maple Flat Cut Veneer)
BKD	Backdrop
BFX	Black Fox
BWH	Bright White
CGP	Cargo Pants
CHT	Chatroom
FRR	French Roast
GRV	Greek Villa
NET	Network Gray
NWH	Nonchalant White
STM	Storm
TRC	Tricorn Black

Contact Customer Service for any additional veneer species. Samples available upon request.

## Flux Open Plan General Options

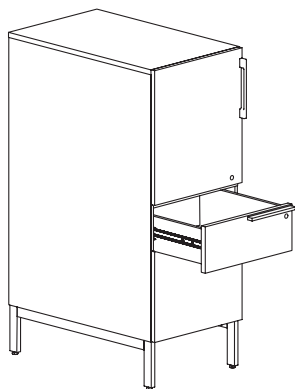

### Drawer Information

Flux Open Plan is standard with a unidirectional V-fold drawer box interior. The box is a durable, miter-fold drawer structure which is glued and doweled. The  $\frac{1}{2}$ "-thick drawer sides are wrapped in a high-grade maple vinyl, with an attached front. The drawer front is attached to the four sided box.

### Wood Drawer Boxes

Optional four corner dovetailed wood drawers are available. Specify and add 10% per unit.

### Drawer Suspension

High quality black drawer suspension carries a lifetime warranty. File and box drawers have 100% full extension with over travel. Slides feature steel ball bearings for longer wear and positive, cushioned in/out stops.

### Filing Hardware

All file drawers are constructed with a custom design for hanging folders. See filing diagram on page 37.

### Locking

All desks, credenzas, returns and mobile pedestals feature pedestal front locking to provide maximum security and flexibility in configuration. Units are shipped randomly keyed as standard. Key-alike units are available upon request for no additional charges. Removable cores for in-field re-keying are standard.

Lock face color is controlled by the metal color of the unit.

Pewter and Matte Black = Black Lock Face

Soft Nickel and Arctic Silver = Silver Lock Face

### Interior compartment

Interior compartment sizes and specification matrix on pages 54, 55 and 65.

### Special Construction

Flux Open Plan has an extensive product offering to create many types of configurations. Contact Customer Service if you are having trouble with finding the right units to complete the desired configuration. Requests for special construction need to be approved by JSI engineering.

# Flux Open Plan General Options

## Pulls and Pull Orientation

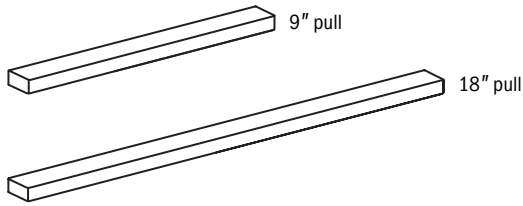

### Ledge Pull

- Standard on all Flux products
- Available in Arctic Silver, Soft Nickel, Matte Black or Pewter
- Ledge pull is considered part of the aesthetic of Flux and has unique orientation on the product. See chart below for these locations.
- Ledge pull length is determined by drawer/door width as follows:

9" pull	drawers/doors 18" wide or less
18" pull	drawers/doors wider than 18"

### Prism Pull

- Optional – must be specified at the time of order placement
- Available in Arctic Silver, Soft Nickel, Matte Black or Pewter
- Prism pull is mounted in the center of drawers on all drawer and lower doors widths. Upper pulls on worksurface towers or wardrobes are mounted on the right door only.

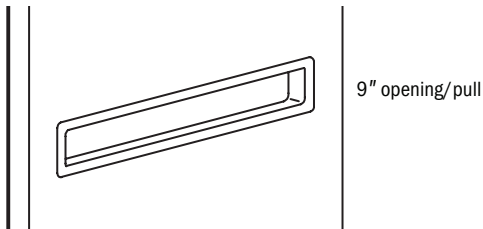

### Mail Slot Pull for Lockers

- Optional for lockers only – must be specified at the time of order placement
- Available in Arctic Silver, Soft Nickel, Matte Black or Pewter

## Flux Open Plan General Options

### Locker Pull and Lock Options

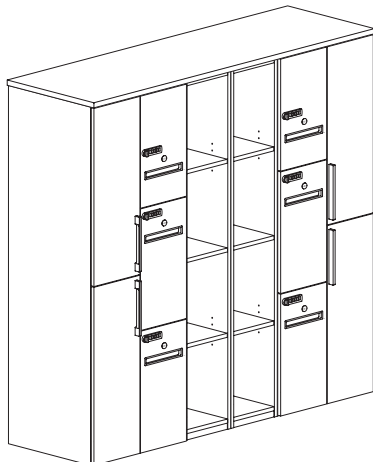

Lockers are available with a variety of pull and lock combinations.

#### Pulls

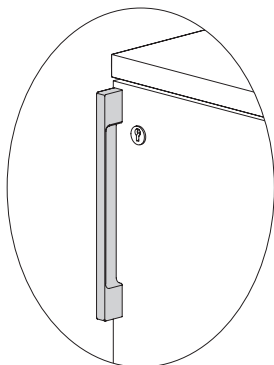

**Ledge**

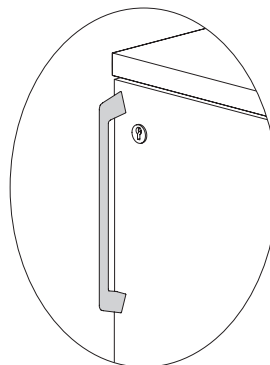

**Prism**

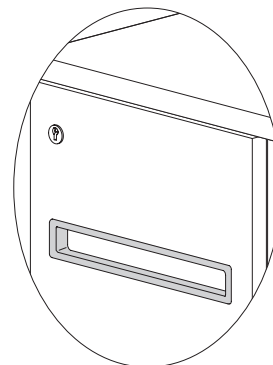

**Mail Slot**

#### Locks

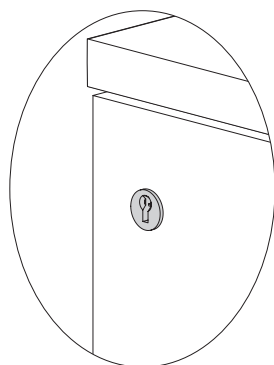

##### Standard

Standard lock and key. Black or silver finish. Ordered separately and field installed. Specify finish and number range. See page 568. \$80 upcharge per lock.

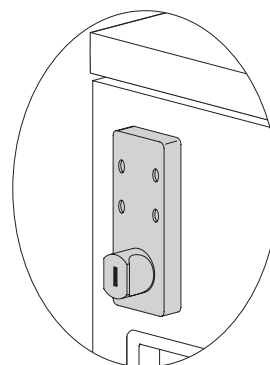

##### Keyless Radial

Temporary 4-digit code gets programmed by each user interaction. Built-in finger grip does not require additional pull. Prism and Ledge pulls not available. Satin Nickel finish. Master Key available, see page 568. \$291 upcharge per lock.

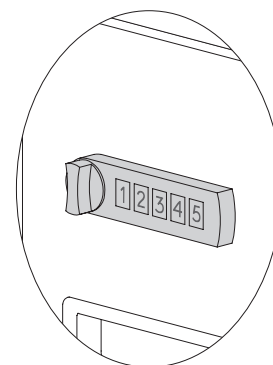

##### Digital Keypad

Temporary 4-digit code gets programmed by each user interaction (Locker Mode). May be reset to "Station Mode" for repeated use with a single code. Black or Silver finish. Master Key Fob available, see page 568. \$328 upcharge per lock.

### Locker Number Plates

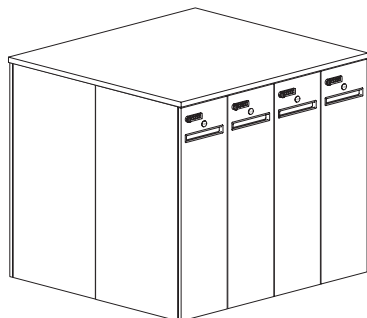

Locker number plates are available for identification. Adhesive backed for field installation. Ordered separately. Specify finish and number range. See page 568.



#### Number Plate

- 1 inch diameter aluminum
- Available in silver with black numbers or black with silver numbers
- Helvetica font

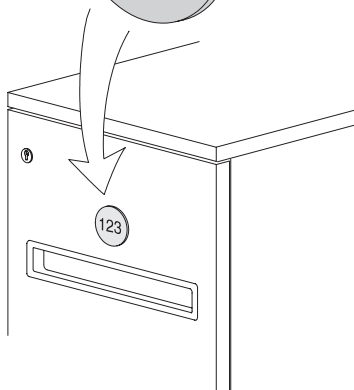

# Flux Open Plan General Options

## Wireless Charging - EC33

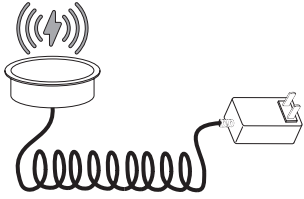

In-surface wireless charging for use with Qi enabled devices. 120" power cord. Black finish. UL Listed and CE/FCC certified. Order cutout with worksurface and order EC33 separately. See page 560.

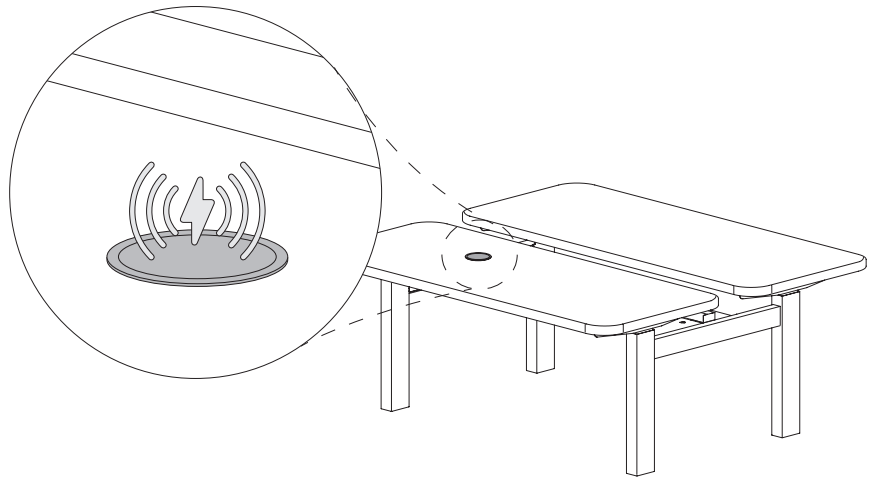

## Wireless Charging Locations

Standard locations for wireless charging units are 16 inches off the user edge, and 18 inches off center of worksurface. Locations are specified per surface; letter codes **A** (left) or **C** (right). See diagrams below.

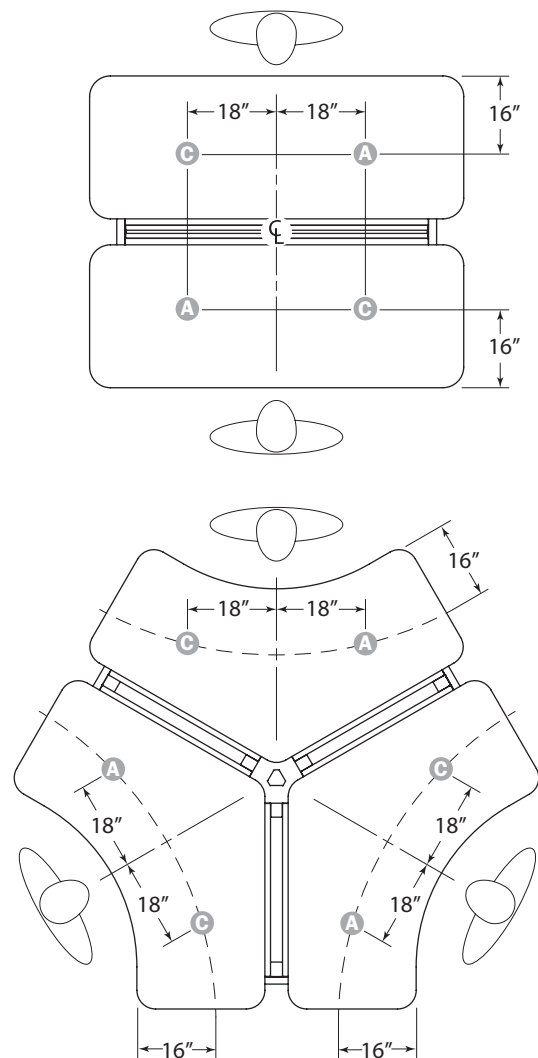
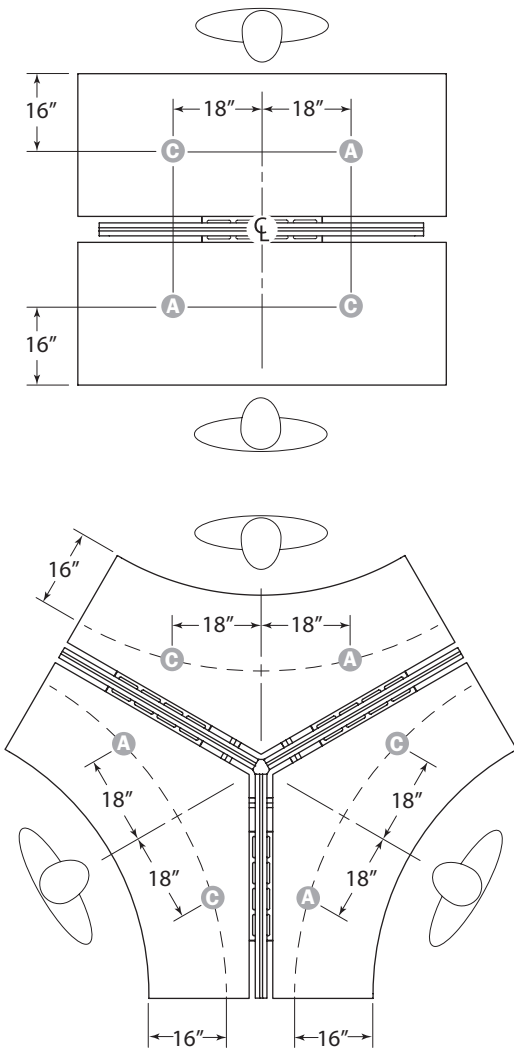

# Flux Open Plan - How to Specify

## Example 1: Fixed Height Benching

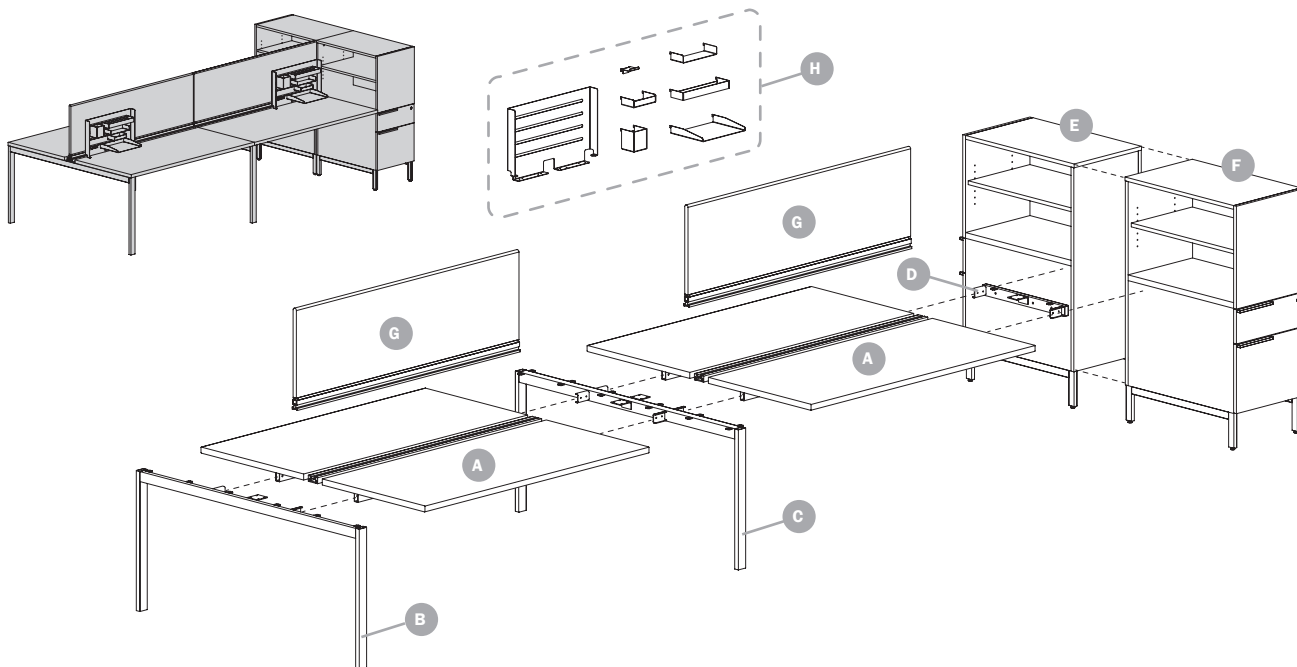

- A = FL\_6060-29B1-2-WS | 60" deep Bench Surface Dual Sided
- B = FLB0260-29B1-EFA | 60" deep End Support Frame
- C = FLB0260-29B1-EFM | 60" deep Mid Support Frame
- D = FLB2202-29B1-BRSP | Mid Support Storage Tower Bracket

- E = FL\_3018-48L5SAL | 48"h Box/File, Side Access
- F = FL\_3018-48L5SAR | 48"h Box/File, Side Access
- G = FLB60-20B3-RMTK | 20"h x 60"w Upholstered Tackboard Privacy Screen
- H = FLB0223-15ASW | Accessory Slat Wall + Accessories (sold separately)

PRODUCT INFORMATION

## Example 2: Adjustable Height H-Frame Benching

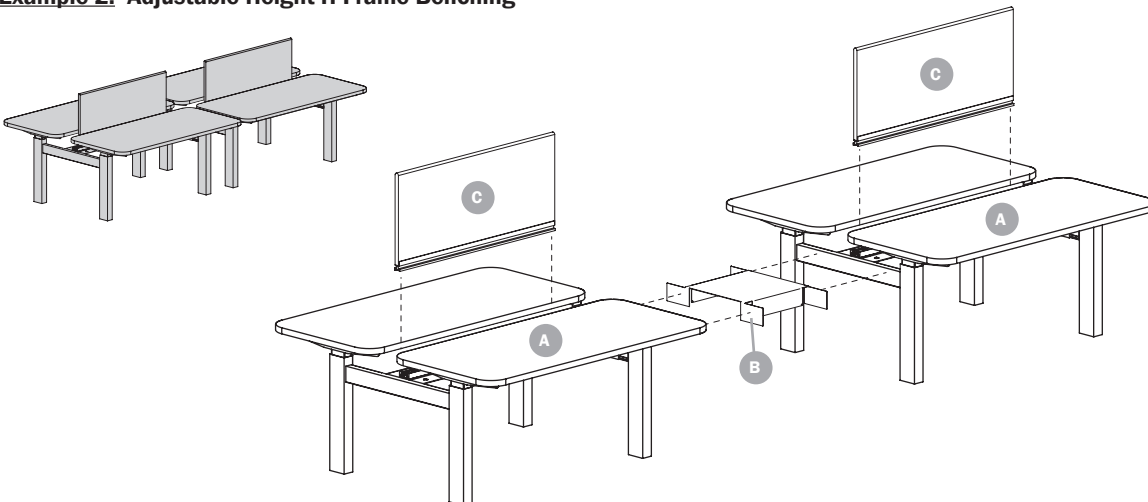

- A = FL\_6060-29B4-AHHT | 60" deep Adjustable Height H-Frame Bench Unit - Dual Sided
- B = FLB6015-B4-CON | H-Frame Ganging Connector for 60" deep Bench Units
- C = FLB48-20B4-RMTK | 20"h x 48"w Upholstered Tackboard Privacy Screen

## Flux Open Plan - How to Specify

### Example 3: Adjustable Height Benching

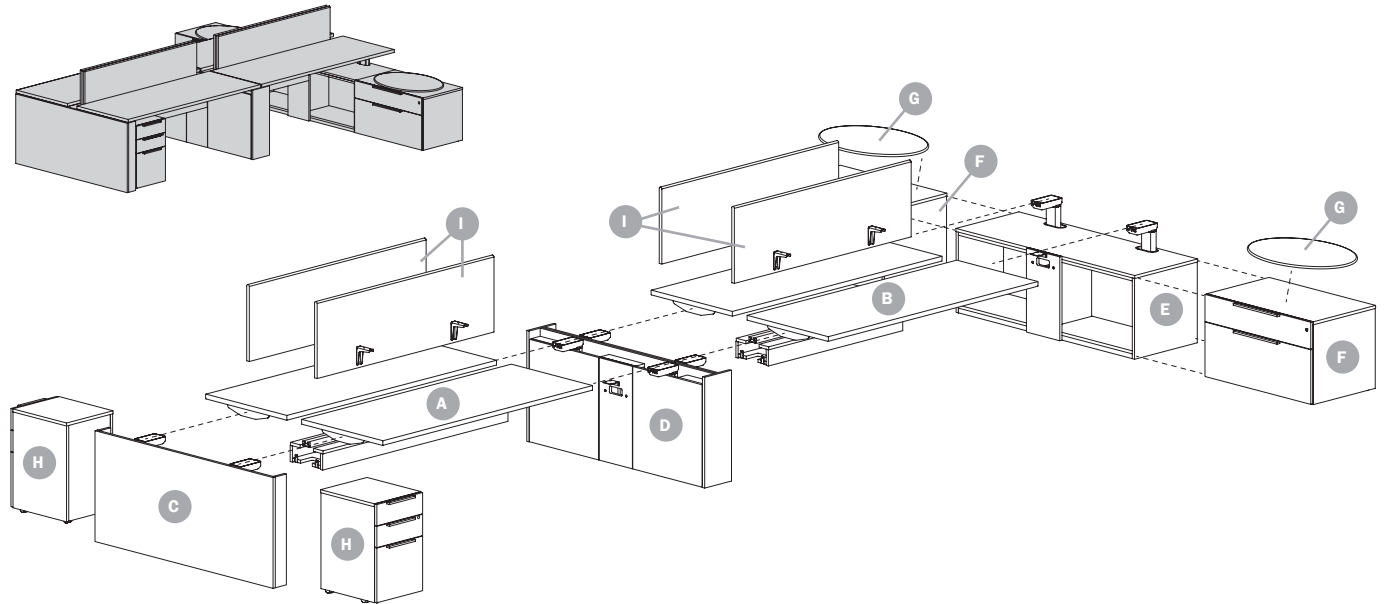

- A = FL\_6072-29B3-2-WS | 60" deep Adjustable Height Bench Surface - Dual Sided
- B = FL\_6072-29B3-2-WSIN | 60" deep Adjustable Height Bench Surface - Dual Sided - Inward Credenza Mount
- C = FL\_0560-29B3-EPAH | 60" deep Adjustable Height End Support
- D = FL\_0960-29B3-EPMAH | 60" deep Adjustable Height Mid Support
- E = FL\_2260-21B3-ECIN | 60" deep Inward Facing Adjustable Height End Support Credenza
- F = FL\_2236-21F6 | Box Lateral File Pedestal
- G = FLB2029OVCUSH | Oval Cushion
- H = FL\_1816-25FMP | Box/Box/File Mobile Pedestal
- I = FLB60-17B3-EMTK | 17"h x 60w" Upholstered Tackboard Edge Mount Privacy Screen



**Flux - Open Plan Typical** Additional typicals can be found on our website at [jsifurniture.com](http://jsifurniture.com)

**FL101**

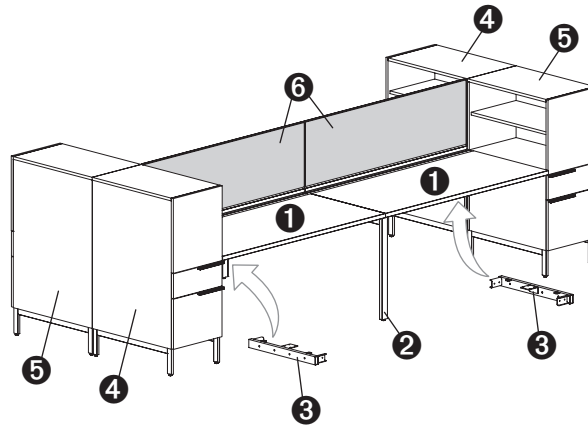
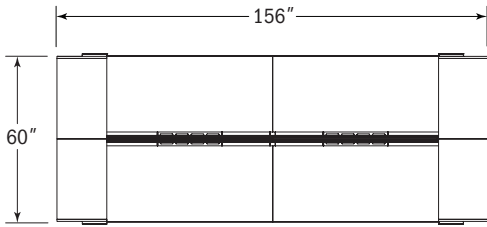

Model	Description	Qty	Laminate	Flat Cut	Double Cut
1 FL_6060-29B1-2-WS	bench surface - dual sided	2	\$3,622	\$5,017	\$5,520
2 FLB0260-29B1-EFM	mid support frame	1	\$758	\$758	\$758
3 FLB2202-29B1-BRSP	mid support storage tower bracket	2	\$737	\$737	\$737
4 FL_3018-48L5SAL	48"h box/file, side access shelf, left	2	\$4,811	\$6,074	\$6,827
5 FL_3018-48L5SAR	48"h box/file, side access shelf, right	2	\$4,811	\$6,074	\$6,827
6 FLB60-19B1-RMTK	18"h x 60"w tackboard privacy screen, COM	2	\$2,015	\$2,015	\$2,014
<b>Typical List Price</b>			<b>\$16,754</b>	<b>\$20,675</b>	<b>\$22,683</b>

**FL102**

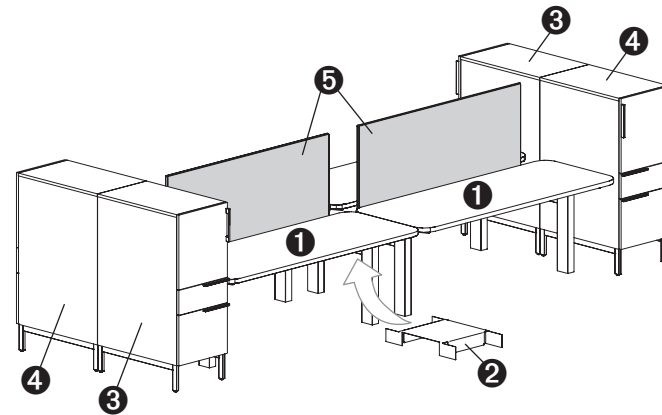
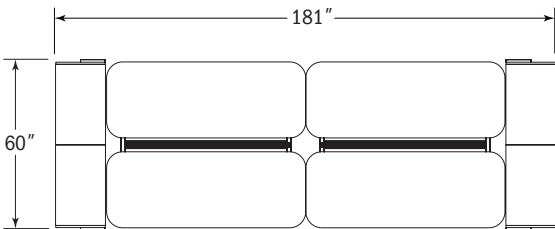

Model	Description	Qty	Laminate	Flat Cut	Double Cut
1 FL_6072-29B4-AHHT	adjustable height h-frame bench unit - dual sided	2	\$10,357	\$11,350	\$11,873
2 FLB6015-B4-CON	h-frame ganging connector	1	\$353	\$353	\$353
3 FL_3018-48L5DL	48"h box/file, storage cabinet, left	2	\$4,579	\$5,778	\$6,358
4 FL_3018-48L5DR	48"h box/file, storage cabinet, right	2	\$4,579	\$5,778	\$6,358
5 FLB60-26B3-RMTK	26"h x 60"w tackboard privacy screen, COM	2	\$2,095	\$2,095	\$2,095
<b>Typical List Price</b>			<b>\$21,963</b>	<b>\$25,354</b>	<b>\$27,037</b>

FLUX - TYPICALS

**Flux - Open Plan Typicals** Additional typicals can be found on our website at [jsifurniture.com](http://jsifurniture.com)

**FL103**

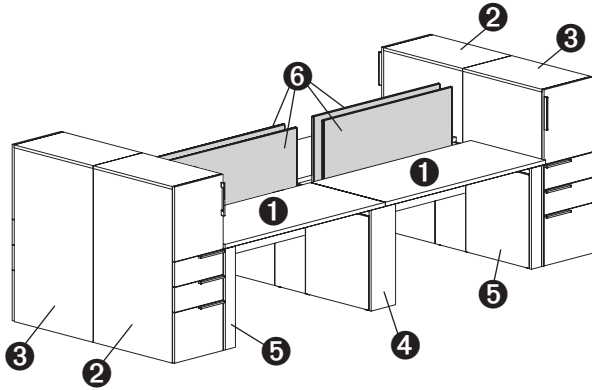
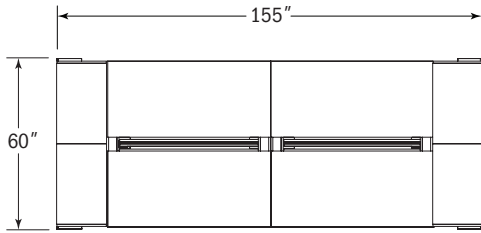

Model	Description	Qty	Laminate	Flat Cut	Double Cut
1 FL_6060-29B3-2-WS	adjustable height bench surface - dual sided	2	\$7,036	\$8,206	\$8,618
2 FL_3018-48F1DL	48"h box/box/bile, storage cabinet, left	2	\$3,665	\$4,798	\$5,278
3 FL_3018-48F1DR	48"h box/box/bile, storage cabinet, right	2	\$3,665	\$4,798	\$5,278
4 FL_0560-29B3-EPAH	adjustable height end support	2	\$4,864	\$5,739	\$6,027
5 FL_0960-29B3-EPMAH	adjustable height mid support	1	\$4,434	\$5,099	\$5,355
6 FLB48-17B3-EMTK	17"h x 48"w tackboard edge mount privacy screen, COM	4	\$3,684	\$3,684	\$3,684
<b>Typical List Price</b>			<b>\$27,348</b>	<b>\$32,324</b>	<b>\$34,240</b>

**FL104**

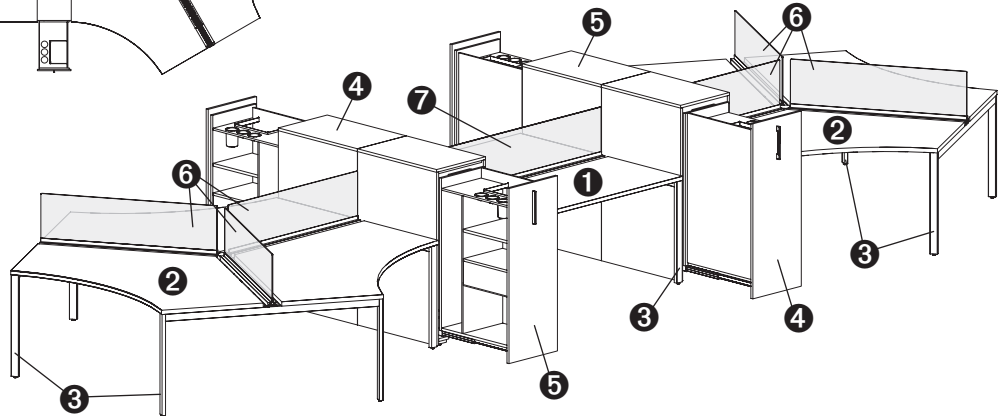
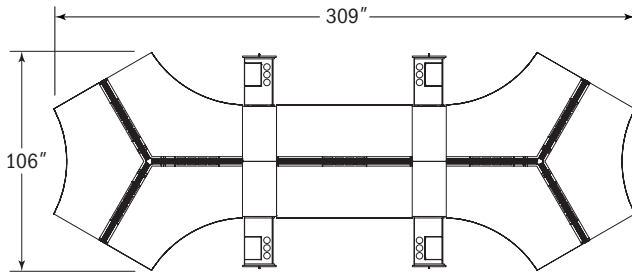

Model	Description	Qty	Laminate	Flat Cut	Double Cut
1 FL_6072-29B1-2-WS	bench surface - dual sided	1	\$1,885	\$2,612	\$2,874
2 FL_60101-29B1-3-WS	bench surface - 120°	2	\$12,051	\$14,131	\$14,981
3 FLB0260-29B1-EFA	end support frame	8	\$4,840	\$4,840	\$4,840
4 FL_3018-48PTAL	48"h pantry drawer with filing and wardrobe, single user, left	2	\$4,569	\$5,880	\$6,442
5 FL_3018-48PTAR	48"h pantry drawer with filing and wardrobe, single user, right	2	\$4,569	\$5,880	\$6,442
6 FLB48-13B1-APS	12"h acrylic privacy screen	6	\$3,246	\$3,246	\$3,246
7 FLB72-13B1-APS	12"h acrylic privacy screen	1	\$781	\$781	\$781
<b>Typical List Price</b>			<b>\$31,941</b>	<b>\$37,370</b>	<b>\$39,606</b>

**Flux - Open Plan Typical** Additional typicals can be found on our website at [jsifurniture.com](http://jsifurniture.com)

**FL105**

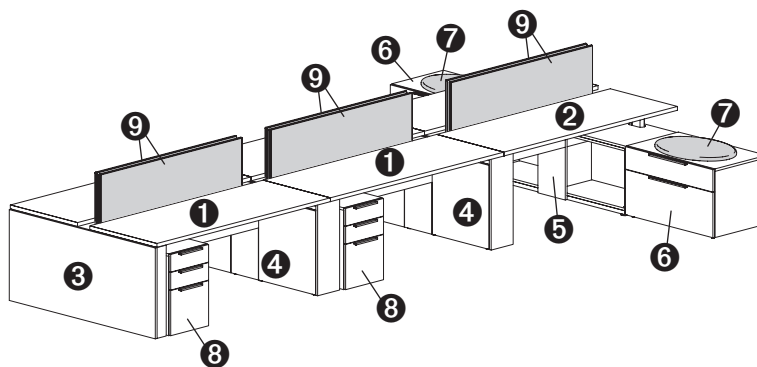
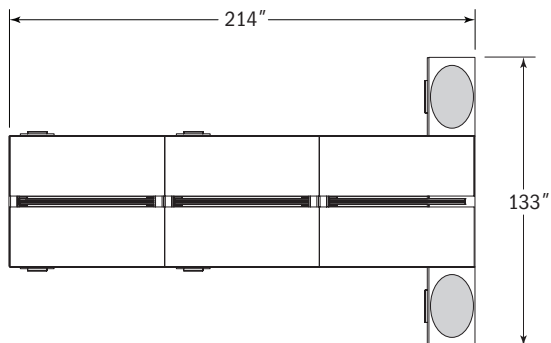

Model	Description	Qty	Laminate	Flat Cut	Double Cut
1 FL_6072-29B3-2-WS	adjustable height bench surface - dual sided	2	\$7,476	\$8,721	\$9,158
2 FL_6072-29B3-2-WSIN	adjustable height bench surface - dual sided - inward credenza mount	1	\$3,738	\$4,361	\$4,579
3 FL_0560-29B3-EPAH	adjustable height end support	1	\$2,432	\$2,870	\$3,014
4 FL_0960-29B3-EPMAH	adjustable height mid support	2	\$8,868	\$10,198	\$10,709
5 FL_2260-21B3-ECIN	inward facing adjustable height end support credenza	1	\$2,073	\$2,652	\$2,864
6 FL_2236-21F6	22 x 36 box/lateral file pedestal	2	\$2,199	\$3,071	\$3,380
7 FLB20290VCUSH	20d x 29w oval cushion, COM	2	\$474	\$474	\$474
8 FL_1816-25FMP	box/box/file mobile pedestal	4	\$4,488	\$6,016	\$6,616
9 FLB60-23B3-EMTK	23"h x 60"w tackboard edge mount privacy screen	6	\$5,970	\$5,970	\$5,970
<b>Typical List Price</b>			<b>\$37,718</b>	<b>\$44,333</b>	<b>\$46,764</b>

FLUX - TYPICALS

**FL106**

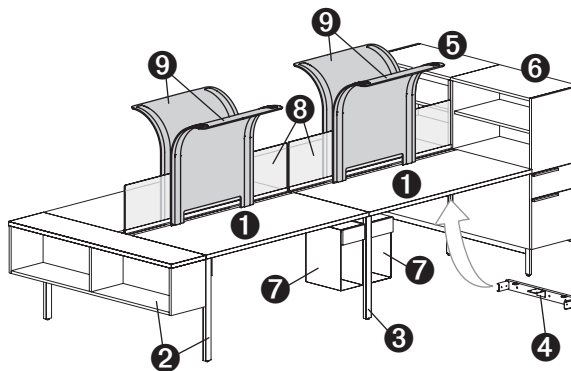
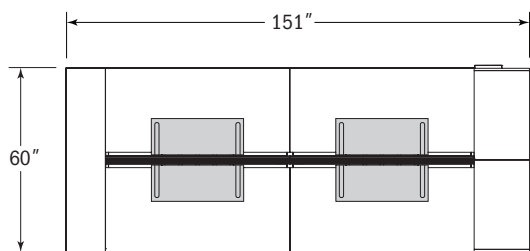

Model	Description	Qty	Laminate	Flat Cut	Double Cut
1 FL_6060-29B1-2-WS	bench surface - dual sided	2	\$3,622	\$5,017	\$5,520
2 FL_1360-29B1-EFBS	end support storage cabinet - below worksurface	1	\$1,517	\$1,851	\$1,962
3 FLB0260-29B1-EFM	mid support frame	1	\$758	\$758	\$758
4 FLB2202-29B1-BRSP	mid support storage tower bracket	1	\$369	\$369	\$369
5 FL_3018-48L5SAL	48"h box/file, side access shelf, left	1	\$2,406	\$3,037	\$3,414
6 FL_3018-48L5SAR	48"h box/file, side access shelf, right	1	\$2,406	\$3,037	\$3,414
7 FL_1208-19SUSP	suspended storage	2	\$1,965	\$2,672	\$2,776
8 FLB60-13B1-APS	12"h acrylic privacy screen	2	\$1,320	\$1,320	\$1,320
9 FLB3012-29CAN	privacy hood - edge mount	4	\$3,744	\$3,744	\$3,744
<b>Typical List Price</b>			<b>\$18,107</b>	<b>\$21,805</b>	<b>\$23,277</b>

**Flux - Open Plan Typical** Additional typicals can be found on our website at [jsifurniture.com](http://jsifurniture.com)

**FL107**

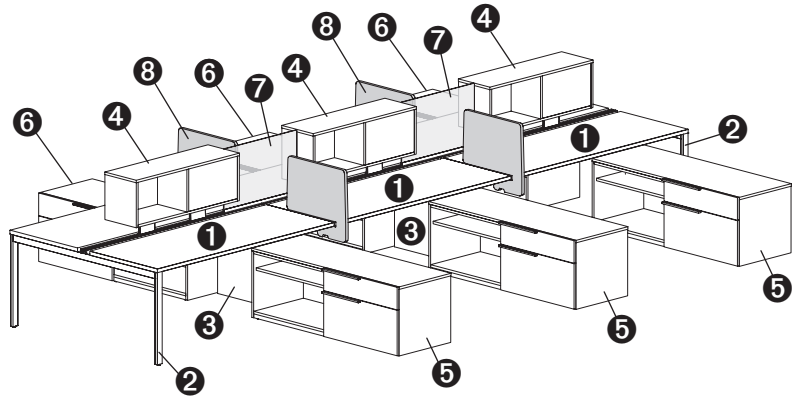
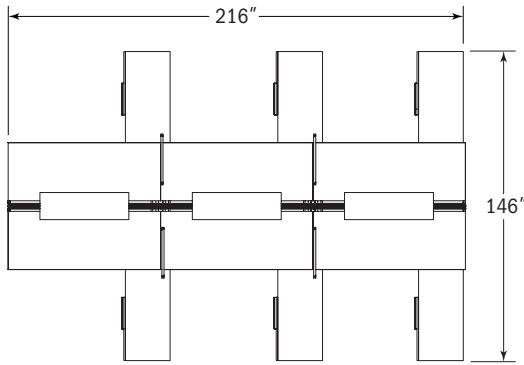

Model	Description	Qty	Laminate	Flat Cut	Double Cut
1 FL_6072-29B1-2-WS	bench surface - dual sided	3	\$5,655	\$7,836	\$8,622
2 FLB0260-29B1-EFA	end support frame	2	\$1,210	\$1,210	\$1,210
3 FL_0926-29B1-MSTC	mid support technology cabinet	2	\$2,602	\$3,430	\$3,686
4 FL_1342-19B1-CMSUL	center mount storage cabinet - dual sided open compartments	3	\$1,961	\$3,273	\$3,765
5 FL_2260-21F06	box/lateral file and open storage credenza, right	3	\$5,307	\$7,104	\$7,818
6 FL_2260-21F60	box/lateral file and open storage credenza, left	3	\$5,307	\$7,104	\$7,818
7 FLB30-19B1-APS	18" h acrylic privacy screen	2	\$946	\$946	\$946
8 GPB2422PDP	portable slide on screen	4	\$2,740	\$2,740	\$2,740
<b>Typical List Price</b>			<b>\$25,688</b>	<b>\$33,603</b>	<b>\$36,565</b>

**FL108**

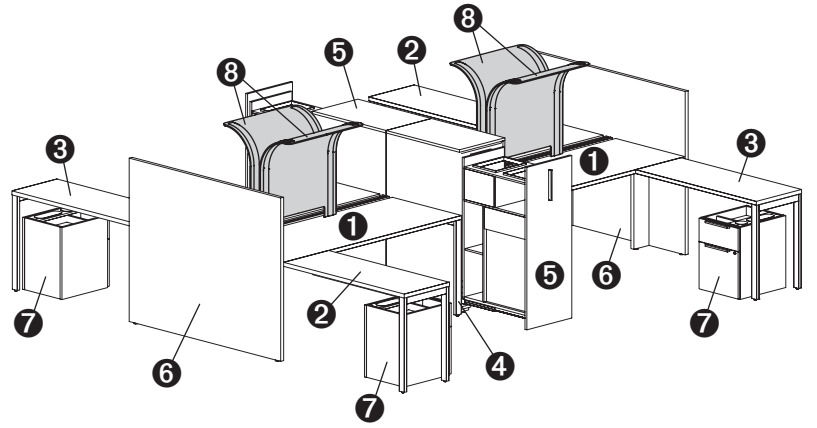
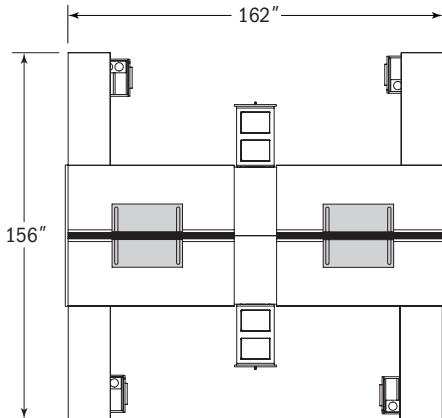

Model	Description	Qty	Laminate	Flat Cut	Double Cut
1 FL_6072-29B1-2-WS	bench surface - dual sided	2	\$3,770	\$5,224	\$5,747
2 FL_1848-29B1-RRWL	runoff return worksurface, left	2	\$1,864	\$2,490	\$2,666
3 FL_1848-29B1-RRWR	runoff return worksurface, right	2	\$1,864	\$2,490	\$2,666
4 FLB0260-29B1-EFA	end support frame	2	\$1,210	\$1,210	\$1,210
5 FL_3018-48PTE	48" h pantry drawer, dual user	2	\$4,633	\$6,033	\$6,608
6 FL_0260-48B2-EPA	end support panel	2	\$1,653	\$2,488	\$2,674
7 FL_1816-21FMPT	mobile pedestal - top storage	4	\$4,426	\$6,056	\$6,660
8 FLB3012-29CAN	privacy hood - edge mount	4	\$3,744	\$3,744	\$3,744
<b>Typical List Price</b>			<b>\$23,164</b>	<b>\$29,735</b>	<b>\$31,975</b>

FLUX - TYPICALS

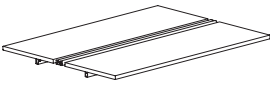
Description	D	W	H	CTN WT	CU FT	① Model	Laminate	Flat Cut Veneer	Double Cut Veneer
Bench Surface - Dual Sided 	60	72	29	175	88	FLT6072-29B1-2-WS	\$1,885		
	60	72	29	175	88	FLV6072-29B1-2-WS		\$2,612	\$2,874
	60	66	29	162	81	FLT6066-29B1-2-WS	\$1,848		
	60	66	29	162	81	FLV6066-29B1-2-WS		\$2,560	\$2,816
	60	60	29	148	74	FLT6060-29B1-2-WS	\$1,811		
	60	60	29	148	74	FLV6060-29B1-2-WS		\$2,509	\$2,760
	60	54	29	132	67	FLT6054-29B1-2-WS	\$1,775		
	60	54	29	132	67	FLV6054-29B1-2-WS		\$2,458	\$2,704
	60	48	29	145	71	FLT6048-29B1-2-WS	\$1,739		
	60	48	29	145	71	FLV6048-29B1-2-WS		\$2,410	\$2,651
	60	42	29	125	13	FLT6042-29B1-2-WS	\$1,709		
	60	42	29	125	13	FLV6042-29B1-2-WS		\$2,368	\$2,602
	60	36	29	107	15	FLT6036-29B1-2-WS	\$1,683		
	60	36	29	107	15	FLV6036-29B1-2-WS		\$2,333	\$2,563
	48	72	29	145	71	FLT4872-29B1-2-WS	\$1,512		
	48	72	29	145	71	FLV4872-29B1-2-WS		\$2,134	\$2,347
	48	66	29	137	66	FLT4866-29B1-2-WS	\$1,482		
	48	66	29	137	66	FLV4866-29B1-2-WS		\$2,091	\$2,300
	48	60	29	122	60	FLT4860-29B1-2-WS	\$1,452		
	48	60	29	122	60	FLV4860-29B1-2-WS		\$2,049	\$2,254
	48	54	29	109	55	FLT4854-29B1-2-WS	\$1,423		
	48	54	29	109	55	FLV4854-29B1-2-WS		\$2,009	\$2,208
	48	48	29	99	49	FLT4848-29B1-2-WS	\$1,395		
	48	48	29	99	49	FLV4848-29B1-2-WS		\$1,968	\$2,166
	48	42	29	92	12	FLT4842-29B1-2-WS	\$1,375		
	48	42	29	92	12	FLV4842-29B1-2-WS		\$1,938	\$2,133
	48	36	29	81	11	FLT4836-29B1-2-WS	\$1,353		
	48	36	29	81	11	FLV4836-29B1-2-WS		\$1,909	\$2,101

**Features:**

- eased edge profile on user sides
- ends must attach to end-supports or mid-supports
- center rail

**Options:**

- power harness kit available, specify and add \$328 list; receptacles and infeeds ordered separately, see page 559
- wireless charging unit available, specify location(s), see page 485; EC33 unit must be ordered separately, see page 560

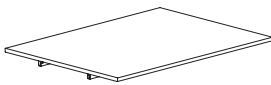
Description	D	W	H	CTN WT	CU FT	① Model	Laminate	Flat Cut Veneer	Double Cut Veneer
Table Surface 	60	72	29	168	88	FLT6072-29B1-1-WS	\$1,472		
	60	72	29	168	88	FLV6072-29B1-1-WS		\$1,926	\$2,119
	60	66	29	155	81	FLT6066-29B1-1-WS	\$1,443		
	60	66	29	155	81	FLV6066-29B1-1-WS		\$1,888	\$2,076
	60	60	29	141	74	FLT6060-29B1-1-WS	\$1,414		
	60	60	29	141	74	FLV6060-29B1-1-WS		\$1,850	\$2,034
	60	54	29	128	67	FLT6054-29B1-1-WS	\$1,386		
	60	54	29	128	67	FLV6054-29B1-1-WS		\$1,813	\$1,993
	60	48	29	114	60	FLT6048-29B1-1-WS	\$1,358		
	60	48	29	114	60	FLV6048-29B1-1-WS		\$1,776	\$1,955
	60	42	29	100	11	FLT6042-29B1-1-WS	\$1,331		
	60	42	29	100	11	FLV6042-29B1-1-WS		\$1,739	\$1,913
	60	36	29	86	9	FLT6036-29B1-1-WS	\$1,305		
	60	36	29	86	9	FLV6036-29B1-1-WS		\$1,703	\$1,873
	48	72	29	139	71	FLT4872-29B1-1-WS	\$1,235		
	48	72	29	139	71	FLV4872-29B1-1-WS		\$1,627	\$1,789
	48	66	29	162	66	FLT4866-29B1-1-WS	\$1,210		
	48	66	29	162	66	FLV4866-29B1-1-WS		\$1,595	\$1,754
	48	60	29	116	60	FLT4860-29B1-1-WS	\$1,186		
	48	60	29	116	60	FLV4860-29B1-1-WS		\$1,563	\$1,719
	48	54	29	105	55	FLT4854-29B1-1-WS	\$1,163		
	48	54	29	105	55	FLV4854-29B1-1-WS		\$1,532	\$19,613
	48	48	29	114	49	FLT4848-29B1-1-WS	\$1,139		
	48	48	29	114	49	FLV4848-29B1-1-WS		\$1,501	\$1,652
	48	42	29	72	9	FLT4842-29B1-1-WS	\$1,116		
	48	42	29	72	9	FLV4842-29B1-1-WS		\$1,471	\$1,619
	48	36	29	64	8	FLT4836-29B1-1-WS	\$1,093		
	48	36	29	64	8	FLV4836-29B1-1-WS		\$1,442	\$1,587

**Features:**

- eased edge profile on user sides
- ends must attach to end-supports or mid-supports

**Options:**

- power harness kit available, specify and add \$328 list; receptacles and infeeds ordered separately, see page 559
- wireless charging unit available, specify location(s), see page 485; EC33 unit must be ordered separately, see page 560
- 3" top grommet available, specify location(s); add \$105 list each; see page 77 for details

**To Order, Specify:**

① Laminate Model #	② Laminate Type	③ Laminate Selection			④ Metal Color	⑤ Other Product Options	
Laminate (FLT)	HPL	Solid Patterns: ALB Alabaster BBL Bridal Blanco DWH Designer White SHD Shadow SLG Slate Grey	Wood Grain Patterns: AGA Aged Ash ALL Ale Light BLO Blonde Echo BOL Bourbon Light BZW Brazilwood BGL Brighton Light	CLL Collectors FLO Florence Walnut GRH Graphite HGL High Line OAT Oatmeal Cookie PIN Pinnacle Walnut	STU Studio Teak VIN Vintage WLH Walnut Heights WEA Weathered Ash	Color: ASL Arctic Silver MBK Matte Black PEW Pewter SNK Soft Nickel	See list of options for each specific unit; Specify and add accordingly.

① Veneer Model #	② Wood Species	③ Wood Finish - Finishes with an asterisk (*) have a coordinating laminate available			④ Metal Color	⑤ Other Product Options		
Veneer (FLV)	Flat Cut CH1 Cherry MA1 Maple WA1 Walnut	Cherry: BRL Barley BBM Bourbon Medium BRM Brighton Medium CLA Classic CLL Collectors*	EAR Earthy HRV Harvest* LGC Legacy PRL Praline* SAF Saffron	Maple: ALM Ale Medium BUT Butterscotch CIN Cinnamon FLX Flax VEN Venetian	Walnut: AUB Auburn ESP Espresso MCH Mocha* NTO Night Owl* SIE Sienna*	TOF Toffee TRF Truffle*	Color: ASL Arctic Silver MBK Matte Black PEW Pewter SNK Soft Nickel	See list of options for each specific unit; Specify and add accordingly.
	Double Cut DC1 Double Cut	ⓐ Wood Finish Double Cut: COF Coffee CRM Cremello		ⓑ Chassis Grain Direction For Double Cut Only: Vertical Horizontal				

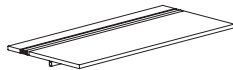
Description	D	W	H	CTN WT	CU FT	① Model	Laminate	Flat Cut Veneer	Double Cut Veneer
Bench Surface - Single Sided Inline 	37	72	29	104	12	FLT3772-29B1-2-WS	\$1,170		
	37	72	29	104	12	FLV3772-29B1-2-WS		\$1,620	\$1,782
	37	66	29	101	11	FLT3766-29B1-2-WS	\$1,146		
	37	66	29	101	11	FLV3766-29B1-2-WS		\$1,588	\$1,747
	37	60	29	94	10	FLT3760-29B1-2-WS	\$1,123		
	37	60	29	94	10	FLV3760-29B1-2-WS		\$1,556	\$1,712
	37	54	29	85	9	FLT3754-29B1-2-WS	\$1,101		
	37	54	29	85	9	FLV3754-29B1-2-WS		\$1,525	\$1,678
	37	48	29	77	8	FLT3748-29B1-2-WS	\$1,084		
	37	48	29	77	8	FLV3748-29B1-2-WS		\$1,502	\$1,653
	37	42	29	68	8	FLT3742-29B1-2-WS	\$1,069		
	37	42	29	68	8	FLV3742-29B1-2-WS		\$1,480	\$1,628
	37	36	29	60	7	FLT3736-29B1-2-WS	\$1,052		
	37	36	29	60	7	FLV3736-29B1-2-WS		\$1,457	\$1,604
	31	72	29	95	10	FLT3172-29B1-2-WS	\$968		
	31	72	29	95	10	FLV3172-29B1-2-WS		\$1,365	\$1,502
	31	66	29	88	9	FLT3166-29B1-2-WS	\$949		
	31	66	29	88	9	FLV3166-29B1-2-WS		\$1,338	\$1,472
	31	60	29	81	9	FLT3160-29B1-2-WS	\$930		
	31	60	29	81	9	FLV3160-29B1-2-WS		\$1,312	\$1,443
	31	54	29	68	8	FLT3154-29B1-2-WS	\$911		
	31	54	29	68	8	FLV3154-29B1-2-WS		\$1,286	\$1,414
	31	48	29	67	7	FLT3148-29B1-2-WS	\$899		
	31	48	29	67	7	FLV3148-29B1-2-WS		\$1,265	\$1,393
	31	42	29	60	6	FLT3142-29B1-2-WS	\$885		
	31	42	29	60	6	FLV3142-29B1-2-WS		\$1,246	\$1,371
31	36	29	53	6	FLT3136-29B1-2-WS	\$871			
31	36	29	53	6	FLV3136-29B1-2-WS		\$1,228	\$1,352	

**Features:**

- eased edge profile on user sides
- ends must attach to end-supports or mid-supports
- center rail

**Options:**

- modesty panels available, specify; add \$354 list for laminate or \$493 list for veneer
- power harness kit available, specify and add \$328 list; receptacles and infeeds ordered separately, see page 559
- wireless charging unit available, specify location(s), see page 485; EC33 unit must be ordered separately, see page 560

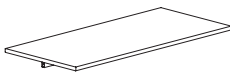
Description	D	W	H	CTN WT	CU FT	① Model	Laminate	Flat Cut Veneer	Double Cut Veneer
Bench Surface - Single Sided 	30	72	29	97	18	FLT3072-29B1-1-WS	\$924		
	30	72	29	97	18	FLV3072-29B1-1-WS		\$1,281	\$1,409
	30	66	29	90	17	FLT3066-29B1-1-WS	\$906		
	30	66	29	90	17	FLV3066-29B1-1-WS		\$1,254	\$1,380
	30	60	29	83	18	FLT3060-29B1-1-WS	\$888		
	30	60	29	83	18	FLV3060-29B1-1-WS		\$1,230	\$1,353
	30	54	29	77	14	FLT3054-29B1-1-WS	\$870		
	30	54	29	77	14	FLV3054-29B1-1-WS		\$1,205	\$1,326
	30	48	29	70	13	FLT3048-29B1-1-WS	\$857		
	30	48	29	70	13	FLV3048-29B1-1-WS		\$1,188	\$1,306
	30	42	29	63	11	FLT3042-29B1-1-WS	\$844		
	30	42	29	63	11	FLV3042-29B1-1-WS		\$1,170	\$1,287
	30	36	29	56	10	FLT3036-29B1-1-WS	\$832		
	30	36	29	56	10	FLV3036-29B1-1-WS		\$1,151	\$1,268
	24	72	29	82	15	FLT2472-29B1-1-WS	\$795		
	24	72	29	82	15	FLV2472-29B1-1-WS		\$1,121	\$1,232
	24	66	29	77	14	FLT2466-29B1-1-WS	\$779		
	24	66	29	77	14	FLV2466-29B1-1-WS		\$1,098	\$1,207
	24	60	29	71	13	FLT2460-29B1-1-WS	\$764		
	24	60	29	71	13	FLV2460-29B1-1-WS		\$1,077	\$1,183
	24	54	29	65	12	FLT2454-29B1-1-WS	\$748		
	24	54	29	65	12	FLV2454-29B1-1-WS		\$1,054	\$1,160
	24	48	29	56	11	FLT2448-29B1-1-WS	\$737		
	24	48	29	56	11	FLV2448-29B1-1-WS		\$1,039	\$1,143
	24	42	29	54	9	FLT2442-29B1-1-WS	\$726		
	24	42	29	54	9	FLV2442-29B1-1-WS		\$1,023	\$1,125
	24	36	29	47	8	FLT2436-29B1-1-WS	\$715		
	24	36	29	47	8	FLV2436-29B1-1-WS		\$1,008	\$1,110

**Features:**

- eased edge profile on user sides
- ends must attach to end-supports or mid-supports

**Options:**

- edge mount privacy screens available, order screen separately
- modesty panels available, specify; add \$354 list for laminate or \$493 list for veneer
- power harness kit available, specify and add \$328 list; receptacles and infeeds ordered separately, see page 559
- wireless charging unit available, specify location(s), see page 485; EC33 unit must be ordered separately, see page 560
- 3" top grommet available, specify location(s); add \$105 list each; see page 77 for details

**To Order, Specify:**

① Laminate Model #	② Laminate Type	③ Laminate Selection			④ Metal Color	⑤ Other Product Options	
Laminate (FLT)	HPL	Solid Patterns: ALB Alabaster BBL Bridal Blanco DWH Designer White SHD Shadow SLG Slate Grey	Wood Grain Patterns: AGA Aged Ash ALL Ale Light BLO Blonde Echo BOL Bourbon Light BZW Brazilwood BGL Brighton Light	CLL Collectors FLO Florence Walnut GRH Graphite HGL High Line OAT Oatmeal Cookie PIN Pinnacle Walnut	STU Studio Teak VIN Vintage WLH Walnut Heights WEA Weathered Ash	Color: ASL Arctic Silver MBK Matte Black PEW Pewter SNK Soft Nickel	See list of options for each specific unit; Specify and add accordingly.

① Veneer Model #	② Wood Species	③ Wood Finish - Finishes with an asterisk (*) have a coordinating laminate available			④ Metal Color	⑤ Other Product Options		
Veneer (FLV)	Flat Cut CH1 Cherry MA1 Maple WA1 Walnut	Cherry: BRL Barley BBM Bourbon Medium BRM Brighton Medium CLA Classic CLL Collectors*	EAR Earthy HRV Harvest* LGC Legacy PRL Praline* SAF Saffron	Maple: ALM Ale Medium BUT Butterscotch CIN Cinnamon FLX Flax VEN Venetian	Walnut: AUB Auburn ESP Espresso MCH Mocha* NTO Night Owl* SIE Sienna*	TOF Toffee TRF Truffle*	Color: ASL Arctic Silver MBK Matte Black PEW Pewter SNK Soft Nickel	See list of options for each specific unit; Specify and add accordingly.
	Double Cut DC1 Double Cut	ⓐ Wood Finish Double Cut: COF Coffee CRM Cremello		ⓑ Chassis Grain Direction For Double Cut Only: Vertical Horizontal				

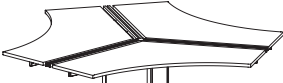

Description	D	W	H	CTN WT	CU FT	❶ Model	Laminate	Flat Cut Veneer	Double Cut Veneer
	100 1/8	115 3/8	29	363	224	FLT60101-29B1-3-WS	\$6,026		
	100 1/8	115 3/8	29	363	224	FLV60101-29B1-3-WS		\$7,066	\$7,491
	95	109 3/8	29	321	202	FLT48101-29B1-3-WS	\$5,724		
	95	109 3/8	29	321	202	FLV48101-29B1-3-WS		\$6,713	\$7,115

**Features:**

- eased edge profile on user sides
- center base support
- ends must attach to end-supports or mid-supports
- center rail

**Options:**

- power harness kit available, specify and add \$402 list; receptacles and infeeds ordered separately, see page 559
- wireless charging unit available, specify location(s), see page 485; EC33 unit must be ordered separately, see page 560
- must specify chassis grain direction on double cut veneer, see pages 42-43 for details
- on laminate units, worksurface available in contrasting color, no upcharge, specify color; see page 44 for details
- privacy screens available for center rail; order screen separately, up to 42" wide; see page 486 for example

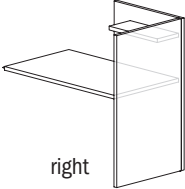
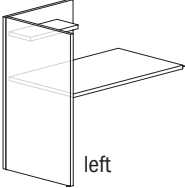
Description	D	W	H	CTN WT	CU FT	1 Model	Laminate	Flat Cut Veneer	Double Cut Veneer
 	34%	60	48	197	72	FLT3560-48B2-RRPWR	\$1,153		
	34%	60	48	11	72	FLV3560-48B2-RRPWR		\$1,579	\$1,738
	34%	60	48	197	72	FLT3560-48B2-RRPWL	\$1,153		
	34%	60	48	197	72	FLV3560-48B2-RRPWL		\$1,579	\$1,738
	34%	54	48	190	65	FLT3554-48B2-RRPWR	\$1,119		
	34%	54	48	190	65	FLV3554-48B2-RRPWR		\$1,533	\$1,685
	34%	54	48	190	65	FLT3554-48B2-RRPWL	\$1,119		
	34%	54	48	190	65	FLV3554-48B2-RRPWL		\$1,533	\$1,685
	34%	48	48	183	59	FLT3548-48B2-RRPWR	\$1,085		
	34%	48	48	183	59	FLV3548-48B2-RRPWR		\$1,487	\$1,634
	34%	48	48	183	59	FLT3548-48B2-RRPWL	\$1,085		
	34%	48	48	183	59	FLV3548-48B2-RRPWL		\$1,487	\$1,634
	34%	42	48	175	52	FLT3542-48B2-RRPWR	\$1,052		
	34%	42	48	175	52	FLV3542-48B2-RRPWR		\$1,442	\$1,587
	34%	42	48	175	52	FLT3542-48B2-RRPWL	\$1,052		
	34%	42	48	175	52	FLV3542-48B2-RRPWL		\$1,442	\$1,587
	28%	60	48	164	61	FLT2960-48B2-RRPWR	\$929		
	28%	60	48	164	61	FLV2960-48B2-RRPWR		\$1,299	\$1,429
	28%	60	48	164	61	FLT2960-48B2-RRPWL	\$929		
	28%	60	48	164	61	FLV2960-48B2-RRPWL		\$1,299	\$1,429
	28%	54	48	158	55	FLT2954-48B2-RRPWR	\$902		
	28%	54	48	164	55	FLV2954-48B2-RRPWR		\$1,260	\$1,386
	28%	54	48	158	55	FLT2954-48B2-RRPWL	\$902		
	28%	54	48	158	55	FLV2954-48B2-RRPWL		\$1,260	\$1,386
	28%	48	48	152	50	FLT2948-48B2-RRPWR	\$874		
	28%	48	48	152	50	FLV2948-48B2-RRPWR		\$1,223	\$1,345
	28%	48	48	152	50	FLT2948-48B2-RRPWL	\$94		
	28%	48	48	152	50	FLV2948-48B2-RRPWL		\$1,223	\$1,345
	28%	42	48	146	44	FLT2942-48B2-RRPWR	\$848		
	28%	42	48	152	44	FLV2942-48B2-RRPWR		\$1,186	\$1,304
28%	42	48	146	44	FLT2942-48B2-RRPWL	\$848			
28%	42	48	146	44	FLV2942-48B2-RRPWL		\$1,186	\$1,304	

**Features:**

- eased edge user side only
- one fixed shelf

**Options:**

- must specify chassis grain direction on double cut veneer, see pages 42-43 for details
- on laminate units, worksurface available in contrasting color, no upcharge, specify color; see page 44 for details
- 3" top grommet available, specify location(s); add \$105 list each; see page 73 for details

**To Order, Specify:**

1 Laminate Model #	2 Laminate Type	3 Laminate Selection	4 Metal Color	5 Other Product Options
Laminate (FLT)	HPL	<p>Solid Patterns:</p> <p>ALB Alabaster BBL Bridal Blanco DWH Designer White SHD Shadow SLG Slate Grey</p> <p>Wood Grain Patterns:</p> <p>AGA Aged Ash ALL Ale Light BLO Blonde Echo BOL Bourbon Light BZW Brazilwood BGL Brighton Light</p> <p>CLL Collectors FLO Florence Walnut GRH Graphite HGL High Line OAT Oatmeal Cookie PIN Pinnacle Walnut</p> <p>STU Studio Teak VIN Vintage WLH Walnut Heights WEA Weathered Ash</p>	<p>Color:</p> <p>ASL Arctic Silver MBK Matte Black PEW Pewter SNK Soft Nickel</p>	See list of options for each specific unit; Specify and add accordingly.

1 Veneer Model #	2 Wood Species	3 Wood Finish - Finishes with an asterisk (*) have a coordinating laminate available	4 Metal Color	5 Other Product Options
Veneer (FLV)	<p>Flat Cut</p> <p>CH1 Cherry MA1 Maple WA1 Walnut</p>	<p>Cherry:</p> <p>BRL Barley BBM Bourbon Medium BRM Brighton Medium CLA Classic CLL Collectors*</p> <p>EAR Earthy HRV Harvest* LGC Legacy PRL Praline* SAF Saffron</p> <p>Maple:</p> <p>ALM Ale Medium BUT Butterscotch CIN Cinnamon FLX Flax VEN Venetian</p> <p>Walnut:</p> <p>AUB Auburn ESP Espresso MCH Mocha* NTO Night Owl* SIE Sienna*</p> <p>TOF Toffee TRF Truffle*</p>	<p>Color:</p> <p>ASL Arctic Silver MBK Matte Black PEW Pewter SNK Soft Nickel</p>	See list of options for each specific unit; Specify and add accordingly.
	<p>Double Cut</p> <p>DC1 Double Cut</p>	<p>Wood Finish</p> <p>COF Coffee FOS Fossil CRM Cremello</p> <p>KHK Khaki GRH Graphite STU Studio Teak</p>	<p>Chassis Grain Direction</p> <p>For Double Cut Only: Vertical Horizontal</p>	

FLUX - OPEN PLAN

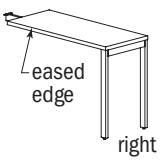
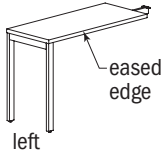
Description	D	W	H	CTN WT	CU FT	① Model	Laminate	Flat Cut Veneer	Double Cut Veneer
Runoff Return Worksurface	30	48	29	75	15	FLT3048-29B1-RRWR	\$1,211		
	30	48	29	75	15	FLV3048-29B1-RRWR		\$1,619	\$1,732
	30	48	29	75	15	FLT3048-29B1-RRWL	\$1,211		
	30	48	29	75	15	FLV3048-29B1-RRWL		\$1,619	\$1,732
	30	42	29	67	13	FLT3042-29B1-RRWR	\$1,188		
	30	42	29	67	13	FLV3042-29B1-RRWR		\$1,587	\$1,698
	30	42	29	67	13	FLT3042-29B1-RRWL	\$1,188		
	30	42	29	67	13	FLV3042-29B1-RRWL		\$1,587	\$1,698
	30	36	29	61	12	FLT3036-29B1-RRWR	\$1,165		
	30	36	29	61	12	FLV3036-29B1-RRWR		\$1,555	\$1,664
	30	36	29	61	12	FLT3036-29B1-RRWL	\$1,165		
	30	36	29	61	12	FLV3036-29B1-RRWL		\$1,555	\$1,664
	30	30	29	54	10	FLT3030-29B1-RRWR	\$1,146		
	30	30	29	54	10	FLV3030-29B1-RRWR		\$1,532	\$1,639
	30	30	29	54	10	FLT3030-29B1-RRWL	\$1,146		
	30	30	29	54	10	FLV3030-29B1-RRWL		\$1,532	\$1,639
	24	48	29	64	13	FLT2448-29B1-RRWR	\$1,067		
	24	48	29	64	13	FLV2448-29B1-RRWR		\$1,424	\$1,525
	24	48	29	64	13	FLT2448-29B1-RRWL	\$1,067		
	24	48	29	64	13	FLV2448-29B1-RRWL		\$1,424	\$1,525
	24	42	29	59	12	FLT2442-29B1-RRWR	\$1,045		
	24	42	29	59	12	FLV2442-29B1-RRWR		\$1,396	\$1,495
	24	42	29	59	12	FLT2442-29B1-RRWL	\$1,045		
	24	42	29	59	12	FLV2442-29B1-RRWL		\$1,396	\$1,495
	24	36	29	53	10	FLT2436-29B1-RRWR	\$1,025		
	24	36	29	53	10	FLV2436-29B1-RRWR		\$1,367	\$1,465
	24	36	29	53	10	FLT2436-29B1-RRWL	\$1,025		
	24	36	29	53	10	FLV2436-29B1-RRWL		\$1,367	\$1,465
	24	30	29	47	8	FLT2430-29B1-RRWR	\$1,010		
	24	30	29	47	8	FLV2430-29B1-RRWR		\$1,348	\$1,443
	24	30	29	47	8	FLT2430-29B1-RRWL	\$1,010		
	24	30	29	47	8	FLV2430-29B1-RRWL		\$1,348	\$1,443

**Features:**

- eased edge user side only

**Options:**

- 3" top grommet available, specify location(s); add \$105 list each; see page 73 for details

Description	D	W	H	CTN WT	CU FT	① Model	Laminate	Flat Cut Veneer	Double Cut Veneer
Runoff Return Worksurface (cont.)	18	48	29	50	21	FLT1848-29B1-RRWR	\$932		
	18	48	29	50	21	FLV1848-29B1-RRWR		\$1,245	\$1,333
	18	48	29	50	21	FLT1848-29B1-RRWL	\$932		
	18	48	29	50	21	FLV1848-29B1-RRWL		\$1,245	\$1,333
	18	42	29	45	19	FLT1842-29B1-RRWR	\$905		
	18	42	29	50	19	FLV1842-29B1-RRWR		\$1,208	\$1,293
	18	42	29	45	19	FLT1842-29B1-RRWL	\$905		
	18	42	29	45	19	FLV1842-29B1-RRWL		\$1,208	\$1,293
	18	36	29	41	16	FLT1836-29B1-RRWR	\$877		
	18	36	29	41	16	FLV1836-29B1-RRWR		\$1,172	\$1,254
	18	36	29	41	16	FLT1836-29B1-RRWL	\$877		
	18	36	29	41	16	FLV1836-29B1-RRWL		\$1,172	\$1,254
	18	30	29	37	14	FLT1830-29B1-RRWR	\$851		
	18	30	29	37	14	FLV1830-29B1-RRWR		\$1,137	\$1,218
	18	30	29	37	14	FLT1830-29B1-RRWL	\$851		
	18	30	29	37	14	FLV1830-29B1-RRWL		\$1,137	\$1,218

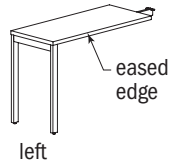
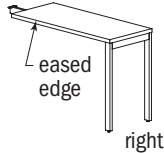

**Features:**

- eased edge user side only

**Options:**

- 3" top grommet available, specify location(s); add \$105 list each; see page 73 for details

**To Order, Specify:**

① Laminate Model #	② Laminate Type	③ Laminate Selection			④ Metal Color	⑤ Other Product Options	
Laminate (FLT)	HPL	<b>Solid Patterns:</b> ALB Alabaster BBL Bridal Blanco DWH Designer White SHD Shadow SLG Slate Grey	<b>Wood Grain Patterns:</b> AGA Aged Ash ALL Ale Light BLO Blonde Echo BOL Bourbon Light BZW Brazilwood BGL Brighton Light	CLL Collectors FLO Florence Walnut GRH Graphite HGL High Line OAT Oatmeal Cookie PIN Pinnacle Walnut	STU Studio Teak VIN Vintage WLH Walnut Heights WEA Weathered Ash	Color: ASL Arctic Silver MBK Matte Black PEW Pewter SNK Soft Nickel	See list of options for each specific unit; Specify and add accordingly.

① Veneer Model #	② Wood Species	③ Wood Finish - Finishes with an asterisk (*) have a coordinating laminate available			④ Metal Color	⑤ Other Product Options		
Veneer (FLV)	<b>Flat Cut</b> CH1 Cherry MA1 Maple WA1 Walnut	<b>Cherry:</b> BRL Barley BBM Bourbon Medium BRM Brighton Medium CLA Classic CLL Collectors*	<b>Earthy:</b> EAR Earthy HRV Harvest* LGC Legacy PRL Praline* SAF Saffron	<b>Maple:</b> ALM Ale Medium BUT Butterscotch CIN Cinnamon FLX Flax VEN Venetian	<b>Walnut:</b> AUB Auburn ESP Espresso MCH Mocha* NTO Night Owl* SIE Sienna*	TOF Toffee TRF Truffle*	Color: ASL Arctic Silver MBK Matte Black PEW Pewter SNK Soft Nickel	See list of options for each specific unit; Specify and add accordingly.
	<b>Double Cut</b> DC1 Double Cut	<b>Wood Finish</b> Double Cut: COF Coffee FOS Fossil KHK Khaki CRM Cremello GRH Graphite STU Studio Teak		<b>Chassis Grain Direction</b> For Double Cut Only: Vertical Horizontal				

Description	D	W	H	CTN WT	CU FT	① Model	List Price
End Support Frame	60	2	27 $\frac{7}{8}$	19	6	FLB0260-29B1-EFA	\$605
	48	2	27 $\frac{7}{8}$	18	5	FLB0248-29B1-EFA	\$580

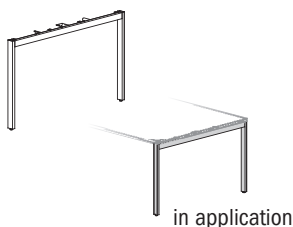

- Features:**
- use with Bench Surface or Table Surface

End Support Frame - Single Sided Inline Left or Right	36 $\frac{1}{4}$	2	27 $\frac{7}{8}$	15	6	FLB0237-29B1-EFR	\$592
	36 $\frac{1}{4}$	2	27 $\frac{7}{8}$	15	6	FLB0237-29B1-EFL	\$592
	30 $\frac{1}{4}$	2	27 $\frac{7}{8}$	13	5	FLB0231-29B1-EFR	\$585
	30 $\frac{1}{4}$	2	27 $\frac{7}{8}$	13	5	FLB0231-29B1-EFL	\$585

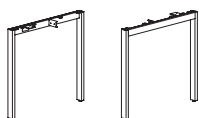

- Features:**
- use with single sided inline bench surface

End Support Frame - Single Sided Left or Right	30	2	27 $\frac{7}{8}$	14	5	FLB0230-29B1-EFR	\$577
	30	2	27 $\frac{7}{8}$	14	5	FLB0230-29B1-EFL	\$577
	24	2	27 $\frac{7}{8}$	13	4	FLB0224-29B1-EFR	\$566
	24	2	27 $\frac{7}{8}$	13	4	FLB0224-29B1-EFL	\$566

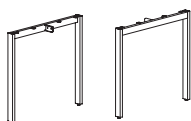

- Features:**
- use with single sided bench surface

Mid Support Frame - Single Sided	30	2	27 $\frac{7}{8}$	14	4	FLB0230-29B1-EFM	\$645
	24	2	27 $\frac{7}{8}$	14	4	FLB0224-29B1-EFM	\$632

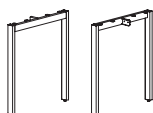

- Features:**
- use between single sided bench surfaces

Mid Support Frame - Single Sided Inline	36 $\frac{1}{4}$	2	27 $\frac{7}{8}$	15	6	FLB0237-29B1-EFM	\$721
	30 $\frac{1}{4}$	2	27 $\frac{7}{8}$	14	5	FLB0231-29B1-EFM	\$710

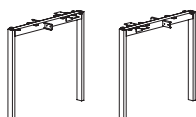

- Features:**
- use between single sided bench surfaces

FLUX - OPEN PLAN

Description	D	W	H	CTN WT	CU FT	① Model	Laminate	Flat Cut Veneer	Double Cut Veneer
End Support Panel	60	7 $\frac{3}{16}$	48	109	10	FLT0260-48B2-EPA	\$827		
	60	7 $\frac{3}{16}$	48	109	10	FLV0260-48B2-EPA		\$1,244	\$1,337
	60	7 $\frac{3}{16}$	42	97	9	FLT0260-42B2-EPA	\$800		
	60	7 $\frac{3}{16}$	42	97	9	FLV0260-42B2-EPA		\$1,209	\$1,294
	48	7 $\frac{3}{16}$	48	90	8	FLT0248-48B2-EPA	\$771		
	48	7 $\frac{3}{16}$	48	90	8	FLV0248-48B2-EPA		\$1,174	\$1,261
	48	7 $\frac{3}{16}$	42	80	7	FLT0248-42B2-EPA	\$745		
	48	7 $\frac{3}{16}$	42	80	7	FLV0248-42B2-EPA		\$1,140	\$1,228

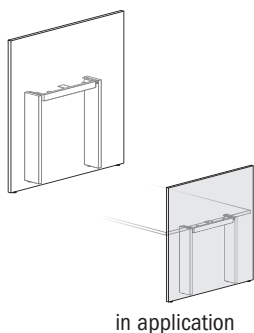

- Features:**
- use with Bench Surface or Table Surface
- Options:**
- must specify chassis grain direction on double cut veneer, see pages 42-43 for details

Description	D	W	H	CTN WT	CU FT	① Model	Laminate	Flat Cut Veneer	Double Cut Veneer
End Support Storage Cabinet - Below Worksurface	60	12 3/4	29	103	20	FLT1360-29B1-EFBS	\$1,517		
	60	12 3/4	29	103	20	FLV1360-29B1-EFBS		\$1,851	\$1,962
	48	12 3/4	29	74	16	FLT1348-29B1-EFBS	\$1,432		
	48	12 3/4	29	74	16	FLV1348-29B1-EFBS		\$1,746	\$1,850

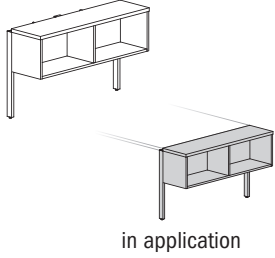

**Features:**

- use with Bench Surface or Table Surface

**Options:**

- must specify chassis grain direction on double cut veneer, see pages 42-43 for details
- on laminate units, top worksurface available in contrasting color, no upcharge, specify color

Description	D	W	H	CTN WT	CU FT	① Model	Laminate	Flat Cut Veneer	Double Cut Veneer
End Support Storage Cabinet - Above Worksurface	60	12 3/4	42	90	28	FLT1360-42B1-EFCS	\$1,571		
	60	12 3/4	42	90	28	FLV1360-42B1-EFCS		\$1,939	\$2,056
	48	12 3/4	42	78	23	FLT1348-42B1-EFCS	\$1,482		
	48	12 3/4	42	78	23	FLV1348-42B1-EFCS		\$1,829	\$1,938

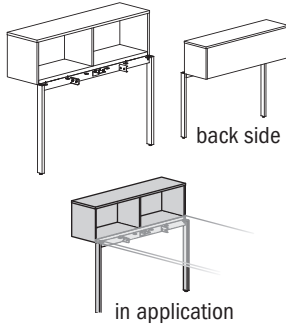

**Features:**

- use with Bench Surface or Table Surface

**Options:**

- must specify chassis grain direction on double cut veneer, see pages 42-43 for details

Description	D	W	H	CTN WT	CU FT	① Model	List Price
Tack Panel	1/2	58 1/2	13 1/8	18	3	FLB1459CSTK	\$259
	1/2	46 1/2	13 1/8	15	2	FLB1447CSTK	\$191

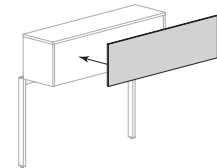

**Features:**

- mounts to back of End Support Storage Cabinet - Above Worksurface

**Options:**

- select color, ash grey or silver grey

**To Order, Specify:**

① Laminate Model #	② Laminate Type	③ Laminate Selection			④ Metal Color	⑤ Other Product Options	
Laminate (FLT)	HPL	<b>Solid Patterns:</b> ALB Alabaster BBL Bridal Blanco DWH Designer White SHD Shadow SLG Slate Grey	<b>Wood Grain Patterns:</b> AGA Aged Ash ALL Ale Light BLO Blonde Echo BOL Bourbon Light BZW Brazilwood BGL Brighton Light	CLL Collectors FLO Florence Walnut GRH Graphite HGL High Line OAT Oatmeal Cookie PIN Pinnacle Walnut	STU Studio Teak VIN Vintage WLH Walnut Heights WEA Weathered Ash	Color: ASL Arctic Silver MBK Matte Black PEW Pewter SNK Soft Nickel	See list of options for each specific unit; Specify and add accordingly.

① Veneer Model #	② Wood Species	③ Wood Finish - Finishes with an asterisk (*) have a coordinating laminate available			④ Metal Color	⑤ Other Product Options	
Veneer (FLV)	<b>Flat Cut</b> CH1 Cherry MA1 Maple WA1 Walnut	<b>Cherry:</b> BRL Barley BBM Bourbon Medium BRM Brighton Medium CLA Classic CLL Collectors*	<b>Earthy:</b> EAR Earthy HRV Harvest* LGC Legacy PRL Praline* SAF Saffron	<b>Maple:</b> ALM Ale Medium BUT Butterscotch CIN Cinnamon FLX Flax VEN Venetian	<b>Walnut:</b> AUB Auburn ESP Espresso MCH Mocha* NTO Night Owl* SIE Sienna*	Color: ASL Arctic Silver MBK Matte Black PEW Pewter SNK Soft Nickel	See list of options for each specific unit; Specify and add accordingly.
	<b>Double Cut</b> DC1 Double Cut	<b>ⓐ Wood Finish</b> Double Cut: COF Coffee FOS Fossil KHK Khaki CRM Cremello GRH Graphite STU Studio Teak		<b>ⓑ Chassis Grain Direction</b> For Double Cut Only: Vertical Horizontal			

Description	D	W	H	CTN WT	CU FT	① Model	Laminate	Flat Cut Veneer	Double Cut Veneer
End Support Four Door Storage Credenza	22	60	27 7/8	226	23	FLT2260-21B1-EFDC	\$2,250		
	22	60	27 7/8	226	23	FLV2260-21B1-EFDC		\$3,009	\$3,309
	22	48	27 7/8	186	18	FLT2248-21B1-EFDC	\$2,161		
	22	48	27 7/8	186	18	FLV2248-21B1-EFDC		\$2,837	\$3,121

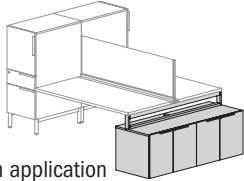
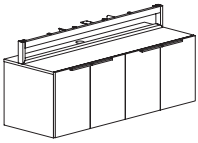

in application

**Features:**

- use with Bench Surface or Table Surface
- top grommet included
- each hinged door compartment has one adjustable shelf

**Options:**

- must specify chassis grain direction on double cut veneer, see pages 42-43 for details
- veneer door fronts available in contrasting paint color, specify paint color and add \$275 list
- laminate door fronts available in contrasting color, no upcharge, specify color; see page 44 for details
- ledge pulls standard; prism pulls available, specify and see page 39
- optional center rail for privacy screen, add \$186 list
- locking door fronts available, specify and add \$245 list

End Support Open Compartment Storage Credenza	22	60	27 7/8	194	23	FLT2260-21B1-EFEC	\$1,890		
	22	60	27 7/8	194	23	FLV2260-21B1-EFEC		\$2,538	\$2,791
	22	48	27 7/8	184	18	FLT2248-21B1-EFEC	\$1,812		
	22	48	27 7/8	184	18	FLV2248-21B1-EFEC		\$2,421	\$2,664

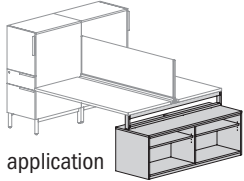
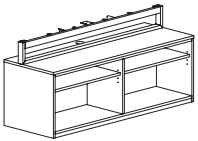

in application

**Features:**

- use with Bench Surface or Table Surface
- top grommet included
- each compartment has one adjustable shelf

**Options:**

- must specify chassis grain direction on double cut veneer, see pages 42-43 for details
- optional center rail for privacy screen, add \$186 list

End Support Four Door Storage Credenza - Flush Legs	22	60	27 7/8	177	23	FLT2260-21B1-EFDLC	\$2,056		
	22	60	27 7/8	177	23	FLV2260-21B1-EFDLC		\$2,842	\$3,070
	22	48	27 7/8	150	18	FLT2248-21B1-EFDLC	\$1,974		
	22	48	27 7/8	150	18	FLV2248-21B1-EFDLC		\$2,748	\$2,967

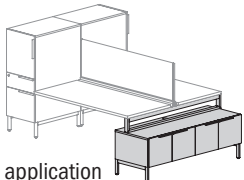
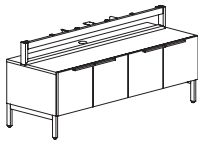

in application

**Features:**

- use with Bench Surface or Table Surface
- top grommet included

**Options:**

- must specify chassis grain direction on double cut veneer, see pages 42-43 for details
- veneer door fronts available in contrasting paint color, specify paint color and add \$275 list
- laminate door fronts available in contrasting color, no upcharge, specify color; see page 44 for details
- ledge pulls standard; prism pulls available, specify and see page 39
- optional center rail for privacy screen, add \$186 list
- locking door fronts available, specify and add \$245 list

End Support Open Compartment Storage Credenza - Flush Legs	22	60	27 7/8	159	23	FLT2260-21B1-EFELC	\$2,056		
	22	60	27 7/8	159	23	FLV2260-21B1-EFELC		\$2,528	\$2,733
	22	48	27 7/8	135	18	FLT2248-21B1-EFELC	\$1,974		
	22	48	27 7/8	135	18	FLV2248-21B1-EFELC		\$2,434	\$2,625

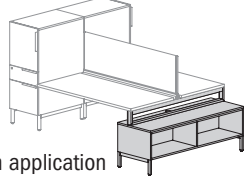
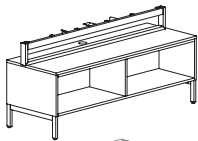

in application

**Features:**

- use with Bench Surface or Table Surface
- top grommet included

**Options:**

- must specify chassis grain direction on double cut veneer, see pages 42-43 for details
- optional center rail for privacy screen, add \$186 list

Description	D	W	H	CTN WT	CU FT	① Model	Laminate	Flat Cut Veneer	Double Cut Veneer
Mid Support Frame	60	2	27 $\frac{7}{8}$	22	6	FLB0260-29B1-EFM			\$758
	48	2	27 $\frac{7}{8}$	20	5	FLB0248-29B1-EFM			\$736

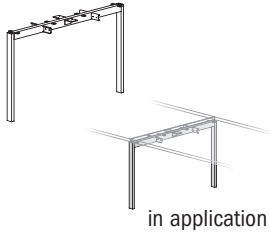

- Features:**
- use between Bench Surfaces or Table Surfaces

Mid Support Technology Cabinet	26	9	27 $\frac{7}{8}$	55	6	FLT0926-29B1-MSTC	\$1,301		
	26	9	27 $\frac{7}{8}$	55	6	FLV0926-29B1-MSTC		\$1,715	\$1,843

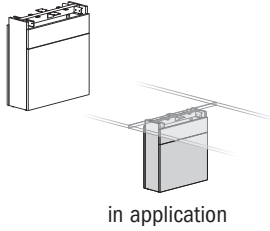

- Features:**
- use between Bench Surfaces or Table Surfaces
- Options:**
- must specify chassis grain direction on double cut veneer, see pages 42-43 for details

Description	D	W	H	CTN WT	CU FT	① Model	List Price
Mid Support Storage Tower Bracket	22	1	2	10	3	FLB2202-29B1-BRSP	\$369

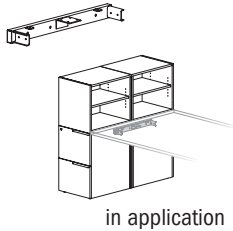

- Features:**
- use with (2) back-to-back storage towers to support Bench Surface or Table Surface

**To Order, Specify:**

① Laminate Model #	② Laminate Type	③ Laminate Selection			④ Metal Color	⑤ Other Product Options	
Laminate (FLT)	HPL	<b>Solid Patterns:</b> ALB Alabaster BBL Bridal Blanco DWH Designer White SHD Shadow SLG Slate Grey	<b>Wood Grain Patterns:</b> AGA Aged Ash ALL Ale Light BLO Blonde Echo BOL Bourbon Light BZW Brazilwood BGL Brighton Light	CLL Collectors FLO Florence Walnut GRH Graphite HGL High Line OAT Oatmeal Cookie PIN Pinnacle Walnut	STU Studio Teak VIN Vintage WLH Walnut Heights WEA Weathered Ash	Color: ASL Arctic Silver MBK Matte Black PEW Pewter SNK Soft Nickel	See list of options for each specific unit; Specify and add accordingly.

① Veneer Model #	② Wood Species	③ Wood Finish - Finishes with an asterisk (*) have a coordinating laminate available			④ Metal Color	⑤ Other Product Options		
Veneer (FLV)	<b>Flat Cut</b> CH1 Cherry MA1 Maple WA1 Walnut	<b>Cherry:</b> BRL Barley BBM Bourbon Medium BRM Brighton Medium CLA Classic CLL Collectors*	<b>Earthy:</b> EAR Earthy HRV Harvest* LGC Legacy PRL Praline* SAF Saffron	<b>Maple:</b> ALM Ale Medium BUT Butterscotch CIN Cinnamon FLX Flax VEN Venetian	<b>Walnut:</b> AUB Auburn ESP Espresso MCH Mocha* NTO Night Owl* SIE Sienna*	TOF Toffee TRF Truffle*	Color: ASL Arctic Silver MBK Matte Black PEW Pewter SNK Soft Nickel	See list of options for each specific unit; Specify and add accordingly.
	<b>Double Cut</b> DC1 Double Cut	<b>Ⓜ Wood Finish</b> Double Cut: COF Coffee CRM Cremello FOS Fossil GRH Graphite KHK Khaki STU Studio Teak		<b>Ⓜ Chassis Grain Direction</b> For Double Cut Only: Vertical Horizontal				

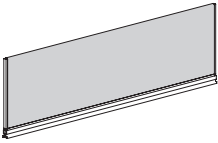
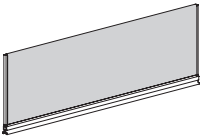
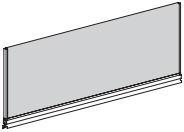
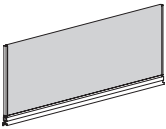

Description	D	W	H	CTN WT	CU FT	① Model	List Price Per Grade
<b>18"h x 72"w Upholstered Tackboard Privacy Screen</b> 	1	72	18 $\frac{7}{8}$	50	3	FLB72-19B1-RMTK	<b>COM</b> \$1,061 A \$1,094 B \$1,161 C \$1,279 D \$1,427 E \$1,576 F \$1,810 G \$2,059 H \$2,325 I \$2,740 J \$3,239
	<b>Features:</b> <ul style="list-style-type: none"> <li>· use with Fixed Height Bench to achieve 48" overall height</li> <li>· mounts to center rail</li> <li>· com ydg: 2<math>\frac{1}{4}</math></li> </ul>						
<b>18"h x 66"w Upholstered Tackboard Privacy Screen</b> 	1	66	18 $\frac{7}{8}$	46	3	FLB66-19B1-RMTK	<b>COM</b> \$1,033 A \$1,066 B \$1,125 C \$1,232 D \$1,368 E \$1,506 F \$1,720 G \$1,948 H \$2,192 I \$2,573 J \$3,030
	<b>Features:</b> <ul style="list-style-type: none"> <li>· use with Fixed Height Bench to achieve 48" overall height</li> <li>· mounts to center rail</li> <li>· com ydg: 2<math>\frac{1}{4}</math></li> </ul>						
<b>18"h x 60"w Upholstered Tackboard Privacy Screen</b> 	1	60	18 $\frac{7}{8}$	42	3	FLB60-19B1-RMTK	<b>COM</b> \$1,008 A \$1,036 B \$1,090 C \$1,188 D \$1,313 E \$1,438 F \$1,631 G \$1,839 H \$2,061 I \$2,407 J \$2,822
	<b>Features:</b> <ul style="list-style-type: none"> <li>· use with Fixed Height Bench to achieve 48" overall height</li> <li>· mounts to center rail</li> <li>· com ydg: 2</li> </ul>						
<b>18"h x 54"w Upholstered Tackboard Privacy Screen</b> 	1	54	18 $\frac{7}{8}$	38	3	FLB54-19B1-RMTK	<b>COM</b> \$981 A \$1,007 B \$1,057 C \$1,143 D \$1,256 E \$1,367 F \$1,542 G \$1,729 H \$1,929 I \$2,240 J \$2,614
	<b>Features:</b> <ul style="list-style-type: none"> <li>· use with Fixed Height Bench to achieve 48" overall height</li> <li>· mounts to center rail</li> <li>· com ydg: 2</li> </ul>						

FLUX - OPEN PLAN

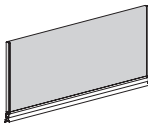
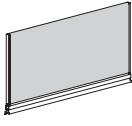
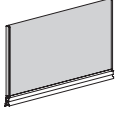
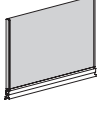
Description	D	W	H	CTN WT	CU FT	① Model	List Price Per Grade	
<b>18" h x 48" w Upholstered Tackboard Privacy Screen</b>  	1	48	18 7/8	35	2	FLB48-19B1-RMTK	COM \$948	
	<b>Features:</b>							A \$971
	· use with Fixed Height Bench to achieve 48" overall height							B \$1,016
	· mounts to center rail							C \$1,092
	· com ydg: 1 3/4							D \$1,193
								E \$1,292
								F \$1,447
								G \$1,614
								H \$1,790
								I \$2,068
								J \$2,400
	<b>18" h x 42" w Upholstered Tackboard Privacy Screen</b>  	1	42	18 7/8	31	2	FLB42-19B1-RMTK	COM \$921
<b>Features:</b>							A \$940	
· use with Fixed Height Bench to achieve 48" overall height							B \$980	
· mounts to center rail							C \$1,047	
· com ydg: 1 1/2							D \$1,135	
							E \$1,223	
							F \$1,357	
							G \$1,503	
							H \$1,658	
							I \$1,901	
							J \$2,192	
<b>18" h x 36" w Upholstered Tackboard Privacy Screen</b>  		1	36	18 7/8	28	2	FLB36-19B1-RMTK	COM \$893
	<b>Features:</b>							A \$910
	· use with Fixed Height Bench to achieve 48" overall height							B \$944
	· mounts to center rail							C \$1,001
	· com ydg: 1 1/2							D \$1,077
								E \$1,151
								F \$1,268
								G \$1,392
								H \$1,525
								I \$1,732
								J \$1,983
	<b>18" h x 30" w Upholstered Tackboard Privacy Screen</b>  	1	30	18 7/8	23	2	FLB30-19B1-RMTK	COM \$879
<b>Features:</b>							A \$896	
· use with Fixed Height Bench to achieve 48" overall height							B \$930	
· mounts to center rail							C \$988	
· com ydg: 1 1/4							D \$1,063	
							E \$1,138	
							F \$1,254	
							G \$1,379	
							H \$1,511	
							I \$1,719	
							J \$1,969	



**To Order, Specify:**

① Model Number	② Fabric Selection
(FLB)	Vendor Pattern Color   See a selection of graded in fabric manufacturers and patterns on pages 19-27. Contact Customer Service for additional fabric options.

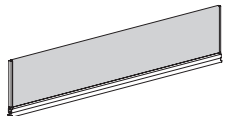
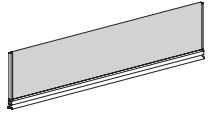
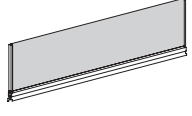
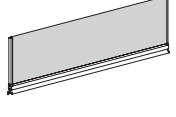
FLUX - OPEN PLAN

Description	D	W	H	CTN WT	CU FT	① Model	List Price Per Grade
<b>12"h x 72"w Upholstered Tackboard Privacy Screen</b> 	1	72	12 $\frac{7}{8}$	38	2	FLB72-13B1-RMTK	<b>COM</b> \$1,011 A \$1,044 B \$1,111 C \$1,228 D \$1,377 E \$1,526 F \$1,759 G \$2,009 H \$2,274 I \$2,689 J \$3,188
	<b>Features:</b> <ul style="list-style-type: none"> <li>· use with Fixed Height Bench to achieve 42" overall height</li> <li>· mounts to center rail</li> <li>· com ydg: 2<math>\frac{1}{4}</math></li> </ul>						
<b>12"h x 66"w Upholstered Tackboard Privacy Screen</b> 	1	66	12 $\frac{7}{8}$	35	2	FLB66-13B1-RMTK	<b>COM</b> \$988 A \$1,020 B \$1,080 C \$1,186 D \$1,324 E \$1,461 F \$1,675 G \$1,903 H \$2,146 I \$2,528 J \$2,985
	<b>Features:</b> <ul style="list-style-type: none"> <li>· use with Fixed Height Bench to achieve 42" overall height</li> <li>· mounts to center rail</li> <li>· com ydg: 2<math>\frac{1}{4}</math></li> </ul>						
<b>12"h x 60"w Upholstered Tackboard Privacy Screen</b> 	1	60	12 $\frac{7}{8}$	32	2	FLB60-13B1-RMTK	<b>COM</b> \$965 A \$993 B \$1,048 C \$1,145 D \$1,271 E \$1,395 F \$1,590 G \$1,798 H \$2,019 I \$2,364 J \$2,780
	<b>Features:</b> <ul style="list-style-type: none"> <li>· use with Fixed Height Bench to achieve 42" overall height</li> <li>· mounts to center rail</li> <li>· com ydg: 2</li> </ul>						
<b>12"h x 54"w Upholstered Tackboard Privacy Screen</b> 	1	54	12 $\frac{7}{8}$	29	2	FLB54-13B1-RMTK	<b>COM</b> \$942 A \$968 B \$1,019 C \$1,105 D \$1,219 E \$1,330 F \$1,504 G \$1,692 H \$1,891 I \$2,202 J \$2,576
	<b>Features:</b> <ul style="list-style-type: none"> <li>· use with Fixed Height Bench to achieve 42" overall height</li> <li>· mounts to center rail</li> <li>· com ydg: 2</li> </ul>						

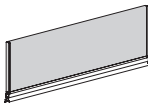
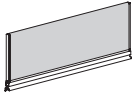
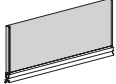
FLUX - OPEN PLAN

Description	D	W	H	CTN WT	CU FT	① Model	List Price Per Grade
<b>12" h x 48" w Upholstered Tackboard Privacy Screen</b> 	1	48	12 7/8	26	2	FLB48-13B1-RMTK	<b>COM \$915</b> A \$937 B \$982 C \$1,059 D \$1,159 E \$1,258 F \$1,413 G \$1,579 H \$1,757 I \$2,034 J \$2,366
<b>Features:</b> <ul style="list-style-type: none"> <li>· use with Fixed Height Bench to achieve 42" overall height</li> <li>· mounts to center rail</li> <li>· com ydg: 1 3/4</li> </ul>							
<b>12" h x 42" w Upholstered Tackboard Privacy Screen</b> 	1	42	12 7/8	23	2	FLB42-13B1-RMTK	<b>COM \$891</b> A \$911 B \$950 C \$1,018 D \$1,105 E \$1,193 F \$1,328 G \$1,473 H \$1,628 I \$1,871 J \$2,162
<b>Features:</b> <ul style="list-style-type: none"> <li>· use with Fixed Height Bench to achieve 42" overall height</li> <li>· mounts to center rail</li> <li>· com ydg: 1 1/2</li> </ul>							
<b>12" h x 36" w Upholstered Tackboard Privacy Screen</b> 	1	36	12 7/8	21	1	FLB36-13B1-RMTK	<b>COM \$868</b> A \$885 B \$919 C \$977 D \$1,051 E \$1,127 F \$1,242 G \$1,366 H \$1,500 I \$1,708 J \$1,958
<b>Features:</b> <ul style="list-style-type: none"> <li>· use with Fixed Height Bench to achieve 42" overall height</li> <li>· mounts to center rail</li> <li>· com ydg: 1 1/2</li> </ul>							
<b>12" h x 30" w Upholstered Tackboard Privacy Screen</b> 	1	30	12 7/8	18	1	FLB30-13B1-RMTK	<b>COM \$859</b> A \$875 B \$909 C \$967 D \$1,042 E \$1,117 F \$1,233 G \$1,357 H \$1,490 I \$1,698 J \$1,948
<b>Features:</b> <ul style="list-style-type: none"> <li>· use with Fixed Height Bench to achieve 42" overall height</li> <li>· mounts to center rail</li> <li>· com ydg: 1 1/4</li> </ul>							

**To Order, Specify:**

① Model Number	② Fabric Selection	
(FLB)	Vendor Pattern Color	See a selection of graded in fabric manufacturers and patterns on pages 19-27. Contact Customer Service for additional fabric options.

FLUX - OPEN PLAN

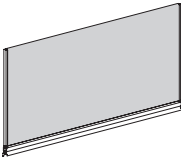
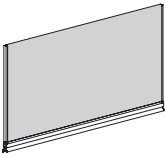
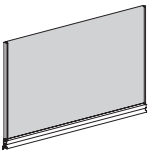
Description	D	W	H	CTN WT	CU FT	① Model	List Price Per Grade
<b>26" h x 60" w Upholstered Tackboard Privacy Screen</b> 	15/16	59 5/8	25 3/4	55	3	FLB60-26B1-RMTK	<b>COM</b> \$1,048
	<b>Features:</b>						A \$1,077
	· use with End Support Credenza to achieve 48" overall height						B \$1,132
	· mounts to center rail which must be ordered with End Support Credenza						C \$1,229
	· com ydg: 2						D \$1,354
							E \$1,479
							F \$1,672
							G \$1,880
							H \$2,102
							I \$2,448
						J \$2,864	
<b>26" h x 54" w Upholstered Tackboard Privacy Screen</b> 	15/16	53 5/8	25 3/4	50	3	FLB54-26B1-RMTK	<b>COM</b> \$1,019
	<b>Features:</b>						A \$1,044
	· use with End Support Credenza to achieve 48" overall height						B \$1,094
	· mounts to center rail which must be ordered with End Support Credenza						C \$1,181
	· com ydg: 2						D \$1,294
							E \$1,406
							F \$1,579
							G \$1,768
							H \$1,967
							I \$2,278
						J \$2,653	
<b>26" h x 48" w Upholstered Tackboard Privacy Screen</b> 	15/16	47 5/8	25 3/4	45	3	FLB48-26B1-RMTK	<b>COM</b> \$981
	<b>Features:</b>						A \$1,005
	· use with End Support Credenza to achieve 48" overall height						B \$1,048
	· mounts to center rail which must be ordered with End Support Credenza						C \$1,125
	· com ydg: 1 3/4						D \$1,226
							E \$1,325
							F \$1,480
							G \$1,647
							H \$1,823
							I \$2,101
						J \$2,434	

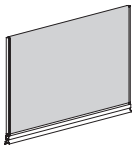
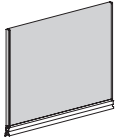
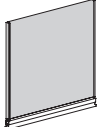
Description	D	W	H	CTN WT	CU FT	① Model	List Price Per Grade
26" h x 42" w Upholstered Tackboard Privacy Screen  	15 1/16	41 5/8	25 3/4	40	3	FLB42-26B1-RMTK	COM \$950
	<b>Features:</b>						A \$970
	· use with End Support Credenza to achieve 48" overall height						B \$1,010
	· mounts to center rail which must be ordered with End Support Credenza						C \$1,077
	· com ydg: 1 1/2						D \$1,165
							E \$1,252
							F \$1,387
							G \$1,533
							H \$1,687
							I \$1,930
						J \$2,222	
26" h x 36" w Upholstered Tackboard Privacy Screen  	15 1/16	35 5/8	25 3/4	35	2	FLB36-26B1-RMTK	COM \$919
	<b>Features:</b>						A \$935
	· use with End Support Credenza to achieve 48" overall height						B \$969
	· mounts to center rail which must be ordered with End Support Credenza						C \$1,027
	· com ydg: 1 1/2						D \$1,102
							E \$1,177
							F \$1,293
							G \$1,417
							H \$1,550
							I \$1,758
						J \$2,009	
26" h x 30" w Upholstered Tackboard Privacy Screen  	15 1/16	29 5/8	25 3/4	30	2	FLB30-26B1-RMTK	COM \$901
	<b>Features:</b>						A \$918
	· use with End Support Credenza to achieve 48" overall height						B \$952
	· mounts to center rail which must be ordered with End Support Credenza						C \$1,010
	· com ydg: 1 1/4						D \$1,084
							E \$1,159
							F \$1,275
							G \$1,400
							H \$1,533
							I \$1,740
						J \$1,990	

**To Order, Specify:**

① Model Number	② Fabric Selection	
(FLB)	Vendor Pattern Color	See a selection of graded in fabric manufacturers and patterns on pages 19-27. Contact Customer Service for additional fabric options.

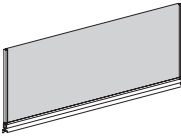
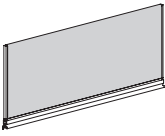
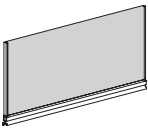
Description	D	W	H	CTN WT	CU FT	① Model	List Price Per Grade	
20"h x 60"w Upholstered Tackboard Privacy Screen  	15 <sup>1</sup> / <sub>16</sub>	59 <sup>5</sup> / <sub>16</sub>	19 <sup>3</sup> / <sub>4</sub>	44	3	FLB60-20B1-RMTK	<b>COM</b> \$1,008	
	<b>Features:</b>							A \$1,036
	· use with End Support Credenza to achieve 42" overall height							B \$1,090
	· mounts to center rail which must be ordered with End Support Credenza							C \$1,188
	· com ydg: 2							D \$1,313
								E \$1,438
								F \$1,631
								G \$1,839
								H \$2,061
								I \$2,407
							J \$2,822	
20"h x 54"w Upholstered Tackboard Privacy Screen  	15 <sup>1</sup> / <sub>16</sub>	53 <sup>5</sup> / <sub>16</sub>	19 <sup>3</sup> / <sub>4</sub>	40	3	FLB54-20B1-RMTK	<b>COM</b> \$981	
	<b>Features:</b>							A \$1,007
	· use with End Support Credenza to achieve 42" overall height							B \$1,057
	· mounts to center rail which must be ordered with End Support Credenza							C \$1,143
	· com ydg: 2							D \$1,256
								E \$1,367
								F \$1,542
								G \$1,729
								H \$1,929
								I \$2,240
							J \$2,614	
20"h x 48"w Upholstered Tackboard Privacy Screen  	15 <sup>1</sup> / <sub>16</sub>	47 <sup>5</sup> / <sub>16</sub>	19 <sup>3</sup> / <sub>4</sub>	36	2	FLB48-20B1-RMTK	<b>COM</b> \$948	
	<b>Features:</b>							A \$971
	· use with End Support Credenza to achieve 42" overall height							B \$1,016
	· mounts to center rail which must be ordered with End Support Credenza							C \$1,092
	· com ydg: 1 <sup>3</sup> / <sub>4</sub>							D \$1,193
								E \$1,292
								F \$1,447
								G \$1,614
								H \$1,790
								I \$2,068
							J \$2,400	

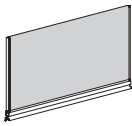
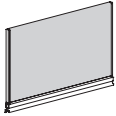
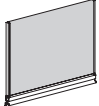
Description	D	W	H	CTN WT	CU FT	① Model	List Price Per Grade	
<b>20" h x 42" w Upholstered Tackboard Privacy Screen</b>  	15 <sup>1</sup> / <sub>16</sub>	41 <sup>5</sup> / <sub>8</sub>	19 <sup>3</sup> / <sub>4</sub>	33	2	FLB42-20B1-RMTK	COM \$921	
	<b>Features:</b>							A \$940
	· use with End Support Credenza to achieve 42" overall height							B \$980
	· mounts to center rail which must be ordered with End Support Credenza							C \$1,047
	· com ydg: 1 1/2							D \$1,135
								E \$1,223
								F \$1,357
								G \$1,503
								H \$1,658
								I \$1,901
								J \$2,192
<b>20" h x 36" w Upholstered Tackboard Privacy Screen</b>  	15 <sup>1</sup> / <sub>16</sub>	35 <sup>5</sup> / <sub>8</sub>	19 <sup>3</sup> / <sub>4</sub>	29	2	FLB36-20B1-RMTK	COM \$893	
	<b>Features:</b>							A \$910
	· use with End Support Credenza to achieve 42" overall height							B \$944
	· mounts to center rail which must be ordered with End Support Credenza							C \$1,001
	· com ydg: 1 1/2							D \$1,077
								E \$1,151
								F \$1,268
								G \$1,392
								H \$1,525
								I \$1,732
								J \$1,983
<b>20" h x 30" w Upholstered Tackboard Privacy Screen</b>  	15 <sup>1</sup> / <sub>16</sub>	29 <sup>5</sup> / <sub>8</sub>	19 <sup>3</sup> / <sub>4</sub>	25	2	FLB30-20B1-RMTK	COM \$879	
	<b>Features:</b>							A \$896
	· use with End Support Credenza to achieve 42" overall height							B \$930
	· mounts to center rail which must be ordered with End Support Credenza							C \$988
	· com ydg: 1 1/4							D \$1,063
								E \$1,138
								F \$1,254
								G \$1,379
								H \$1,511
								I \$1,719
								J \$1,969

**To Order, Specify:**

① Model Number	② Fabric Selection	
(FLB)	Vendor Pattern Color	See a selection of graded in fabric manufacturers and patterns on pages 19-27. Contact Customer Service for additional fabric options.



Description	D	W	H	CTN WT	CU FT	① Model	List Price
<b>18" h Acrylic Privacy Screen</b> 	¼	71%	18%	23	4	FLB72-19B1-APS	\$1,048
	¼	65%	18%	21	4	FLB66-19B1-APS	\$961
	¼	59%	18%	19	3	FLB60-19B1-APS	\$883
	¼	53%	18%	18	3	FLB54-19B1-APS	\$801
	¼	47%	18%	16	3	FLB48-19B1-APS	\$719
	¼	41%	18%	15	3	FLB42-19B1-APS	\$636
	¼	35%	18%	12	3	FLB36-19B1-APS	\$555
	¼	29%	18%	11	3	FLB30-19B1-APS	\$473

**Features:**

- use with Fixed Height Bench to achieve 48" overall height
- mounts to center rail; see page 486 for details

<b>12" h Acrylic Privacy Screen</b> 	¼	71%	12%	18	3	FLB72-13B1-APS	\$781
	¼	65%	12%	17	3	FLB66-13B1-APS	\$716
	¼	59%	12%	16	3	FLB60-13B1-APS	\$660
	¼	53%	12%	11	3	FLB54-13B1-APS	\$600
	¼	47%	12%	14	2	FLB48-13B1-APS	\$541
	¼	41%	12%	13	2	FLB42-13B1-APS	\$480
	¼	35%	12%	12	2	FLB36-13B1-APS	\$420
	¼	29%	12%	11	2	FLB30-13B1-APS	\$362

**Features:**

- use with Fixed Height Bench to achieve 42" overall height
- mounts to center rail; see page 486 for details

Description	D	W	H	CTN WT	CU FT	① Model	List Price
26" h Acrylic Privacy Screen - End Support Credenza	¼	59 ⅝	25 ¾	14	5	FLB60-26B1-APS	\$1,030
	¼	47 ⅝	25 ¾	17	4	FLB48-26B1-APS	\$924

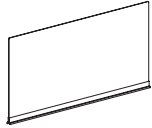

**Features:**

- use with End Support Credenza to achieve 48" overall height
- mounts to center rail; see page 486 for details which must be ordered with End Support Credenza

20" h Acrylic Privacy Screen -End Support Credenza	¼	59 ⅝	19 ¾	18	4	FLB54-20B1-APS	\$830
	¼	47 ⅝	19 ¾	17	3	FLB48-20B1-APS	\$746



**Features:**

- use with End Support Credenza to achieve 42" overall height
- mounts to center rail; see page 486 for details which must be ordered with End Support Credenza

**To Order, Specify:**

① Laminate Model #	② Laminate Selection	③ Metal Color	④ Other Product Options
Laminate (FLT)	<p>Solid Patterns:</p> <p>ALB Alabaster BBL Bridal Blanco DWH Designer White SHD Shadow SLG Slate Grey</p> <p>Wood Grain Patterns:</p> <p>AGA Aged Ash ALL Ale Light BLO Blonde Echo BOL Bourbon Light BZW Brazilwood BGL Brighton Light</p> <p>CLL Collectors FLO Florence Walnut GRH Graphite HGL High Line OAT Oatmeal Cookie PIN Pinnacle Walnut</p> <p>STU Studio Teak VIN Vintage WLH Walnut Heights WEA Weathered Ash</p>	<p>Color:</p> <p>ASL Arctic Silver MBK Matte Black PEW Pewter SNK Soft Nickel</p>	See list of options for each specific unit; Specify and add accordingly.

① Veneer Model #	② Wood Species	③ Wood Finish - Finishes with an asterisk (*) have a coordinating laminate available	④ Metal Color	⑤ Other Product Options
Veneer (FLV)	<p>Flat Cut</p> <p>CH1 Cherry MA1 Maple WA1 Walnut</p>	<p>Cherry:</p> <p>BRL Barley BBM Bourbon Medium BRM Brighton Medium CLA Classic CLL Collectors*</p> <p>EAR Earthy HRV Harvest* LGC Legacy PRL Praline* SAF Saffron</p> <p>Maple:</p> <p>ALM Ale Medium BUT Butterscotch CIN Cinnamon FLX Flax VEN Venetian</p> <p>Walnut:</p> <p>AUB Auburn ESP Espresso MCH Mocha* NTO Night Owl* SIE Sienna*</p> <p>TOF Toffee TRF Truffle*</p>	<p>Color:</p> <p>ASL Arctic Silver MBK Matte Black PEW Pewter SNK Soft Nickel</p>	See list of options for each specific unit; Specify and add accordingly.
	<p>Double Cut</p> <p>DC1 Double Cut</p>	<p>ⓐ Wood Finish</p> <p>Double Cut:</p> <p>COF Coffee CRM Cremello</p> <p>FOS Fossil GRH Graphite</p> <p>KHK Khaki STU Studio Teak</p> <p>ⓑ Chassis Grain Direction</p> <p>For Double Cut Only:</p> <p>Vertical Horizontal</p>		

FLUX - OPEN PLAN

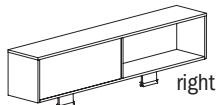
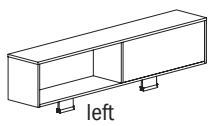
Description	D	W	H	CTN WT	CU FT	① Model	Laminate	Flat Cut Veneer	Double Cut Veneer
Center Mount Storage Cabinet - Dual Sided Open Compartments	12 3/4	72	19	90	16	FLT1372-19B1-CMSUR	\$842		
	12 3/4	72	19	90	16	FLV1372-19B1-CMSUR		\$1,409	\$1,593
	12 3/4	72	19	90	16	FLT1372-19B1-CMSUL	\$842		
	12 3/4	72	19	90	16	FLV1372-19B1-CMSUL		\$1,409	\$1,593
	12 3/4	66	19	85	15	FLT1366-19B1-CMSUR	\$786		
	12 3/4	66	19	85	15	FLV1366-19B1-CMSUR		\$1,310	\$1,480
	12 3/4	66	19	85	15	FLT1366-19B1-CMSUL	\$786		
	12 3/4	66	19	85	15	FLV1366-19B1-CMSUL		\$1,310	\$1,480
	12 3/4	60	19	80	14	FLT1360-19B1-CMSUR	\$742		
	12 3/4	60	19	80	14	FLV1360-19B1-CMSUR		\$1,233	\$1,393
	12 3/4	60	19	80	14	FLT1360-19B1-CMSUL	\$742		
	12 3/4	60	19	80	14	FLV1360-19B1-CMSUL		\$1,233	\$1,393
	12 3/4	54	19	75	12	FLT1354-19B1-CMSUR	\$707		
	12 3/4	54	19	75	12	FLV1354-19B1-CMSUR		\$1,180	\$1,333
	12 3/4	54	19	75	12	FLT1354-19B1-CMSUL	\$707		
	12 3/4	54	19	75	12	FLV1354-19B1-CMSUL		\$1,180	\$1,333
	12 3/4	48	19	66	11	FLT1348-19B1-CMSUR	\$679		
	12 3/4	48	19	66	11	FLV1348-19B1-CMSUR		\$1,136	\$1,284
	12 3/4	48	19	66	11	FLT1348-19B1-CMSUL	\$679		
	12 3/4	48	19	66	11	FLV1348-19B1-CMSUL		\$1,136	\$1,284
	12 3/4	42	19	59	10	FLT1342-19B1-CMSUR	\$654		
	12 3/4	42	19	59	10	FLV1342-19B1-CMSUR		\$1,091	\$1,255
	12 3/4	42	19	59	10	FLT1342-19B1-CMSUL	\$654		
	12 3/4	42	19	59	10	FLV1342-19B1-CMSUL		\$1,091	\$1,255
	12 3/4	36	19	57	9	FLT1336-19B1-CMSUR	\$625		
	12 3/4	36	19	57	9	FLV1336-19B1-CMSUR		\$86	\$985
	12 3/4	36	19	57	9	FLT1336-19B1-CMSUL	\$625		
	12 3/4	36	19	57	9	FLV1336-19B1-CMSUL		\$857	\$985

**Features:**

- use with Fixed Height Bench to achieve 48" overall height
- mounts to center rail
- two open compartments - one facing each side

**Options:**

- must specify chassis grain direction on double cut veneer, see pages 42-43 for details

Description	D	W	H	CTN WT	CU FT	① Model	List Price
Tack Panel 	1/2	34 7/8	12 5/8	13	2	FLB35-13B1-FTK	\$151
	1/2	31 7/8	12 5/8	12	2	FLB32-13B1-FTK	\$137
	1/2	28 7/8	12 5/8	12	2	FLB29-13B1-FTK	\$125
	1/2	25 7/8	12 5/8	11	2	FLB26-13B1-FTK	\$117
	1/2	22 7/8	12 5/8	10	1	FLB23-13B1-FTK	\$101
	1/2	18 7/8	12 5/8	10	1	FLB20-13B1-FTK	\$94
	1/2	16 7/8	12 5/8	10	1	FLB17-13B1-FTK	\$79

- Features:**
- mounts to back of Center Mount Storage Cabinet
- Options:**
- select color, ash grey or silver grey

Description	D	W	H	CTN WT	CU FT	① Model	List Price
Markerboard 	1/2	36 3/8	14	12	2	FLB37-14B1-AMB	\$288
	1/2	33 3/8	14	11	2	FLB34-14B1-AMB	\$280
	1/2	30 3/8	14	11	2	FLB31-14B1-AMB	\$270
	1/2	27 3/8	14	9	2	FLB28-14B1-AMB	\$261
	1/2	24 3/8	14	9	1	FLB25-14B1-AMB	\$253
	1/2	21 3/8	14	10	1	FLB22-14B1-AMB	\$245
	1/2	18 3/8	14	9	1	FLB19-14B1-AMB	\$236

- Features:**
- mounts to back of Center Mount Storage Cabinet
  - markerboard laminate with silver PVC edge

**To Order, Specify:**

① Laminate Model #	② Laminate Selection	③ Metal Color	④ Other Product Options
Laminate (FLT)	Solid Patterns: ALB Alabaster BBL Bridal Blanco DWH Designer White SHD Shadow SLG Slate Grey  Wood Grain Patterns: AGA Aged Ash ALL Ale Light BLO Blonde Echo BOL Bourbon Light BZW Brazilwood BGL Brighton Light CLL Collectors FLO Florence Walnut GRH Graphite HGL High Line OAT Oatmeal Cookie PIN Pinnacle Walnut STU Studio Teak VIN Vintage WLH Walnut Heights WEA Weathered Ash	Color: ASL Arctic Silver MBK Matte Black PEW Pewter SNK Soft Nickel	See list of options for each specific unit; Specify and add accordingly.

① Veneer Model #	② Wood Species	③ Wood Finish - Finishes with an asterisk (*) have a coordinating laminate available	④ Metal Color	⑤ Other Product Options
Veneer (FLV)	Flat Cut CH1 Cherry MA1 Maple WA1 Walnut	Cherry: BRL Barley BBM Bourbon Medium BRM Brighton Medium CLA Classic CLL Collectors* EAR Earthy HRV Harvest* LGC Legacy PRL Praline* SAF Saffron Maple: ALM Ale Medium BUT Butterscotch CIN Cinnamon FLX Flax VEN Venetian Walnut: AUB Auburn ESP Espresso MCH Mocha* NTO Night Owl* SIE Sienna* TOF Toffee TRF Truffle*	Color: ASL Arctic Silver MBK Matte Black PEW Pewter SNK Soft Nickel	See list of options for each specific unit; Specify and add accordingly.
	Double Cut DC1 Double Cut	③a Wood Finish Double Cut: COF Coffee CRM Cremello FOS Fossil GRH Graphite KHK Khaki STU Studio Teak	③b Chassis Grain Direction For Double Cut Only: Vertical Horizontal	

FLUX - OPEN PLAN

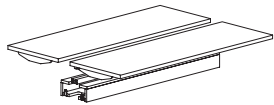
Description	D	W	H	CTN WT	CU FT	① Model	Laminate	Flat Cut Veneer	Double Cut Veneer
Adjustable Height Bench Surface - Dual Sided 	60	72	Adj.	267	88	FLT6072-29B3-2-WS	\$3,738		
	60	72	Adj.	267	88	FLV6072-29B3-2-WS		\$4,361	\$4,579
	60	66	Adj.	26	81	FLT6066-29B3-2-WS	\$3,627		
	60	66	Adj.	267	81	FLV6066-29B3-2-WS		\$4,231	\$4,443
	60	60	Adj.	242	74	FLT6060-29B3-2-WS	\$3,518		
	60	60	Adj.	242	74	FLV6060-29B3-2-WS		\$4,103	\$4,309
	60	54	Adj.	217	55	FLT6054-29B3-2-WS	\$3,413		
	60	54	Adj.	217	55	FLV6054-29B3-2-WS		\$3,980	\$4,180
	60	48	Adj.	392	60	FLT6048-29B3-2-WS	\$3,310		
	60	48	Adj.	392	60	FLV6048-29B3-2-WS		\$3,861	\$4,054
	60	42	Adj.	125	13	FLT6042-29B3-2-WS	\$3,261		
	60	42	Adj.	125	13	FLV6042-29B3-2-WS		\$3,804	\$3,993
	60	36	Adj.	107	11	FLT6036-29B3-2-WS	\$3,212		
	60	36	Adj.	107	11	FLV6036-29B3-2-WS		\$3,747	\$3,934
	48	72	Adj.	463	71	FLT4872-29B3-2-WS	\$3,630		
	48	72	Adj.	463	71	FLV4872-29B3-2-WS		\$4,235	\$4,447
	48	66	Adj.	240	66	FLT4866-29B3-2-WS	\$3,521		
	48	66	Adj.	240	66	FLV4866-29B3-2-WS		\$4,108	\$4,312
	48	60	Adj.	218	60	FLT4860-29B3-2-WS	\$3,416		
	48	60	Adj.	218	60	FLV4860-29B3-2-WS		\$3,985	\$4,184
	48	54	Adj.	195	55	FLT4854-29B3-2-WS	\$3,313		
	48	54	Adj.	195	55	FLV4854-29B3-2-WS		\$3,865	\$4,058
	48	48	Adj.	373	49	FLT4848-29B3-2-WS	\$3,213		
	48	48	Adj.	373	49	FLV4848-29B3-2-WS		\$3,750	\$3,936
	48	42	Adj.	108	12	FLT4842-29B3-2-WS	\$3,164		
	48	42	Adj.	108	12	FLV4842-29B3-2-WS		\$3,694	\$3,877
	48	36	Adj.	93	11	FLT4836-29B3-2-WS	\$3,117		
	48	36	Adj.	93	11	FLV4836-29B3-2-WS		\$3,637	\$3,819

**Features:**

- ends must attach to Adjustable Height End Support or Mid Support or Outward Facing Adjustable Height Credenza Support
- eased edge profile on user sides
- 29 1/4" to 47 1/4" height adjustment
- center rail
- wire trough with hinged lid

**Options:**

- on laminate units, worksurface available in contrasting color, no upcharge, specify color; see page 44 for details
- power harness kit available, specify and add \$328 list; receptacles and infeeds ordered separately, see page 559
- wireless charging unit available, specify location(s), see page 485; EC33 unit must be ordered separately, see page 560
- privacy screens available for center rail; order screen separately, 12" less than width of bench surface; see page 487 for details
- edge mount privacy screens available, order screen separately, 12" less than width of bench surface; see page 487 for details

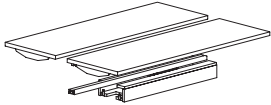
Description	D	W	H	CTN WT	CU FT	① Model	Laminate	Flat Cut Veneer	Double Cut Veneer
Adjustable Height Bench Surface - Dual Sided - Inward Credenza Mount 	60	72	Adj.	20	88	FLT6072-29B3-2-WSIN	\$3,738		
	60	72	Adj.	20	88	FLV6072-29B3-2-WSIN		\$4,361	\$4,579
	60	66	Adj.	20	81	FLT6066-29B3-2-WSIN	\$3,627		
	60	66	Adj.	20	81	FLV6066-29B3-2-WSIN		\$4,231	\$4,443
	60	60	Adj.	20	74	FLT6060-29B3-2-WSIN	\$3,518		
	60	60	Adj.	20	74	FLV6060-29B3-2-WSIN		\$4,103	\$4,309
	60	54	Adj.	20	67	FLT6054-29B3-2-WSIN	\$3,413		
	60	54	Adj.	20	67	FLV6054-29B3-2-WSIN		\$3,980	\$4,180
	48	72	Adj.	20	71	FLT4872-29B3-2-WSIN	\$3,630		
	48	72	Adj.	20	71	FLV4872-29B3-2-WSIN		\$4,235	\$4,447
	48	66	Adj.	20	66	FLT4866-29B3-2-WSIN	\$3,521		
	48	66	Adj.	20	66	FLV4866-29B3-2-WSIN		\$4,108	\$4,312
	48	60	Adj.	20	60	FLT4860-29B3-2-WSIN	\$3,416		
	48	60	Adj.	20	60	FLV4860-29B3-2-WSIN		\$3,985	\$4,184
	48	54	Adj.	20	55	FLT4854-29B3-2-WSIN	\$3,313		
	48	54	Adj.	20	55	FLV4854-29B3-2-WSIN		\$3,865	\$4,058

**Features:**

- one end must attach to Inward Facing Adjustable Height Credenza Support and other end must attach to Adjustable Height End Support or Mid Support
- eased edge profile on user sides
- 29 1/4" to 47 1/4" height adjustment
- center rail
- wire trough with hinged lid

**Options:**

- on laminate units, worksurface available in contrasting color, no upcharge, specify color; see page 44 for details
- power harness kit available, specify and add \$328 list; receptacles and infeeds ordered separately, see page 559
- wireless charging unit available, specify "to accommodate EC33"; EC33 unit must be ordered separately
- privacy screens available for center rail; order screen separately, 12" less than width of bench surface; see page 487 for details
- edge mount privacy screens available, order screen separately, 12" less than width of bench surface; see page 487 for details

**To Order, Specify:**

① Laminate Model #	② Laminate Type	③ Laminate Selection			④ Metal Color	⑤ Other Product Options	
Laminate (FLT)	HPL	<b>Solid Patterns:</b> ALB Alabaster BBL Bridal Blanco DWH Designer White SHD Shadow SLG Slate Grey	<b>Wood Grain Patterns:</b> AGA Aged Ash ALL Ale Light BLO Blonde Echo BOL Bourbon Light BZW Brazilwood BGL Brighton Light	CLL Collectors FLO Florence Walnut GRH Graphite HGL High Line OAT Oatmeal Cookie PIN Pinnacle Walnut	STU Studio Teak VIN Vintage WLH Walnut Heights WEA Weathered Ash	Color: ASL Arctic Silver MBK Matte Black PEW Pewter SNK Soft Nickel	See list of options for each specific unit; Specify and add accordingly.

① Veneer Model #	② Wood Species	③ Wood Finish - Finishes with an asterisk (*) have a coordinating laminate available			④ Metal Color	⑤ Other Product Options		
Veneer (FLV)	<b>Flat Cut</b> CH1 Cherry MA1 Maple WA1 Walnut	<b>Cherry:</b> BRL Barley BBM Bourbon Medium BRM Brighton Medium CLA Classic CLL Collectors*	<b>Earthy:</b> EAR Earthy HRV Harvest* LGC Legacy PRL Praline* SAF Saffron	<b>Maple:</b> ALM Ale Medium BUT Butterscotch CIN Cinnamon FLX Flax VEN Venetian	<b>Walnut:</b> AUB Auburn ESP Espresso MCH Mocha* NTO Night Owl* SIE Sienna*	TOF Toffee TRF Truffle*	Color: ASL Arctic Silver MBK Matte Black PEW Pewter SNK Soft Nickel	See list of options for each specific unit; Specify and add accordingly.
	<b>Double Cut</b> DC1 Double Cut	<b>Wood Finish</b> Double Cut: COF Coffee CRM Cremello FOS Fossil GRH Graphite KHK Khaki STU Studio Teak		<b>Chassis Grain Direction</b> For Double Cut Only: Vertical Horizontal				

Description	D	W	H	CTN WT	CU FT	① Model	Laminate	Flat Cut Veneer	Double Cut Veneer
Adjustable Height End Support	60	4 ½	Adj.	146	10	FLT0560-29B3-EPAH	\$2,432		
	60	4 ½	Adj.	146	10	FLV0560-29B3-EPAH		\$2,870	\$3,014
	48	4 ½	Adj.	133	8	FLT0548-29B3-EPAH	\$2,385		
	48	4 ½	Adj.	133	8	FLV0548-29B3-EPAH		\$2,814	\$2,954

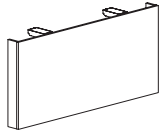
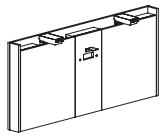

**Features:**

- use with Adjustable Height Bench Surface

**Options:**

- must specify chassis grain direction on double cut veneer, see pages 42-43 for details

Adjustable Height Mid Support	60	9	Adj.	253	15	FLT0960-29B3-EPMAH	\$4,434		
	60	9	Adj.	253	15	FLV0960-29B3-EPMAH		\$5,099	\$5,355
	48	9	Adj.	239	13	FLT0948-29B3-EPMAH	\$4,347		
	48	9	Adj.	239	13	FLV0948-29B3-EPMAH		\$4,999	\$5,249

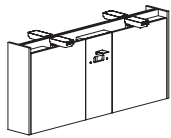

**Features:**

- use with Adjustable Height Bench Surfaces

**Options:**

- must specify chassis grain direction on double cut veneer, see pages 42-43 for details

Outward Facing Adjustable Height End Support Credenza	60	22	Adj.	233	15	FLT2260-21B3-ECOUT	\$2,114		
	60	22	Adj.	233	15	FLV2260-21B3-ECOUT		\$2,705	\$2,922
	48	22	Adj.	206	13	FLT2248-21B3-ECOUT	\$2,032		
	48	22	Adj.	206	13	FLV2248-21B3-ECOUT		\$2,601	\$2,809

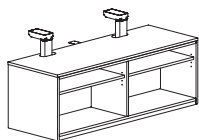
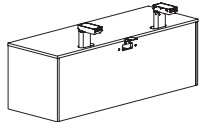

**Features:**

- use with Adjustable Height Bench Surface
- each compartment has one adjustable shelf

**Options:**

- optional center rail for privacy screen; screen ordered separately
- must specify chassis grain direction on double cut veneer, see pages 42-43 for details

Inward Facing Adjustable Height End Support Credenza	60	22	Adj.	226	15	FLT2260-21B3-ECIN	\$2,073		
	60	22	Adj.	226	15	FLV2260-21B3-ECIN		\$2,652	\$2,864
	48	22	Adj.	201	13	FLT2248-21B3-ECIN	\$1,992		
	48	22	Adj.	201	13	FLV2248-21B3-ECIN		\$2,550	\$2,754

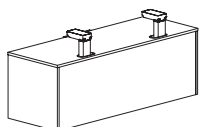
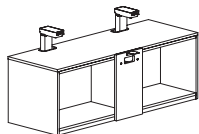

**Features:**

- use with Adjustable Height Bench Surface

**Options:**

- must specify chassis grain direction on double cut veneer, see pages 42-43 for details

Description	D	W	H	CTN WT	CU FT	① Model	List Price
26" Acrylic Privacy Screen - Adjustable Height Bench or Credenza Support	¼	59 ⅝	25 ¾	24	5	FLB60-26B3-APS	\$1,138
	¼	53 ⅝	25 ¾	22	4	FLB54-26B3-APS	\$1,030
	¼	47 ⅝	25 ¾	20	4	FLB48-26B3-APS	\$924
	¼	41 ⅝	25 ¾	18	4	FLB42-26B3-APS	\$814
	¼	35 ⅝	25 ¾	16	3	FLB36-26B3-APS	\$707
	¼	29 ⅝	25 ¾	15	3	FLB30-26B3-APS	\$600
	¼	23 ⅝	25 ¾	12	3	FLB24-26B3-APS	\$540



**Features:**

- use with Adjustable Height Bench or End Support Credenza to achieve 48" overall height
- mounts to center rail; see page 486 for details

Description	D	W	H	CTN WT	CU FT	① Model	List Price
20" Acrylic Privacy Screen - Adjustable Height Bench or Credenza Support	¼	59 ⅝	19 ¾	20	4	FLB60-20B3-APS	\$916
	¼	53 ⅝	19 ¾	19	4	FLB54-20B3-APS	\$830
	¼	47 ⅝	19 ¾	17	3	FLB48-20B3-APS	\$746
	¼	41 ⅝	19 ¾	16	3	FLB42-20B3-APS	\$658
	¼	35 ⅝	19 ¾	14	3	FLB36-20B3-APS	\$573
	¼	29 ⅝	19 ¾	13	2	FLB30-20B3-APS	\$490
	¼	23 ⅝	19 ¾	9	2	FLB24-20B3-APS	\$486



**Features:**

- use with Adjustable Height Bench or End Support Credenza to achieve 42" overall height
- mounts to center rail; see page 486 for details

**To Order, Specify:**

① Laminate Model #	② Laminate Selection	③ Metal Color	④ Other Product Options
Laminate (FLT)	Solid Patterns: ALB Alabaster BBL Bridal Blanco DWH Designer White SHD Shadow SLG Slate Grey  Wood Grain Patterns: AGA Aged Ash ALL Ale Light BLO Blonde Echo BOL Bourbon Light BZW Brazilwood BGL Brighton Light CLL Collectors FLO Florence Walnut GRH Graphite HGL High Line OAT Oatmeal Cookie PIN Pinnacle Walnut STU Studio Teak VIN Vintage WLH Walnut Heights WEA Weathered Ash	Color: ASL Arctic Silver MBK Matte Black PEW Pewter SNK Soft Nickel	See list of options for each specific unit; Specify and add accordingly.

① Veneer Model #	② Wood Species	③ Wood Finish - Finishes with an asterisk (*) have a coordinating laminate available	④ Metal Color	⑤ Other Product Options
Veneer (FLV)	Flat Cut CH1 Cherry MA1 Maple WA1 Walnut	Cherry: BRL Barley BBM Bourbon Medium BRM Brighton Medium CLA Classic CLL Collectors* EAR Earthy HRV Harvest* LGC Legacy PRL Praline* SAF Saffron ALM Ale Medium BUT Butterscotch CIN Cinnamon FLX Flax VEN Venetian AUB Auburn ESP Espresso MCH Mocha* NTO Night Owl* SIE Sienna* TOF Toffee TRF Truffle*	Color: ASL Arctic Silver MBK Matte Black PEW Pewter SNK Soft Nickel	See list of options for each specific unit; Specify and add accordingly.
	Double Cut DC1 Double Cut	③a Wood Finish Double Cut: COF Coffee CRM Cremello FOS Fossil GRH Graphite KHK Khaki STU Studio Teak	③b Chassis Grain Direction For Double Cut Only: Vertical Horizontal	

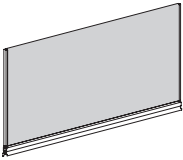
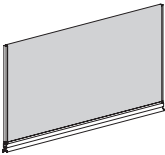
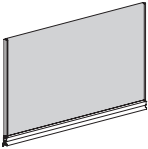
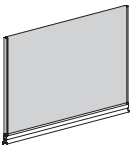

Description	D	W	H	CTN WT	CU FT	① Model	List Price Per Grade	
<b>26"h x 60"w Upholstered Tackboard Privacy Screen</b> 	15 <sup>1</sup> / <sub>16</sub>	59 <sup>3</sup> / <sub>16</sub>	25 <sup>3</sup> / <sub>4</sub>	55	3	FLB60-26B3-RMTK	<b>COM</b> \$1,048	
	<b>Features:</b>							A \$1,077
	· use with Adjustable Height Bench or Credenza Support to achieve 48" overall height							B \$1,132
	· mounts to center rail							C \$1,229
	· com ydg: 2							D \$1,354
								E \$1,479
								F \$1,672
								G \$1,880
								H \$2,102
								I \$2,448
							J \$2,864	
<b>26"h x 54"w Upholstered Tackboard Privacy Screen</b> 	15 <sup>1</sup> / <sub>16</sub>	53 <sup>5</sup> / <sub>16</sub>	25 <sup>3</sup> / <sub>4</sub>	50	3	FLB54-26B3-RMTK	<b>COM</b> \$1,019	
	<b>Features:</b>							A \$1,044
	· use with Adjustable Height Bench or Credenza Support to achieve 48" overall height							B \$1,094
	· mounts to center rail							C \$1,181
	· com ydg: 2							D \$1,294
								E \$1,406
								F \$1,579
								G \$1,768
								H \$1,967
								I \$2,278
							J \$2,653	
<b>26"h x 48"w Upholstered Tackboard Privacy Screen</b> 	15 <sup>1</sup> / <sub>16</sub>	47 <sup>5</sup> / <sub>16</sub>	25 <sup>3</sup> / <sub>4</sub>	45	3	FLB48-26B3-RMTK	<b>COM</b> \$981	
	<b>Features:</b>							A \$1,005
	· use with Adjustable Height Bench or Credenza Support to achieve 48" overall height							B \$1,048
	· mounts to center rail							C \$1,125
	· com ydg: 1 <sup>3</sup> / <sub>4</sub>							D \$1,226
								E \$1,325
								F \$1,480
								G \$1,647
								H \$1,823
								I \$2,101
							J \$2,434	
<b>26"h x 42"w Upholstered Tackboard Privacy Screen</b> 	15 <sup>1</sup> / <sub>16</sub>	41 <sup>5</sup> / <sub>16</sub>	25 <sup>3</sup> / <sub>4</sub>	40	3	FLB42-26B3-RMTK	<b>COM</b> \$950	
	<b>Features:</b>							A \$970
	· use with Adjustable Height Bench or Credenza Support to achieve 48" overall height							B \$1,010
	· mounts to center rail							C \$1,077
	· com ydg: 1 <sup>1</sup> / <sub>2</sub>							D \$1,165
								E \$1,252
								F \$1,387
								G \$1,533
								H \$1,687
								I \$1,930
							J \$2,222	

FLUX - OPEN PLAN

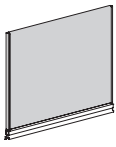
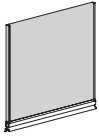
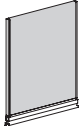
Description	D	W	H	CTN WT	CU FT	① Model	List Price Per Grade	
26" h x 36" w Upholstered Tackboard Privacy Screen 	15 1/16	35 5/8	25 3/4	35	2	FLB36-26B3-RMTK	COM \$919	
	<b>Features:</b>							A \$935
	· use with Adjustable Height Bench or Credenza Support to achieve 48" overall height							B \$969
	· mounts to center rail							C \$1,027
	· com ydg: 1 1/2							D \$1,102
								E \$1,177
								F \$1,293
								G \$1,417
								H \$1,550
								I \$1,758
							J \$2,009	
26" h x 30" w Upholstered Tackboard Privacy Screen 	15 1/16	29 5/8	25 3/4	30	2	FLB30-26B3-RMTK	COM \$901	
	<b>Features:</b>							A \$918
	· use with Adjustable Height Bench or Credenza Support to achieve 48" overall height							B \$952
	· mounts to center rail							C \$1,010
	· com ydg: 1 1/4							D \$1,084
								E \$1,159
								F \$1,275
								G \$1,400
								H \$1,533
								I \$1,740
							J \$1,990	
26" h x 24" w Upholstered Tackboard Privacy Screen 	15 1/16	23 5/8	25 3/4	24	2	FLB24-26B3-RMTK	COM \$860	
	<b>Features:</b>							A \$871
	· use with Adjustable Height Bench or Credenza Support to achieve 48" overall height							B \$893
	· mounts to center rail							C \$932
	· com ydg: 1 1/4							D \$982
								E \$1,031
								F \$1,110
								G \$1,193
								H \$1,282
								I \$1,419
							J \$1,587	

**To Order, Specify:**

① Model Number	② Fabric Selection	
(FLB)	Vendor Pattern Color	See a selection of graded in fabric manufacturers and patterns on pages 19-27. Contact Customer Service for additional fabric options.

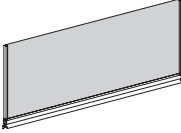
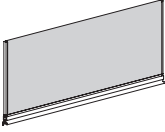
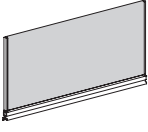
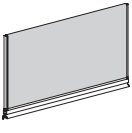
Description	D	W	H	CTN WT	CU FT	① Model	List Price Per Grade	
20"h x 60"w Upholstered Tackboard Privacy Screen 	15 <sup>1</sup> / <sub>16</sub>	59 <sup>3</sup> / <sub>16</sub>	19 <sup>3</sup> / <sub>4</sub>	44	3	FLB60-20B3-RMTK	COM \$1,008	
	<b>Features:</b>							A \$1,036
	· use with Adjustable Height Bench or Credenza Support to achieve 42" overall height							B \$1,090
	· mounts to center rail							C \$1,188
	· com ydg: 2							D \$1,313
								E \$1,438
								F \$1,631
								G \$1,839
								H \$2,061
								I \$2,407
							J \$2,822	
20"h x 54"w Upholstered Tackboard Privacy Screen 	15 <sup>1</sup> / <sub>16</sub>	53 <sup>5</sup> / <sub>16</sub>	19 <sup>3</sup> / <sub>4</sub>	40	3	FLB54-20B3-RMTK	COM \$981	
	<b>Features:</b>							A \$1,007
	· use with Adjustable Height Bench or Credenza Support to achieve 42" overall height							B \$1,057
	· mounts to center rail							C \$1,143
	· com ydg: 2							D \$1,256
								E \$1,367
								F \$1,542
								G \$1,729
								H \$1,929
								I \$2,240
							J \$2,614	
20"h x 48"w Upholstered Tackboard Privacy Screen 	15 <sup>1</sup> / <sub>16</sub>	47 <sup>5</sup> / <sub>16</sub>	19 <sup>3</sup> / <sub>4</sub>	36	2	FLB48-20B3-RMTK	COM \$948	
	<b>Features:</b>							A \$971
	· use with Adjustable Height Bench or Credenza Support to achieve 42" overall height							B \$1,016
	· mounts to center rail							C \$1,092
	· com ydg: 1 <sup>3</sup> / <sub>4</sub>							D \$1,193
								E \$1,292
								F \$1,447
								G \$1,614
								H \$1,790
								I \$2,068
							J \$2,400	
20"h x 42"w Upholstered Tackboard Privacy Screen 	15 <sup>1</sup> / <sub>16</sub>	41 <sup>5</sup> / <sub>16</sub>	19 <sup>3</sup> / <sub>4</sub>	33	2	FLB42-20B3-RMTK	COM \$921	
	<b>Features:</b>							A \$940
	· use with Adjustable Height Bench or Credenza Support to achieve 42" overall height							B \$980
	· mounts to center rail							C \$1,047
	· com ydg: 1 <sup>1</sup> / <sub>2</sub>							D \$1,135
								E \$1,223
								F \$1,357
								G \$1,503
								H \$1,658
								I \$1,901
							J \$2,192	

FLUX - OPEN PLAN

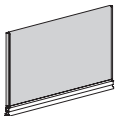
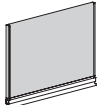
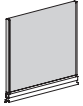
Description	D	W	H	CTN WT	CU FT	① Model	List Price Per Grade
20" h x 36" w Upholstered Tackboard Privacy Screen 	15 1/16	35 5/8	19 3/4	29	2	FLB36-20B3-RMTK	COM \$893
	<b>Features:</b>						A \$910
	· use with Adjustable Height Bench or Credenza Support to achieve 42" overall height						B \$944
	· mounts to center rail						C \$1,001
	· com ydg: 1 1/2						D \$1,077
							E \$1,151
							F \$1,268
							G \$1,392
							H \$1,525
							I \$1,732
						J \$1,983	
20" h x 30" w Upholstered Tackboard Privacy Screen 	15 1/16	29 5/8	19 3/4	25	2	FLB30-20B3-RMTK	COM \$879
	<b>Features:</b>						A \$896
	· use with Adjustable Height Bench or Credenza Support to achieve 42" overall height						B \$930
	· mounts to center rail						C \$988
	· com ydg: 1 1/4						D \$1,063
							E \$1,138
							F \$1,254
							G \$1,379
							H \$1,511
							I \$1,719
						J \$1,969	
20" h x 24" w Upholstered Tackboard Privacy Screen 	15 1/16	23 5/8	19 3/4	20	2	FLB24-20B3-RMTK	COM \$842
	<b>Features:</b>						A \$855
	· use with Adjustable Height Bench or Credenza Support to achieve 42" overall height						B \$876
	· mounts to center rail						C \$916
	· com ydg: 1 1/4						D \$965
							E \$1,015
							F \$1,092
							G \$1,176
							H \$1,264
							I \$1,403
						J \$1,569	

To Order, Specify:

① Model Number	② Fabric Selection	
(FLB)	Vendor Pattern Color	See a selection of graded in fabric manufacturers and patterns on pages 19-27. Contact Customer Service for additional fabric options.

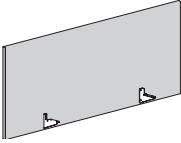
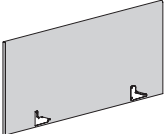
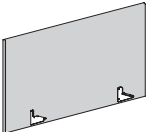
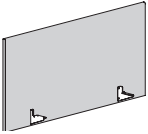
Description	D	W	H	CTN WT	CU FT	① Model	List Price Per Grade	
<b>23" h x 60" w Upholstered Tackboard Edge Mount Privacy Screen</b>  	15 1/16	59 3/8	23	54	3	<b>FLB60-23B3-EMTK</b>	<b>COM \$995</b>	
	<b>Features:</b>							<b>A \$1,024</b>
	· use with Adjustable Height Bench to achieve 48" overall height							<b>B \$1,079</b>
	· mounts to underside of worksurface							<b>C \$1,176</b>
	· extends 19" above worksurface							<b>D \$1,301</b>
	· com ydg: 2							<b>E \$1,426</b>
								<b>F \$1,620</b>
								<b>G \$1,828</b>
								<b>H \$2,049</b>
								<b>I \$2,395</b>
								<b>J \$2,811</b>
	<b>23" h x 54" w Upholstered Tackboard Edge Mount Privacy Screen</b>  	15 1/16	53 3/8	23	49	3	<b>FLB54-23B3-EMTK</b>	<b>COM \$969</b>
		<b>Features:</b>						
· use with Adjustable Height Bench to achieve 48" overall height							<b>B \$1,045</b>	
· mounts to underside of worksurface							<b>C \$1,132</b>	
· extends 19" above worksurface							<b>D \$1,244</b>	
· com ydg: 2							<b>E \$1,356</b>	
							<b>F \$1,530</b>	
							<b>G \$1,718</b>	
							<b>H \$1,918</b>	
							<b>I \$2,229</b>	
							<b>J \$2,603</b>	
<b>23" h x 48" w Upholstered Tackboard Edge Mount Privacy Screen</b>  		15 1/16	47 3/8	23	44	3	<b>FLB48-23B3-EMTK</b>	<b>COM \$942</b>
		<b>Features:</b>						
	· use with Adjustable Height Bench to achieve 48" overall height							<b>B \$1,011</b>
	· mounts to underside of worksurface							<b>C \$1,087</b>
	· extends 19" above worksurface							<b>D \$1,188</b>
	· com ydg: 1 3/4							<b>E \$1,287</b>
								<b>F \$1,442</b>
								<b>G \$1,608</b>
								<b>H \$1,785</b>
								<b>I \$2,063</b>
								<b>J \$2,395</b>
	<b>23" h x 42" w Upholstered Tackboard Edge Mount Privacy Screen</b>  	15 1/16	41 3/8	23	39	2	<b>FLB42-23B3-EMTK</b>	<b>COM \$917</b>
		<b>Features:</b>						
· use with Adjustable Height Bench to achieve 48" overall height							<b>B \$976</b>	
· mounts to underside of worksurface							<b>C \$1,043</b>	
· extends 19" above worksurface							<b>D \$1,131</b>	
· com ydg: 1 1/2							<b>E \$1,219</b>	
							<b>F \$1,353</b>	
							<b>G \$1,499</b>	
							<b>H \$1,654</b>	
							<b>I \$1,896</b>	
							<b>J \$2,187</b>	

FLUX - OPEN PLAN

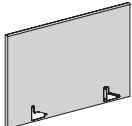
Description	D	W	H	CTN WT	CU FT	① Model	List Price Per Grade
<b>23" h x 36" w Upholstered Tackboard Edge Mount Privacy Screen</b>  	15 <sup>1</sup> / <sub>16</sub>	35 <sup>5</sup> / <sub>8</sub>	23	34	2	FLB36-23B3-EMTK	<b>COM</b> \$892
	<b>Features:</b>						A \$909
	· use with Adjustable Height Bench to achieve 48" overall height						B \$942
	· mounts to underside of worksurface						C \$1,000
	· extends 19" above worksurface						D \$1,076
	· com ydg: 1 1/2						E \$1,150
							F \$1,266
							G \$1,391
							H \$1,524
							I \$1,731
							J \$1,982

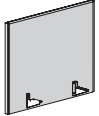
<b>23" h x 30" w Upholstered Tackboard Edge Mount Privacy Screen</b>  	15 <sup>1</sup> / <sub>16</sub>	29 <sup>5</sup> / <sub>8</sub>	23	27	2	FLB30-23B3-EMTK	<b>COM</b> \$880
	<b>Features:</b>						A \$897
	· use with Adjustable Height Bench to achieve 48" overall height						B \$931
	· mounts to underside of worksurface						C \$989
	· extends 19" above worksurface						D \$1,064
	· com ydg: 1 1/2						E \$1,139
							F \$1,255
							G \$1,380
							H \$1,512
							I \$1,720
							J \$1,970

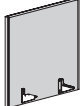
<b>23" h x 24" w Upholstered Tackboard Edge Mount Privacy Screen</b>  	15 <sup>1</sup> / <sub>16</sub>	23 <sup>5</sup> / <sub>8</sub>	23	24	2	FLB24-23B3-EMTK	<b>COM</b> \$856
	<b>Features:</b>						A \$867
	· use with Adjustable Height Bench to achieve 48" overall height						B \$889
	· mounts to underside of worksurface						C \$928
	· extends 19" above worksurface						D \$978
	· com ydg: 1 1/2						E \$1,027
							F \$1,105
							G \$1,189
							H \$1,277
							I \$1,415
							J \$1,581

**To Order, Specify:**

① Model Number	② Fabric Selection	
(FLB)	Vendor Pattern Color	See a selection of graded in fabric manufacturers and patterns on pages 19-27. Contact Customer Service for additional fabric options.

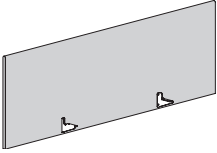
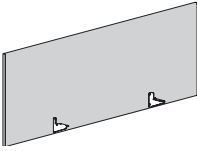
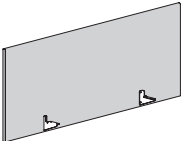
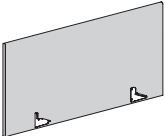
Description	D	W	H	CTN WT	CU FT	① Model	List Price Per Grade	
<b>23" h x 72" w Upholstered Tackboard Edge Mount Privacy Screen</b>  	15 1/16	71 3/8	23	59	3	FLB72-23B1-EMTK	<b>COM</b> \$1,049	
	<b>Features:</b>							<b>A</b> \$1,083
	· use with Adjustable Height Bench to achieve 48" overall height							<b>B</b> \$1,149
	· mounts to underside of worksurface							<b>C</b> \$1,266
	· extends 19" above worksurface							<b>D</b> \$1,415
	· com ydg: 2							<b>E</b> \$1,565
								<b>F</b> \$1,799
								<b>G</b> \$2,047
								<b>H</b> \$2,313
								<b>I</b> \$2,728
							<b>J</b> \$3,228	
<b>23" h x 66" w Upholstered Tackboard Edge Mount Privacy Screen</b>  	15 1/16	65 3/8	23	65	3	FLB66-23B1-EMTK	<b>COM</b> \$1,022	
	<b>Features:</b>							<b>A</b> \$1,053
	· use with Adjustable Height Bench to achieve 48" overall height							<b>B</b> \$1,114
	· mounts to underside of worksurface							<b>C</b> \$1,221
	· extends 19" above worksurface							<b>D</b> \$1,357
	· com ydg: 2							<b>E</b> \$1,495
								<b>F</b> \$1,709
								<b>G</b> \$1,936
								<b>H</b> \$2,180
								<b>I</b> \$2,562
							<b>J</b> \$3,019	
<b>23" h x 60" w Upholstered Tackboard Edge Mount Privacy Screen</b>  	15 1/16	59 3/8	23	38		FLB60-23B1-EMTK	<b>COM</b> \$995	
	<b>Features:</b>							<b>A</b> \$1,024
	· use with Adjustable Height Bench to achieve 48" overall height							<b>B</b> \$1,079
	· mounts to underside of worksurface							<b>C</b> \$1,176
	· extends 19" above worksurface							<b>D</b> \$1,301
	· com ydg: 2							<b>E</b> \$1,426
								<b>F</b> \$1,620
								<b>G</b> \$1,828
								<b>H</b> \$2,049
								<b>I</b> \$2,395
							<b>J</b> \$2,811	
<b>23" h x 54" w Upholstered Tackboard Edge Mount Privacy Screen</b>  	15 1/16	53 3/8	23	35		FLB54-23B1-EMTK	<b>COM</b> \$969	
	<b>Features:</b>							<b>A</b> \$994
	· use with Adjustable Height Bench to achieve 48" overall height							<b>B</b> \$1,045
	· mounts to underside of worksurface							<b>C</b> \$1,132
	· extends 19" above worksurface							<b>D</b> \$1,244
	· com ydg: 2							<b>E</b> \$1,356
								<b>F</b> \$1,530
								<b>G</b> \$1,718
								<b>H</b> \$1,918
								<b>I</b> \$2,229
							<b>J</b> \$2,603	

FLUX - OPEN PLAN

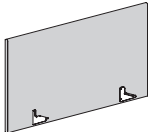
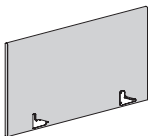
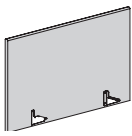
Description	D	W	H	CTN WT	CU FT	① Model	List Price Per Grade	
<b>23" h x 48" w Upholstered Tackboard Edge Mount Privacy Screen</b> 	15 <sup>1</sup> / <sub>16</sub>	47 <sup>5</sup> / <sub>8</sub>	23	31		<b>FLB48-23B1-EMTK</b>	<b>COM \$942</b>	
	<b>Features:</b>							A \$966
	· use with Adjustable Height Bench to achieve 48" overall height							B \$1,011
	· mounts to underside of worksurface							C \$1,087
	· extends 19" above worksurface							D \$1,188
	· com ydg: 1 3/4							E \$1,287
								F \$1,442
								G \$1,608
								H \$1,785
								I \$2,063
								J \$2,395
<b>23" h x 42" w Upholstered Tackboard Edge Mount Privacy Screen</b> 	15 <sup>1</sup> / <sub>16</sub>	41 <sup>5</sup> / <sub>8</sub>	23	28		<b>FLB42-23B1-EMTK</b>	<b>COM \$917</b>	
	<b>Features:</b>							A \$936
	· use with Adjustable Height Bench to achieve 48" overall height							B \$976
	· mounts to underside of worksurface							C \$1,043
	· extends 19" above worksurface							D \$1,131
	· com ydg: 1 1/2							E \$1,219
								F \$1,353
								G \$1,499
								H \$1,654
								I \$1,896
								J \$2,187
<b>23" h x 36" w Upholstered Tackboard Edge Mount Privacy Screen</b> 	15 <sup>1</sup> / <sub>16</sub>	35 <sup>5</sup> / <sub>8</sub>	23	23		<b>FLB36-23B1-EMTK</b>	<b>COM \$892</b>	
	<b>Features:</b>							A \$909
	· use with Adjustable Height Bench to achieve 48" overall height							B \$942
	· mounts to underside of worksurface							C \$1,000
	· extends 19" above worksurface							D \$1,076
	· com ydg: 1 1/2							E \$1,150
								F \$1,266
								G \$1,391
								H \$1,524
								I \$1,731
								J \$1,982



**To Order, Specify:**

① Model Number	② Fabric Selection	
(FLB)	Vendor Pattern Color	See a selection of graded in fabric manufacturers and patterns on pages 19-27. Contact Customer Service for additional fabric options.

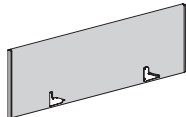
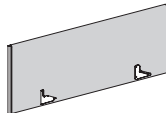
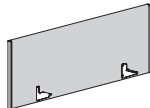
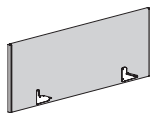

Description	D	W	H	CTN WT	CU FT	① Model	List Price Per Grade	
<b>17" h x 60" w Upholstered Tackboard Edge Mount Privacy Screen</b> 	15 <sup>1</sup> / <sub>16</sub>	59 <sup>3</sup> / <sub>16</sub>	17	42	3	FLB60-17B3-EMTK	<b>COM</b> \$973	
	<b>Features:</b>							<b>A</b> \$1,001
	· use with Adjustable Height Bench to achieve 42" overall height							<b>B</b> \$1,057
	· mounts to underside of worksurface							<b>C</b> \$1,153
	· extends 13" above worksurface							<b>D</b> \$1,280
	· com ydg: 2							<b>E</b> \$1,404
								<b>F</b> \$1,598
								<b>G</b> \$1,806
								<b>H</b> \$2,027
								<b>I</b> \$2,372
								<b>J</b> \$2,788
	<b>17" h x 54" w Upholstered Tackboard Edge Mount Privacy Screen</b> 	15 <sup>1</sup> / <sub>16</sub>	53 <sup>3</sup> / <sub>16</sub>	17	38	2	FLB54-17B3-EMTK	<b>COM</b> \$947
		<b>Features:</b>						
· use with Adjustable Height Bench to achieve 42" overall height							<b>B</b> \$1,023	
· mounts to underside of worksurface							<b>C</b> \$1,110	
· extends 13" above worksurface							<b>D</b> \$1,223	
· com ydg: 2							<b>E</b> \$1,334	
							<b>F</b> \$1,508	
							<b>G</b> \$1,696	
							<b>H</b> \$1,895	
							<b>I</b> \$2,206	
							<b>J</b> \$2,580	
<b>17" h x 48" w Upholstered Tackboard Edge Mount Privacy Screen</b> 		15 <sup>1</sup> / <sub>16</sub>	47 <sup>3</sup> / <sub>16</sub>	17	35	2	FLB48-17B3-EMTK	<b>COM</b> \$921
		<b>Features:</b>						
	· use with Adjustable Height Bench to achieve 42" overall height							<b>B</b> \$988
	· mounts to underside of worksurface							<b>C</b> \$1,066
	· extends 13" above worksurface							<b>D</b> \$1,166
	· com ydg: 1 3/4							<b>E</b> \$1,264
								<b>F</b> \$1,419
								<b>G</b> \$1,587
								<b>H</b> \$1,763
								<b>I</b> \$2,041
								<b>J</b> \$2,372
	<b>17" h x 42" w Upholstered Tackboard Edge Mount Privacy Screen</b> 	15 <sup>1</sup> / <sub>16</sub>	41 <sup>3</sup> / <sub>16</sub>	17	31	2	FLB42-17B3-EMTK	<b>COM</b> \$894
		<b>Features:</b>						
· use with Adjustable Height Bench to achieve 42" overall height							<b>B</b> \$954	
· mounts to underside of worksurface							<b>C</b> \$1,021	
· extends 13" above worksurface							<b>D</b> \$1,108	
· com ydg: 1 1/2							<b>E</b> \$1,196	
							<b>F</b> \$1,331	
							<b>G</b> \$1,476	
							<b>H</b> \$1,631	
							<b>I</b> \$1,874	
							<b>J</b> \$2,166	

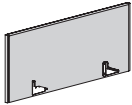
FLUX - OPEN PLAN

Description	D	W	H	CTN WT	CU FT	① Model	List Price Per Grade
<b>17" h x 36" w Upholstered Tackboard Edge Mount Privacy Screen</b>  	15 <sup>1</sup> / <sub>16</sub>	35 <sup>5</sup> / <sub>16</sub>	17	28	2	FLB36-17B3-EMTK	COM \$870
	<b>Features:</b>						A \$887
	· use with Adjustable Height Bench to achieve 42" overall height						B \$921
	· mounts to underside of worksurface						C \$979
	· extends 13" above worksurface						D \$1,053
	· com ydg: 1 ½						E \$1,129
							F \$1,244
							G \$1,368
							H \$1,502
							I \$1,710
							J \$1,960
<b>17" h x 30" w Upholstered Tackboard Edge Mount Privacy Screen</b>  	15 <sup>1</sup> / <sub>16</sub>	29 <sup>5</sup> / <sub>16</sub>	17	21	2	FLB30-17B3-EMTK	COM \$859
	<b>Features:</b>						A \$875
	· use with Adjustable Height Bench to achieve 42" overall height						B \$909
	· mounts to underside of worksurface						C \$967
	· extends 13" above worksurface						D \$1,042
	· com ydg: 1 ½						E \$1,117
							F \$1,233
							G \$1,357
							H \$1,490
							I \$1,698
							J \$1,948
<b>17" h x 24" w Upholstered Tackboard Edge Mount Privacy Screen</b>  	15 <sup>1</sup> / <sub>16</sub>	23 <sup>5</sup> / <sub>16</sub>	17	17	2	FLB24-17B3-EMTK	COM \$833
	<b>Features:</b>						A \$844
	· use with Adjustable Height Bench to achieve 42" overall height						B \$867
	· mounts to underside of worksurface						C \$906
	· extends 13" above worksurface						D \$956
	· com ydg: 1 ½						E \$1,006
							F \$1,083
							G \$1,167
							H \$1,255
							I \$1,393
							J \$1,560

**To Order, Specify:**

① Model Number	② Fabric Selection	
(FLB)	Vendor Pattern Color	See a selection of graded in fabric manufacturers and patterns on pages 19-27. Contact Customer Service for additional fabric options.

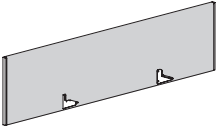
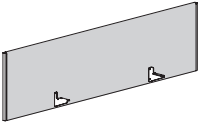
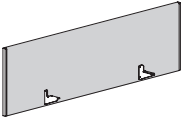
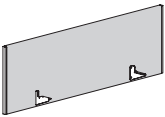
Description	D	W	H	CTN WT	CU FT	① Model	List Price Per Grade	
<b>17" h x 72" w Upholstered Tackboard Edge Mount Privacy Screen</b>  	15 1/16	71 3/8	17	50	3	FLB72-17B1-EMTK	<b>COM</b> \$1,027	
	<b>Features:</b>							<b>A</b> \$1,061
	· use with Adjustable Height Bench to achieve 42" overall height							<b>B</b> \$1,128
	· mounts to underside of worksurface							<b>C</b> \$1,244
	· extends 13" above worksurface							<b>D</b> \$1,393
	· com ydg: 2							<b>E</b> \$1,543
								<b>F</b> \$1,776
								<b>G</b> \$2,025
								<b>H</b> \$2,291
								<b>I</b> \$2,706
								<b>J</b> \$3,205
<b>17" h x 66" w Upholstered Tackboard Edge Mount Privacy Screen</b>  	15 1/16	65 3/8	17	46	3	FLB66-17B1-EMTK	<b>COM</b> \$999	
	<b>Features:</b>							<b>A</b> \$1,031
	· use with Adjustable Height Bench to achieve 42" overall height							<b>B</b> \$1,091
	· mounts to underside of worksurface							<b>C</b> \$1,198
	· extends 13" above worksurface							<b>D</b> \$1,335
	· com ydg: 2							<b>E</b> \$1,472
								<b>F</b> \$1,686
								<b>G</b> \$1,914
								<b>H</b> \$2,157
								<b>I</b> \$2,540
								<b>J</b> \$2,996
<b>17" h x 60" w Upholstered Tackboard Edge Mount Privacy Screen</b>  	15 1/16	59 3/8	17	45		FLB60-17B1-EMTK	<b>COM</b> \$973	
	<b>Features:</b>							<b>A</b> \$1,001
	· use with Adjustable Height Bench to achieve 42" overall height							<b>B</b> \$1,057
	· mounts to underside of worksurface							<b>C</b> \$1,153
	· extends 13" above worksurface							<b>D</b> \$1,280
	· com ydg: 2							<b>E</b> \$1,404
								<b>F</b> \$1,598
								<b>G</b> \$1,806
								<b>H</b> \$2,027
								<b>I</b> \$2,372
								<b>J</b> \$2,788
<b>17" h x 54" w Upholstered Tackboard Edge Mount Privacy Screen</b>  	15 1/16	53 3/8	17	40		FLB54-17B1-EMTK	<b>COM</b> \$947	
	<b>Features:</b>							<b>A</b> \$972
	· use with Adjustable Height Bench to achieve 42" overall height							<b>B</b> \$1,023
	· mounts to underside of worksurface							<b>C</b> \$1,110
	· extends 13" above worksurface							<b>D</b> \$1,223
	· com ydg: 2							<b>E</b> \$1,334
								<b>F</b> \$1,508
								<b>G</b> \$1,696
								<b>H</b> \$1,895
								<b>I</b> \$2,206
								<b>J</b> \$2,580

FLUX - OPEN PLAN

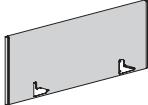
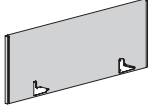
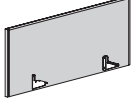
Description	D	W	H	CTN WT	CU FT	① Model	List Price Per Grade	
<b>17" h x 48" w Upholstered Tackboard Edge Mount Privacy Screen</b>  	15/16	47 5/8	17	35		<b>FLB48-17B1-EMTK</b>	<b>COM \$921</b>	
	<b>Features:</b>							<b>A \$944</b>
	<ul style="list-style-type: none"> <li>· use with Adjustable Height Bench to achieve 42" overall height</li> <li>· mounts to underside of worksurface</li> <li>· extends 13" above worksurface</li> <li>· com ydg: 1 3/4</li> </ul>							<b>B \$988</b>
								<b>C \$1,066</b>
								<b>D \$1,166</b>
								<b>E \$1,264</b>
								<b>F \$1,419</b>
								<b>G \$1,587</b>
								<b>H \$1,763</b>
								<b>I \$2,041</b>
								<b>J \$2,372</b>
<b>17" h x 42" w Upholstered Tackboard Edge Mount Privacy Screen</b>  	15/16	41 5/8	17	30		<b>FLB42-17B1-EMTK</b>	<b>COM \$894</b>	
	<b>Features:</b>							<b>A \$915</b>
	<ul style="list-style-type: none"> <li>· use with Adjustable Height Bench to achieve 42" overall height</li> <li>· mounts to underside of worksurface</li> <li>· extends 13" above worksurface</li> <li>· com ydg: 1 1/2</li> </ul>							<b>B \$954</b>
								<b>C \$1,021</b>
								<b>D \$1,108</b>
								<b>E \$1,196</b>
								<b>F \$1,331</b>
								<b>G \$1,476</b>
								<b>H \$1,631</b>
								<b>I \$1,874</b>
								<b>J \$2,166</b>
<b>17" h x 36" w Upholstered Tackboard Edge Mount Privacy Screen</b>  	15/16	35 5/8	17	25		<b>FLB36-17B1-EMTK</b>	<b>COM \$870</b>	
	<b>Features:</b>							<b>A \$887</b>
	<ul style="list-style-type: none"> <li>· use with Adjustable Height Bench to achieve 42" overall height</li> <li>· mounts to underside of worksurface</li> <li>· extends 13" above worksurface</li> <li>· com ydg: 1 1/2</li> </ul>							<b>B \$921</b>
								<b>C \$979</b>
								<b>D \$1,053</b>
								<b>E \$1,129</b>
								<b>F \$1,244</b>
								<b>G \$1,368</b>
								<b>H \$1,502</b>
								<b>I \$1,710</b>
								<b>J \$1,960</b>

**To Order, Specify:**

① Model Number	② Fabric Selection	
(FLB)	Vendor Pattern Color	See a selection of graded in fabric manufacturers and patterns on pages 19-27. Contact Customer Service for additional fabric options.

Description	D	W	H	CTN WT	CU FT	① Model	Laminate	Flat Cut Veneer	Double Cut Veneer
Adjustable Height H-Frame Bench Unit - Dual Sided	60	72	Adj.	467	88	FLT6072-29B4-AHHT	\$5,179		
	60	72	Adj.	467	88	FLV6072-29B4-AHHT		\$5,675	\$5,937
	60	66	Adj.	478	81	FLT6066-29B4-AHHT	\$5,075		
	60	66	Adj.	478	81	FLV6066-29B4-AHHT		\$5,561	\$5,815
	60	60	Adj.	453	74	FLT6060-29B4-AHHT	\$4,974		
	60	60	Adj.	453	74	FLV6060-29B4-AHHT		\$5,451	\$5,698
	60	54	Adj.	428	67	FLT6054-29B4-AHHT	\$4,874		
	60	54	Adj.	428	67	FLV6054-29B4-AHHT		\$5,342	\$5,582
	60	48	Adj.	392	60	FLT6048-29B4-AHHT	\$4,777		
	60	48	Adj.	392	60	FLV6048-29B4-AHHT		\$5,235	\$5,470
	60	42	Adj.	85	19	FLT6042-29B4-AHHT	\$4,729		
	60	42	Adj.	85	19	FLV6042-29B4-AHHT		\$5,182	\$5,416
	60	36	Adj.	78	17	FLT6036-29B4-AHHT	\$4,681		
	60	36	Adj.	78	17	FLV6036-29B4-AHHT		\$5,130	\$5,362
	48	72	Adj.	450	71	FLT4872-29B4-AHHT	\$4,868		
	48	72	Adj.	450	71	FLV4872-29B4-AHHT		\$5,335	\$5,577
	48	66	Adj.	427	66	FLT4866-29B4-AHHT	\$4,770		
	48	66	Adj.	427	66	FLV4866-29B4-AHHT		\$5,228	\$5,462
	48	60	Adj.	405	60	FLT4860-29B4-AHHT	\$4,675		
	48	60	Adj.	405	60	FLV4860-29B4-AHHT		\$5,124	\$5,351
	48	54	Adj.	382	55	FLT4854-29B4-AHHT	\$4,581		
	48	54	Adj.	382	55	FLV4854-29B4-AHHT		\$5,022	\$5,241
	48	48	Adj.	373	49	FLT4848-29B4-AHHT	\$4,490		
	48	48	Adj.	373	49	FLV4848-29B4-AHHT		\$4,921	\$5,157
	48	42	Adj.	70	15	FLT4842-29B4-AHHT	\$4,490		
	48	42	Adj.	70	15	FLV4842-29B4-AHHT		\$4,921	\$5,157
	48	36	Adj.	62	14	FLT4836-29B4-AHHT	\$4,445		
48	36	Adj.	62	14	FLV4836-29B4-AHHT		\$4,872	\$5,105	

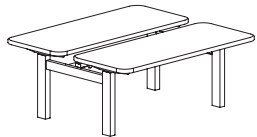

**Features:**

- eased edge profile
- rounded corners
- 27 ¼" to 46 ¼" height adjustment
- center rail
- wire trough with removable lid

**Options:**

- power harness kit available, specify and add \$328 list; receptacles and infeeds ordered separately, see page 559
- wireless charging unit available, specify location(s), see page 485; EC33 unit must be ordered separately, see page 560
- privacy screens available for center rail; order screen separately, 18" less than width of bench surface; see page 486 for details
- edge mount privacy screens available, order screen separately, 12" less than width of bench surface; see page 486 for details

Description	D	W	H	CTN WT	CU FT	① Model	Laminate	Flat Cut Veneer	Double Cut Veneer
Adjustable Height H-Frame Bench Unit - 120°	100½	115½	Adj.	835	135	FLT60101-29B4-AHHT	\$12,206		
	100½	115½	Adj.	835	135	FLV60101-29B4-AHHT		\$13,195	\$13,604
	95	109½	Adj.	799	125	FLT48101-29B4-AHHT	\$11,842		
	95	109½	Adj.	799	125	FLV48101-29B4-AHHT		\$12,803	\$13,198

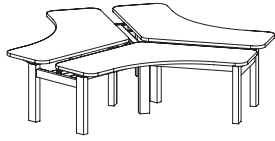

**Features:**

- eased edge profile
- rounded corners
- 27 ¼" to 46 ¼" height adjustment
- center rail
- wire trough with removable lid

**Options:**

- power harness kit available, specify and add \$328 list; receptacles and infeeds ordered separately, see page 559
- wireless charging unit available, specify location(s), see page 485; EC33 unit must be ordered separately, see page 560
- privacy screens available for center rail; order screen separately, up to 48" wide; see page 486 for details
- edge mount privacy screens available, order screen separately, 12" less than width of bench surface; see page 486 for details

Description	D	W	H	CTN WT	CU FT	① Model	List Price
H-Frame Ganging Connector	12 7/16	15 3/4	3	10	1	FLB6015-B4-CON	\$353
	12 7/16	15 3/4	3	10	1	FLB4815-B4-CON	\$337

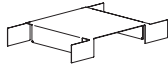

**Features:**

- use to connect Adjustable Height H-Frame Bench Units

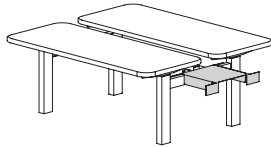

in application



**To Order, Specify:**

① Laminate Model #	② Laminate Type	③ Laminate Selection			④ Metal Color	⑤ Other Product Options	
Laminate (FLT)	HPL	<b>Solid Patterns:</b> ALB Alabaster BBL Bridal Blanco DWH Designer White SHD Shadow SLG Slate Grey	<b>Wood Grain Patterns:</b> AGA Aged Ash ALL Ale Light BLO Blonde Echo BOL Bourbon Light BZW Brazilwood BGL Brighton Light	CLL Collectors FLO Florence Walnut GRH Graphite HGL High Line OAT Oatmeal Cookie PIN Pinnacle Walnut	STU Studio Teak VIN Vintage WLH Walnut Heights WEA Weathered Ash	Color: ASL Arctic Silver MBK Matte Black PEW Pewter SNK Soft Nickel	See list of options for each specific unit; Specify and add accordingly.

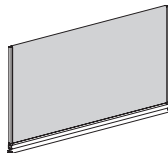
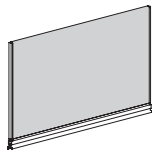
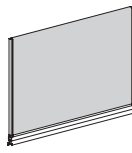
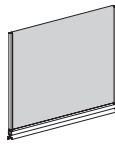
① Veneer Model #	② Wood Species	③ Wood Finish - Finishes with an asterisk (*) have a coordinating laminate available			④ Metal Color	⑤ Other Product Options		
Veneer (FLV)	<b>Flat Cut</b> CH1 Cherry MA1 Maple WA1 Walnut	<b>Cherry:</b> BRL Barley BBM Bourbon Medium BRM Brighton Medium CLA Classic CLL Collectors*	<b>Earthy:</b> EAR Earthy HRV Harvest* LGC Legacy PRL Praline* SAF Saffron	<b>Maple:</b> ALM Ale Medium BUT Butterscotch CIN Cinnamon FLX Flax VEN Venetian	<b>Walnut:</b> AUB Auburn ESP Espresso MCH Mocha* NTO Night Owl* SIE Sienna*	TOF Toffee TRF Truffle*	Color: ASL Arctic Silver MBK Matte Black PEW Pewter SNK Soft Nickel	See list of options for each specific unit; Specify and add accordingly.
	<b>Double Cut</b> DC1 Double Cut	<b>ⓐ Wood Finish</b> Double Cut: COF Coffee FOS Fossil KHK Khaki CRM Cremello GRH Graphite STU Studio Teak		<b>ⓑ Chassis Grain Direction</b> For Double Cut Only: Vertical Horizontal				

Description	D	W	H	CTN WT	CU FT	① Model	List Price Per Grade			
26"h x 54"w Upholstered Tackboard Privacy Screen  	15/16	53 3/8	25 3/4	50	3	FLB54-26B4-RMTK	<b>COM</b> \$1,019 A \$1,044 B \$1,094 C \$1,181 D \$1,294 E \$1,406 F \$1,579 G \$1,768 H \$1,967 I \$2,278 J \$2,653			
	<b>Features:</b> <ul style="list-style-type: none"> <li>· use with Adjustable Height H-Frame Bench to achieve 48" overall height</li> <li>· mounts to center rail</li> <li>· com ydg: 2</li> </ul>									
	26"h x 48"w Upholstered Tackboard Privacy Screen  	15/16	47 3/8	25 3/4	45	3	FLB48-26B4-RMTK	<b>COM</b> \$981 A \$1,005 B \$1,048 C \$1,125 D \$1,226 E \$1,325 F \$1,480 G \$1,647 H \$1,823 I \$2,101 J \$2,434		
		<b>Features:</b> <ul style="list-style-type: none"> <li>· use with Adjustable Height H-Frame Bench to achieve 48" overall height</li> <li>· mounts to center rail</li> <li>· com ydg: 1 3/4</li> </ul>								
		26"h x 42"w Upholstered Tackboard Privacy Screen  	15/16	41 3/8	25 3/4	40	3	FLB42-26B4-RMTK	<b>COM</b> \$950 A \$970 B \$1,010 C \$1,077 D \$1,165 E \$1,252 F \$1,387 G \$1,533 H \$1,687 I \$1,930 J \$2,222	
			<b>Features:</b> <ul style="list-style-type: none"> <li>· use with Adjustable Height H-Frame Bench to achieve 48" overall height</li> <li>· mounts to center rail</li> <li>· com ydg: 1 1/2</li> </ul>							
			26"h x 36"w Upholstered Tackboard Privacy Screen  	15/16	35 3/8	25 3/4	35	2	FLB36-26B4-RMTK	<b>COM</b> \$919 A \$935 B \$969 C \$1,027 D \$1,102 E \$1,177 F \$1,293 G \$1,417 H \$1,550 I \$1,758 J \$2,009
				<b>Features:</b> <ul style="list-style-type: none"> <li>· use with Adjustable Height H-Frame Bench to achieve 48" overall height</li> <li>· mounts to center rail</li> <li>· com ydg: 1 1/2</li> </ul>						

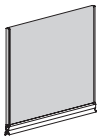
FLUX - OPEN PLAN

Description	D	W	H	CTN WT	CU FT	① Model	List Price Per Grade	
26" h x 30" w Upholstered Tackboard Privacy Screen  	15 1/16	29 3/8	25 3/4	30	2	FLB30-26B4-RMTK	COM \$901	
	<b>Features:</b>							A \$918
	<ul style="list-style-type: none"> <li>· use with Adjustable Height H-Frame Bench to achieve 48" overall height</li> <li>· mounts to center rail</li> <li>· com ydg: 1 1/4</li> </ul>							B \$952
								C \$1,010
								D \$1,084
								E \$1,159
								F \$1,275
								G \$1,400
								H \$1,533
								I \$1,740
							J \$1,990	
26" h x 24" w Upholstered Tackboard Privacy Screen  	15 1/16	23 3/8	25 3/4	24	2	FLB24-26B4-RMTK	COM \$860	
	<b>Features:</b>							A \$871
	<ul style="list-style-type: none"> <li>· use with Adjustable Height H-Frame Bench to achieve 48" overall height</li> <li>· mounts to center rail</li> <li>· com ydg: 1 1/4</li> </ul>							B \$893
								C \$932
								D \$982
								E \$1,031
								F \$1,110
								G \$1,193
								H \$1,282
								I \$1,419
							J \$1,587	
26" h x 18" w Upholstered Tackboard Privacy Screen  	15 1/16	17 3/8	25 3/4	19	2	FLB18-26B4-RMTK	COM \$825	
	<b>Features:</b>							A \$836
	<ul style="list-style-type: none"> <li>· use with Adjustable Height H-Frame Bench to achieve 48" overall height</li> <li>· mounts to center rail</li> <li>· com ydg: 1 1/4</li> </ul>							B \$859
								C \$897
								D \$947
								E \$996
								F \$1,075
								G \$1,158
								H \$1,246
								I \$1,385
							J \$1,551	

**To Order, Specify:**

① Model Number	② Fabric Selection	
(FLB)	Vendor Pattern Color	See a selection of graded in fabric manufacturers and patterns on pages 19-27. Contact Customer Service for additional fabric options.

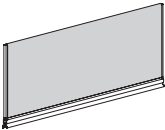
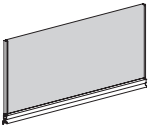
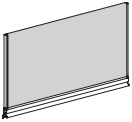
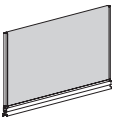

Description	D	W	H	CTN WT	CU FT	① Model	List Price Per Grade
<b>20" h x 54" w Upholstered Tackboard Privacy Screen</b>  	15 <sup>5</sup> / <sub>16</sub>	53 <sup>5</sup> / <sub>16</sub>	19 <sup>3</sup> / <sub>4</sub>	40	3	<b>FLB54-20B4-RMTK</b>	<b>COM \$981</b> A \$1,007 B \$1,057 C \$1,143 D \$1,256 E \$1,367 F \$1,542 G \$1,729 H \$1,929 I \$2,240 J \$2,614
<b>Features:</b> · use with Adjustable Height H-Frame Bench to achieve 42" overall height · mounts to center rail · com ydg: 2							
<b>20" h x 48" w Upholstered Tackboard Privacy Screen</b>  	15 <sup>5</sup> / <sub>16</sub>	47 <sup>5</sup> / <sub>16</sub>	19 <sup>3</sup> / <sub>4</sub>	36	2	<b>FLB48-20B4-RMTK</b>	<b>COM \$948</b> A \$971 B \$1,016 C \$1,092 D \$1,193 E \$1,292 F \$1,447 G \$1,614 H \$1,790 I \$2,068 J \$2,400
<b>Features:</b> · use with Adjustable Height H-Frame Bench to achieve 42" overall height · mounts to center rail · com ydg: 1 <sup>3</sup> / <sub>4</sub>							
<b>20" h x 42" w Upholstered Tackboard Privacy Screen</b>  	15 <sup>5</sup> / <sub>16</sub>	41 <sup>5</sup> / <sub>16</sub>	19 <sup>3</sup> / <sub>4</sub>	33	2	<b>FLB42-20B4-RMTK</b>	<b>COM \$921</b> A \$940 B \$980 C \$1,047 D \$1,135 E \$1,223 F \$1,357 G \$1,503 H \$1,658 I \$1,901 J \$2,192
<b>Features:</b> · use with Adjustable Height H-Frame Bench to achieve 42" overall height · mounts to center rail · com ydg: 1 <sup>1</sup> / <sub>2</sub>							
<b>20" h x 36" w Upholstered Tackboard Privacy Screen</b>  	15 <sup>5</sup> / <sub>16</sub>	35 <sup>5</sup> / <sub>16</sub>	19 <sup>3</sup> / <sub>4</sub>	29	2	<b>FLB36-20B4-RMTK</b>	<b>COM \$893</b> A \$910 B \$944 C \$1,001 D \$1,077 E \$1,151 F \$1,268 G \$1,392 H \$1,525 I \$1,732 J \$1,983
<b>Features:</b> · use with Adjustable Height H-Frame Bench to achieve 42" overall height · mounts to center rail · com ydg: 1 <sup>1</sup> / <sub>2</sub>							

FLUX - OPEN PLAN

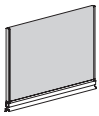
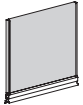
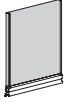
Description	D	W	H	CTN WT	CU FT	① Model	List Price Per Grade	
20" h x 30" w Upholstered Tackboard Privacy Screen  	15 1/16	29 5/8	19 3/4	25	2	FLB30-20B4-RMTK	COM \$879	
	<b>Features:</b>							A \$896
	· use with Adjustable Height H-Frame Bench to achieve 42" overall height							B \$930
	· mounts to center rail							C \$988
	· com ydg: 1 1/4							D \$1,063
								E \$1,138
								F \$1,254
								G \$1,379
								H \$1,511
								I \$1,719
							J \$1,969	
20" h x 24" w Upholstered Tackboard Privacy Screen  	15 1/16	23 5/8	19 3/4	24	2	FLB24-20B4-RMTK	COM \$842	
	<b>Features:</b>							A \$855
	· use with Adjustable Height H-Frame Bench to achieve 42" overall height							B \$876
	· mounts to center rail							C \$916
	· com ydg: 1 1/2							D \$965
								E \$1,015
								F \$1,092
								G \$1,176
								H \$1,264
								I \$1,403
							J \$1,569	
20" h x 18" w Upholstered Tackboard Privacy Screen  	15 1/16	17 5/8	19 3/4	19	2	FLB18-20B4-RMTK	COM \$805	
	<b>Features:</b>							A \$816
	· use with Adjustable Height H-Frame Bench to achieve 42" overall height							B \$838
	· mounts to center rail							C \$877
	· com ydg: 1 1/4							D \$927
								E \$977
								F \$1,054
								G \$1,138
								H \$1,227
								I \$1,364
							J \$1,532	

**To Order, Specify:**

① Model Number	② Fabric Selection	
(FLB)	Vendor Pattern Color	See a selection of graded in fabric manufacturers and patterns on pages 19-27. Contact Customer Service for additional fabric options.

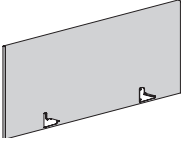
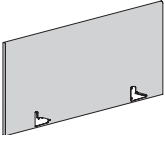
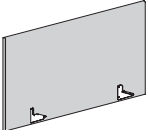
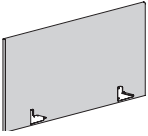
Description	D	W	H	CTN WT	CU FT	① Model	List Price Per Grade
<b>23" h x 60" w Upholstered Tackboard Edge Mount Privacy Screen</b> 	15 <sup>5</sup> / <sub>16</sub>	59 <sup>3</sup> / <sub>16</sub>	23	54	3	FLB60-23B4-EMTK	<b>COM \$995</b> A \$1,024 B \$1,079 C \$1,176 D \$1,301 E \$1,426 F \$1,620 G \$1,828 H \$2,049 I \$2,395 J \$2,811
<b>23" h x 54" w Upholstered Tackboard Edge Mount Privacy Screen</b> 	15 <sup>5</sup> / <sub>16</sub>	53 <sup>3</sup> / <sub>16</sub>	23	49	3	FLB54-23B4-EMTK	<b>COM \$969</b> A \$994 B \$1,045 C \$1,132 D \$1,244 E \$1,356 F \$1,530 G \$1,718 H \$1,918 I \$2,229 J \$2,603
<b>23" h x 48" w Upholstered Tackboard Edge Mount Privacy Screen</b> 	15 <sup>5</sup> / <sub>16</sub>	47 <sup>3</sup> / <sub>16</sub>	23	44	3	FLB48-23B4-EMTK	<b>COM \$942</b> A \$966 B \$1,011 C \$1,087 D \$1,188 E \$1,287 F \$1,442 G \$1,608 H \$1,785 I \$2,063 J \$2,395
<b>23" h x 42" w Upholstered Tackboard Edge Mount Privacy Screen</b> 	15 <sup>5</sup> / <sub>16</sub>	41 <sup>3</sup> / <sub>16</sub>	23	39	2	FLB42-23B4-EMTK	<b>COM \$917</b> A \$936 B \$976 C \$1,043 D \$1,131 E \$1,219 F \$1,353 G \$1,499 H \$1,654 I \$1,896 J \$2,187

- Features:**
- use with Adjustable Height H-frame Bench to achieve 48" overall height
  - mounts to underside of worksurface
  - extends 19" above worksurface
  - com ydg: 2

- Features:**
- use with Adjustable Height H-frame Bench to achieve 48" overall height
  - mounts to underside of worksurface
  - extends 19" above worksurface
  - com ydg: 2

- Features:**
- use with Adjustable Height H-frame Bench to achieve 48" overall height
  - mounts to underside of worksurface
  - extends 19" above worksurface
  - com ydg: 1 3/4

- Features:**
- use with Adjustable Height H-frame Bench to achieve 48" overall height
  - mounts to underside of worksurface
  - extends 19" above worksurface
  - com ydg: 1 1/2

FLUX - OPEN PLAN

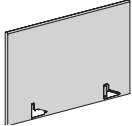
Description	D	W	H	CTN WT	CU FT	① Model	List Price Per Grade	
<b>23" h x 36" w Upholstered Tackboard Edge Mount Privacy Screen</b>  	15 <sup>1</sup> / <sub>16</sub>	35 <sup>5</sup> / <sub>16</sub>	23	34	2	FLB36-23B4-EMTK	<b>COM</b> \$892	
	<b>Features:</b>							A \$909
	<ul style="list-style-type: none"> <li>· use with Adjustable Height H-frame Bench to achieve 48" overall height</li> <li>· mounts to underside of worksurface</li> <li>· extends 19" above worksurface</li> <li>· com ydg: 1 1/2</li> </ul>							B \$942
								C \$1,000
								D \$1,076
								E \$1,150
								F \$1,266
								G \$1,391
								H \$1,524
								I \$1,731
								J \$1,982

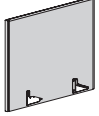
<b>23" h x 30" w Upholstered Tackboard Edge Mount Privacy Screen</b>  	15 <sup>1</sup> / <sub>16</sub>	29 <sup>5</sup> / <sub>16</sub>	23	27	2	FLB30-23B4-EMTK	<b>COM</b> \$880	
	<b>Features:</b>							A \$897
	<ul style="list-style-type: none"> <li>· use with Adjustable Height H-frame Bench to achieve 48" overall height</li> <li>· mounts to underside of worksurface</li> <li>· extends 19" above worksurface</li> <li>· com ydg: 1 1/2</li> </ul>							B \$931
								C \$989
								D \$1,064
								E \$1,139
								F \$1,255
								G \$1,380
								H \$1,512
								I \$1,720
								J \$1,970

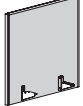

<b>23" h x 24" w Upholstered Tackboard Edge Mount Privacy Screen</b>  	15 <sup>1</sup> / <sub>16</sub>	23 <sup>5</sup> / <sub>16</sub>	23	22	2	FLB24-23B4-EMTK	<b>COM</b> \$856	
	<b>Features:</b>							A \$867
	<ul style="list-style-type: none"> <li>· use with Adjustable Height H-frame Bench to achieve 48" overall height</li> <li>· mounts to underside of worksurface</li> <li>· extends 19" above worksurface</li> <li>· com ydg: 1 1/2</li> </ul>							B \$889
								C \$928
								D \$978
								E \$1,027
								F \$1,105
								G \$1,189
								H \$1,277
								I \$1,415
								J \$1,581

**To Order, Specify:**

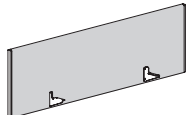
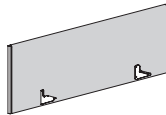
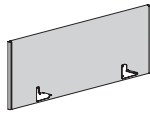
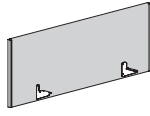
① Model Number	② Fabric Selection	
(FLB)	Vendor Pattern Color	See a selection of graded in fabric manufacturers and patterns on pages 19-27. Contact Customer Service for additional fabric options.

Description	D	W	H	CTN WT	CU FT	① Model	List Price Per Grade
<b>17" h x 60" w Upholstered Tackboard Edge Mount Privacy Screen</b> 	15 <sup>1</sup> / <sub>16</sub>	59 <sup>3</sup> / <sub>16</sub>	17	42	3	FLB60-17B4-EMTK	<b>COM \$973</b> A \$1,001 B \$1,057 C \$1,153 D \$1,280 E \$1,404 F \$1,598 G \$1,806 H \$2,027 I \$2,372 J \$2,788
<b>Features:</b> <ul style="list-style-type: none"> <li>· use with Adjustable Height H-frame Bench to achieve 42" overall height</li> <li>· mounts to underside of worksurface</li> <li>· extends 13" above worksurface</li> <li>· com ydg: 2</li> </ul>							
<b>17" h x 54" w Upholstered Tackboard Edge Mount Privacy Screen</b> 	15 <sup>1</sup> / <sub>16</sub>	53 <sup>3</sup> / <sub>16</sub>	17	38	2	FLB54-17B4-EMTK	<b>COM \$947</b> A \$972 B \$1,023 C \$1,110 D \$1,223 E \$1,334 F \$1,508 G \$1,696 H \$1,895 I \$2,206 J \$2,580
<b>Features:</b> <ul style="list-style-type: none"> <li>· use with Adjustable Height H-frame Bench to achieve 42" overall height</li> <li>· mounts to underside of worksurface</li> <li>· extends 13" above worksurface</li> <li>· com ydg: 2</li> </ul>							
<b>17" h x 48" w Upholstered Tackboard Edge Mount Privacy Screen</b> 	15 <sup>1</sup> / <sub>16</sub>	47 <sup>3</sup> / <sub>16</sub>	17	35	2	FLB48-17B4-EMTK	<b>COM \$921</b> A \$944 B \$988 C \$1,066 D \$1,166 E \$1,264 F \$1,419 G \$1,587 H \$1,763 I \$2,041 J \$2,372
<b>Features:</b> <ul style="list-style-type: none"> <li>· use with Adjustable Height H-frame Bench to achieve 42" overall height</li> <li>· mounts to underside of worksurface</li> <li>· extends 13" above worksurface</li> <li>· com ydg: 1 3/4</li> </ul>							
<b>17" h x 42" w Upholstered Tackboard Edge Mount Privacy Screen</b> 	15 <sup>1</sup> / <sub>16</sub>	41 <sup>3</sup> / <sub>16</sub>	17	31	2	FLB42-17B4-EMTK	<b>COM \$894</b> A \$915 B \$954 C \$1,021 D \$1,108 E \$1,196 F \$1,331 G \$1,476 H \$1,631 I \$1,874 J \$2,166
<b>Features:</b> <ul style="list-style-type: none"> <li>· use with Adjustable Height H-frame Bench to achieve 42" overall height</li> <li>· mounts to underside of worksurface</li> <li>· extends 13" above worksurface</li> <li>· com ydg: 1 1/2</li> </ul>							

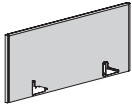
FLUX - OPEN PLAN

Description	D	W	H	CTN WT	CU FT	① Model	List Price Per Grade
<b>17" h x 36" w Upholstered Tackboard Edge Mount Privacy Screen</b>  	15 <sup>1</sup> / <sub>16</sub>	35 <sup>5</sup> / <sub>8</sub>	17	28	2	FLB36-17B4-EMTK	COM \$870
	<b>Features:</b>						A \$887
	· use with Adjustable Height H-frame Bench to achieve 42" overall height						B \$921
	· mounts to underside of worksurface						C \$979
	· extends 13" above worksurface						D \$1,053
	· com ydg: 1 1/2						E \$1,129
							F \$1,244
							G \$1,368
							H \$1,502
							I \$1,710
							J \$1,960
<b>17" h x 30" w Upholstered Tackboard Edge Mount Privacy Screen</b>  	15 <sup>1</sup> / <sub>16</sub>	29 <sup>5</sup> / <sub>8</sub>	17	21	2	FLB30-17B4-EMTK	COM \$859
	<b>Features:</b>						A \$875
	· use with Adjustable Height H-frame Bench to achieve 42" overall height						B \$909
	· mounts to underside of worksurface						C \$967
	· extends 13" above worksurface						D \$1,042
	· com ydg: 1 1/2						E \$1,117
							F \$1,233
							G \$1,357
							H \$1,490
							I \$1,698
							J \$1,948
<b>17" h x 24" w Upholstered Tackboard Edge Mount Privacy Screen</b>  	15 <sup>1</sup> / <sub>16</sub>	23 <sup>5</sup> / <sub>8</sub>	17	17	2	FLB24-17B4-EMTK	COM \$833
	<b>Features:</b>						A \$844
	· use with Adjustable Height H-frame Bench to achieve 42" overall height						B \$867
	· mounts to underside of worksurface						C \$906
	· extends 13" above worksurface						D \$956
	· com ydg: 1 1/2						E \$1,006
							F \$1,083
							G \$1,167
							H \$1,255
							I \$1,393
							J \$1,560

**To Order, Specify:**

① Model Number	② Fabric Selection	
(FLB)	Vendor Pattern Color	See a selection of graded in fabric manufacturers and patterns on pages 19-27. Contact Customer Service for additional fabric options.

Description	D	W	H	CTN WT	CU FT	① Model	Laminate	Flat Cut Veneer	Double Cut Veneer
	36	72	Adj.	194	18	FLT3672AHTD-EL	\$2,087		
	36	72	Adj.	194	18	FLV3672AHTD-EL		\$2,601	\$2,749
	30	72	Adj.	175	16	FLT3072AHTD-EL	\$2,015		
	30	72	Adj.	175	16	FLV3072AHTD-EL		\$2,502	\$2,642
	30	66	Adj.	168	15	FLT3066AHTD-EL	\$1,987		
	30	66	Adj.	168	15	FLV3066AHTD-EL		\$2,473	\$2,611
	30	60	Adj.	160	14	FLT3060AHTD-EL	\$1,961		
	30	60	Adj.	160	14	FLV3060AHTD-EL		\$2,443	\$2,579
	24	72	Adj.	151	12	FLT2472AHTD-EL	\$1,943		
	24	72	Adj.	151	12	FLV2472AHTD-EL		\$2,401	\$2,536
	24	66	Adj.	146	11	FLT2466AHTD-EL	\$1,915		
	24	66	Adj.	146	11	FLV2466AHTD-EL		\$2,378	\$2,510
	24	60	Adj.	140	10	FLT2460AHTD-EL	\$1,891		
	24	60	Adj.	140	10	FLV2460AHTD-EL		\$2,355	\$2,486

**Features:**

- eased edge profile on approach and user sides
- 22 1/2" to 48 1/2" height adjustment
- maximum weight rating 140 lbs. (evenly distributed load)
- key pad features height display with three memory settings; key pad mounts left or right
- 120" power cord

**Options:**

- specify Matte Black (MBK) or Arctic Silver (ASL) base finish
- reverse bevel edge available on desk approach side only, specify; add \$356 list for laminate or \$138 list for veneer
- top grommet available, specify location; add \$105 list each
- wireless charging unit available, specify location(s), see page 485; EC33 unit must be ordered separately, see page 560
- undermount power available, specify and add \$807 list

	30	84	Adj.	233	23	FLT3084-29AH120T	\$3,171		
	30	84	Adj.	233	23	FLV3084-29AH120T		\$3,931	\$4,206
	24	84	Adj.	218	21	FLT2484-29AH120T	\$3,107		
	24	84	Adj.	218	21	FLV2484-29AH120T		\$3,853	\$4,122

**Features:**

- eased edge profile on approach and user sides
- 22 1/2" to 48 1/2" height adjustment
- maximum weight rating 140 lbs. (evenly distributed load)
- key pad features height display with three memory settings; key pad mounts left or right
- 120" power cord

**Options:**

- specify Matte Black (MBK) or Arctic Silver (ASL) base finish
- top grommet available, specify location; add \$105 list each
- wireless charging unit available, specify location(s), see page 485; EC33 unit must be ordered separately, see page 560
- undermount power available, specify and add \$807 list

FLUX - OPEN PLAN

Description	D	W	H	CTN WT	CU FT	① Model	List Price
26" Privacy Screen - Acrylic - Adjustable Height Bench or Credenza Support	¼	53 ¾	25 ¾	22	4	FLB54-26B4-APS	\$1,030
	¼	47 ¾	25 ¾	20	4	FLB48-26B4-APS	\$924
	¼	41 ¾	25 ¾	18	4	FLB42-26B4-APS	\$814
	¼	35 ¾	25 ¾	16	3	FLB36-26B4-APS	\$707
	¼	29 ¾	25 ¾	15	3	FLB30-26B4-APS	\$600
	¼	23 ¾	25 ¾	14	3	FLB24-26B4-APS	\$540
	¼	17 ¾	25 ¾	13	2	FLB18-26B4-APS	\$486

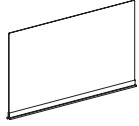

**Features:**

- use with Adjustable Height H-Frame Bench to achieve 48" overall height
- mounts to center rail; see page 486 for details

Description	D	W	H	CTN WT	CU FT	① Model	List Price
20" Privacy Screen - Acrylic - Adjustable Height Bench or Credenza Support	¼	53 ¾	19 ¾	19	4	FLB54-20B4-APS	\$830
	¼	47 ¾	19 ¾	17	3	FLB48-20B4-APS	\$746
	¼	41 ¾	19 ¾	16	3	FLB42-20B4-APS	\$658
	¼	35 ¾	19 ¾	14	3	FLB36-20B4-APS	\$573
	¼	29 ¾	19 ¾	13	2	FLB30-20B4-APS	\$490
	¼	23 ¾	19 ¾	12	2	FLB24-20B4-APS	\$409
	¼	17 ¾	19 ¾	11	2	FLB18-20B4-APS	\$332



**Features:**

- use with Adjustable Height H-Frame Bench to achieve 42" overall height
- mounts to center rail; see page 486 for details

**To Order, Specify:**

① Laminate Model #	② Laminate Selection	③ Metal Color	④ Other Product Options
Laminate (FLT)	<p>Solid Patterns:</p> <p>ALB Alabaster BBL Bridal Blanco DWH Designer White SHD Shadow SLG Slate Grey</p> <p>Wood Grain Patterns:</p> <p>AGA Aged Ash    CLL Collectors    STU Studio Teak ALL Ale Light    FLO Florence Walnut    VIN Vintage BLO Blonde Echo    GRH Graphite    WLH Walnut Heights BOL Bourbon Light    HGL High Line    WEA Weathered Ash BZW Brazilwood    OAT Oatmeal Cookie BGL Brighton Light    PIN Pinnacle Walnut</p>	<p>Color:</p> <p>ASL Arctic Silver MBK Matte Black PEW Pewter SNK Soft Nickel</p>	<p>See list of options for each specific unit; Specify and add accordingly.</p>

① Veneer Model #	② Wood Species	③ Wood Finish - Finishes with an asterisk (*) have a coordinating laminate available	④ Metal Color	⑤ Other Product Options
Veneer (FLV)	<p>Flat Cut</p> <p>CH1 Cherry MA1 Maple WA1 Walnut</p>	<p>Cherry:</p> <p>BRL Barley    EAR Earthy BBM Bourbon Medium    HRV Harvest* BRM Brighton Medium    LGC Legacy CLA Classic    PRL Praline* CLL Collectors*    SAF Saffron</p> <p>Maple:</p> <p>ALM Ale Medium    BUT Butterscotch CIN Cinnamon    FLX Flax VEN Venetian</p> <p>Walnut:</p> <p>AUB Auburn    TOF Toffee ESP Espresso    TRF Truffle* MCH Mocha* NTO Night Owl* SIE Sienna*</p>	<p>Color:</p> <p>ASL Arctic Silver MBK Matte Black PEW Pewter SNK Soft Nickel</p>	<p>See list of options for each specific unit; Specify and add accordingly.</p>
	<p>Double Cut</p> <p>DC1 Double Cut</p>	<p>ⓐ Wood Finish</p> <p>Double Cut: COF Coffee    FOS Fossil    KHK Khaki CRM Cremello    GRH Graphite    STU Studio Teak</p>	<p>ⓑ Chassis Grain Direction</p> <p>For Double Cut Only: Vertical Horizontal</p>	

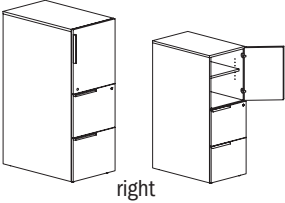

Description	D	W	H	CTN WT	CU FT	① Model	Laminate	Flat Cut Veneer	Double Cut Veneer
 <p>right</p>	30	18	48	178	22	FLT3018-48F2DR	\$1,827		
	30	18	48	178	22	FLV3018-48F2DR		\$2,393	\$2,631
	30	18	48	178	22	FLT3018-48F2DL	\$1,827		
	30	18	48	178	22	FLV3018-48F2DL		\$2,393	\$2,631
	24	18	48	157	18	FLT2418-48F2DR	\$1,715		
	24	18	48	157	18	FLV2418-48F2DR		\$2,246	\$2,471
	24	18	48	157	18	FLT2418-48F2DL	\$1,715		
	24	18	48	157	18	FLV2418-48F2DL		\$2,246	\$2,471

**Features:**

- pedestal front locking
- upper compartment has one adjustable shelf

**Options:**

- must specify chassis grain direction on double cut veneer, see pages 42-43 for details
- veneer door and drawer fronts available in contrasting paint color, specify paint color and add \$275 list; see page 44 for details
- laminate door and drawer fronts available in contrasting color, no upcharge, specify color; see page 44 for details
- ledge pulls standard; prism pulls available, specify and see page 39
- locking door available, specify and add \$123 list
- wire pass-thru grommets available, specify and add \$96 list
- power jumper available; specify and add \$38 list. (wire pass-thru grommet option must also be specified.)

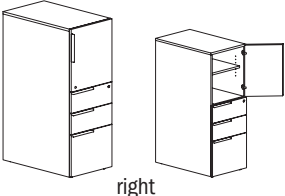
Description	D	W	H	CTN WT	CU FT	① Model	Laminate	Flat Cut Veneer	Double Cut Veneer
 <p>right</p>	30	18	48	178	22	FLT3018-48F1DR	\$1,833		
	30	18	48	178	22	FLV3018-48F1DR		\$2,399	\$2,639
	30	18	48	178	22	FLT3018-48F1DL	\$1,833		
	30	18	48	178	22	FLV3018-48F1DL		\$2,399	\$2,639
	24	18	48	159	18	FLT2418-48F1DR	\$1,721		
	24	18	48	159	18	FLV2418-48F1DR		\$2,253	\$2,478
	24	18	48	159	18	FLT2418-48F1DL	\$1,721		
	24	18	48	159	18	FLV2418-48F1DL		\$2,253	\$2,478

**Features:**

- pedestal front locking
- upper compartment has one adjustable shelf

**Options:**

- must specify chassis grain direction on double cut veneer, see pages 42-43 for details
- veneer door and drawer fronts available in contrasting paint color, specify paint color and add \$275 list; see page 44 for details
- laminate door and drawer fronts available in contrasting color, no upcharge, specify color; see page 44 for details
- ledge pulls standard; prism pulls available, specify and see page 39
- locking door available, specify and add \$123 list
- wire pass-thru grommets available, specify and add \$96 list
- power jumper available; specify and add \$38 list. (wire pass-thru grommet option must also be specified.)

left

FLUX - OPEN PLAN

Description	D	W	H	CTN WT	CU FT	① Model	Laminate	Flat Cut Veneer	Double Cut Veneer
48" h File/File, CPU Storage Cabinet	30	18	48	173	22	FLT3018-48F2CPR	\$1,907		
	30	18	48	173	22	FLV3018-48F2CPR		\$2,498	\$2,748
	30	18	48	173	22	FLT3018-48F2CPL	\$1,907		
	30	18	48	173	22	FLV3018-48F2CPL		\$2,498	\$2,748
	24	18	48	157	18	FLT2418-48F2CPR	\$1,790		
	24	18	48	157	18	FLV2418-48F2CPR		\$2,345	\$2,579
	24	18	48	157	18	FLT2418-48F2CPL	\$1,790		
	24	18	48	157	18	FLV2418-48F2CPL		\$2,345	\$2,579

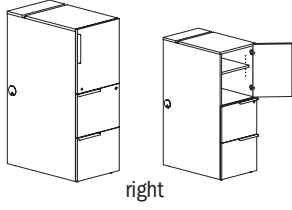

right

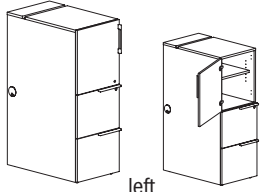

left

**Features:**

- pedestal front locking
- upper compartment has one adjustable equipment shelf
- ventilation slot on top of cabinet
- wire pass-thru grommets standard

**Options:**

- must specify chassis grain direction on double cut veneer, see pages 42-43 for details
- veneer door and drawer fronts available in contrasting paint color, specify paint color and add \$275 list; see page 44 for details
- laminate door and drawer fronts available in contrasting color, no upcharge, specify color; see page 44 for details
- ledge pulls standard; prism pulls available, specify and see page 39
- locking door available, specify and add \$123 list
- power jumper available; specify and add \$38 list. (wire pass-thru grommet option must also be specified.)

48" h Box/Box/File, CPU Storage Cabinet	D	W	H	CTN WT	CU FT	① Model	Laminate	Flat Cut Veneer	Double Cut Veneer
48" h Box/Box/File, CPU Storage Cabinet	30	18	48	175	22	FLT3018-48F1CPR	\$1,913		
	30	18	48	175	22	FLV3018-48F1CPR		\$2,504	\$2,755
	30	18	48	175	22	FLT3018-48F1CPL	\$1,913		
	30	18	48	175	22	FLV3018-48F1CPL		\$2,504	\$2,755
	24	18	48	157	18	FLT2418-48F1CPR	\$1,798		
	24	18	48	157	18	FLV2418-48F1CPR		\$2,351	\$2,588
	24	18	48	157	18	FLT2418-48F1CPL	\$1,798		
	24	18	48	157	18	FLV2418-48F1CPL		\$2,351	\$2,588

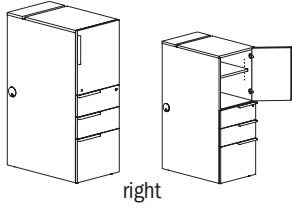

right

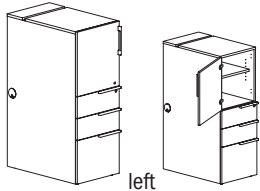

left

**Features:**

- pedestal front locking
- upper compartment has one adjustable equipment shelf
- ventilation slot on top of cabinet
- wire pass-thru grommets standard

**Options:**

- must specify chassis grain direction on double cut veneer, see pages 42-43 for details
- veneer door and drawer fronts available in contrasting paint color, specify paint color and add \$275 list; see page 44 for details
- laminate door and drawer fronts available in contrasting color, no upcharge, specify color; see page 44 for details
- ledge pulls standard; prism pulls available, specify and see page 39
- locking door available, specify and add \$123 list
- power jumper available; specify and add \$38 list. (wire pass-thru grommet option must also be specified.)

**To Order, Specify:**

① Laminate Model #	② Laminate Type	③ Laminate Selection			④ Metal Color	⑤ Other Product Options	
Laminate (FLT)	HPL	<b>Solid Patterns:</b> ALB Alabaster BBL Bridal Blanco DWH Designer White SHD Shadow SLG Slate Grey	<b>Wood Grain Patterns:</b> AGA Aged Ash ALL Ale Light BLO Blonde Echo BOL Bourbon Light BZW Brazilwood BGL Brighton Light	CLL Collectors FLO Florence Walnut GRH Graphite HGL High Line OAT Oatmeal Cookie PIN Pinnacle Walnut	STU Studio Teak VIN Vintage WLH Walnut Heights WEA Weathered Ash	Color: ASL Arctic Silver MBK Matte Black PEW Pewter SNK Soft Nickel	See list of options for each specific unit; Specify and add accordingly.

① Veneer Model #	② Wood Species	③ Wood Finish - Finishes with an asterisk (*) have a coordinating laminate available			④ Metal Color	⑤ Other Product Options		
Veneer (FLV)	<b>Flat Cut</b> CH1 Cherry MA1 Maple WA1 Walnut	<b>Cherry:</b> BRL Barley BBM Bourbon Medium BRM Brighton Medium CLA Classic CLL Collectors*	<b>Earthy:</b> EAR Earthy HRV Harvest* LGC Legacy PRL Praline* SAF Saffron	<b>Maple:</b> ALM Ale Medium BUT Butterscotch CIN Cinnamon FLX Flax VEN Venetian	<b>Walnut:</b> AUB Auburn ESP Espresso MCH Mocha* NTO Night Owl* SIE Sienna*	TOF Toffee TRF Truffle*	Color: ASL Arctic Silver MBK Matte Black PEW Pewter SNK Soft Nickel	See list of options for each specific unit; Specify and add accordingly.
	<b>Double Cut</b> DC1 Double Cut	<b>Wood Finish</b> COF Coffee FOS Fossil CRM Cremello		<b>Chassis Grain Direction</b> KHK Khaki GRH Graphite STU Studio Teak		For Double Cut Only: Vertical Horizontal		

Description	D	W	H	CTN WT	CU FT	① Model	Laminate	Flat Cut Veneer	Double Cut Veneer
48" h File/File, Side Access Shelf	30	18	48	168	22	FLT3018-48F2SAR	\$1,945		
	30	18	48	168	22	FLV3018-48F2SAR		\$2,548	\$2,804
	30	18	48	168	22	FLT3018-48F2SAL	\$1,945		
	30	18	48	168	22	FLV3018-48F2SAL		\$2,548	\$2,804
	24	18	48	162	18	FLT2418-48F2SAR	\$1,827		
	24	18	48	162	18	FLV2418-48F2SAR		\$2,392	\$2,631
	24	18	48	162	18	FLT2418-48F2SAL	\$1,827		
	24	18	48	162	18	FLV2418-48F2SAL		\$2,392	\$2,631

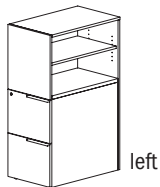
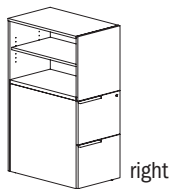

**Features:**

- pedestal front locking
- upper compartment has one adjustable shelf

**Options:**

- must specify chassis grain direction on double cut veneer, see pages 42-43 for details
- veneer door and drawer fronts available in contrasting paint color, specify paint color and add \$275 list; see page 44 for details
- laminate door and drawer fronts available in contrasting color, no upcharge, specify color; see page 44 for details
- ledge pulls standard; prism pulls available, specify and see page 39
- wire pass-thru grommets available, specify and add \$96 list
- power jumper available; specify and add \$38 list. (wire pass-thru grommet option must also be specified.)

48" h Box/Box/File, Side Access Shelf	30	18	48	170	22	FLT3018-48F1SAR	\$1,952		
	30	18	48	170	22	FLV3018-48F1SAR		\$2,554	\$2,811
	30	18	48	170	22	FLT3018-48F1SAL	\$1,952		
	30	18	48	170	22	FLV3018-48F1SAL		\$2,554	\$2,811
	24	18	48	167	18	FLT2418-48F1SAR	\$1,833		
	24	18	48	167	18	FLV2418-48F1SAR		\$2,398	\$2,639
	24	18	48	167	18	FLT2418-48F1SAL	\$1,833		
	24	18	48	167	18	FLV2418-48F1SAL		\$2,398	\$2,639

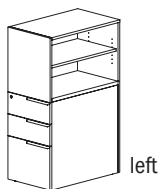
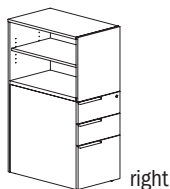

**Features:**

- pedestal front locking
- upper compartment has one adjustable shelf

**Options:**

- must specify chassis grain direction on double cut veneer, see pages 42-43 for details
- veneer door and drawer fronts available in contrasting paint color, specify paint color and add \$275 list; see page 44 for details
- laminate door and drawer fronts available in contrasting color, no upcharge, specify color; see page 44 for details
- ledge pulls standard; prism pulls available, specify and see page 39
- wire pass-thru grommets available, specify and add \$96 list
- power jumper available; specify and add \$38 list. (wire pass-thru grommet option must also be specified.)

Description	D	W	H	CTN WT	CU FT	① Model	Laminate	Flat Cut Veneer	Double Cut Veneer
48" h Box/File, Storage Cabinet  right  left	30	18	48	175	22	FLT3018-48L5DR	\$2,290		
	30	18	48	175	22	FLV3018-48L5DR		\$2,889	\$3,179
	30	18	48	175	22	FLT3018-48L5DL	\$2,290		
	30	18	48	175	22	FLV3018-48L5DL		\$2,889	\$3,179
	24	18	48	151	18	FLT2418-48L5DR	\$2,173		
	24	18	48	151	18	FLV2418-48L5DR		\$2,740	\$3,015
	24	18	48	151	18	FLT2418-48L5DL	\$2,173		
	24	18	48	151	18	FLV2418-48L5DL		\$2,740	\$3,015

**Features:**

- pedestal front locking
- upper compartment has one adjustable shelf

**Options:**

- must specify chassis grain direction on double cut veneer, see pages 42-43 for details
- veneer door and drawer fronts available in contrasting paint color, specify paint color and add \$275 list; see page 44 for details
- laminate door and drawer fronts available in contrasting color, no upcharge, specify color; see page 44 for details
- ledge pulls standard; prism pulls available, specify and see page 39
- locking door
- available, specify and add \$123 list
- wire pass-thru grommets available, specify and add \$96 list
- power jumper available; specify and add \$38 list. (wire pass-thru grommet option must also be specified.)

Description	D	W	H	CTN WT	CU FT	① Model	Laminate	Flat Cut Veneer	Double Cut Veneer
48" h Box/File, CPU Storage Cabinet  right  left	30	18	48	170	22	FLT3018-48L5CPR	\$2,390		
	30	18	48	170	22	FLV3018-48L5CPR		\$3,018	\$3,319
	30	18	48	170	22	FLT3018-48L5CPL	\$2,390		
	30	18	48	170	22	FLV3018-48L5CPL		\$3,018	\$3,319
	24	18	48	150	18	FLT2418-48L5CPR	\$2,267		
	24	18	48	150	18	FLV2418-48L5CPR		\$2,862	\$3,147
	24	18	48	150	18	FLT2418-48L5CPL	\$2,267		
	24	18	48	150	18	FLV2418-48L5CPL		\$2,862	\$3,147

**Features:**

- pedestal front locking
- upper compartment has one adjustable equipment shelf
- ventilation slot on top of cabinet
- wire pass-thru grommets standard

**Options:**

- must specify chassis grain direction on double cut veneer, see pages 42-43 for details
- veneer door and drawer fronts available in contrasting paint color, specify paint color and add \$275 list; see page 44 for details
- laminate door and drawer fronts available in contrasting color, no upcharge, specify color; see page 44 for details
- ledge pulls standard; prism pulls available, specify and see page 39
- locking door available, specify and add \$123 list
- power jumper available; specify and add \$38 list. (wire pass-thru grommet option must also be specified.)

**To Order, Specify:**

① Laminate Model #	② Laminate Type	③ Laminate Selection	④ Metal Color	⑤ Other Product Options
Laminate (FLT)	HPL	<p><b>Solid Patterns:</b></p> <p>ALB Alabaster BBL Bridal Blanco DWH Designer White SHD Shadow SLG Slate Grey</p> <p><b>Wood Grain Patterns:</b></p> <p>AGA Aged Ash ALL Ale Light BLO Blonde Echo BOL Bourbon Light BZW Brazilwood BGL Brighton Light</p> <p>CLL Collectors FLO Florence Walnut GRH Graphite HGL High Line OAT Oatmeal Cookie PIN Pinnacle Walnut</p> <p>STU Studio Teak VIN Vintage WLH Walnut Heights WEA Weathered Ash</p>	Color: ASL Arctic Silver MBK Matte Black PEW Pewter SNK Soft Nickel	See list of options for each specific unit; Specify and add accordingly.

① Veneer Model #	② Wood Species	③ Wood Finish - Finishes with an asterisk (*) have a coordinating laminate available	④ Metal Color	⑤ Other Product Options
Veneer (FLV)	Flat Cut CH1 Cherry MA1 Maple WA1 Walnut	<p><b>Cherry:</b></p> <p>BRL Barley BBM Bourbon Medium BRM Brighton Medium CLA Classic CLL Collectors*</p> <p><b>Earthy:</b></p> <p>EAR Earthy HRV Harvest* LGC Legacy PRL Praline* SAF Saffron</p> <p><b>Maple:</b></p> <p>ALM Ale Medium BUT Butterscotch CIN Cinnamon FLX Flax VEN Venetian</p> <p><b>Walnut:</b></p> <p>AUB Auburn ESP Espresso MCH Mocha* NTO Night Owl* SIE Sienna*</p> <p>TOF Toffee TRF Truffle*</p>	Color: ASL Arctic Silver MBK Matte Black PEW Pewter SNK Soft Nickel	See list of options for each specific unit; Specify and add accordingly.
	Double Cut DC1 Double Cut	<p><b>Wood Finish</b></p> <p>COF Coffee CRM Cremello</p> <p>FOS Fossil GRH Graphite</p> <p>KHK Khaki STU Studio Teak</p>	<p><b>Chassis Grain Direction</b></p> <p>For Double Cut Only: Vertical Horizontal</p>	

FLUX - OPEN PLAN

Description	D	W	H	CTN WT	CU FT	① Model	Laminate	Flat Cut Veneer	Double Cut Veneer
48" h Box/File, Side Access Shelf	30	18	48	179	22	FLT3018-48L5SAR	\$2,406		
	30	18	48	179	22	FLV3018-48L5SAR		\$3,037	\$3,414
	30	18	48	179	22	FLT3018-48L5SAL	\$2,406		
	30	18	48	179	22	FLV3018-48L5SAL		\$3,037	\$3,414
	24	18	48	154	18	FLT2418-48L5SAR	\$2,284		
	24	18	48	154	18	FLV2418-48L5SAR		\$2,880	\$3,237
	24	18	48	154	18	FLT2418-48L5SAL	\$2,284		
	24	18	48	154	18	FLV2418-48L5SAL		\$2,880	\$3,237

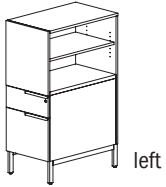

**Features:**

- pedestal front locking
- upper compartment has one adjustable shelf

**Options:**

- must specify chassis grain direction on double cut veneer, see pages 42-43 for details
- veneer door and drawer fronts available in contrasting paint color, specify paint color and add \$275 list; see page 44 for details
- laminate door and drawer fronts available in contrasting color, no upcharge, specify color; see page 44 for details
- ledge pulls standard; prism pulls available, specify and see page 39
- wire pass-thru grommets available, specify and add \$96 list
- power jumper available; specify and add \$38 list. (wire pass-thru grommet option must also be specified.)

48" h Pantry Drawer with Filing and Wardrobe, Single User	30	18	48	254	23	FLT3018-48PTAR	\$2,285		
	30	18	48	254	23	FLV3018-48PTAR		\$2,940	\$3,221
	30	18	48	254	23	FLT3018-48PTAL	\$2,285		
	30	18	48	254	23	FLV3018-48PTAL		\$2,940	\$3,221

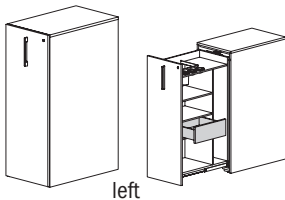
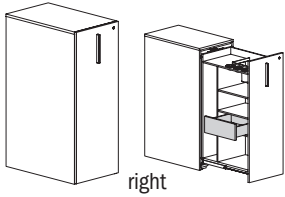

**Features:**

- filing brackets, accessory trays, fixed shelf, box drawer and wardrobe coat hook
- may not be used with Mid Support bracket to support Bench or Table Surfaces
- drawer extends 26"

**Options:**

- must specify drawer interior color, Designer White or Slate Grey
- must specify chassis grain direction on double cut veneer, see pages 42-43 for details
- veneer door and drawer fronts available in contrasting paint color, specify paint color and add \$275 list; see page 44 for details
- laminate door and drawer fronts available in contrasting color, no upcharge, specify color; see page 44 for details
- ledge pulls standard; prism pulls available, specify and see page 39
- locking door available, specify and add \$123 list
- wire pass-thru grommets available, specify and add \$96 list
- markerboard available on drawer back panel, specify and add \$416 list
- power jumper available; specify and add \$38 list. (wire pass-thru grommet option must also be specified.)

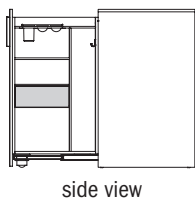

FLUX - OPEN PLAN

Description	D	W	H	CTN WT	CU FT	① Model	Laminate	Flat Cut Veneer	Double Cut Veneer
48" h Pantry Drawer with Paper Sorter and Wardrobe, Single User	30	18	48	234	23	FLT3018-48PTBR	\$2,182		
	30	18	48	234	23	FLV3018-48PTBR		\$2,838	\$3,109
	30	18	48	234	23	FLT3018-48PTBL	\$2,182		
	30	18	48	234	23	FLV3018-48PTBL		\$2,838	\$3,109
	24	18	48	169	18	FLT2418-48PTBR	\$2,124		
	24	18	48	169	18	FLV2418-48PTBR		\$2,762	\$2,998
	24	18	48	169	18	FLT2418-48PTBL	\$2,124		
	24	18	48	169	18	FLV2418-48PTBL		\$2,762	\$2,998

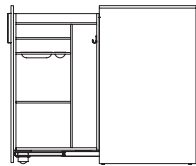
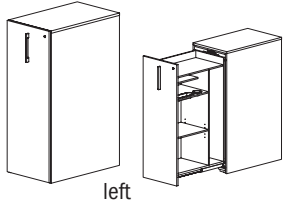
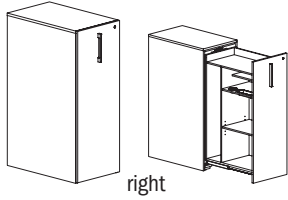

**Features:**

- paper shelves, accessory trays, fixed shelves and wardrobe coat hook
- may not be used with Mid Support bracket to support Bench or Table Surfaces
- drawer extends 26" on 30"d units, 20" on 24"d units

**Options:**

- must specify drawer interior color, Designer White or Slate Grey
- must specify chassis grain direction on double cut veneer, see pages 42-43 for details
- veneer door and drawer fronts available in contrasting paint color, specify paint color and add \$275 list; see page 44 for details
- laminate door and drawer fronts available in contrasting color, no upcharge, specify color; see page 44 for details
- ledge pulls standard; prism pulls available, specify and see page 39
- locking door available, specify and add \$123 list
- wire pass-thru grommets available, specify and add \$96 list
- markerboard available on drawer back panel, specify and add \$416 list
- power jumper available; specify and add \$38 list. (wire pass-thru grommet option must also be specified.)

**To Order, Specify:**

① Laminate Model #	② Laminate Type	③ Laminate Selection	④ Metal Color	⑤ Other Product Options
Laminate (FLT)	HPL	<p>Solid Patterns:</p> <p>ALB Alabaster BBL Bridal Blanco DWH Designer White SHD Shadow SLG Slate Grey</p> <p>Wood Grain Patterns:</p> <p>AGA Aged Ash ALL Ale Light BLO Blonde Echo BOL Bourbon Light BZW Brazilwood BGL Brighton Light</p> <p>CLL Collectors FLO Florence Walnut GRH Graphite HGL High Line OAT Oatmeal Cookie PIN Pinnacle Walnut</p> <p>STU Studio Teak VIN Vintage WLH Walnut Heights WEA Weathered Ash</p>	<p>Color:</p> <p>ASL Arctic Silver MBK Matte Black PEW Pewter SNK Soft Nickel</p>	See list of options for each specific unit; Specify and add accordingly.

① Veneer Model #	② Wood Species	③ Wood Finish - Finishes with an asterisk (*) have a coordinating laminate available	④ Metal Color	⑤ Other Product Options
Veneer (FLV)	Flat Cut CH1 Cherry MA1 Maple WA1 Walnut	<p>Cherry:</p> <p>BRL Barley BBM Bourbon Medium BRM Brighton Medium CLA Classic CLL Collectors*</p> <p>EAR Earthy HRV Harvest* LGC Legacy PRL Praline* SAF Saffron</p> <p>Maple:</p> <p>ALM Ale Medium BUT Butterscotch CIN Cinnamon FLX Flax VEN Venetian</p> <p>Walnut:</p> <p>AUB Auburn ESP Espresso MCH Mocha* NTO Night Owl* SIE Sienna*</p> <p>TOF Toffee TRF Truffle*</p>	<p>Color:</p> <p>ASL Arctic Silver MBK Matte Black PEW Pewter SNK Soft Nickel</p>	See list of options for each specific unit; Specify and add accordingly.
	Double Cut DC1 Double Cut	<p>ⓐ Wood Finish</p> <p>Double Cut: COF Coffee CRM Cremello</p> <p>FOS Fossil GRH Graphite</p> <p>KHK Khaki STU Studio Teak</p> <p>ⓑ Chassis Grain Direction</p> <p>For Double Cut Only: Vertical Horizontal</p>		

Description	D	W	H	CTN WT	CU FT	① Model	Laminate	Flat Cut Veneer	Double Cut Veneer
48" h Pantry Drawer with Filing, Single User	30	18	48	218	23	FLT3018-48PTCR	\$2,213		
	30	18	48	218	23	FLV3018-48PTCR		\$2,879	\$3,153
	30	18	48	218	23	FLT3018-48PTCL	\$2,213		
	30	18	48	218	23	FLV3018-48PTCL		\$2,879	\$3,153
	24	18	48	192	18	FLT2418-48PTCR	\$2,154		
	24	18	48	192	18	FLV2418-48PTCR		\$2,802	\$3,041
	24	18	48	192	18	FLT2418-48PTCL	\$2,154		
	24	18	48	192	18	FLV2418-48PTCL		\$2,802	\$3,041

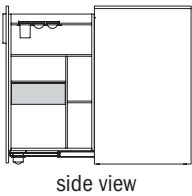
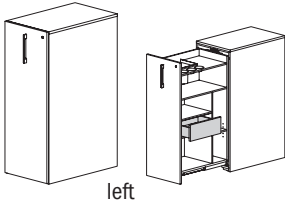
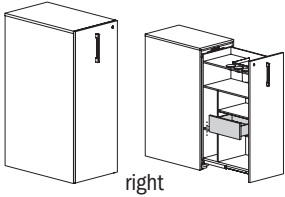

**Features:**

- filing brackets, accessory trays, fixed shelves and box drawer
- may not be used with Mid Support bracket to support Bench or Table Surfaces
- drawer extends 26" on 30"d units, 20" on 24"d units

**Options:**

- must specify drawer interior color, Designer White or Slate Grey
- must specify chassis grain direction on double cut veneer, see pages 42-43 for details
- veneer door and drawer fronts available in contrasting paint color, specify paint color and add \$275 list; see page 44 for details
- laminate door and drawer fronts available in contrasting color, no upcharge, specify color; see page 44 for details
- ledge pulls standard; prism pulls available, specify and see page 39
- locking door available, specify and add \$123 list
- wire pass-thru grommets available, specify and add \$96 list
- markerboard available on drawer back panel, specify and add \$416 list
- power jumper available; specify and add \$38 list. (wire pass-thru grommet option must also be specified.)

48" h Pantry Drawer with Paper Sorter, Single User	30	18	48	209	23	FLT3018-48PTDR	\$2,162		
	30	18	48	209	23	FLV3018-48PTDR		\$2,812	\$3,080
	30	18	48	209	23	FLT3018-48PTDL	\$2,162		
	30	18	48	209	23	FLV3018-48PTDL		\$2,812	\$3,080
	24	18	48	163	18	FLT2418-48PTDR	\$2,105		
	24	18	48	163	18	FLV2418-48PTDR		\$2,735	\$2,970
	24	18	48	163	18	FLT2418-48PTDL	\$2,105		
	24	18	48	163	18	FLV2418-48PTDL		\$2,735	\$2,970

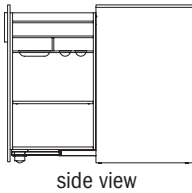
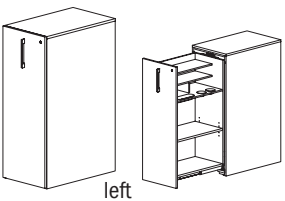
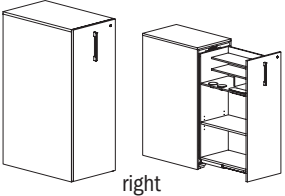

**Features:**

- paper shelves, accessory trays and fixed shelves
- may not be used with Mid Support bracket to support Bench or Table Surfaces
- drawer extends 26" on 30"d units, 20" on 24"d units

**Options:**

- must specify drawer interior color, Designer White or Slate Grey
- must specify chassis grain direction on double cut veneer, see pages 42-43 for details
- veneer door and drawer fronts available in contrasting paint color, specify paint color and add \$275 list; see page 44 for details
- laminate door and drawer fronts available in contrasting color, no upcharge, specify color; see page 44 for details
- ledge pulls standard; prism pulls available, specify and see page 39
- locking door available, specify and add \$123 list
- wire pass-thru grommets available, specify and add \$96 list
- markerboard available on drawer back panel, specify and add \$416 list
- power jumper available; specify and add \$38 list. (wire pass-thru grommet option must also be specified.)



Description	D	W	H	CTN WT	CU FT	① Model	Laminate	Flat Cut Veneer	Double Cut Veneer
48" h Pantry Drawer, Dual User	30	18	48	225	23	FLT3018-48PTE	\$2,317		
	30	18	48	225	23	FLV3018-48PTE		\$3,017	\$3,304
	24	18	48	184	18	FLT2418-48PTE	\$2,256		
	24	18	48	184	18	FLV2418-48PTE		\$3,030	\$3,214

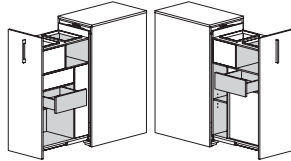
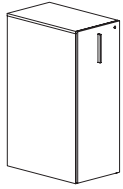

side view

**Features:**

- filing brackets, fixed shelves and box drawer for each side
- may not be used with Mid Support bracket to support Bench or Table Surfaces
- drawer extends 26" on 30"d units, 20" on 24"d units

**Options:**

- must specify drawer interior color, Designer White or Slate Grey
- must specify chassis grain direction on double cut veneer, see pages 42-43 for details
- veneer door and drawer fronts available in contrasting paint color, specify paint color and add \$275 list; see page 44 for details
- laminate door and drawer fronts available in contrasting color, no upcharge, specify color; see page 44 for details
- ledge pulls standard; prism pulls available, specify and see page 39
- locking door available, specify and add \$123 list
- wire pass-thru grommets available, specify and add \$96 list
- power jumper available; specify and add \$38 list. (wire pass-thru grommet option must also be specified.)

Description	D	W	H	CTN WT	CU FT	① Model	List Price
Tack Panel	1/2	28 7/8	17 1/2	13	2	FLB30-18B1-FTK	\$151
	1/2	23 1/8	17 1/2	12	2	FLB24-18B1-FTK	\$124

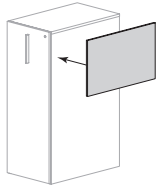

**Features:**

- mounts to sides of 48" h Storage Cabinets
- sizes coordinate with depth of Storage Cabinets

**Options:**

- select color, ash grey or silver grey

**To Order, Specify:**

① Laminate Model #	② Laminate Type	③ Laminate Selection			④ Metal Color	⑤ Other Product Options	
Laminate (FLT)	HPL	<b>Solid Patterns:</b> ALB Alabaster BBL Bridal Blanco DWH Designer White SHD Shadow SLG Slate Grey	<b>Wood Grain Patterns:</b> AGA Aged Ash ALL Ale Light BLO Blonde Echo BOL Bourbon Light BZW Brazilwood BGL Brighton Light	CLL Collectors FLO Florence Walnut GRH Graphite HGL High Line OAT Oatmeal Cookie PIN Pinnacle Walnut	STU Studio Teak VIN Vintage WLH Walnut Heights WEA Weathered Ash	Color: ASL Arctic Silver MBK Matte Black PEW Pewter SNK Soft Nickel	See list of options for each specific unit; Specify and add accordingly.

① Veneer Model #	② Wood Species	③ Wood Finish - Finishes with an asterisk (*) have a coordinating laminate available			④ Metal Color	⑤ Other Product Options	
Veneer (FLV)	<b>Flat Cut</b> CH1 Cherry MA1 Maple WA1 Walnut	<b>Cherry:</b> BRL Barley BBM Bourbon Medium BRM Brighton Medium CLA Classic CLL Collectors*	<b>Earthy:</b> EAR Earthy HRV Harvest* LGC Legacy PRL Praline* SAF Saffron	<b>Maple:</b> ALM Ale Medium BUT Butterscotch CIN Cinnamon FLX Flax VEN Venetian	<b>Walnut:</b> AUB Auburn ESP Espresso MCH Mocha* NTO Night Owl* SIE Sienna*	Color: ASL Arctic Silver MBK Matte Black PEW Pewter SNK Soft Nickel	See list of options for each specific unit; Specify and add accordingly.
	<b>Double Cut</b> DC1 Double Cut	<b>ⓐ Wood Finish</b> Double Cut: COF Coffee FOS Fossil KHK Khaki CRM Cremello GRH Graphite STU Studio Teak		<b>ⓑ Chassis Grain Direction</b> For Double Cut Only: Vertical Horizontal			



Description	D	W	H	CTN WT	CU FT	① Model	Laminate	Flat Cut Veneer	Double Cut Veneer
Dual Sided Lateral File Credenza	22 3/4	36	21	157	15	FLT2236-21F5F5R	\$1,291		
	22 3/4	36	21	157	15	FLV2236-21F5F5R		\$1,691	\$1,860
	22 3/4	36	21	157	15	FLT2236-21F5F5L	\$1,291		
	22 3/4	36	21	157	15	FLV2236-21F5F5L		\$1,691	\$1,860

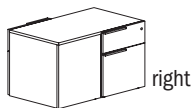

right

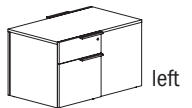

left

**Features:**

- pedestal front locking

**Options:**

- must specify chassis grain direction on double cut veneer, see pages 42-43 for details
- veneer door and drawer fronts available in contrasting paint color, specify paint color and add \$275 list; see page 44 for details
- laminate door and drawer fronts available in contrasting color, no upcharge, specify color; see page 44 for details
- ledge pulls standard; prism pulls available, specify and see page 39
- oval or rectangular seat cushion available; see page 582

Dual Sided Lateral File Credenza	22 3/4	72	21	250	28	FLT2272-21F6F6R	\$1,839		
	22 3/4	72	21	250	28	FLV2272-21F6F6R		\$2,572	\$2,830
	22 3/4	72	21	250	28	FLT2272-21F6F6L	\$1,839		
	22 3/4	72	21	250	28	FLV2272-21F6F6L		\$2,572	\$2,830
	22 3/4	60	21	224	23	FLT2260-21F6F6R	\$1,763		
	22 3/4	60	21	224	23	FLV2260-21F6F6R		\$2,459	\$2,705
	22 3/4	60	21	224	23	FLT2260-21F6F6L	\$1,763		
	22 3/4	60	21	224	23	FLV2260-21F6F6L		\$2,459	\$2,705

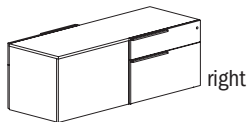

right

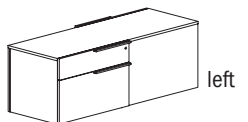

left

**Features:**

- pedestal front locking

**Options:**

- must specify chassis grain direction on double cut veneer, see pages 42-43 for details
- veneer door and drawer fronts available in contrasting paint color, specify paint color and add \$275 list; see page 44 for details
- laminate door and drawer fronts available in contrasting color, no upcharge, specify color; see page 44 for details
- ledge pulls standard; prism pulls available, specify and see page 39
- oval or rectangular seat cushion available; see page 582

Dual Sided Lateral File Credenza - Flush Legs	22 3/4	36	21	129	15	FLT2236-21L5L5R	\$1,697		
	22 3/4	36	21	129	15	FLV2236-21L5L5R		\$2,128	\$2,297
	22 3/4	36	21	129	15	FLT2236-21L5L5L	\$1,697		
	22 3/4	36	21	129	15	FLV2236-21L5L5L		\$2,128	\$2,297

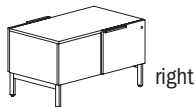

right



left

**Features:**

- pedestal front locking

**Options:**

- must specify chassis grain direction on double cut veneer, see pages 42-43 for details
- veneer door and drawer fronts available in contrasting paint color, specify paint color and add \$275 list; see page 44 for details
- laminate door and drawer fronts available in contrasting color, no upcharge, specify color; see page 44 for details
- ledge pulls standard; prism pulls available, specify and see page 39
- oval or rectangular seat cushion available; see page 582

FLUX - OPEN PLAN

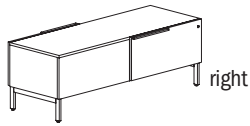
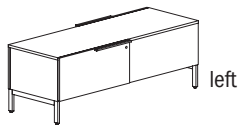
Description	D	W	H	CTN WT	CU FT	① Model	Laminate	Flat Cut Veneer	Double Cut Veneer
<b>Dual Sided Lateral File Credenza - Flush Legs</b>  right  left	22 3/4	72	21	210	28	FLT2272-21L6L6R	\$2,351		
	22 3/4	72	21	210	28	FLV2272-21L6L6R		\$3,132	\$3,446
	22 3/4	72	21	210	28	FLT2272-21L6L6L	\$2,351		
	22 3/4	72	21	210	28	FLV2272-21L6L6L		\$3,132	\$3,446
	22 3/4	60	21	224	23	FLT2260-21L6L6R	\$2,276		
	22 3/4	60	21	224	23	FLV2260-21L6L6R		\$2,952	\$3,247
	22 3/4	60	21	224	23	FLT2260-21L6L6L	\$2,276		
	22 3/4	60	21	224	23	FLV2260-21L6L6L		\$2,952	\$3,247

**Features:**

- pedestal front locking

**Options:**

- must specify chassis grain direction on double cut veneer, see pages 42-43 for details
- veneer door and drawer fronts available in contrasting paint color, specify paint color and add \$275 list; see page 44 for details
- laminated door and drawer fronts available in contrasting color, no upcharge, specify color; see page 44 for details
- ledge pulls standard; prism pulls available, specify and see page 39
- oval or rectangular seat cushion available; see page 582

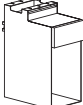
Suspended Storage	D	W	H	CTN WT	CU FT	① Model	Laminate	Flat Cut Veneer	Double Cut Veneer
	12 7/8	8	18 1/2	25	2	FLT1208-19SUSP	\$983		
	12 7/8	8	18 1/2	25	2	FLV1208-19SUSP		\$1,336	\$1,388

**Features:**

- pedestal front locking
- mounts to underside of fixed-height bench surface

**Options:**

- must specify chassis grain direction on double cut veneer, see pages 42-43 for details
- veneer door and drawer fronts available in contrasting paint color, specify paint color and add \$275 list; see page 44 for details
- laminated door and drawer fronts available in contrasting color, no upcharge, specify color; see page 44 for details

**To Order, Specify:**

① Laminate Model #	② Laminate Type	③ Laminate Selection			④ Metal Color	⑤ Other Product Options
Laminate (FLT)	HPL	Solid Patterns: ALB Alabaster BBL Bridal Blanco DWH Designer White SHD Shadow SLG Slate Grey	Wood Grain Patterns: AGA Aged Ash ALL Ale Light BLO Blonde Echo BOL Bourbon Light BZW Brazilwood BGL Brighton Light	CLL Collectors FLO Florence Walnut GRH Graphite HGL High Line OAT Oatmeal Cookie PIN Pinnacle Walnut	Color: ASL Arctic Silver MBK Matte Black PEW Pewter SNK Soft Nickel	See list of options for each specific unit; Specify and add accordingly.

① Veneer Model #	② Wood Species	③ Wood Finish - Finishes with an asterisk (*) have a coordinating laminate available			④ Metal Color	⑤ Other Product Options	
Veneer (FLV)	Flat Cut CH1 Cherry MA1 Maple WA1 Walnut	Cherry: BRL Barley BBM Bourbon Medium BRM Brighton Medium CLA Classic CLL Collectors*	EAR Earthy HRV Harvest* LGC Legacy PRL Praline* SAF Saffron	Maple: ALM Ale Medium BUT Butterscotch CIN Cinnamon FLX Flax VEN Venetian	Walnut: AUB Auburn ESP Espresso MCH Mocha* NTO Night Owl* SIE Sienna*	Color: ASL Arctic Silver MBK Matte Black PEW Pewter SNK Soft Nickel	See list of options for each specific unit; Specify and add accordingly.
	Double Cut DC1 Double Cut	ⓐ Wood Finish Double Cut: COF Coffee FOS Fossil KHK Khaki CRM Cremello GRH Graphite STU Studio Teak		ⓑ Chassis Grain Direction For Double Cut Only: Vertical Horizontal			

Description	D	W	H	CTN WT	CU FT	① Model	List Price
Privacy Hood - Edge Mount	11 <sup>7</sup> / <sub>16</sub>	30	28 <sup>5</sup> / <sub>16</sub>	30	10	FLB3012-29CAN	\$936



**Features:**

- mounts to edge of worksurface
- 28 1/4" h above worksurface

**Options:**

- select color, ash grey or silver grey

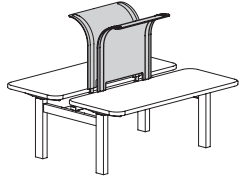

Privacy Hood with Light - Edge Mount	11 <sup>7</sup> / <sub>16</sub>	30	28 <sup>5</sup> / <sub>16</sub>	30	10	FLB3012-29CANLT	\$1,092
--------------------------------------	---------------------------------	----	---------------------------------	----	----	-----------------	---------

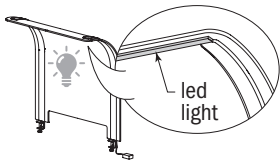

**Features:**

- mounts to edge of worksurface
- 28 1/4" h above worksurface
- LED tasklight included

**Options:**

- select color, ash grey or silver grey

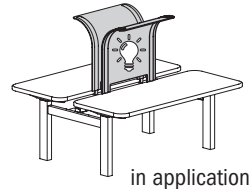

in application

# Index

Portable Slide on Screen	1	24	21 ½	10	2	GPB2422PDP	\$685
--------------------------	---	----	------	----	---	------------	-------

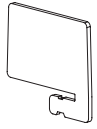

**Features:**

- works with any surface material
- works in any location, with the exception of where tilt release paddle is located on tilting tables

**Options:**

- Specify Ash Grey (ASH) or Silver Grey (SIL)

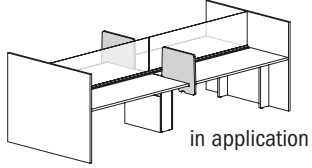

Description	D	W	H	CTN WT	CU FT	① Model	List Price
Accessory Slat Wall	2	22 1/8	14 3/8	25	2	FLB0223-15ASW	\$270

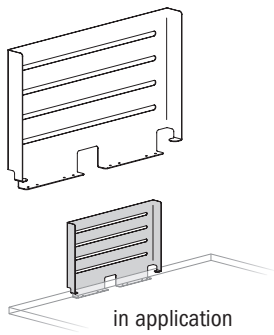

- Features:**
- mounts to underside of worksurface, see page 486 for details
  - 13" h above worksurface

Vessel	3 1/2	3 1/2	4	10	1	FLB0404-04VES	\$193
--------	-------	-------	---	----	---	---------------	-------



- Features:**
- hangs on Accessory Slat Wall

Paper Tray	8 3/4	11 3/8	1 1/2	10	1	FLB0912-02TRY	\$182
------------	-------	--------	-------	----	---	---------------	-------



- Features:**
- hangs on Accessory Slat Wall

Shelf	3 1/2	9	1 1/2	10	1	FLB0412-02SHF	\$148
-------	-------	---	-------	----	---	---------------	-------

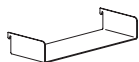

- Features:**
- hangs on Accessory Slat Wall

Dish	3 1/2	5 7/8	1 1/2	10	1	FLB0406-02DSH	\$166
------	-------	-------	-------	----	---	---------------	-------



- Features:**
- hangs on Accessory Slat Wall

Mobile Device Dock	2 3/8	2 1/2	1 3/8	10	1	FLB0303-02MDD	\$162
--------------------	-------	-------	-------	----	---	---------------	-------



- Features:**
- hangs on Accessory Slat Wall

File Hanger	3 1/2	12 3/8	1 1/2	10	1	FLB0413-02FIL	\$175
-------------	-------	--------	-------	----	---	---------------	-------



- Features:**
- hangs on Accessory Slat Wall

**To Order, Specify:**

① Model Number	
----------------	--

FLUX - OPEN PLAN

## Index

Mobile Pedestal - Top Storage	12 ¾	15 ½	22	65	7	FLT1816-21FMPT	\$1,107		
	12 ¾	15 ½	22	65	7	FLV1816-21FMPT		\$1,514	\$1,665



**Features:**

- pedestal front locking

**Options:**

- must specify chassis grain direction on double cut veneer, see pages 42-43 for details
- veneer drawer front available in contrasting paint color, specify paint color and add \$275 list
- laminate drawer fronts available in contrasting color, no upcharge, specify color; see page 44 for details

Description	D	W	H	CTN WT	CU FT	① Model	List Price
-------------	---	---	---	-----------	----------	---------	------------

 <p><b>Monitor Arm - Edge Mount</b></p> <p><b>Features:</b></p> <ul style="list-style-type: none"> <li>· mounts to edge of worksurface</li> </ul> <p><b>Options:</b></p> <ul style="list-style-type: none"> <li>· silver or black</li> </ul>				9	1	GP5901MA	\$567
--	--	--	--	---	---	----------	-------

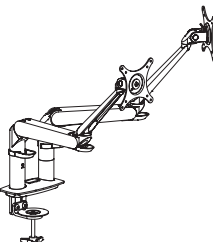
 <p><b>Dual Monitor Arm - Edge Mount</b></p> <p><b>Features:</b></p> <ul style="list-style-type: none"> <li>· mounts to edge of worksurface</li> <li>· supports two monitors</li> </ul> <p><b>Options:</b></p> <ul style="list-style-type: none"> <li>· silver or black</li> </ul>				18	2	GP5902MA	\$1,021
--	--	--	--	----	---	----------	---------

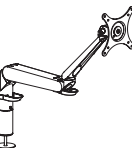
 <p><b>Monitor Arm</b></p> <p><b>Features:</b></p> <ul style="list-style-type: none"> <li>· mounts through hole in worksurface</li> <li>· field drilled and field installed</li> <li>· supports up to 12 lbs and/or 27" monitor</li> </ul> <p><b>Options:</b></p> <ul style="list-style-type: none"> <li>· silver or black</li> </ul>				9	1	GP5905MA	\$632
--	--	--	--	---	---	----------	-------

 <p><b>Wire Manager - Magnetic</b></p> <p><b>Features:</b></p> <ul style="list-style-type: none"> <li>· metal wire manager</li> <li>· magnetic attachment to metal End/Mid Support Frame</li> </ul>	1	2	23	3	1	FLB0223VWM	\$231
	1	2	19	3	1	FLB0219VWM	\$231

## Index

### Power Receptacles

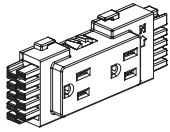

1	6	2	1	1	FLDUP8-1	\$45
1	6	2	1	1	FLDUP8-2	\$45
1	6	2	1	1	FLDUP8-3	\$45
1	6	2	1	1	FLDUP8-4	\$45

#### Features:

- duplex receptacles
- mounts to Power Harness - 4 per harness (2 per side)
- 15 amp
- UL listed
- FLDUP8-1 = Circuit 1
- FLDUP8-2 = Circuit 2
- FLDUP8-3 = Circuit 3
- FLDUP8-4 = Circuit 4

### Power Infeed





1 ½	144	2	4	1	FLB-POW8-IN144	\$403
1 ½	120	2	4	1	FLB-POW8-IN120	\$348
1 ½	96	2	3	1	FLB-POW8-IN96	\$303
1 ½	72	2	3	1	FLB-POW8-IN72	\$243
1 ½	60	2	3	1	FLB-POW8-IN60	\$222
1 ½	48	2	2	1	FLB-POW8-IN48	\$194

#### Features:

- 8-wire / 4-circuit
- ¾" x 1 ½" Oval Extra-Flex conduit
- Minimum bend radius 2"
- Pig tail end hardwires to building power
- End fittings are keyed to insure proper connection to other system components
- UL Listed system



Description	D	W	H	CTN WT	CU FT	① Model	List Price
Power Jumper	1 1/2	36	2	2	1	FLB-POW8-JMP36	\$158
	1 1/2	24	2	2	1	FLB-POW8-JMP24	\$134
	1 1/2	21	2	2	1	FLB-POW8-JMP21	\$114
	1 1/2	12	2	2	1	FLB-POW8-JMP12	\$101

**Features:**

- 8-wire / 4-circuit
- Non-directional
- 3/4" x 1 1/8" Oval Extra-Flex conduit
- Minimum bend radius 2"
- End fittings are keyed to insure proper connection to other system components
- UL Listed system

Worksurface Power	2 3/8	6 3/8	3	3	1	EC26	\$574
-------------------	-------	-------	---	---	---	------	-------

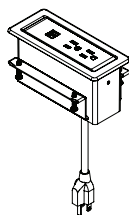

**Features:**

- two power receptacles - 120 volt; 15 amp dual powered USB
- 120" power cord with molded plug
- UL recognized

**Options:**

- White (W) or Black (B) finish available, specify when ordering

Edge Mount Power	3 1/2	5 1/2	7 1/2	3	1	EC28	\$546
------------------	-------	-------	-------	---	---	------	-------

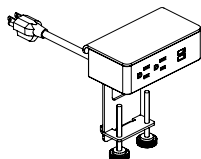

**Features:**

- two power receptacles - 120 volt; 15 amp dual powered USB
- 120" power cord with molded plug
- UL recognized

**Options:**

- White (W) or Black (B) finish available, specify when ordering

Wireless Charging Unit	3 1/2	3 1/2	1	3	1	EC33	\$349
------------------------	-------	-------	---	---	---	------	-------

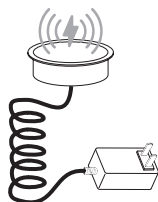

**Features:**

- wireless charging for use with Qi enabled devices
- 72" power cord
- black
- UL Listed
- CE / FCC certified

Under Surface Convenience Power Unit	3 1/8	7 1/8	2 1/8	3	1	EC34	\$386
--------------------------------------	-------	-------	-------	---	---	------	-------

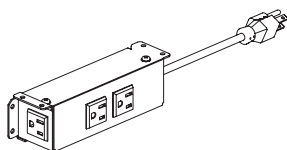

**Features:**

- three outlets
- 120" power cord
- black
- ETL Listed for US

**To Order, Specify:**

① Model Number	
----------------	--

FLUX - OPEN PLAN

Description	D	W	H	CTN WT	CU FT	① Model	List Price
42" h Locker - Open Shelves	22	12	42	77	11	FLT2212-42FLK-E	\$892
	18	12	42	65	9	FLT1812-42FLK-E	\$843

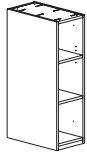

**Features:**

- must be connected to another locker with a common top, this unit is not freestanding; see pages 565-567 for modular tops
- one adjustable shelf and one fixed shelf (lower)
- unfinished back; modular common top & finished back panels available

42" h Locker - Storage Cabinet	D	W	H	CTN WT	CU FT	Model	List Price
	22	12	42	98	11	FLT2212-42FLK-EDR	\$1,058
	22	12	42	98	11	FLT2212-42FLK-EDL	\$1,058
	18	12	42	86	9	FLT1812-42FLK-EDR	\$1,001
	18	12	42	86	9	FLT1812-42FLK-EDL	\$1,001

**Features:**

- must be connected to another locker with a common top, this unit is not freestanding; see pages 565-567 for modular tops
- one adjustable shelf and one fixed shelf (lower)
- unfinished back; modular common top & finished back panels available

**Options:**

- laminate door fronts available in contrasting color, no upcharge, specify color
- specify pull; see page 484
- locking options available; see page 484 for details and upcharge
- number plate available, order separately; see page 568

42" h Locker - Storage Cabinet with Wardrobe Hooks	D	W	H	CTN WT	CU FT	Model	List Price
	22	12	42	96	11	FLT2212-42FLK-BDR	\$1,102
	22	12	42	96	11	FLT2212-42FLK-BDL	\$1,102
	18	12	42	85	9	FLT1812-42FLK-BDR	\$1,047
	18	12	42	85	9	FLT1812-42FLK-BDL	\$1,047

**Features:**

- must be connected to another locker with a common top, this unit is not freestanding; see pages 565-567 for modular tops
- one full depth fixed shelf, one shallow adjustable shelf and two coat hooks
- unfinished back; modular common top & finished back panels available

**Options:**

- laminate door fronts available in contrasting color, no upcharge, specify color
- specify pull; see page 484
- locking options available; see page 484 for details and upcharge
- number plate available, order separately; see page 568

**To Order, Specify:**

① Laminate Model #	② Laminate Selection	③ Metal Color	④ Other Product Options
Laminate (FLT)	<p>Solid Patterns:</p> <p>ALB Alabaster BBL Bridal Blanco DWH Designer White SHD Shadow SLG Slate Grey</p> <p>Wood Grain Patterns:</p> <p>AGA Aged Ash ALL Ale Light BLO Blonde Echo BOL Bourbon Light BZW Brazilwood BGL Brighton Light</p> <p>CLL Collectors FLO Florence Walnut GRH Graphite HGL High Line OAT Oatmeal Cookie PIN Pinnacle Walnut</p> <p>STU Studio Teak VIN Vintage WLH Walnut Heights WEA Weathered Ash</p>	<p>Color:</p> <p>ASL Arctic Silver MBK Matte Black PEW Pewter SNK Soft Nickel</p>	See list of options for each specific unit; Specify and add accordingly.

① Veneer Model #	② Wood Species	③ Wood Finish - Finishes with an asterisk (*) have a coordinating laminate available	④ Metal Color	⑤ Other Product Options
Veneer (FLV)	<p>Flat Cut</p> <p>CH1 Cherry MA1 Maple WA1 Walnut</p>	<p>Cherry:</p> <p>BRL Barley BBM Bourbon Medium BRM Brighton Medium CLA Classic CLL Collectors*</p> <p>EAR Earthy HRV Harvest* LGC Legacy PRL Praline* SAF Saffron</p> <p>Maple:</p> <p>ALM Ale Medium BUT Butterscotch CIN Cinnamon FLX Flax VEN Venetian</p> <p>Walnut:</p> <p>AUB Auburn ESP Espresso MCH Mocha* NTO Night Owl* SIE Sienna*</p> <p>TOF Toffee TRF Truffle*</p>	<p>Color:</p> <p>ASL Arctic Silver MBK Matte Black PEW Pewter SNK Soft Nickel</p>	See list of options for each specific unit; Specify and add accordingly.
	<p>Double Cut</p> <p>DC1 Double Cut</p>	<p>ⓐ Wood Finish</p> <p>Double Cut: COF Coffee CRM Cremello</p> <p>FOS Fossil GRH Graphite</p> <p>KHK Khaki STU Studio Teak</p>	<p>ⓑ Chassis Grain Direction</p> <p>For Double Cut Only: Vertical Horizontal</p>	

FLUX - OPEN PLAN

Description	D	W	H	CTN WT	CU FT	Model	List Price
42" h Locker - Wardrobe	22	12	42	89	11	FLT2212-42FLK-CDR	\$1,053
	22	12	42	89	11	FLT2212-42FLK-CDL	\$1,053
	18	12	42	79	9	FLT1812-42FLK-CDR	\$999
	18	12	42	79	9	FLT1812-42FLK-CDL	\$999

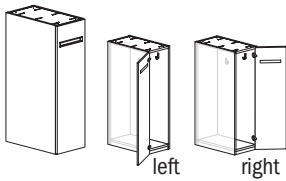

**Features:**

- must be connected to another locker with a common top, this unit is not freestanding; see pages 565-567 for modular tops
- one wardrobe bar in 22"d units; two coat hooks in 18"d units
- unfinished back; modular common top & finished back panels available

**Options:**

- laminate door fronts available in contrasting color, no upcharge, specify color
- specify pull; see page 484
- locking options available; see page 484 for details and upcharge
- number plate available, order separately; see page 568

48" h Locker - Open Shelves	22	12	48	84	13	FLT2212-48FLK-E	\$934
	18	12	48	65	11	FLT1812-48FLK-E	\$884

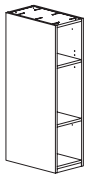

**Features:**

- must be connected to another locker with a common top, this unit is not freestanding; see pages 565-567 for modular tops
- one adjustable shelf and one fixed shelf (lower)
- unfinished back; modular common top & finished back panels available

48" h Locker - Storage Cabinet	22	12	48	107	13	FLT2212-48FLK-EDR	\$1,107
	22	12	48	107	13	FLT2212-48FLK-EDL	\$1,107
	18	12	48	86	11	FLT1812-48FLK-EDR	\$1,049
	18	12	48	86	11	FLT1812-48FLK-EDL	\$1,049

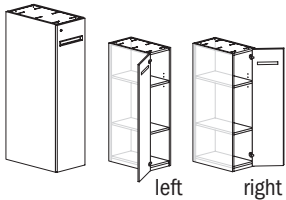

**Features:**

- must be connected to another locker with a common top, this unit is not freestanding; see pages 565-567 for modular tops
- one adjustable shelf and one fixed shelf (lower)
- unfinished back; modular common top & finished back panels available

**Options:**

- laminate door fronts available in contrasting color, no upcharge, specify color
- specify pull; see page 484
- locking options available; see page 484 for details and upcharge
- number plate available, order separately; see page 568

48" h Locker - Storage Cabinet with Wardrobe Hooks	22	12	48	106	13	FLT2212-48FLK-BDR	\$1,150
	22	12	48	106	13	FLT2212-48FLK-BDL	\$1,150
	18	12	48	94	11	FLT1812-48FLK-BDR	\$1,093
	18	12	48	94	11	FLT1812-48FLK-BDL	\$1,093

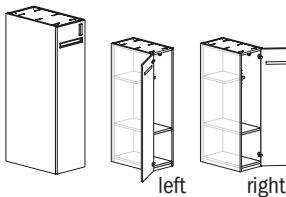

**Features:**

- must be connected to another locker with a common top, this unit is not freestanding; see pages 565-567 for modular tops
- one full depth fixed shelf, one shallow adjustable shelf and two coat hooks
- unfinished back; modular common top & finished back panels available

**Options:**

- laminate door fronts available in contrasting color, no upcharge, specify color
- specify pull; see page 484
- locking options available; see page 484 for details and upcharge
- number plate available, order separately; see page 568

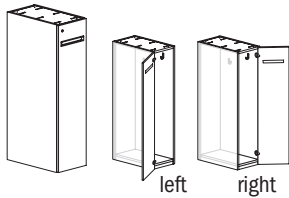
Description	D	W	H	CTN WT	CU FT	① Model	List Price
 left right	22	12	48	99	13	FLT2212-48FLK-CDR	\$1,103
	22	12	48	99	13	FLT2212-48FLK-CDL	\$1,103
	18	12	48	88	11	FLT1812-48FLK-CDR	\$1,047
	18	12	48	88	11	FLT1812-48FLK-CDL	\$1,047

**Features:**

- must be connected to another locker with a common top, this unit is not freestanding; see pages 565-567 for modular tops
- one wardrobe bar in 22"d units; two coat hooks in 18"d units
- unfinished back; modular common top & finished back panels available

**Options:**

- laminate door fronts available in contrasting color, no upcharge, specify color
- specify pull; see page 484
- locking options available; see page 484 for details and upcharge
- number plate available, order separately; see page 568

	22	12	69	116	13	FLT2212-69FLK-F	\$1,046
	18	12	69	98	11	FLT1812-69FLK-F	\$989

**Features:**

- must be connected to another locker with a common top, this unit is not freestanding; see pages 565-567 for modular tops
- two adjustable shelves and one fixed shelf (center)
- unfinished back; modular common top & finished back panels available

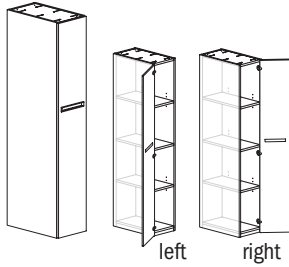
 left right	22	12	69	150	18	FLT2212-69FLK-FDR	\$1,240
	22	12	69	150	18	FLT2212-69FLK-FDL	\$1,240
	18	12	69	133	15	FLT1812-69FLK-FDR	\$1,175
	18	12	69	133	15	FLT1812-69FLK-FDL	\$1,175

**Features:**

- must be connected to another locker with a common top, this unit is not freestanding; see pages 565-567 for modular tops
- two adjustable shelves and one fixed shelf (center)
- unfinished back; modular common top & finished back panels available

**Options:**

- laminate door fronts available in contrasting color, no upcharge, specify color
- specify pull; see page 484
- locking options available; see page 484 for details and upcharge
- number plate available, order separately; see page 568

**To Order, Specify:**

① Laminate Model #	② Laminate Selection	③ Metal Color	④ Other Product Options
Laminate (FLT)	Solid Patterns: ALB Alabaster BBL Bridal Blanco DWH Designer White SHD Shadow SLG Slate Grey Wood Grain Patterns: AGA Aged Ash ALL Ale Light BLO Blonde Echo BOL Bourbon Light BZW Brazilwood BGL Brighton Light CLL Collectors FLO Florence Walnut GRH Graphite HGL High Line OAT Oatmeal Cookie PIN Pinnacle Walnut STU Studio Teak VIN Vintage WLH Walnut Heights WEA Weathered Ash	Color: ASL Arctic Silver MBK Matte Black PEW Pewter SNK Soft Nickel	See list of options for each specific unit; Specify and add accordingly.

① Veneer Model #	② Wood Species	③ Wood Finish - Finishes with an asterisk (*) have a coordinating laminate available	④ Metal Color	⑤ Other Product Options
Veneer (FLV)	Flat Cut CH1 Cherry MA1 Maple WA1 Walnut	Cherry: BRL Barley BBM Bourbon Medium BRM Brighton Medium CLA Classic CLL Collectors* EAR Earthy HRV Harvest* LGC Legacy PRL Praline* SAF Saffron Maple: ALM Ale Medium BUT Butterscotch CIN Cinnamon FLX Flax VEN Venetian Walnut: AUB Auburn ESP Espresso MCH Mocha* NTO Night Owl* SIE Sienna* TOF Toffee TRF Truffle*	Color: ASL Arctic Silver MBK Matte Black PEW Pewter SNK Soft Nickel	See list of options for each specific unit; Specify and add accordingly.
	Double Cut DC1 Double Cut	ⓐ Wood Finish Double Cut: COF Coffee CRM Cremello FOS Fossil GRH Graphite KHK Khaki STU Studio Teak ⓑ Chassis Grain Direction For Double Cut Only: Vertical Horizontal		

FLUX - OPEN PLAN

Description	D	W	H	CTN WT	CU FT	Model	List Price
69" h Locker - Storage Cabinet with Wardrobe Hooks	22	12	69	146	18	FLT2212-69FLK-GDR	\$1,289
	22	12	69	146	18	FLT2212-69FLK-GDL	\$1,289
	18	12	69	130	15	FLT1812-69FLK-GDR	\$1,225
	18	12	69	130	15	FLT1812-69FLK-GDL	\$1,225

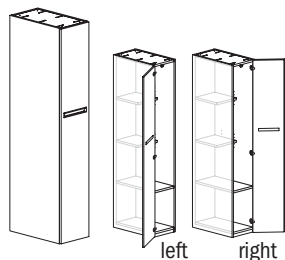

**Features:**

- must be connected to another locker with a common top, this unit is not freestanding; see pages 565-567 for modular tops
- one full depth fixed shelf, two shallow adjustable shelves and two coat hooks
- unfinished back; modular common top & finished back panels available

**Options:**

- laminate door fronts available in contrasting color, no upcharge, specify color
- specify pull; see page 484
- locking options available; see page 484 for details and upcharge
- number plate available, order separately; see page 568

69" h Locker - Wardrobe	22	12	69	141	18	FLT2212-69FLK-HDR	\$1,257
	22	12	69	141	18	FLT2212-69FLK-HDL	\$1,257
	18	12	69	125	15	FLT1812-69FLK-HDR	\$1,193
	18	12	69	125	15	FLT1812-69FLK-HDL	\$1,193

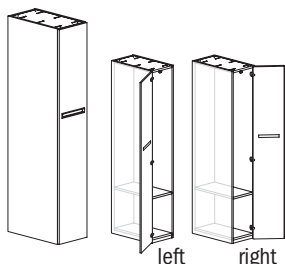

**Features:**

- must be connected to another locker with a common top, this unit is not freestanding; see pages 565-567 for modular tops
- one full depth fixed shelf and one wardrobe bar in 22"d units; two coat hooks in 18"d units
- unfinished back; modular common top & finished back panels available

**Options:**

- laminate door fronts available in contrasting color, no upcharge, specify color
- specify pull; see page 484
- locking options available; see page 484 for details and upcharge
- number plate available, order separately; see page 568

69" h Dual Locker - Storage Cabinet	22	12	69	151	18	FLT2212-69FLK-F2DR	\$1,274
	22	12	69	151	18	FLT2212-69FLK-F2DL	\$1,274
	18	12	69	133	15	FLT1812-69FLK-F2DR	\$1,208
	18	12	69	133	15	FLT1812-69FLK-F2DL	\$1,208

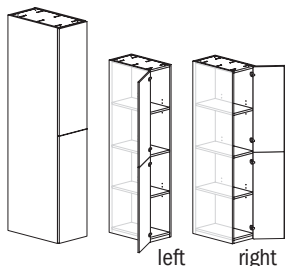

**Features:**

- must be connected to another locker with a common top, this unit is not freestanding; see pages 565-567 for modular tops
- one adjustable shelf per compartment
- unfinished back; modular common top & finished back panels available

**Options:**

- laminate door fronts available in contrasting color, no upcharge, specify color
- specify pull; see page 484
- locking options available; see page 484 for details and upcharge
- number plate available, order separately; see page 568

69" h Triple Locker - Storage Cabinet	22	12	69	160	18	FLT2212-69FLK-J3DR	\$1,306
	22	12	69	160	18	FLT2212-69FLK-J3DL	\$1,306
	18	12	69	140	15	FLT1812-69FLK-J3DR	\$1,241
	18	12	69	140	15	FLT1812-69FLK-J3DL	\$1,241

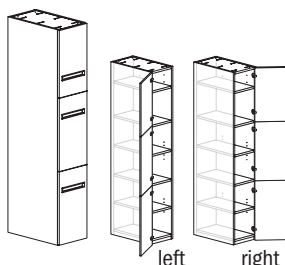

**Features:**

- must be connected to another locker with a common top, this unit is not freestanding; see pages 565-567 for modular tops
- one adjustable shelf per compartment
- unfinished back; modular common top & finished back panels available

**Options:**

- laminate door fronts available in contrasting color, no upcharge, specify color
- specify pull; see page 484
- locking options available; see page 484 for details and upcharge
- number plate available, order separately; see page 568

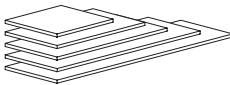
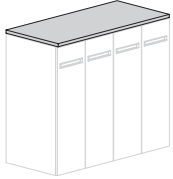
Description	D	W	H	CTN WT	CU FT	① Model	List Price
Modular Top - Single Depth Locker     in application	22	96 1/8	1 3/16	78	5	FLT2296LKMT	\$636
	22	84 1/8	1 3/16	69	5	FLT2284LKMT	\$557
	22	72 1/8	1 3/16	60	4	FLT2272LKMT	\$477
	22	60 1/8	1 3/16	50	4	FLT2260LKMT	\$398
	22	48 1/8	1 3/16	42	3	FLT2248LKMT	\$319
	22	36 1/8	1 3/16	33	2	FLT2236LKMT	\$239
	22	24 1/8	1 3/16	24	2	FLT2224LKMT	\$187
	18	96 1/8	1 3/16	65	5	FLT1896LKMT	\$623
	18	84 1/8	1 3/16	56	4	FLT1884LKMT	\$545
	18	72 1/8	1 3/16	50	4	FLT1872LKMT	\$467
	18	61 1/8	1 3/16	44	3	FLT1860LKMT	\$389
	18	48 1/8	1 3/16	35	3	FLT1848LKMT	\$312
	18	36 1/8	1 3/16	28	2	FLT1836LKMT	\$234
	18	24 1/8	1 3/16	20	2	FLT1824LKMT	\$182

**Features:**

- use with modular Locker Storage Cabinets
- eased edge profile user side

**To Order, Specify:**

① Laminate Model #	② Laminate Selection	③ Metal Color	④ Other Product Options
Laminate (FLT)	<p>Solid Patterns:</p> <p>ALB Alabaster BBL Bridal Blanco DWH Designer White SHD Shadow SLG Slate Grey</p> <p>Wood Grain Patterns:</p> <p>AGA Aged Ash    CLL Collectors    STU Studio Teak ALL Ale Light    FLO Florence Walnut    VIN Vintage BLO Blonde Echo    GRH Graphite    WLH Walnut Heights BOL Bourbon Light    HGL High Line    WEA Weathered Ash BZW Brazilwood    OAT Oatmeal Cookie BGL Brighton Light    PIN Pinnacle Walnut</p>	<p>Color:</p> <p>ASL Arctic Silver MBK Matte Black PEW Pewter SNK Soft Nickel</p>	See list of options for each specific unit; Specify and add accordingly.

① Veneer Model #	② Wood Species	③ Wood Finish - Finishes with an asterisk (*) have a coordinating laminate available	④ Metal Color	⑤ Other Product Options
Veneer (FLV)	<p>Flat Cut</p> <p>CH1 Cherry MA1 Maple WA1 Walnut</p>	<p>Cherry:</p> <p>BRL Barley    EAR Earthy BBM Bourbon Medium    HRV Harvest* BRM Brighton Medium    LGC Legacy CLA Classic    PRL Praline* CLL Collectors*    SAF Saffron</p> <p>Maple:</p> <p>ALM Ale Medium    BUT Butterscotch CIN Cinnamon    FLX Flax VEN Venetian</p> <p>Walnut:</p> <p>AUB Auburn    TOF Toffee ESP Espresso    TRF Truffle* MCH Mocha* NTO Night Owl* SIE Sienna*</p>	<p>Color:</p> <p>ASL Arctic Silver MBK Matte Black PEW Pewter SNK Soft Nickel</p>	See list of options for each specific unit; Specify and add accordingly.
	<p>Double Cut</p> <p>DC1 Double Cut</p>	<p>ⓐ Wood Finish</p> <p>Double Cut: COF Coffee    FOS Fossil    KHK Khaki CRM Cremello    GRH Graphite    STU Studio Teak</p>	<p>ⓑ Chassis Grain Direction</p> <p>For Double Cut Only: Vertical Horizontal</p>	

FLUX - OPEN PLAN

Description	D	W	H	CTN WT	CU FT	① Model	List Price
42" h Modular Top & Common Back - Single Depth Locker	22 3/4	60 1/8	42	105	44	FLT2360-42LKMTB	\$949
	22 3/4	48 1/8	42	85	36	FLT2348-42LKMTB	\$760
	22 3/4	36 1/8	42	65	28	FLT2336-42LKMTB	\$571
	22 3/4	24 1/8	42	45	20	FLT2324-42LKMTB	\$446
	18 3/4	60 1/8	42	97	38	FLT1960-42LKMTB	\$942
	18 3/4	48 1/8	42	85	31	FLT1948-42LKMTB	\$754
	18 3/4	36 1/8	42	60	24	FLT1936-42LKMTB	\$566
	18 3/4	24 1/8	42	42	17	FLT1924-42LKMTB	\$443

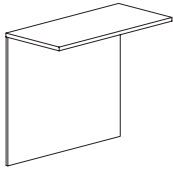

in application

**Features:**

- use with modular Locker Storage Cabinets to create a finished back
- eased edge profile user side

48" h Modular Top & Common Back - Single Depth Locker	22 3/4	60 1/8	48	113	50	FLT2360-48LKMTB	\$1,028
	22 3/4	48 1/8	48	91	41	FLT2348-48LKMTB	\$824
	22 3/4	36 1/8	48	69	32	FLT2336-48LKMTB	\$619
	22 3/4	24 1/8	48	49	23	FLT2324-48LKMTB	\$483
	18 3/4	60 1/8	48	104	43	FLT1960-48LKMTB	\$1,022
	18 3/4	48 1/8	48	85	35	FLT1948-48LKMTB	\$817
	18 3/4	36 1/8	48	65	27	FLT1936-48LKMTB	\$614
	18 3/4	24 1/8	48	45	19	FLT1924-48LKMTB	\$480

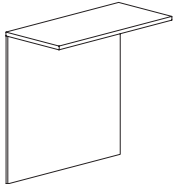

in application

**Features:**

- use with modular Locker Storage Cabinets to create a finished back
- eased edge profile user side

69" h Modular Top & Common Back - Single Depth Locker	22 3/4	60 1/8	69	140	71	FLT2360-69LKMTB	\$1,303
	22 3/4	48 1/8	69	113	58	FLT2348-69LKMTB	\$1,044
	22 3/4	36 1/8	69	80	45	FLT2336-69LKMTB	\$785
	22 3/4	24 1/8	69	59	31	FLT2324-69LKMTB	\$613
	18 3/4	60 1/8	69	132	60	FLT1960-69LKMTB	\$1,298
	18 3/4	48 1/8	69	107	49	FLT1948-69LKMTB	\$1,038
	18 3/4	36 1/8	69	80	38	FLT1936-69LKMTB	\$779
	18 3/4	24 1/8	69	56	27	FLT1924-69LKMTB	\$610

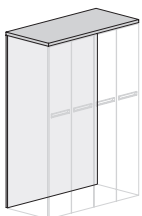
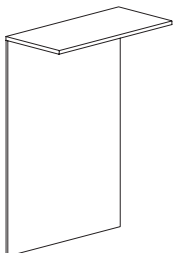

in application

**Features:**

- use with modular Locker Storage Cabinets to create a finished back
- eased edge profile user side

FLUX - OPEN PLAN

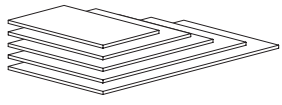
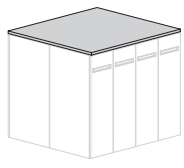
Description	D	W	H	CTN WT	CU FT	① Model	List Price
Modular Top - Back to Back Lockers     in application	44	96 1/8	1 3/16	150	9	FLT4496LKMT	\$1,261
	44	84 1/8	1 3/16	133	8	FLT4484LKMT	\$1,105
	44	72 1/8	1 3/16	114	7	FLT4472LKMT	\$949
	44	60 1/8	1 3/16	96	6	FLT4460LKMT	\$785
	44	48 1/8	1 3/16	78	5	FLT4448LKMT	\$558
	44	36 1/8	1 3/16	60	4	FLT4436LKMT	\$478
	44	24 1/8	1 3/16	42	3	FLT4424LKMT	\$286
	36	96 1/8	1 3/16	124	8	FLT3696LKMT	\$1,036
	36	84 1/8	1 3/16	109	7	FLT3684LKMT	\$909
	36	72 1/8	1 3/16	95	6	FLT3672LKMT	\$779
	36	61 1/8	1 3/16	80	5	FLT3660LKMT	\$650
	36	48 1/8	1 3/16	65	4	FLT3648LKMT	\$525
	36	36 1/8	1 3/16	35	3	FLT3636LKMT	\$404
	36	24 1/8	1 3/16	35	3	FLT3624LKMT	\$245

**Features:**

- use with modular Locker Storage Cabinets to span back-to-back units
- eased edge profile user side

**To Order, Specify:**

① Laminate Model #	② Laminate Selection	③ Metal Color	④ Other Product Options
Laminate (FLT)	<p>Solid Patterns:</p> <p>ALB Alabaster BBL Bridal Blanco DWH Designer White SHD Shadow SLG Slate Grey</p> <p>Wood Grain Patterns:</p> <p>AGA Aged Ash ALL Ale Light BLO Blonde Echo BOL Bourbon Light BZW Brazilwood BGL Brighton Light</p> <p>CLL Collectors FLO Florence Walnut GRH Graphite HGL High Line OAT Oatmeal Cookie PIN Pinnacle Walnut</p> <p>STU Studio Teak VIN Vintage WLH Walnut Heights WEA Weathered Ash</p>	<p>Color:</p> <p>ASL Arctic Silver MBK Matte Black PEW Pewter SNK Soft Nickel</p>	See list of options for each specific unit; Specify and add accordingly.

① Veneer Model #	② Wood Species	③ Wood Finish - Finishes with an asterisk (*) have a coordinating laminate available	④ Metal Color	⑤ Other Product Options
Veneer (FLV)	<p>Flat Cut</p> <p>CH1 Cherry MA1 Maple WA1 Walnut</p>	<p>Cherry:</p> <p>BRL Barley BBM Bourbon Medium BRM Brighton Medium CLA Classic CLL Collectors*</p> <p>EAR Earthy HRV Harvest* LGC Legacy PRL Praline* SAF Saffron</p> <p>Maple:</p> <p>ALM Ale Medium BUT Butterscotch CIN Cinnamon FLX Flax VEN Venetian</p> <p>Walnut:</p> <p>AUB Auburn ESP Espresso MCH Mocha* NTO Night Owl* SIE Sienna*</p> <p>TOF Toffee TRF Truffle*</p>	<p>Color:</p> <p>ASL Arctic Silver MBK Matte Black PEW Pewter SNK Soft Nickel</p>	See list of options for each specific unit; Specify and add accordingly.
	<p>Double Cut</p> <p>DC1 Double Cut</p>	<p>ⓐ Wood Finish</p> <p>COF Coffee CRM Cremello</p> <p>FOS Fossil GRH Graphite</p> <p>KHK Khaki STU Studio Teak</p>	<p>ⓑ Chassis Grain Direction</p> <p>For Double Cut Only: Vertical Horizontal</p>	

FLUX - OPEN PLAN



Description	D	W	H	CTN WT	CU FT	① Model	List Price
Locker Number Plate	1/8	1	1	1	1	FLB-NUMPLT	\$30

**Options:**

- select Silver with Black numerals OR Black with Silver Numerals

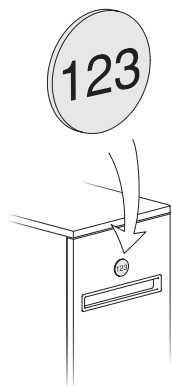

Lock & Key				1	1	FLB-LOCKCORE-A	\$24
------------	--	--	--	---	---	----------------	------

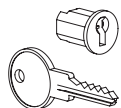

**Features:**

- key #'s start at 100

**Options:**

- select key #'s
- select Silver or Black

Digital lock master key				1	1	FLB-MASTKEY-B	\$80
-------------------------	--	--	--	---	---	---------------	------

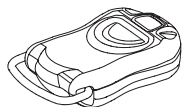

Keyless radial lock master key				1	1	FLB-MASTKEY-C	\$80
--------------------------------	--	--	--	---	---	---------------	------

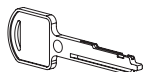

FLUX - OPEN PLAN

**To Order, Specify:**

① Model Number	
----------------	--

Description	D	W	H	CTN WT	CU FT	① Model	Laminate	Flat Cut Veneer	Double Cut Veneer
Box/Box/File Mobile Pedestal	18	15 1/2	25	91	6	FLT1816-25FMP	\$1,122		
	18	15 1/2	25	91	6	FLV1816-25FMP		\$1,504	\$1,654



**Features:**

- box, box file only; letter width pedestal
- pedestal front locking
- no additional top needed

**Options:**

- must specify chassis grain direction on double cut veneer, see pages 42-43 for details, see page 42-43 for details
- ledge pulls standard; prism pulls available, specify and see page 39, specify and see page 39

Box/File Mobile Pedestal	18	15 3/8	21	67	5	FLT1816-21FMP	\$1,009		
	18	15 3/8	21	67	5	FLV1816-21FMP		\$1,407	\$1,547



**Features:**

- dual wheel casters
- pedestal front locking

**Options:**

- must specify chassis grain direction on double cut veneer, see pages 42-43 for details, see pages 42-43 for details
- veneer drawer fronts in paint available, specify paint color and add \$275 list; see page 44 for details
- on laminate units, contrasting fronts available, no upcharge; specify color, see page 44 for details
- ledge pulls standard; prism pulls available, specify and see page 39, specify and see page 39
- round or square seat cushion available, see page 583

**To Order, Specify:**

① Laminate Model #	② Laminate Type	③ Laminate Selection				④ Metal Color	⑤ Other Product Options
Laminate (FLT)	HPL	<b>Solid Patterns:</b> ALB Alabaster BBL Bridal Blanco DWH Designer White SHD Shadow SLG Slate Grey	<b>Wood Grain Patterns:</b> AGA Aged Ash ALL Ale Light BLO Blonde Echo BOL Bourbon Light BZW Brazilwood BGL Brighton Light	CLL Collectors FLO Florence Walnut GRH Graphite HGL High Line OAT Oatmeal Cookie PIN Pinnacle Walnut	STU Studio Teak VIN Vintage WLH Walnut Heights WEA Weathered Ash	Color: ASL Arctic Silver MBK Matte Black PEW Pewter SNK Soft Nickel	See list of options for each specific unit; Specify and add accordingly.

① Veneer Model #	② Wood Species	③ Wood Finish - Finishes with an asterisk (*) have a coordinating laminate available				④ Metal Color	⑤ Other Product Options	
Veneer (FLV)	<b>Flat Cut</b> CH1 Cherry MA1 Maple WA1 Walnut	<b>Cherry:</b> BRL Barley BBM Bourbon Medium BRM Brighton Medium CLA Classic CLL Collectors*	<b>Earthy:</b> EAR Earthy HRV Harvest* LGC Legacy PRL Praline* SAF Saffron	<b>Maple:</b> ALM Ale Medium BUT Butterscotch CIN Cinnamon FLX Flax VEN Venetian	<b>Walnut:</b> AUB Auburn ESP Espresso MCH Mocha* NTO Night Owl* SIE Sienna*	TOF Toffee TRF Truffle*	Color: ASL Arctic Silver MBK Matte Black PEW Pewter SNK Soft Nickel	See list of options for each specific unit; Specify and add accordingly.
	<b>Double Cut</b> DC1 Double Cut	<b>ⓐ Wood Finish</b> Double Cut: COF Coffee FOS Fossil KHK Khaki CRM Cremello GRH Graphite STU Studio Teak		<b>ⓑ Chassis Grain Direction</b> For Double Cut Only: Vertical Horizontal				

FLUX - OPEN PLAN

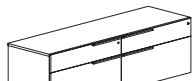
Description	D	W	H	CTN WT	CU FT	① Model	Laminate	Flat Cut Veneer	Double Cut Veneer
Box/Lateral File Credenza 	22	72	21	289	24	FLT2272-21F66	\$1,893		
	22	72	21	289	24	FLV2272-21F66		\$2,643	\$2,908
	22	60	21	251	20	FLT2260-21F66	\$1,818		
	22	60	21	251	20	FLV2260-21F66		\$2,539	\$2,792

**Features:**

- pedestal front locking

**Options:**

- must specify chassis grain direction on double cut veneer, see pages 42-43 for details, see pages 42-43 for details
- concealed box drawer(s) available, specify location in unit; add \$191 list for each laminate drawer or \$291 for each veneer drawer, see page 53 for details
- veneer drawer fronts in paint available, specify paint color and add \$275 list; see page 44 for details
- on laminate units, contrasting fronts available, no upcharge; specify color, see page 44 for details
- ledge pulls standard; prism pulls available, specify and see page 39, specify and see page 39
- oval grommets in back panel can be eliminated upon request, no upcharge
- oval or rectangular seat cushion available, see page 53 for more details and page 582 for pricing
- interior horizontal wire manager with end grommets available, specify and add \$148 list; see page 68 for details
- top grommet available, specify location and add \$105 list each; see page 74 for details

Description	D	W	H	CTN WT	CU FT	① Model	Laminate	Flat Cut Veneer	Double Cut Veneer
 Box/Lateral File Pedestal	22	36	21	146	13	FLT2236-21F6	\$1,100		
	22	36	21	146	13	FLV2236-21F6		\$1,536	\$1,690
	22	30	21	126	11	FLT2230-21F6	\$1,074		
	22	30	21	126	11	FLV2230-21F6		\$1,498	\$1,649

**Features:**

- pedestal front locking

**Options:**

- must specify chassis grain direction on double cut veneer, see pages 42-43 for details, see pages 42-43 for details
- concealed box drawer available, specify; add \$191 list for each laminate drawer or \$291 for each veneer drawer, see page 53 for details
- veneer drawer fronts in paint available, specify paint color and add \$275 list; see page 44 for details
- on laminate units, contrasting fronts available, no upcharge; specify color, see page 44 for details
- ledge pulls standard; prism pulls available, specify and see page 39, specify and see page 39
- oval grommet in back panel can be eliminated upon request, no upcharge
- oval or rectangular seat cushion available, see page 53 for more details and page 582 for pricing
- interior horizontal wire manager with end grommets available, specify and add \$148 list; see page 68 for details
- top grommet available, specify location and add \$105 list each; see page 74 for details

**To Order, Specify:**

① Laminate Model #	② Laminate Type	③ Laminate Selection	④ Metal Color	⑤ Other Product Options
Laminate (FLT)	HPL	Solid Patterns: ALB Alabaster BBL Bridal Blanco DWH Designer White SHD Shadow SLG Slate Grey  Wood Grain Patterns: AGA Aged Ash ALL Ale Light BLO Blonde Echo BOL Bourbon Light BZW Brazilwood BGL Brighton Light CLL Collectors FLO Florence Walnut GRH Graphite HGL High Line OAT Oatmeal Cookie PIN Pinnacle Walnut STU Studio Teak VIN Vintage WLH Walnut Heights WEA Weathered Ash	Color: ASL Arctic Silver MBK Matte Black PEW Pewter SNK Soft Nickel	See list of options for each specific unit; Specify and add accordingly.

① Veneer Model #	② Wood Species	③ Wood Finish - Finishes with an asterisk (*) have a coordinating laminate available	④ Metal Color	⑤ Other Product Options
Veneer (FLV)	Flat Cut CH1 Cherry MA1 Maple WA1 Walnut	Cherry: BRL Barley BBM Bourbon Medium BRM Brighton Medium CLA Classic CLL Collectors* EAR Earthy HRV Harvest* LGC Legacy PRL Praline* SAF Saffron ALM Ale Medium BUT Butterscotch CIN Cinnamon FLX Flax VEN Venetian AUB Auburn ESP Espresso MCH Mocha* NTO Night Owl* SIE Sienna* TOF Toffee TRF Truffle*	Color: ASL Arctic Silver MBK Matte Black PEW Pewter SNK Soft Nickel	See list of options for each specific unit; Specify and add accordingly.
	Double Cut DC1 Double Cut	<b>ⓐ Wood Finish</b> Double Cut: COF Coffee CRM Cremello FOS Fossil GRH Graphite KHK Khaki STU Studio Teak	<b>ⓑ Chassis Grain Direction</b> For Double Cut Only: Vertical Horizontal	

FLUX - OPEN PLAN

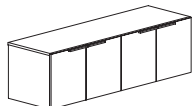

Description	D	W	H	CTN WT	CU FT	① Model	Laminate	Flat Cut Veneer	Double Cut Veneer
	22	78	21	254	26	FLT2278-21F77	\$1,560		
	22	78	21	254	26	FLV2278-21F77		\$2,293	\$2,521
	22	72	21	238	24	FLT2272-21F77	\$1,522		
	22	72	21	238	24	FLV2272-21F77		\$2,237	\$2,460
	22	66	21	220	22	FLT2266-21F77	\$1,461		
	22	66	21	220	22	FLV2266-21F77		\$2,147	\$2,362
	22	60	21	205	20	FLT2260-21F77	\$1,403		
	22	60	21	205	20	FLV2260-21F77		\$2,062	\$2,267

**Features:**

- each hinged door compartment has one adjustable shelf

**Options:**

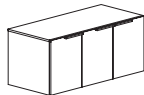
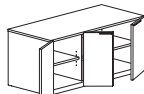
- must specify chassis grain direction on double cut veneer, see pages 42-43 for details, see pages 42-43 for details
- locking doors available, specify and add \$245 list
- veneer door fronts in paint available, specify paint color and add \$275 list; see page 44 for details
- on laminate units, contrasting laminate door fronts available, no upcharge; specify laminate color, see page 44 for details
- ledge pulls standard; prism pulls available, specify and see page 39, specify and see page 39
- oval grommets in back panel can be eliminated upon request, no upcharge
- oval or rectangular seat cushion available, see page 53 for more details and page 582 for pricing
- interior horizontal wire manager with end grommets available, specify and add \$148 list; see page 68 for details
- top grommet available, specify location and add \$105 list each; see page 74 for details
- worksurface power available, specify "to accommodate EC26" on your purchase order; EC26 unit must be ordered separately, see page 74

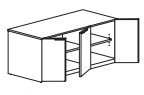
Description	D	W	H	CTN WT	CU FT	① Model	Laminate	Flat Cut Veneer	Double Cut Veneer
  left shown    right	22	54	21	188	18	FLT2254-21F77R	\$1,276		
	22	54	21	188	18	FLV2254-21F77R		\$1,877	\$2,065
	22	54	21	185	18	FLT2254-21F77L	\$1,276		
	22	54	21	185	18	FLV2254-21F77L		\$1,877	\$2,065
	22	48	21	169	16	FLT2248-21F77R	\$1,212		
	22	48	21	169	16	FLV2248-21F77R		\$1,783	\$1,962
	22	48	21	163	16	FLT2248-21F77L	\$1,212		
	22	48	21	163	16	FLV2248-21F77L		\$1,783	\$1,962
	22	42	21	153	15	FLT2242-21F77R	\$1,151		
	22	42	21	153	15	FLV2242-21F77R		\$1,694	\$1,863
	22	42	21	150	15	FLT2242-21F77L	\$1,151		
	22	42	21	150	15	FLV2242-21F77L		\$1,694	\$1,863

**Features:**

- each hinged door compartment has one adjustable shelf

**Options:**

- must specify chassis grain direction on double cut veneer, see pages 42-43 for details, see pages 42-43 for details
- locking doors available, specify and add \$367 list
- veneer door fronts in paint available, specify paint color and add \$275 list; see page 44 for details
- on laminate units, contrasting laminate door fronts available, no upcharge; specify laminate color, see page 44 for details
- ledge pulls standard; prism pulls available, specify and see page 39, specify and see page 39
- oval grommet in back panel can be eliminated upon request, no upcharge
- oval or rectangular seat cushion available, see page 53 for more details and page 582 for pricing
- interior horizontal wire manager with end grommets available, specify and add \$148 list; see page 68 for details
- top grommet available, specify location and add \$105 list each; see page 74 for details
- worksurface power available, specify "to accommodate EC26" on your purchase order; EC26 unit must be ordered separately, see page 74

FLUX - OPEN PLAN

Description	D	W	H	CTN WT	CU FT	① Model	Laminate	Flat Cut Veneer	Double Cut Veneer
Two Door Storage	22	36	21	127	13	FLT2236-21F7	\$819		
	22	36	21	127	13	FLV2236-21F7		\$1,203	\$1,325
	22	30	21	109	11	FLT2230-21F7	\$786		
	22	30	21	109	11	FLV2230-21F7		\$1,154	\$1,271

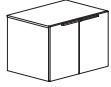

**Features:**

- compartment has one adjustable shelf

**Options:**

- must specify chassis grain direction on double cut veneer, see pages 42-43 for details, see pages 42-43 for details
- locking doors available, specify and add \$123 list
- veneer door fronts in paint available, specify paint color and add \$275 list; see page 44 for details
- on laminate units, contrasting laminate door fronts available, no upcharge; specify laminate color, see page 44 for details
- ledge pulls standard; prism pulls available, specify and see page 39, specify and see page 39
- oval grommets in back panel can be eliminated upon request, no upcharge
- oval or rectangular seat cushion available, see page 53 for more details and page 582 for pricing
- interior horizontal wire manager with end grommets available, specify and add \$148 list; see page 68 for details
- top grommet available, specify location and add \$105 list each; see page 74 for details
- worksurface power available, specify "to accommodate EC26" on your purchase order; EC26 unit must be ordered separately, see page 74

**To Order, Specify:**

① Laminate Model #	② Laminate Type	③ Laminate Selection	④ Metal Color	⑤ Other Product Options
Laminate (FLT)	HPL	Solid Patterns: ALB Alabaster BBL Bridal Blanco DWH Designer White SHD Shadow SLG Slate Grey  Wood Grain Patterns: AGA Aged Ash ALL Ale Light BLO Blonde Echo BOL Bourbon Light BZW Brazilwood BGL Brighton Light CLL Collectors FLO Florence Walnut GRH Graphite HGL High Line OAT Oatmeal Cookie PIN Pinnacle Walnut STU Studio Teak VIN Vintage WLH Walnut Heights WEA Weathered Ash	Color: ASL Arctic Silver MBK Matte Black PEW Pewter SNK Soft Nickel	See list of options for each specific unit; Specify and add accordingly.

① Veneer Model #	② Wood Species	③ Wood Finish - Finishes with an asterisk (*) have a coordinating laminate available	④ Metal Color	⑤ Other Product Options
Veneer (FLV)	Flat Cut CH1 Cherry MA1 Maple WA1 Walnut	Cherry: BRL Barley BBM Bourbon Medium BRM Brighton Medium CLA Classic CLL Collectors* EAR Earthy HRV Harvest* LGC Legacy PRL Praline* SAF Saffron ALM Ale Medium BUT Butterscotch CIN Cinnamon FLX Flax VEN Venetian AUB Auburn ESP Espresso MCH Mocha* NTO Night Owl* SIE Sienna* TOF Toffee TRF Truffle*	Color: ASL Arctic Silver MBK Matte Black PEW Pewter SNK Soft Nickel	See list of options for each specific unit; Specify and add accordingly.
	Double Cut DC1 Double Cut	③a Wood Finish Double Cut: COF Coffee CRM Cremello FOS Fossil GRH Graphite KHK Khaki STU Studio Teak	③b Chassis Grain Direction For Double Cut Only: Vertical Horizontal	

FLUX - OPEN PLAN

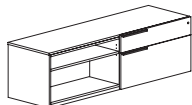
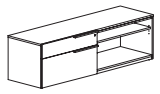
Description	D	W	H	CTN WT	CU FT	① Model	Laminate	Flat Cut Veneer	Double Cut Veneer
<b>Box/Lateral File with Open Storage Credenza</b>  *06 shown  *60	22	72	21	232	24	FLT2272-21F06	\$1,876		
	22	72	21	232	24	FLV2272-21F06		\$2,514	\$2,766
	22	72	21	232	24	FLT2272-21F60	\$1,876		
	22	72	21	232	24	FLV2272-21F60		\$2,514	\$2,766
	22	66	21	214	22	FLT2266-21F06	\$1,821		
	22	66	21	214	22	FLV2266-21F06		\$2,442	\$2,686
	22	66	21	214	22	FLT2266-21F60	\$1,821		
	22	66	21	214	22	FLV2266-21F60		\$2,442	\$2,686
	22	60	21	203	20	FLT2260-21F06	\$1,769		
	22	60	21	203	20	FLV2260-21F06		\$2,368	\$2,606
	22	60	21	203	20	FLT2260-21F60	\$1,769		
	22	60	21	203	20	FLV2260-21F60		\$2,368	\$2,606

**Features:**

- pedestal front locking
- compartment has one adjustable shelf
- shelf 12 1/2"d

**Options:**

- must specify chassis grain direction on double cut veneer, see pages 42-43 for details, see pages 42-43 for details
- peninsula desk mounting must be specified when ordering secondary credenza; see page 47 for details
- concealed box drawer available, specify; add \$191 list for each laminate drawer or \$291 for each veneer drawer, see page 47 for details
- veneer drawer fronts in paint available, specify paint color and add \$275 list; see page 44 for details
- on laminate units, contrasting fronts available, no upcharge; specify color, see page 44 for details
- ledge pulls standard; prism pulls available, specify and see page 39, specify and see page 39
- oval grommets in back panel can be eliminated upon request, no upcharge
- oval or rectangular seat cushion available, see page 53 for more details and page 582 for pricing
- interior horizontal wire manager with end grommets available, specify and add \$148 list; see page 68 for details
- top grommet available, specify location and add \$105 list each; see page 74 for details
- worksurface power available, specify "to accommodate EC26" on your purchase order; EC26 unit must be ordered separately, see page 74

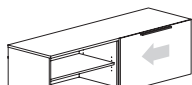
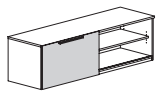
<b>Sliding Door Credenza</b>  	22	72	21	211	24	FLT2272-21F09	\$1,707		
	22	72	21	211	24	FLV2272-21F09		\$2,384	\$2,623
	22	60	21	185	20	FLT2260-21F09	\$1,610		
	22	60	21	185	20	FLV2260-21F09		\$2,248	\$2,473

**Features:**

- locking door not available
- each compartment has one adjustable shelf
- shelves 12 1/2"d

**Options:**

- must specify chassis grain direction on double cut veneer, see pages 42-43 for details, see pages 42-43 for details
- peninsula desk mounting must be specified when ordering secondary credenza; see page 47 for details
- veneer door fronts in paint available, specify paint color and add \$275 list; see page 44 for details
- on laminate units, contrasting laminate door fronts available, no upcharge; specify laminate color, see page 44 for details
- ledge pulls standard; prism pulls available, specify and see page 39, specify and see page 39
- oval grommets in back panel can be eliminated upon request, no upcharge
- oval or rectangular seat cushion available, see page 53 for more details and page 582 for pricing
- interior horizontal wire manager with end grommets available, specify and add \$148 list; see page 68 for details
- top grommet available, specify location and add \$105 list each; see page 74 for details
- worksurface power available, specify "to accommodate EC26" on your purchase order; EC26 unit must be ordered separately, see page 74

FLUX - OPEN PLAN

Description	D	W	H	CTN WT	CU FT	① Model	Laminate	Flat Cut Veneer	Double Cut Veneer
Open Compartment Storage Credenza	22	72	21	193	24	FLT2272-21F00	\$1,481		
	22	72	21	193	24	FLV2272-21F00		\$2,068	\$2,275
	22	60	21	169	20	FLT2260-21F00	\$1,386		
	22	60	21	169	20	FLV2260-21F00		\$1,950	\$2,145

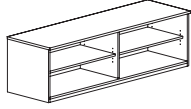

**Features:**

- square edge on top
- each open compartment has one adjustable shelf
- shelves 12 1/2"d

**Options:**

- must specify chassis grain direction on double cut veneer, see pages 42-43 for details, see pages 42-43 for details
- peninsula desk mounting must be specified when ordering secondary credenza; see page 47 for details
- oval or rectangular seat cushion available, see page 53 for more details and page 582 for pricing
- oval grommets in back panel can be eliminated upon request, no upcharge
- interior horizontal wire manager with end grommets available, specify and add \$148 list; see page 68 for details
- top grommet available, specify location and add \$105 list each; see page 74 for details
- worksurface power available, specify "to accommodate EC26" on your purchase order; EC26 unit must be ordered separately, see page 74

Open Storage with Side Power Access	D	W	H	CTN WT	CU FT	① Model	Laminate	Flat Cut Veneer	Double Cut Veneer
	22	36	21	118	13	FLT2236-21FE0	\$1,332		
	22	36	21	118	13	FLV2236-21FE0		\$1,729	\$1,903
	22	36	21	124	13	FLT2236-21FOE	\$1,332		
	22	36	21	124	13	FLV2236-21FOE		\$1,729	\$1,903
	22	30	21	101	11	FLT2230-21FE0	\$1,293		
	22	30	21	101	11	FLV2230-21FE0		\$1,678	\$1,846
	22	30	21	107	11	FLT2230-21FOE	\$1,293		
	22	30	21	107	11	FLV2230-21FOE		\$1,678	\$1,846



\*OE shown

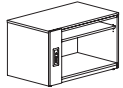

\*EO

**Features:**

- square edge on top
- electrical power unit - EC26 included, specify color
- open compartment with adjustable shelf
- shelf 12 1/2"d

**Options:**

- must specify chassis grain direction on double cut veneer, see pages 42-43 for details, see pages 42-43 for details
- oval or rectangular seat cushion available, see page 53 for more details and page 582 for pricing
- oval grommet in back panel can be eliminated upon request, no upcharge

**To Order, Specify:**

① Laminate Model #	② Laminate Type	③ Laminate Selection			④ Metal Color	⑤ Other Product Options	
Laminate (FLT)	HPL	<b>Solid Patterns:</b> ALB Alabaster BBL Bridal Blanco DWH Designer White SHD Shadow SLG Slate Grey	<b>Wood Grain Patterns:</b> AGA Aged Ash ALL Ale Light BLO Blonde Echo BOL Bourbon Light BZW Brazilwood BGL Brighton Light	CLL Collectors FLO Florence Walnut GRH Graphite HGL High Line OAT Oatmeal Cookie PIN Pinnacle Walnut	STU Studio Teak VIN Vintage WLH Walnut Heights WEA Weathered Ash	Color: ASL Arctic Silver MBK Matte Black PEW Pewter SNK Soft Nickel	See list of options for each specific unit; Specify and add accordingly.

① Veneer Model #	② Wood Species	③ Wood Finish - Finishes with an asterisk (*) have a coordinating laminate available			④ Metal Color	⑤ Other Product Options		
Veneer (FLV)	<b>Flat Cut</b> CH1 Cherry MA1 Maple WA1 Walnut	<b>Cherry:</b> BRL Barley BBM Bourbon Medium BRM Brighton Medium CLA Classic CLL Collectors*	<b>Earthy:</b> EAR Earthy HRV Harvest* LGC Legacy PRL Praline* SAF Saffron	<b>Maple:</b> ALM Ale Medium BUT Butterscotch CIN Cinnamon FLX Flax VEN Venetian	<b>Walnut:</b> AUB Auburn ESP Espresso MCH Mocha* NTO Night Owl* SIE Sienna*	TOF Toffee TRF Truffle*	Color: ASL Arctic Silver MBK Matte Black PEW Pewter SNK Soft Nickel	See list of options for each specific unit; Specify and add accordingly.
	<b>Double Cut</b> DC1 Double Cut	<b>ⓐ Wood Finish</b> Double Cut: COF Coffee FOS Fossil KHK Khaki CRM Cremello GRH Graphite STU Studio Teak		<b>ⓑ Chassis Grain Direction</b> For Double Cut Only: Vertical Horizontal				

FLUX - OPEN PLAN



Description	D	W	H	CTN WT	CU FT	① Model	Laminate	Flat Cut Veneer	Double Cut Veneer
Lateral File Pedestal Credenza -	22	72	21	225	24	FLT2272-21L66	\$2,481		
Flush Legs	22	72	21	225	24	FLV2272-21L66		\$3,222	\$3,544
	22	60	21	198	20	FLT2260-21L66	\$2,341		
	22	60	21	198	20	FLV2260-21L66		\$3,039	\$3,344

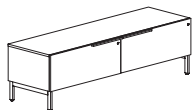

**Features:**

- pedestal front locking

**Options:**

- must specify chassis grain direction on double cut veneer, see pages 42-43 for details, see pages 42-43 for details
- veneer drawer fronts in paint available, specify paint color and add \$275 list; see page 44 for details
- on laminate units, contrasting fronts available, no upcharge; specify color, see page 44 for details
- ledge pulls standard; prism pulls available, specify and see page 39, specify and see page 39
- oval or rectangular seat cushion available, see page 53 for more details and page 582 for pricing
- oval grommets in back panel can be eliminated upon request, no upcharge
- interior horizontal wire manager with end grommets available, specify and add \$148 list; see page 68 for details
- top grommet available, specify location and add \$105 list each; see page 74 for details

Description	D	W	H	CTN WT	CU FT	① Model	Laminate	Flat Cut Veneer	Double Cut Veneer
Lateral Credenza - Inset Legs	22	72	21	220	24	FLT2272-21S66	\$2,481		
	22	72	21	220	24	FLV2272-21S66		\$3,222	\$3,544

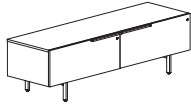

**Features:**

- pedestal front locking

**Options:**

- must specify chassis grain direction on double cut veneer, see pages 42-43 for details, see pages 42-43 for details
- veneer drawer fronts in paint available, specify paint color and add \$275 list; see page 44 for details
- on laminate units, contrasting fronts available, no upcharge; specify color, see page 44 for details
- ledge pulls standard; prism pulls available, specify and see page 39, specify and see page 39
- oval or rectangular seat cushion available, see page 53 for more details and page 582 for pricing
- oval grommets in back panel can be eliminated upon request, no upcharge
- interior horizontal wire manager with end grommets available, specify and add \$148 list; see page 68 for details
- top grommet available, specify location and add \$105 list each; see page 74 for details

Lateral File Pedestal Credenza - Flush Legs	22	36	21	127	13	FLT2236-21L6	\$1,797		
	22	36	21	127	13	FLV2236-21L6		\$2,333	\$2,567
	22	30	21	104	11	FLT2230-21L6	\$1,745		
	22	30	21	104	11	FLV2230-21L6		\$2,264	\$2,491

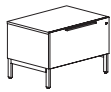

**Features:**

- pedestal front locking

**Options:**

- must specify chassis grain direction on double cut veneer, see pages 42-43 for details, see pages 42-43 for details
- veneer drawer fronts in paint available, specify paint color and add \$275 list; see page 44 for details
- on laminate units, contrasting fronts available, no upcharge; specify color, see page 44 for details
- ledge pulls standard; prism pulls available, specify and see page 39, specify and see page 39
- oval or rectangular seat cushion available, see page 53 for more details and page 582 for pricing
- oval grommets in back panel can be eliminated upon request, no upcharge
- interior horizontal wire manager with end grommets available, specify and add \$148 list; see page 68 for details
- top grommet available, specify location and add \$105 list each; see page 74 for details

**To Order, Specify:**

① Laminate Model #	② Laminate Type	③ Laminate Selection			④ Metal Color	⑤ Other Product Options	
Laminate (FLT)	HPL	<b>Solid Patterns:</b> ALB Alabaster BBL Bridal Blanco DWH Designer White SHD Shadow SLG Slate Grey	<b>Wood Grain Patterns:</b> AGA Aged Ash ALL Ale Light BLO Blonde Echo BOL Bourbon Light BZW Brazilwood BGL Brighton Light	CLL Collectors FLO Florence Walnut GRH Graphite HGL High Line OAT Oatmeal Cookie PIN Pinnacle Walnut	STU Studio Teak VIN Vintage WLH Walnut Heights WEA Weathered Ash	Color: ASL Arctic Silver MBK Matte Black PEW Pewter SNK Soft Nickel	See list of options for each specific unit; Specify and add accordingly.

① Veneer Model #	② Wood Species	③ Wood Finish - Finishes with an asterisk (*) have a coordinating laminate available			④ Metal Color	⑤ Other Product Options		
Veneer (FLV)	<b>Flat Cut</b> CH1 Cherry MA1 Maple WA1 Walnut	<b>Cherry:</b> BRL Barley BBM Bourbon Medium BRM Brighton Medium CLA Classic CLL Collectors*	<b>Earthy:</b> EAR Earthy HRV Harvest* LGC Legacy PRL Praline* SAF Saffron	<b>Maple:</b> ALM Ale Medium BUT Butterscotch CIN Cinnamon FLX Flax VEN Venetian	<b>Walnut:</b> AUB Auburn ESP Espresso MCH Mocha* NTO Night Owl* SIE Sienna*	TOF Toffee TRF Truffle*	Color: ASL Arctic Silver MBK Matte Black PEW Pewter SNK Soft Nickel	See list of options for each specific unit; Specify and add accordingly.
	<b>Double Cut</b> DC1 Double Cut	<b>ⓐ Wood Finish</b> Double Cut: COF Coffee FOS Fossil KHK Khaki CRM Cremello GRH Graphite STU Studio Teak		<b>ⓑ Chassis Grain Direction</b> For Double Cut Only: Vertical Horizontal				

FLUX - OPEN PLAN

Description	D	W	H	CTN WT	CU FT	① Model	Laminate	Flat Cut Veneer	Double Cut Veneer
Lateral File and Open Storage Credenza - Flush Legs	22	72	21	210	24	FLT2272-21L06	\$2,289		
	22	72	21	210	24	FLV2272-21L06		\$2,972	\$3,269
	22	72	21	210	24	FLT2272-21L60	\$2,289		
	22	72	21	210	24	FLV2272-21L60		\$2,972	\$3,269
	22	66	21	186	22	FLT2266-21L06	\$2,222		
	22	66	21	186	22	FLV2266-21L06		\$2,883	\$3,172
	22	66	21	177	22	FLT2266-21L60	\$2,222		
	22	66	21	177	22	FLV2266-21L60		\$2,883	\$3,172
	22	60	21	169	20	FLT2260-21L06	\$2,154		
	22	60	21	169	20	FLV2260-21L06		\$2,795	\$3,076
	22	60	21	169	20	FLT2260-21L60	\$2,154		
	22	60	21	169	20	FLV2260-21L60		\$2,795	\$3,076

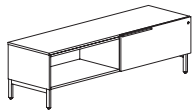

\*06 shown

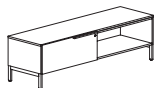

\*60 shown

**Features:**

- pedestal front locking

**Options:**

- must specify chassis grain direction on double cut veneer, see pages 42-43 for details, see pages 42-43 for details
- peninsula desk mounting must be specified when ordering secondary credenza; see page 47 for details
- veneer drawer fronts in paint available, specify paint color and add \$275 list; see page 44 for details
- on laminate units, contrasting fronts available, no upcharge; specify color, see page 44 for details
- ledge pulls standard; prism pulls available, specify and see page 39, specify and see page 39
- oval or rectangular seat cushion available, see page 53 for more details and page 582 for pricing
- oval grommets in back panel can be eliminated upon request, no upcharge
- interior horizontal wire manager with end grommets available, specify and add \$148 list; see page 68 for details
- top grommet available, specify location and add \$105 list each; see page 74 for details
- worksurface power available, specify "to accommodate EC26" on your purchase order; EC26 unit must be ordered separately, see page 74

Lateral File and Open Storage Credenza - Inset Legs	22	72	21	205	24	FLT2272-21S06	\$2,289		
	22	72	21	205	24	FLV2272-21S06		\$2,972	\$3,268
	22	72	21	205	24	FLT2272-21S60	\$2,289		
	22	72	21	205	24	FLV2272-21S60		\$2,972	\$3,268
	22	60	21	161	20	FLT2260-21S06	\$2,154		
	22	60	21	161	20	FLV2260-21S06		\$2,795	\$3,076
	22	60	21	161	20	FLT2260-21S60	\$2,154		
	22	60	21	161	20	FLV2260-21S60		\$2,795	\$3,076

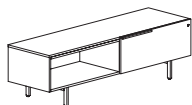

\*06 shown

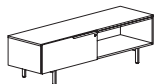

\*60

**Features:**

- pedestal front locking

**Options:**

- must specify chassis grain direction on double cut veneer, see pages 42-43 for details, see pages 42-43 for details
- peninsula desk mounting must be specified when ordering secondary credenza; see page 47 for details
- veneer drawer fronts in paint available, specify paint color and add \$275 list; see page 44 for details
- on laminate units, contrasting fronts available, no upcharge; specify color, see page 44 for details
- ledge pulls standard; prism pulls available, specify and see page 39, specify and see page 39
- oval or rectangular seat cushion available, see page 53 for more details and page 582 for pricing
- oval grommets in back panel can be eliminated upon request, no upcharge
- interior horizontal wire manager with end grommets available, specify and add \$148 list; see page 68 for details
- top grommet available, specify location and add \$105 list each; see page 74 for details
- worksurface power available, specify "to accommodate EC26" on your purchase order; EC26 unit must be ordered separately, see page 74

FLUX - OPEN PLAN

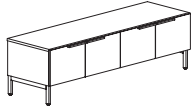
Description	D	W	H	CTN WT	CU FT	① Model	Laminate	Flat Cut Veneer	Double Cut Veneer
 Four Door Storage - Flush Legs	22	72	21	189	24	FLT2272-21L77	\$1,934		
	22	72	21	189	24	FLV2272-21L77		\$2,511	\$2,762
	22	60	21	160	20	FLT2260-21L77	\$1,818		
	22	60	21	160	20	FLV2260-21L77		\$2,360	\$2,598

**Options:**

- must specify chassis grain direction on double cut veneer, see pages 42-43 for details, see pages 42-43 for details
- locking doors available, specify and add \$245 list
- veneer door fronts in paint available, specify paint color and add \$275 list; see page 44 for details
- on laminate units, contrasting laminate door fronts available, no upcharge; specify laminate color, see page 44 for details
- ledge pulls standard; prism pulls available, specify and see page 39, specify and see page 39
- oval or rectangular seat cushion available, see page 53 for more details and page 582 for pricing
- oval grommets in back panel can be eliminated upon request, no upcharge
- interior horizontal wire manager with end grommets available, specify and add \$148 list; see page 68 for details
- top grommet available, specify location and add \$105 list each; see page 74 for details
- worksurface power available, specify "to accommodate EC26" on your purchase order; EC26 unit must be ordered separately, see page 74

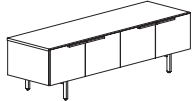
Description	D	W	H	CTN WT	CU FT	① Model	Laminate	Flat Cut Veneer	Double Cut Veneer
 Four Door Storage Credenza - Inset Legs	22	72	21	196	20	FLT2272-21S77	\$1,934		
	22	72	21	196	20	FLV2272-21S77		\$2,511	\$2,762
	22	60	21	152	20	FLT2260-21S77	\$1,818		
	22	60	21	152	20	FLV2260-21S77		\$2,360	\$2,597

**Options:**

- must specify chassis grain direction on double cut veneer, see pages 42-43 for details, see pages 42-43 for details
- locking doors available, specify and add \$245 list
- veneer door fronts in paint available, specify paint color and add \$275 list; see page 44 for details
- on laminate units, contrasting laminate door fronts available, no upcharge; specify laminate color, see page 44 for details
- ledge pulls standard; prism pulls available, specify and see page 39, specify and see page 39
- oval or rectangular seat cushion available, see page 53 for more details and page 582 for pricing
- oval grommets in back panel can be eliminated upon request, no upcharge
- interior horizontal wire manager with end grommets available, specify and add \$148 list; see page 68 for details
- top grommet available, specify location and add \$105 list each; see page 74 for details
- worksurface power available, specify "to accommodate EC26" on your purchase order; EC26 unit must be ordered separately, see page 74

**To Order, Specify:**

① Laminate Model #	② Laminate Type	③ Laminate Selection	④ Metal Color	⑤ Other Product Options
Laminate (FLT)	HPL	Solid Patterns: ALB Alabaster BBL Bridal Blanco DWH Designer White SHD Shadow SLG Slate Grey  Wood Grain Patterns: AGA Aged Ash ALL Ale Light BLO Blonde Echo BOL Bourbon Light BZW Brazilwood BGL Brighton Light CLL Collectors FLO Florence Walnut GRH Graphite HGL High Line OAT Oatmeal Cookie PIN Pinnacle Walnut STU Studio Teak VIN Vintage WLH Walnut Heights WEA Weathered Ash	Color: ASL Arctic Silver MBK Matte Black PEW Pewter SNK Soft Nickel	See list of options for each specific unit; Specify and add accordingly.

① Veneer Model #	② Wood Species	③ Wood Finish - Finishes with an asterisk (*) have a coordinating laminate available	④ Metal Color	⑤ Other Product Options
Veneer (FLV)	Flat Cut CH1 Cherry MA1 Maple WA1 Walnut	Cherry: BRL Barley BBM Bourbon Medium BRM Brighton Medium CLA Classic CLL Collectors* EAR Earthy HRV Harvest* LGC Legacy PRL Praline* SAF Saffron Maple: ALM Ale Medium BUT Butterscotch CIN Cinnamon FLX Flax VEN Venetian Walnut: AUB Auburn ESP Espresso MCH Mocha* NTO Night Owl* SIE Sienna* TOF Toffee TRF Truffle*	Color: ASL Arctic Silver MBK Matte Black PEW Pewter SNK Soft Nickel	See list of options for each specific unit; Specify and add accordingly.
	Double Cut DC1 Double Cut	ⓐ Wood Finish Double Cut: COF Coffee CRM Cremello FOS Fossil GRH Graphite KHK Khaki STU Studio Teak ⓑ Chassis Grain Direction For Double Cut Only: Vertical Horizontal		

Description	D	W	H	CTN WT	CU FT	① Model	Laminate	Flat Cut Veneer	Double Cut Veneer
Open Compartment Storage	22	72	21	136	24	FLT2272-21L00	\$1,740		
Credenza - Flush Legs	22	72	21	136	24	FLV2272-21L00		\$2,259	\$2,485
	22	60	21	136	20	FLT2260-21L00	\$1,638		
	22	60	21	136	20	FLV2260-21L00		\$2,126	\$2,338

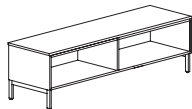

**Options:**

- must specify chassis grain direction on double cut veneer, see pages 42-43 for details, see pages 42-43 for details
- peninsula desk mounting must be specified when ordering secondary credenza; see page 47 for details
- oval or rectangular seat cushion available, see page 53 for more details and page 582 for pricing
- oval grommets in back panel can be eliminated upon request, no upcharge
- top grommet available, specify location and add \$105 list each; see page 74 for details
- worksurface power available, specify "to accommodate EC26" on your purchase order; EC26 unit must be ordered separately, see page 74

Description	D	W	H	CTN WT	CU FT	① Model	Laminate	Flat Cut Veneer	Double Cut Veneer
Open Storage with Side Power Access - Flush Legs	22	36	21	100	13	FLT2236-21LE0	\$1,785		
	22	36	21	100	13	FLV2236-21LE0		\$2,317	\$2,549
	22	36	21	96	13	FLT2236-21LOE	\$1,785		
	22	36	21	96	13	FLV2236-21LOE		\$2,317	\$2,549
	22	30	21	84	11	FLT2230-21LE0	\$1,750		
	22	30	21	84	11	FLV2230-21LE0		\$2,271	\$2,499
	22	30	21	84	11	FLT2230-21LOE	\$1,750		
	22	30	21	84	11	FLV2230-21LOE		\$2,271	\$2,499



\*OE shown



\*EO

**Features:**

- square edge on top
- electrical power unit - EC26 included, specify color

**Options:**

- must specify chassis grain direction on double cut veneer, see pages 42-43 for details, see pages 42-43 for details
- oval or rectangular seat cushion available, see page 53 for more details and page 582 for pricing
- oval grommet in back panel can be eliminated upon request, no upcharge

**To Order, Specify:**

① Laminate Model #	② Laminate Type	③ Laminate Selection	④ Metal Color	⑤ Other Product Options
Laminate (FLT)	HPL	Solid Patterns: ALB Alabaster BBL Bridal Blanco DWH Designer White SHD Shadow SLG Slate Grey  Wood Grain Patterns: AGA Aged Ash ALL Ale Light BLO Blonde Echo BOL Bourbon Light BZW Brazilwood BGL Brighton Light CLL Collectors FLO Florence Walnut GRH Graphite HGL High Line OAT Oatmeal Cookie PIN Pinnacle Walnut STU Studio Teak VIN Vintage WLH Walnut Heights WEA Weathered Ash	Color: ASL Arctic Silver MBK Matte Black PEW Pewter SNK Soft Nickel	See list of options for each specific unit; Specify and add accordingly.

① Veneer Model #	② Wood Species	③ Wood Finish - Finishes with an asterisk (*) have a coordinating laminate available	④ Metal Color	⑤ Other Product Options
Veneer (FLV)	Flat Cut CH1 Cherry MA1 Maple WA1 Walnut	Cherry: BRL Barley BBM Bourbon Medium BRM Brighton Medium CLA Classic CLL Collectors* EAR Earthy HRV Harvest* LGC Legacy PRL Praline* SAF Saffron Maple: ALM Ale Medium BUT Butterscotch CIN Cinnamon FLX Flax VEN Venetian Walnut: AUB Auburn ESP Espresso MCH Mocha* NTO Night Owl* SIE Sienna* TOF Toffee TRF Truffle*	Color: ASL Arctic Silver MBK Matte Black PEW Pewter SNK Soft Nickel	See list of options for each specific unit; Specify and add accordingly.
	Double Cut DC1 Double Cut	⑧ Wood Finish Double Cut: COF Coffee CRM Cremello FOS Fossil GRH Graphite KHK Khaki STU Studio Teak ⑨ Chassis Grain Direction For Double Cut Only: Vertical Horizontal		

Description	D	W	H	CTN WT	CU FT	① Model	List Price Per Grade	
<b>Oval Cushion</b>  <ul style="list-style-type: none"> <li>· use with secondary height units 30" - 36" wide</li> <li>· com ydg: 1 ¾</li> </ul>	20	29	1 ¾	10	2	FLB20290VCUSH	<b>COM</b> \$237	
								A \$250
								B \$276
								<b>COL/C</b> \$321
								D \$379
								E \$435
								F \$523
								G \$619
								H \$721
								I \$879
								J \$1,071
								L1 \$690
								L2 \$803

<b>Rectangular Cushion</b>  <ul style="list-style-type: none"> <li>· use with secondary height units 30" - 36" wide</li> <li>· com ydg: 1 ¾</li> </ul>	20	29	1 ¾	11	2	FLB2029RECUSH	<b>COM</b> \$237	
								A \$250
								B \$276
								<b>COL/C</b> \$321
								D \$379
								E \$435
								F \$523
								G \$619
								H \$721
								I \$879
								J \$1,071
								L1 \$690
								L2 \$803

Description	D	W	H	CTN WT	CU FT	① Model	List Price Per Grade
Round Cushion 	15 ¼	15 ¼	1 ¾	5	1	FLB1515RDCUSH	COM \$191 A \$199 B \$214 COL/C \$240 D \$275 E \$309 F \$362 G \$419 H \$481 I \$575 J \$691 L1 \$461 L2 \$530
<ul style="list-style-type: none"> <li>· use with secondary height 18" w mobile pedestals</li> <li>· com ydg: ¾</li> </ul>							

Square Cushion 	15 ¼	15 ¼	1 ¾	5	1	FLB1515SQCUSH	COM \$191 A \$199 B \$214 COL/C \$240 D \$275 E \$309 F \$362 G \$419 H \$481 I \$575 J \$691 L1 \$461 L2 \$530
<ul style="list-style-type: none"> <li>· use with secondary height 18" w mobile pedestals</li> <li>· com ydg: ¾</li> </ul>							

To Order, Specify:

① Model Number	② Fabric Selection	
(FLB)	Vendor Pattern Color	See a selection of graded in fabric manufacturers and patterns on pages 19-27. Contact Customer Service for additional fabric options.