

Forge - Overview

Base Cabinets

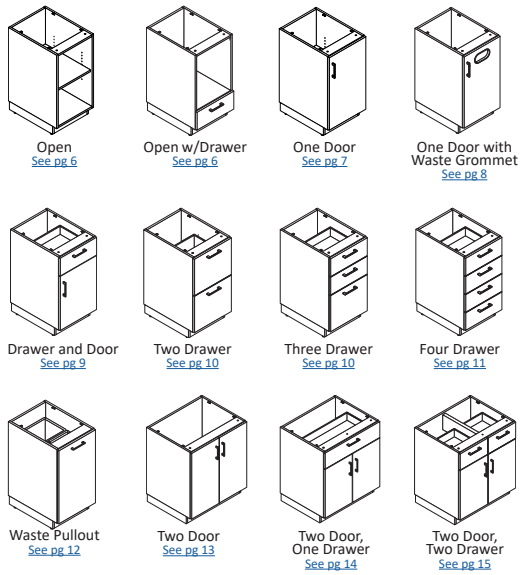

Base Sink Cabinets

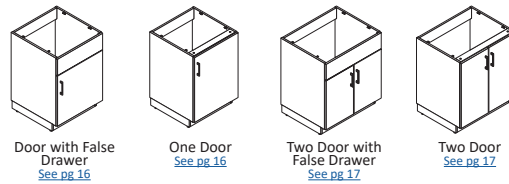

Base Filler & End Panels

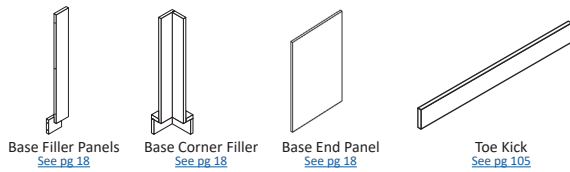

Wall Hanging Base Cabinets

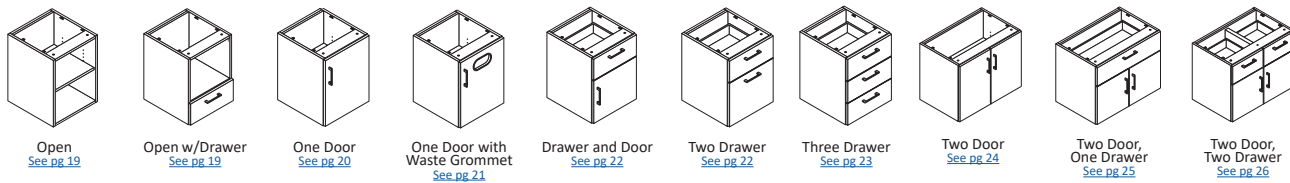

Wall Hanging Sink Cabinets

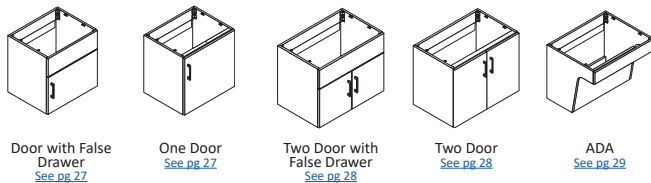

Wall Filler Panels

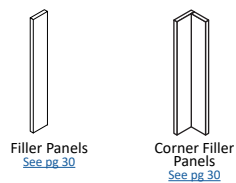

HPL Worksurfaces

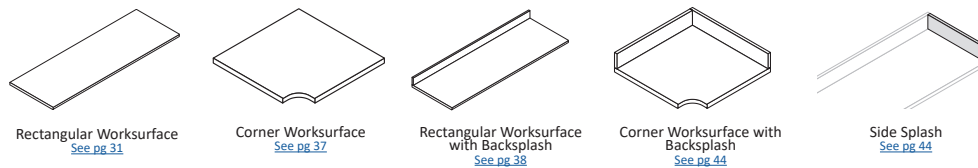

Forge - Overview

Solid Surface Worksurfaces

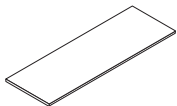

Rectangular Worksurface
[See pg 45](#)

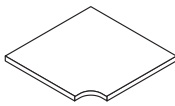

Corner Worksurface
[See pg 51](#)

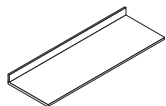

Rectangular Worksurface with Integral Backsplash
[See pg 52](#)

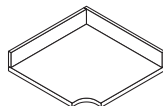

Corner Worksurface with Integral Backsplash
[See pg 58](#)

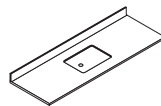

Worksurface with Integral Backsplash & Sink
[See pg 59](#)

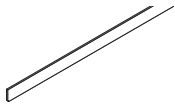

Backsplash
[See pg 65](#)

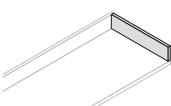

Side Splash
[See pg 68](#)

Accessories



Worsurface Waste Ring
[See pg 62](#)

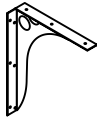

Worsurface Bracket
[See pg 69](#)

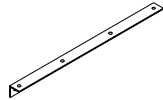

L-Bracket
[See pg 69](#)



Edge Support
[See pg 69](#)



Flat Bracket
[See pg 69](#)

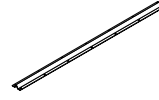

Support Rail
[See pg 69](#)



Support Bracket for End Panel
[See pg 69](#)

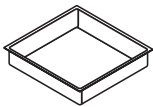

Removable Drawer Liner
[See pg 106](#)



Wall Panel
[See pg 104](#)

Upper Cabinets

Flat Top

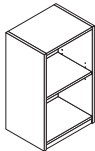

Open
[See pg 70](#)

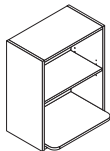

Open with Microwave Shelf
[See pg 70](#)

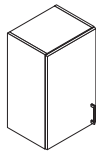

One Door
[See pg 71](#)

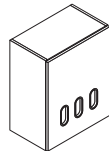

One Door with Glove Box
[See pg 72](#)

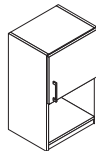

One Door with Open Shelf
[See pg 73](#)

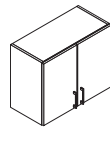

Two Door
[See pg 74](#)

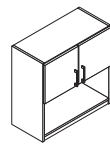

Two Doors with Open Shelf
[See pg 74](#)

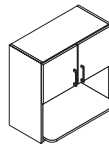

Two Door with Microwave Shelf
[See pg 74](#)

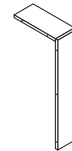

Filler Panel
[See pg 75](#)

Sloped Top

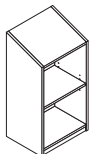

Open
[See pg 76](#)

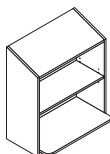

Open with Microwave Shelf
[See pg 76](#)

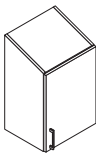

One Door
[See pg 77](#)

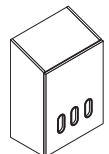

One Door with Glove Box
[See pg 78](#)

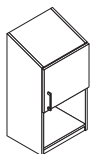

One Door with Open Shelf
[See pg 79](#)

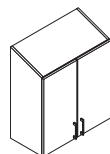

Two Door
[See pg 80](#)

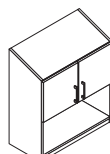

Two Doors with Open Shelf
[See pg 80](#)

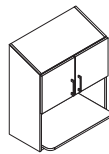

Two Door with Microwave Shelf
[See pg 80](#)

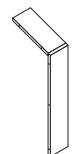

Filler Panel
[See pg 81](#)

Forge - Overview

Storage Cabinets

Flat Top

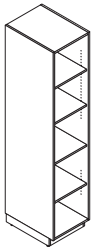

Open
[See pg 82](#)

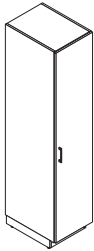

One Door
[See pg 83](#)

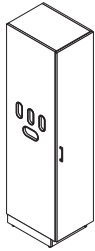

One Door with
Glove Box
[See pg 85](#)

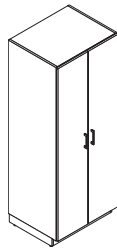

Two Door
[See pg 87](#)

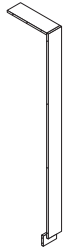

Filler Panels
[See pg 88](#)

Sloped Top

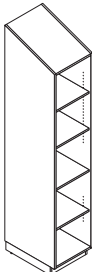

Open
[See pg 89](#)

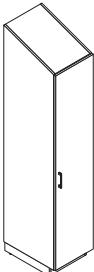

One Door
[See pg 90](#)

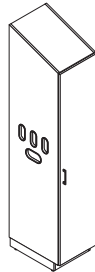

One Door with
Glove Box
[See pg 92](#)

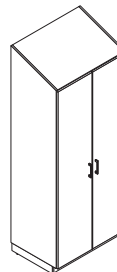

Two Door
[See pg 94](#)



Filler Panels
[See pg 95](#)

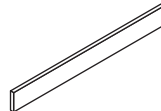

Toe Kick
[See pg 105](#)

Lockers

Flat Top

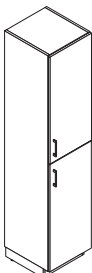

Two Door
[See pg 96](#)

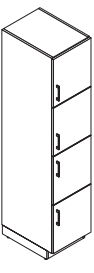

Four Door
[See pg 98](#)

Sloped Top

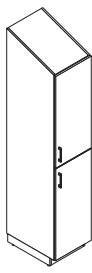

Two Door
[See pg 100](#)

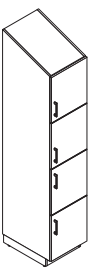

Four Door
[See pg 102](#)

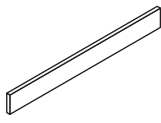

Toe Kick
[See pg 105](#)

Forge Product Information

NOTE: Forge storage must be anchored to a wall (hardware not included); not intended for freestanding use. [Reference Installation Instructions for more details.](#)

WorkSurfaces

Forge offers worksurfaces in both HPL Laminate and Solid Surfaces. Laminate worksurfaces have a 3-ply balanced construction. Tops are 1 3/16" thick with coordinating PVC edges. Worksurfaces feature 3mm eased (PVC) edge on the front; sides and back have coordinating 1mm PVC edge band.

Forge worksurfaces are available in all JSI standard HPL's, consisting of 19 wood grain patterns and 7 solid colors. Each has a coordinating PVC edge color that is automatically used with the standard laminates. The wood grain laminate features an embossed grain to hide finger prints and light scratches. The solid laminate is smooth to the touch with a semi-matte finish.

The chart below lists the laminates available on the Forge product.

TFL - HPL Wood Grain Pattern Laminates

BEL Belair	MIN Mineral
BRK Brickdust	MCH Mocha
CSK Cask	OBK Outback
CLY Clay	PIL Pilsner
EGR Egret	PIN Pinnacle Walnut
FAW Fawn	UMB Umber
FLN Flint	VAL Valley
FLO Florence Walnut	WLH Walnut Heights
LOF Loft	WEA Weathered Ash
MES Mesa	

TFL - HPL Solid Laminates

ALB Alabaster	SHD Shadow
BLK Black	SLG Slate Grey
BBL Bridal Blanco	ZEN Zen Grey
DWH Designer White	

In addition, an extensive list of HPL laminates from Wilsonart and Formica are available at the Tier 2 price, [see pages 107-108](#). Selecting from the Tier 2 laminates will require a PVC banding to be specified from the standard list.

Solid surface worksurfaces are 1" thick and have a moisture-resistant core. Front edge features a 3mm radius eased edge, sides and back have finished flat edge. Worksurfaces are available in 4 standard JSI colors.

DWH Designer White	ONX Black Onyx Mirage
HST Hot Stone	SOG Soothing Grey

Additional Wilsonart and Corian finishes are available in 4 pricing tiers, [see pages 109-110](#).

Cabinet Construction

Forge Laminate features TFL (thermally fused laminate) chassis with standard banding. Worksurfaces are available in a HPL (high pressure laminate) with standard banding.

Thermally fused laminate (TFL) with all edges fully banded. Interior material matches exterior. 3/4" thick side panels. Adjustable glides on base cabinets, storage cabinets and lockers; they provide 1" adjustment. Must use toe kick or cove molding to finish off base cabinets.

Grain direction runs vertically on all door/drawer fronts. Door and drawer fronts are banded with a 2mm banding.

Drawers

The unidirectional V- Fold drawer box is a durable miter-fold drawer structure which is glued and doweled. The 1/2" thick drawer sides are wrapped in a high grade white vinyl, with an attached front. The drawer front is attached to the four sided box.

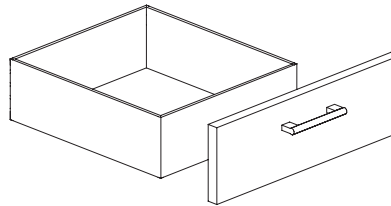

Drawer Suspension

High quality soft close, silver drawer suspension carries a lifetime warranty. Drawers have 100% full extension with over travel. Slides feature steel ball bearings for longer wear and positive, cushioned in/out stops.

Drawer Liner

Seamless, one-piece, white drawer liner available for 18" and 24" wide drawers.

Hinges

Concealed Euro soft close hinges with 110° opening and four adjustment points.

Locking

Cabinets offer locking to provide maximum security and flexibility in configuration. Up-charge applies. Locks are available as a standard keyed lock or a digital keyless lock.

When standard locks are ordered, units are shipped randomly keyed. Key alike units are available upon request for no additional charges. Removable cores for in-field re-keying are standard. Lock face color is available in Arctic Silver or Matte Black.

Digital Keyless Locks come pre-programmed for shared use, but can be field programmed for dedicated use. To lock, enter a 4 to 8 digit code and press the lock button. To unlock reenter the previous 4 to 8 digit code and press the unlock button. User guide ships with cabinet. Keyless lock will be oriented vertically on drawer units and horizontally on doors. Lock face is available in a black finish.

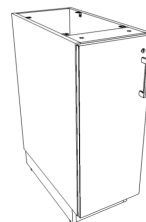

Standard Lock



Keyless Lock (drawer)

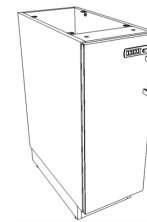

Keyless Lock (door)

Wall Panels

3/4" thick with standard TFL 1/2" banding.

Forge Product Information

Top Edge Profile

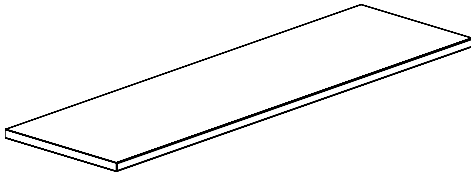

Tops feature a 3mm radius front edge, sides and back are flat

Pull and Color Options

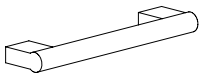

Bar
Matte Black MBK
Polished Nickel PNK



Sweep
Matte Black MBK
Matte Nickel MNK

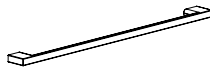

Delve
Aged Bronze ABZ
Arctic Silver ASL
Chrome CHR
Gold GLD
Matte Black MBK
Pewter PEW
Soft Bronze SBZ
Soft Nickel SNK



Prospect
Aged Bronze ABZ
Arctic Silver ASL
Gold GLD
Matte Black MBK
Pewter PEW
Soft Bronze SBZ
Soft Nickel SNK

Bar, Sweep and Delve are ADA compliant.

Pull Alignment

Bar, Sweep and Delve pulls are mounted on the front of drawer/door. Prospect pull overlays the top of the drawer and door front. Bar and Sweep pulls are standard in one length for every application. Delve and Prospect pulls offer an enhanced aesthetic on 30" - 36" wide drawer cabinets with an elongated version. In these cases, the longer pull is used in appropriate applications - user need not specify.

Boring Dimensions

24" wide or smaller

Sweep, Delve and Bar - 128mm

Prospect - 216mm

30" & 36" wide

Delve - 320mm

Prospect - 419mm

Integral Sink

Sink is always Designer White independent of selection of worksurface. Sink location is available in 1" increments from left side of worksurface to centerline of sink with minimum of 12" to centerline from either edge of surface. Sink should always be centered over sink cabinet. Drain hole is nominally 1 3/4" diameter and accepts standard drain hardware (not included).

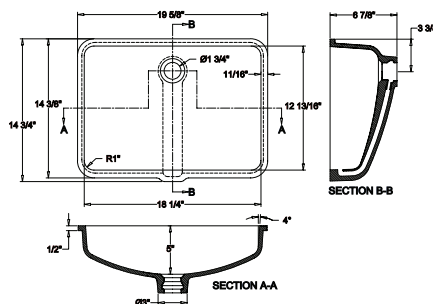
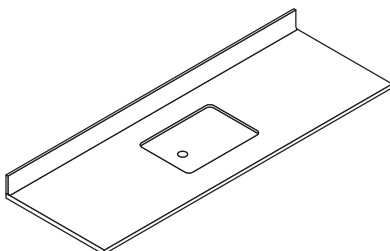

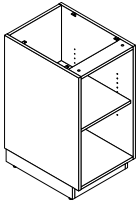
Description	D	W	H	CTN WT	CU FT	Model	List
Open Base Cabinet 	23 ½	36	35	97	21	40C243635BCT	\$1,105
	23 ½	30	35	87	18	40C243035BCT	\$1,065
	23 ½	24	35	76	15	40C242435BCT	\$1,020
	23 ½	21	35	70	13	40C242135BCT	\$980
	23 ½	18	35	65	11	40C241835BCT	\$940
	23 ½	15	35	59	10	40C241535BCT	\$900
	23 ½	12	35	54	8	40C241235BCT	\$855
	23 ½	36	32 ½	93	20	40C243633BCT	\$980
	23 ½	30	32 ½	82	17	40C243033BCT	\$960
	23 ½	24	32 ½	72	14	40C242433BCT	\$940
	23 ½	21	32 ½	66	12	40C242133BCT	\$915
	23 ½	18	32 ½	61	11	40C241833BCT	\$890
	23 ½	15	32 ½	56	9	40C241533BCT	\$865
	23 ½	12	32 ½	51	8	40C241233BCT	\$840

• one adjustable shelf

Specify: Model | Chassis Laminate

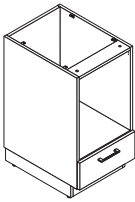
Description	D	W	H	CTN WT	CU FT	Model	List
Open Base Cabinet with Drawer 	24 ¼	36	35	90	22	40C243635BC1T	\$1,875
	24 ¼	30	35	81	18	40C243035BC1T	\$1,810
	24 ¼	24	35	71	15	40C242435BC1T	\$1,750
	24 ¼	21	35	66	13	40C242135BC1T	\$1,690
	24 ¼	18	35	62	12	40C241835BC1T	\$1,630
	24 ¼	15	35	57	10	40C241535BC1T	\$1,570
	24 ¼	12	35	52	8	40C241235BC1T	\$1,510
	24 ¼	36	32 ½	89	20	40C243633BC1T	\$1,770
	24 ¼	30	32 ½	80	17	40C243033BC1T	\$1,705
	24 ¼	24	32 ½	71	14	40C242433BC1T	\$1,642
	24 ¼	21	32 ½	66	13	40C242133BC1T	\$1,579
	24 ¼	18	32 ½	61	11	40C241833BC1T	\$1,516
	24 ¼	15	32 ½	57	9	40C241533BC1T	\$1,453
	24 ¼	12	32 ½	52	8	40C241233BC1T	\$1,390

Specify: Model | Chassis Laminate | Drawer Laminate | Pull | Lock

Model	Chassis Laminate	Drawer Laminate	Pull	Lock
	see Forge Laminate Finishes	see Forge Laminate Finishes	P001 Bar see Bar Pull Color P005 Delve see Delve Pull Color P011 Prospect see Prospect Pull Color P003 Sweep see Sweep Pull Color	NLK No Lock KLK Standard - add \$78 ASL Arctic Silver MBK Matte Black DLK Keyless Lock - add \$232

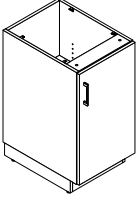
Description	D	W	H	CTN WT	CU FT	Model	List
One Door Base - Right Hinged Cabinet 	24 ¼	24	35	91	15	40C242435BCDRT	\$1,146
	24 ¼	21	35	84	13	40C242135BCDRT	\$1,133
	24 ¼	18	35	76	12	40C241835BCDRT	\$1,120
	24 ¼	15	35	69	10	40C241535BCDRT	\$1,082
	24 ¼	12	35	62	8	40C241235BCDRT	\$1,061
	24 ¼	24	32 ½	86	14	40C242433BCDRT	\$1,053
	24 ¼	21	32 ½	79	13	40C242133BCDRT	\$1,045
	24 ¼	18	32 ½	72	11	40C241833BCDRT	\$1,037
	24 ¼	15	32 ½	65	9	40C241533BCDRT	\$1,029
	24 ¼	12	32 ½	58	8	40C241233BCDRT	\$1,021

• one adjustable shelf

Specify: Model | Chassis Laminate | Door Laminate | Pull | Lock

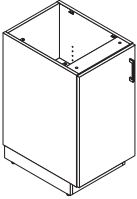
One Door Base - Left Hinged Cabinet 	24 ¼	24	35	91	15	40C242435BCDLT	\$1,146
	24 ¼	21	35	84	13	40C242135BCDLT	\$1,133
	24 ¼	18	35	76	12	40C241835BCDLT	\$1,120
	24 ¼	15	35	69	10	40C241535BCDLT	\$1,082
	24 ¼	12	35	62	8	40C241235BCDLT	\$1,061
	24 ¼	24	32 ½	86	14	40C242433BCDLT	\$1,053
	24 ¼	21	32 ½	79	13	40C242133BCDLT	\$1,045
	24 ¼	18	32 ½	72	11	40C241833BCDLT	\$1,037
	24 ¼	15	32 ½	65	9	40C241533BCDLT	\$1,029
	24 ¼	12	32 ½	58	8	40C241233BCDLT	\$1,021

• one adjustable shelf

Specify: Model | Chassis Laminate | Door Laminate | Pull | Lock

Model	Chassis Laminate	Door Laminate	Pull	Lock
	see Forge Laminate Finishes	see Forge Laminate Finishes	P001 Bar see Bar Pull Color P005 Delve see Delve Pull Color P011 Prospect see Prospect Pull Color P003 Sweep see Sweep Pull Color	NLK No Lock KLK Standard - add \$78 ASL Arctic Silver MBK Matte Black DLK Keyless Lock - add \$232

Description	D	W	H	CTN WT	CU FT	Model	List
One Door Base - Right Hinged Cabinet, Waste Grommet	24 ¼	24	35	91	15	40C242435BCDRTGT	\$1,171
	24 ¼	21	35	84	13	40C242135BCDRTGT	\$1,158
	24 ¼	18	35	76	12	40C241835BCDRTGT	\$1,145
	24 ¼	15	35	69	10	40C241535BCDRTGT	\$1,135
	24 ¼	12	35	62	8	40C241235BCDRTGT	\$1,112
	24 ¼	24	32 ½	86	14	40C242433BCDRTGT	\$1,098
	24 ¼	21	32 ½	79	13	40C242133BCDRTGT	\$1,084
	24 ¼	18	32 ½	72	11	40C241833BCDRTGT	\$1,070
	24 ¼	15	32 ½	65	9	40C241533BCDRTGT	\$1,056
	24 ¼	12	32 ½	58	8	40C241233BCDRTGT	\$1,042

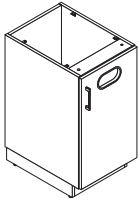

• waste grommet size 7 ½" x 4" x 13/16" - zinc oval grommet

Specify: Model | Chassis Laminate | Door Laminate | Pull | Lock | Waste Grommet Color

One Door Base - Left Hinged Cabinet, Waste Grommet	24 ¼	24	35	91	15	40C242435BCDLTGT	\$1,171
	24 ¼	21	35	84	13	40C242135BCDLTGT	\$1,158
	24 ¼	18	35	76	12	40C241835BCDLTGT	\$1,145
	24 ¼	15	35	69	10	40C241535BCDLTGT	\$1,135
	24 ¼	12	35	62	8	40C241235BCDLTGT	\$1,112
	24 ¼	24	32 ½	86	14	40C242433BCDLTGT	\$1,098
	24 ¼	21	32 ½	79	13	40C242133BCDLTGT	\$1,084
	24 ¼	18	32 ½	72	11	40C241833BCDLTGT	\$1,070
	24 ¼	15	32 ½	65	9	40C241533BCDLTGT	\$1,056
	24 ¼	12	32 ½	58	8	40C241233BCDLTGT	\$1,042

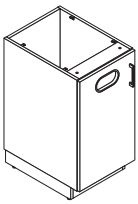

• waste grommet size 7 ½" x 4" x 13/16" - zinc oval grommet

Specify: Model | Chassis Laminate | Door Laminate | Pull | Lock | Waste Grommet Color

Model	Chassis Laminate	Door Laminate	Pull	Lock	Waste Grommet Color
	see Forge Laminate Finishes	see Forge Laminate Finishes	P001 Bar see Bar Pull Color P005 Delve see Delve Pull Color P011 Prospect see Prospect Pull Color P003 Sweep see Sweep Pull Color	NLK No Lock KLK Standard - add \$78 ASL Arctic Silver MBK Matte Black	MBK Matte Black SNK Soft Nickel

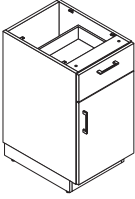
Description	D	W	H	CTN WT	CU FT	Model	List
 <p>One Door - Right Hinged, One Drawer Base Cabinet</p>	24 ¼	24	35	97	15	40C242435BCDDRT	\$1,615
	24 ¼	21	35	90	13	40C242135BCDDRT	\$1,591
	24 ¼	18	35	82	12	40C241835BCDDRT	\$1,486
	24 ¼	15	35	74	10	40C241535BCDDRT	\$1,471
	24 ¼	12	35	67	8	40C241235BCDDRT	\$1,455
	24 ¼	24	32 ½	92	14	40C242433BCDDRT	\$1,439
	24 ¼	21	32 ½	85	13	40C242133BCDDRT	\$1,423
	24 ¼	18	32 ½	77	11	40C241833BCDDRT	\$1,407
	24 ¼	15	32 ½	70	9	40C241533BCDDRT	\$1,391
	24 ¼	12	32 ½	63	8	40C241233BCDDRT	\$1,375

- plastic drawer liner available on top drawer for 18" and 24" wide cabinets, [see page 106](#) for pricing
 - 18" 40CDBL184
 - 24" 40CDBL244
- Note: when locking is specified, only top drawer locks

Specify: Model | Chassis Laminate | Door/Drawer Laminate | Pull | Lock

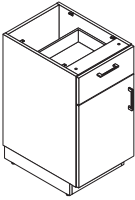
Description	D	W	H	CTN WT	CU FT	Model	List
 <p>One Door - Left Hinged, One Drawer Base Cabinet</p>	24 ¼	24	35	97	15	40C242435BCDDLTL	\$1,615
	24 ¼	21	35	90	13	40C242135BCDDLTL	\$1,591
	24 ¼	18	35	82	12	40C241835BCDDLTL	\$1,486
	24 ¼	15	35	74	10	40C241535BCDDLTL	\$1,471
	24 ¼	12	35	67	8	40C241235BCDDLTL	\$1,455
	24 ¼	24	32 ½	92	14	40C242433BCDDLTL	\$1,439
	24 ¼	21	32 ½	85	13	40C242133BCDDLTL	\$1,423
	24 ¼	18	32 ½	77	11	40C241833BCDDLTL	\$1,407
	24 ¼	15	32 ½	70	9	40C241533BCDDLTL	\$1,391
	24 ¼	12	32 ½	63	8	40C241233BCDDLTL	\$1,375

- plastic drawer liner available on top drawer for 18" and 24" wide cabinets, [see page 106](#) for pricing
 - 18" 40CDBL184
 - 24" 40CDBL244
- Note: when locking is specified, only top drawer locks

Specify: Model | Chassis Laminate | Door/Drawer Laminate | Pull | Lock

Model	Chassis Laminate	Door/Drawer Laminate	Pull	Lock
	see Forge Laminate Finishes	see Forge Laminate Finishes	P001 Bar see Bar Pull Color P005 Delve see Delve Pull Color P011 Prospect see Prospect Pull Color P003 Sweep see Sweep Pull Color	NLK No Lock KLK Standard - add \$78 ASL Arctic Silver MBK Matte Black DLK Keyless Lock - add \$232

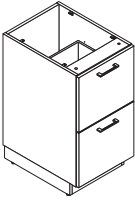
Description	D	W	H	CTN WT	CU FT	Model	List
 <p>Two Drawer Base Cabinet</p>	24 ¼	36	35	129	22	40C243635BC2T	\$1,775
	24 ¼	30	35	114	18	40C243035BC2T	\$1,760
	24 ¼	24	35	99	15	40C242435BC2T	\$1,745
	24 ¼	21	35	92	13	40C242135BC2T	\$1,730
	24 ¼	18	35	84	12	40C241835BC2T	\$1,715
	24 ¼	15	35	77	10	40C241535BC2T	\$1,700
	24 ¼	12	35	70	8	40C241235BC2T	\$1,685
	24 ¼	36	32 ½	122	20	40C243633BC2T	\$1,670
	24 ¼	30	32 ½	108	17	40C243033BC2T	\$1,655
	24 ¼	24	32 ½	94	14	40C242433BC2T	\$1,640
	24 ¼	21	32 ½	87	13	40C242133BC2T	\$1,592
	24 ¼	18	32 ½	80	11	40C241833BC2T	\$1,545
	24 ¼	15	32 ½	73	9	40C241533BC2T	\$1,497
	24 ¼	12	32 ½	66	8	40C241233BC2T	\$1,450

• Note: when locking is specified, only top drawer locks

Specify: Model | Chassis Laminate | Drawer Laminate | Pull | Lock

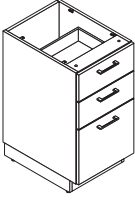
 <p>Three Drawer Base Cabinet</p>	24 ¼	36	35	127	22	40C243635BC3T	\$1,870
	24 ¼	30	35	113	18	40C243035BC3T	\$1,855
	24 ¼	24	35	99	15	40C242435BC3T	\$1,840
	24 ¼	21	35	92	13	40C242135BC3T	\$1,825
	24 ¼	18	35	85	12	40C241835BC3T	\$1,810
	24 ¼	15	35	78	10	40C241535BC3T	\$1,795
	24 ¼	12	35	71	8	40C241235BC3T	\$1,780
	24 ¼	36	32 ½	121	20	40C243633BC3T	\$1,765
	24 ¼	30	32 ½	108	17	40C243033BC3T	\$1,750
	24 ¼	24	32 ½	94	14	40C242433BC3T	\$1,735
	24 ¼	21	32 ½	87	13	40C242133BC3T	\$1,720
	24 ¼	18	32 ½	80	11	40C241833BC3T	\$1,705
	24 ¼	15	32 ½	73	9	40C241533BC3T	\$1,690
	24 ¼	12	32 ½	67	8	40C241233BC3T	\$1,675

• plastic drawer liner available on top two drawers for 18" and 24" wide cabinets, see page 106 for pricing

- 18" 40CDBL184

- 24" 40CDBL244

• Note: when locking is specified, only top drawer locks

Model	Chassis Laminate	Drawer Laminate	Pull	Lock
	see Forge Laminate Finishes	see Forge Laminate Finishes	<p>P001 Bar see Bar Pull Color</p> <p>P005 Delve see Delve Pull Color</p> <p>P011 Prospect see Prospect Pull Color</p> <p>P003 Sweep see Sweep Pull Color</p>	<p>NLK No Lock</p> <p>KLK Standard - add \$78</p> <p>ASL Arctic Silver</p> <p>MBK Matte Black</p> <p>DLK Keyless Lock - add \$232</p>

Description	D	W	H	CTN WT	CU FT	① Model	List
 <p>Four Drawer Base Cabinet</p>	24 ¼	36	35	134	22	40C243635BC4T	\$2,380
	24 ¼	30	35	120	18	40C243035BC4T	\$2,288
	24 ¼	24	35	105	15	40C242435BC4T	\$2,196
	24 ¼	21	35	98	13	40C242135BC4T	\$2,104
	24 ¼	18	35	90	12	40C241835BC4T	\$2,012
	24 ¼	15	35	83	10	40C241535BC4T	\$1,920
	24 ¼	12	35	76	8	40C241235BC4T	\$1,828
	24 ¼	36	32 ½	128	20	40C243633BC4T	\$2,208
	24 ¼	30	32 ½	114	17	40C243033BC4T	\$2,124
	24 ¼	24	32 ½	100	14	40C242433BC4T	\$2,040
	24 ¼	21	32 ½	93	13	40C242133BC4T	\$1,958
	24 ¼	18	32 ½	86	11	40C241833BC4T	\$1,874
	24 ¼	15	32 ½	78	9	40C241533BC4T	\$1,790
	24 ¼	12	32 ½	72	8	40C241233BC4T	\$1,706

- plastic drawer liner available on 18" and 24" wide cabinets, [see page 106](#) for pricing
 - 18" 40CDBL184
 - 24" 40CDBL244
- Note: when locking is specified, only top drawer locks

Specify: Model | Chassis Laminate | Drawer Laminate | Pull | Lock

Model	Chassis Laminate	Drawer Laminate	Pull	Lock
	see Forge Laminate Finishes	see Forge Laminate Finishes	P001 Bar see Bar Pull Color P005 Delve see Delve Pull Color P011 Prospect see Prospect Pull Color P003 Sweep see Sweep Pull Color	NLK No Lock KLK Standard - add \$78 ASL Arctic Silver MBK Matte Black DLK Keyless Lock - add \$232

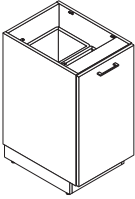
Description	D	W	H	CTN WT	CU FT	Model	List
 Waste Pullout Drawer Base Cabinet	24 ¼	24	35	93	15	40C242435BCWPT	\$1,790
	24 ¼	21	35	85	13	40C242135BCWPT	\$1,743
	24 ¼	18	35	77	12	40C241835BCWPT	\$1,695
	24 ¼	15	35	72	10	40C241535BCWPT	\$1,676
	24 ¼	24	32 ½	88	14	40C242433BCWPT	\$1,657
	24 ¼	21	32 ½	81	13	40C242133BCWPT	\$1,625
	24 ¼	18	32 ½	73	11	40C241833BCWPT	\$1,594
	24 ¼	15	32 ½	68	9	40C241533BCWPT	\$1,563

- one trash can included in 15"w models
- two trash cans included in 18"-24"w models

Specify: Model | Chassis Laminate | Drawer Laminate | Pull

Model	Chassis Laminate	Drawer Laminate	Pull
	see Forge Laminate Finishes	see Forge Laminate Finishes	P001 Bar see Bar Pull Color P005 Delve see Delve Pull Color P011 Prospect see Prospect Pull Color P003 Sweep see Sweep Pull Color

Description	D	W	H	CTN WT	CU FT	Model	List
Two Door Base Cabinet	24 ¼	36	35	121	22	40C243635BCDT	\$1,505
	24 ¼	30	35	106	18	40C243035BCDT	\$1,450
	24 ¼	36	32 ½	115	20	40C243633BCDT	\$1,425
	24 ¼	30	32 ½	100	17	40C243033BCDT	\$1,370

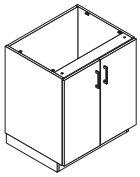

- one adjustable shelf

Specify: Model | Chassis Laminate | Door Laminate | Pull | Lock

Model	Chassis Laminate	Door Laminate	Pull	Lock
	see Forge Laminate Finishes	see Forge Laminate Finishes	P001 Bar see Bar Pull Color P005 Delve see Delve Pull Color P011 Prospect see Prospect Pull Color P003 Sweep see Sweep Pull Color	NLK No Lock KLK Standard - add \$78 ASL Arctic Silver MBK Matte Black DLK Keyless Lock - add \$256

Description	D	W	H	CTN WT	CU FT	Model	List
Two Door, One Drawer Base Cabinet	24 ¼	36	35	129	22	40C243635BCDD1T	\$1,845
	24 ¼	30	35	113	18	40C243035BCDD1T	\$1,790
	24 ¼	36	32 ½	122	20	40C243633BCDD1T	\$1,765
	24 ¼	30	32 ½	107	17	40C243033BCDD1T	\$1,710

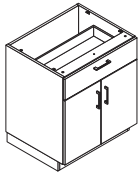

- one adjustable shelf
- Note: when locking is specified, only top drawer locks

Specify: Model | Chassis Laminate | Drawer/Door Laminate | Pull | Lock

Model	Chassis Laminate	Door/Drawer Laminate	Pull	Lock
	see Forge Laminate Finishes	see Forge Laminate Finishes	P001 Bar see Bar Pull Color P005 Delve see Delve Pull Color P011 Prospect see Prospect Pull Color P003 Sweep see Sweep Pull Color	NLK No Lock KLK Standard - add \$78 ASL Arctic Silver MBK Matte Black DLK Keyless Lock - add \$232

Description	D	W	H	CTN WT	CU FT	Model	List
Two Door, Two Drawer Base Cabinet	24 ¼	36	35	132	22	40C243635BCDD2T	\$2,065
	24 ¼	30	35	116	18	40C243035BCDD2T	\$2,010
	24 ¼	36	32 ½	125	20	40C243633BCDD2T	\$1,985
	24 ¼	30	32 ½	110	17	40C243033BCDD2T	\$1,930

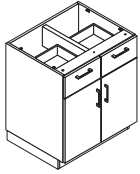

- one adjustable shelf
- 18" plastic drawer liner available for model 40C243635BCDD2T and 40C243633BCDD2T, [see page 106](#)
- Note: when locking is specified, only top drawer locks

Specify: Model | Chassis Laminate | Door/Drawer Laminate | Pull | Lock

Model	Chassis Laminate	Door/Drawer Laminate	Pull	Lock
	see Forge Laminate Finishes	see Forge Laminate Finishes	P001 Bar see Bar Pull Color P005 Delve see Delve Pull Color P011 Prospect see Prospect Pull Color P003 Sweep see Sweep Pull Color	NLK No Lock KLK Standard - add \$156 ASL Arctic Silver MBK Matte Black DLK Keyless Lock - add \$464

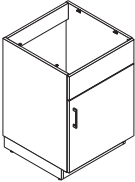
Description	D	W	H	CTN WT	CU FT	Model	List
One Door, False Front Sink Base Cabinet  right shown	Hinged Right						
	24 ¼	24	35	79	15	40C242435BSCDRFT	\$1,335
	24 ¼	24	32 ½	75	14	40C242433BSCDRFT	\$1,265
	Hinged Left						
	24 ¼	24	35	79	15	40C242435BSCDLFT	\$1,335
	24 ¼	24	32 ½	75	14	40C242433BSCDLFT	\$1,265

Specify: Model | Chassis Laminate | Door Laminate | Pull | Lock

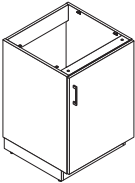
One Door Sink Base Cabinet  right shown	Hinged Right						
	24 ¼	24	35	79	15	40C242435BSCDRT	\$1,320
	24 ¼	24	32 ½	75	14	40C242433BSCDRT	\$1,250
	Hinged Left						
	24 ¼	24	35	79	15	40C242435BSCDLT	\$1,320
	24 ¼	24	32 ½	75	14	40C242433BSCDLT	\$1,250

Specify: Model | Chassis Laminate | Door Laminate | Pull | Lock

Model	Chassis Laminate	Door Laminate	Pull	Lock
	see Forge Laminate Finishes	see Forge Laminate Finishes	P001 Bar see Bar Pull Color P005 Delve see Delve Pull Color P011 Prospect see Prospect Pull Color P003 Sweep see Sweep Pull Color	NLK No Lock KLK Standard - add \$78 ASL Arctic Silver MBK Matte Black DLK Keyless Lock - add \$232

Description	D	W	H	CTN WT	CU FT	Model	List
Two Door, False Front Sink Base Cabinet	24 ¼	36	35	105	22	40C243635BSCDFT	\$1,480
	24 ¼	30	35	93	18	40C243035BSCDFT	\$1,425
	24 ¼	36	32 ½	98	20	40C243633BSCDFT	\$1,400
	24 ¼	30	32 ½	87	17	40C243033BSCDFT	\$1,345

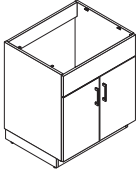

Specify: Model | Chassis Laminate | Door Laminate | Pull | Lock

Two Door Sink Base Cabinet	24 ¼	36	35	105	22	40C243635BSCDT	\$1,470
	24 ¼	30	35	93	18	40C243035BSCDT	\$1,415
	24 ¼	36	32 ½	98	20	40C243633BSCDT	\$1,390
	24 ¼	30	32 ½	87	17	40C243033BSCDT	\$1,335

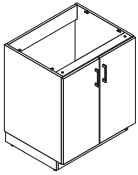

Specify: Model | Chassis Laminate | Door Laminate | Pull | Lock

Model	Chassis Laminate	Door Laminate	Pull	Lock
	see Forge Laminate Finishes	see Forge Laminate Finishes	P001 Bar see Bar Pull Color P005 Delve see Delve Pull Color P011 Prospect see Prospect Pull Color P003 Sweep see Sweep Pull Color	NLK No Lock KLK Standard - add \$78 ASL Arctic Silver MBK Matte Black DLK Keyless Lock - add \$256

Description	D	W	H	CTN WT	CU FT	① Model	List
Base Filler 	6	2	35	4	1	40C6235BFT	\$150
	6	2	32 ½	3	1	40C6233BFT	\$145

- includes brackets to attach to cabinet
- may be field scribed as needed

Specify: Model | Chassis Laminate

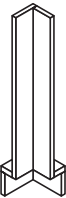
Base Corner Filler 	7	7	35	7	2	40C7735BFT	\$300
	7	7	33	6	2	40C7733BFT	\$290

- use with corner surfaces
- includes brackets to attach to cabinets

Specify: Model | Chassis Laminate

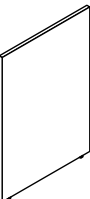
Base End Panel 	23 ½	¾	35	17	2	40C24135BET	\$225
	23 ½	¾	32 ½	16	2	40C24133BET	\$205

- can be used for support in place of a base cabinet
- brackets must be specified separately, [see page 69](#)

Specify: Model | Chassis Laminate

Model	Chassis Laminate
	see Forge Laminate Finishes

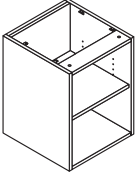
Description	D	W	H	CTN WT	CU FT	Model	List
Open Wall Hanging Base Cabinet 	18 ½	36	23 ½	65	12	40C193624WHBCT	\$985
	18 ½	30	23 ½	57	10	40C193024WHBCT	\$925
	18 ½	24	23 ½	49	8	40C192424WHBCT	\$870
	18 ½	21	23 ½	45	7	40C192124WHBCT	\$810
	18 ½	18	23 ½	41	7	40C191824WHBCT	\$750
	18 ½	15	23 ½	37	6	40C191524WHBCT	\$690
	18 ½	12	23 ½	33	5	40C191224WHBCT	\$630

- one adjustable shelf

Specify: Model | Chassis Laminate

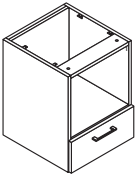
Description	D	W	H	CTN WT	CU FT	Model	List
Open Wall Hanging Base Cabinet with One Drawer 	19 ¼	36	23 ½	74	12	40C193624WHBC1T	\$1,350
	19 ¼	30	23 ½	65	10	40C193024WHBC1T	\$1,275
	19 ¼	24	23 ½	51	9	40C192424WHBC1T	\$1,200
	19 ¼	21	23 ½	47	8	40C192124WHBC1T	\$1,125
	19 ¼	18	23 ½	43	7	40C191824WHBC1T	\$1,050
	19 ¼	15	23 ½	40	6	40C191524WHBC1T	\$975
	19 ¼	12	23 ½	36	5	40C191224WHBC1T	\$900

- one adjustable shelf
- plastic drawer liner available for 18" and 24" wide cabinets, [see page 106](#) for pricing
 18" 40CDBL184
 24" 40CDBL244

Specify: Model | Chassis Laminate | Drawer Laminate | Pull | Lock

Model	Chassis Laminate	Drawer Laminate	Pull	Lock
	see Forge Laminate Finishes	see Forge Laminate Finishes	P001 Bar see Bar Pull Color P005 Delve see Delve Pull Color P011 Prospect see Prospect Pull Color P003 Sweep see Sweep Pull Color	NLK No Lock KLK Standard - add \$78 ASL Arctic Silver MBK Matte Black DLK Keyless Lock - add \$232

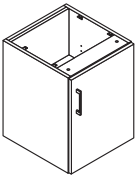
Description	D	W	H	CTN WT	CU FT	Model	List
Door Wall Hanging Base Cabinet  right shown	Hinged Right						
	19 ¼	24	23 ½	61	9	40C192424WHBCDRT	\$915
	19 ¼	21	23 ½	55	8	40C192124WHBCDRT	\$890
	19 ¼	18	23 ½	50	7	40C191824WHBCDRT	\$845
	19 ¼	15	23 ½	44	6	40C191524WHBCDRT	\$831
	19 ¼	12	23 ½	39	5	40C191224WHBCDRT	\$818
	Hinged Left						
	19 ¼	24	23 ½	61	9	40C192424WHBCDLT	\$915
	19 ¼	21	23 ½	55	8	40C192124WHBCDLT	\$890
	19 ¼	18	23 ½	50	7	40C191824WHBCDLT	\$845
19 ¼	15	23 ½	44	6	40C191524WHBCDLT	\$831	
19 ¼	12	23 ½	39	5	40C191224WHBCDLT	\$818	

• one adjustable shelf

Specify: Model | Chassis Laminate | Door Laminate | Pull | Lock

Model	Chassis Laminate	Door Laminate	Pull	Lock
	see Forge Laminate Finishes	see Forge Laminate Finishes	P001 Bar see Bar Pull Color P005 Delve see Delve Pull Color P011 Prospect see Prospect Pull Color P003 Sweep see Sweep Pull Color	NLK No Lock KLK Standard - add \$78 ASL Arctic Silver MBK Matte Black DLK Keyless Lock - add \$232

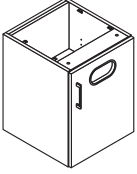
Description	D	W	H	CTN WT	CU FT	Model	List
 Door Wall Hanging Base Cabinet with Waste Grommet right shown	Hinged Right						
	19 ¼	24	23 ½	61	9	40C192424WHBCDRTGT	\$955
	19 ¼	21	23 ½	55	8	40C192124WHBCDRTGT	\$930
	19 ¼	18	23 ½	50	7	40C191824WHBCDRTGT	\$887
	19 ¼	15	23 ½	44	6	40C191524WHBCDRTGT	\$862
	19 ¼	12	23 ½	39	5	40C191224WHBCDRTGT	\$855
	Hinged Left						
	19 ¼	24	23 ½	61	9	40C192424WHBCDLTGT	\$955
	19 ¼	21	23 ½	55	8	40C192124WHBCDLTGT	\$930
	19 ¼	18	23 ½	50	7	40C191824WHBCDLTGT	\$887
19 ¼	15	23 ½	44	6	40C191524WHBCDLTGT	\$862	
19 ¼	12	23 ½	39	5	40C191224WHBCDLTGT	\$855	

• waste grommet size 7 ½" x 4" x 13/16" - zinc oval grommet

Specify: Model | Chassis Laminate | Door Laminate | Pull | Lock | Waste Grommet Color

Model	Chassis Laminate	Door Laminate	Pull	Lock	Waste Grommet Color
	see Forge Laminate Finishes	see Forge Laminate Finishes	P001 Bar see Bar Pull Color P005 Delve see Delve Pull Color P011 Prospect see Prospect Pull Color P003 Sweep see Sweep Pull Color	NLK No Lock KLK Standard - add \$78 ASL Arctic Silver MBK Matte Black	MBK Matte Black SNK Soft Nickel

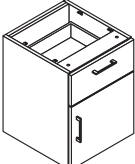
Description	D	W	H	CTN WT	CU FT	Model	List
One Door, One Drawer Wall Hanging Base Cabinet 	Hinged Right						
	19 ¼	24	23 ½	67	9	40C192424WHBCDDRT	\$1,182
	19 ¼	21	23 ½	61	8	40C192124WHBCDDRT	\$1,149
	19 ¼	18	23 ½	55	7	40C191824WHBCDDRT	\$1,115
	19 ¼	15	23 ½	49	6	40C191524WHBCDDRT	\$1,081
	19 ¼	12	23 ½	44	5	40C191224WHBCDDRT	\$1,047

right shown

Hinged Left						
19 ¼	24	23 ½	67	9	40C192424WHBCDDL	\$1,182
19 ¼	21	23 ½	61	8	40C192124WHBCDDL	\$1,149
19 ¼	18	23 ½	55	7	40C191824WHBCDDL	\$1,115
19 ¼	15	23 ½	49	6	40C191524WHBCDDL	\$1,081
19 ¼	12	23 ½	44	5	40C191224WHBCDDL	\$1,047

- plastic drawer liner available on drawer for 18" and 24" wide cabinets, [see page 106](#) for pricing
18" 40CDBL184
24" 40CDBL244
- Note: when locking is specified, only drawer locks

Specify: Model | Chassis Laminate | Door/Drawer Laminate | Pull | Lock

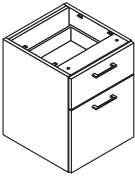
Two Drawer Wall Hanging Base Cabinet 	19 ¼	36	23 ½	98	12	40C193624WHBC2T	\$1,362
	19 ¼	30	23 ½	86	10	40C193024WHBC2T	\$1,332
	19 ¼	24	23 ½	68	9	40C192424WHBC2T	\$1,302
	19 ¼	21	23 ½	63	8	40C192124WHBC2T	\$1,272
	19 ¼	18	23 ½	57	7	40C191824WHBC2T	\$1,242
	19 ¼	15	23 ½	52	6	40C191524WHBC2T	\$1,212
	19 ¼	12	23 ½	46	5	40C191224WHBC2T	\$1,182

- plastic drawer liner available on top drawer for 18" and 24" wide cabinets, [see page 106](#) for pricing
18" 40CDBL184
24" 40CDBL244
- Note: when locking is specified, only top drawer locks

Specify: Model | Chassis Laminate | Drawer Laminate | Pull | Lock

Model	Chassis Laminate	Door/Drawer Laminate	Pull	Lock
	see Forge Laminate Finishes	see Forge Laminate Finishes	P001 Bar see Bar Pull Color P005 Delve see Delve Pull Color P011 Prospect see Prospect Pull Color P003 Sweep see Sweep Pull Color	NLK No Lock KLK Standard - add \$78 ASL Arctic Silver MBK Matte Black DLK Keyless Lock - add \$232

Description	D	W	H	CTN WT	CU FT	① Model	List
Three Drawer Wall Hanging Base Cabinet 	19 ¼	36	23 ½	101	12	40C193624WHBC3T	\$1,500
	19 ¼	30	23 ½	89	10	40C193024WHBC3T	\$1,440
	19 ¼	24	23 ½	71	9	40C192424WHBC3T	\$1,380
	19 ¼	21	23 ½	66	8	40C192124WHBC3T	\$1,320
	19 ¼	18	23 ½	60	7	40C191824WHBC3T	\$1,260
	19 ¼	15	23 ½	54	6	40C191524WHBC3T	\$1,200
	19 ¼	12	23 ½	49	5	40C191224WHBC3T	\$1,140

- plastic drawer liner available for 18" and 24" wide cabinets, [see page 106](#) for pricing
 18" 40CDBL184
 24" 40CDBL244
- Note: when locking is specified, only top drawer locks

Specify: Model | Chassis Laminate | Drawer Laminate | Pull | Lock

Model	Chassis Laminate	Drawer Laminate	Pull	Lock
	see Forge Laminate Finishes	see Forge Laminate Finishes	P001 Bar see Bar Pull Color P005 Delve see Delve Pull Color P011 Prospect see Prospect Pull Color P003 Sweep see Sweep Pull Color	NLK No Lock KLK Standard - add \$78 ASL Arctic Silver MBK Matte Black DLK Keyless Lock - add \$232

Description	D	W	H	CTN WT	CU FT	Model	List
Two Door Wall Hanging Base Cabinet	19 ¼	36	23 ½	93	12	40C193624WHBCDT	\$1,155
	19 ¼	30	23 ½	82	10	40C193024WHBCDT	\$1,100

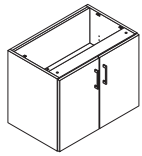

- one adjustable shelf

Specify: Model | Chassis Laminate | Door Laminate | Pull | Lock

Model	Chassis Laminate	Door Laminate	Pull	Lock
	see Forge Laminate Finishes	see Forge Laminate Finishes	P001 Bar see Bar Pull Color P005 Delve see Delve Pull Color P011 Prospect see Prospect Pull Color P003 Sweep see Sweep Pull Color	NLK No Lock KLK Standard - add \$78 ASL Arctic Silver MBK Matte Black DLK Keyless Lock - add \$256

Description	D	W	H	CTN WT	CU FT	Model	List
Two Door, One Drawer Wall Hanging Base Cabinet	19 ¼	36	23 ½	100	12	40C193624WHBCDDT	\$1,375
	19 ¼	30	23 ½	89	10	40C193024WHBCDDT	\$1,260

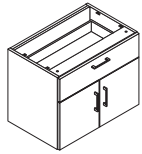

- one adjustable shelf
- Note: when locking is specified, only drawer locks

Specify: Model | Chassis Laminate | Door/Drawer Laminate | Pull | Lock

Model	Chassis Laminate	Door/Drawer Laminate	Pull	Lock
	see Forge Laminate Finishes	see Forge Laminate Finishes	P001 Bar see Bar Pull Color P005 Delve see Delve Pull Color P011 Prospect see Prospect Pull Color P003 Sweep see Sweep Pull Color	NLK No Lock KLK Standard - add \$78 ASL Arctic Silver MBK Matte Black DLK Keyless Lock - add \$232

Description	D	W	H	CTN WT	CU FT	Model	List
Two Door, Two Drawer Wall Hanging Base Cabinet	19 ¼	36	23 ½	104	12	40C193624WHBCDD2T	\$1,450
	19 ¼	30	23 ½	92	10	40C193024WHBCDD2T	\$1,335

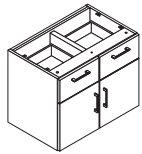

- one adjustable shelf
- 18" plastic drawer liner available for model 40C193624WHBCDD2T, [see page 106](#) for pricing - 18" 40CDBL184
- Note: when locking is specified, only drawer locks

Specify: Model | Chassis Laminate | Door/Drawer Laminate | Pull | Lock

Model	Chassis Laminate	Door/Drawer Laminate	Pull	Lock
	see Forge Laminate Finishes	see Forge Laminate Finishes	P001 Bar see Bar Pull Color P005 Delve see Delve Pull Color P011 Prospect see Prospect Pull Color P003 Sweep see Sweep Pull Color	NLK No Lock KLK Standard - add \$156 ASL Arctic Silver MBK Matte Black DLK Keyless Lock - add \$464

Description	D	W	H	CTN WT	CU FT	Model	List
One Door, False Drawer Front Wall Hanging Sink Cabinet	Hinged Right						
	19 ¼	24	23 ½	53	9	40C192424WHSCDRFT	\$895

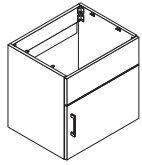

right shown

Hinged Left						
19 ¼	24	23 ½	53	9	40C192424WHSCDLFT	\$895

Specify: Model | Chassis Laminate | Door Laminate | Pull | Lock

One Door Wall Hanging Sink Cabinet	Hinged Right						
	19 ¼	24	23 ½	53	9	40C192424WHSCDRT	\$890

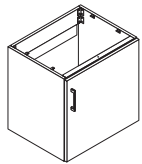

right shown

Hinged Left						
19 ¼	24	23 ½	53	9	40C192424WHSCDLT	\$890

Specify: Model | Chassis Laminate | Door Laminate | Pull | Lock

Model	Chassis Laminate	Door Laminate	Pull	Lock
	see Forge Laminate Finishes	see Forge Laminate Finishes	P001 Bar see Bar Pull Color P005 Delve see Delve Pull Color P011 Prospect see Prospect Pull Color P003 Sweep see Sweep Pull Color	NLK No Lock KLK Standard - add \$78 ASL Arctic Silver MBK Matte Black DLK Keyless Lock - add \$232

Description	D	W	H	CTN WT	CU FT	Model	List
Two Door False Front Wall Hanging Sink Cabinet	19 ¼	36	23 ½	70	12	40C193624WHSCDFT	\$1,045
	19 ¼	30	23 ½	62	10	40C193024WHSCDFT	\$990

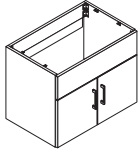

Specify: Model | Chassis Laminate | Door Laminate | Pull | Lock

Two Door Wall Hanging Sink Cabinet	19 ¼	36	23 ½	70	12	40C193624WHSCDT	\$1,045
	19 ¼	30	23 ½	62	10	40C193024WHSCDT	\$990

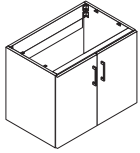

Specify: Model | Chassis Laminate | Door Laminate | Pull | Lock

Model	Chassis Laminate	Door Laminate	Pull	Lock
	see Forge Laminate Finishes	see Forge Laminate Finishes	P001 Bar see Bar Pull Color P005 Delve see Delve Pull Color P011 Prospect see Prospect Pull Color P003 Sweep see Sweep Pull Color	NLK No Lock KLK Standard - add \$78 ASL Arctic Silver MBK Matte Black DLK Keyless Lock - add \$256

Description	D	W	H	CTN WT	CU FT	Model	List
ADA Wall Hanging Sink Cabinet 	24 ¼	36	23 ½	47	15	40C243624ADAT	\$1,250
	24 ¼	30	23 ½	47	15	40C243024ADAT	\$1,195
	19 ¼	36	23 ½	39	12	40C193624ADAT	\$1,135
	19 ¼	30	23 ½	34	10	40C193024ADAT	\$1,080

- removable front panel

Specify: Model | Chassis Laminate | False Front Laminate

Model	Chassis Laminate	False Front Laminate
	see Forge Laminate Finishes	see Forge Laminate Finishes

Description	D	W	H	CTN WT	CU FT	① Model	List
Wall Hanging Filler	6	¾	23 ½	3	1	40C6124WHFT	\$136

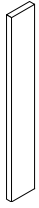

- includes brackets to attach to cabinet
- may be field scribed as needed

Specify: Model | Chassis Laminate

Wall Hanging Corner Filler	4 ¼	4 ¼	23 ½	5	1	40C4424WHFT	\$272
----------------------------	-----	-----	------	---	---	-------------	-------

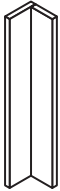

- includes brackets to attach to cabinet

Specify: Model | Chassis Laminate

Model	Chassis Laminate
	see Forge Laminate Finishes

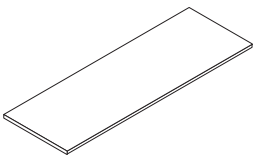
Description	D	W	H	CTN WT	CU FT	① Model	Tier 1	Tier 2
24½" d HPL Worksurfaces 	24 ½	120	1 ⅜	104	7	40C25120TH	\$984	\$1,034
	24 ½	119	1 ⅜	103	7	40C25119TH	\$979	\$1,028
	24 ½	118	1 ⅜	102	7	40C25118TH	\$974	\$1,023
	24 ½	117	1 ⅜	101	7	40C25117TH	\$968	\$1,017
	24 ½	116	1 ⅜	101	6	40C25116TH	\$962	\$1,011
	24 ½	115	1 ⅜	100	6	40C25115TH	\$956	\$1,004
	24 ½	114	1 ⅜	99	6	40C25114TH	\$950	\$998
	24 ½	113	1 ⅜	98	6	40C25113TH	\$944	\$992
	24 ½	112	1 ⅜	97	6	40C25112TH	\$938	\$985
	24 ½	111	1 ⅜	96	6	40C25111TH	\$932	\$979
	24 ½	110	1 ⅜	95	6	40C25110TH	\$926	\$973
	24 ½	109	1 ⅜	95	6	40C25109TH	\$920	\$966
	24 ½	108	1 ⅜	94	6	40C25108TH	\$914	\$960
	24 ½	107	1 ⅜	93	6	40C25107TH	\$906	\$952
	24 ½	106	1 ⅜	92	6	40C25106TH	\$898	\$943
	24 ½	105	1 ⅜	91	6	40C25105TH	\$890	\$935
	24 ½	104	1 ⅜	90	6	40C25104TH	\$882	\$927
	24 ½	103	1 ⅜	89	6	40C25103TH	\$875	\$919
	24 ½	102	1 ⅜	88	6	40C25102TH	\$866	\$910
	24 ½	101	1 ⅜	88	6	40C25101TH	\$857	\$900
	24 ½	100	1 ⅜	87	6	40C25100TH	\$848	\$891
	24 ½	99	1 ⅜	86	6	40C2599TH	\$839	\$881
	24 ½	98	1 ⅜	85	6	40C2598TH	\$830	\$872
	24 ½	97	1 ⅜	84	6	40C2597TH	\$821	\$863
	24 ½	96	1 ⅜	83	5	40C2596TH	\$812	\$853
	24 ½	95	1 ⅜	82	5	40C2595TH	\$801	\$842
	24 ½	94	1 ⅜	82	5	40C2594TH	\$790	\$830
	24 ½	93	1 ⅜	81	5	40C2593TH	\$779	\$818
	24 ½	92	1 ⅜	80	5	40C2592TH	\$768	\$807
	24 ½	91	1 ⅜	79	5	40C2591TH	\$757	\$795
	24 ½	90	1 ⅜	78	5	40C2590TH	\$746	\$784
	24 ½	89	1 ⅜	77	5	40C2589TH	\$735	\$772
24 ½	88	1 ⅜	76	5	40C2588TH	\$724	\$761	
24 ½	87	1 ⅜	75	5	40C2587TH	\$713	\$749	
24 ½	86	1 ⅜	75	5	40C2586TH	\$702	\$738	
24 ½	85	1 ⅜	74	5	40C2585TH	\$691	\$726	

• 3mm front edge, 1mm side and back edges

Specify: Model | Worksurface Laminate | Edge Finish

Model	Worksurface Laminate	Edge Finish
	see Forge Laminate Finishes	see Forge Edge Finishes (when applicable)

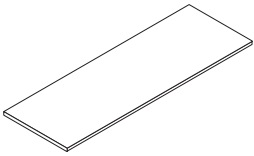
Description	D	W	H	CTN WT	CU FT	① Model	Tier 1	Tier 2
24½" d HPL Worksurfaces (continued) 	24 ½	84	1 ⅜	73	5	40C2584TH	\$680	\$714
	24 ½	83	1 ⅜	72	5	40C2583TH	\$672	\$706
	24 ½	82	1 ⅜	71	5	40C2582TH	\$664	\$698
	24 ½	81	1 ⅜	70	5	40C2581TH	\$656	\$689
	24 ½	80	1 ⅜	69	5	40C2580TH	\$648	\$681
	24 ½	79	1 ⅜	69	5	40C2579TH	\$640	\$672
	24 ½	78	1 ⅜	68	5	40C2578TH	\$632	\$664
	24 ½	77	1 ⅜	67	5	40C2577TH	\$624	\$656
	24 ½	76	1 ⅜	66	4	40C2576TH	\$616	\$647
	24 ½	75	1 ⅜	65	4	40C2575TH	\$608	\$639
	24 ½	74	1 ⅜	64	4	40C2574TH	\$600	\$630
	24 ½	73	1 ⅜	63	4	40C2573TH	\$592	\$622
	24 ½	72	1 ⅜	62	4	40C2572TH	\$584	\$614
	24 ½	71	1 ⅜	62	4	40C2571TH	\$575	\$604
	24 ½	70	1 ⅜	61	4	40C2570TH	\$567	\$596
	24 ½	69	1 ⅜	60	4	40C2569TH	\$559	\$587
	24 ½	68	1 ⅜	59	4	40C2568TH	\$551	\$579
	24 ½	67	1 ⅜	58	4	40C2567TH	\$543	\$571
	24 ½	66	1 ⅜	57	4	40C2566TH	\$535	\$562
	24 ½	65	1 ⅜	56	4	40C2565TH	\$527	\$554
	24 ½	64	1 ⅜	56	4	40C2564TH	\$519	\$545
	24 ½	63	1 ⅜	55	4	40C2563TH	\$511	\$537
	24 ½	62	1 ⅜	54	4	40C2562TH	\$503	\$529
	24 ½	61	1 ⅜	53	4	40C2561TH	\$495	\$520
	24 ½	60	1 ⅜	52	4	40C2560TH	\$487	\$512
	24 ½	59	1 ⅜	51	4	40C2559TH	\$480	\$504
	24 ½	58	1 ⅜	50	4	40C2558TH	\$473	\$497
	24 ½	57	1 ⅜	49	3	40C2557TH	\$465	\$489
	24 ½	56	1 ⅜	49	3	40C2556TH	\$457	\$480
	24 ½	55	1 ⅜	48	3	40C2555TH	\$449	\$472
	24 ½	54	1 ⅜	47	3	40C2554TH	\$440	\$462
	24 ½	53	1 ⅜	46	3	40C2553TH	\$433	\$455
24 ½	52	1 ⅜	45	3	40C2552TH	\$427	\$449	
24 ½	51	1 ⅜	44	3	40C2551TH	\$421	\$443	
24 ½	50	1 ⅜	43	3	40C2550TH	\$415	\$436	
24 ½	49	1 ⅜	43	3	40C2549TH	\$409	\$430	

• 3mm front edge, 1mm side and back edges

Specify: Model | Worksurface Laminate | Edge Finish

Model	Worksurface Laminate	Edge Finish
	see Forge Laminate Finishes	see Forge Edge Finishes (when applicable)

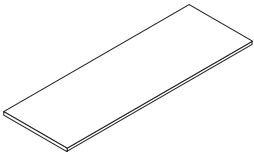
Description	D	W	H	CTN WT	CU FT	① Model	Tier 1	Tier 2
24½" d HPL Worksurfaces (continued) 	24 ½	48	1 ⅜	42	3	40C2548TH	\$403	\$424
	24 ½	47	1 ⅜	41	3	40C2547TH	\$401	\$422
	24 ½	46	1 ⅜	40	3	40C2546TH	\$400	\$420
	24 ½	45	1 ⅜	39	3	40C2545TH	\$398	\$418
	24 ½	44	1 ⅜	38	3	40C2544TH	\$396	\$416
	24 ½	43	1 ⅜	37	3	40C2543TH	\$394	\$414
	24 ½	42	1 ⅜	36	3	40C2542TH	\$393	\$413
	24 ½	41	1 ⅜	36	3	40C2541TH	\$391	\$411
	24 ½	40	1 ⅜	35	3	40C2540TH	\$390	\$410
	24 ½	39	1 ⅜	34	3	40C2539TH	\$388	\$408
	24 ½	38	1 ⅜	33	3	40C2538TH	\$386	\$406
	24 ½	37	1 ⅜	32	2	40C2537TH	\$385	\$405
	24 ½	36	1 ⅜	31	2	40C2536TH	\$383	\$403
	24 ½	35	1 ⅜	30	2	40C2535TH	\$379	\$398
	24 ½	34	1 ⅜	30	2	40C2534TH	\$376	\$395
	24 ½	33	1 ⅜	29	2	40C2533TH	\$373	\$392
	24 ½	32	1 ⅜	28	2	40C2532TH	\$370	\$389
	24 ½	31	1 ⅜	27	2	40C2531TH	\$367	\$386
	24 ½	30	1 ⅜	26	2	40C2530TH	\$364	\$383
	24 ½	29	1 ⅜	25	2	40C2529TH	\$361	\$380
	24 ½	28	1 ⅜	24	2	40C2528TH	\$358	\$376
	24 ½	27	1 ⅜	23	2	40C2527TH	\$356	\$374
	24 ½	26	1 ⅜	23	2	40C2526TH	\$353	\$371
	24 ½	25	1 ⅜	22	2	40C2525TH	\$351	\$369
	24 ½	24	1 ⅜	21	2	40C2524TH	\$349	\$367
	24 ½	23	1 ⅜	20	2	40C2523TH	\$346	\$364
	24 ½	22	1 ⅜	19	2	40C2522TH	\$343	\$361
	24 ½	21	1 ⅜	18	2	40C2521TH	\$340	\$357
	24 ½	20	1 ⅜	17	2	40C2520TH	\$337	\$354
	24 ½	19	1 ⅜	17	2	40C2519TH	\$335	\$352
	24 ½	18	1 ⅜	16	2	40C2518TH	\$333	\$350
	24 ½	17	1 ⅜	15	1	40C2517TH	\$330	\$347
	24 ½	16	1 ⅜	14	1	40C2516TH	\$328	\$345
	24 ½	15	1 ⅜	13	1	40C2515TH	\$325	\$342
24 ½	14	1 ⅜	12	1	40C2514TH	\$323	\$340	
24 ½	13	1 ⅜	11	1	40C2513TH	\$320	\$336	
24 ½	12	1 ⅜	10	1	40C2512TH	\$318	\$334	

• 3mm front edge, 1mm side and back edges

Specify: Model | Worksurface Laminate | Edge Finish

Model	Worksurface Laminate	Edge Finish
	see Forge Laminate Finishes	see Forge Edge Finishes (when applicable)

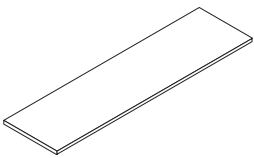
Description	D	W	H	CTN WT	CU FT	① Model	Tier 1	Tier 2
19½" d HPL Worksurfaces 	19 ½	120	1 ⅜	84	5	40C20120TH	\$820	\$861
	19 ½	119	1 ⅜	83	5	40C20119TH	\$815	\$856
	19 ½	118	1 ⅜	83	5	40C20118TH	\$810	\$851
	19 ½	117	1 ⅜	82	5	40C20117TH	\$805	\$846
	19 ½	116	1 ⅜	81	5	40C20116TH	\$800	\$840
	19 ½	115	1 ⅜	81	5	40C20115TH	\$796	\$836
	19 ½	114	1 ⅜	80	5	40C20114TH	\$792	\$832
	19 ½	113	1 ⅜	79	5	40C20113TH	\$788	\$828
	19 ½	112	1 ⅜	78	5	40C20112TH	\$784	\$824
	19 ½	111	1 ⅜	78	5	40C20111TH	\$780	\$819
	19 ½	110	1 ⅜	77	5	40C20110TH	\$776	\$815
	19 ½	109	1 ⅜	76	5	40C20109TH	\$772	\$811
	19 ½	108	1 ⅜	76	5	40C20108TH	\$768	\$807
	19 ½	107	1 ⅜	75	5	40C20107TH	\$763	\$802
	19 ½	106	1 ⅜	74	5	40C20106TH	\$758	\$796
	19 ½	105	1 ⅜	74	5	40C20105TH	\$753	\$791
	19 ½	104	1 ⅜	73	5	40C20104TH	\$747	\$785
	19 ½	103	1 ⅜	72	5	40C20103TH	\$741	\$779
	19 ½	102	1 ⅜	71	5	40C20102TH	\$735	\$772
	19 ½	101	1 ⅜	71	5	40C20101TH	\$727	\$764
	19 ½	100	1 ⅜	70	5	40C20100TH	\$721	\$758
	19 ½	99	1 ⅜	69	5	40C2099TH	\$715	\$751
	19 ½	98	1 ⅜	69	4	40C2098TH	\$709	\$745
	19 ½	97	1 ⅜	68	4	40C2097TH	\$703	\$739
	19 ½	96	1 ⅜	67	4	40C2096TH	\$697	\$732
	19 ½	95	1 ⅜	67	4	40C2095TH	\$687	\$722
	19 ½	94	1 ⅜	66	4	40C2094TH	\$677	\$711
	19 ½	93	1 ⅜	65	4	40C2093TH	\$667	\$701
	19 ½	92	1 ⅜	64	4	40C2092TH	\$658	\$691
	19 ½	91	1 ⅜	64	4	40C2091TH	\$649	\$682
	19 ½	90	1 ⅜	63	4	40C2090TH	\$642	\$675
	19 ½	89	1 ⅜	62	4	40C2089TH	\$633	\$665
19 ½	88	1 ⅜	62	4	40C2088TH	\$624	\$656	
19 ½	87	1 ⅜	61	4	40C2087TH	\$615	\$646	
19 ½	86	1 ⅜	60	4	40C2086TH	\$606	\$637	
19 ½	85	1 ⅜	60	4	40C2085TH	\$597	\$627	

• 3mm front edge, 1mm side and back edges

Specify: Model | Worksurface Laminate | Edge Finish

Model	Worksurface Laminate	Edge Finish
	see Forge Laminate Finishes	see Forge Edge Finishes (when applicable)

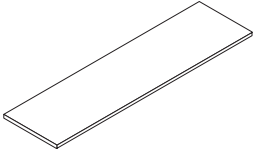
Description	D	W	H	CTN WT	CU FT	① Model	Tier 1	Tier 2
19½" d HPL Worksurfaces (continued) 	19 ½	84	1 ⅜	59	4	40C2084TH	\$588	\$618
	19 ½	83	1 ⅜	58	4	40C2083TH	\$582	\$612
	19 ½	82	1 ⅜	57	4	40C2082TH	\$576	\$605
	19 ½	81	1 ⅜	57	4	40C2081TH	\$571	\$600
	19 ½	80	1 ⅜	56	4	40C2080TH	\$566	\$595
	19 ½	79	1 ⅜	55	4	40C2079TH	\$561	\$590
	19 ½	78	1 ⅜	55	4	40C2078TH	\$556	\$584
	19 ½	77	1 ⅜	54	4	40C2077TH	\$551	\$579
	19 ½	76	1 ⅜	53	4	40C2076TH	\$545	\$573
	19 ½	75	1 ⅜	53	4	40C2075TH	\$539	\$566
	19 ½	74	1 ⅜	52	4	40C2074TH	\$532	\$559
	19 ½	73	1 ⅜	51	3	40C2073TH	\$524	\$551
	19 ½	72	1 ⅜	50	3	40C2072TH	\$518	\$544
	19 ½	71	1 ⅜	50	3	40C2071TH	\$513	\$539
	19 ½	70	1 ⅜	49	3	40C2070TH	\$509	\$535
	19 ½	69	1 ⅜	48	3	40C2069TH	\$504	\$530
	19 ½	68	1 ⅜	48	3	40C2068TH	\$499	\$524
	19 ½	67	1 ⅜	47	3	40C2067TH	\$493	\$518
	19 ½	66	1 ⅜	46	3	40C2066TH	\$486	\$511
	19 ½	65	1 ⅜	46	3	40C2065TH	\$480	\$504
	19 ½	64	1 ⅜	45	3	40C2064TH	\$472	\$496
	19 ½	63	1 ⅜	44	3	40C2063TH	\$466	\$490
	19 ½	62	1 ⅜	43	3	40C2062TH	\$459	\$482
	19 ½	61	1 ⅜	43	3	40C2061TH	\$452	\$475
	19 ½	60	1 ⅜	42	3	40C2060TH	\$446	\$469
	19 ½	59	1 ⅜	41	3	40C2059TH	\$439	\$461
	19 ½	58	1 ⅜	41	3	40C2058TH	\$432	\$454
	19 ½	57	1 ⅜	40	3	40C2057TH	\$425	\$447
	19 ½	56	1 ⅜	39	3	40C2056TH	\$419	\$440
	19 ½	55	1 ⅜	39	3	40C2055TH	\$412	\$433
	19 ½	54	1 ⅜	38	3	40C2054TH	\$405	\$426
	19 ½	53	1 ⅜	37	3	40C2053TH	\$402	\$423
	19 ½	52	1 ⅜	36	3	40C2052TH	\$399	\$419
19 ½	51	1 ⅜	36	3	40C2051TH	\$396	\$416	
19 ½	50	1 ⅜	35	3	40C2050TH	\$393	\$413	
19 ½	49	1 ⅜	34	3	40C2049TH	\$390	\$410	

• 3mm front edge, 1mm side and back edges

Specify: Model | Worksurface Laminate | Edge Finish

Model	Worksurface Laminate	Edge Finish
	see Forge Laminate Finishes	see Forge Edge Finishes (when applicable)

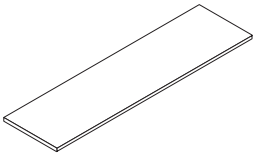
Description	D	W	H	CTN WT	CU FT	① Model	Tier 1	Tier 2
19½" d HPL Worksurfaces (continued) 	19 ½	48	1 ⅜	34	2	40C2048TH	\$387	\$407
	19 ½	47	1 ⅜	33	2	40C2047TH	\$384	\$404
	19 ½	46	1 ⅜	32	2	40C2046TH	\$382	\$402
	19 ½	45	1 ⅜	32	2	40C2045TH	\$379	\$398
	19 ½	44	1 ⅜	31	2	40C2044TH	\$377	\$396
	19 ½	43	1 ⅜	30	2	40C2043TH	\$375	\$394
	19 ½	42	1 ⅜	29	2	40C2042TH	\$373	\$392
	19 ½	41	1 ⅜	29	2	40C2041TH	\$369	\$388
	19 ½	40	1 ⅜	28	2	40C2040TH	\$366	\$385
	19 ½	39	1 ⅜	27	2	40C2039TH	\$362	\$381
	19 ½	38	1 ⅜	27	2	40C2038TH	\$359	\$377
	19 ½	37	1 ⅜	26	2	40C2037TH	\$356	\$374
	19 ½	36	1 ⅜	25	2	40C2036TH	\$353	\$371
	19 ½	35	1 ⅜	25	2	40C2035TH	\$350	\$368
	19 ½	34	1 ⅜	24	2	40C2034TH	\$347	\$365
	19 ½	33	1 ⅜	23	2	40C2033TH	\$344	\$362
	19 ½	32	1 ⅜	22	2	40C2032TH	\$341	\$359
	19 ½	31	1 ⅜	22	2	40C2031TH	\$338	\$355
	19 ½	30	1 ⅜	21	2	40C2030TH	\$335	\$352
	19 ½	29	1 ⅜	20	2	40C2029TH	\$332	\$349
	19 ½	28	1 ⅜	20	2	40C2028TH	\$328	\$345
	19 ½	27	1 ⅜	19	2	40C2027TH	\$324	\$341
	19 ½	26	1 ⅜	18	2	40C2026TH	\$321	\$338
	19 ½	25	1 ⅜	18	2	40C2025TH	\$318	\$334
	19 ½	24	1 ⅜	17	2	40C2024TH	\$315	\$331
	19 ½	23	1 ⅜	16	1	40C2023TH	\$312	\$328
	19 ½	22	1 ⅜	15	1	40C2022TH	\$309	\$325
	19 ½	21	1 ⅜	15	1	40C2021TH	\$307	\$323
	19 ½	20	1 ⅜	14	1	40C2020TH	\$304	\$320
	19 ½	19	1 ⅜	13	1	40C2019TH	\$302	\$318
	19 ½	18	1 ⅜	13	1	40C2018TH	\$300	\$315
	19 ½	17	1 ⅜	12	1	40C2017TH	\$297	\$312
	19 ½	16	1 ⅜	11	1	40C2016TH	\$294	\$309
	19 ½	15	1 ⅜	11	1	40C2015TH	\$290	\$305
19 ½	14	1 ⅜	10	1	40C2014TH	\$287	\$302	
19 ½	13	1 ⅜	9	1	40C2013TH	\$284	\$299	
19 ½	12	1 ⅜	8	1	40C2012TH	\$280	\$294	

• 3mm front edge, 1mm side and back edges

Specify: Model | Worksurface Laminate | Edge Finish

Model	Worksurface Laminate	Edge Finish
	see Forge Laminate Finishes	see Forge Edge Finishes (when applicable)

Description	D	W	H	CTN WT	CU FT	① Model	Tier 1	Tier 2
HPL Corner Worksurfaces	24 ½	29	1 ⅝	35	2	40C2929CTWH	\$579	\$608
	24 ½	24	1 ⅝	24	2	40C2424CTWH	\$545	\$573

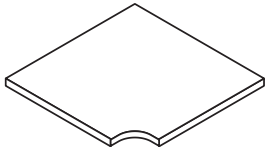

- 3mm front edge, 1mm side and back edges
- brackets must be specified separately, [see page 69](#)

Specify: Model | Worksurface Laminate | Edge Finish

Model	Worksurface Laminate	Edge Finish
	see Forge Laminate Finishes	see Forge Edge Finishes (when applicable)

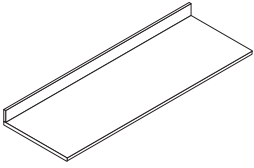
Description	D	W	H	CTN WT	CU FT	① Model	Tier 1	Tier 2
24½" d HPL Worksurfaces with Backsplash 	24 ½	120	5 ⅜	116	14	40C25120TWBH	\$1,130	\$1,187
	24 ½	119	5 ⅜	115	14	40C25119TWBH	\$1,120	\$1,176
	24 ½	118	5 ⅜	114	14	40C25118TWBH	\$1,110	\$1,166
	24 ½	117	5 ⅜	113	14	40C25117TWBH	\$1,100	\$1,155
	24 ½	116	5 ⅜	112	14	40C25116TWBH	\$1,096	\$1,151
	24 ½	115	5 ⅜	111	14	40C25115TWBH	\$1,092	\$1,147
	24 ½	114	5 ⅜	110	14	40C25114TWBH	\$1,088	\$1,143
	24 ½	113	5 ⅜	109	14	40C25113TWBH	\$1,085	\$1,140
	24 ½	112	5 ⅜	108	14	40C25112TWBH	\$1,082	\$1,137
	24 ½	111	5 ⅜	107	13	40C25111TWBH	\$1,076	\$1,130
	24 ½	110	5 ⅜	106	13	40C25110TWBH	\$1,070	\$1,124
	24 ½	109	5 ⅜	105	13	40C25109TWBH	\$1,064	\$1,118
	24 ½	108	5 ⅜	104	13	40C25108TWBH	\$1,058	\$1,111
	24 ½	107	5 ⅜	103	13	40C25107TWBH	\$1,045	\$1,098
	24 ½	106	5 ⅜	102	13	40C25106TWBH	\$1,038	\$1,090
	24 ½	105	5 ⅜	101	13	40C25105TWBH	\$1,031	\$1,083
	24 ½	104	5 ⅜	100	13	40C25104TWBH	\$1,024	\$1,076
	24 ½	103	5 ⅜	99	13	40C25103TWBH	\$1,017	\$1,068
	24 ½	102	5 ⅜	98	12	40C25102TWBH	\$1,010	\$1,061
	24 ½	101	5 ⅜	97	12	40C25101TWBH	\$1,005	\$1,056
	24 ½	100	5 ⅜	97	12	40C25100TWBH	\$999	\$1,049
	24 ½	99	5 ⅜	96	12	40C2599TWBH	\$993	\$1,043
	24 ½	98	5 ⅜	95	12	40C2598TWBH	\$987	\$1,037
	24 ½	97	5 ⅜	94	12	40C2597TWBH	\$981	\$1,031
	24 ½	96	5 ⅜	93	12	40C2596TWBH	\$975	\$1,024
	24 ½	95	5 ⅜	92	12	40C2595TWBH	\$965	\$1,014
	24 ½	94	5 ⅜	91	11	40C2594TWBH	\$963	\$1,012
	24 ½	93	5 ⅜	90	11	40C2593TWBH	\$949	\$997
	24 ½	92	5 ⅜	89	11	40C2592TWBH	\$935	\$982
	24 ½	91	5 ⅜	88	11	40C2591TWBH	\$921	\$968
	24 ½	90	5 ⅜	87	11	40C2590TWBH	\$907	\$953
	24 ½	89	5 ⅜	86	11	40C2589TWBH	\$926	\$973
24 ½	88	5 ⅜	85	11	40C2588TWBH	\$912	\$958	
24 ½	87	5 ⅜	84	11	40C2587TWBH	\$898	\$943	
24 ½	86	5 ⅜	83	11	40C2586TWBH	\$884	\$929	
24 ½	85	5 ⅜	82	10	40C2585TWBH	\$870	\$914	

- 3mm front edge, 1mm side and back edges
- requires backsplash seams to be sealed in the field

Specify: Model | Worksurface Laminate | Edge Finish

Model	Worksurface Laminate	Edge Finish
	see Forge Laminate Finishes	see Forge Edge Finishes (when applicable)

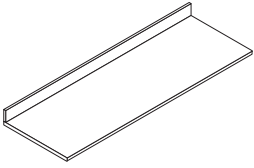
Description	D	W	H	CTN WT	CU FT	① Model	Tier 1	Tier 2
24½" d HPL Worksurfaces with Backsplash (continued) 	24 ½	84	5 ⅜	81	10	40C2584TWBH	\$856	\$899
	24 ½	83	5 ⅜	80	10	40C2583TWBH	\$916	\$962
	24 ½	82	5 ⅜	79	10	40C2582TWBH	\$902	\$948
	24 ½	81	5 ⅜	78	10	40C2581TWBH	\$888	\$933
	24 ½	80	5 ⅜	77	10	40C2580TWBH	\$875	\$919
	24 ½	79	5 ⅜	76	10	40C2579TWBH	\$861	\$905
	24 ½	78	5 ⅜	75	10	40C2578TWBH	\$848	\$891
	24 ½	77	5 ⅜	74	10	40C2577TWBH	\$834	\$876
	24 ½	76	5 ⅜	73	9	40C2576TWBH	\$820	\$861
	24 ½	75	5 ⅜	72	9	40C2575TWBH	\$789	\$829
	24 ½	74	5 ⅜	71	9	40C2574TWBH	\$786	\$826
	24 ½	73	5 ⅜	70	9	40C2573TWBH	\$783	\$823
	24 ½	72	5 ⅜	69	9	40C2572TWBH	\$780	\$819
	24 ½	71	5 ⅜	68	9	40C2571TWBH	\$809	\$850
	24 ½	70	5 ⅜	68	9	40C2570TWBH	\$799	\$839
	24 ½	69	5 ⅜	67	9	40C2569TWBH	\$789	\$829
	24 ½	68	5 ⅜	66	9	40C2568TWBH	\$779	\$818
	24 ½	67	5 ⅜	65	8	40C2567TWBH	\$769	\$808
	24 ½	66	5 ⅜	64	8	40C2566TWBH	\$759	\$797
	24 ½	65	5 ⅜	63	8	40C2565TWBH	\$748	\$786
	24 ½	64	5 ⅜	62	8	40C2564TWBH	\$738	\$775
	24 ½	63	5 ⅜	61	8	40C2563TWBH	\$728	\$765
	24 ½	62	5 ⅜	60	8	40C2562TWBH	\$717	\$753
	24 ½	61	5 ⅜	59	8	40C2561TWBH	\$707	\$743
	24 ½	60	5 ⅜	58	8	40C2560TWBH	\$697	\$732
	24 ½	59	5 ⅜	57	7	40C2559TWBH	\$718	\$754
	24 ½	58	5 ⅜	56	7	40C2558TWBH	\$709	\$745
	24 ½	57	5 ⅜	55	7	40C2557TWBH	\$700	\$735
	24 ½	56	5 ⅜	54	7	40C2556TWBH	\$690	\$725
	24 ½	55	5 ⅜	53	7	40C2555TWBH	\$681	\$716
	24 ½	54	5 ⅜	52	7	40C2554TWBH	\$672	\$706
	24 ½	53	5 ⅜	51	7	40C2553TWBH	\$665	\$699
24 ½	52	5 ⅜	50	7	40C2552TWBH	\$657	\$690	
24 ½	51	5 ⅜	49	7	40C2551TWBH	\$649	\$682	
24 ½	50	5 ⅜	48	6	40C2550TWBH	\$641	\$674	
24 ½	49	5 ⅜	47	6	40C2549TWBH	\$633	\$665	

- 3mm front edge, 1mm side and back edges
- requires backsplash seams to be sealed in the field

Specify: Model | Worksurface Laminate | Edge Finish

Model	Worksurface Laminate	Edge Finish
	see Forge Laminate Finishes	see Forge Edge Finishes (when applicable)

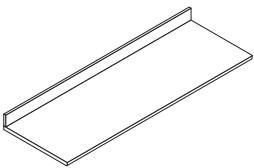
Description	D	W	H	CTN WT	CU FT	① Model	Tier 1	Tier 2
24½" d HPL Worksurfaces with Backsplash (continued) 	24 ½	48	5 ⅜	46	6	40C2548TWBH	\$625	\$657
	24 ½	47	5 ⅜	45	6	40C2547TWBH	\$588	\$618
	24 ½	46	5 ⅜	44	6	40C2546TWBH	\$586	\$616
	24 ½	45	5 ⅜	43	6	40C2545TWBH	\$585	\$615
	24 ½	44	5 ⅜	42	6	40C2544TWBH	\$584	\$614
	24 ½	43	5 ⅜	41	6	40C2543TWBH	\$582	\$612
	24 ½	42	5 ⅜	40	6	40C2542TWBH	\$580	\$609
	24 ½	41	5 ⅜	39	5	40C2541TWBH	\$530	\$557
	24 ½	40	5 ⅜	39	5	40C2540TWBH	\$527	\$554
	24 ½	39	5 ⅜	38	5	40C2539TWBH	\$524	\$551
	24 ½	38	5 ⅜	37	5	40C2538TWBH	\$521	\$548
	24 ½	37	5 ⅜	36	5	40C2537TWBH	\$518	\$544
	24 ½	36	5 ⅜	35	5	40C2536TWBH	\$515	\$541
	24 ½	35	5 ⅜	34	5	40C2535TWBH	\$512	\$538
	24 ½	34	5 ⅜	33	5	40C2534TWBH	\$509	\$535
	24 ½	33	5 ⅜	32	4	40C2533TWBH	\$506	\$532
	24 ½	32	5 ⅜	31	4	40C2532TWBH	\$481	\$506
	24 ½	31	5 ⅜	30	4	40C2531TWBH	\$478	\$502
	24 ½	30	5 ⅜	29	4	40C2530TWBH	\$475	\$499
	24 ½	29	5 ⅜	28	4	40C2529TWBH	\$472	\$496
	24 ½	28	5 ⅜	27	4	40C2528TWBH	\$469	\$493
	24 ½	27	5 ⅜	26	4	40C2527TWBH	\$466	\$490
	24 ½	26	5 ⅜	25	4	40C2526TWBH	\$463	\$487
	24 ½	25	5 ⅜	24	4	40C2525TWBH	\$460	\$483
	24 ½	24	5 ⅜	23	3	40C2524TWBH	\$457	\$480
	24 ½	23	5 ⅜	22	3	40C2523TWBH	\$422	\$444
	24 ½	22	5 ⅜	21	3	40C2522TWBH	\$419	\$440
	24 ½	21	5 ⅜	20	3	40C2521TWBH	\$416	\$437
	24 ½	20	5 ⅜	19	3	40C2520TWBH	\$413	\$434
	24 ½	19	5 ⅜	18	3	40C2519TWBH	\$410	\$431
	24 ½	18	5 ⅜	17	3	40C2518TWBH	\$407	\$428
	24 ½	17	5 ⅜	16	3	40C2517TWBH	\$391	\$411
24 ½	16	5 ⅜	15	3	40C2516TWBH	\$388	\$408	
24 ½	15	5 ⅜	14	2	40C2515TWBH	\$385	\$405	
24 ½	14	5 ⅜	13	2	40C2514TWBH	\$382	\$402	
24 ½	13	5 ⅜	12	2	40C2513TWBH	\$379	\$398	
24 ½	12	5 ⅜	11	2	40C2512TWBH	\$376	\$395	

- 3mm front edge, 1mm side and back edges
- requires backsplash seams to be sealed in the field

Specify: Model | Worksurface Laminate | Edge Finish

Model	Worksurface Laminate	Edge Finish
	see Forge Laminate Finishes	see Forge Edge Finishes (when applicable)

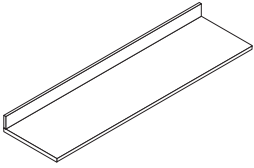
Description	D	W	H	CTN WT	CU FT	① Model	Tier 1	Tier 2
19½" d HPL Worksurfaces with Backsplash 	19 ½	120	5 ⅜	96	11	40C20120TWBH	\$978	\$1,027
	19 ½	119	5 ⅜	95	11	40C20119TWBH	\$944	\$992
	19 ½	118	5 ⅜	94	11	40C20118TWBH	\$936	\$983
	19 ½	117	5 ⅜	93	11	40C20117TWBH	\$928	\$975
	19 ½	116	5 ⅜	93	11	40C20116TWBH	\$925	\$972
	19 ½	115	5 ⅜	92	11	40C20115TWBH	\$922	\$969
	19 ½	114	5 ⅜	91	11	40C20114TWBH	\$919	\$965
	19 ½	113	5 ⅜	90	11	40C20113TWBH	\$916	\$962
	19 ½	112	5 ⅜	89	11	40C20112TWBH	\$914	\$960
	19 ½	111	5 ⅜	89	11	40C20111TWBH	\$912	\$958
	19 ½	110	5 ⅜	88	11	40C20110TWBH	\$909	\$955
	19 ½	109	5 ⅜	87	10	40C20109TWBH	\$907	\$953
	19 ½	108	5 ⅜	86	10	40C20108TWBH	\$905	\$951
	19 ½	107	5 ⅜	85	10	40C20107TWBH	\$903	\$948
	19 ½	106	5 ⅜	85	10	40C20106TWBH	\$899	\$944
	19 ½	105	5 ⅜	84	10	40C20105TWBH	\$890	\$935
	19 ½	104	5 ⅜	83	10	40C20104TWBH	\$882	\$927
	19 ½	103	5 ⅜	82	10	40C20103TWBH	\$873	\$917
	19 ½	102	5 ⅜	81	10	40C20102TWBH	\$865	\$909
	19 ½	101	5 ⅜	81	10	40C20101TWBH	\$853	\$896
	19 ½	100	5 ⅜	80	10	40C20100TWBH	\$845	\$888
	19 ½	99	5 ⅜	79	10	40C2099TWBH	\$846	\$889
	19 ½	98	5 ⅜	78	9	40C2098TWBH	\$838	\$880
	19 ½	97	5 ⅜	77	9	40C2097TWBH	\$830	\$872
	19 ½	96	5 ⅜	77	9	40C2096TWBH	\$822	\$864
	19 ½	95	5 ⅜	76	9	40C2095TWBH	\$824	\$866
	19 ½	94	5 ⅜	75	9	40C2094TWBH	\$816	\$857
	19 ½	93	5 ⅜	74	9	40C2093TWBH	\$808	\$849
	19 ½	92	5 ⅜	73	9	40C2092TWBH	\$800	\$840
	19 ½	91	5 ⅜	73	9	40C2091TWBH	\$792	\$832
	19 ½	90	5 ⅜	72	9	40C2090TWBH	\$784	\$824
	19 ½	89	5 ⅜	71	9	40C2089TWBH	\$777	\$816
	19 ½	88	5 ⅜	70	9	40C2088TWBH	\$769	\$808
19 ½	87	5 ⅜	69	8	40C2087TWBH	\$761	\$800	
19 ½	86	5 ⅜	69	8	40C2086TWBH	\$754	\$792	
19 ½	85	5 ⅜	68	8	40C2085TWBH	\$746	\$784	

- 3mm front edge, 1mm side and back edges
- requires backsplash seams to be sealed in the field

Specify: Model | Worksurface Laminate | Edge Finish

Model	Worksurface Laminate	Edge Finish
	see Forge Laminate Finishes	see Forge Edge Finishes (when applicable)

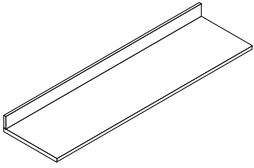
Description	D	W	H	CTN WT	CU FT	① Model	Tier 1	Tier 2
19½" d HPL Worksurfaces with Backsplash (continued) 	19 ½	84	5 ⅜	67	8	40C2084TWBH	\$738	\$775
	19 ½	83	5 ⅜	66	8	40C2083TWBH	\$733	\$770
	19 ½	82	5 ⅜	65	8	40C2082TWBH	\$727	\$764
	19 ½	81	5 ⅜	65	8	40C2081TWBH	\$721	\$758
	19 ½	80	5 ⅜	64	8	40C2080TWBH	\$715	\$751
	19 ½	79	5 ⅜	63	8	40C2079TWBH	\$709	\$745
	19 ½	78	5 ⅜	62	8	40C2078TWBH	\$703	\$739
	19 ½	77	5 ⅜	61	8	40C2077TWBH	\$700	\$735
	19 ½	76	5 ⅜	61	7	40C2076TWBH	\$691	\$726
	19 ½	75	5 ⅜	60	7	40C2075TWBH	\$682	\$717
	19 ½	74	5 ⅜	59	7	40C2074TWBH	\$673	\$707
	19 ½	73	5 ⅜	58	7	40C2073TWBH	\$664	\$698
	19 ½	72	5 ⅜	57	7	40C2072TWBH	\$655	\$688
	19 ½	71	5 ⅜	57	7	40C2071TWBH	\$682	\$717
	19 ½	70	5 ⅜	56	7	40C2070TWBH	\$672	\$706
	19 ½	69	5 ⅜	55	7	40C2069TWBH	\$662	\$696
	19 ½	68	5 ⅜	54	7	40C2068TWBH	\$652	\$685
	19 ½	67	5 ⅜	53	7	40C2067TWBH	\$642	\$675
	19 ½	66	5 ⅜	53	7	40C2066TWBH	\$632	\$664
	19 ½	65	5 ⅜	52	6	40C2065TWBH	\$622	\$654
	19 ½	64	5 ⅜	51	6	40C2064TWBH	\$612	\$643
	19 ½	63	5 ⅜	50	6	40C2063TWBH	\$602	\$633
	19 ½	62	5 ⅜	49	6	40C2062TWBH	\$592	\$622
	19 ½	61	5 ⅜	49	6	40C2061TWBH	\$586	\$616
	19 ½	60	5 ⅜	48	6	40C2060TWBH	\$581	\$611
	19 ½	59	5 ⅜	47	6	40C2059TWBH	\$576	\$605
	19 ½	58	5 ⅜	46	6	40C2058TWBH	\$570	\$599
	19 ½	57	5 ⅜	45	6	40C2057TWBH	\$565	\$594
	19 ½	56	5 ⅜	45	6	40C2056TWBH	\$560	\$588
	19 ½	55	5 ⅜	44	6	40C2055TWBH	\$552	\$580
	19 ½	54	5 ⅜	43	6	40C2054TWBH	\$545	\$573
	19 ½	53	5 ⅜	42	5	40C2053TWBH	\$540	\$567
19 ½	52	5 ⅜	41	5	40C2052TWBH	\$535	\$562	
19 ½	51	5 ⅜	41	5	40C2051TWBH	\$531	\$558	
19 ½	50	5 ⅜	40	5	40C2050TWBH	\$527	\$554	
19 ½	49	5 ⅜	39	5	40C2049TWBH	\$522	\$549	

- 3mm front edge, 1mm side and back edges
- requires backsplash seams to be sealed in the field

Specify: Model | Worksurface Laminate | Edge Finish

Model	Worksurface Laminate	Edge Finish
	see Forge Laminate Finishes	see Forge Edge Finishes (when applicable)

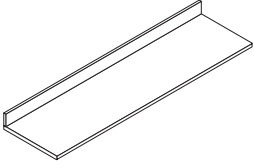
Description	D	W	H	CTN WT	CU FT	① Model	Tier 1	Tier 2
19½" d HPL Worksurfaces with Backsplash (continued) 	19 ½	48	5 ⅜	38	5	40C2048TWBH	\$517	\$543
	19 ½	47	5 ⅜	37	5	40C2047TWBH	\$515	\$541
	19 ½	46	5 ⅜	37	5	40C2046TWBH	\$512	\$538
	19 ½	45	5 ⅜	36	5	40C2045TWBH	\$509	\$535
	19 ½	44	5 ⅜	35	5	40C2044TWBH	\$507	\$533
	19 ½	43	5 ⅜	34	5	40C2043TWBH	\$504	\$530
	19 ½	42	5 ⅜	33	4	40C2042TWBH	\$501	\$527
	19 ½	41	5 ⅜	33	4	40C2041TWBH	\$496	\$521
	19 ½	40	5 ⅜	32	4	40C2040TWBH	\$492	\$517
	19 ½	39	5 ⅜	31	4	40C2039TWBH	\$488	\$513
	19 ½	38	5 ⅜	30	4	40C2038TWBH	\$484	\$509
	19 ½	37	5 ⅜	29	4	40C2037TWBH	\$480	\$504
	19 ½	36	5 ⅜	29	4	40C2036TWBH	\$476	\$500
	19 ½	35	5 ⅜	28	4	40C2035TWBH	\$471	\$495
	19 ½	34	5 ⅜	27	4	40C2034TWBH	\$467	\$491
	19 ½	33	5 ⅜	26	4	40C2033TWBH	\$463	\$487
	19 ½	32	5 ⅜	25	4	40C2032TWBH	\$459	\$482
	19 ½	31	5 ⅜	25	3	40C2031TWBH	\$455	\$478
	19 ½	30	5 ⅜	24	3	40C2030TWBH	\$451	\$474
	19 ½	29	5 ⅜	23	3	40C2029TWBH	\$445	\$468
	19 ½	28	5 ⅜	22	3	40C2028TWBH	\$440	\$462
	19 ½	27	5 ⅜	21	3	40C2027TWBH	\$435	\$457
	19 ½	26	5 ⅜	21	3	40C2026TWBH	\$430	\$452
	19 ½	25	5 ⅜	20	3	40C2025TWBH	\$425	\$447
	19 ½	24	5 ⅜	19	3	40C2024TWBH	\$420	\$441
	19 ½	23	5 ⅜	18	3	40C2023TWBH	\$412	\$433
	19 ½	22	5 ⅜	17	3	40C2022TWBH	\$404	\$425
	19 ½	21	5 ⅜	17	3	40C2021TWBH	\$396	\$416
	19 ½	20	5 ⅜	16	2	40C2020TWBH	\$388	\$408
	19 ½	19	5 ⅜	15	2	40C2019TWBH	\$380	\$399
	19 ½	18	5 ⅜	14	2	40C2018TWBH	\$372	\$391
	19 ½	17	5 ⅜	13	2	40C2017TWBH	\$368	\$387
	19 ½	16	5 ⅜	13	2	40C2016TWBH	\$364	\$383
19 ½	15	5 ⅜	12	2	40C2015TWBH	\$360	\$378	
19 ½	14	5 ⅜	11	2	40C2014TWBH	\$355	\$373	
19 ½	13	5 ⅜	10	2	40C2013TWBH	\$351	\$369	
19 ½	12	5 ⅜	9	2	40C2012TWBH	\$347	\$365	

- 3mm front edge, 1mm side and back edges
- requires backsplash seams to be sealed in the field

Specify: Model | Worksurface Laminate | Edge Finish

Model	Worksurface Laminate	Edge Finish
	see Forge Laminate Finishes	see Forge Edge Finishes (when applicable)

Description	D	W	H	CTN WT	CU FT	① Model	Tier 1	Tier 2
HPL Corner Worksurface with Backsplash	24 1/2	29	5 3/6	42	4	40C2929CTWHBS	\$690	\$725
	19 1/2	24	5 3/6	30	3	40C2424CTWHBS	\$650	\$683

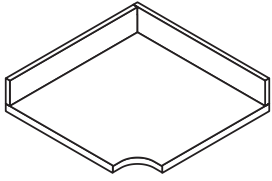

- requires backsplash seams to be sealed in the field
- brackets must be specified separately, [see page 69](#)

Specify: Model | Worksurface Laminate | Edge Finish

HPL Side Splash	3/4	23 3/8	4	2	1	40C123SSH	\$99	\$104
	3/4	18 3/8	4	2	1	40C118SSH	\$97	\$102

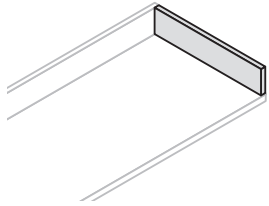

Specify: Model | Worksurface Laminate

HPL Side Splash Flush with Storage Cabinets	3/4	22 1/2	4	2	1	40C123SSFH	\$94	\$99
	3/4	17 1/2	4	2	1	40C118SSFH	\$92	\$97

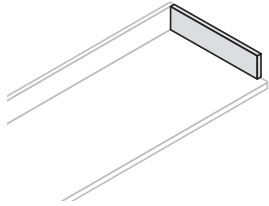

- aligns flush with storage cabinet chassis

Specify: Model | Worksurface Laminate

Model	Worksurface Laminate	Edge Finish
	see Forge Laminate Finishes	see Forge Edge Finishes (when applicable)

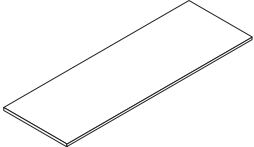
Description	D	W	H	CTN WT	CU FT	① Model	Tier 1	Tier 2	Tier 3	Tier 4
24½" d Solid Surface Worksurfaces 	24 ½	120	1	137	6	40C25120TS	\$4,001	\$4,441	\$5,201	\$6,402
	24 ½	119	1	136	6	40C25119TS	\$3,971	\$4,407	\$5,162	\$6,353
	24 ½	118	1	135	6	40C25118TS	\$3,942	\$4,375	\$5,124	\$6,306
	24 ½	117	1	134	6	40C25117TS	\$3,912	\$4,342	\$5,085	\$6,258
	24 ½	116	1	132	6	40C25116TS	\$3,882	\$4,308	\$5,046	\$6,210
	24 ½	115	1	131	6	40C25115TS	\$3,853	\$4,276	\$5,008	\$6,164
	24 ½	114	1	130	6	40C25114TS	\$3,824	\$4,244	\$4,971	\$6,118
	24 ½	113	1	129	6	40C25113TS	\$3,779	\$4,194	\$4,912	\$6,046
	24 ½	112	1	128	6	40C25112TS	\$3,733	\$4,143	\$4,852	\$5,972
	24 ½	111	1	127	6	40C25111TS	\$3,707	\$4,114	\$4,818	\$5,930
	24 ½	110	1	126	6	40C25110TS	\$3,682	\$4,086	\$4,786	\$5,890
	24 ½	109	1	125	6	40C25109TS	\$3,657	\$4,059	\$4,753	\$5,850
	24 ½	108	1	123	6	40C25108TS	\$3,632	\$4,031	\$4,721	\$5,810
	24 ½	107	1	122	6	40C25107TS	\$3,607	\$4,003	\$4,688	\$5,770
	24 ½	106	1	121	5	40C25106TS	\$3,582	\$3,975	\$4,656	\$5,730
	24 ½	105	1	120	5	40C25105TS	\$3,557	\$3,948	\$4,623	\$5,690
	24 ½	104	1	119	5	40C25104TS	\$3,532	\$3,920	\$4,591	\$5,650
	24 ½	103	1	118	5	40C25103TS	\$3,476	\$3,858	\$4,519	\$5,562
	24 ½	102	1	117	5	40C25102TS	\$3,420	\$3,796	\$4,446	\$5,472
	24 ½	101	1	116	5	40C25101TS	\$3,364	\$3,734	\$4,373	\$5,382
	24 ½	100	1	114	5	40C25100TS	\$3,308	\$3,672	\$4,300	\$5,293
	24 ½	99	1	113	5	40C2599TS	\$3,279	\$3,639	\$4,262	\$5,246
	24 ½	98	1	112	5	40C2598TS	\$3,251	\$3,608	\$4,226	\$5,201
	24 ½	97	1	111	5	40C2597TS	\$3,223	\$3,577	\$4,189	\$5,156
	24 ½	96	1	110	5	40C2596TS	\$3,195	\$3,546	\$4,153	\$5,111
	24 ½	95	1	109	5	40C2595TS	\$3,157	\$3,504	\$4,103	\$5,050
	24 ½	94	1	108	5	40C2594TS	\$3,120	\$3,463	\$4,055	\$4,991
	24 ½	93	1	106	5	40C2593TS	\$3,083	\$3,422	\$4,007	\$4,932
	24 ½	92	1	105	5	40C2592TS	\$3,046	\$3,381	\$3,959	\$4,873
	24 ½	91	1	104	5	40C2591TS	\$3,009	\$3,339	\$3,911	\$4,814
	24 ½	90	1	103	5	40C2590TS	\$2,972	\$3,298	\$3,863	\$4,754
	24 ½	89	1	102	5	40C2589TS	\$2,934	\$3,256	\$3,814	\$4,694
24 ½	88	1	101	5	40C2588TS	\$2,897	\$3,215	\$3,765	\$4,634	
24 ½	87	1	100	5	40C2587TS	\$2,860	\$3,174	\$3,717	\$4,575	
24 ½	86	1	99	5	40C2586TS	\$2,823	\$3,133	\$3,669	\$4,516	
24 ½	85	1	97	4	40C2585TS	\$2,786	\$3,092	\$3,621	\$4,457	

• 3mm radius front edge, sides and back are flat

Specify: Model | Worksurface Solid Surface

Model	Worksurface Solid Surface
	see Forge Solid Surface Finishes

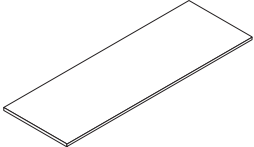
Description	D	W	H	CTN WT	CU FT	① Model	Tier 1	Tier 2	Tier 3	Tier 4
24½" d Solid Surface Worksurfaces (continued) 	24 ½	84	1	96	4	40C2584TS	\$2,749	\$3,051	\$3,573	\$4,398
	24 ½	83	1	95	4	40C2583TS	\$2,711	\$3,009	\$3,524	\$4,337
	24 ½	82	1	94	4	40C2582TS	\$2,674	\$2,968	\$3,476	\$4,278
	24 ½	81	1	93	4	40C2581TS	\$2,636	\$2,925	\$3,426	\$4,217
	24 ½	80	1	92	4	40C2580TS	\$2,599	\$2,884	\$3,378	\$4,158
	24 ½	79	1	91	4	40C2579TS	\$2,562	\$2,843	\$3,330	\$4,098
	24 ½	78	1	90	4	40C2578TS	\$2,525	\$2,802	\$3,282	\$4,039
	24 ½	77	1	88	4	40C2577TS	\$2,487	\$2,760	\$3,232	\$3,978
	24 ½	76	1	87	4	40C2576TS	\$2,450	\$2,719	\$3,184	\$3,919
	24 ½	75	1	86	4	40C2575TS	\$2,413	\$2,678	\$3,136	\$3,860
	24 ½	74	1	85	4	40C2574TS	\$2,375	\$2,636	\$3,087	\$3,799
	24 ½	73	1	84	4	40C2573TS	\$2,338	\$2,595	\$3,039	\$3,740
	24 ½	72	1	83	4	40C2572TS	\$2,301	\$2,554	\$2,991	\$3,681
	24 ½	71	1	82	4	40C2571TS	\$2,273	\$2,523	\$2,955	\$3,637
	24 ½	70	1	80	4	40C2570TS	\$2,244	\$2,491	\$2,917	\$3,590
	24 ½	69	1	79	4	40C2569TS	\$2,215	\$2,459	\$2,880	\$3,544
	24 ½	68	1	78	4	40C2568TS	\$2,186	\$2,426	\$2,842	\$3,498
	24 ½	67	1	77	4	40C2567TS	\$2,157	\$2,394	\$2,804	\$3,451
	24 ½	66	1	76	4	40C2566TS	\$2,128	\$2,362	\$2,766	\$3,405
	24 ½	65	1	75	4	40C2565TS	\$2,103	\$2,334	\$2,733	\$3,364
	24 ½	64	1	74	4	40C2564TS	\$2,077	\$2,305	\$2,699	\$3,322
	24 ½	63	1	73	3	40C2563TS	\$2,051	\$2,276	\$2,666	\$3,281
	24 ½	62	1	71	3	40C2562TS	\$2,025	\$2,247	\$2,632	\$3,239
	24 ½	61	1	70	3	40C2561TS	\$1,999	\$2,218	\$2,598	\$3,198
	24 ½	60	1	69	3	40C2560TS	\$1,973	\$2,189	\$2,564	\$3,156
	24 ½	59	1	68	3	40C2559TS	\$1,947	\$2,161	\$2,530	\$3,114
	24 ½	58	1	67	3	40C2558TS	\$1,921	\$2,132	\$2,497	\$3,073
	24 ½	57	1	66	3	40C2557TS	\$1,888	\$2,095	\$2,454	\$3,020
	24 ½	56	1	65	3	40C2556TS	\$1,856	\$2,060	\$2,412	\$2,969
	24 ½	55	1	64	3	40C2555TS	\$1,824	\$2,024	\$2,371	\$2,918
	24 ½	54	1	62	3	40C2554TS	\$1,792	\$1,989	\$2,329	\$2,866
	24 ½	53	1	61	3	40C2553TS	\$1,766	\$1,960	\$2,296	\$2,826
24 ½	52	1	60	3	40C2552TS	\$1,740	\$1,931	\$2,262	\$2,784	
24 ½	51	1	59	3	40C2551TS	\$1,715	\$1,904	\$2,230	\$2,744	
24 ½	50	1	58	3	40C2550TS	\$1,689	\$1,875	\$2,196	\$2,702	
24 ½	49	1	57	3	40C2549TS	\$1,664	\$1,847	\$2,163	\$2,662	

• 3mm radius front edge, sides and back are flat

Specify: Model | Worksurface Solid Surface

Model	Worksurface Solid Surface
	see Forge Solid Surface Finishes

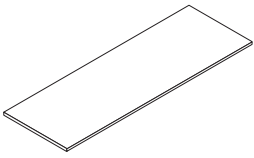
Description	D	W	H	CTN WT	CU FT	① Model	Tier 1	Tier 2	Tier 3	Tier 4
24½" d Solid Surface Worksurfaces (continued) 	24 ½	48	1	56	3	40C2548TS	\$1,639	\$1,819	\$2,131	\$2,622
	24 ½	47	1	55	3	40C2547TS	\$1,626	\$1,804	\$2,113	\$2,601
	24 ½	46	1	53	3	40C2546TS	\$1,613	\$1,790	\$2,096	\$2,580
	24 ½	45	1	52	3	40C2545TS	\$1,600	\$1,775	\$2,079	\$2,559
	24 ½	44	1	51	3	40C2544TS	\$1,587	\$1,761	\$2,062	\$2,538
	24 ½	43	1	50	3	40C2543TS	\$1,574	\$1,747	\$2,046	\$2,518
	24 ½	42	1	49	3	40C2542TS	\$1,561	\$1,732	\$2,029	\$2,497
	24 ½	41	1	48	2	40C2541TS	\$1,523	\$1,690	\$1,979	\$2,436
	24 ½	40	1	47	2	40C2540TS	\$1,486	\$1,649	\$1,931	\$2,377
	24 ½	39	1	45	2	40C2539TS	\$1,448	\$1,607	\$1,882	\$2,316
	24 ½	38	1	44	2	40C2538TS	\$1,411	\$1,566	\$1,834	\$2,257
	24 ½	37	1	43	2	40C2537TS	\$1,373	\$1,523	\$1,784	\$2,196
	24 ½	36	1	42	2	40C2536TS	\$1,336	\$1,482	\$1,736	\$2,137
	24 ½	35	1	41	2	40C2535TS	\$1,289	\$1,430	\$1,675	\$2,062
	24 ½	34	1	40	2	40C2534TS	\$1,242	\$1,378	\$1,614	\$1,986
	24 ½	33	1	39	2	40C2533TS	\$1,196	\$1,327	\$1,554	\$1,913
	24 ½	32	1	38	2	40C2532TS	\$1,149	\$1,275	\$1,493	\$1,838
	24 ½	31	1	36	2	40C2531TS	\$1,103	\$1,224	\$1,433	\$1,764
	24 ½	30	1	35	2	40C2530TS	\$1,057	\$1,173	\$1,373	\$1,690
	24 ½	29	1	34	2	40C2529TS	\$1,033	\$1,147	\$1,343	\$1,653
	24 ½	28	1	33	2	40C2528TS	\$1,011	\$1,122	\$1,314	\$1,618
	24 ½	27	1	32	2	40C2527TS	\$988	\$1,097	\$1,284	\$1,581
	24 ½	26	1	31	2	40C2526TS	\$966	\$1,072	\$1,256	\$1,546
	24 ½	25	1	30	2	40C2525TS	\$943	\$1,047	\$1,226	\$1,509
	24 ½	24	1	29	2	40C2524TS	\$921	\$1,022	\$1,197	\$1,474
	24 ½	23	1	27	2	40C2523TS	\$911	\$1,011	\$1,184	\$1,458
	24 ½	22	1	26	2	40C2522TS	\$901	\$1,000	\$1,171	\$1,441
	24 ½	21	1	25	2	40C2521TS	\$883	\$980	\$1,147	\$1,412
	24 ½	20	1	24	2	40C2520TS	\$865	\$960	\$1,124	\$1,383
	24 ½	19	1	23	1	40C2519TS	\$847	\$940	\$1,100	\$1,354
	24 ½	18	1	22	1	40C2518TS	\$829	\$920	\$1,077	\$1,326
	24 ½	17	1	21	1	40C2517TS	\$823	\$914	\$1,070	\$1,317
24 ½	16	1	19	1	40C2516TS	\$818	\$908	\$1,063	\$1,309	
24 ½	15	1	18	1	40C2515TS	\$813	\$902	\$1,057	\$1,301	
24 ½	14	1	17	1	40C2514TS	\$808	\$897	\$1,050	\$1,293	
24 ½	13	1	16	1	40C2513TS	\$803	\$891	\$1,044	\$1,285	
24 ½	12	1	15	1	40C2512TS	\$798	\$886	\$1,037	\$1,277	

• 3mm radius front edge, sides and back are flat

Specify: Model | Worksurface Solid Surface

Model | Worksurface Solid Surface

[see Forge Solid Surface Finishes](#)

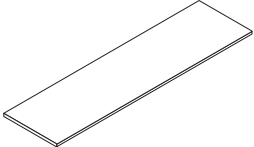
Description	D	W	H	CTN WT	CU FT	① Model	Tier 1	Tier 2	Tier 3	Tier 4
1 1/2" d Solid Surface Worksurfaces 	19 1/2	120	1	109	5	40C20120TS	\$3,132	\$3,477	\$4,072	\$5,011
	19 1/2	119	1	108	5	40C20119TS	\$3,104	\$3,445	\$4,035	\$4,966
	19 1/2	118	1	107	5	40C20118TS	\$3,077	\$3,415	\$3,999	\$4,922
	19 1/2	117	1	107	5	40C20117TS	\$3,050	\$3,385	\$3,964	\$4,879
	19 1/2	116	1	106	5	40C20116TS	\$3,022	\$3,354	\$3,928	\$4,834
	19 1/2	115	1	105	5	40C20115TS	\$2,995	\$3,324	\$3,893	\$4,791
	19 1/2	114	1	104	5	40C20114TS	\$2,968	\$3,294	\$3,858	\$4,748
	19 1/2	113	1	103	5	40C20113TS	\$2,922	\$3,243	\$3,799	\$4,675
	19 1/2	112	1	102	5	40C20112TS	\$2,876	\$3,192	\$3,739	\$4,602
	19 1/2	111	1	101	5	40C20111TS	\$2,849	\$3,162	\$3,704	\$4,558
	19 1/2	110	1	100	5	40C20110TS	\$2,824	\$3,135	\$3,671	\$4,518
	19 1/2	109	1	99	5	40C20109TS	\$2,799	\$3,107	\$3,639	\$4,478
	19 1/2	108	1	98	5	40C20108TS	\$2,774	\$3,079	\$3,606	\$4,438
	19 1/2	107	1	98	5	40C20107TS	\$2,748	\$3,050	\$3,572	\$4,397
	19 1/2	106	1	97	5	40C20106TS	\$2,723	\$3,023	\$3,540	\$4,357
	19 1/2	105	1	96	4	40C20105TS	\$2,698	\$2,995	\$3,507	\$4,317
	19 1/2	104	1	95	4	40C20104TS	\$2,672	\$2,966	\$3,474	\$4,275
	19 1/2	103	1	94	4	40C20103TS	\$2,639	\$2,929	\$3,430	\$4,222
	19 1/2	102	1	93	4	40C20102TS	\$2,607	\$2,893	\$3,388	\$4,170
	19 1/2	101	1	92	4	40C20101TS	\$2,575	\$2,858	\$3,347	\$4,119
	19 1/2	100	1	91	4	40C20100TS	\$2,543	\$2,822	\$3,305	\$4,068
	19 1/2	99	1	90	4	40C2099TS	\$2,529	\$2,807	\$3,288	\$4,046
	19 1/2	98	1	89	4	40C2098TS	\$2,515	\$2,792	\$3,270	\$4,024
	19 1/2	97	1	89	4	40C2097TS	\$2,501	\$2,776	\$3,251	\$4,002
	19 1/2	96	1	88	4	40C2096TS	\$2,487	\$2,761	\$3,233	\$3,979
	19 1/2	95	1	87	4	40C2095TS	\$2,461	\$2,731	\$3,199	\$3,937
	19 1/2	94	1	86	4	40C2094TS	\$2,434	\$2,701	\$3,164	\$3,894
	19 1/2	93	1	85	4	40C2093TS	\$2,407	\$2,671	\$3,128	\$3,850
	19 1/2	92	1	84	4	40C2092TS	\$2,380	\$2,641	\$3,093	\$3,807
	19 1/2	91	1	83	4	40C2091TS	\$2,353	\$2,611	\$3,058	\$3,764
	19 1/2	90	1	82	4	40C2090TS	\$2,326	\$2,581	\$3,023	\$3,721
	19 1/2	89	1	81	4	40C2089TS	\$2,299	\$2,551	\$2,988	\$3,678
19 1/2	88	1	80	4	40C2088TS	\$2,272	\$2,521	\$2,953	\$3,634	
19 1/2	87	1	80	4	40C2087TS	\$2,245	\$2,491	\$2,918	\$3,591	
19 1/2	86	1	79	4	40C2086TS	\$2,218	\$2,461	\$2,883	\$3,548	
19 1/2	85	1	78	4	40C2085TS	\$2,191	\$2,431	\$2,848	\$3,505	

• 3mm radius front edge, sides and back are flat

Specify: Model | Worksurface Solid Surface

Model	Worksurface Solid Surface
	see Forge Solid Surface Finishes

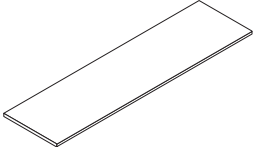
Description	D	W	H	CTN WT	CU FT	① Model	Tier 1	Tier 2	Tier 3	Tier 4
19½" d Solid Surface Worksurfaces (continued) 	19 ½	84	1	77	4	40C2084TS	\$2,164	\$2,401	\$2,813	\$3,462
	19 ½	83	1	76	4	40C2083TS	\$2,138	\$2,373	\$2,779	\$3,421
	19 ½	82	1	75	4	40C2082TS	\$2,113	\$2,345	\$2,747	\$3,381
	19 ½	81	1	74	4	40C2081TS	\$2,087	\$2,317	\$2,713	\$3,339
	19 ½	80	1	73	4	40C2080TS	\$2,062	\$2,289	\$2,681	\$3,299
	19 ½	79	1	72	4	40C2079TS	\$2,037	\$2,261	\$2,648	\$3,259
	19 ½	78	1	71	3	40C2078TS	\$2,012	\$2,233	\$2,616	\$3,219
	19 ½	77	1	71	3	40C2077TS	\$1,987	\$2,206	\$2,583	\$3,179
	19 ½	76	1	70	3	40C2076TS	\$1,962	\$2,178	\$2,551	\$3,139
	19 ½	75	1	69	3	40C2075TS	\$1,937	\$2,150	\$2,518	\$3,099
	19 ½	74	1	68	3	40C2074TS	\$1,912	\$2,122	\$2,486	\$3,059
	19 ½	73	1	67	3	40C2073TS	\$1,887	\$2,095	\$2,453	\$3,019
	19 ½	72	1	66	3	40C2072TS	\$1,862	\$2,067	\$2,421	\$2,979
	19 ½	71	1	65	3	40C2071TS	\$1,843	\$2,046	\$2,396	\$2,949
	19 ½	70	1	64	3	40C2070TS	\$1,823	\$2,024	\$2,370	\$2,917
	19 ½	69	1	63	3	40C2069TS	\$1,803	\$2,001	\$2,344	\$2,885
	19 ½	68	1	62	3	40C2068TS	\$1,783	\$1,979	\$2,318	\$2,853
	19 ½	67	1	62	3	40C2067TS	\$1,763	\$1,957	\$2,292	\$2,821
	19 ½	66	1	61	3	40C2066TS	\$1,743	\$1,935	\$2,266	\$2,789
	19 ½	65	1	60	3	40C2065TS	\$1,723	\$1,913	\$2,240	\$2,757
	19 ½	64	1	59	3	40C2064TS	\$1,703	\$1,890	\$2,214	\$2,725
	19 ½	63	1	58	3	40C2063TS	\$1,683	\$1,868	\$2,188	\$2,693
	19 ½	62	1	57	3	40C2062TS	\$1,663	\$1,846	\$2,162	\$2,661
	19 ½	61	1	56	3	40C2061TS	\$1,644	\$1,825	\$2,137	\$2,630
	19 ½	60	1	55	3	40C2060TS	\$1,624	\$1,803	\$2,111	\$2,598
	19 ½	59	1	54	3	40C2059TS	\$1,604	\$1,780	\$2,085	\$2,566
	19 ½	58	1	53	3	40C2058TS	\$1,584	\$1,758	\$2,059	\$2,534
	19 ½	57	1	53	3	40C2057TS	\$1,568	\$1,740	\$2,038	\$2,509
	19 ½	56	1	52	3	40C2056TS	\$1,553	\$1,724	\$2,019	\$2,485
	19 ½	55	1	51	3	40C2055TS	\$1,538	\$1,707	\$1,999	\$2,461
	19 ½	54	1	50	3	40C2054TS	\$1,522	\$1,689	\$1,979	\$2,435
	19 ½	53	1	49	3	40C2053TS	\$1,503	\$1,668	\$1,954	\$2,405
19 ½	52	1	48	3	40C2052TS	\$1,485	\$1,648	\$1,931	\$2,376	
19 ½	51	1	47	2	40C2051TS	\$1,466	\$1,627	\$1,906	\$2,346	
19 ½	50	1	46	2	40C2050TS	\$1,448	\$1,607	\$1,882	\$2,317	
19 ½	49	1	45	2	40C2049TS	\$1,429	\$1,586	\$1,858	\$2,286	

• 3mm radius front edge, sides and back are flat

Specify: Model | Worksurface Solid Surface

Model	Worksurface Solid Surface
	see Forge Solid Surface Finishes

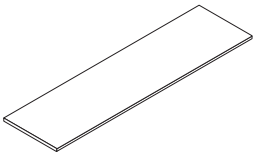
Description	D	W	H	CTN WT	CU FT	① Model	Tier 1	Tier 2	Tier 3	Tier 4
19½" d Solid Surface Worksurfaces (continued) 	19 ½	48	1	44	2	40C2048TS	\$1,411	\$1,566	\$1,834	\$2,258
	19 ½	47	1	44	2	40C2047TS	\$1,357	\$1,506	\$1,763	\$2,170
	19 ½	46	1	43	2	40C2046TS	\$1,304	\$1,447	\$1,695	\$2,086
	19 ½	45	1	42	2	40C2045TS	\$1,251	\$1,388	\$1,626	\$2,001
	19 ½	44	1	41	2	40C2044TS	\$1,198	\$1,329	\$1,557	\$1,916
	19 ½	43	1	40	2	40C2043TS	\$1,145	\$1,270	\$1,488	\$1,831
	19 ½	42	1	39	2	40C2042TS	\$1,092	\$1,212	\$1,419	\$1,746
	19 ½	41	1	38	2	40C2041TS	\$1,080	\$1,199	\$1,404	\$1,728
	19 ½	40	1	37	2	40C2040TS	\$1,069	\$1,187	\$1,390	\$1,710
	19 ½	39	1	36	2	40C2039TS	\$1,058	\$1,174	\$1,375	\$1,693
	19 ½	38	1	35	2	40C2038TS	\$1,046	\$1,161	\$1,360	\$1,674
	19 ½	37	1	35	2	40C2037TS	\$1,035	\$1,149	\$1,346	\$1,656
	19 ½	36	1	34	2	40C2036TS	\$1,023	\$1,136	\$1,330	\$1,637
	19 ½	35	1	33	2	40C2035TS	\$999	\$1,109	\$1,299	\$1,598
	19 ½	34	1	32	2	40C2034TS	\$976	\$1,083	\$1,269	\$1,562
	19 ½	33	1	31	2	40C2033TS	\$953	\$1,058	\$1,239	\$1,525
	19 ½	32	1	30	2	40C2032TS	\$930	\$1,032	\$1,209	\$1,488
	19 ½	31	1	29	2	40C2031TS	\$907	\$1,007	\$1,179	\$1,451
	19 ½	30	1	28	2	40C2030TS	\$884	\$981	\$1,149	\$1,414
	19 ½	29	1	27	2	40C2029TS	\$878	\$975	\$1,141	\$1,405
	19 ½	28	1	26	2	40C2028TS	\$873	\$969	\$1,135	\$1,397
	19 ½	27	1	26	2	40C2027TS	\$868	\$963	\$1,128	\$1,389
	19 ½	26	1	25	2	40C2026TS	\$863	\$958	\$1,122	\$1,381
	19 ½	25	1	24	2	40C2025TS	\$858	\$952	\$1,115	\$1,373
	19 ½	24	1	23	1	40C2024TS	\$853	\$947	\$1,109	\$1,365
	19 ½	23	1	22	1	40C2023TS	\$822	\$912	\$1,069	\$1,315
	19 ½	22	1	21	1	40C2022TS	\$791	\$878	\$1,028	\$1,266
	19 ½	21	1	20	1	40C2021TS	\$786	\$872	\$1,022	\$1,258
	19 ½	20	1	19	1	40C2020TS	\$781	\$867	\$1,015	\$1,250
	19 ½	19	1	18	1	40C2019TS	\$776	\$861	\$1,009	\$1,242
	19 ½	18	1	17	1	40C2018TS	\$771	\$855	\$1,002	\$1,233
	19 ½	17	1	17	1	40C2017TS	\$769	\$854	\$1,000	\$1,230
	19 ½	16	1	16	1	40C2016TS	\$767	\$851	\$997	\$1,227
19 ½	15	1	15	1	40C2015TS	\$765	\$849	\$995	\$1,224	
19 ½	14	1	14	1	40C2014TS	\$763	\$847	\$992	\$1,221	
19 ½	13	1	13	1	40C2013TS	\$761	\$845	\$989	\$1,218	
19 ½	12	1	12	1	40C2012TS	\$759	\$842	\$987	\$1,214	

• 3mm radius front edge, sides and back are flat

Specify: Model | Worksurface Solid Surface

Model Worksurface Solid Surface

[see Forge Solid Surface Finishes](#)

Description	D	W	H	CTN WT	CU FT	① Model	Tier 1	Tier 2	Tier 3	Tier 4
Solid Surface Corner Worksurfaces	29	29	1 3/16	35	2	40C2929CTS	\$1,549	\$1,719	\$2,014	\$2,478
	24	24	1 3/16	24	2	40C2424CTS	\$1,276	\$1,416	\$1,659	\$2,042

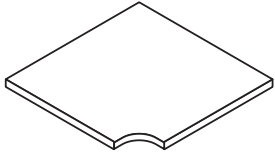

- 3mm radius front edge, sides and back are flat
- brackets must be specified separately, [see page 69](#)

Specify: Model | Worksurface Solid Surface

Model	Worksurface Solid Surface
	see Forge Solid Surface Finishes

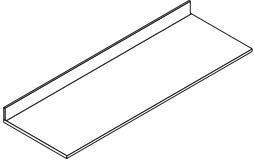
Description	D	W	H	CTN WT	CU FT	① Model	Tier 1	Tier 2	Tier 3	Tier 4
24½" d Solid Surface Worksurfaces with Integral Backsplash 	24 ½	120	5	153	14	40C25120TWBS	\$4,503	\$4,998	\$5,854	\$7,205
	24 ½	119	5	152	13	40C25119TWBS	\$4,466	\$4,957	\$5,806	\$7,146
	24 ½	118	5	151	13	40C25118TWBS	\$4,428	\$4,915	\$5,756	\$7,085
	24 ½	117	5	149	13	40C25117TWBS	\$4,390	\$4,873	\$5,707	\$7,024
	24 ½	116	5	148	13	40C25116TWBS	\$4,352	\$4,831	\$5,658	\$6,963
	24 ½	115	5	147	13	40C25115TWBS	\$4,314	\$4,789	\$5,608	\$6,902
	24 ½	114	5	146	13	40C25114TWBS	\$4,276	\$4,746	\$5,559	\$6,842
	24 ½	113	5	144	13	40C25113TWBS	\$4,238	\$4,704	\$5,509	\$6,781
	24 ½	112	5	143	13	40C25112TWBS	\$4,200	\$4,662	\$5,460	\$6,720
	24 ½	111	5	142	13	40C25111TWBS	\$4,162	\$4,620	\$5,411	\$6,659
	24 ½	110	5	141	13	40C25110TWBS	\$4,124	\$4,578	\$5,361	\$6,598
	24 ½	109	5	139	12	40C25109TWBS	\$4,086	\$4,535	\$5,312	\$6,538
	24 ½	108	5	138	12	40C25108TWBS	\$4,048	\$4,493	\$5,262	\$6,477
	24 ½	107	5	137	12	40C25107TWBS	\$4,011	\$4,452	\$5,214	\$6,418
	24 ½	106	5	136	12	40C25106TWBS	\$3,973	\$4,410	\$5,165	\$6,357
	24 ½	105	5	134	12	40C25105TWBS	\$3,935	\$4,368	\$5,116	\$6,296
	24 ½	104	5	133	12	40C25104TWBS	\$3,897	\$4,326	\$5,066	\$6,235
	24 ½	103	5	132	12	40C25103TWBS	\$3,859	\$4,283	\$5,017	\$6,174
	24 ½	102	5	130	12	40C25102TWBS	\$3,821	\$4,241	\$4,967	\$6,114
	24 ½	101	5	129	12	40C25101TWBS	\$3,783	\$4,199	\$4,918	\$6,053
	24 ½	100	5	128	11	40C25100TWBS	\$3,745	\$4,157	\$4,869	\$5,992
	24 ½	99	5	127	11	40C2599TWBS	\$3,707	\$4,115	\$4,819	\$5,931
	24 ½	98	5	125	11	40C2598TWBS	\$3,669	\$4,073	\$4,770	\$5,870
	24 ½	97	5	124	11	40C2597TWBS	\$3,631	\$4,030	\$4,720	\$5,810
	24 ½	96	5	123	11	40C2596TWBS	\$3,593	\$3,988	\$4,671	\$5,749
	24 ½	95	5	122	11	40C2595TWBS	\$3,555	\$3,941	\$4,616	\$5,681
	24 ½	94	5	120	11	40C2594TWBS	\$3,509	\$3,894	\$4,561	\$5,614
	24 ½	93	5	119	11	40C2593TWBS	\$3,468	\$3,849	\$4,508	\$5,548
	24 ½	92	5	118	11	40C2592TWBS	\$3,426	\$3,802	\$4,453	\$5,481
	24 ½	91	5	117	10	40C2591TWBS	\$3,384	\$3,756	\$4,399	\$5,414
	24 ½	90	5	115	10	40C2590TWBS	\$3,343	\$3,710	\$4,345	\$5,348
	24 ½	89	5	114	10	40C2589TWBS	\$3,301	\$3,664	\$4,291	\$5,281
24 ½	88	5	113	10	40C2588TWBS	\$3,259	\$3,617	\$4,236	\$5,214	
24 ½	87	5	111	10	40C2587TWBS	\$3,218	\$3,571	\$4,183	\$5,148	
24 ½	86	5	110	10	40C2586TWBS	\$3,176	\$3,525	\$4,128	\$5,081	
24 ½	85	5	109	10	40C2585TWBS	\$3,134	\$3,478	\$4,074	\$5,014	

- 3mm radius front edge, sides and back are flat
- 4" h backsplash

Specify: Model | Worksurface Solid Surface

Model	Worksurface Solid Surface
	see Forge Solid Surface Finishes

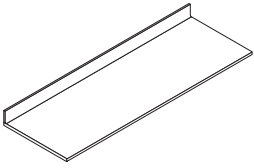
Description	D	W	H	CTN WT	CU FT	① Model	Tier 1	Tier 2	Tier 3	Tier 4
24½" d Solid Surface Worksurfaces with Integral Backsplash (continued) 	24 ½	84	5	108	10	40C2584TWBS	\$3,093	\$3,433	\$4,020	\$4,948
	24 ½	83	5	106	10	40C2583TWBS	\$3,051	\$3,386	\$3,966	\$4,881
	24 ½	82	5	105	10	40C2582TWBS	\$3,009	\$3,339	\$3,911	\$4,814
	24 ½	81	5	104	9	40C2581TWBS	\$2,967	\$3,293	\$3,856	\$4,746
	24 ½	80	5	103	9	40C2580TWBS	\$2,925	\$3,246	\$3,802	\$4,679
	24 ½	79	5	101	9	40C2579TWBS	\$2,883	\$3,200	\$3,747	\$4,612
	24 ½	78	5	100	9	40C2578TWBS	\$2,841	\$3,153	\$3,693	\$4,545
	24 ½	77	5	99	9	40C2577TWBS	\$2,802	\$3,110	\$3,643	\$4,483
	24 ½	76	5	98	9	40C2576TWBS	\$2,764	\$3,068	\$3,593	\$4,422
	24 ½	75	5	96	9	40C2575TWBS	\$2,725	\$3,025	\$3,543	\$4,360
	24 ½	74	5	95	9	40C2574TWBS	\$2,687	\$2,983	\$3,493	\$4,299
	24 ½	73	5	94	9	40C2573TWBS	\$2,648	\$2,939	\$3,442	\$4,237
	24 ½	72	5	92	8	40C2572TWBS	\$2,610	\$2,897	\$3,393	\$4,176
	24 ½	71	5	91	8	40C2571TWBS	\$2,576	\$2,859	\$3,348	\$4,121
	24 ½	70	5	90	8	40C2570TWBS	\$2,543	\$2,822	\$3,305	\$4,068
	24 ½	69	5	89	8	40C2569TWBS	\$2,510	\$2,786	\$3,262	\$4,015
	24 ½	68	5	87	8	40C2568TWBS	\$2,477	\$2,749	\$3,219	\$3,962
	24 ½	67	5	86	8	40C2567TWBS	\$2,444	\$2,712	\$3,177	\$3,910
	24 ½	66	5	85	8	40C2566TWBS	\$2,411	\$2,676	\$3,134	\$3,857
	24 ½	65	5	84	8	40C2565TWBS	\$2,378	\$2,639	\$3,091	\$3,804
	24 ½	64	5	82	8	40C2564TWBS	\$2,345	\$2,602	\$3,048	\$3,751
	24 ½	63	5	81	7	40C2563TWBS	\$2,312	\$2,566	\$3,005	\$3,698
	24 ½	62	5	80	7	40C2562TWBS	\$2,279	\$2,529	\$2,962	\$3,646
	24 ½	61	5	79	7	40C2561TWBS	\$2,246	\$2,493	\$2,919	\$3,593
	24 ½	60	5	77	7	40C2560TWBS	\$2,213	\$2,456	\$2,876	\$3,540
	24 ½	59	5	76	7	40C2559TWBS	\$2,180	\$2,419	\$2,833	\$3,487
	24 ½	58	5	75	7	40C2558TWBS	\$2,147	\$2,383	\$2,790	\$3,434
	24 ½	57	5	73	7	40C2557TWBS	\$2,114	\$2,346	\$2,748	\$3,382
	24 ½	56	5	72	7	40C2556TWBS	\$2,085	\$2,314	\$2,711	\$3,336
	24 ½	55	5	71	7	40C2555TWBS	\$2,055	\$2,281	\$2,672	\$3,288
	24 ½	54	5	70	7	40C2554TWBS	\$2,025	\$2,248	\$2,633	\$3,240
24 ½	53	5	68	6	40C2553TWBS	\$1,995	\$2,214	\$2,594	\$3,192	
24 ½	52	5	67	6	40C2552TWBS	\$1,965	\$2,181	\$2,555	\$3,144	
24 ½	51	5	66	6	40C2551TWBS	\$1,936	\$2,149	\$2,517	\$3,098	
24 ½	50	5	65	6	40C2550TWBS	\$1,906	\$2,116	\$2,478	\$3,050	
24 ½	49	5	63	6	40C2549TWBS	\$1,876	\$2,082	\$2,439	\$3,002	

• 3mm radius front edge, sides and back are flat

Specify: Model | Worksurface Solid Surface

Model	Worksurface Solid Surface
	see Forge Solid Surface Finishes

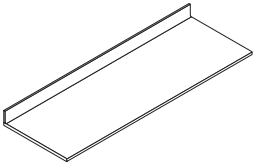
Description	D	W	H	CTN WT	CU FT	① Model	Tier 1	Tier 2	Tier 3	Tier 4
24½" d Solid Surface Worksurfaces with Integral Backsplash (continued) 	24 ½	48	5	62	6	40C2548TWBS	\$1,846	\$2,049	\$2,400	\$2,954
	24 ½	47	5	61	6	40C2547TWBS	\$1,838	\$2,019	\$2,365	\$2,910
	24 ½	46	5	60	6	40C2546TWBS	\$1,811	\$1,989	\$2,330	\$2,867
	24 ½	45	5	58	6	40C2545TWBS	\$1,784	\$1,959	\$2,295	\$2,824
	24 ½	44	5	57	5	40C2544TWBS	\$1,757	\$1,929	\$2,259	\$2,781
	24 ½	43	5	56	5	40C2543TWBS	\$1,730	\$1,899	\$2,224	\$2,738
	24 ½	42	5	54	5	40C2542TWBS	\$1,703	\$1,869	\$2,189	\$2,694
	24 ½	41	5	53	5	40C2541TWBS	\$1,676	\$1,839	\$2,154	\$2,651
	24 ½	40	5	52	5	40C2540TWBS	\$1,649	\$1,809	\$2,119	\$2,608
	24 ½	39	5	51	5	40C2539TWBS	\$1,622	\$1,779	\$2,084	\$2,565
	24 ½	38	5	49	5	40C2538TWBS	\$1,595	\$1,749	\$2,049	\$2,522
	24 ½	37	5	48	5	40C2537TWBS	\$1,568	\$1,719	\$2,014	\$2,478
	24 ½	36	5	47	5	40C2536TWBS	\$1,522	\$1,689	\$1,979	\$2,435
	24 ½	35	5	46	4	40C2535TWBS	\$1,461	\$1,622	\$1,899	\$2,338
	24 ½	34	5	44	4	40C2534TWBS	\$1,400	\$1,554	\$1,820	\$2,240
	24 ½	33	5	43	4	40C2533TWBS	\$1,339	\$1,486	\$1,741	\$2,142
	24 ½	32	5	42	4	40C2532TWBS	\$1,286	\$1,428	\$1,672	\$2,058
	24 ½	31	5	41	4	40C2531TWBS	\$1,234	\$1,370	\$1,605	\$1,975
	24 ½	30	5	39	4	40C2530TWBS	\$1,183	\$1,313	\$1,538	\$1,893
	24 ½	29	5	38	4	40C2529TWBS	\$1,157	\$1,284	\$1,504	\$1,850
	24 ½	28	5	37	4	40C2528TWBS	\$1,132	\$1,256	\$1,471	\$1,810
	24 ½	27	5	35	4	40C2527TWBS	\$1,107	\$1,228	\$1,439	\$1,770
	24 ½	26	5	34	4	40C2526TWBS	\$1,082	\$1,200	\$1,406	\$1,730
	24 ½	25	5	33	3	40C2525TWBS	\$1,057	\$1,173	\$1,373	\$1,690
	24 ½	24	5	32	3	40C2524TWBS	\$1,032	\$1,145	\$1,341	\$1,650
	24 ½	23	5	30	3	40C2523TWBS	\$1,016	\$1,128	\$1,321	\$1,626
	24 ½	22	5	29	3	40C2522TWBS	\$1,002	\$1,113	\$1,303	\$1,604
	24 ½	21	5	28	3	40C2521TWBS	\$988	\$1,097	\$1,285	\$1,581
	24 ½	20	5	27	3	40C2520TWBS	\$968	\$1,074	\$1,258	\$1,549
	24 ½	19	5	25	3	40C2519TWBS	\$948	\$1,052	\$1,232	\$1,517
	24 ½	18	5	24	3	40C2518TWBS	\$928	\$1,030	\$1,206	\$1,485
	24 ½	17	5	23	3	40C2517TWBS	\$923	\$1,024	\$1,199	\$1,476
24 ½	16	5	22	2	40C2516TWBS	\$917	\$1,017	\$1,192	\$1,466	
24 ½	15	5	20	2	40C2515TWBS	\$911	\$1,011	\$1,184	\$1,457	
24 ½	14	5	19	2	40C2514TWBS	\$905	\$1,004	\$1,176	\$1,447	
24 ½	13	5	18	2	40C2513TWBS	\$899	\$997	\$1,168	\$1,438	
24 ½	12	5	16	2	40C2512TWBS	\$893	\$991	\$1,160	\$1,428	

• 3mm radius front edge, sides and back are flat

Specify: Model | Worksurface Solid Surface

Model	Worksurface Solid Surface
	see Forge Solid Surface Finishes

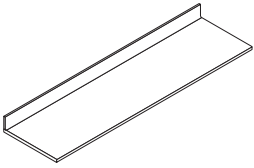
Description	D	W	H	CTN WT	CU FT	① Model	Tier 1	Tier 2	Tier 3	Tier 4
19½" d Solid Surface Worksurfaces with Integral Backsplash 	19 ½	120	5	125	11	40C20120TWBS	\$3,522	\$3,909	\$4,579	\$5,635
	19 ½	119	5	124	11	40C20119TWBS	\$3,492	\$3,876	\$4,539	\$5,586
	19 ½	118	5	123	11	40C20118TWBS	\$3,462	\$3,842	\$4,500	\$5,538
	19 ½	117	5	122	11	40C20117TWBS	\$3,432	\$3,809	\$4,461	\$5,490
	19 ½	116	5	121	11	40C20116TWBS	\$3,401	\$3,775	\$4,421	\$5,442
	19 ½	115	5	120	11	40C20115TWBS	\$3,371	\$3,742	\$4,382	\$5,394
	19 ½	114	5	119	11	40C20114TWBS	\$3,340	\$3,707	\$4,342	\$5,344
	19 ½	113	5	118	11	40C20113TWBS	\$3,305	\$3,669	\$4,297	\$5,288
	19 ½	112	5	117	10	40C20112TWBS	\$3,270	\$3,630	\$4,251	\$5,232
	19 ½	111	5	116	10	40C20111TWBS	\$3,235	\$3,591	\$4,206	\$5,176
	19 ½	110	5	115	10	40C20110TWBS	\$3,200	\$3,552	\$4,160	\$5,120
	19 ½	109	5	114	10	40C20109TWBS	\$3,165	\$3,513	\$4,115	\$5,064
	19 ½	108	5	113	10	40C20108TWBS	\$3,130	\$3,474	\$4,069	\$5,008
	19 ½	107	5	112	10	40C20107TWBS	\$3,087	\$3,426	\$4,012	\$4,938
	19 ½	106	5	111	10	40C20106TWBS	\$3,046	\$3,381	\$3,959	\$4,873
	19 ½	105	5	110	10	40C20105TWBS	\$3,005	\$3,335	\$3,906	\$4,807
	19 ½	104	5	109	10	40C20104TWBS	\$2,964	\$3,289	\$3,853	\$4,742
	19 ½	103	5	108	10	40C20103TWBS	\$2,923	\$3,244	\$3,799	\$4,676
	19 ½	102	5	107	10	40C20102TWBS	\$2,882	\$3,198	\$3,746	\$4,610
	19 ½	101	5	106	9	40C20101TWBS	\$2,862	\$3,176	\$3,720	\$4,578
	19 ½	100	5	104	9	40C20100TWBS	\$2,841	\$3,153	\$3,693	\$4,545
	19 ½	99	5	103	9	40C2099TWBS	\$2,830	\$3,141	\$3,678	\$4,527
	19 ½	98	5	102	9	40C2098TWBS	\$2,820	\$3,130	\$3,665	\$4,511
	19 ½	97	5	101	9	40C2097TWBS	\$2,809	\$3,117	\$3,651	\$4,494
	19 ½	96	5	100	9	40C2096TWBS	\$2,799	\$3,106	\$3,638	\$4,478
	19 ½	95	5	99	9	40C2095TWBS	\$2,767	\$3,071	\$3,596	\$4,426
	19 ½	94	5	98	9	40C2094TWBS	\$2,736	\$3,036	\$3,556	\$4,377
	19 ½	93	5	97	9	40C2093TWBS	\$2,705	\$3,002	\$3,516	\$4,327
	19 ½	92	5	96	9	40C2092TWBS	\$2,673	\$2,966	\$3,474	\$4,276
	19 ½	91	5	95	9	40C2091TWBS	\$2,643	\$2,933	\$3,435	\$4,228
19 ½	90	5	94	9	40C2090TWBS	\$2,614	\$2,901	\$3,398	\$4,182	
19 ½	89	5	93	8	40C2089TWBS	\$2,584	\$2,868	\$3,359	\$4,134	
19 ½	88	5	92	8	40C2088TWBS	\$2,555	\$2,835	\$3,321	\$4,087	
19 ½	87	5	91	8	40C2087TWBS	\$2,525	\$2,802	\$3,282	\$4,039	
19 ½	86	5	90	8	40C2086TWBS	\$2,496	\$2,770	\$3,244	\$3,993	
19 ½	85	5	89	8	40C2085TWBS	\$2,466	\$2,737	\$3,205	\$3,945	

• 3mm radius front edge, sides and back are flat

Specify: Model | Worksurface Solid Surface

Model	Worksurface Solid Surface
	see Forge Solid Surface Finishes

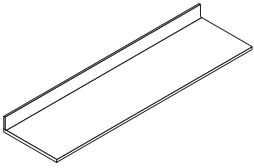
Description	D	W	H	CTN WT	CU FT	① Model	Tier 1	Tier 2	Tier 3	Tier 4
19½" d Solid Surface Worksurfaces with Integral Backsplash (continued) 	19 ½	84	5	88	8	40C2084TWBS	\$2,437	\$2,705	\$3,167	\$3,898
	19 ½	83	5	87	8	40C2083TWBS	\$2,411	\$2,676	\$3,134	\$3,858
	19 ½	82	5	86	8	40C2082TWBS	\$2,386	\$2,648	\$3,102	\$3,818
	19 ½	81	5	85	8	40C2081TWBS	\$2,360	\$2,620	\$3,068	\$3,776
	19 ½	80	5	84	8	40C2080TWBS	\$2,335	\$2,592	\$3,036	\$3,736
	19 ½	79	5	83	8	40C2079TWBS	\$2,309	\$2,563	\$3,002	\$3,694
	19 ½	78	5	82	7	40C2078TWBS	\$2,284	\$2,535	\$2,969	\$3,654
	19 ½	77	5	81	7	40C2077TWBS	\$2,252	\$2,499	\$2,927	\$3,602
	19 ½	76	5	80	7	40C2076TWBS	\$2,221	\$2,465	\$2,887	\$3,553
	19 ½	75	5	79	7	40C2075TWBS	\$2,190	\$2,430	\$2,846	\$3,503
	19 ½	74	5	78	7	40C2074TWBS	\$2,159	\$2,396	\$2,806	\$3,454
	19 ½	73	5	77	7	40C2073TWBS	\$2,128	\$2,362	\$2,766	\$3,404
	19 ½	72	5	76	7	40C2072TWBS	\$2,097	\$2,327	\$2,725	\$3,354
	19 ½	71	5	75	7	40C2071TWBS	\$2,074	\$2,302	\$2,696	\$3,318
	19 ½	70	5	73	7	40C2070TWBS	\$2,052	\$2,278	\$2,668	\$3,283
	19 ½	69	5	72	7	40C2069TWBS	\$2,030	\$2,253	\$2,639	\$3,248
	19 ½	68	5	71	7	40C2068TWBS	\$2,008	\$2,229	\$2,610	\$3,213
	19 ½	67	5	70	7	40C2067TWBS	\$1,986	\$2,204	\$2,582	\$3,178
	19 ½	66	5	69	6	40C2066TWBS	\$1,964	\$2,180	\$2,553	\$3,142
	19 ½	65	5	68	6	40C2065TWBS	\$1,942	\$2,156	\$2,525	\$3,107
	19 ½	64	5	67	6	40C2064TWBS	\$1,920	\$2,131	\$2,496	\$3,072
	19 ½	63	5	66	6	40C2063TWBS	\$1,898	\$2,107	\$2,467	\$3,037
	19 ½	62	5	65	6	40C2062TWBS	\$1,876	\$2,082	\$2,439	\$3,002
	19 ½	61	5	64	6	40C2061TWBS	\$1,856	\$2,060	\$2,412	\$2,969
	19 ½	60	5	63	6	40C2060TWBS	\$1,837	\$2,039	\$2,387	\$2,938
	19 ½	59	5	62	6	40C2059TWBS	\$1,818	\$2,017	\$2,363	\$2,908
	19 ½	58	5	61	6	40C2058TWBS	\$1,798	\$1,995	\$2,337	\$2,876
	19 ½	57	5	60	6	40C2057TWBS	\$1,779	\$1,974	\$2,312	\$2,846
	19 ½	56	5	59	6	40C2056TWBS	\$1,760	\$1,953	\$2,287	\$2,815
	19 ½	55	5	58	5	40C2055TWBS	\$1,736	\$1,927	\$2,257	\$2,778
19 ½	54	5	57	5	40C2054TWBS	\$1,712	\$1,900	\$2,226	\$2,739	
19 ½	53	5	56	5	40C2053TWBS	\$1,692	\$1,878	\$2,200	\$2,707	
19 ½	52	5	55	5	40C2052TWBS	\$1,671	\$1,855	\$2,172	\$2,674	
19 ½	51	5	54	5	40C2051TWBS	\$1,650	\$1,832	\$2,145	\$2,640	
19 ½	50	5	53	5	40C2050TWBS	\$1,630	\$1,809	\$2,119	\$2,608	
19 ½	49	5	52	5	40C2049TWBS	\$1,609	\$1,786	\$2,092	\$2,574	

• 3mm radius front edge, sides and back are flat

Specify: Model | Worksurface Solid Surface

Model	Worksurface Solid Surface
	see Forge Solid Surface Finishes

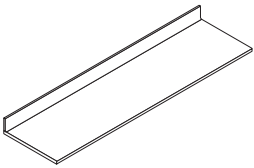
Description	D	W	H	CTN WT	CU FT	① Model	Tier 1	Tier 2	Tier 3	Tier 4
19½" d Solid Surface Worksurfaces with Integral Backsplash (continued) 	19 ½	48	5	51	5	40C2048TWBS	\$1,588	\$1,763	\$2,064	\$2,541
	19 ½	47	5	50	5	40C2047TWBS	\$1,528	\$1,696	\$1,986	\$2,444
	19 ½	46	5	49	5	40C2046TWBS	\$1,468	\$1,629	\$1,908	\$2,348
	19 ½	45	5	48	5	40C2045TWBS	\$1,408	\$1,562	\$1,830	\$2,252
	19 ½	44	5	47	5	40C2044TWBS	\$1,349	\$1,497	\$1,753	\$2,158
	19 ½	43	5	46	4	40C2043TWBS	\$1,289	\$1,430	\$1,675	\$2,062
	19 ½	42	5	45	4	40C2042TWBS	\$1,230	\$1,365	\$1,598	\$1,967
	19 ½	41	5	44	4	40C2041TWBS	\$1,210	\$1,343	\$1,572	\$1,935
	19 ½	40	5	42	4	40C2040TWBS	\$1,191	\$1,321	\$1,548	\$1,905
	19 ½	39	5	41	4	40C2039TWBS	\$1,171	\$1,299	\$1,522	\$1,873
	19 ½	38	5	40	4	40C2038TWBS	\$1,152	\$1,278	\$1,497	\$1,842
	19 ½	37	5	39	4	40C2037TWBS	\$1,132	\$1,256	\$1,471	\$1,810
	19 ½	36	5	38	4	40C2036TWBS	\$1,113	\$1,235	\$1,446	\$1,780
	19 ½	35	5	37	4	40C2035TWBS	\$1,093	\$1,213	\$1,420	\$1,748
	19 ½	34	5	36	4	40C2034TWBS	\$1,074	\$1,192	\$1,396	\$1,718
	19 ½	33	5	35	4	40C2033TWBS	\$1,055	\$1,170	\$1,371	\$1,687
	19 ½	32	5	34	3	40C2032TWBS	\$1,036	\$1,149	\$1,346	\$1,657
	19 ½	31	5	33	3	40C2031TWBS	\$1,017	\$1,128	\$1,321	\$1,626
	19 ½	30	5	32	3	40C2030TWBS	\$998	\$1,107	\$1,297	\$1,596
	19 ½	29	5	31	3	40C2029TWBS	\$991	\$1,100	\$1,288	\$1,586
	19 ½	28	5	30	3	40C2028TWBS	\$985	\$1,093	\$1,281	\$1,576
	19 ½	27	5	29	3	40C2027TWBS	\$979	\$1,087	\$1,273	\$1,566
	19 ½	26	5	28	3	40C2026TWBS	\$973	\$1,080	\$1,265	\$1,557
	19 ½	25	5	27	3	40C2025TWBS	\$967	\$1,073	\$1,257	\$1,547
	19 ½	24	5	26	3	40C2024TWBS	\$961	\$1,067	\$1,249	\$1,538
	19 ½	23	5	25	3	40C2023TWBS	\$945	\$1,049	\$1,229	\$1,512
	19 ½	22	5	24	3	40C2022TWBS	\$929	\$1,031	\$1,208	\$1,486
	19 ½	21	5	23	2	40C2021TWBS	\$913	\$1,013	\$1,187	\$1,461
	19 ½	20	5	22	2	40C2020TWBS	\$897	\$996	\$1,166	\$1,435
	19 ½	19	5	21	2	40C2019TWBS	\$881	\$978	\$1,145	\$1,410
19 ½	18	5	20	2	40C2018TWBS	\$865	\$960	\$1,125	\$1,384	
19 ½	17	5	19	2	40C2017TWBS	\$860	\$954	\$1,117	\$1,375	
19 ½	16	5	18	2	40C2016TWBS	\$855	\$948	\$1,111	\$1,367	
19 ½	15	5	17	2	40C2015TWBS	\$850	\$943	\$1,104	\$1,359	
19 ½	14	5	16	2	40C2014TWBS	\$844	\$937	\$1,097	\$1,350	
19 ½	13	5	15	2	40C2013TWBS	\$839	\$931	\$1,091	\$1,342	
19 ½	12	5	14	2	40C2012TWBS	\$834	\$926	\$1,084	\$1,334	

• 3mm radius front edge, sides and back are flat

Specify: Model | Worksurface Solid Surface

Model	Worksurface Solid Surface
	see Forge Solid Surface Finishes

Description	D	W	H	CTN WT	CU FT	① Model	Tier 1	Tier 2	Tier 3	Tier 4
Solid Surface Corner	29	29	5 3/16	42	4	40C2929CTSBS	\$1,766	\$1,960	\$2,296	\$2,826
Worksurface with Integral Backsplash	24	24	5 3/16	30	3	40C2424CTSBS	\$1,485	\$1,648	\$1,931	\$2,376

- 3mm radius front edge, sides and back are flat
- brackets must be specified separately, [see page 69](#)

Specify: Model | Worksurface Solid Surface

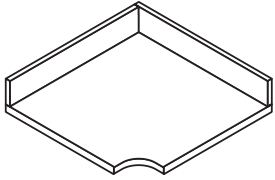

Model	Worksurface Solid Surface
	see Forge Solid Surface Finishes

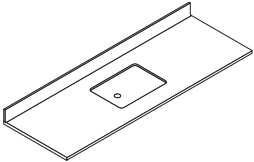
Description	D	W	H	CTN WT	CU FT	① Model	Tier 1	Tier 2	Tier 3	Tier 4
24½" d Solid Surface Worksurfaces with Integral Backsplash & Sink 	24 ½	120	5	173	26	40C25120TWBSSS	\$6,502	\$6,860	\$7,477	\$8,453
	24 ½	119	5	172	26	40C25119TWBSSS	\$6,468	\$6,824	\$7,438	\$8,408
	24 ½	118	5	171	25	40C25118TWBSSS	\$6,434	\$6,788	\$7,399	\$8,364
	24 ½	117	5	169	25	40C25117TWBSSS	\$6,400	\$6,752	\$7,360	\$8,320
	24 ½	116	5	168	25	40C25116TWBSSS	\$6,366	\$6,716	\$7,321	\$8,276
	24 ½	115	5	167	25	40C25115TWBSSS	\$6,332	\$6,680	\$7,282	\$8,232
	24 ½	114	5	166	25	40C25114TWBSSS	\$6,298	\$6,644	\$7,243	\$8,187
	24 ½	113	5	164	24	40C25113TWBSSS	\$6,245	\$6,588	\$7,182	\$8,119
	24 ½	112	5	163	24	40C25112TWBSSS	\$6,192	\$6,533	\$7,121	\$8,050
	24 ½	111	5	162	24	40C25111TWBSSS	\$6,162	\$6,501	\$7,086	\$8,011
	24 ½	110	5	161	24	40C25110TWBSSS	\$6,133	\$6,470	\$7,053	\$7,973
	24 ½	109	5	159	23	40C25109TWBSSS	\$6,104	\$6,440	\$7,020	\$7,935
	24 ½	108	5	158	23	40C25108TWBSSS	\$6,075	\$6,409	\$6,986	\$7,898
	24 ½	107	5	157	23	40C25107TWBSSS	\$6,046	\$6,379	\$6,953	\$7,860
	24 ½	106	5	156	23	40C25106TWBSSS	\$6,016	\$6,347	\$6,918	\$7,821
	24 ½	105	5	154	23	40C25105TWBSSS	\$5,987	\$6,316	\$6,885	\$7,783
	24 ½	104	5	153	22	40C25104TWBSSS	\$5,958	\$6,286	\$6,852	\$7,745
	24 ½	103	5	152	22	40C25103TWBSSS	\$5,908	\$6,233	\$6,794	\$7,680
	24 ½	102	5	150	22	40C25102TWBSSS	\$5,860	\$6,182	\$6,739	\$7,618
	24 ½	101	5	149	22	40C25101TWBSSS	\$5,812	\$6,132	\$6,684	\$7,556
	24 ½	100	5	148	22	40C25100TWBSSS	\$5,764	\$6,081	\$6,629	\$7,493
	24 ½	99	5	147	21	40C2599TWBSSS	\$5,716	\$6,030	\$6,573	\$7,431
	24 ½	98	5	145	21	40C2598TWBSSS	\$5,668	\$5,980	\$6,518	\$7,368
	24 ½	97	5	144	21	40C2597TWBSSS	\$5,620	\$5,929	\$6,463	\$7,306
	24 ½	96	5	143	21	40C2596TWBSSS	\$5,572	\$5,878	\$6,408	\$7,244
	24 ½	95	5	142	21	40C2595TWBSSS	\$5,531	\$5,835	\$6,361	\$7,190
	24 ½	94	5	140	20	40C2594TWBSSS	\$5,488	\$5,790	\$6,311	\$7,134
	24 ½	93	5	139	20	40C2593TWBSSS	\$5,445	\$5,744	\$6,262	\$7,079
	24 ½	92	5	138	20	40C2592TWBSSS	\$5,402	\$5,699	\$6,212	\$7,023
	24 ½	91	5	137	20	40C2591TWBSSS	\$5,359	\$5,654	\$6,163	\$6,967
24 ½	90	5	135	20	40C2590TWBSSS	\$5,316	\$5,608	\$6,113	\$6,911	
24 ½	89	5	134	19	40C2589TWBSSS	\$5,273	\$5,563	\$6,064	\$6,855	
24 ½	88	5	133	19	40C2588TWBSSS	\$5,230	\$5,518	\$6,015	\$6,799	
24 ½	87	5	131	19	40C2587TWBSSS	\$5,187	\$5,472	\$5,965	\$6,743	
24 ½	86	5	130	19	40C2586TWBSSS	\$5,144	\$5,427	\$5,916	\$6,687	
24 ½	85	5	129	19	40C2585TWBSSS	\$5,101	\$5,382	\$5,866	\$6,631	

- 3mm radius front edge, sides and back are flat
- Integral Sink is always Designer White

Specify: Model | Worksurface Solid Surface | Sink Location

Model	Worksurface Solid Surface	Sink Location
	see Forge Solid Surface Finishes	Sink location is available in 1" increments from left side of worksurface to centerline of sink with minimum of 12" to centerline from either edge of surface. Sink should always be centered over sink cabinet

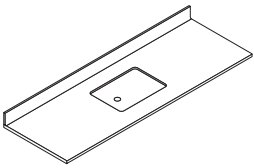
Description	D	W	H	CTN WT	CU FT	① Model	Tier 1	Tier 2	Tier 3	Tier 4
24½" d Solid Surface Worksurfaces with Integral Backsplash & Sink (continued) 	24 ½	84	5	128	18	40C2584TWBSSS	\$5,058	\$5,336	\$5,817	\$6,575
	24 ½	83	5	126	18	40C2583TWBSSS	\$5,012	\$5,288	\$5,764	\$6,516
	24 ½	82	5	125	18	40C2582TWBSSS	\$4,967	\$5,240	\$5,712	\$6,457
	24 ½	81	5	124	18	40C2581TWBSSS	\$4,921	\$5,192	\$5,659	\$6,397
	24 ½	80	5	123	17	40C2580TWBSSS	\$4,876	\$5,144	\$5,607	\$6,339
	24 ½	79	5	121	17	40C2579TWBSSS	\$4,830	\$5,096	\$5,555	\$6,279
	24 ½	78	5	120	17	40C2578TWBSSS	\$4,785	\$5,048	\$5,503	\$6,221
	24 ½	77	5	119	17	40C2577TWBSSS	\$4,740	\$5,001	\$5,451	\$6,162
	24 ½	76	5	118	17	40C2576TWBSSS	\$4,695	\$4,953	\$5,399	\$6,104
	24 ½	75	5	116	16	40C2575TWBSSS	\$4,668	\$4,925	\$5,368	\$6,068
	24 ½	74	5	115	16	40C2574TWBSSS	\$4,640	\$4,895	\$5,336	\$6,032
	24 ½	73	5	114	16	40C2573TWBSSS	\$4,613	\$4,867	\$5,305	\$5,997
	24 ½	72	5	112	16	40C2572TWBSSS	\$4,585	\$4,837	\$5,273	\$5,961
	24 ½	71	5	111	16	40C2571TWBSSS	\$4,544	\$4,794	\$5,226	\$5,907
	24 ½	70	5	110	15	40C2570TWBSSS	\$4,502	\$4,750	\$5,177	\$5,853
	24 ½	69	5	109	15	40C2569TWBSSS	\$4,460	\$4,705	\$5,129	\$5,798
	24 ½	68	5	107	15	40C2568TWBSSS	\$4,418	\$4,661	\$5,081	\$5,743
	24 ½	67	5	106	15	40C2567TWBSSS	\$4,376	\$4,617	\$5,032	\$5,689
	24 ½	66	5	105	15	40C2566TWBSSS	\$4,334	\$4,572	\$4,984	\$5,634
	24 ½	65	5	104	14	40C2565TWBSSS	\$4,292	\$4,528	\$4,936	\$5,580
	24 ½	64	5	102	14	40C2564TWBSSS	\$4,250	\$4,484	\$4,888	\$5,525
	24 ½	63	5	101	14	40C2563TWBSSS	\$4,227	\$4,459	\$4,861	\$5,495
	24 ½	62	5	100	14	40C2562TWBSSS	\$4,203	\$4,434	\$4,833	\$5,464
	24 ½	61	5	99	14	40C2561TWBSSS	\$4,179	\$4,409	\$4,806	\$5,433
	24 ½	60	5	97	13	40C2560TWBSSS	\$4,155	\$4,384	\$4,778	\$5,402
	24 ½	59	5	96	13	40C2559TWBSSS	\$4,122	\$4,349	\$4,740	\$5,359
	24 ½	58	5	95	13	40C2558TWBSSS	\$4,089	\$4,314	\$4,702	\$5,316
	24 ½	57	5	93	13	40C2557TWBSSS	\$4,056	\$4,279	\$4,664	\$5,273
	24 ½	56	5	92	13	40C2556TWBSSS	\$4,023	\$4,244	\$4,626	\$5,230
	24 ½	55	5	91	12	40C2555TWBSSS	\$3,990	\$4,209	\$4,589	\$5,187
24 ½	54	5	90	12	40C2554TWBSSS	\$3,957	\$4,175	\$4,551	\$5,144	
24 ½	53	5	88	12	40C2553TWBSSS	\$3,935	\$4,151	\$4,525	\$5,116	
24 ½	52	5	87	12	40C2552TWBSSS	\$3,914	\$4,129	\$4,501	\$5,088	
24 ½	51	5	86	11	40C2551TWBSSS	\$3,893	\$4,107	\$4,477	\$5,061	
24 ½	50	5	85	11	40C2550TWBSSS	\$3,872	\$4,085	\$4,453	\$5,034	
24 ½	49	5	83	11	40C2549TWBSSS	\$3,829	\$4,040	\$4,403	\$4,978	

- 3mm radius front edge, sides and back are flat
- Integral Sink is always Designer White

Specify: Model | Worksurface Solid Surface | Sink Location

Model	Worksurface Solid Surface	Sink Location
	see Forge Solid Surface Finishes	Sink location is available in 1" increments from left side of worksurface to centerline of sink with minimum of 12" to centerline from either edge of surface. Sink should always be centered over sink cabinet

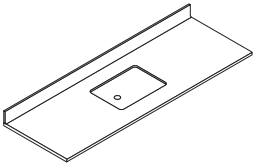
Description	D	W	H	CTN WT	CU FT	① Model	Tier 1	Tier 2	Tier 3	Tier 4
24½" d Solid Surface Worksurfaces with Integral Backsplash & Sink (continued) 	24 ½	48	5	82	11	40C2548TWBSSS	\$3,785	\$3,993	\$4,353	\$4,921
	24 ½	47	5	81	11	40C2547TWBSSS	\$3,770	\$3,977	\$4,336	\$4,901
	24 ½	46	5	80	10	40C2546TWBSSS	\$3,755	\$3,962	\$4,318	\$4,882
	24 ½	45	5	78	10	40C2545TWBSSS	\$3,740	\$3,946	\$4,301	\$4,862
	24 ½	44	5	77	10	40C2544TWBSSS	\$3,725	\$3,930	\$4,284	\$4,843
	24 ½	43	5	76	10	40C2543TWBSSS	\$3,710	\$3,914	\$4,267	\$4,823
	24 ½	42	5	74	10	40C2542TWBSSS	\$3,695	\$3,898	\$4,249	\$4,804
	24 ½	41	5	73	9	40C2541TWBSSS	\$3,651	\$3,852	\$4,199	\$4,746
	24 ½	40	5	72	9	40C2540TWBSSS	\$3,608	\$3,806	\$4,149	\$4,690
	24 ½	39	5	71	9	40C2539TWBSSS	\$3,565	\$3,761	\$4,100	\$4,635
	24 ½	38	5	69	9	40C2538TWBSSS	\$3,521	\$3,715	\$4,049	\$4,577
	24 ½	37	5	68	9	40C2537TWBSSS	\$3,478	\$3,669	\$4,000	\$4,521
	24 ½	36	5	67	8	40C2536TWBSSS	\$3,435	\$3,624	\$3,950	\$4,466
	24 ½	35	5	66	8	40C2535TWBSSS	\$3,356	\$3,582	\$3,904	\$4,414
	24 ½	34	5	64	8	40C2534TWBSSS	\$3,317	\$3,541	\$3,859	\$4,363
	24 ½	33	5	63	8	40C2533TWBSSS	\$3,278	\$3,458	\$3,770	\$4,261
	24 ½	32	5	62	8	40C2532TWBSSS	\$3,224	\$3,401	\$3,708	\$4,191
	24 ½	31	5	61	7	40C2531TWBSSS	\$3,171	\$3,345	\$3,647	\$4,122
	24 ½	30	5	59	7	40C2530TWBSSS	\$3,118	\$3,289	\$3,586	\$4,053
	24 ½	29	5	58	7	40C2529TWBSSS	\$3,096	\$3,266	\$3,560	\$4,025
	24 ½	28	5	57	7	40C2528TWBSSS	\$3,073	\$3,242	\$3,534	\$3,995
	24 ½	27	5	55	6	40C2527TWBSSS	\$3,050	\$3,218	\$3,508	\$3,965
	24 ½	26	5	54	6	40C2526TWBSSS	\$3,039	\$3,206	\$3,495	\$3,951
	24 ½	25	5	53	6	40C2525TWBSSS	\$2,999	\$3,164	\$3,449	\$3,899
24 ½	24	5	52	6	40C2524TWBSSS	\$2,959	\$3,122	\$3,403	\$3,847	

- 3mm radius front edge, sides and back are flat
- Integral Sink is always Designer White

Specify: Model | Worksurface Solid Surface | Sink Location

Model	Worksurface Solid Surface	Sink Location
	see Forge Solid Surface Finishes	Sink location is available in 1" increments from left side of worksurface to centerline of sink with minimum of 12" to centerline from either edge of surface. Sink should always be centered over sink cabinet

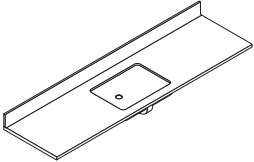
Description	D	W	H	CTN WT	CU FT	① Model	Tier 1	Tier 2	Tier 3	Tier 4
19½" d Solid Surface Worksurfaces with Integral Backsplash & Sink 	19 ½	120	5	144	21	40C20120TWBSSS	\$5,500	\$5,803	\$6,325	\$7,150
	19 ½	119	5	143	21	40C20119TWBSSS	\$5,463	\$5,763	\$6,282	\$7,102
	19 ½	118	5	142	21	40C20118TWBSSS	\$5,426	\$5,724	\$6,240	\$7,054
	19 ½	117	5	141	20	40C20117TWBSSS	\$5,389	\$5,685	\$6,197	\$7,006
	19 ½	116	5	140	20	40C20116TWBSSS	\$5,352	\$5,646	\$6,155	\$6,958
	19 ½	115	5	139	20	40C20115TWBSSS	\$5,316	\$5,608	\$6,113	\$6,911
	19 ½	114	5	138	20	40C20114TWBSSS	\$5,279	\$5,569	\$6,071	\$6,863
	19 ½	113	5	137	20	40C20113TWBSSS	\$5,242	\$5,530	\$6,028	\$6,815
	19 ½	112	5	136	20	40C20112TWBSSS	\$5,205	\$5,491	\$5,986	\$6,767
	19 ½	111	5	135	19	40C20111TWBSSS	\$5,179	\$5,464	\$5,956	\$6,733
	19 ½	110	5	133	19	40C20110TWBSSS	\$5,152	\$5,435	\$5,925	\$6,698
	19 ½	109	5	132	19	40C20109TWBSSS	\$5,125	\$5,407	\$5,894	\$6,663
	19 ½	108	5	131	19	40C20108TWBSSS	\$5,098	\$5,378	\$5,863	\$6,627
	19 ½	107	5	130	19	40C20107TWBSSS	\$5,067	\$5,346	\$5,827	\$6,587
	19 ½	106	5	129	19	40C20106TWBSSS	\$5,035	\$5,312	\$5,790	\$6,546
	19 ½	105	5	128	18	40C20105TWBSSS	\$5,003	\$5,278	\$5,753	\$6,504
	19 ½	104	5	127	18	40C20104TWBSSS	\$4,972	\$5,245	\$5,718	\$6,464
	19 ½	103	5	126	18	40C20103TWBSSS	\$4,909	\$5,179	\$5,645	\$6,382
	19 ½	102	5	125	18	40C20102TWBSSS	\$4,845	\$5,111	\$5,572	\$6,299
	19 ½	101	5	124	18	40C20101TWBSSS	\$4,830	\$5,096	\$5,555	\$6,279
	19 ½	100	5	123	18	40C20100TWBSSS	\$4,816	\$5,081	\$5,538	\$6,261
	19 ½	99	5	122	17	40C2099TWBSSS	\$4,802	\$5,066	\$5,522	\$6,243
	19 ½	98	5	121	17	40C2098TWBSSS	\$4,788	\$5,051	\$5,506	\$6,224
	19 ½	97	5	120	17	40C2097TWBSSS	\$4,774	\$5,037	\$5,490	\$6,206
	19 ½	96	5	119	17	40C2096TWBSSS	\$4,760	\$5,022	\$5,474	\$6,188
	19 ½	95	5	118	17	40C2095TWBSSS	\$4,729	\$4,989	\$5,438	\$6,148
	19 ½	94	5	117	17	40C2094TWBSSS	\$4,698	\$4,956	\$5,403	\$6,107
	19 ½	93	5	116	16	40C2093TWBSSS	\$4,667	\$4,924	\$5,367	\$6,067
	19 ½	92	5	115	16	40C2092TWBSSS	\$4,636	\$4,891	\$5,331	\$6,027
	19 ½	91	5	114	16	40C2091TWBSSS	\$4,605	\$4,858	\$5,296	\$5,987
19 ½	90	5	113	16	40C2090TWBSSS	\$4,574	\$4,826	\$5,260	\$5,946	
19 ½	89	5	112	16	40C2089TWBSSS	\$4,543	\$4,793	\$5,224	\$5,906	
19 ½	88	5	111	16	40C2088TWBSSS	\$4,512	\$4,760	\$5,189	\$5,866	
19 ½	87	5	110	15	40C2087TWBSSS	\$4,481	\$4,727	\$5,153	\$5,825	
19 ½	86	5	109	15	40C2086TWBSSS	\$4,450	\$4,695	\$5,118	\$5,785	
19 ½	85	5	108	15	40C2085TWBSSS	\$4,419	\$4,662	\$5,082	\$5,745	

- 3mm radius front edge, sides and back are flat
- Integral Sink is always Designer White

Specify: Model | Worksurface Solid Surface | Sink Location

Model	Worksurface Solid Surface	Sink Location
	see Forge Solid Surface Finishes	Sink location is available in 1" increments from left side of worksurface to centerline of sink with minimum of 12" to centerline from either edge of surface. Sink should always be centered over sink cabinet

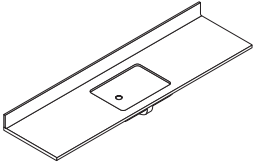
Description	D	W	H	CTN WT	CU FT	① Model	Tier 1	Tier 2	Tier 3	Tier 4
19½" d Solid Surface Worksurfaces with Integral Backsplash & Sink (continued) 	19 ½	84	5	107	15	40C2084TWBSSS	\$4,388	\$4,629	\$5,046	\$5,704
	19 ½	83	5	106	15	40C2083TWBSSS	\$4,362	\$4,602	\$5,016	\$5,671
	19 ½	82	5	105	15	40C2082TWBSSS	\$4,336	\$4,574	\$4,986	\$5,637
	19 ½	81	5	104	14	40C2081TWBSSS	\$4,310	\$4,547	\$4,957	\$5,603
	19 ½	80	5	103	14	40C2080TWBSSS	\$4,284	\$4,520	\$4,927	\$5,569
	19 ½	79	5	102	14	40C2079TWBSSS	\$4,258	\$4,492	\$4,897	\$5,535
	19 ½	78	5	101	14	40C2078TWBSSS	\$4,232	\$4,465	\$4,867	\$5,502
	19 ½	77	5	100	14	40C2077TWBSSS	\$4,185	\$4,415	\$4,813	\$5,441
	19 ½	76	5	99	14	40C2076TWBSSS	\$4,138	\$4,366	\$4,759	\$5,379
	19 ½	75	5	98	13	40C2075TWBSSS	\$4,113	\$4,339	\$4,730	\$5,347
	19 ½	74	5	97	13	40C2074TWBSSS	\$4,089	\$4,314	\$4,702	\$5,316
	19 ½	73	5	96	13	40C2073TWBSSS	\$4,065	\$4,289	\$4,675	\$5,285
	19 ½	72	5	95	13	40C2072TWBSSS	\$4,041	\$4,263	\$4,647	\$5,253
	19 ½	71	5	94	13	40C2071TWBSSS	\$4,014	\$4,235	\$4,616	\$5,218
	19 ½	70	5	93	13	40C2070TWBSSS	\$3,986	\$4,205	\$4,584	\$5,182
	19 ½	69	5	92	12	40C2069TWBSSS	\$3,959	\$4,177	\$4,553	\$5,147
	19 ½	68	5	91	12	40C2068TWBSSS	\$3,931	\$4,147	\$4,521	\$5,110
	19 ½	67	5	90	12	40C2067TWBSSS	\$3,903	\$4,118	\$4,488	\$5,074
	19 ½	66	5	89	12	40C2066TWBSSS	\$3,876	\$4,089	\$4,457	\$5,039
	19 ½	65	5	88	12	40C2065TWBSSS	\$3,848	\$4,060	\$4,425	\$5,002
	19 ½	64	5	87	12	40C2064TWBSSS	\$3,820	\$4,030	\$4,393	\$4,966
	19 ½	63	5	86	11	40C2063TWBSSS	\$3,802	\$4,011	\$4,372	\$4,943
	19 ½	62	5	85	11	40C2062TWBSSS	\$3,783	\$3,991	\$4,350	\$4,918
	19 ½	61	5	84	11	40C2061TWBSSS	\$3,764	\$3,971	\$4,329	\$4,893
	19 ½	60	5	83	11	40C2060TWBSSS	\$3,745	\$3,951	\$4,307	\$4,869
	19 ½	59	5	82	11	40C2059TWBSSS	\$3,729	\$3,934	\$4,288	\$4,848
	19 ½	58	5	81	11	40C2058TWBSSS	\$3,713	\$3,917	\$4,270	\$4,827
	19 ½	57	5	80	10	40C2057TWBSSS	\$3,697	\$3,900	\$4,252	\$4,806
	19 ½	56	5	79	10	40C2056TWBSSS	\$3,682	\$3,885	\$4,234	\$4,787
	19 ½	55	5	78	10	40C2055TWBSSS	\$3,666	\$3,868	\$4,216	\$4,766
19 ½	54	5	77	10	40C2054TWBSSS	\$3,650	\$3,851	\$4,198	\$4,745	
19 ½	53	5	76	10	40C2053TWBSSS	\$3,633	\$3,833	\$4,178	\$4,723	
19 ½	52	5	75	10	40C2052TWBSSS	\$3,617	\$3,816	\$4,160	\$4,702	
19 ½	51	5	74	9	40C2051TWBSSS	\$3,601	\$3,799	\$4,141	\$4,681	
19 ½	50	5	72	9	40C2050TWBSSS	\$3,585	\$3,782	\$4,123	\$4,661	
19 ½	49	5	71	9	40C2049TWBSSS	\$3,556	\$3,752	\$4,089	\$4,623	

- 3mm radius front edge, sides and back are flat
- Integral Sink is always Designer White

Specify: Model | Worksurface Solid Surface | Sink Location

Model	Worksurface Solid Surface	Sink Location
	see Forge Solid Surface Finishes	Sink location is available in 1" increments from left side of worksurface to centerline of sink with minimum of 12" to centerline from either edge of surface. Sink should always be centered over sink cabinet

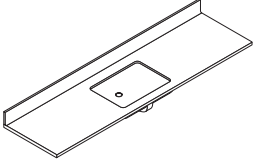
Description	D	W	H	CTN WT	CU FT	① Model	Tier 1	Tier 2	Tier 3	Tier 4
19½" d Solid Surface Worksurfaces with Integral Backsplash & Sink (continued) 	19 ½	48	5	70	9	40C2048TWBSSS	\$3,526	\$3,720	\$4,055	\$4,584
	19 ½	47	5	69	9	40C2047TWBSSS	\$3,464	\$3,655	\$3,984	\$4,503
	19 ½	46	5	68	9	40C2046TWBSSS	\$3,402	\$3,589	\$3,912	\$4,423
	19 ½	45	5	67	8	40C2045TWBSSS	\$3,340	\$3,524	\$3,841	\$4,342
	19 ½	44	5	66	8	40C2044TWBSSS	\$3,279	\$3,459	\$3,771	\$4,263
	19 ½	43	5	65	8	40C2043TWBSSS	\$3,217	\$3,394	\$3,700	\$4,182
	19 ½	42	5	64	8	40C2042TWBSSS	\$3,155	\$3,329	\$3,628	\$4,102
	19 ½	41	5	63	8	40C2041TWBSSS	\$3,140	\$3,313	\$3,611	\$4,082
	19 ½	40	5	62	8	40C2040TWBSSS	\$3,128	\$3,300	\$3,597	\$4,066
	19 ½	39	5	61	7	40C2039TWBSSS	\$3,116	\$3,287	\$3,583	\$4,051
	19 ½	38	5	60	7	40C2038TWBSSS	\$3,104	\$3,275	\$3,570	\$4,035
	19 ½	37	5	59	7	40C2037TWBSSS	\$3,092	\$3,262	\$3,556	\$4,020
	19 ½	36	5	58	7	40C2036TWBSSS	\$3,080	\$3,249	\$3,542	\$4,004
	19 ½	35	5	57	7	40C2035TWBSSS	\$3,060	\$3,228	\$3,519	\$3,978
	19 ½	34	5	56	7	40C2034TWBSSS	\$3,040	\$3,207	\$3,496	\$3,952
	19 ½	33	5	55	6	40C2033TWBSSS	\$3,020	\$3,186	\$3,473	\$3,926
	19 ½	32	5	54	6	40C2032TWBSSS	\$3,000	\$3,165	\$3,450	\$3,900
	19 ½	31	5	53	6	40C2031TWBSSS	\$2,959	\$3,122	\$3,403	\$3,847
	19 ½	30	5	52	6	40C2030TWBSSS	\$2,918	\$3,078	\$3,356	\$3,793
	19 ½	29	5	51	6	40C2029TWBSSS	\$2,911	\$3,071	\$3,348	\$3,784
19 ½	28	5	50	6	40C2028TWBSSS	\$2,905	\$3,065	\$3,341	\$3,777	
19 ½	27	5	49	5	40C2027TWBSSS	\$2,899	\$3,058	\$3,334	\$3,769	
19 ½	26	5	48	5	40C2026TWBSSS	\$2,893	\$3,052	\$3,327	\$3,761	
19 ½	25	5	47	5	40C2025TWBSSS	\$2,886	\$3,045	\$3,319	\$3,752	
19 ½	24	5	46	5	40C2024TWBSSS	\$2,880	\$3,038	\$3,312	\$3,744	

- 3mm radius front edge, sides and back are flat
- Integral Sink is always Designer White

Specify: Model | Worksurface Solid Surface | Sink Location

Model	Worksurface Solid Surface	Sink Location
	see Forge Solid Surface Finishes	Sink location is available in 1" increments from left side of worksurface to centerline of sink with minimum of 12" to centerline from either edge of surface. Sink should always be centered over sink cabinet

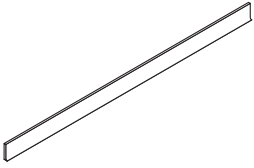
Description	D	W	H	CTN WT	CU FT	① Model	Tier 1	Tier 2	Tier 3	Tier 4
 <p>Solid Surface Backsplash</p>	½	120	4	16	2	40C1120BS	\$838	\$930	\$1,089	\$1,341
	½	119	4	16	2	40C1119BS	\$774	\$859	\$1,006	\$1,238
	½	118	4	16	2	40C1118BS	\$771	\$856	\$1,002	\$1,234
	½	117	4	16	2	40C1117BS	\$768	\$852	\$998	\$1,229
	½	116	4	15	2	40C1116BS	\$765	\$849	\$995	\$1,224
	½	115	4	15	2	40C1115BS	\$762	\$846	\$991	\$1,219
	½	114	4	15	2	40C1114BS	\$759	\$842	\$987	\$1,214
	½	113	4	15	1	40C1113BS	\$756	\$839	\$983	\$1,210
	½	112	4	15	1	40C1112BS	\$753	\$836	\$979	\$1,205
	½	111	4	15	1	40C1111BS	\$750	\$833	\$975	\$1,200
	½	110	4	15	1	40C1110BS	\$747	\$829	\$971	\$1,195
	½	109	4	15	1	40C1109BS	\$744	\$826	\$967	\$1,190
	½	108	4	14	1	40C1108BS	\$741	\$823	\$963	\$1,186
	½	107	4	14	1	40C1107BS	\$738	\$819	\$959	\$1,181
	½	106	4	14	1	40C1106BS	\$736	\$817	\$957	\$1,178
	½	105	4	14	1	40C1105BS	\$733	\$814	\$953	\$1,173
	½	104	4	14	1	40C1104BS	\$731	\$811	\$950	\$1,170
	½	103	4	14	1	40C1103BS	\$728	\$808	\$946	\$1,165
	½	102	4	14	1	40C1102BS	\$725	\$805	\$943	\$1,160
	½	101	4	14	1	40C1101BS	\$710	\$788	\$923	\$1,136
	½	100	4	13	1	40C1100BS	\$705	\$783	\$917	\$1,128
	½	99	4	13	1	40C199BS	\$700	\$777	\$910	\$1,120
	½	98	4	13	1	40C198BS	\$696	\$773	\$905	\$1,114
	½	97	4	13	1	40C197BS	\$691	\$767	\$898	\$1,106
	½	96	4	13	1	40C196BS	\$687	\$763	\$893	\$1,099
	½	95	4	13	1	40C195BS	\$609	\$676	\$792	\$974
	½	94	4	13	1	40C194BS	\$606	\$673	\$788	\$970
	½	93	4	12	1	40C193BS	\$603	\$669	\$784	\$965
	½	92	4	12	1	40C192BS	\$600	\$666	\$780	\$960
	½	91	4	12	1	40C191BS	\$597	\$663	\$776	\$955
	½	90	4	12	1	40C190BS	\$594	\$659	\$772	\$950
	½	89	4	12	1	40C189BS	\$591	\$656	\$768	\$946
½	88	4	12	1	40C188BS	\$588	\$653	\$764	\$941	
½	87	4	12	1	40C187BS	\$585	\$649	\$761	\$936	
½	86	4	12	1	40C186BS	\$582	\$646	\$757	\$931	
½	85	4	11	1	40C185BS	\$579	\$643	\$753	\$926	

Specify: Model | Worksurface Solid Surface

Model	Worksurface Solid Surface
	see Forge Solid Surface Finishes

Description	D	W	H	CTN WT	CU FT	① Model	Tier 1	Tier 2	Tier 3	Tier 4
Solid Surface Backsplash (continued)	½	84	4	11	1	40C184BS	\$575	\$638	\$748	\$920
	½	83	4	11	1	40C183BS	\$572	\$635	\$744	\$915
	½	82	4	11	1	40C182BS	\$569	\$632	\$740	\$910
	½	81	4	11	1	40C181BS	\$565	\$627	\$735	\$904
	½	80	4	11	1	40C180BS	\$562	\$624	\$731	\$899
	½	79	4	11	1	40C179BS	\$559	\$620	\$727	\$894
	½	78	4	11	1	40C178BS	\$555	\$616	\$722	\$888
	½	77	4	10	1	40C177BS	\$552	\$613	\$718	\$883
	½	76	4	10	1	40C176BS	\$549	\$609	\$714	\$878
	½	75	4	10	1	40C175BS	\$545	\$605	\$709	\$872
	½	74	4	10	1	40C174BS	\$542	\$602	\$705	\$867
	½	73	4	10	1	40C173BS	\$539	\$598	\$701	\$862
	½	72	4	10	1	40C172BS	\$536	\$595	\$697	\$858
	½	71	4	10	1	40C171BS	\$465	\$516	\$605	\$744
	½	70	4	9	1	40C170BS	\$462	\$513	\$601	\$739
	½	69	4	9	1	40C169BS	\$460	\$511	\$598	\$736
	½	68	4	9	1	40C168BS	\$457	\$507	\$594	\$731
	½	67	4	9	1	40C167BS	\$454	\$504	\$590	\$726
	½	66	4	9	1	40C166BS	\$452	\$502	\$588	\$723
	½	65	4	9	1	40C165BS	\$449	\$498	\$584	\$718
	½	64	4	9	1	40C164BS	\$447	\$496	\$581	\$715
	½	63	4	9	1	40C163BS	\$445	\$494	\$579	\$712
	½	62	4	8	1	40C162BS	\$442	\$491	\$575	\$707
	½	61	4	8	1	40C161BS	\$440	\$488	\$572	\$704
	½	60	4	8	1	40C160BS	\$438	\$486	\$569	\$701
	½	59	4	8	1	40C159BS	\$435	\$483	\$566	\$696
	½	58	4	8	1	40C158BS	\$433	\$481	\$563	\$693
	½	57	4	8	1	40C157BS	\$430	\$477	\$559	\$688
	½	56	4	8	1	40C156BS	\$428	\$475	\$556	\$685
	½	55	4	8	1	40C155BS	\$425	\$472	\$553	\$680
	½	54	4	7	1	40C154BS	\$423	\$470	\$550	\$677
	½	53	4	7	1	40C153BS	\$349	\$387	\$454	\$558
½	52	4	7	1	40C152BS	\$347	\$385	\$451	\$555	
½	51	4	7	1	40C151BS	\$345	\$383	\$449	\$552	
½	50	4	7	1	40C150BS	\$342	\$380	\$445	\$547	
½	49	4	7	1	40C149BS	\$340	\$377	\$442	\$544	

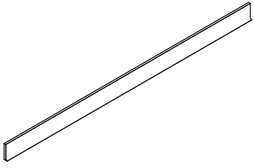

Specify: Model | Worksurface Solid Surface

Model	Worksurface Solid Surface
	see Forge Solid Surface Finishes

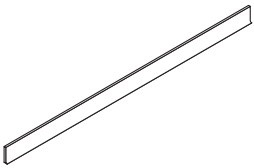
Description	D	W	H	CTN WT	CU FT	① Model	Tier 1	Tier 2	Tier 3	Tier 4
Solid Surface Backsplash (continued) 	½	48	4	7	1	40C148BS	\$338	\$375	\$439	\$541
	½	47	4	7	1	40C147BS	\$335	\$372	\$436	\$536
	½	46	4	6	1	40C146BS	\$333	\$370	\$433	\$533
	½	45	4	6	1	40C145BS	\$331	\$367	\$430	\$530
	½	44	4	6	1	40C144BS	\$328	\$364	\$426	\$525
	½	43	4	6	1	40C143BS	\$326	\$362	\$424	\$522
	½	42	4	6	1	40C142BS	\$324	\$360	\$421	\$518
	½	41	4	6	1	40C141BS	\$321	\$356	\$417	\$514
	½	40	4	6	1	40C140BS	\$319	\$354	\$415	\$510
	½	39	4	5	1	40C139BS	\$317	\$352	\$412	\$507
	½	38	4	5	1	40C138BS	\$314	\$349	\$408	\$502
	½	37	4	5	1	40C137BS	\$312	\$346	\$406	\$499
	½	36	4	5	1	40C136BS	\$310	\$344	\$403	\$496
	½	35	4	5	1	40C135BS	\$303	\$336	\$394	\$485
	½	34	4	5	1	40C134BS	\$297	\$330	\$386	\$475
	½	33	4	5	1	40C133BS	\$291	\$323	\$378	\$466
	½	32	4	5	1	40C132BS	\$285	\$316	\$371	\$456
	½	31	4	4	1	40C131BS	\$280	\$311	\$364	\$448
	½	30	4	4	1	40C130BS	\$275	\$305	\$358	\$440
	½	29	4	4	1	40C129BS	\$217	\$241	\$282	\$347
	½	28	4	4	1	40C128BS	\$215	\$239	\$280	\$344
	½	27	4	4	1	40C127BS	\$214	\$238	\$278	\$342
	½	26	4	4	1	40C126BS	\$212	\$235	\$276	\$339
	½	25	4	4	1	40C125BS	\$211	\$234	\$274	\$338
	½	24	4	4	1	40C124BS	\$209	\$232	\$272	\$334
	½	23	4	3	1	40C123BS	\$208	\$231	\$270	\$333
	½	22	4	3	1	40C122BS	\$206	\$229	\$268	\$330
	½	21	4	3	1	40C121BS	\$205	\$228	\$267	\$328
	½	20	4	3	1	40C120BS	\$203	\$225	\$264	\$325
	½	19	4	3	1	40C119BS	\$202	\$224	\$263	\$323
	½	18	4	3	1	40C118BS	\$200	\$222	\$260	\$320
	½	17	4	3	1	40C117BS	\$176	\$195	\$229	\$282
	½	16	4	2	1	40C116BS	\$173	\$192	\$225	\$277
½	15	4	2	1	40C115BS	\$169	\$188	\$220	\$270	
½	14	4	2	1	40C114BS	\$166	\$184	\$216	\$266	
½	13	4	2	1	40C113BS	\$163	\$181	\$212	\$261	
½	12	4	2	1	40C112BS	\$160	\$178	\$208	\$256	

Specify: Model | Worksurface Solid Surface

Model	Worksurface Solid Surface
	see Forge Solid Surface Finishes

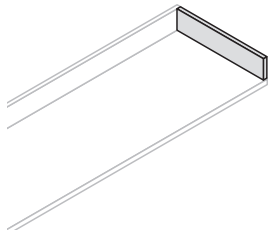
Description	D	W	H	CTN WT	CU FT	① Model	Tier 1	Tier 2	Tier 3	Tier 4	
Solid Surface Side Splash 	Right										
	½	23 ¾	4	3	1	40C123RSSS	\$237	\$263	\$308	\$379	
	½	18 ¾	4	3	1	40C118RSSS	\$200	\$222	\$260	\$320	
	Left										
	½	23 ¾	4	3	1	40C123LSSS	\$237	\$263	\$308	\$379	
	½	18 ¾	4	3	1	40C118LSSS	\$200	\$222	\$260	\$320	
<ul style="list-style-type: none"> • handed <p>Specify: Model Worksurface Solid Surface Side Splash</p>											

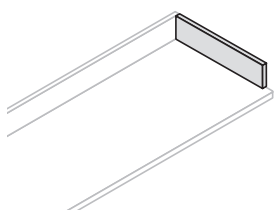
Solid Surface Side Splash Flush with Storage Cabinets 	Right										
	½	22 ½	4	3	1	40C123RSSFS	\$237	\$263	\$308	\$379	
	½	17 ½	4	3	1	40C118RSSFS	\$200	\$222	\$260	\$320	
	Left										
	½	22 ½	4	3	1	40C123LSSFS	\$237	\$263	\$308	\$379	
	½	17 ½	4	3	1	40C118LSSFS	\$200	\$222	\$260	\$320	
<ul style="list-style-type: none"> • handed • aligns flush with storage cabinet chassis <p>Specify: Model Worksurface Solid Surface Side Splash</p>											

Model	Worksurface Solid Surface	Side Splash
	see Forge Solid Surface Finishes	CIBS Compatible with Integrated Backsplash CSBS Compatible with Straight Backsplash

Description	D	W	H	CTN WT	CU FT	① Model	List
Worksurface Waste Ring	6 ¾	6 ¾	2	1	1	GPWSWR	\$369



- use with laminate and solid surface tops
- field cut and installed
- stainless steel finish

Specify: Model

Worksurface Bracket	15	1 ¾	18	3	1	GPWSBRKT18W (White)	\$463
	15	1 ¾	18	3	1	GPWSBRKT18B (Black)	\$463

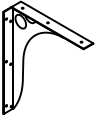

- used with 19½" or 24½"d surfaces
- includes hardware to attach to worksurface
- hardware to attach to wall is not included

Specify: Model

L-Bracket	1	21	1	4	1	GPLBRKT24	\$97
	1	17	1	3	1	GPLBRKT20	\$92

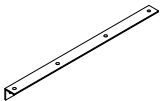

- GPLBRKT24 should be used with 24 ½"d worksurface
- GPLBRKT20 should be used with 19 ½"d worksurface
- attaches to the wall or storage cabinet
- one GPLBRKT20 is required with corner worksurface
- silver finish

Specify: Model

Edge Support	1 ⅙	2	1 ⅙	1	1	GPLBRKT04	\$12
---------------------	-----	---	-----	---	---	------------------	------



- two brackets may be used in place of L-bracket to attach worksurface to storage cabinet
- two brackets are required with base end panel
- one bracket may be used to anchor end panel to the wall
- black finish

Specify: Model

Flat Bracket	2	6		1	1	GPFBRKT	\$17
---------------------	---	---	--	---	---	----------------	------



- required for use with corner worksurface
- two brackets are required at each seam
- black finish

Specify: Model

Support Rail	2	43	¾	3	1	GP0243SB	\$80
	2	37	¾	3	1	GP0237SB	\$76



- GP0243SB used where unsupported width span is 43" to 50"
- GP0237SB used for unsupported width span of 37" to 43"
- black finish

Specify: Model

Support Bracket for End Panel	9 ⅙	1	9 ⅙	2	1	GPEPSB	\$96
--------------------------------------	-----	---	-----	---	---	---------------	------

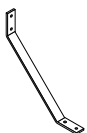

- used to support base end panels that are not attached to the wall
- black finish

Specify: Model

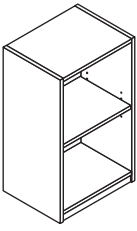
Description	D	W	H	CTN WT	CU FT	① Model	List
 <p>Open Upper Cabinet</p>	13 ¾	36	30	69	12	40C143630UCT	\$785
	13 ¾	30	30	61	10	40C143030UCT	\$708
	13 ¾	24	30	52	8	40C142430UCT	\$632
	13 ¾	21	30	47	7	40C142130UCT	\$556
	13 ¾	18	30	43	6	40C141830UCT	\$480
	13 ¾	15	30	38	5	40C141530UCT	\$420
	13 ¾	12	30	34	5	40C141230UCT	\$365
	13 ¾	36	24	61	9	40C143624UCT	\$722
	13 ¾	30	24	53	8	40C143024UCT	\$655
	13 ¾	24	24	45	7	40C142424UCT	\$595
	13 ¾	21	24	41	6	40C142124UCT	\$535
	13 ¾	18	24	37	5	40C141824UCT	\$475
	13 ¾	15	24	33	4	40C141524UCT	\$415
	13 ¾	12	24	29	4	40C141224UCT	\$355

• one adjustable shelf

Specify: Model | Chassis Laminate

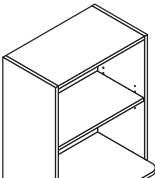
 <p>Open Upper Microwave Shelf Cabinet</p>	17 ¾	36	30	72	12	40C143630UCMT	\$850
	17 ¾	30	30	63	10	40C143030UCMT	\$795
	17 ¾	24	30	54	8	40C142430UCMT	\$740
	17 ¾	36	24	64	9	40C143624UCMT	\$787
	17 ¾	30	24	56	8	40C143024UCMT	\$720
	17 ¾	24	24	47	7	40C142424UCMT	\$660

• one adjustable shelf

Specify: Model | Chassis Laminate

Model	Chassis Laminate
	see Forge Laminate Finishes

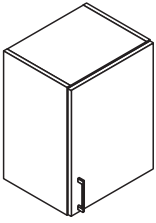
Description	D	W	H	CTN WT	CU FT	Model	List
 <p>right shown</p>	30" h Right Hinged						
	14 ½	24	30	67	8	40C152430UCDRT	\$1,011
	14 ½	21	30	61	7	40C152130UCDRT	\$938
	14 ½	18	30	54	7	40C151830UCDRT	\$865
	14 ½	15	30	48	6	40C151530UCDRT	\$793
	14 ½	12	30	41	5	40C151230UCDRT	\$720
	30" h Left Hinged						
	14 ½	24	30	67	8	40C152430UCDLT	\$1,011
	14 ½	21	30	61	7	40C152130UCDLT	\$938
	14 ½	18	30	54	7	40C151830UCDLT	\$865
	14 ½	15	30	48	6	40C151530UCDLT	\$793
	14 ½	12	30	41	5	40C151230UCDLT	\$720
	24" h Right Hinged						
	14 ½	24	24	57	7	40C152424UCDRT	\$945
	14 ½	21	24	52	6	40C152124UCDRT	\$875
	14 ½	18	24	46	5	40C151824UCDRT	\$805
	14 ½	15	24	40	5	40C151524UCDRT	\$735
	14 ½	12	24	35	4	40C151224UCDRT	\$665
	24" h Left Hinged						
	14 ½	24	24	57	7	40C152424UCDLT	\$945
14 ½	21	24	52	6	40C152124UCDLT	\$875	
14 ½	18	24	46	5	40C151824UCDLT	\$805	
14 ½	15	24	40	5	40C151524UCDLT	\$735	
14 ½	12	24	35	4	40C151224UCDLT	\$665	

• one adjustable shelf

Specify: Model | Chassis Laminate | Door Laminate | Pull | Lock

Model	Chassis Laminate	Door Laminate	Pull	Lock
	see Forge Laminate Finishes	see Forge Laminate Finishes	P001 Bar see Bar Pull Color P005 Delve see Delve Pull Color P011 Prospect see Prospect Pull Color P003 Sweep see Sweep Pull Color	NLK No Lock KLK Standard - add \$78 ASL Arctic Silver MBK Matte Black DLK Keyless Lock - add \$232

Description	D	W	H	CTN WT	CU FT	Model	List
Upper Door Cabinet with Glove Box	14 ½	24	30	67	8	40C152430UCDGBT	\$1,105
	14 ½	21	30	61	7	40C152130UCDGBT	\$1,070
	14 ½	18	30	54	7	40C151830UCDGBT	\$1,035
	14 ½	24	24	57	7	40C152424UCDGBT	\$1,000
	14 ½	21	24	52	6	40C152124UCDGBT	\$965
	14 ½	18	24	46	5	40C151824UCDGBT	\$930

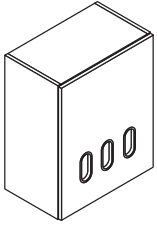

- one fixed shelf
- metal glove box holder is included
- zinc oval glove grommet size 6 ½" x 3" x 13/16"
- 24" & 21"w units have 3 glove box openings
- 18"w units have 2 glove box openings

Specify: Model | Chassis Laminate | Door Laminate | Lock | Waste Grommet Color

Model	Chassis Laminate	Door Laminate	Lock	Waste Grommet Color
	see Forge Laminate Finishes	see Forge Laminate Finishes	NLK No Lock KLK Standard - add \$78 ASL Arctic Silver MBK Matte Black	MBK Matte Black SNK Soft Nickel

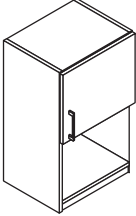
Description	D	W	H	CTN WT	CU FT	Model	List
Upper Door with Open Shelf Cabinet  right shown	Right Hinged						
	14 ½	24	30	59	8	40C152430UCHDRT	\$855
	14 ½	21	30	54	7	40C152130UCHDRT	\$790
	14 ½	18	30	48	7	40C151830UCHDRT	\$725
	14 ½	15	30	43	6	40C151530UCHDRT	\$660
	14 ½	12	30	37	5	40C151230UCHDRT	\$595
	Left Hinged						
	14 ½	24	30	59	8	40C152430UCHDLT	\$855
	14 ½	21	30	54	7	40C152130UCHDLT	\$790
	14 ½	18	30	48	7	40C151830UCHDLT	\$725
	14 ½	15	30	43	6	40C151530UCHDLT	\$660
14 ½	12	30	37	5	40C151230UCHDLT	\$595	

- one adjustable shelf

Specify: Model | Chassis Laminate | Door Laminate | Pull | Lock

Model	Chassis Laminate	Door Laminate	Pull	Lock
	see Forge Laminate Finishes	see Forge Laminate Finishes	P001 Bar see Bar Pull Color P005 Delve see Delve Pull Color P011 Prospect see Prospect Pull Color P003 Sweep see Sweep Pull Color	NLK No Lock KLK Standard - add \$78 ASL Arctic Silver MBK Matte Black DLK Keyless Lock - add \$232

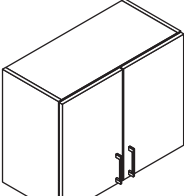
Description	D	W	H	CTN WT	CU FT	Model	List
	14 ½	36	30	92	12	40C153630UCDT	\$1,280
	14 ½	30	30	80	10	40C153030UCDT	\$1,180
	14 ½	24	30	67	8	40C152430UCDT	\$1,080
	14 ½	36	24	80	10	40C153624UCDT	\$1,175
	14 ½	30	24	69	8	40C153024UCDT	\$1,075
	14 ½	24	24	57	7	40C152424UCDT	\$975

• one adjustable shelf

Specify: Model | Chassis Laminate | Door Laminate | Pull | Lock

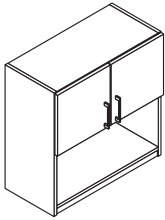
	14 ½	36	30	81	12	40C153630UCHDHT	\$1,070
	14 ½	30	30	70	10	40C153030UCHDHT	\$980
	14 ½	24	30	59	8	40C152430UCHDHT	\$890

• one adjustable shelf

Specify: Model | Chassis Laminate | Door Laminate | Pull | Lock

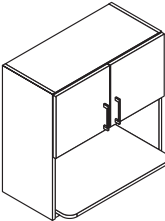
	17 ¾	36	30	84	12	40C153630UCHDMT	\$1,141
	17 ¾	30	30	72	10	40C153030UCHDMT	\$1,060
	17 ¾	24	30	61	8	40C152430UCHDMT	\$980

Specify: Model | Chassis Laminate | Door Laminate | Pull | Lock

Model	Chassis Laminate	Door Laminate	Pull	Lock
	see Forge Laminate Finishes	see Forge Laminate Finishes	P001 Bar see Bar Pull Color P005 Delve see Delve Pull Color P011 Prospect see Prospect Pull Color P003 Sweep see Sweep Pull Color	NLK No Lock KLK Standard - add \$78 ASL Arctic Silver MBK Matte Black DLK Keyless Lock - add \$256

Description	D	W	H	CTN WT	CU FT	① Model	List
Upper Filler	13 ¾	6	30	4	3	40C14630UFT	\$191
	13 ¾	6	24	4	2	40C14624UFT	\$145

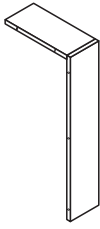

- includes brackets to attach to cabinet
- may be field scribed as needed

Specify: Model | Chassis Laminate

Model	Chassis Laminate
	see Forge Laminate Finishes

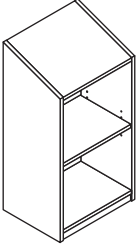
Description	D	W	H	CTN WT	CU FT	Model	List
Sloped Top Open Upper Cabinet 	13 ¾	36	35	72	13	40C143635UCST	\$865
	13 ¾	30	35	63	11	40C143035UCST	\$792
	13 ¾	24	35	53	9	40C142435UCST	\$722
	13 ¾	21	35	49	8	40C142135UCST	\$652
	13 ¾	18	35	44	7	40C141835UCST	\$582
	13 ¾	15	35	40	6	40C141535UCST	\$512
	13 ¾	12	35	35	5	40C141235UCST	\$442
	13 ¾	36	29	64	11	40C143629UCST	\$795
	13 ¾	30	29	55	9	40C143029UCST	\$722
	13 ¾	24	29	47	8	40C142429UCST	\$649
	13 ¾	21	29	43	7	40C142129UCST	\$576
	13 ¾	18	29	39	6	40C141829UCST	\$503
	13 ¾	15	29	35	5	40C141529UCST	\$430
	13 ¾	12	29	30	4	40C141229UCST	\$370

• one adjustable shelf

Specify: Model | Chassis Laminate

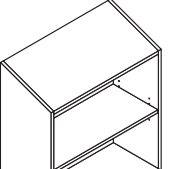
Sloped Top Open Upper Microwave Shelf Cabinet 	17 ¾	36	35	13	75	40C143635UCSMT	\$1,081
	17 ¾	30	35	11	65	40C143035UCSMT	\$1,008
	17 ¾	24	35	9	55	40C142435UCSMT	\$938
	17 ¾	36	29	11	67	40C143629UCSMT	\$865
	17 ¾	30	29	9	58	40C143029UCSMT	\$792
	17 ¾	24	29	8	49	40C142429UCSMT	\$719

• one adjustable shelf

Specify: Model | Chassis Laminate

Model	Chassis Laminate
	see Forge Laminate Finishes

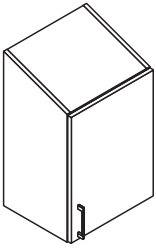
Description	D	W	H	CTN WT	CU FT	Model	List
 <p>right shown</p>	35" h Right Hinged						
	14 ½	24	35	69	10	40C152435UCDSRT	\$1,086
	14 ½	21	35	62	9	40C152135UCDSRT	\$1,013
	14 ½	18	35	56	8	40C151835UCDSRT	\$940
	14 ½	15	35	49	6	40C151535UCDSRT	\$867
	14 ½	12	35	43	5	40C151235UCDSRT	\$794
	35" h Left Hinged						
	14 ½	24	35	69	10	40C152435UCDSL	\$1,086
	14 ½	21	35	62	9	40C152135UCDSL	\$1,013
	14 ½	18	35	56	8	40C151835UCDSL	\$940
	14 ½	15	35	49	6	40C151535UCDSL	\$867
	14 ½	12	35	43	5	40C151235UCDSL	\$794
	29" h Right Hinged						
	14 ½	24	29	59	8	40C152429UCDSRT	\$1,014
	14 ½	21	29	54	7	40C152129UCDSRT	\$941
	14 ½	18	29	48	6	40C151829UCDSRT	\$868
	14 ½	15	29	42	5	40C151529UCDSRT	\$795
	14 ½	12	29	36	5	40C151229UCDSRT	\$722
	29" h Left Hinged						
	14 ½	24	29	59	8	40C152429UCDSL	\$1,014
14 ½	21	29	54	7	40C152129UCDSL	\$941	
14 ½	18	29	48	6	40C151829UCDSL	\$868	
14 ½	15	29	42	5	40C151529UCDSL	\$795	
14 ½	12	29	36	5	40C151229UCDSL	\$722	

• one adjustable shelf

Specify: Model | Chassis Laminate | Door Laminate | Pull | Lock

Model	Chassis Laminate	Door Laminate	Pull	Lock
	see Forge Laminate Finishes	see Forge Laminate Finishes	P001 Bar see Bar Pull Color P005 Delve see Delve Pull Color P011 Prospect see Prospect Pull Color P003 Sweep see Sweep Pull Color	NLK No Lock KLK Standard - add \$78 ASL Arctic Silver MBK Matte Black DLK Keyless Lock - add \$232

Description	D	W	H	CTN WT	CU FT	Model	List
Sloped Top Upper Door Cabinet with Glove Box	14 ½	24	35	69	10	40C152435UCDGBST	\$1,240
	14 ½	21	35	62	9	40C152135UCDGBST	\$1,185
	14 ½	18	35	56	8	40C151835UCDGBST	\$1,130
	14 ½	24	29	59	8	40C152429UCDGBST	\$1,105
	14 ½	21	29	54	7	40C152129UCDGBST	\$1,070
	14 ½	18	29	54	7	40C151829UCDGBST	\$1,035

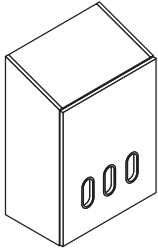

- one fixed shelf
- metal glove box holder is included
- zinc oval glove grommet size 6 ½" x 3" x 13/16"
- 24" & 21"w units have 3 glove box openings
- 18"w units have 2 glove box openings

Specify: Model | Chassis Laminate | Door Laminate | Lock | Waste Grommet Color

Model	Chassis Laminate	Door Laminate	Lock	Waste Grommet Color
	see Forge Laminate Finishes	see Forge Laminate Finishes	NLK No Lock KLK Standard - add \$78 ASL Arctic Silver MBK Matte Black	MBK Matte Black SNK Soft Nickel

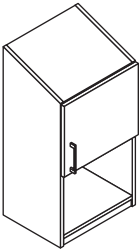
Description	D	W	H	CTN WT	CU FT	Model	List
Sloped Top Upper Door with Open Shelf Cabinet  right shown	Right Hinged						
	14 ½	24	35	61	10	40C152435UCHDSRT	\$990
	14 ½	21	35	56	9	40C152135UCHDSRT	\$900
	14 ½	18	35	50	8	40C151835UCHDSRT	\$810
	14 ½	15	35	45	6	40C151535UCHDSRT	\$730
	14 ½	12	35	39	5	40C151235UCHDSRT	\$640
	Left Hinged						
	14 ½	24	35	61	10	40C152435UCHDSL	\$990
	14 ½	21	35	56	9	40C152135UCHDSL	\$900
	14 ½	18	35	50	8	40C151835UCHDSL	\$810
14 ½	15	35	45	6	40C151535UCHDSL	\$730	
14 ½	12	35	39	5	40C151235UCHDSL	\$640	

• one adjustable shelf

Specify: Model | Chassis Laminate | Door Laminate | Pull | Lock

Model	Chassis Laminate	Door Laminate	Pull	Lock
	see Forge Laminate Finishes	see Forge Laminate Finishes	P001 Bar see Bar Pull Color P005 Delve see Delve Pull Color P011 Prospect see Prospect Pull Color P003 Sweep see Sweep Pull Color	NLK No Lock KLK Standard - add \$78 ASL Arctic Silver MBK Matte Black DLK Keyless Lock - add \$232

Description	D	W	H	CTN WT	CU FT	Model	List
Sloped Top Two Door Upper Cabinet	14 ½	36	35	95	14	40C153635UCDST	\$1,380
	14 ½	30	35	82	12	40C153035UCDST	\$1,280
	14 ½	24	35	69	10	40C152435UCDST	\$1,175
	14 ½	36	29	82	12	40C153629UCDST	\$1,275
	14 ½	30	29	71	10	40C153029UCDST	\$1,170
	14 ½	24	29	59	8	40C152429UCDST	\$1,065

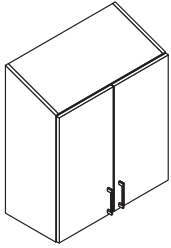

• one adjustable shelf

Specify: Model | Chassis Laminate | Door Laminate | Pull | Lock

Sloped Top Two Doors with Open Shelf Cabinet	14 ½	36	35	83	14	40C153635UCHDST	\$1,233
	14 ½	30	35	72	12	40C153035UCHDST	\$1,005
	14 ½	24	35	61	10	40C152435UCHDST	\$925

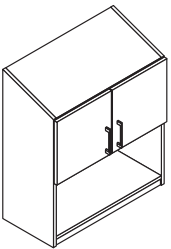

• one adjustable shelf

Specify: Model | Chassis Laminate | Door Laminate | Pull | Lock

Sloped Top Two Doors with Microwave Shelf Cabinet	18 ½	36	35	86	14	40C153635UCHDSMT	\$1,305
	18 ½	30	35	74	12	40C153035UCHDSMT	\$1,140
	18 ½	24	35	63	10	40C152435UCHDSMT	\$1,105

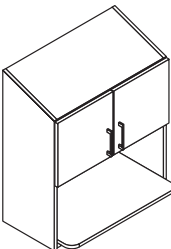

Specify: Model | Chassis Laminate | Door Laminate | Pull | Lock

Model	Chassis Laminate	Door Laminate	Pull	Lock
	see Forge Laminate Finishes	see Forge Laminate Finishes	P001 Bar see Bar Pull Color P005 Delve see Delve Pull Color P011 Prospect see Prospect Pull Color P003 Sweep see Sweep Pull Color	NLK No Lock KLK Standard - add \$78 ASL Arctic Silver MBK Matte Black DLK Keyless Lock - add \$256

Description	D	W	H	CTN WT	CU FT	① Model	List
Sloped Top Upper Filler	13 ¾	6	35	6	3	40C14635UFST	\$202
	13 ¾	6	29	5	3	40C14629UFST	\$191

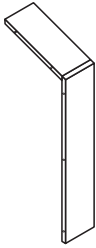

- includes brackets to attach to cabinet
- may be field scribed as needed

Specify: Model | Chassis Laminate

Model	Chassis Laminate
	see Forge Laminate Finishes

24"d Models

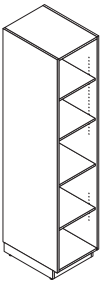
Description	D	W	H	CTN WT	CU FT	① Model	List
 <p>1 fixed & 3 adjustable shelves shown</p>	23 ½	36	84	246	49	40C243684SCOT	\$2,495
	23 ½	30	84	218	41	40C243084SCOT	\$2,350
	23 ½	24	84	190	33	40C242484SCOT	\$2,200
	23 ½	21	84	176	30	40C242184SCOT	\$2,050
	23 ½	18	84	162	26	40C241884SCOT	\$1,895
	23 ½	15	84	148	22	40C241584SCOT	\$1,745
	23 ½	12	84	134	18	40C241284SCOT	\$1,595
	23 ½	36	78	236	45	40C243678SCOT	\$2,210
	23 ½	30	78	209	38	40C243078SCOT	\$2,095
	23 ½	24	78	182	31	40C242478SCOT	\$1,980
	23 ½	21	78	168	28	40C242178SCOT	\$1,863
	23 ½	18	78	155	24	40C241878SCOT	\$1,748
	23 ½	15	78	141	21	40C241578SCOT	\$1,633
	23 ½	12	78	127	17	40C241278SCOT	\$1,518

Specify: Model | Chassis Laminate | Interior Configuration

19"d Models

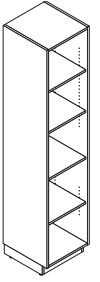
Description	D	W	H	CTN WT	CU FT	① Model	List
 <p>1 fixed & 3 adjustable shelves shown</p>	18 ½	36	84	229	39	40C193684SCOT	\$2,258
	18 ½	30	84	201	33	40C193084SCOT	\$2,110
	18 ½	24	84	173	27	40C192484SCOT	\$1,965
	18 ½	21	84	159	24	40C192184SCOT	\$1,820
	18 ½	18	84	145	21	40C191884SCOT	\$1,675
	18 ½	15	84	131	18	40C191584SCOT	\$1,525
	18 ½	12	84	116	15	40C191284SCOT	\$1,375
	18 ½	36	78	220	37	40C193678SCOT	\$1,970
	18 ½	30	78	193	31	40C193078SCOT	\$1,855
	18 ½	24	78	166	25	40C192478SCOT	\$1,740
	18 ½	21	78	152	22	40C192178SCOT	\$1,695
	18 ½	18	78	139	19	40C191878SCOT	\$1,580
	18 ½	15	78	125	17	40C191578SCOT	\$1,465
	18 ½	12	78	111	14	40C191278SCOT	\$1,350

Specify: Model | Chassis Laminate | Interior Configuration

Model	Chassis Laminate	Interior Configuration
	see Forge Laminate Finishes	CH Coat Hook CR2FS Coat Rod & 2 Fixed Shelves - add \$42 1F3AS 1 Fixed & 3 Adjustable Shelves - add \$150

24"d Models

Description	D	W	H	CTN WT	CU FT	Model	List
 right shown	84"h Right Hinged						
	24 ¼	24	84	231	33	40C242484SCDRT	\$2,510
	24 ¼	21	84	212	30	40C242184SCDRT	\$2,365
	24 ¼	18	84	193	26	40C241884SCDRT	\$2,217
	24 ¼	15	84	174	22	40C241584SCDRT	\$2,010
	24 ¼	12	84	154	18	40C241284SCDRT	\$1,860
	84"h Left Hinged						
	24 ¼	24	84	231	33	40C242484SCDLT	\$2,510
	24 ¼	21	84	212	30	40C242184SCDLT	\$2,365
	24 ¼	18	84	193	26	40C241884SCDLT	\$2,217
	24 ¼	15	84	174	22	40C241584SCDLT	\$2,010
	24 ¼	12	84	154	18	40C241284SCDLT	\$1,860
	78"h Right Hinged						
	24 ¼	24	78	220	31	40C242478SCDRT	\$2,229
	24 ¼	21	78	202	28	40C242178SCDRT	\$2,134
	24 ¼	18	78	183	24	40C241878SCDRT	\$2,039
	24 ¼	15	78	165	21	40C241578SCDRT	\$1,924
	24 ¼	12	78	146	17	40C241278SCDRT	\$1,810
	78"h Left Hinged						
	24 ¼	24	78	220	31	40C242478SCDLT	\$2,229
24 ¼	21	78	202	28	40C242178SCDLT	\$2,134	
24 ¼	18	78	183	24	40C241878SCDLT	\$2,039	
24 ¼	15	78	165	21	40C241578SCDLT	\$1,924	
24 ¼	12	78	146	17	40C241278SCDLT	\$1,810	

Specify: Model | Chassis Laminate | Door Laminate | Interior Configuration | Pull | Lock

Model	Chassis Laminate	Door Laminate	Interior Configuration	Pull	Lock
	see Forge Laminate Finishes	see Forge Laminate Finishes	CH Coat Hook CR2FS Coat Rod & 2 Fixed Shelves - add \$42 1F3AS 1 Fixed & 3 Adjustable Shelves - add \$150	P001 Bar see Bar Pull Color P005 Delve see Delve Pull Color P011 Prospect see Prospect Pull Color P003 Sweep see Sweep Pull Color	NLK No Lock KLK Standard - add \$78 ASL Arctic Silver MBK Matte Black DLK Keyless Lock - add \$232

19"d Models

Description	D	W	H	CTN WT	CU FT	Model	List
 <p>right shown</p>	84"h Right Hinged						
	19 ¼	24	84	214	27	40C192484SCDRT	\$2,270
	19 ¼	21	84	195	24	40C192184SCDRT	\$2,055
	19 ¼	18	84	176	21	40C191884SCDRT	\$1,940
	19 ¼	15	84	156	18	40C191584SCDRT	\$1,805
	19 ¼	12	84	137	15	40C191284SCDRT	\$1,700
	84"h Left Hinged						
	19 ¼	24	84	214	27	40C192484SCDLT	\$2,270
	19 ¼	21	84	195	24	40C192184SCDLT	\$2,055
	19 ¼	18	84	176	21	40C191884SCDLT	\$1,940
	19 ¼	15	84	156	18	40C191584SCDLT	\$1,805
	19 ¼	12	84	137	15	40C191284SCDLT	\$1,700
	78"h Right Hinged						
	19 ¼	24	78	204	25	40C192478SCDRT	\$1,995
	19 ¼	21	78	186	22	40C192178SCDRT	\$1,880
	19 ¼	18	78	167	19	40C191878SCDRT	\$1,775
	19 ¼	15	78	149	17	40C191578SCDRT	\$1,695
	19 ¼	12	78	130	14	40C191278SCDRT	\$1,609
	78"h Left Hinged						
	19 ¼	24	78	204	25	40C192478SCDLT	\$1,995
19 ¼	21	78	186	22	40C192178SCDLT	\$1,880	
19 ¼	18	78	167	19	40C191878SCDLT	\$1,775	
19 ¼	15	78	149	17	40C191578SCDLT	\$1,695	
19 ¼	12	78	130	14	40C191278SCDLT	\$1,609	

Specify: Model | Chassis Laminate | Door Laminate | Interior Configuration | Pull | Lock

Model	Chassis Laminate	Door Laminate	Interior Configuration	Pull	Lock
	see Forge Laminate Finishes	see Forge Laminate Finishes	CH Coat Hook CR2FS Coat Rod & 2 Fixed Shelves - add \$42 1F3AS 1 Fixed & 3 Adjustable Shelves - add \$150	P001 Bar see Bar Pull Color P005 Delve see Delve Pull Color P011 Prospect see Prospect Pull Color P003 Sweep see Sweep Pull Color	NLK No Lock KLK Standard - add \$78 ASL Arctic Silver MBK Matte Black DLK Keyless Lock - add \$232

24"d Models

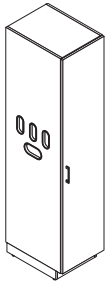
Description	D	W	H	CTN WT	CU FT	Model	List
Storage Cabinet with Glove Box  right shown	84"h Right Hinged						
	24 ¼	24	84	231	33	40C242484SCDGBRT	\$2,750
	24 ¼	21	84	212	30	40C242184SCDGBRT	\$2,605
	24 ¼	18	84	193	26	40C241884SCDGBRT	\$2,457
	24 ¼	15	84	174	22	40C241584SCDGBRT	\$2,312
	24 ¼	12	84	154	18	40C241284SCDGBRT	\$2,167
	84"h Left Hinged						
	24 ¼	24	84	231	33	40C242484SCDGBLT	\$2,750
	24 ¼	21	84	212	30	40C242184SCDGBLT	\$2,605
	24 ¼	18	84	193	26	40C241884SCDGBLT	\$2,457
24 ¼	15	84	174	22	40C241584SCDGBLT	\$2,312	
24 ¼	12	84	154	18	40C241284SCDGBLT	\$2,167	
78"h Right Hinged							
24 ¼	24	78	220	31	40C242478SCDGBRT	\$2,509	
24 ¼	21	78	202	28	40C242178SCDGBRT	\$2,394	
24 ¼	18	78	183	24	40C241878SCDGBRT	\$2,279	
24 ¼	15	78	165	21	40C241578SCDGBRT	\$2,164	
24 ¼	12	78	146	17	40C241278SCDGBRT	\$2,050	
78"h Left Hinged							
24 ¼	24	78	220	31	40C242478SCDGBLT	\$2,509	
24 ¼	21	78	202	28	40C242178SCDGBLT	\$2,394	
24 ¼	18	78	183	24	40C241878SCDGBLT	\$2,279	
24 ¼	15	78	165	21	40C241578SCDGBLT	\$2,164	
24 ¼	12	78	146	17	40C241278SCDGBLT	\$2,050	

- metal glove box holder is included
- glove grommet size 6 ½" x 3" x 13/16" - zinc oval grommet
- waste grommet size 7 ½" x 4" x 13/16" - zinc oval grommet

Specify: Model | Chassis Laminate | Door Laminate | Pull | Lock | Waste Grommet Color

Model	Chassis Laminate	Door Laminate	Pull	Lock	Waste Grommet Color
	see Forge Laminate Finishes	see Forge Laminate Finishes	P001 Bar see Bar Pull Color P005 Delve see Delve Pull Color P011 Prospect see Prospect Pull Color P003 Sweep see Sweep Pull Color	NLK No Lock KLK Standard - add \$78 ASL Arctic Silver MBK Matte Black DLK Keyless Lock - add \$232	MBK Matte Black SNK Soft Nickel

19"d Models

Description	D	W	H	CTN WT	CU FT	Model	List
Storage Cabinet with Glove Box  right shown	84"h Right Hinged						
	19 ¼	24	84	214	27	40C192484SCDGBRT	\$2,495
	19 ¼	21	84	195	24	40C192184SCDGBRT	\$2,362
	19 ¼	18	84	176	21	40C191884SCDGBRT	\$2,195
	19 ¼	15	84	156	18	40C191584SCDGBRT	\$2,058
	19 ¼	12	84	137	15	40C191284SCDGBRT	\$1,943
	84"h Left Hinged						
	19 ¼	24	84	214	27	40C192484SCDGBLT	\$2,495
	19 ¼	21	84	195	24	40C192184SCDGBLT	\$2,362
	19 ¼	18	84	176	21	40C191884SCDGBLT	\$2,195
19 ¼	15	84	156	18	40C191584SCDGBLT	\$2,058	
19 ¼	12	84	137	15	40C191284SCDGBLT	\$1,943	
78"h Right Hinged							
19 ¼	24	78	204	25	40C192478SCDGBRT	\$2,285	
19 ¼	21	78	186	22	40C192178SCDGBRT	\$2,170	
19 ¼	18	78	167	19	40C191878SCDGBRT	\$2,055	
19 ¼	15	78	149	17	40C191578SCDGBRT	\$1,940	
19 ¼	12	78	130	14	40C191278SCDGBRT	\$1,850	
78"h Left Hinged							
19 ¼	24	78	204	25	40C192478SCDGBLT	\$2,285	
19 ¼	21	78	186	22	40C192178SCDGBLT	\$2,170	
19 ¼	18	78	167	19	40C191878SCDGBLT	\$2,055	
19 ¼	15	78	149	17	40C191578SCDGBLT	\$1,940	
19 ¼	12	78	130	14	40C191278SCDGBLT	\$1,850	

• metal glove box holder is included

Specify: Model | Chassis Laminate | Door Laminate | Pull | Lock | Waste Grommet Color

Model	Chassis Laminate	Door Laminate	Pull	Lock	Waste Grommet Color
	see Forge Laminate Finishes	see Forge Laminate Finishes	P001 Bar see Bar Pull Color P005 Delve see Delve Pull Color P011 Prospect see Prospect Pull Color P003 Sweep see Sweep Pull Color	NLK No Lock KLK Standard - add \$78 ASL Arctic Silver MBK Matte Black DLK Keyless Lock - add \$232	MBK Matte Black SNK Soft Nickel

24"d Models

Description	D	W	H	CTN WT	CU FT	① Model	List
Storage Cabinet with Doors	24 ¼	36	84	308	49	40C243684SCDT	\$3,160
	24 ¼	30	84	270	41	40C243084SCDT	\$3,025
	24 ¼	36	78	294	45	40C243678SCDT	\$2,885
	24 ¼	30	78	257	38	40C243078SCDT	\$2,750

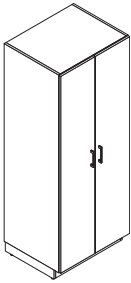

Specify: Model | Chassis Laminate | Door Laminate | Interior Configuration | Pull | Lock

19"d Models

Description	D	W	H	CTN WT	CU FT	① Model	List
Storage Cabinet with Doors	19 ¼	36	84	291	39	40C193684SCDT	\$2,920
	19 ¼	30	84	252	33	40C193084SCDT	\$2,785
	19 ¼	36	78	278	37	40C193678SCDT	\$2,705
	19 ¼	30	78	241	31	40C193078SCDT	\$2,570

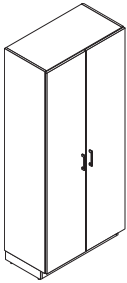

Specify: Model | Chassis Laminate | Door Laminate | Interior Configuration | Pull | Lock

Model	Chassis Laminate	Door Laminate	Interior Configuration	Pull	Lock
	see Forge Laminate Finishes	see Forge Laminate Finishes	CH Coat Hook CR2FS Coat Rod & 2 Fixed Shelves - add \$42 1F3AS 1 Fixed & 3 Adjustable Shelves - add \$150	P001 Bar see Bar Pull Color P005 Delve see Delve Pull Color P011 Prospect see Prospect Pull Color P003 Sweep see Sweep Pull Color	NLK No Lock KLK Standard - add \$102 ASL Arctic Silver MBK Matte Black DLK Keyless Lock - add \$256

24"d Models

Description	D	W	H	CTN WT	CU FT	① Model	List
Storage Filler	23 ½	6	84	0	0	40C24684SFT	\$335
	23 ½	6	78	0	0	40C24678SFT	\$320

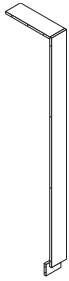

- includes brackets to attach to cabinet
- may be field scribed as needed

Specify: Model | Chassis Laminate

19"d Models

Description	D	W	H	CTN WT	CU FT	① Model	List
Storage Filler	19 ¼	6	84	7	9	40C19684SFT	\$322
	19 ¼	6	78	7	8	40C19678SFT	\$305

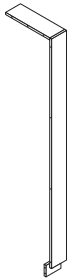

- includes brackets to attach to cabinet
- may be field scribed as needed

Specify: Model | Chassis Laminate

Model	Chassis Laminate
	see Forge Laminate Finishes

24"d Models

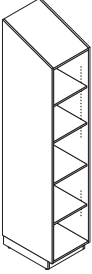
Description	D	W	H	CTN WT	CU FT	Model	List
 <p>Sloped Top Open Storage Cabinet</p> <p>1 fixed & 3 adjustable shelves shown</p>	23 ½	36	92 ½	258	53	40C243693SCSOT	\$2,550
	23 ½	30	92 ½	229	45	40C243093SCSOT	\$2,400
	23 ½	24	92 ½	199	37	40C242493SCSOT	\$2,250
	23 ½	21	92 ½	185	33	40C242193SCSOT	\$2,110
	23 ½	18	92 ½	170	28	40C241893SCSOT	\$1,960
	23 ½	15	92 ½	155	24	40C241593SCSOT	\$1,810
	23 ½	12	92 ½	140	20	40C241293SCSOT	\$1,660
	23 ½	36	86 ½	247	50	40C243687SCSOT	\$2,255
	23 ½	30	86 ½	219	42	40C243087SCSOT	\$2,140
	23 ½	24	86 ½	190	34	40C242487SCSOT	\$2,025
	23 ½	21	86 ½	176	30	40C242187SCSOT	\$1,910
	23 ½	18	86 ½	162	27	40C241887SCSOT	\$1,795
	23 ½	15	86 ½	147	23	40C241587SCSOT	\$1,680
	23 ½	12	86 ½	133	19	40C241287SCSOT	\$1,565

Specify: Model | Chassis Laminate | Interior Configuration

19"d Models

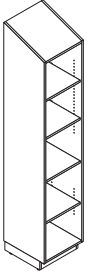
Description	D	W	H	CTN WT	CU FT	Model	List
 <p>Sloped Top Open Storage Cabinet</p> <p>1 fixed & 3 adjustable shelves shown</p>	18 ½	36	90 ¾	236	43	40C193691SCSOT	\$2,345
	18 ½	30	90 ¾	207	36	40C193091SCSOT	\$2,240
	18 ½	24	90 ¾	177	30	40C192491SCSOT	\$2,090
	18 ½	21	90 ¾	163	26	40C192191SCSOT	\$1,900
	18 ½	18	90 ¾	148	23	40C191891SCSOT	\$1,800
	18 ½	15	90 ¾	134	20	40C191591SCSOT	\$1,650
	18 ½	12	90 ¾	119	16	40C191291SCSOT	\$1,500
	18 ½	36	84 ¾	228	40	40C193685SCSOT	\$2,070
	18 ½	30	84 ¾	199	34	40C193085SCSOT	\$1,955
	18 ½	24	84 ¾	170	28	40C192485SCSOT	\$1,840
	18 ½	21	84 ¾	156	25	40C192185SCSOT	\$1,725
	18 ½	18	84 ¾	142	21	40C191885SCSOT	\$1,610
	18 ½	15	84 ¾	128	18	40C191585SCSOT	\$1,495
	18 ½	12	84 ¾	113	15	40C191285SCSOT	\$1,425

Specify: Model | Chassis Laminate | Interior Configuration

Model	Chassis Laminate	Interior Configuration
	see Forge Laminate Finishes	CH Coat Hook CR2FS Coat Rod & 2 Fixed Shelves - add \$42 1F3AS 1 Fixed & 3 Adjustable Shelves - add \$150

24"d Models

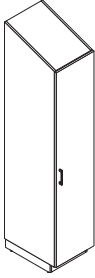
Description	D	W	H	CTN WT	CU FT	Model	List
 <p>right shown</p>	92 ½" h Right Hinged						
	24 ¼	24	92 ½	240	37	40C242493SCDSRT	\$2,540
	24 ¼	21	92 ½	221	33	40C242193SCDSRT	\$2,388
	24 ¼	18	92 ½	201	28	40C241893SCDSRT	\$2,244
	24 ¼	15	92 ½	181	24	40C241593SCDSRT	\$2,105
	24 ¼	12	92 ½	161	20	40C241293SCDSRT	\$1,961
	92 ½" h Left Hinged						
	24 ¼	24	92 ½	240	37	40C242493SCDSL	\$2,540
	24 ¼	21	92 ½	221	33	40C242193SCDSL	\$2,388
	24 ¼	18	92 ½	201	28	40C241893SCDSL	\$2,244
	24 ¼	15	92 ½	181	24	40C241593SCDSL	\$2,105
	24 ¼	12	92 ½	161	20	40C241293SCDSL	\$1,961
	86 ½" h Right Hinged						
	24 ¼	24	86 ½	228	34	40C242487SCDSRT	\$2,250
	24 ¼	21	86 ½	209	30	40C242187SCDSRT	\$2,140
24 ¼	18	86 ½	190	27	40C241887SCDSRT	\$2,120	
24 ¼	15	86 ½	171	23	40C241587SCDSRT	\$2,010	
24 ¼	12	86 ½	152	19	40C241287SCDSRT	\$1,810	
86 ½" h Left Hinged							
24 ¼	24	86 ½	228	34	40C242487SCDSL	\$2,250	
24 ¼	21	86 ½	209	30	40C242187SCDSL	\$2,140	
24 ¼	18	86 ½	190	27	40C241887SCDSL	\$2,120	
24 ¼	15	86 ½	171	23	40C241587SCDSL	\$2,010	
24 ¼	12	86 ½	152	19	40C241287SCDSL	\$1,810	

Specify: Model | Chassis Laminate | Door Laminate | Interior Configuration | Pull | Lock

Model	Chassis Laminate	Door Laminate	Interior Configuration	Pull	Lock
	see Forge Laminate Finishes	see Forge Laminate Finishes	CH Coat Hook CR2FS Coat Rod & 2 Fixed Shelves - add \$42 1F3AS 1 Fixed & 3 Adjustable Shelves - add \$150	P001 Bar see Bar Pull Color P005 Delve see Delve Pull Color P011 Prospect see Prospect Pull Color P003 Sweep see Sweep Pull Color	NLK No Lock KLK Standard - add \$78 ASL Arctic Silver MBK Matte Black DLK Keyless Lock - add \$232

19"d Models

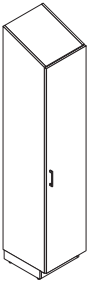
Description	D	W	H	CTN WT	CU FT	Model	List
 <p>right shown</p>	90 3/4"h Right Hinged						
	19 1/4	24	90 3/4	218	30	40C192491SCDSRT	\$2,330
	19 1/4	21	90 3/4	199	26	40C192191SCDSRT	\$2,228
	19 1/4	18	90 3/4	179	23	40C191891SCDSRT	\$2,084
	19 1/4	15	90 3/4	159	20	40C191591SCDSRT	\$1,890
	19 1/4	12	90 3/4	139	16	40C191291SCDSRT	\$1,796
	90 3/4"h Left Hinged						
	19 1/4	24	90 3/4	218	30	40C192491SCDSLTL	\$2,330
	19 1/4	21	90 3/4	199	26	40C192191SCDSLTL	\$2,228
	19 1/4	18	90 3/4	179	23	40C191891SCDSLTL	\$2,084
19 1/4	15	90 3/4	159	20	40C191591SCDSLTL	\$1,890	
19 1/4	12	90 3/4	139	16	40C191291SCDSLTL	\$1,796	
84 3/4"h Right Hinged							
19 1/4	24	84 3/4	208	28	40C192485SCDSRT	\$2,040	
19 1/4	21	84 3/4	190	25	40C192185SCDSRT	\$1,945	
19 1/4	18	84 3/4	170	21	40C191885SCDSRT	\$1,835	
19 1/4	15	84 3/4	152	18	40C191585SCDSRT	\$1,740	
19 1/4	12	84 3/4	132	15	40C191285SCDSRT	\$1,650	
84 3/4"h Left Hinged							
19 1/4	24	84 3/4	208	28	40C192485SCDSLTL	\$2,040	
19 1/4	21	84 3/4	190	25	40C192185SCDSLTL	\$1,945	
19 1/4	18	84 3/4	170	21	40C191885SCDSLTL	\$1,835	
19 1/4	15	84 3/4	152	18	40C191585SCDSLTL	\$1,740	
19 1/4	12	84 3/4	132	15	40C191285SCDSLTL	\$1,650	

Specify: Model | Chassis Laminate | Door Laminate | Interior Configuration | Pull | Lock

Model	Chassis Laminate	Door Laminate	Interior Configuration	Pull	Lock
	see Forge Laminate Finishes	see Forge Laminate Finishes	CH Coat Hook CR2FS Coat Rod & 2 Fixed Shelves - add \$42 1F3AS 1 Fixed & 3 Adjustable Shelves - add \$150	P001 Bar see Bar Pull Color P005 Delve see Delve Pull Color P011 Prospect see Prospect Pull Color P003 Sweep see Sweep Pull Color	NLK No Lock KLK Standard - add \$78 ASL Arctic Silver MBK Matte Black DLK Keyless Lock - add \$232

24" d Models

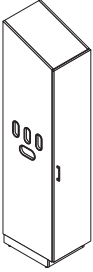
Description	D	W	H	CTN WT	CU FT	Model	List
 <p>right shown</p>	92 ½" h Right Hinged						
	24 ¼	24	92 ½	240	37	40C242493SCDGBSRT	\$2,780
	24 ¼	21	92 ½	221	33	40C242193SCDGBSRT	\$2,635
	24 ¼	18	92 ½	201	28	40C241893SCDGBSRT	\$2,490
	24 ¼	15	92 ½	181	24	40C241593SCDGBSRT	\$2,345
	24 ¼	12	92 ½	161	20	40C241293SCDGBSRT	\$2,200
	92 ½" h Left Hinged						
	24 ¼	24	92 ½	240	37	40C242493SCDGBSLT	\$2,780
	24 ¼	21	92 ½	221	33	40C242193SCDGBSLT	\$2,635
	24 ¼	18	92 ½	201	28	40C241893SCDGBSLT	\$2,490
	24 ¼	15	92 ½	181	24	40C241593SCDGBSLT	\$2,345
	24 ¼	12	92 ½	161	20	40C241293SCDGBSLT	\$2,200
	86 ½" h Right Hinged						
	24 ¼	24	86 ½	228	34	40C242487SCDGBSRT	\$2,580
	24 ¼	21	86 ½	209	30	40C242187SCDGBSRT	\$2,470
	24 ¼	18	86 ½	190	27	40C241887SCDGBSRT	\$2,360
	24 ¼	15	86 ½	171	23	40C241587SCDGBSRT	\$2,250
	24 ¼	12	86 ½	152	19	40C241287SCDGBSRT	\$2,140
	86 ½" h Left Hinged						
	24 ¼	24	86 ½	228	34	40C242487SCDGBSLT	\$2,580
24 ¼	21	86 ½	209	30	40C242187SCDGBSLT	\$2,470	
24 ¼	18	86 ½	190	27	40C241887SCDGBSLT	\$2,360	
24 ¼	15	86 ½	171	23	40C241587SCDGBSLT	\$2,250	
24 ¼	12	86 ½	152	19	40C241287SCDGBSLT	\$2,140	

• metal glove box holder is included

Specify: Model | Chassis Laminate | Door Laminate | Pull | Lock | Waste Grommet Color

Model	Chassis Laminate	Door Laminate	Pull	Lock	Waste Grommet Color
	see Forge Laminate Finishes	see Forge Laminate Finishes	P001 Bar see Bar Pull Color P005 Delve see Delve Pull Color P011 Prospect see Prospect Pull Color P003 Sweep see Sweep Pull Color	NLK No Lock KLK Standard - add \$78 ASL Arctic Silver MBK Matte Black DLK Keyless Lock - add \$232	MBK Matte Black SNK Soft Nickel

19" d Models

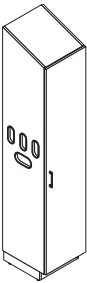
Description	D	W	H	CTN WT	CU FT	Model	List
 <p>right shown</p>	90 3/4" h Right Hinged						
	19 1/4	24	90 3/4	218	30	40C192491SCDGBSRT	\$2,575
	19 1/4	21	90 3/4	199	26	40C192191SCDGBSRT	\$2,395
	19 1/4	18	90 3/4	179	23	40C191891SCDGBSRT	\$2,308
	19 1/4	15	90 3/4	159	20	40C191591SCDGBSRT	\$2,165
	19 1/4	12	90 3/4	139	16	40C191291SCDGBSRT	\$1,990
	90 3/4" h Left Hinged						
	19 1/4	24	90 3/4	218	30	40C192491SCDGBSLT	\$2,575
	19 1/4	21	90 3/4	199	26	40C192191SCDGBSLT	\$2,395
	19 1/4	18	90 3/4	179	23	40C191891SCDGBSLT	\$2,308
	19 1/4	15	90 3/4	159	20	40C191591SCDGBSLT	\$2,165
	19 1/4	12	90 3/4	139	16	40C191291SCDGBSLT	\$1,990
	84 3/4" h Right Hinged						
	19 1/4	24	84 3/4	208	28	40C192485SCDGBSRT	\$2,370
	19 1/4	21	84 3/4	190	25	40C192185SCDGBSRT	\$2,290
	19 1/4	18	84 3/4	170	21	40C191885SCDGBSRT	\$2,180
	19 1/4	15	84 3/4	152	18	40C191585SCDGBSRT	\$2,020
	19 1/4	12	84 3/4	132	15	40C191285SCDGBSRT	\$1,930
	84 3/4" h Left Hinged						
	19 1/4	24	84 3/4	208	28	40C192485SCDGBSLT	\$2,370
19 1/4	21	84 3/4	190	25	40C192185SCDGBSLT	\$2,290	
19 1/4	18	84 3/4	170	21	40C191885SCDGBSLT	\$2,180	
19 1/4	15	84 3/4	152	18	40C191585SCDGBSLT	\$2,020	
19 1/4	12	84 3/4	132	15	40C191285SCDGBSLT	\$1,930	

• metal glove box holder is included

Specify: Model | Chassis Laminate | Door Laminate | Pull | Lock | Waste Grommet Color

Model	Chassis Laminate	Door Laminate	Pull	Lock	Waste Grommet Color
	see Forge Laminate Finishes	see Forge Laminate Finishes	P001 Bar see Bar Pull Color P005 Delve see Delve Pull Color P011 Prospect see Prospect Pull Color P003 Sweep see Sweep Pull Color	NLK No Lock KLK Standard - add \$78 ASL Arctic Silver MBK Matte Black DLK Keyless Lock - add \$232	MBK Matte Black SNK Soft Nickel

24"d Models

Description	D	W	H	CTN WT	CU FT	① Model	List
Sloped Top Storage Cabinet with Doors	24 ¼	36	92 ½	320	53	40C243693SCDST	\$3,220
	24 ¼	30	92 ½	280	45	40C243093SCDST	\$3,085
	24 ¼	36	86 ½	305	50	40C243687SCDST	\$2,935
	24 ¼	30	86 ½	266	42	40C243087SCDST	\$2,800

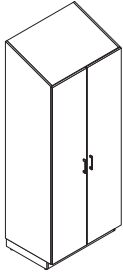

Specify: Model | Chassis Laminate | Door Laminate | Interior Configuration | Pull | Lock

19"d Models

Description	D	W	H	CTN WT	CU FT	① Model	List
Sloped Top Storage Cabinet with Doors	19 ¼	36	90 ¾	298	43	40C193691SCDST	\$2,995
	19 ¼	30	90 ¾	258	36	40C193091SCDST	\$2,860
	19 ¼	36	84 ¾	285	40	40C193685SCDST	\$2,785
	19 ¼	30	84 ¾	247	34	40C193085SCDST	\$2,650

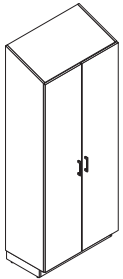

Specify: Model | Chassis Laminate | Door Laminate | Interior Configuration | Pull | Lock

Model	Chassis Laminate	Door Laminate	Interior Configuration	Pull	Lock
	see Forge Laminate Finishes	see Forge Laminate Finishes	CH Coat Hook CR2FS Coat Rod & 2 Fixed Shelves - add \$42 1F3AS 1 Fixed & 3 Adjustable Shelves - add \$150	P001 Bar see Bar Pull Color P005 Delve see Delve Pull Color P011 Prospect see Prospect Pull Color P003 Sweep see Sweep Pull Color	NLK No Lock KLK Standard - add \$102 ASL Arctic Silver MBK Matte Black DLK Keyless Lock - add \$256

24"d Models

Description	D	W	H	CTN WT	CU FT	① Model	List
Sloped Top Storage Filler	23 ½	6	92 ½	8	12	40C24693SFST	\$357
	23 ½	6	86 ½	7	12	40C24687SFST	\$340



- includes brackets to attach to cabinet
- may be field scribed as needed

Specify: Model | Chassis Laminate

19"d Models

Description	D	W	H	CTN WT	CU FT	① Model	List
Sloped Top Storage Filler	19 ¼	6	90 ¾	7	10	40C19691SFST	\$338
	19 ¼	6	84 ¾	7	9	40C19685SFST	\$322

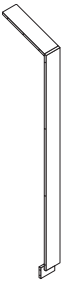

- includes brackets to attach to cabinet
- may be field scribed as needed

Specify: Model | Chassis Laminate

Model	Chassis Laminate
	see Forge Laminate Finishes

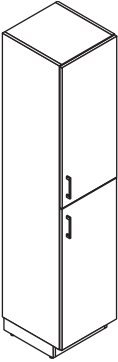
Description	D	W	H	CTN WT	CU FT	Model	List
 <p>right shown</p>	Right Hinged						
	24 ¼	24	84	208	33	40C242484SCDR2T	\$2,295
	24 ¼	21	84	193	30	40C242184SCDR2T	\$2,187
	24 ¼	18	84	177	26	40C241884SCDR2T	\$2,080
	24 ¼	15	84	162	22	40C241584SCDR2T	\$1,973
	24 ¼	12	84	146	18	40C241284SCDR2T	\$1,866
	19 ¼	24	84	179	28	40C192484SCDR2T	\$2,075
	19 ¼	21	84	164	25	40C192184SCDR2T	\$1,897
	19 ¼	18	84	149	22	40C191884SCDR2T	\$1,720
	19 ¼	15	84	134	19	40C191584SCDR2T	\$1,643
	19 ¼	12	84	119	15	40C191284SCDR2T	\$1,566
	Left Hinged						
	24 ¼	24	84	208	33	40C242484SCDL2T	\$2,295
	24 ¼	21	84	193	30	40C242184SCDL2T	\$2,187
	24 ¼	18	84	177	26	40C241884SCDL2T	\$2,080
	24 ¼	15	84	162	22	40C241584SCDL2T	\$1,973
	24 ¼	12	84	146	18	40C241284SCDL2T	\$1,866
	19 ¼	24	84	179	28	40C192484SCDL2T	\$2,075
	19 ¼	21	84	164	25	40C192184SCDL2T	\$1,897
19 ¼	18	84	149	22	40C191884SCDL2T	\$1,720	
19 ¼	15	84	134	19	40C191584SCDL2T	\$1,643	
19 ¼	12	84	119	15	40C191284SCDL2T	\$1,566	

Specify: Model | Chassis Laminate | Door Laminate | Pull | Lock

Model	Chassis Laminate	Door Laminate	Pull	Lock
	see Forge Laminate Finishes	see Forge Laminate Finishes	P001 Bar see Bar Pull Color P005 Delve see Delve Pull Color P011 Prospect see Prospect Pull Color P003 Sweep see Sweep Pull Color	NLK No Lock KLK Standard - add \$156 ASL Arctic Silver MBK Matte Black DLK Keyless Lock - add \$464

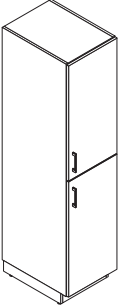
Description	D	W	H	CTN WT	CU FT	Model	List
 <p>right shown</p>	Right Hinged						
	24 ¼	24	78	196	31	40C242478SCDR2T	\$1,840
	24 ¼	21	78	182	28	40C242178SCDR2T	\$1,800
	24 ¼	18	78	167	24	40C241878SCDR2T	\$1,755
	24 ¼	15	78	152	21	40C241578SCDR2T	\$1,561
	24 ¼	12	78	137	17	40C241278SCDR2T	\$1,425
	19 ¼	24	78	169	26	40C192478SCDR2T	\$1,800
	19 ¼	21	78	155	23	40C192178SCDR2T	\$1,630
	19 ¼	18	78	141	20	40C191878SCDR2T	\$1,560
	19 ¼	15	78	127	17	40C191578SCDR2T	\$1,467
	19 ¼	12	78	112	14	40C191278SCDR2T	\$1,375
	Left Hinged						
	24 ¼	24	78	196	31	40C242478SCDL2T	\$1,840
	24 ¼	21	78	182	28	40C242178SCDL2T	\$1,800
	24 ¼	18	78	167	24	40C241878SCDL2T	\$1,755
	24 ¼	15	78	152	21	40C241578SCDL2T	\$1,561
	24 ¼	12	78	137	17	40C241278SCDL2T	\$1,425
	19 ¼	24	78	169	26	40C192478SCDL2T	\$1,800
	19 ¼	21	78	155	23	40C192178SCDL2T	\$1,630
19 ¼	18	78	141	20	40C191878SCDL2T	\$1,560	
19 ¼	15	78	127	17	40C191578SCDL2T	\$1,467	
19 ¼	12	78	112	14	40C191278SCDL2T	\$1,375	

Specify: Model | Chassis Laminate | Door Laminate | Pull | Lock

Model	Chassis Laminate	Door Laminate	Pull	Lock
	see Forge Laminate Finishes	see Forge Laminate Finishes	P001 Bar see Bar Pull Color P005 Delve see Delve Pull Color P011 Prospect see Prospect Pull Color P003 Sweep see Sweep Pull Color	NLK No Lock KLK Standard - add \$156 ASL Arctic Silver MBK Matte Black DLK Keyless Lock - add \$464

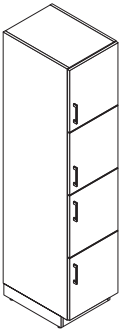
Description	D	W	H	CTN WT	CU FT	Model	List
 <p>right shown</p>	Right Hinged						
	24 ¼	24	84	219	33	40C242484SCDR4T	\$2,585
	24 ¼	21	84	202	30	40C242184SCDR4T	\$2,405
	24 ¼	18	84	185	26	40C241884SCDR4T	\$2,225
	24 ¼	15	84	168	22	40C241584SCDR4T	\$2,045
	24 ¼	12	84	151	18	40C241284SCDR4T	\$1,865
	19 ¼	24	84	189	28	40C192484SCDR4T	\$2,350
	19 ¼	21	84	172	25	40C192184SCDR4T	\$2,161
	19 ¼	18	84	156	22	40C191884SCDR4T	\$1,971
	19 ¼	15	84	140	19	40C191584SCDR4T	\$1,782
	19 ¼	12	84	123	15	40C191284SCDR4T	\$1,593
	Left Hinged						
	24 ¼	24	84	219	33	40C242484SCDL4T	\$2,585
	24 ¼	21	84	202	30	40C242184SCDL4T	\$2,405
	24 ¼	18	84	185	26	40C241884SCDL4T	\$2,225
	24 ¼	15	84	168	22	40C241584SCDL4T	\$2,045
	24 ¼	12	84	151	18	40C241284SCDL4T	\$1,865
	19 ¼	24	84	194	28	40C192484SCDL4T	\$2,350
	19 ¼	21	84	177	25	40C192184SCDL4T	\$2,161
19 ¼	18	84	160	22	40C191884SCDL4T	\$1,971	
19 ¼	15	84	143	19	40C191584SCDL4T	\$1,782	
19 ¼	12	84	126	15	40C191284SCDL4T	\$1,593	

Specify: Model | Chassis Laminate | Door Laminate | Pull | Lock

Model	Chassis Laminate	Door Laminate	Pull	Lock
	see Forge Laminate Finishes	see Forge Laminate Finishes	P001 Bar see Bar Pull Color P005 Delve see Delve Pull Color P011 Prospect see Prospect Pull Color P003 Sweep see Sweep Pull Color	NLK No Lock KLK Standard - add \$312 ASL Arctic Silver MBK Matte Black DLK Keyless Lock - add \$928

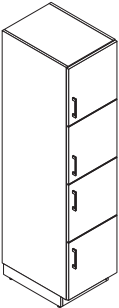
Description	D	W	H	CTN WT	CU FT	Model	List
 <p>right shown</p>	Right Hinged						
	24 ¼	24	78	207	31	40C242478SCDR4T	\$2,271
	24 ¼	21	78	191	28	40C242178SCDR4T	\$2,144
	24 ¼	18	78	174	24	40C241878SCDR4T	\$2,017
	24 ¼	15	78	158	21	40C241578SCDR4T	\$1,890
	24 ¼	12	78	142	17	40C241278SCDR4T	\$1,763
	19 ¼	24	78	178	26	40C192478SCDR4T	\$2,042
	19 ¼	21	78	163	23	40C192178SCDR4T	\$1,921
	19 ¼	18	78	147	20	40C191878SCDR4T	\$1,800
	19 ¼	15	78	132	17	40C191578SCDR4T	\$1,678
	19 ¼	12	78	116	14	40C191278SCDR4T	\$1,557
	Left Hinged						
	24 ¼	24	78	207	31	40C242478SCDL4T	\$2,271
	24 ¼	21	78	191	28	40C242178SCDL4T	\$2,144
	24 ¼	18	78	174	24	40C241878SCDL4T	\$2,017
	24 ¼	15	78	158	21	40C241578SCDL4T	\$1,890
	24 ¼	12	78	142	17	40C241278SCDL4T	\$1,763
	19 ¼	24	78	184	26	40C192478SCDL4T	\$2,042
	19 ¼	21	78	168	23	40C192178SCDL4T	\$1,921
19 ¼	18	78	152	20	40C191878SCDL4T	\$1,800	
19 ¼	15	78	136	17	40C191578SCDL4T	\$1,678	
19 ¼	12	78	120	14	40C191278SCDL4T	\$1,557	

Specify: Model | Chassis Laminate | Door Laminate | Pull | Lock

Model	Chassis Laminate	Door Laminate	Pull	Lock
	see Forge Laminate Finishes	see Forge Laminate Finishes	P001 Bar see Bar Pull Color P005 Delve see Delve Pull Color P011 Prospect see Prospect Pull Color P003 Sweep see Sweep Pull Color	NLK No Lock KLK Standard - add \$312 ASL Arctic Silver MBK Matte Black DLK Keyless Lock - add \$928

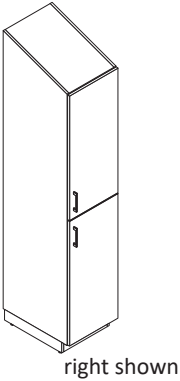
Description	D	W	H	CTN WT	CU FT	Model	List
Sloped Top Two Door Lockers 92 1/2" h Right Hinged							
	24 1/4	24	92 1/2	208	37	40C242493SCDR2ST	\$2,360
	24 1/4	21	92 1/2	193	33	40C242193SCDR2ST	\$2,252
	24 1/4	18	92 1/2	177	28	40C241893SCDR2ST	\$2,145
	24 1/4	15	92 1/2	162	24	40C241593SCDR2ST	\$2,038
	24 1/4	12	92 1/2	146	20	40C241293SCDR2ST	\$1,931
92 1/2" h Left Hinged							
	24 1/4	24	92 1/2	208	37	40C242493SCDL2ST	\$2,360
	24 1/4	21	92 1/2	193	33	40C242193SCDL2ST	\$2,252
	24 1/4	18	92 1/2	177	28	40C241893SCDL2ST	\$2,145
	24 1/4	15	92 1/2	162	24	40C241593SCDL2ST	\$2,038
	24 1/4	12	92 1/2	146	20	40C241293SCDL2ST	\$1,931
90 3/4" h Right Hinged							
	19 1/4	24	90 3/4	181	30	40C192491SCDR2ST	\$2,143
	19 1/4	21	90 3/4	166	27	40C192191SCDR2ST	\$1,965
	19 1/4	18	90 3/4	151	24	40C191891SCDR2ST	\$1,788
	19 1/4	15	90 3/4	136	20	40C191591SCDR2ST	\$1,711
	19 1/4	12	90 3/4	121	17	40C191291SCDR2ST	\$1,634
90 3/4" h Left Hinged							
	19 1/4	24	90 3/4	181	30	40C192491SCDL2ST	\$2,143
	19 1/4	21	90 3/4	166	27	40C192191SCDL2ST	\$1,965
	19 1/4	18	90 3/4	151	24	40C191891SCDL2ST	\$1,788
	19 1/4	15	90 3/4	136	20	40C191591SCDL2ST	\$1,711
	19 1/4	12	90 3/4	121	17	40C191291SCDL2ST	\$1,634

Specify: Model | Chassis Laminate | Door Laminate | Pull | Lock

Model	Chassis Laminate	Door Laminate	Pull	Lock
	see Forge Laminate Finishes	see Forge Laminate Finishes	P001 Bar see Bar Pull Color P005 Delve see Delve Pull Color P011 Prospect see Prospect Pull Color P003 Sweep see Sweep Pull Color	NLK No Lock KLK Standard - add \$156 ASL Arctic Silver MBK Matte Black DLK Keyless Lock - add \$464

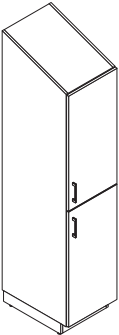
Description	D	W	H	CTN WT	CU FT	Model	List
Sloped Top Two Door Lockers 86 1/2" h Right Hinged							
	24 1/4	24	86 1/2	196	34	40C242487SCDR2ST	\$1,905
	24 1/4	21	86 1/2	182	30	40C242187SCDR2ST	\$1,865
	24 1/4	18	86 1/2	167	27	40C241887SCDR2ST	\$1,820
	24 1/4	15	86 1/2	152	23	40C241587SCDR2ST	\$1,626
	24 1/4	12	86 1/2	137	19	40C241287SCDR2ST	\$1,490
86 1/2" h Left Hinged							
	24 1/4	24	86 1/2	196	34	40C242487SCDL2ST	\$1,905
	24 1/4	21	86 1/2	182	30	40C242187SCDL2ST	\$1,865
	24 1/4	18	86 1/2	167	27	40C241887SCDL2ST	\$1,820
	24 1/4	15	86 1/2	152	23	40C241587SCDL2ST	\$1,626
	24 1/4	12	86 1/2	137	19	40C241287SCDL2ST	\$1,490
84 3/4" h Right Hinged							
	19 1/4	24	84 3/4	171	29	40C192485SCDR2ST	\$1,868
	19 1/4	21	84 3/4	157	25	40C192185SCDR2ST	\$1,698
	19 1/4	18	84 3/4	142	22	40C191885SCDR2ST	\$1,628
	19 1/4	15	84 3/4	128	19	40C191585SCDR2ST	\$1,535
	19 1/4	12	84 3/4	114	16	40C191285SCDR2ST	\$1,443
84 3/4" h Left Hinged							
	19 1/4	24	84 3/4	171	29	40C192485SCDL2ST	\$1,868
	19 1/4	21	84 3/4	157	25	40C192185SCDL2ST	\$1,698
	19 1/4	18	84 3/4	142	22	40C191885SCDL2ST	\$1,628
	19 1/4	15	84 3/4	128	19	40C191585SCDL2ST	\$1,535
	19 1/4	12	84 3/4	114	16	40C191285SCDL2ST	\$1,443

Specify: Model | Chassis Laminate | Door Laminate | Pull | Lock

Model	Chassis Laminate	Door Laminate	Pull	Lock
	see Forge Laminate Finishes	see Forge Laminate Finishes	P001 Bar see Bar Pull Color P005 Delve see Delve Pull Color P011 Prospect see Prospect Pull Color P003 Sweep see Sweep Pull Color	NLK No Lock KLK Standard - add \$156 ASL Arctic Silver MBK Matte Black DLK Keyless Lock - add \$464

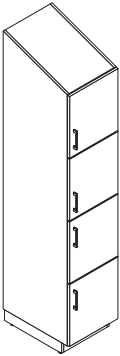
Description	D	W	H	CTN WT	CU FT	Model	List
 <p>right shown</p>	92 ½" h Right Hinged						
	24 ¼	24	92 ½	219	37	40C242493SCDR4ST	\$2,672
	24 ¼	21	92 ½	202	33	40C242193SCDR4ST	\$2,492
	24 ¼	18	92 ½	185	28	40C241893SCDR4ST	\$2,312
	24 ¼	15	92 ½	168	24	40C241593SCDR4ST	\$2,132
	24 ¼	12	92 ½	151	20	40C241293SCDR4ST	\$1,952
	92 ½" h Left Hinged						
	24 ¼	24	92 ½	219	37	40C242493SCDL4ST	\$2,672
	24 ¼	21	92 ½	202	33	40C242193SCDL4ST	\$2,492
	24 ¼	18	92 ½	185	28	40C241893SCDL4ST	\$2,312
	24 ¼	15	92 ½	168	24	40C241593SCDL4ST	\$2,132
	24 ¼	12	92 ½	151	20	40C241293SCDL4ST	\$1,952
	90 ¾" h Right Hinged						
	19 ¼	24	90 ¾	190	30	40C192491SCDR4ST	\$2,445
	19 ¼	21	90 ¾	174	27	40C192191SCDR4ST	\$2,256
	19 ¼	18	90 ¾	157	24	40C191891SCDR4ST	\$2,066
	19 ¼	15	90 ¾	141	20	40C191591SCDR4ST	\$1,877
	19 ¼	12	90 ¾	125	17	40C191291SCDR4ST	\$1,688
	90 ¾" h Left Hinged						
	19 ¼	24	90 ¾	190	30	40C192491SCDL4ST	\$2,445
19 ¼	21	90 ¾	174	27	40C192191SCDL4ST	\$2,256	
19 ¼	18	90 ¾	157	24	40C191891SCDL4ST	\$2,066	
19 ¼	15	90 ¾	141	20	40C191591SCDL4ST	\$1,877	
19 ¼	12	90 ¾	125	17	40C191291SCDL4ST	\$1,688	

Specify: Model | Chassis Laminate | Door Laminate | Pull | Lock

Model	Chassis Laminate	Door Laminate	Pull	Lock
	see Forge Laminate Finishes	see Forge Laminate Finishes	P001 Bar see Bar Pull Color P005 Delve see Delve Pull Color P011 Prospect see Prospect Pull Color P003 Sweep see Sweep Pull Color	NLK No Lock KLK Standard - add \$312 ASL Arctic Silver MBK Matte Black DLK Keyless Lock - add \$928

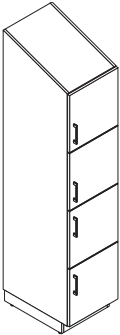
Description	D	W	H	CTN WT	CU FT	Model	List
 <p>right shown</p>	86 1/2" h Right Hinged						
	24 1/4	24	86 1/2	207	34	40C242487SCDR4ST	\$2,363
	24 1/4	21	86 1/2	191	30	40C242187SCDR4ST	\$2,236
	24 1/4	18	86 1/2	174	27	40C241887SCDR4ST	\$2,109
	24 1/4	15	86 1/2	158	23	40C241587SCDR4ST	\$1,982
	24 1/4	12	86 1/2	142	19	40C241287SCDR4ST	\$1,855
	86 1/2" h Left Hinged						
	24 1/4	24	86 1/2	207	34	40C242487SCDL4ST	\$2,363
	24 1/4	21	86 1/2	191	30	40C242187SCDL4ST	\$2,236
	24 1/4	18	86 1/2	174	27	40C241887SCDL4ST	\$2,109
	24 1/4	15	86 1/2	158	23	40C241587SCDL4ST	\$1,982
	24 1/4	12	86 1/2	142	19	40C241287SCDL4ST	\$1,855
	84 3/4" h Right Hinged						
	19 1/4	24	84 3/4	180	29	40C192485SCDR4ST	\$2,134
	19 1/4	21	84 3/4	165	25	40C192185SCDR4ST	\$2,013
	19 1/4	18	84 3/4	149	22	40C191885SCDR4ST	\$1,892
	19 1/4	15	84 3/4	133	19	40C191585SCDR4ST	\$1,770
	19 1/4	12	84 3/4	118	16	40C191285SCDR4ST	\$1,649
	84 3/4" h Right Hinged						
	19 1/4	24	84 3/4	180	29	40C192485SCDL4ST	\$2,134
19 1/4	21	84 3/4	165	25	40C192185SCDL4ST	\$2,013	
19 1/4	18	84 3/4	149	22	40C191885SCDL4ST	\$1,892	
19 1/4	15	84 3/4	133	19	40C191585SCDL4ST	\$1,770	
19 1/4	12	84 3/4	118	16	40C191285SCDL4ST	\$1,649	

Specify: Model | Chassis Laminate | Door Laminate | Pull | Lock

Model	Chassis Laminate	Door Laminate	Pull	Lock
	see Forge Laminate Finishes	see Forge Laminate Finishes	P001 Bar see Bar Pull Color P005 Delve see Delve Pull Color P011 Prospect see Prospect Pull Color P003 Sweep see Sweep Pull Color	NLK No Lock KLK Standard - add \$312 ASL Arctic Silver MBK Matte Black DLK Keyless Lock - add \$928

Description	D	W	H	CTN WT	CU FT	Model	List
	¾	36	42	33	3	40C3642WPT	\$480
	¾	30	42	28	3	40C3042WPT	\$476
	¾	24	42	22	2	40C2442WPT	\$472
	¾	21	42	20	2	40C2142WPT	\$469
	¾	18	42	17	2	40C1842WPT	\$466
	¾	36	36	29	3	40C3636WPT	\$408
	¾	30	36	24	2	40C3036WPT	\$404
	¾	24	36	19	2	40C2436WPT	\$400
	¾	21	36	17	2	40C2136WPT	\$397
	¾	18	36	14	2	40C1836WPT	\$394
	¾	36	30	24	2	40C3630WPT	\$328
	¾	30	30	20	2	40C3030WPT	\$324
	¾	24	30	16	2	40C2430WPT	\$320
	¾	21	30	14	2	40C2130WPT	\$317
	¾	18	30	12	1	40C1830WPT	\$314
	¾	36	24	19	2	40C3624WPT	\$287
	¾	30	24	16	2	40C3024WPT	\$283
	¾	24	24	13	2	40C2424WPT	\$279
	¾	21	24	11	1	40C2124WPT	\$276
	¾	18	24	10	1	40C1824WPT	\$273
¾	36	18	15	2	40C3618WPT	\$270	
¾	30	18	12	1	40C3018WPT	\$267	
¾	24	18	10	1	40C2418WPT	\$264	
¾	21	18	9	1	40C2118WPT	\$261	
¾	18	18	7	1	40C1818WPT	\$258	

Specify: Model | Chassis Laminate

Model	Chassis Laminate
	see Forge Laminate Finishes

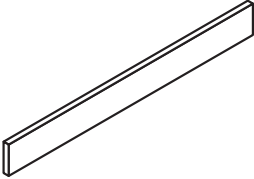
Description	D	W	H	CTN WT	CU FT	Model	List
 <p>Toe Kick</p>	¾	96	4	8	1	40C496TKT	\$215
	¾	95 ½	4	8	1	40C495TKT	\$213
	¾	93	4	8	1	40C493TKT	\$211
	¾	92 ½	4	8	1	40C492TKT	\$209
	¾	90	4	8	1	40C490TKT	\$207
	¾	89 ½	4	8	1	40C489TKT	\$205
	¾	87	4	8	1	40C487TKT	\$203
	¾	86 ½	4	7	1	40C486TKT	\$201
	¾	84	4	7	1	40C484TKT	\$199
	¾	83 ½	4	7	1	40C483TKT	\$197
	¾	81	4	7	1	40C481TKT	\$195
	¾	80 ½	4	7	1	40C480TKT	\$193
	¾	78	4	7	1	40C478TKT	\$192
	¾	77 ½	4	7	1	40C477TKT	\$190
	¾	75	4	7	1	40C475TKT	\$188
	¾	74 ½	4	7	1	40C474TKT	\$186
	¾	72	4	6	1	40C472TKT	\$184
	¾	71 ½	4	6	1	40C471TKT	\$182
	¾	69	4	6	1	40C469TKT	\$180
	¾	68 ½	4	6	1	40C468TKT	\$178
	¾	66	4	6	1	40C466TKT	\$176
	¾	65 ½	4	6	1	40C465TKT	\$174
	¾	63	4	6	1	40C463TKT	\$172
	¾	62 ½	4	6	1	40C462TKT	\$170
	¾	60	4	5	1	40C460TKT	\$168
	¾	59 ½	4	5	1	40C459TKT	\$166
	¾	57	4	5	1	40C457TKT	\$164
	¾	56 ½	4	5	1	40C456TKT	\$162
	¾	54	4	5	1	40C454TKT	\$160
	¾	53 ½	4	5	1	40C453TKT	\$158
¾	51	4	5	1	40C451TKT	\$156	
¾	50 ½	4	5	1	40C450TKT	\$154	
¾	48	4	4	1	40C448TKT	\$153	
¾	47 ½	4	4	1	40C447TKT	\$151	

Specify: Model | Chassis Laminate

Model	Chassis Laminate
	see Forge Laminate Finishes

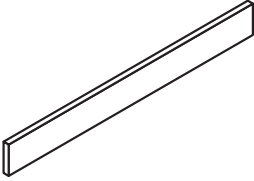
Description	D	W	H	CTN WT	CU FT	① Model	List
Toe Kick (continued)	¾	45	4	4	1	40C445TKT	\$149
	¾	44 ½	4	4	1	40C444TKT	\$147
	¾	42	4	4	1	40C442TKT	\$146
	¾	41 ½	4	4	1	40C441TKT	\$144
	¾	39	4	4	1	40C439TKT	\$142
	¾	38 ½	4	4	1	40C438TKT	\$140
	¾	36	4	3	1	40C436TKT	\$138
	¾	35 ½	4	3	1	40C435TKT	\$136
	¾	33	4	3	1	40C433TKT	\$134
	¾	32 ½	4	3	1	40C432TKT	\$132
	¾	30	4	3	1	40C430TKT	\$130
	¾	29 ½	4	3	1	40C429TKT	\$128
	¾	27	4	3	1	40C427TKT	\$126
	¾	26 ½	4	3	1	40C426TKT	\$124
	¾	24	4	2	1	40C424TKT	\$123
	¾	23 ½	4	2	1	40C423TKT	\$121
	¾	21	4	2	1	40C421TKT	\$119
	¾	20 ½	4	2	1	40C420TKT	\$118
	¾	18	4	2	1	40C418TKT	\$116
	¾	17 ½	4	2	1	40C417TKT	\$114
	¾	15	4	2	1	40C415TKT	\$112
¾	14 ½	4	2	1	40C414TKT	\$111	
¾	12	4	2	1	40C412TKT	\$109	
¾	11 ½	4	1	1	40C411TKT	\$107	

Specify: Model | Chassis Laminate

Removable Drawer Liner	15 ⅞	15 ¼	3	1	2	40CDBL244	\$134
	15 ⅞	21 ¼	3	1	2	40CDBL184	\$122

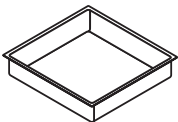

Specify: Model

Model	Chassis Laminate
	see Forge Laminate Finishes



Formica Laminate

Forge offers an extensive program for laminates beyond our Standard Program. Always reference below the most current listing and tier pricing when using a Graded-In Laminate; on page 108 select the color of the PVC edge color.

Laminate	Pattern-Sheen	Tier	Laminate	Pattern-Sheen	Tier	Laminate	Pattern-Sheen	Tier	Laminate	Pattern-Sheen	Tier
Acajou Mahogany	7008-58	2	Dark Chocolate	2200-58	2	Mission White	933-58	2	Smoke Onyx	3710-58	2
Aged Ash	8844-58	2	Denim	8822-58	2	Mocha Travertine	3456-58	2	Smoke Quarstone	6220-58	2
Algae	8796-58	2	Desert Beige	899-58	2	Mojave	8751-58	2	Smokey Brown Pear	5488-58	2
Almond	920-58	2	Dover White	7197-58	2	Moonstone	7872-58	2	Solar Orange	8235-58	2
Aluminum	9318-58	2	Earth	5342-58	2	Mouse	928-58	2	Sorrel Cherry	5886-58	2
Amber Kashmir	6227-58	2	Earth Wash	7213-58	2	Muslin Fabric	6127-58	2	Spectrum Blue	851-58	2
Amber Maple	7012-58	2	Earthen Twill	8828-58	2	Natural Ash	8843-58	2	Spectrum Green	7897-58	2
Antique White	932-58	2	Earthen Warp	5880-58	2	Natural Birch	7481-58	2	Spectrum Red	845-58	2
Argento Romano	6697-58	2	Earthenware	8241-58	2	Natural Canvas	7022-58	2	Stainless	9319-58	2
Artichoke	800-58	2	Earthenware	6999-58	2	Natural Gray Felt	4971-58	2	Star Dune	9309-58	2
Ashwood Beige	5785-58	2	Brushstroke		2	Natural Maple	756-58	2	Starched Paperfold	8678-58	2
Ashwood Bone	5784-58	2	Ebony	9012-58	2	Natural Oak	346-58	2	Stone Grafix	503-58	2
Ashwood Oak	5786-58	2	Ebony Oxide	299-58	2	Natural Recycled Kraft	9684-58	2	Stop Red	839-58	2
Basalt Slate	3690-58	2	Elemental Concrete	8830-58	2	Natural Riftwood	9282-58	2	Storm	912-58	2
Beige Elm	5794-58	2	Elemental Stone	8831-58	2	Natural Teak	8849-58	2	Storm Solidz	3505-58	2
Belmonte Granite	3496-58	2	Espresso Pear	5489-58	2	Navy Blue	969-58	2	Storm Teakwood	8908-58	2
Birchbark	8684-58	2	Finnish Oak	118-58	2	Navy Grafix	7018-58	2	Sugar Glass	3705-58	2
Black	909-58	2	Flax Gauze	7708-58	2	Neo Cloud	6314-58	2	Surf	923-58	2
Black Bardiglio	5019-58	2	Flint Crystal	3518-58	2	Neutral Twill	8826-58	2	Swede Rift Oak	8676-58	2
Black Birchply	8552-58	2	Fog	961-58	2	Neutral Weft	5875-58	2	Taupe Walnut	5787-58	2
Black Recycled Kraft	9685-58	2	Folkstone	927-58	2	Neutral White	918-58	2	Terril	2297-58	2
Black Riftwood	6414-58	2	Folkstone Celesta	692-58	2	New Burgundy	7966-58	2	Thermo Walnut	6402-58	2
Black Shalestone	9527-58	2	Folkstone Grafix	507-58	2	Night Forest	8244-58	2	Travertine	3526-58	2
Black Walnut	3485-58	2	Formal Walnut	5782-58	2	Night Shade	8243-58	2	Tula Oak	8589-58	2
Blackened Fiberwood	8916-58	2	Fossil	5349-58	2	Noble Mahogany	9236-58	2	Venetian Gold Granite	6223-58	2
Blackened Legno	8848-58	2	Fox Teakwood	8907-58	2	Nocturne	5323-58	2	Vibrant Green	6901-58	2
Blackened Steel	8918-58	2	Geriba Gray	9308-58	2	Noir Cedar	1547-58	2	Walnut Butcherblock	3712-58	2
Blackstone	271-58	2	Ginger Root Maple	7288-58	2	Noir Envision	7500-58	2	Walnut Fiberwood	8915-58	2
Bleached Legno	8845-58	2	Glamour Cherry	6208-58	2	Nut Brown Cherry	5790-58	2	Walnut Riftwood	9283-58	2
Blond Cedar	8576-58	2	Glass Cloth	8683-58	2	Oiled Legno	8846-58	2	Walnut Softwood	4925-58	2
Blossom Cherrywood	758-58	2	Gold Braze	1193-58	2	Oiled Walnut	5487-58	2	Washi Paperfold	8680-58	2
Blue Felt	9320-58	2	Graphite	837-58	2	Orange Felt	4973-58	2	Waxed Maple	8905-58	2
Blush	8238-58	2	Graphite Elm	5796-58	2	Origami Paperfold	8679-58	2	Weathered Ash	8842-58	2
Brazilian Brown Granite	6222-58	2	Graphite Grafix	515-58	2	Otter	3202-58	2	Weathered Fiberwood	8914-58	2
Brite White	459-58	2	Graphite Twill	8829-58	2	Oxidized Beamwood	9484-58	2	Wenge Strand	6306-58	2
Bronzed Steel	8919-58	2	Gray Fabric	6129-58	2	Oyster Grey	929-58	2	Wheat Strand	6212-58	2
Bubble Art	8958-58	2	Gray Grafix	9300-58	2	Pale Brushstroke	6997-58	2	White	949-58	2
Buff Elm	5793-58	2	Gray Onyx	7409-58	2	Paloma Polar	6698-58	2	White Ash	8841-58	2
Burnished Coin	3708-58	2	Grayed Oak	5791-58	2	Patine Bronze	3707-58	2	White Bardiglio	9306-58	2
Burnished Iron	3709-58	2	Graystone	464-58	2	Patine Concrete	3706-58	2	White Drops	8824-58	2
Burnt Strand	6307-58	2	Green Felt	4974-58	2	Pearl	934-58	2	White Ice Granite	9476-58	2
Butterum Granite	7732-58	2	Green Slate	8793-58	2	Pecan Walnut	6996-58	2	White Marble	9310-58	2
Camel Elm	5795-58	2	Greige Softwood	4924-58	2	Pecan Woodline	5883-58	2	Herringbone		2
Cardboard Solidz	7813-58	2	Gull Grey	9242-58	2	Pencil Wood	7747-58	2	White Onyx	827-58	2
Carrara Bianco	6696-58	2	Hard Rock Maple	86992-58	2	Perlato Granite	3522-58	2	White Painted Wood	8902-58	2
Carrara Envision	7494-58	2	Hazel Walnut	5788-58	2	Planked Coffee Oak	7413-58	2	White Pearl Cascade	3720-58	2
Cascara Teakwood	8909-58	2	Ice Onyx	7408-58	2	Planked Deluxe Pear	6206-58	2	White Shalestone	9525-58	2
Cassis	6903-58	2	Inked Oak	5792-58	2	Planked Raw Oak	7412-58	2	White Twill	9285-58	2
Ceruse Gray Walnut	6994-58	2	Ivory Kashmir	6226-58	2	Planked Urban Oak	9312-58	2	White Washed	6372-58	2
Chambray Fabric	6130-58	2	Jadeite	1198-58	2	Platinum	902-58	2	Birchply		2
Charcoal Boomerang	6942-58	2	Jamocho Granite	7734-58	2	Portico Marble	7735-58	2	Wild Cherry	5904-58	2
Chelsea Maple	9238-58	2	Just Rose	8858-58	2	Prestige Walnut	6209-58	2	Winter Sky	8792-58	2
Cherry Heartwood	9240-58	2	Labrador Granite	3692-58	2	Pumice	858-58	2	Wood Brushstroke	6998-58	2
Cherry Walnut	6995-58	2	Layered Black Sand	9510-58	2	Purple Dye	1196-58	2	Woolen Cloth	8682-58	2
Chestnut Woodline	5884-58	2	Layered Sand	9511-58	2	Raw Birchply	8910-58	2	Yellow Felt	4972-58	2
Chrome Yellow	1485-58	2	Layered White Sand	9512-58	2	Raw Cedar	1545-58	2			
Cinnamon Cherry	8955-58	2	Lime Stone	7264-58	2	Sail White	463-58	2			
Citadel	1097-58	2	Liquid Glass	8240-58	2	Sand Crystal	3517-58	2			
Citadel Warp	5882-58	2	Luxe Mango	8685-58	2	Sand Maple	9237-58	2			
Classic White	9244-58	2	Macchiato Walnut	6932-58	2	Sarum Grey	2770-58	2			
Clementine	2962-58	2	Maple Woodline	6925-58	2	Sarum Twill	8827-58	2			
Clove Spice Cherry	5789-58	2	Marine Blue	914-58	2	Scandi Rift Oak	8677-58	2			
Cocoa Maple	7739-58	2	Marmara Beige	7406-58	2	Sea Salt	9529-58	2			
Cocoa Oak	9374-58	2	Marmara Gray	7407-58	2	Seasoned Planked Elm	6477-58	2			
Cognac Maple	7738-58	2	Matrix Blue	8795-58	2	Select Cherry	7759-58	2			
Concrete Formwood	6362-58	2	Mdf Solidz	7812-58	2	Sheer Fabric	6126-58	2			
Concrete Stone	7267-58	2	Midnight Stone	6280-58	2	Silver Quartzite	9497-58	2			
Cotton Cloth	8681-58	2	Milk	9634-58	2	Silver Riftwood	6413-58	2			
Cream Softwood	4923-58	2	Millennium Oak	5887-58	2	Silver Shalestone	9307-58	2			
Danish Maple	8906-58	2	Mineral Jet	3450-58	2	Slate Noir	3711-58	2			
			Mineral Spa	6920-58	2	Smoke	3245-58	2			

Wilsonart Laminate

Forge offers an extensive program for laminates beyond our Standard Program. Always reference below the most current listing and tier pricing when using a Graded-In Laminate; see below on the PVC edge color selection.

Laminate	Pattern-Sheen	Tier	Laminate	Pattern-Sheen	Tier	Laminate	Pattern-Sheen	Tier	Laminate	Pattern-Sheen	Tier
Almond Leather	2932-60	2	Florence Walnut	7993-38	2	Lowell Ash	7994-38	2	Port	D14-60	2
Anitque White	1572-60	2	Fonthill Pear	10745-60	2	Mangalore Mango	7984-38	2	Pressed Linen	4991-38	2
Anzio Marble	5037-38	2	Forged Steel	4995-60	2	Manitoba Maple	7911-60	2	Raw Cotton	4947-38	2
Atlantis	D25-60	2	Fossil Shale	D504-60	2	Midnight	D505-60	2	River Cherry	7937-38	2
Bannister Oak	7806-60	2	French Linen	5016-38	2	Mission Maple	7990-38	2	Rustic Slate	4888-38	2
Beige	1530-60	2	French Pear	8220-38	2	Misted Zephyr	4843-60	2	Sable Soapstone	4883-38	2
Beigewood	7850-60	2	Frosty White	1573-60	2	Monticello Maple	7925-38	2	Sap Walnut	8221-38	2
Boardwalk Oak	7983-38	2	Fusion Maple	7909-60	2	Morelia Maple	7985-38	2	Shadow Zephyr	4857-60	2
Brazilwood	7946-38	2	Graphite	10657-60	2	Morro Zephyr	4846-60	2	Sheer Mesh	4876-38	2
Brittany Blue	D321-60	2	Graphite Nebula	4623-60	2	Natural Almond	D30-60	2	Sierra Cascade	5005-38	2
Bronze Legacy	4656-60	2	Green Tigris	4667-60	2	Natural Cotton	4946-38	2	Silicon Ev	4811-60	2
Buka Bark	7982-38	2	Grey	1500-60	2	Natural Recon	7996-38	2	Solar Oak	7816-60	2
Burnished Chestnut	4796-60	2	Grey Glace	4142-60	2	Natural Rift	7954-38	2	Steel Mesh	4879-38	2
Candy Apple	13096-60	2	Grey Mesh	4877-38	2	Natural Tigris	4669-60	2	Sterling Ash	7995-38	2
Canyon Zephyr	4842-60	2	Grey Nebula	4622-60	2	Navy Legacy	4651-60	2	Sunny Side Up	13089-60	2
Carbon Ev	4820-60	2	Grey Pampas	4168-60	2	Neo Walnut	7991-38	2	Tailored Linen	4992-38	2
Carbon Mesh	4880-60	2	Gumball	13102-60	2	Neutral Glace	4143-60	2	Titanium EV	4810-60	2
Castle Oak	7928-38	2	Handspun Chestnut	5036-38	2	New Age Oak	7938-38	2	Tungsten EV	4814-60	2
Casual Linen	4944-38	2	Handspun Dove	5034-38	2	Nordic Linen	5015-38	2	Tuscan Walnut	7921-38	2
Catalina	13092-60	2	Handspun Pearl	5033-38	2	Nori	13091-60	2	Twilight Zephyr	4845-60	2
Cement	D503-60	2	Hanspun Slate	5035-38	2	North Sea	D90-60	2	Wallaby	D439-60	2
Centizo Cherry	8239-38	2	Harvest Maple	7953-38	2	Norwegian Ash	8241-38	2	Washi Crystal	5017-38	2
Classic Linen	4843-38	2	high Rise	4996-38	2	Oiled Soapstone	4882-38	2	Washi Pewter	5018-38	2
Cloud Nebula	4830-60	2	Hollyberry	D307-60	2	Orange Grove	D501-60	2	White	1570-60	2
Cloud Zephyr	4856-60	2	Huntington Mplae	7929-38	2	Organic Cotton	4945-38	2	White Carrara	4924-38	2
Coffee Bean	D495-60	2	Indigo	D379-60	2	Palisades Oak	7987-38	2	White Cascade	5003-38	2
Crisp Linen	4942-38	2	Invory Birch	8219-38	2	Pampas	4170-60	2	White Nebula	4621-60	2
Crystal	D388-60	2	Jubilee Oak	8242-38	2	Pasadena Oak	7966-38	2	White Sand	D403-60	2
Desert Zephyr	4841-60	2	Kensington Maple	10776-60	2	Pearl Soapstone	4886-38	2	White Tigris	4783-60	2
Dove Grey	D92-60	2	Khaki Brown	D50-60	2	Pepperdust	D327-60	2	Wild Cherry	7054-60	2
Dragon Fly	13088-60	2	Kingswood Walnut	8218-38	2	Pewter	D73-60	2	Windswept Pewter	4795-60	2
Ebony Recon	7997-38	2	Lapis Blue	D417-60	2	Pewter Brush	4779-60	2	Woolamai Brush	4746-60	2
Evening Tigris	4674-60	2	Limber Maple	10734-60	2	Pewter Mesh	4878-38	2			
Fashion Grey	D381-60	2	Linen	D427-60	2	Pinnacle Walnut	7992-38	2			
Flax Linen	4930-38	2	Loden Zephyr	4844-60	2	Platinum	D315-60	2			

PVC Edge Selection

Tier 2 and 3 Laminates require the additional specification of a PVC edge band. Choose from one of the following JSI standard options.

ALB	Alabaster	MES	Mesa
BEL	Belair	MIN	Mineral
BLK	Black	MCH	Mocha
BRK	Brickdust	OBK	Outback
BBL	Bridal Blanco	PIL	Pilsner
CSK	Cask	PIN	Pinnacle Walnut
CLY	Clay	SHD	Shadow
DWH	Designer White	SLG	Slate Grey
EGR	Egret	UMB	Umber
FAW	Fawn	VAL	Valley
FLN	Flint	WLH	Walnut Heights
FLO	Florence Walnut	WEA	Weathered Ash
LOF	Loft	ZEN	Zen Grey

Wilsonart Solid Surface

Forge offers an extensive program for Solid Surface beyond our Standard Program. Always reference below the most current listing and tier pricing when using a Graded-In Solid Surface.

Solid Surface	Pattern	Tier	Solid Surface	Pattern	Tier
Angel Falls	9223SS	3	Silver Smoke	9226SS	3
Antique White	1572SL	2	Steel Grey Tempest	9194TM	2
Arctic Drift	9246SS	3	Titanium Grey	9222SS	2
Arctic Dune	9253CM	3	Tumbled Stone	9220CE	3
Arctic Melange	9070ML	2	Whisper White	9237SS	3
Aspen Quartzite	9245SS	3	White Stone	9208CS	3
Avalanche Melange	9175ML	2	Whitewater	9198EA	3
Baja Melange	9030ML	2	Yukon Riverstone	9196RS	2
Basalt Concrete	9254SS	3	Zen Grey	9115GS	2
Beachfront	9233SS	2			
Beige Tempest	1530TM	2			
Beige Travertine	9236SS	3			
Bluestone	9074EA	3			
Brooklyn Concrete	9219GS	2			
Calacutta Perlato	9913SS	3			
Calming Waves	9240SS	3			
Cannon Beach	9250SS	2			
Caramel Melange	9033ML	2			
Carbone Marmo	9914SS	3			
Carrara Emporio	9909SS	3			
Cashmere Mirage	9135MG	2			
Chai Cream Mirage	9111MG	2			
Chicory Cream Melange	9047ML	2			
Chilled Earth	9228SS	2			
Cloud Mist	9243SS	3			
Coconut Oil	9100GS	2			
Cool Basalt	9251SS	2			
Cream Swirl	9242SS	3			
Dusk Ice	9203CE	3			
Europa	9210CM	3			
Flint Rock	9207CS	3			
French Blue Melange	9024ML	2			
Frosty White	1573SL	2			
Frosty White Mirage	1573MG	2			
Gold Glitz	9108CS	3			
Golden Sail	9234SS	3			
Grey Beola	9218CM	3			
Grey Lace	9224SS	3			
Gulf Coast	9239SS	3			
Hidden Space	9227SS	2			
Ice Statuario	9912SS	3			
Iron Falls	9238SS	3			
Jovian	9211CM	3			
Kimberlite	9215CE	3			
Luminous White	9221SP	2			
Mansoned Concrete	9252SS	3			
Maple Harvest	9106CS	3			
Marzipan Mirage	9130MG	2			
Metro Concrete	9249SS	2			
Midnight Frost	9244SS	3			
Midnight Melange	9091ML	2			
Milk Glass Spectra	9077ST	2			
Mink Concrete	9248SS	2			
Monte Amiata	9911SS	3			
Moon Geyser	9209CM	3			
Morning Ice	9204CE	3			
Mystique	9200CS	3			
Night Stars	9105CS	3			
Northern Melange	9195ML	2			
Oatmeal	9101GS	2			
Paris Fog	9110CS	3			
Peace Grey	9232SS	2			
Pearl Mirage	9199MG	2			
Pebble	9036EA	3			
Powder White	9230SS	2			
Quarry Melange	9041ML	2			
Quiet Swirl	9241SS	3			
Relaxed White	9247SS	2			
Saharan Night	9225SS	3			
Sea Stone	9202CS	3			

Corian Solid Surface

Forge offers an extensive program for Solid Surface beyond our Standard Program. Always reference below the most current listing and tier pricing when using a Graded-In Solid Surface.

Solid Surface	Pattern	Tier	Solid Surface	Pattern	Tier
Abalone	COR-ABA	3	Sahara	COR-SAH	4
Antarctica	COR-ANT	3	Sand Storm	COR-SST	4
Archeologic	COR-ARC	3	Sandalwood	COR-SDL	4
Arctic Ice	COR-AIC	4	Sandstone	COR-SAN	3
Arrowroot	COR-ARR	4	Savannah	COR-SAV	4
Artista Beige	COR-ABE	3	Sepia Linear	COR-SLI	4
Artista Canvas	COR-ACA	3	Serene Sage	COR-SSA	4
Artista Dust	COR-ADU	3	Silt	COR-SIL	3
Artista Gray	COR-AGR	3	Silver Birch	COR-SBI	4
Ash Aggregate	COR-AAG	4	Silver Gray	COR-SGR	2
Ash Concrete	COR-ACO	4	Silver Linear	COR-SLN	4
Aurora	COR-AUR	3	Silverite	COR-SLV	4
Bisque	COR-BIS	2	Smoke Drift Prima	COR-SDP	4
Bleached NuWood	COR-BNU	4	Sorrel	COR-SOR	4
Bone	COR-BON	2	Sparkling Granita	COR-SPG	4
Cameo White	COR-CWH	2	Sparkling White	COR-SWH	3
Canvas	COR-CNV	4	Stonique	COR-STO	3
Canyon	COR-CAN	3	Vanilla	COR-VAN	2
Carbon Aggregate	COR-CAG	4	Venaro White	COR-VWH	4
Carbon Concrete	COR-CCO	4	Verdant	COR-VER	4
Carrara Crema	COR-CCR	4	Weathered Aggregate	COR-WAG	4
Carrara Lino	COR-CLI	4	Weathered Concrete	COR-WCO	4
Cirrus White	COR-CIW	4	Whipped Cream	COR-WCR	4
Clam Shell	COR-CSH	4	Whisper	COR-WHI	4
Concrete	COR-CON	4	White Jasmine	COR-WJA	4
Cosmos Prima	COR-CPR	4	White Onyx	COR-WON	4
Deep Anthracite	COR-DAN	4	Willow	COR-WIL	4
Deep Black Quartz	COR-DBQ	4	Windswept Prima	COR-WPR	4
Deep Cloud	COR-DCL	4	Witch Hazel	COR-WHA	4
Deep Espresso	COR-DES	4			
Deep Mink	COR-DMI	4			
Deep Night Sky	COR-DNS	4			
Deep Nocturne	COR-DNO	4			
Deep Sable	COR-DSA	4			
Deep Storm	COR-DST	4			
Deep Titanium	COR-DTI	4			
Designer White	COR-DWH	3			
Doeskin	COR-DOE	4			
Domino Terrazzo	COR-DTE	4			
Dove	COR-DOV	3			
Dune Prima	COR-DPR	4			
Elegant Gray	COR-EGR	3			
Evening Prima	COR-EPR	4			
Everest	COR-EVE	3			
Excavage	COR-EXC	3			
Glacier Ice	COR-GIC	3			
Glacier White	COR-GWH	2			
Gray Onyx	COR-GON	4			
Hazelnut	COR-HAZ	4			
Hot	COR-HOT	4			
Juniper	COR-JUN	4			
Laguna	COR-LAG	4			
Laguna Terrazzo	COR-LTE	4			
Lava Rock	COR-LRO	4			
Limestone Prima	COR-LPR	4			
Linen	COR-LIN	2			
Matterhorn	COR-MAT	3			
Modern White	COR-MWH	3			
Natural Gray	COR-NGR	4			
Neutral Aggregate	COR-NAG	4			
Neutral Concrete	COR-NCO	3			
Nimbus Prima	COR-NPR	4			
Pearl Gray	COR-PGR	2			
Pebble Lane	COR-PLA	3			
Peppered Terrazzo	COR-PTE	4			
Platinum	COR-PAT	4			
Provence NuWood	COR-PNU	4			
Rain Cloud	COR-RCL	4			
Rice Paper	COR-RPA	4			
Rosemary	COR-ROS	4			
Sagebrush	COR-SAG	4			