

pricelist

effective March 4, 2024
updated for April 8, 2024 Forge Introduction

JSI HEALTH



JSI Price Lists

Tables + Casegoods

[Apogee](#)
[Bourne Tables](#)
[Brogan](#)
[Collective Conference](#)
[Copilot](#)
[Finale](#)
[Lincoln](#)
[Native](#)
[Nosh](#)
[Privacy Program](#)
[Prost](#)
[Reef](#)
[Romy](#)
[Strata](#)
[Traditional](#)
[Trail](#)
[Walden](#)
[Wellington](#)
[Accessories](#)

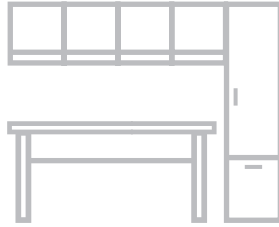

Lok

[Training Tables](#)
[Teamwork Tables](#)
[Conference Tables](#)
[Occasional Tables](#)



Flux

[Private Office](#)

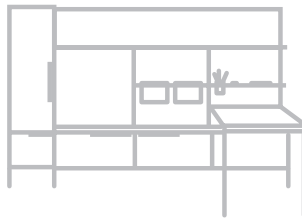

Healthcare

[Seating](#)
[Kindera](#)
[Satisse](#)
[Somna](#)
[Casework](#)
[Forge](#)



Vision

[Casegoods](#)
[Tables](#)



Seating

Addison	Madison
Americana	Melrose
Ansen	Millie
Arwyn	Moto
Avalon	Murphy
Avini	Newton
BeSpace	Oxley
Boston	Pillow
Bourne Seating	Poet
Bryn	Protocol
Caav	Proxy
Cabaret	Ramona
Class Act	Ria
Collective Motion	Sosa
Connect	Tara
Encore	Teekan
Esque	Totem
Finn	Trinity
Finn Nu	Tyler
Garvey R5	Wink
Gatsby	Ziva
Harbor	
Hoopz	
Indie	
Jude	
Knox	
Kyla	
Laurel	
Mackey	



Environmental Mission

Our vision and goal is a sustaining supplier, manufacturer and customer for the long term protection and preservation of our environment for future generations.

MISSION

To achieve this vision, we are dedicated to ensuring the health and wellbeing of all of our partners, reducing negative impact on the environment, and maintaining price structure by increasing efficiencies and reducing consumption.

JSI, and it's parent company, is an internal manufacturer and has been an environmentally conscious organization for more than 80 years.

We are proud to use wood as our primary sustainable material resource and all corporate policies and procedures support the efforts to "recover, recycle, reuse, repurpose, reduce, refuse, and re-engineer". In doing this, we are committed to the conservation of the environment and its natural resources as well as encouraging our suppliers and customers to do the same. A goal of a "Sustainable Partnership", supplier, manufacturer and customer, is essential for the long term protection preservation and sustainability of our environment for future generations.

LOCATION

Our manufacturing facilities are located in the center of Southern Indiana. With our diverse product offering and manufacturing capabilities, we provide a single source for all of your project needs allowing you to conserve our fossil fuels and reduce greenhouse gases.

PACKAGING

We place emphasis on the minimal use of disposable packaging while still providing adequate protection to the finished product. Our corrugated packaging is recyclable, reusable, and up to 100% recycled content. We reuse or recycle more than 175 tons of corrugated material annually.

REGULATORY

All of our manufacturing facilities are in compliance with applicable OSHA regulations and meet or exceed all applicable DEM and EPA regulations for air emissions, storm water and hazardous waste disposal.

MANUFACTURING FACILITIES

Our manufacturing facilities are geared toward eco-efficiency and are encouraged to continually improve and conserve. Solid wood not used in the direct manufacturing process is recovered for the operation of our dry kilns, thus reducing greenhouse gases, the use of fossil fuels, and the burden of waste placed on landfills. Composite panels not used in the direct manufacturing process are ground and sold for use as animal bedding and boiler fuel. In addition to other energy savings techniques, our manufacturing facilities use high efficient lighting, make use of power factor capacitors, and encourage all to conserve and reduce energy consumption and water usage. Condensation pumps are used to aid in water conservation as well as extending boiler life.

MANUFACTURING PROCESSES

Our finish processes utilize efficient spray guns and proper spray techniques to reduce wasted material. Excess finish material, solvents, and waste are recycled. Many of the assembly processes use water based glues that contain no hazardous ingredients.

TEXTILES

Many of our fabric options utilize up to 100% recycled content. Our leather alternative program includes selections that contain no toxic materials, plasticizers, heavy metals, or formaldehyde and have a 100% biodegradable back cloth. Some of the available panel fabric used, if discarded is a biological nutrient for the soil. Most of the components (foam, batting, and polycord) used in upholstered products are recyclable. Excess fabrics and leathers not utilized in the upholstery process go to recyclers and local charities for additional use.

WOOD

Wood is the most diverse, most process friendly, and most widely utilized natural resource in mankind's history. No other natural resource can match the environmental advantages of wood, including being renewable, recyclable, natural, carbon negative, and biodegradable. Utilizing the sun's energy, trees grow and remove carbon dioxide from the air while giving off oxygen to benefit the entire planet. Approximately 49% of wood's dry weight is carbon and harvesting mature trees in a sustainable forest, which has slowed in the absorption of carbon dioxide, allows the photosynthetic cycle to continue at full optimization and allow for the carbon to remain sequestered. We are proud to use wood as our primary "sustainable" renewable resource.

WOOD OPTIONS

Many environmentally friendly solid wood and engineered wood options are available for quote, including: Lyptus®, Plyboo®, reclaimed woods, agricultural and post-consumer waste fiber products, etc.

INDOOR AIR QUALITY

Our goal is to reduce the impact our products will have on the indoor air quality. We practice the latest technologies and utilize a third party to assure we meet this goal. GreenGuard, one of the leaders in IAQ certification, continues to certify our product offering with UL2818 - GreenGuard Indoor Air Quality certification.

PARTNERSHIPS

BIFMA
Business and Institutional Furniture Manufacturer Association

USGBC

United States Green Building Council

IIDA

International Interior Design Association

FSC

Forest Stewardship Council - Forestland

UL GreenGuard

Indiana Department of Natural Resources - Division of Forestry - Classified Forest, Wildlands Program

Lifetime Warranty

JSI warrants to the original purchaser that each piece of furniture will be free from defects in workmanship, given normal use and care for as long as the original customer owns and uses the product. Normal use is defined as the equivalent of a single shift, 40-hour work week.

JSI will, at its option, repair or replace with comparable product within the terms of the warranty.

Exceptions to Warranty:

12 Years (from date of purchase)

- Wood Seating
- Seating Controls
- Pneumatic Cylinders
- Laminate Surfaces
- Veneer Surfaces
- Solid Surface Components
- Somna, Kindera, Satisse and Forge in multi-shift environment except components as specifically identified below

10 Years (from date of purchase)

- Recliner Mechanisms and Associated Levelers (regardless of shift usage)

5 Years (from date of purchase)

- Casters (including recliner central locking)
- Glides (including MagLinx™)
- Electric Height Adjustable Bases
- Task Lights
- Mesh/Knit Materials
- Electrical Components
- Foam
- Recliner Heat Components

This Warranty Does Not Cover:

- Natural variations in color, grain or texture of wood and other covering materials over which JSI has no control
- Normal wear, color fastness, shrinkage, puddling, wrinkling and stretching of upholsteries including fabric, vinyl, leather and other textiles. This warranty does not cover any defects that may arise in the use of COM or COL upholstery materials. Textile manufacturer's warranty will apply.
- Damages resulting from transportation, improper assembly, installation, handling, accident, user modification attachments, misuse, or neglect of product care.
- Damage resulting from extreme climate conditions
- Finish damages resulting from normal wear and tear, improper maintenance, water damage, exposure to sunlight, extreme high or low humidity or temperature, or other acts of nature.
- Damage created by loading file drawers with anything other than hanging folders.
- Use of any unauthorized non-JSI components for use in the place of JSI components, including but not limited to worksurfaces, bases, brackets, or other essential components.

Replacement components are warranted for a duration of 2 years or for the remaining duration of the initial warranty, whichever extends further.

Textile supplier's warranty will apply. Given the diverse range of cleaning agents used by various facilities, it is advisable to conduct testing on each textile choice using the facility's designated cleaning techniques prior to placing an order.

JSI makes no expressed or implied warranties to any product and, in particular, makes no warranty of merchantability of fitness for any particular purpose. JSI will not be liable for any consequential or incidental damages under this warranty.

Unique Characteristic of Natural Woods and Veneers

JSI uses high quality wood and veneer harvested from sustainably managed forests. Every tree has unique and defining characteristics, like fingerprints. These characteristics can be defined by differences in color, grain configuration, and textures. These characteristics will be more noticeable if the product has a clear or lighter finish.

JSI uses select beech, cherry, maple, oak and walnut cut wood products to produce the desired look of our furniture products.

Maple and Cherry species have a higher degree of uneven distribution of grain, small color streaks, and pin knots.

At JSI, we take care of selecting woods and veneers that are used in our products. With this in mind, we hope you appreciate the beauty of each tree's fingerprints. Products will not be replaced due to these natural characteristics.

Veneers can be sliced in a variety of ways to create unique patterns. JSI uses several different patterns, as shown below.

Flat (Plain) Cut as shown in diagram

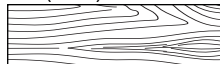

Quarter Sliced as shown in diagram

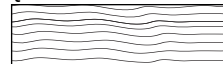

Double Cut as shown in diagram



Rift Cut as shown in diagram

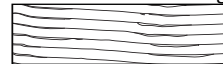

Double Cut

The Double Cut veneer is a processed product that has at least two cuttings to create the final veneers. These cuts of veneer strands are dyed and layered into a block to create variation of patterns from a very tight grain pattern to an exotic figure grain pattern.

JSI offers two collection of veneer, our Essentials and Artisan Collections.

Essentials

The Essentials Collection allows users to specify beautiful veneers, without sacrificing budget, providing grain patterns and hues for maximum material flexibility and style range.

Artisan

The Artisan Collection provides a curated selection of finishes expressing an elevated style and contemporary nature

Laminates (Veneer Series)

An alternative HPL (Higher Pressure Laminate) laminate work surface can be specified on most of our casework product lines. The specification pages will also list the available coordinating finishes.

Laminate Series

JSI laminate series offer a full laminated product with imprinted grain to hide finger prints and provide durability. The worksurface tops are HPL (High Pressure Laminate) or TFL (Thermal Fused Laminate). TFL is used on the product's chassis.

An overview of finishes and laminates appear on page IV, detailing which species each veneer finish is applied to.

Series Material Offering

Select finishes, species and materiality are available on a per series offering, with JSI curating the correct palette offering for the series intent. Please refer to each series feature highlights within the product pages to identify the material, species, grain patterns and finishes available for that specific series.

JSI Core Materials

For projects requiring similar finishes across multiple series, JSI recommends using our Core Materials program. Finishes in this group are offered throughout the vast majority* of JSI products in the three main material categories Essentials and Artisan Veneer, Laminate and Solid Maple, in a spectrum of light to dark.

*note: not applicable to all series, for example BeSpace only offers clear veneer finish.

Finish - Top Coat

To reduce hazardous formaldehyde emissions, we use our proprietary specially designed top coat, DuraTex™. It significantly reduces hazardous formaldehyde emissions and helps improve indoor air quality.

Finish - Color/Stains

A wide range of stains are available to bring out the beautiful characteristics of each wood species. We coordinate finish color between our veneer stains and solid lumber stains; however, not all may be a perfect match. The stains are continually reviewed for accuracy of color, as well as a constant monitoring of the latest color trends in the furniture market.

Finish - Matching

Due to the natural characteristics of wood, environmental effects, and material upgrades, JSI cannot guarantee exact finish matches on existing furniture previously ordered.

If an exact match is required to accompany existing furniture, it must be specified at the time of order placement, so specific internal procedures can be followed to ensure a proper and acceptable finish match. We reserve the right to change our finish formula at any time to improve safety, quality, and appearance. Unless a finish match for existing furniture is requested at the time of ordering, we accept no liability for finish that may not match the existing furniture from prior orders.

Solid lumber may inherently have mineral streaks, pits, and various other natural occurrences. Care is taken in selecting the solid lumber to coordinate with the requested finish on our veneer products. This internal selection process is subject to availability of solid lumber parts.

Finish Sheen

All casegood veneer finishes are standard in 35-sheen, with the exception of Raven, which is only offered in 15-sheen. All other finishes are available in 15-sheen, with a 5% upcharge, per model

Custom/Special Finishes

JSI, upon request, will accommodate special finishes. A written request is required to proceed with custom finish orders. A sample reference is required for first time matches and must be included with the written request.

There is a one time charge of **\$372 list per order** for any non-standard wood finish.

Orders will be entered noting the special finish. A sample match will be provided to the customer. Written approval is needed before the finish process can be started. Delays in approval may have an impact on lead times.

Every effort will be made to create the requested match; however, an acceptable match may not be possible because of natural variations of wood. These natural variations can also cause minor differences in the final finish product.

Samples

Samples of standard wood finishes, paints colors, metal colors, and standard laminate are available upon request. The fastest way for requests to be filled is by using our website. See below for options to request samples.

Website - jsifurniture.com (click the resource tab)
 JSI Sales representatives
 Phone - 800.457.4511 - Customer Service
 Email - customerservice@jaspergroup.us.com

Veneer Finish and Laminate Overview

Designator	Finish	Veneer Collection	Veneer Species	Laminate	Core Program
BAR	Barrel	Artisan	White Oak- Double Cut	n/a	N
BRK	Brickdust	Essentials	Cherry	HPL & TFL	Y
BUF	Buff	Artisan	White Oak- Double Cut	n/a	N
CSK	Cask	Essentials	Walnut	HPL & TFL	Y
CND	Cinder	Artisan	White Oak- Double Cut	n/a	N
CLY	Clay	Essentials	Cherry	HPL & TFL	Y
EGR	Egret	Artisan	White Oak- Double Cut	HPL & TFL	N
FAW	Fawn	Essentials	Linear - Double Cut	HPL & TFL	Y
FLX	Flax	Essentials	Maple	n/a	N
FLN	Flint	Essentials	Linear - Double Cut	HPL & TFL	Y
LOF	Loft	Essentials	Linear - Double Cut	HPL & TFL	Y
MES	Mesa	Essentials	Cherry	HPL & TFL	Y
MIN	Mineral	Essentials	White Oak- Double Cut	HPL & TFL	Y
MCH	Mocha	Essentials	Walnut	HPL & TFL	Y
OBK	Outback	Essentials	Cherry	HPL & TFL	Y
PIL	Pilsner	Essentials	Maple	HPL & TFL	Y
RAV	Raven	Artisan	Black Oak	n/a	N
RYE	Rye	Artisan	White Oak- Double Cut	n/a	N
SAB	Sable	Artisan	White Oak- Double Cut	n/a	N
SAD	Saddle	Artisan	White Oak- Double Cut	n/a	N
SIE	Sienna	Essentials	Walnut	n/a	N
TRF	Truffle	Essentials	Walnut	n/a	N
UMB	Umber	Essentials	Walnut	HPL & TFL	Y
VAL	Valley	Essentials	Linear - Double Cut	HPL & TFL	Y

Pricing

Prices found in this document or on our website are list prices in U.S. dollars for standard product delivery to one destination. Prices do not include storage, installation, or taxes. Possession of this price list does not constitute an offer to sell. Orders can only be received from approved authorized JSI dealers.

Prices and product information in this document, as well as our website, are subject to change without notice. Reference website for most up to date product offering and pricing.

Orders

Detailed specification pages are available in the price list at the beginning of each series.

Additional information may be obtained by consulting the Customer Service Department or our website.

Indicate shipping address if different from billing address.

Send Orders To:

US Mail – JSI

225 Clay Street

Jasper, IN 47546

Fax – 812-482-1548

Email – orders@jaspergroup.us.com

JSI reserves the right to make changes in dimensions, styles, or specifications if we believe these changes will improve the safety, quality, or appearance of the product.

Acceptance of orders will be subject to credit approval, barring any acts of governments, or any other causes beyond our control (e.g. strikes, fire, embargo of materials, etc).

Product Modifications

While we offer a wide range of products to accommodate many possible solutions, we also recognize the needs for our products to be modified from our standard offering.

In the series introduction section of each product, we address modification options for that series.

To see if the desired modification is possible, please contact our Customer Service Department for a quote. Note that order quantities and material availability can affect the quote. Additional information may be requested to fully quote modifications.

Order Acknowledgments

All orders will be acknowledged promptly upon entry of a clean order. The acknowledgment will show how the order was entered, ship date and any other information pertinent to the order. It is the purchaser's responsibility to verify all the information on the acknowledgment carefully and notify us immediately, in writing, of any discrepancies.

Every reasonable effort is made to ship as acknowledged; however, the acknowledged ship date is approximate. Company will generally ship within five (5) working days of the acknowledged ship date. If a firm ship date is necessary, customer must inform company at time of order and company will make all reasonable efforts to meet each customer's request. Acknowledged shipping dates are contingent upon the force majeure conditions contained in these terms and conditions.

Quickship

JSI offers select Vision models, with select options, in our Quickship program. These items ship within 10 business days after receipt of a clean, credit approved purchase order. Items should be placed on order separate from standard lead time models.

Product for up to 10 offices or 10 tables can be included on a single Quickship order. Available capacity is filled by orders as they are received. If normal 10 day Quickship is not available because capacity has been filled, you will be immediately notified by JSI customer service. Changes and cancellations to Quickship orders are not allowed under any circumstances, nor are modifications to the predetermined Quickship offering. Limit one order per project.

Delivery

Our freight policy consists of prepaid freight to the 48 contiguous states; all other shipments are prepaid to port of exit ONLY. JSI reserves the right to select the appropriate carrier and shipment routes, most shipments are on freight carriers that are dedicated furniture specialists. Standard deliveries require a DOCK that can accommodate **75 foot trucks**. Ownership and inspection of product is the responsibility of the buyer upon pickup by the freight carrier. Pricing in this book is for standard delivery only. Standard delivery does **not** include non-dock delivery, inside delivery, residential delivery or installation of product. Fees and changes for non-standard deliveries are listed below.

Standard Delivery Time

Between 8AM and 3PM Monday through Friday. Special delivery requests can be subject to additional fees to accommodate requests.

Cancellations and Changes

All orders are considered firm and are not subject to cancellation or change without approval from JSI. All approved changes are subject to additional charges and revised lead times

No Touch Freight

Our freight is considered "no touch". Therefore, customers are to be prepared to unload freight from inside the truck prior to arrival. In the instance that a driver must unload the shipment, driver assists fees will apply (see fees below).

On-Site Deliveries

Shipments to the installation site, and time deliveries are available on full truckloads or slightly less, at no additional charge. Shipments or timed deliveries for smaller shipments may not be available, or if available may require an additional charge.

Detention Fees

- Carriers are given two-hour maximum time allotment to unload for one-stop truckloads.
- Carriers are given one hour maximum time allotment to unload for multi-stop truckloads
- *Detention fees apply after allotted unloading time and will be at buyer's expense.

Fees

Orders of less than \$1,000 net \$90 net per order
 (If order is UPS shippable, the handling fee is waived and customer is invoiced for exact shipping charges.)
 Weekday deliveries outside of standard delivery times \$300
 Weekend deliveries (Saturday or Sunday) \$600
 Liftgate Deliveries. \$500 minimum 7% of net price
 Driver Assist \$90
 Jobsite Non-Dock Delivery \$150 per truck
 Inside Delivery (first floor inside only) - no installation or carton removal. \$250 minimum 7% of net price
 NO RESIDENTIAL DELIVERIES

Warehouse/Storage Fees

Additional storage time with a provided two-week approved notice is calculated at 3% per month of the product amount or per day.

Please be Advised

- Reconsignment fees are the responsibility of the buyer.
- Any charges arising from failure to meet shipment, re-routing while in transit or carrier storage charges are the responsibility of the buyer.
- Contact Customer Service to inquire about skidding of products, special crating of products and product installation. These requests must be approved by JSI and made at the time of order.
- Carriers have the right to refuse delivery to a specified location if it conflicts with their liability policy.

Freight Damage

JSI products are packed in cartons and meet or exceed existing codes for furniture and seating products. All shipments are delivered to the carrier in good condition and our liability ceases thereafter. If delivery arrives short or damaged, contact Customer Service immediately to file a claim. In the event of concealed damage, notify Customer Service and request immediate inspection. Failure to file a claim within 15 days after receipt of merchandise constitutes acceptance and a waiver of any such claims. Please inspect merchandise immediately upon receipt, otherwise there is no recourse. Keep all cartons and packing material, discarding these materials may negate your claim.

Storage of product in areas of uncontrolled humidity and temperature may cause damage to the product and void the JSI warranty.

Repairs

JSI will not issue credit allowance for any type of repairs without prior written consent.

Sales order, product model numbers, and reason for repair will be expected in order to process the repair request. A digital photo will help to expedite the request. JSI reserves the right to recommend solutions for repair.

Replacement Parts

Obtain information and pricing on replacement parts by contacting Customer Service. Please have the model number available when requesting replacement parts. Additional information may be required to ensure proper replacement parts.

Returns

JSI products are made to order and may not be returned for credit. No merchandise may be returned to JSI without a signed Return Good Authorization (RGA) form issued by our Customer Service Department. RGA's will be considered for the following reasons:

1. Manufacturing defect (validated by JSI representative).
2. JSI order processing error.
3. Shipping error.
4. Mis-marked cartons.
5. Duplicate shipments.

Liability for defective merchandise shall be limited to replacement or repair.

If you have questions as to whether your reason for return qualifies for consideration, please contact Customer Service. At the discretion of JSI, returns on stocked items may be considered with the following stipulations:

1. 60% restocking fee.
2. All return freight charges must be prepaid by dealer.
3. Product was never removed from the original carton.
4. Product must be returned within 30 days of RGA issue date.
5. Credit will not be issued if product returned is damaged.
6. Under no circumstances can we accept COD (Cash on Delivery) returns. Any such shipment will be refused.

Please note most models on Quickship are produced on demand and cannot be returned. Modified, special or custom-built product is not eligible for return.

Fire Retardancy

All JSI upholstered components comply with California Bureau of Home Furnishings and Thermal Insulation-Technical Bulletin 117-2013 issued by State of California Department of Consumer Affairs. This standard requires upholstered furniture to be safer from the hazards associated with smolder ignition in all four (4) categories of materials, as applicable.

Compliance with more stringent codes may require special manufacturing considerations and upcharges.

California Technical Bulletin 133 (CAL 133)

JSI uses a barrier material between the foam cushioning and the upholstery cover in order to comply with CAL 133. The standard upcharge on products specified to comply with CAL 133 is \$78 list per yard of textile.

JSI has performed a series of full scale fire tests on samples - representing worst case scenarios of upholstered units - to comply with the requirements of the state of California Technical Bulletin 133 (CAL 133). Products in compliance are labeled in accordance of the standards.

Some product designs and fabric cannot be combined to comply with CAL 133. Because of this, we reserve the right to reject any request for an upholstery cover, including COM, textile may not contain olefin or product style that we feel may compromise the integrity or safety of a product specified to comply with CAL 133.

Contact Customer Service for a quote if you require laboratory certification that a specific product and upholstery combination WILL PASS CAL 133. The quotation will include testing, video, and transportation charges plus the list cost of the sample.

Our standard lead time will apply to products that do not require certification. Allow an additional six weeks over the standard lead time for products that need actual laboratory certification.

The end user, specifier and/or dealer have the responsibility to make sure all products specified will meet the flammability and safety codes of the jurisdiction where the products will be located and used.



Flame Spread

All JSI may be required to comply with the requirements of Flame Spread based on ASTM standards/NFPA Life Safety Codes and general public knowledge are as follows:

- Solid Wood - Class C
- Topcoats - Class A
- Carded Fabric - Class A
- Composite Panels - Class C
- Laminate - Class B

Plastics - According to the NFPA, the lack of stability of plastics under high temperature conditions and inherit combustibility have eliminated the use of plastics for applications requiring a flame spread rating.

Also be advised that improvements may be attained in certain instances with the addition of chemicals which may add additional costs, chemical exposure and/or compromise the integrity of the product.

Textile Carded Programs

JSI is proud to partner with Maharam, Momentum, Spradling, Stinson, Ultrafabrics, Camira and Cortina Leather. Please refer to our website for our standard patterns, along with the current grade.

<https://www.jsifurniture.com/finishes-and-materials/textiles>

Textile Grade-In Programs

For the convenience of our specifiers, we offer an extensive graded in program. Please reference our website for the most up to date information on our graded in program.

<https://www.jsifurniture.com/resources/textile-partner-info/overview/>

For additional specifications on the pattern or to order memo samples, please contact the textile suppliers directly:

- Arc Com www.arc-com.com
- Camira www.camirafabrics.com
- DesignTex www.designtex.com
- Maharam www.maharam.com
- Mayer www.mayerfabrics.com
- Momentum www.themomgroup.com
- Spradling www.spradlingvinyl.com
- Stinson www.cfstinson.com
- Ultrafabrics www.ultrafabricsllc.com
- Cortina Leather www.cortinaleathers.com

Any textile not graded in or pre-approved for COM/COL will require application test approval prior to order entry and shipment of fabric or leather to JSI. For current JSI grades and application status by series visit jsifurniture.com Resources > Graded-In + COM; [Graded-In + COM](#).

Indicate on purchase order if JSI is to order the fabric.

Grades and availability of fabric are subject to change without notice. Changes could include but are not limited to price increase, discontinued patterns, discontinued colors, etc. See jsifurniture.com for up to date information.

Many textiles have repeats and the additional yardage required has been factored in for textiles ordered through the JSI Carded and Grade-In Programs. We reserve the right not to match textiles with a horizontal or vertical repeat greater than 17". Additional charges may apply for textile being applied with special instructions.

Some fabric thickness or stiffness may cause issue with proper upholstering of tackable wall panels or upholstery privacy screens. Please contact customer service with concerns on the fabric thickness for these items.

COM/COL Address

JSI
Attn: COM/COL Department
Receiving B
Dock 71
201 East Martin St.
Orleans, IN 47452

Tag: Dealer Name / Purchase Order #

General COM Fabric/COL Hide Policy

Refer to the COM/COL Price Columns for list prices.

All yardage requirements listed in the price list are based upon 54" plain non-directional material. Additional yardage may be required based on fabric repeat and matching.

All square footage requirements for COL are based on an average hide size of 50 square feet.

Contact Customer Service for any of the following conditions:

- + approval of COM/COL to be used (see policy on the next page)
- + fabric repeats greater than 3"
- + fabric less than 54" wide
- + leather hides smaller than 50 square feet
- + special application requirements request

When requesting information from Customer Service on COM/COL please supply the following information:

- + model number and quantity of the product the COM/COL will be applied
- + COM/COL textile supplier's name
- + name of pattern and color of the textile
- + any special application request

Visit jsifurniture.com Resources > Graded-In + COM to see if the textile has already been approved. If there is no record for this particular textile then a Memo Sample will be required.

JSI takes no responsibility when additional materials must be ordered.

COM Fabric Repeat Guide

Roll Width	Plain Fabric	1" - 5" Repeat	6" - 10" Repeat	11" - 15" Repeat	16" - 20" Repeat	21" - 30" Repeat	31" - 40" Repeat	41" - 50" Repeat
54"	0%	10%	15%	20%	25%	30%	40%	50%
53" to 51"	15%	20%	25%	30%	35%	40%	50%	60%
50" to 48"	30%	35%	40%	45%	50%	55%	70%	90%
47" to 36"	60%	65%	70%	75%	80%	85%	100%	120%

The percentage represents the additional fabric yardage that needs to be added to the COM yardage. Contact Customer Service for repeats greater than 50".

All COM/COL must meet applicable codes and regulations, including TB117-2013. By selecting COM/COL, customer certifies that the material meets such codes. JSI assumes no responsibility for the applicable codes and regulation regarding flammability rating and safety rating of any COM/COL.

JSI cannot be held responsible for receipt of defective fabrics, as we apply all COM as first quality goods.

We can take no responsibility for tailoring, wear-ability or application of COM/COL textiles. Any warranty claims for the COM/COL Textile materials will fall to the original vendor of the textile, not JSI.

COM Fabric/COL Hide Process for JSI Seating

General COM Fabric and COL Hide Policy also apply.

JSI will approve or disapprove COM/COL on all products. An approval of a textile from JSI makes no claim that performance, durability or tailoring of COM/COL will result in satisfactory upholstery. Every effort will be made to meet customer's expectation, but fabrics/leathers have unforeseen inherent characteristics that may limit JSI's ability to deliver a well tailored product.

Approval COM Textile/COL Hide Process for Seating

Follow the Steps Below:

1. Send a Memo Sample of the COM/COL (recommended memo be at least 4" x 4")
 JSI
 Attn: COM/COL Approval Department
 201 East Martin Street
 Receiving B, Dock 71
 Orleans, IN 47452
2. Call our Customer Service Department at 812-482-3204 to request an electronic version of approval form.

Guide Order Form for COM and COL

Please send sample to:
 JSI
 Attn: COM/COL Approval Depart.
 201 East Martin St.
 Receiving B, Dock 71
 Orleans, IN 47452

① **Order Information:**

Quote #: _____ Purchase Order #: _____

Customer Service: _____

Dealer Name/Project Name: _____

Contact: _____

Address: _____

Phone: _____ Email: _____

Model Number(s) Receiving COM / COL: _____

Please forward a copy of this form to your JSI CSR for record keeping

② **Select off the bolt application:** *(Check one of the boxes)*

Up the roll (standard on most seating) Railroaded

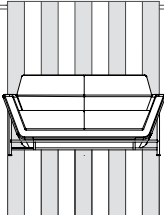
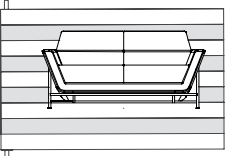
③ **Additional information:** _____

④

Attach sample here.

JSI will review and test as needed all requests. You will be notified as soon as results are documented by our review personnel. JSI reserves the right to reject any COM/COL on our products. We will provide COM/COL explanation of any unapproved textile whenever possible.

Custom Options

Wood Laser Engraved Back

Many of our seating models are available with a custom wood laser engraved back. University seals, logos, unique designs, or any type of graphic can be designed into the seating back for a custom creation. Copyright approval may be required. Consult JSI Customer Service for pricing and artwork specifications. Artwork must be submitted as a JPG or PDF file.



Wood Laser Engraved Back General Pricing

* must order plain back when choosing these options

For Artwork 4" x 4" or Less	\$56 list per chair
For Artwork Less than 6" x 6"	\$99 list per chair
For Artwork Larger than 6" x 6"	Call For Pricing

For orders fewer than 50 pieces, add \$153 list per design, per order. This pricing reflects etching (leaving the wood dark). If additional painted colors are added to artwork please call customer service for pricing.

A \$134 list set-up fee applies.

Care and Maintenance

Care and Maintenance

Care of Upholstery Surfaces

Cleanability will vary based on the fabric type. For best results, a professional service is recommended. Dirt and crumbs may be gently brushed or vacuumed off. Spills should be wiped up immediately with a cloth. Vinyl textiles can be cleaned with warm soapy water and then wiped down with a warm damp cloth. For more details on any JSI carded fabric and vinyl, please visit our website at jsifurniture.com or consult the back of the appropriate swatch card for cleaning codes and any specific instructions. For COM materials, consult with the individual textile manufacturer for cleaning codes and any specific instructions pertaining to your particular fabric.

Maintenance of Mechanical Parts

Clean any lint or debris from the moving parts of the base mechanisms. Mechanisms have been designed and tested to not require lubrication under normal conditions; however, lubricant can be used if needed.

Care of Wood Edges and Veneer Surfaces

Clean all surfaces frequently with water dampened soft cloth, moving the cloth with the grain direction. Immediately remove any liquids that come in contact with wood surfaces with a blotting action to absorb liquid. Buff dry. Lift objects to move them, never pull them across the finished surface. For an additional safeguard, use a protective surface pad. This will ensure a lasting finish by protecting your furniture from possible damage caused by pens, cups and sharp objects. Avoid exposure of furniture to extremes of heat and cold, or to wide humidity variances. Avoid exposure of furniture to strong sunlight. Avoid exposure of furniture to harsh solvents such as nail polish remover, acetates, etc., as it will cause finish deterioration. If using a protective glass top, place spacer pads under the glass top to allow the wood to breath.

Care of Metal Finishes

Wash you powder-coated item at least one every six months. Use soft rags only - No abrasives. For stubborn stains and grease marks, use soap and water mixture. Combine 1 gallon of water and 1 cup of the neutral detergent in the bucket. Mix it up by swirling one of the rags around in it. Wipe down the powder coat with a rag that has been dampened with the cleaning solution. Do not scrub, but use gentle, repetitive pressure to remove any built-up grime. Rinse the powder coat off with a rag dampened with clear, clean water. Do not spray it down, but rather wipe it off with the rag. You may need to do this several times to get all the soap off. Wipe the powder coat down with a clean dry rag. This will prevent streaking and spotting.

Care of Frosted Glass

Use a clean, dry lint free cloth to wipe the surface. Follow with warm water and a clean rag; no soap or chemicals. Wipe dry with a clean, dry lint free cloth. Cleaning the frosted side is not recommended, if desired to clean use the above method but do not spray the water on the frosted side, use a clean rag. Please allow 48 hours for the frosted side to dry and not to show cloudiness.

Tempered Glass Information

JSI is aware of occasional occurrences of spontaneous glass breakage in various furniture products. Tempered glass makes it stronger and if it breaks, will cause it to break into many small pieces of "cubes" rather than sharp and potentially dangerous shards.

Glass breakage in furniture may occur for a variety of reasons. Tempered glass is particularly prone to breakage from damage (scratches, nicks, etc.) that may occur during shipping, handling, installation, use or maintenance. Exposure to rapid changes in temperature or concentrated temperature zones may also cause breakage.

Tempered glass may also break due to a specific type of imperfection or "inclusion" that occurs within the glass when manufactured. When this condition exists glass breakage may occur without any obvious cause. This is often referred to as "spontaneous" breakage but is a very isolated occurrence in the glass industry.

Care of Dry Erase Boards

Erase after every use to eliminate ghosting. Clean weekly with a Dry Erase Cleaner. Avoid the use of orange and red Dry Erase Markers. Follow manufacturers cleaning instructions for the eraser. If ghosting or staining remains use a small amount of rubbing alcohol on a clean, soft towel to remove.

Care of Solid Surface

Although liquids cannot penetrate Solid Surface, it is best to wipe up spills as they occur. Generally, a damp microfiber cloth used with a standard household kitchen spray should remove most stains.

For most residues, all you need to clean your Solid Surface countertops is a warm soapy water, ammonia-based household cleaner or a dedicated countertop cleaner. Do avoid window cleaners; however, as they can leave a waxy build-up that dulls the surface. Always clean using a circular motion.

Film will build up on countertops if water is left to dry on the surface. This film will dull the countertop surface, making the finish appear blotchy and uneven. To prevent film build-up, it is very important to wipe the countertop completely dry immediately after spills and cleaning.

Some color of Solid Surface may require more frequent cleaning to maintain a uniform finish. Darker colors tend to require more attention than lighter colors. Over time, even with proper care, your countertop will acquire a sheen. Dark colors may show light scratches more readily.

Specification Tools

JSI products are manufactured to order and provide a multitude of options to address your individual customer needs. As you process your order do not forget to include all the necessary information to allow the order entry process to be completed. Please see the order checklist at the beginning of every series.

JSI Customer Service edits every order for complete information. If details are not included with the purchase order, Customer Service will contact you to answer these questions. If information is not completed in a timely manner it will delay the entry process and could affect your product delivery date. To avoid delay in order entry and potential delay in delivery of your order, please double check the line items to ensure all selections have been completed.

To ensure completion of details on your purchase order, electronic catalogs and specification tools have been developed to aid in the process. These electronic tools include:

20-20 GIZA Studio and 20-20 CAP Studio software offers state-of-the-art design, specification, photo-realistic rendering and three-dimensional visualization capabilities for configurable products in the commercial interior design markets. 20-20 GIZA Studio and 20-20 CAP Studio are available for all JSI Casegood and Seating products, in 2D and 3D graphics and the Specifier Catalog. Updates are made monthly reflecting any changes that occurred. To be sure the most up to date information is provided on orders, users of this software program are responsible to update their catalogs.

CET Designer, by Configura is an all-in-one software solution for space planning and configuration of products. The intuitive workflow guides you through entire process from idea to reality - supporting every step of the sales process

GSAdvantage is a Federal Government electronic catalog site offered to assist GSA customers in specifying and pricing JSI product. Listed at this site are all contract items and prices under GSA Contract # GS-28F-0030U.

Our JSI website jsifurniture.com provides many tools to assist in the design and order selection. Included in the site are downloadable images, typicals, product symbols, brochures, contact information, price lists, sales representative locations, warranty and environmental information.

GSA Terms and Conditions



Contract Holder
Contract # GS-28F-0030U

In addition to the standard terms and conditions, the following terms and conditions apply to GSA contract.

Contract Number

GS-28F-0030U

Contract Period

June 24, 2013 - June 24, 2028

Statement of Intended Use

The furniture covered by special item number 33721 Office Furniture shall comply with the requirements defined in purchase description 3QSAB 09-608. All furniture offered under this SIN shall be GSA Chassis Grade 1, 2, 3 or NA, GSA Drawer Grade 1, 2, 3, 4 or NA, Design A B or C, as defined in 3QSAB 09-608.

Description of Special Item Number SIN #33721

Cooperative Purchasing

No

Set Aside

No

FSC/PSC Code

7125

NAICS 337211 Wood Office Furniture Manufacturing 1000 employees

Includes all furniture placed in an office, such as chairs, desks, etc. In addition, ancillary services are included, however services performed shall not be the primary purpose of the work ordered.

Lowest Price Model

SIN #	Model Number	Net Price
33721	VS-LBRKT-20	\$28.03

Maximum Order

\$250,000 net

Geographic Coverage

48 contiguous states and Washington D.C.

Point of Production

Jasper, Dubois County, Indiana
Orleans, Orange County, Indiana

Discount

Discount 61.6%* off list.

*Discount for Walden and Wellington is 61.71% off list.

Discount Quantity

Walden and Wellington only
\$300,000 to \$350,000 Net = 0.5%
\$350,001 to \$400,000 Net = 1%
\$400,001 to \$450,000 Net = 1.5%

Prompt Payment Terms

1% 15 - net 30 days from date of invoice.

Government purchase cards are accepted at or below the micro-purchase threshold

Government purchase cards are accepted above the micro-purchase threshold

Foreign Terms

Not applicable.

Time of Delivery

30-75 days after receipt of order, 90 days maximum.

Expedited Delivery

Contact Customer Service 800-457-4511

Overnight and 2-day Delivery

Not applicable.

Urgent Requirements

Contact Customer Service 800-457-4511

F.O.B. Points

F.O.B. destination, freight prepaid and allowed to 48 contiguous states and Washington D.C. excludes special delivery requirements.



GSA Terms and Conditions

Ordering Address

Jasper Seating Company, Inc. d/b/a JSI
Attn: Participating Dealer
225 Clay Street
Jasper, IN 47546
Fax: 812-482-1548
Phone: 800-457-4511
Email: orders@jaspergroup.us.com

Order Procedures:

Per contract

Payment Address

JSI
225 Clay Street
Jasper, IN 47546

Warranty Provision

Limited Lifetime

Export Package Charges

Quoted on project-by-project basis.

Terms of Government Commercial Credit Card Acceptance

Accepted.

Rental, Maintenance, and Repair

Not applicable.

Terms and Conditions of installation

12% of net purchase order for installation services up to \$250,000.00 of net purchase price.

Terms and conditions of repair parts, etc.

See warranty.

List of service and distribution points

Contact Customer Service 800-457-4511.

List of participating dealers

Contact Customer Service 800-457-4511.

Preventive Maintenance

N/A

Environmental Attributes

GreenGuard Certified and recycled wood waste and fabric remnants

Section 508 Compliance.

N/A

DUNS

00-636-7767

CCR and SAMS Registration

Jasper Seating Company, Inc. is registered
Cage Code #31881
Federal ID #35-0420370
UEI #DDJ2GKQM7M84

Product Modifications

We willingly accept customers' modifications to standard products. See product modification information by series at the start of each series under the "Product Modification" sections. If there is a modification you desire that is not listed in this section, please call Customer Service for a modification quote/price

Acceptance, Modification, Assignment

By placing this order for furniture, material or other products (sometimes collectively referred to as "goods"), customer agrees to these terms and conditions which shall prevail over inconsistent provisions in any other form or document of customer. No change or modification shall be applicable unless set forth in writing and signed by company. Neither this order nor any interest therein shall be assigned by customer except with the prior written consent of company.

Payment

Customer agrees to pay to company the amount indicated on the invoice, 1% 15 days, net 30 days from date of invoice (U.S. funds only), for goods ordered. Interest will be charged after 30 days from the date of invoice at the rate of one and a half percent (1.5%) per month. International sales will require additional payment arrangements. No goods shall be sold on consignment or conditional sales basis. Payment for the goods delivered hereunder shall constitute acceptance thereof.

Attorneys' Fees

Customer shall be responsible for all expenses and cost in connection with the enforcement by company of these terms and conditions and the cost of collection (including the fees of any collection agencies to whom the customer's account may be referred), plus reasonable attorneys' fees (which attorneys' fees shall not be less than 25% of the amount due, unless a lower amount is specified by applicable law).

Remedies

The remedies herein reserved shall be cumulative, and additional to any other or further remedies provided in law or equity. No waiver of a breach of any provision of these terms and conditions shall constitute waiver of any other breach or of such provision.

Insolvency

Company may forthwith cancel this order in the event of the happening of any of the following or any other comparable event: insolvency of the customer, the filing of a voluntary petition in bankruptcy, the filing of any involuntary petition to have customer declared bankrupt provided it is not vacated within thirty (30) days from the date of filing, the appointment of a receiver or trustee for customer provided such appointment is not vacated within thirty (30) days from the date of such appointment, or the execution by customer of an assignment for the benefit of creditors.

GSA Terms and Conditions

Limitation of Liability

The Company shall not under any circumstances be liable to the customer, owner of the goods or any third party for special, indirect, incidental, or consequential damages, including, without limitation, loss of profits or revenues, loss or damage to other property or equipment, cost of capital or of purchased or replacement goods, or expense, delay, or inconvenience cause by or arising from the purchase, sale, use, repair or inability to use the goods or by any performance or non-performance under, or breach of, these terms and conditions. The Company's sole liability for any defective goods shall be its repair or its replacement pursuant to the express warranties set forth above, or if amended, as applicable at the time of manufacture or repair of the goods. Some states do not allow the exclusion or limitation of incidental or consequential damages, so the above limitations or exclusion may not apply to all customers. Any action resulting from any breach on the part of company as to the goods or services delivered here under must be commenced within one year after the cause of action has occurred.

Returns and Allowances

Reasonable touch-up and deluxing is the dealer's responsibility. The Company will not make allowances for trip or delivery charges, but will only make allowance for actual work performed to correct manufacturing defects. Allowances maybe authorized only by a company officer. It is the responsibility of the field sales representative to inspect any defective merchandise and make suggestions and recommendations as to the proper disposition. Field personnel cannot obligate or bind the company by definite agreement, without final authorization by a company officer. Company will not accept automatic charge backs which do not have prior authorization. All defects must be called to the company's attention upon arrival at the customer's "ship to" destination. To initiate any type of claim or request for parts, it is imperative to have the model number or fabric number, which may be located on the tag attached to the frame of the unit. Authorization for return to the company via a return goods authorization. Company will not issue credit allowances for any repairs without company's prior consent. Under no circumstances shall the company accept COD (cash on delivery) returns, and any such shipment will be refused.

Security Agreement

The Company may require and customer shall grant a security interest in goods sold pursuant to any credit the company may extend to the customer.

Governing Law

All disputes between the parties, whether or not arising out of these terms and conditions, will be governed by the laws of the state of Indiana. Customer agrees to submit to the jurisdiction of and agrees all lawsuits relating to any disputes between the customer and the company will be brought only in a state court located in Dubois County, Indiana or the United States District Court for the Southern District of Indiana. The customer hereby waives the right to a trial by jury in any action, proceeding, claim, or counterclaim whether in contract or tort, at law or in equity, arising out of or relating in any way to these terms and conditions and all other disputes between the parties.

Mitigation

If the company repossesses the goods prior to payment by the customer of all amounts due hereunder, the company may sell the goods, as is, where is, free and clear of all rights of the customer at either public or private sales, and apply the net proceeds (after deducting expenses of repossession and sale) to the obligation of customer hereunder. The customer may dispose of the goods in any commercially reasonable place and manner and the customer waives any notice of time, place and manner of sale.

Integration

This order for goods, including these terms and conditions, along with any credit application, invoice, statement, dealer contract, acknowledgment, bill of lading (and any exhibits, addenda or amendments thereto) of which this order may be a part, constitutes the sole and complete agreement between the company and the customer with respect to the purchase of the goods.

Dimensions/Specifications/Finishes

All dimensions are approximate and may vary due to the upholstery technique of each craftsman. If exact dimensions are required, it is necessary for the customer to state such specifications with the order. Detailed specifications sheets are available for each series of goods, and customer should consult the company's customer service department for these specification sheets. Company reserves the right to make changes in dimensions, style, or specifications if company believes these changes will improve the goods' quality or appearance. Company reserves the right to substitute hardwoods due to availability at production. Due to the natural characteristics of wood, environmental effects, and material upgrades, the company cannot guarantee exact finish matches on existing goods previously ordered from company. If an exact match to customer's existing goods is required, it must be specified so that the proper procedures can be followed to ensure an acceptable finish. Company will accept no liability for the finish if this procedure isn't followed. Company reserves the right to make changes in a finish formula if company believes the change will improve the quality or appearance of company's goods.

Company's Performance of Its Obligation

The production and delivery of the goods to the extent delayed or hindered or prevented from the performance by reason of natural disasters, acts of god, strikes, lockouts, labor troubles, inability to procure materials, casualties, failure of power, restrictive governmental laws or regulations, riots, insurrections, acts of terrorism, war or other reason of a like nature not the fault of the company shall excuse for the period of the delay the company's performance and the period for the performance shall be extended for a period equivalent to the period of such delay.

Kindera - Overview

Recliner

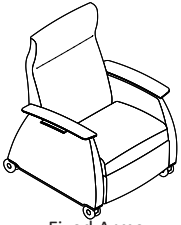

Fixed Arms
[See pg 8](#)

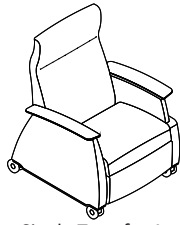

Single Transfer Arms
[See pg 10](#)

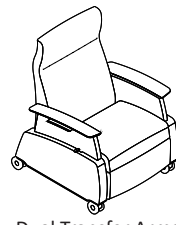

Dual Transfer Arms
[See pg 12](#)

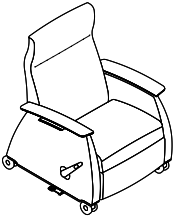

Trendelenburg
Fixed Arms
[See pg 9](#)

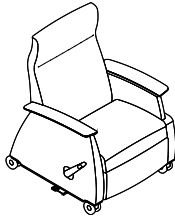

Trendelenburg
Single Transfer Arms
[See pg 11](#)

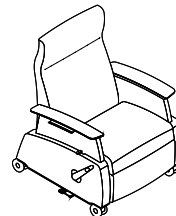

Trendelenburg
Dual Transfer Arms
[See pg 13](#)

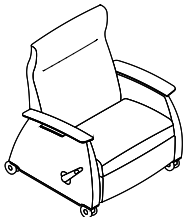

Bariatric
Fixed Arms
[See pg 14](#)

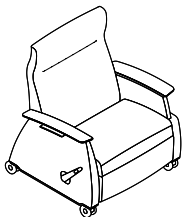

Bariatric
Single Transfer Arms
[See pg 15](#)

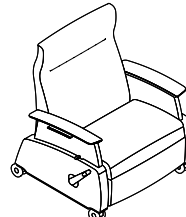

Bariatric
Dual Transfer Arms
[See pg 16](#)

Replacement Parts - [begin on pg 17](#)

Kindera Order Check List:



Specify:

- 1. Model Number
- 2. Upholstery Selection
 - A. Single Upholstery Models: Vendor, Pattern and Color
 - B. Multiple Upholstery Models (_M): Vendor, Pattern and Color each per zone
- 3. Moisture Barrier - Seat Only - upcharge applies, Seat and Back - upcharge applies
- 4. Arm Cap - Polyurethane, 3D Laminate or Solid Surface - upcharge applies to 3D Laminate & Solid Surface
- 5. Footrest Handle Location - Left, Right or Left & Right - upcharge applies to Left & Right
- 6. Footrest Handles - Yes or No - upcharge applies
- 7. Brake - 2 Locking Caster Brakes or Central Brake - upcharge applies to Central Brake
- 8. Transfer Arm - Left or Right (as seated)
- 9. Heated Seat & Back - Yes or No - upcharge applies
- 10. Foley Hook - Yes or No - upcharge applies
- 11. Power in Arm - Left or Right (as seated) - upcharge applies

Example:

43SPDTAT (model #)	Momentum (fabric vendor)	Evo CV (pattern name)	Mist (pattern color)	MB1 (moisture barrier)	SAC (solid surface arm cap)	LH (footrest handle location)	NPH (push handles)	CNB (brake)	NFH (foley hook)
-----------------------	-----------------------------	--------------------------	-------------------------	---------------------------	--------------------------------	----------------------------------	-----------------------	----------------	---------------------

1. Model Number

2. Upholstery Selection - Please supply the following:
Fabric vendor/ Pattern name/ Pattern color

[For a complete list of JSI Standard and Graded-In Textiles click here](#)

- Indicate direction of fabric - Railroaded or Up the Roll
- Please provide illustration, if available

All COM orders must include the following:

- Vendor's name, pattern name and color
- Sample of the fabric attached to the order
- Model numbers of items for fabric application
- Special application instructions
- Customer and purchase order number

Ship prepaid COM material to:
JSI
Attn: COM Department
201 East Martin Street
Receiving B, Dock 71
Orleans, IN 47452

Application of fabric:
Up the Roll Railroaded

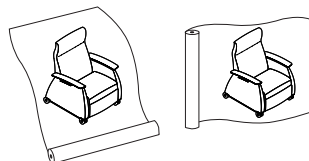

Upholstery Application

Kindera offers the ability to be specified with multiply upholsteries to create a unique look.

Both upholstery styles are presented in the price list and eTools.

Models not ending in a _M will be upholstered in the single upholstery for the complete unit.

Models ending with a _M designate multiple upholstery zones will be specified (ex: 43SPFA_M) To calculate pricing, add base price + zone 1 upcharge + zone 2 upcharge + zone 3 upcharge.

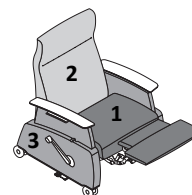

Zone 1 = Seat & Mid-Ottoman
Zone 2 = Back
Zone 3 = Arms

When specifying multiple upholstery, make sure to identify specific yardage per zone. This can be found at the top of each product page.

All COM orders will ship at standard lead time from receipt of COM except for orders requiring special custom matched finishes.

- 3. Moisture Barrier** - offers further protection from fluids
- NMB No Moisture Barrier
 - MB1 Moisture Barrier Seat Only - upcharge applies
 - MB2 Moisturer Barrier Seat & Back - upcharge applies

4. Arm Caps

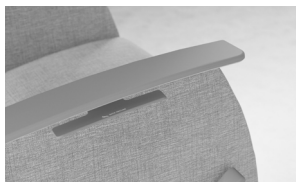

polyurethane

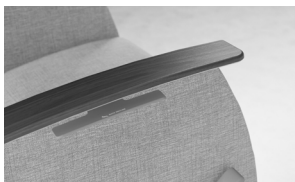

3D laminate



solid surface

Arm Caps are available in three different materials:

Polyurethane (PAC) - standard

SGU Stone Grey

3D Laminate (3LAC) - upcharge applies

BEL Belair
 FLO Florence Walnut
 PIL Pilsner
 PIN Pinnacle Walnut

Solid Surface (SAC) - upcharge applies

DWH Designer White

5. Footrest Handle

Footrest handle is standard on all models with placement on the right as seated by default.

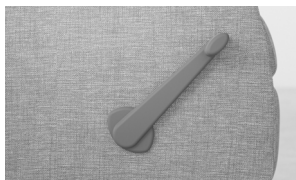

RH Footrest handle on right
 LH Footrest handle on left
 LRH Footrest handle on both left and right - upcharge applies

6. Push Handles

To aide in repositioning of chair optional push handles can be specified as a set of two on the recliner or ordered individually as a replacement part. Note: Recliner is not intended for patient transport.



NPH No push handles
 YPH Yes push handles

7. Brake/Casters



casters

Kindera provides (4) 4" non-marking swivel casters at both the front and back. Standard Caster/Brake option is for (2) front individual locking and (2) back non-locking.

All models offer central lock as an upgrade. Central Brake option offers dual-sided levers. When Central Brake is selected, the front casters are replaced with swivel casters at arm height for caregivers to easily lock or unlock casters. By design only front two casters lock.

2CB 2 Locking Caster Brake
 CNB Central Caster Lock Lever - upcharge applies



central brake

8. Transfer Arm

Kindera features the patented pending Trans4arm™ system in both the dual transfer and single transfer arm models. Dual transfer recliners allow either arm to retract into the recliner frame, creating a seamless way to transfer patients without increasing the footprint. Single transfer models provide one fixed arm and one transfer arm, enable the specification of left or right for transfer.



Recliner with Dual Transfer Arms



Bariatric Recliner with Dual Transfer Arms

Models using the Trans4arm™ system smoothly retract their arm into the frame, creating a smooth surface for safe patient transfers.

9. Heated Seat & Back

Patient care can be enhanced with optional Heated Seat & Back. In fixed arm units the control panel is always on the right arm. In single transfer models the control panel is always on the non transfer arm. This option is not offered on dual transfer models. Cord extends out the bottom of chair, if heated seat and power are selected on same chair a combined power cord is used. Heat is regulated not to exceed 102°.



NHSB No Heated Seat & Back
 YHSB Yes Heated Seat & Back - upcharge applies

10. Foley Hook

Foley hook can be added to models with a single ottoman handle. The hook is always black and applied to the arm without the handle.



NFH No Foley Hook
 YFH Foley Hook - upcharge applies

shown in the down position

11. Power in Arm

A USB A+C black power port with integrated spill shield is available for patient convenience. In fixed arm units, the control panel is always on the right arm. In single transfer models the control panel is always on the non transfer arm. This option is not offered on dual transfer arm models. Cord extends out the bottom of chair, if heated seat and power are selected on same chair a combined power cord is used.



Fixed Arm Models

NPU No Power
 PUL Power in Left Arm (as seated) - upcharge applies
 PUR Power in Right Arm (as seated) - upcharge applies

Single Transfer Arm Models

NPU No Power
 YPU Power in Fixed Arm - upcharge applies

Features

1. Trans4rm™ System

Allows arm to retract into the recliner's frame, creating a seamless way to transfer patients without increasing the recliner's footprint. Available as single or dual.



2. Dual Back Recline Levers

Accessible, elongated levers below the arm caps easily activate the back's infinite recline.

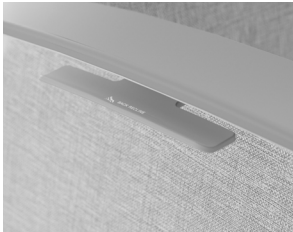

3. Trendelenburg (Dual-Sided)

Foot pedal at the base quickly repositions the reclined chair to elevate the patient's feet above their head.



Reclined Positions



bariatric
infinite recline 60°

footprint for full back/footrest
extended is 64.8"



patient
infinite recline - 25°

footprint for full back/footrest
extended to lay flat is 74.5"



trendelenburg
available in standard size only

activated by the foot pedal along the
base

Clean Out

Ensures simple and thorough cleaning around the seat.



Recline Motion/Weight Capacity/ Cleanable Specs

- Each Kindera model has infinite recline from sitting position to 25° for patient model and 60° for bariatric models.
- Kindera is thoughtfully designed to accommodate the regimens of clinical environments with durable arm caps, bumper guard, recline lever, footrest handle and push handles that wipe down quickly and clean outs to ensure ease of cleaning.
- Built for demanding healthcare facilities, Kindera exceeds rigorous testing.
ANSI/BIFMA X5.41 (400 lb)-2021 - Large Occupant Public and Lounge Seating Tests¹
ANSI/BIFMA X5.41 (600 lb)-2021 - Large Occupant Public and Lounge Seating Tests²

Weight Capacities are as follows:

- 400 lb. Patient Recliner
- 600 lb. Bariatric Recliner
- 80 lb. Breakaway ottoman

Description + General Information

Recliner with Fixed Arms

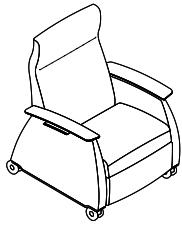

- clean out feature allows for easier cleaning between the back and the seat
- infinite recline up to 25° lay flat position
- nylon bumper guard
- replacement parts available, starting on [pg 17](#)
- additional specs, [see pg 3-7](#)

Dimensions	D	W	H	Shipping	
Overall	35	33 ½	46 ¼	Ctn Wt	155
Seat	21	24	19	Cu Ft	36
Arm			27		

	Single Upholstery	Seat & Mid Ottoman Zone 1	Back Zone 2	Arms Zone 3
COM Ydg	7	1 ¾	3	3
COL Sq Ft	140	35	60	60

Single Upholstery Specify: Model | Upholstery | Moisture Barrier | Arm Cap | Footrest Handle Location | Push Handles | Brake | Heated Seat & Back | Foley Hook | Power In Arm

43SPFA														
	COM	COL	A	B	C	D	E	F	G	H	I	J	L1	L2
Single Uph	\$5,382	\$5,781	\$5,444	\$5,566	\$5,781	\$6,058	\$6,334	\$6,764	\$7,225	\$7,716	\$8,484	\$9,405	\$7,562	\$8,177

Multiple Upholstery Specify: Model | Seat & Mid-Ottoman Uph | Back Uph | Arms Uph | Moisture Barrier | Arm Cap | Footrest Handle Location | Push Handles | Brake | Heated Seat & Back | Foley Hook | Power In Arm

43SPFA_M															
Base Price: \$5,382	To the Base Price, add the appropriate upcharges by grade, per zone														
	COM	COL	A	B	C	D	E	F	G	H	I	J	L1	L2	
Seat & Mid-Ottoman - Zone 1	+\$0	+\$100	+\$16	+\$46	+\$100	+\$169	+\$238	+\$346	+\$461	+\$584	+\$776	+\$1,006	+\$545	+\$699	
Back - Zone 2	+\$0	+\$171	+\$27	+\$79	+\$171	+\$290	+\$408	+\$593	+\$790	+\$1,001	+\$1,330	+\$1,725	+\$935	+\$1,198	
Arms - Zone 3	+\$0	+\$171	+\$27	+\$79	+\$171	+\$290	+\$408	+\$593	+\$790	+\$1,001	+\$1,330	+\$1,725	+\$935	+\$1,198	

Model	Upholstery	Moisture Barrier	Arm Cap	Footrest Handle Location	Push Handles	Brake	Heated Seat & Back	Foley Hook	Power in Arm
	Grade	NMB No Moisture Barrier	PAC Polyurethane Arm Cap Set	LH Left	NPH No	2CB 2 Locking Caster Brakes	NHSB No	NFH No Foley Hook	NPU No Power
	Vendor	MB1 Moisture Barrier Seat - add \$169	3LAC 3D Laminate Arm Cap Set - add \$322	RH Right	YPH Yes - add \$116	CNB Central Brake - add \$778	YHSB Yes - add \$1,035	YFH Foley Hook - add \$45	PUL Power in Left Arm - add \$144
	Pattern	MB2 Moisture Barrier Seat & Back - add \$414	BEL Belair	LRH Left & Right - add \$183					PUR Power in Right Arm - add \$144 (as seated)
	Colorway		FLO Florence Walnut						
			PIN Pinnacle Walnut						
			PIL Pilsner						
			SAC Solid Surface Arm Set - add \$802						

Description + General Information

Trendelenburg Recliner with Fixed Arms

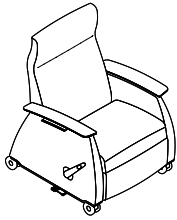

- clean out feature allows for easier cleaning between the back and the seat
- infinite recline up to 25° lay flat position
- nylon bumper guard
- trendelenburg foot pedal at the base quickly repositions the reclined chair to elevate the patient's feet above their head
- replacement parts available, starting on [pg 17](#)
- additional specs, [see pg 3-7](#)

Dimensions	D	W	H	Shipping	
Overall	35	34 ½	46 ¼	Ctn Wt	160
Seat	21	24	19	Cu Ft	37
Arm			27		

	Single Upholstery	Seat & Mid Ottoman Zone 1	Back Zone 2	Arms Zone 3
COM Ydg	7	1 ¾	3	3
COL Sq Ft	140	35	60	60

Single Upholstery Specify: Model | Upholstery | Moisture Barrier | Arm Cap | Footrest Handle Location | Push Handles | Brake | Heated Seat & Back | Foley Hook | Power In Arm

43SPFAT														
	COM	COL	A	B	C	D	E	F	G	H	I	J	L1	L2
Single Uph	\$5,559	\$5,959	\$5,621	\$5,744	\$5,959	\$6,235	\$6,512	\$6,941	\$7,402	\$7,893	\$8,661	\$9,582	\$7,740	\$8,354

Multiple Upholstery Specify: Model | Seat & Mid-Ottoman Uph | Back Uph | Arms Uph | Moisture Barrier | Arm Cap | Footrest Handle Location | Push Handles | Brake | Heated Seat & Back | Foley Hook | Power In Arm

43SPFAT_M															
Base Price: \$5,559		To the Base Price, add the appropriate upcharges by grade, per zone													
	COM	COL	A	B	C	D	E	F	G	H	I	J	L1	L2	
Seat & Mid-Ottoman - Zone 1	+\$0	+\$100	+\$16	+\$47	+\$100	+\$169	+\$239	+\$346	+\$461	+\$584	+\$776	+\$1,006	+\$546	+\$699	
Back - Zone 2	+\$0	+\$172	+\$27	+\$80	+\$172	+\$290	+\$409	+\$593	+\$790	+\$1,001	+\$1,330	+\$1,725	+\$935	+\$1,198	
Arms - Zone 3	+\$0	+\$172	+\$27	+\$80	+\$172	+\$290	+\$409	+\$593	+\$790	+\$1,001	+\$1,330	+\$1,725	+\$935	+\$1,198	

Model	Upholstery	Moisture Barrier	Arm Cap	Footrest Handle Location	Push Handles	Brake	Heated Seat & Back	Foley Hook	Power in Arm
	Grade	NMB No Moisture Barrier	PAC Polyurethane Arm Cap Set	LH Left	NPH No	2CB 2 Locking Caster Brakes	NHSB No	NFH No Foley Hook	NPU No Power
	Vendor	MB1 Moisture Barrier Seat - add \$169	3LAC 3D Laminate Arm Cap Set - add \$322	RH Right	YPH Yes - add \$116	CNB Central Brake - add \$778	YHSB Yes - add \$1,035	YFH Foley Hook - add \$45	PUL Power in Left Arm - add \$144
	Pattern	MB2 Moisture Barrier Seat & Back - add \$414	BEL Belair	LRH Left & Right - add \$183					PUR Power in Right Arm - add \$144 (as seated)
	Colorway		FLO Florence Walnut						
			PIN Pinnacle Walnut						
			PIL Pilsner						
			SAC Solid Surface Arm Set - add \$802						

Description + General Information

Recliner with Single Transfer Arm

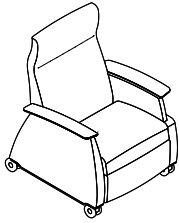

- clean out feature allows for easier cleaning between the back and the seat
- infinite recline up to 25° lay flat position
- nylon bumper guard
- replacement parts available, starting on [pg 17](#)
- additional specs, [see pg 3-7](#)

Dimensions	D	W	H	Shipping	
Overall	35	33 ½	46 ¼	Ctn Wt	165
Seat	21	24	19	Cu Ft	36
Arm			27		

	Single Upholstery	Seat & Mid Ottoman Zone 1	Back Zone 2	Arms Zone 3
COM Ydg	7 ½	1 ¾	3	3 ½
COL Sq Ft	150	35	60	70

Single Upholstery Specify: Model | Upholstery | Moisture Barrier | Arm Cap | Footrest Handle Location | Push Handles | Brake | Single Transfer Arm | Heated Seat & Back | Foley Hook | Power In Arm

43SPSTA														
	COM	COL	A	B	C	D	E	F	G	H	I	J	L1	L2
Single Uph	\$6,307	\$6,736	\$6,374	\$6,505	\$6,736	\$7,032	\$7,328	\$7,788	\$8,282	\$8,808	\$9,631	\$10,618	\$8,644	\$9,302

Multiple Upholstery Specify: Model | Seat & Mid-Ottoman Uph | Back Uph | Arms Uph | Moisture Barrier | Arm Cap | Footrest Handle Location | Push Handles | Brake | Single Transfer Arm | Heated Seat & Back | Foley Hook | Power In Arm

43SPSTA_M														
Base Price: \$6,307		To the Base Price, add the appropriate upcharges by grade, per zone												
	COM	COL	A	B	C	D	E	F	G	H	I	J	L1	L2
Seat & Mid-Ottoman - Zone 1	+\$0	+\$101	+\$16	+\$47	+\$101	+\$170	+\$239	+\$346	+\$461	+\$584	+\$776	+\$1,006	+\$546	+\$699
Back - Zone 2	+\$0	+\$172	+\$27	+\$80	+\$172	+\$290	+\$409	+\$593	+\$790	+\$1,001	+\$1,330	+\$1,725	+\$935	+\$1,198
Arms - Zone 3	+\$0	+\$201	+\$32	+\$93	+\$201	+\$339	+\$477	+\$692	+\$922	+\$1,168	+\$1,552	+\$2,012	+\$1,091	+\$1,398

Note: Foley hook available on the non-handle side standard follow special order process if required to place otherwise.

Model	Upholstery	Moisture Barrier	Arm Cap	Footrest Handle Location	Push Handles	Brake	Single Transfer Arm	Heated Seat & Back	Foley Hook	Power in Arm
	Grade	NMB No Moisture Barrier	PAC Polyurethane Arm Cap Set	LH Left	NPH No	2CB 2 Locking Caster Brakes	LTA Left Arm	NHSB No	NFH No Foley Hook	NPU No Power
	Vendor	MB1 Moisture Barrier Seat - add \$169	3LAC 3D Laminate Arm Cap Set - add \$322	RH Right	YPH Yes - add \$116	CNB Central Brake - add \$778	RTA Right Arm (as seated)	YHSB Yes - add \$1,035	YFH Foley Hook - add \$45	PUL Power in Left Arm - add \$144
	Pattern	MB2 Moisture Barrier Seat & Back - add \$414	BEL Belair	LRH Left & Right - add \$183						PUR Power in Right Arm - add \$144 (as seated)
	Colorway		FLO Florence Walnut							
			PIN Pinnacle Walnut							
			PIL Pitliner							
			SAC Solid Surface Arm Set - add \$802							

Description + General Information

Trendelenburg Recliner with Single Transfer Arm

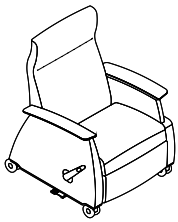

- clean out feature allows for easier cleaning between the back and the seat
- infinite recline up to 25° lay flat position
- nylon bumper guard
- trendelenburg foot pedal at the base quickly repositions the reclined chair to elevate the patient's feet above their head
- replacement parts available, starting on [pg 17](#)
- additional specs, [see pg 3-7](#)

Dimensions	D	W	H	Shipping	
Overall	35	34 ½	46 ¼	Ctn Wt	170
Seat	21	24	19	Cu Ft	37
Arm			27		

	Single Upholstery	Seat & Mid Ottoman Zone 1	Back Zone 2	Arms Zone 3
COM Ydg	7 ½	1 ¾	3	3 ½
COL Sq Ft	150	35	60	70

Single Upholstery Specify: Model | Upholstery | Moisture Barrier | Arm Cap | Footrest Handle Location | Push Handles | Brake | Single Transfer Arm | Heated Seat & Back | Foley Hook | Power In Arm

43SPSTAT														
	COM	COL	A	B	C	D	E	F	G	H	I	J	L1	L2
Single Uph	\$6,480	\$6,908	\$6,547	\$6,678	\$6,908	\$7,205	\$7,501	\$7,961	\$8,455	\$8,981	\$9,804	\$10,791	\$8,817	\$9,475

Multiple Upholstery Specify: Model | Seat & Mid Ottoman Uph | Back Uph | Arms Uph | Moisture Barrier | Arm Cap | Footrest Handle Location | Push Handles | Brake | Single Transfer Arm | Heated Seat & Back | Foley Hook | Power In Arm

43SPSTAT_M														
Base Price: \$6,480		To the Base Price, add the appropriate upcharges by grade, per zone												
	COM	COL	A	B	C	D	E	F	G	H	I	J	L1	L2
Seat & Mid-Ottoman - Zone 1	+\$0	+\$100	+\$16	+\$47	+\$100	+\$170	+\$239	+\$346	+\$461	+\$584	+\$776	+\$1,006	+\$546	+\$699
Back - Zone 2	+\$0	+\$172	+\$27	+\$80	+\$172	+\$290	+\$409	+\$593	+\$790	+\$1,001	+\$1,330	+\$1,725	+\$935	+\$1,198
Arms - Zone 3	+\$0	+\$200	+\$32	+\$93	+\$200	+\$339	+\$477	+\$692	+\$922	+\$1,168	+\$1,552	+\$2,012	+\$1,091	+\$1,398

Note: Foley hook available on the non-handle side standard follow special order process if required to place otherwise.

Model	Upholstery	Moisture Barrier	Arm Cap	Footrest Handle Location	Push Handles	Brake	Single Transfer Arm	Heated Seat & Back	Foley Hook	Power in Arm
	Grade	NMB No Moisture Barrier	PAC Polyurethane Arm Cap Set	LH Left	NPH No	2CB 2 Locking Caster Brakes	LTA Left Arm	NHSB No	NFH No Foley Hook	NPU No Power
	Vendor	MB1 Moisture Barrier Seat - add \$169	3LAC 3D Laminate Arm Cap Set - add \$322	RH Right	YPH Yes - add \$116	CNB Central Brake - add \$778	RTA Right Arm (as seated)	YHSB Yes - add \$1,035	YFH Foley Hook - add \$45	PUL Power in Left Arm - add \$144
	Pattern	MB2 Moisture Barrier Seat & Back - add \$414	BEL Belair	LRH Left & Right - add \$183						PUR Power in Right Arm - add \$144 (as seated)
	Colorway		FLO Florence Walnut							
			PIN Pinnacle Walnut							
			PIL Pitliner							
			SAC Solid Surface Arm Set - add \$802							

Description + General Information

Recliner with Dual Transfer Arms

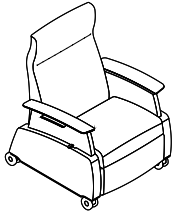

- clean out feature allows for easier cleaning between the back and the seat
- infinite recline up to 25° lay flat position
- nylon bumper guard
- replacement parts available, starting on [pg 17](#)
- additional specs, [see pg 3-7](#)

Dimensions	D	W	H	Shipping	
Overall	35	33 ½	46 ¼	Ctn Wt	175
Seat	21	24	19	Cu Ft	36
Arm			27		

	Single Upholstery	Seat & Mid Ottoman Zone 1	Back Zone 2	Arms Zone 3
COM Ydg	7 ¾	1 ¾	3	3 ¾
COL Sq Ft	150	35	60	70

Single Upholstery Specify: Model | Upholstery | Moisture Barrier | Arm Cap | Footrest Handle Location | Push Handles | Brake | Foley Hook

43SPDTA														
	COM	COL	A	B	C	D	E	F	G	H	I	J	L1	L2
Single Uph	\$7,294	\$7,737	\$7,363	\$7,499	\$7,737	\$8,043	\$8,349	\$8,825	\$9,335	\$9,879	\$10,728	\$11,748	\$9,709	\$10,388

Multiple Upholstery Specify: Model | Seat & Mid Ottoman Uph | Back Uph | Arms Uph | Moisture Barrier | Arm Cap | Footrest Handle Location | Push Handles | Brake | Foley Hook

43SPDTA_M														
Base Price: \$7,294		To the Base Price, add the appropriate upcharges by grade, per zone												
	COM	COL	A	B	C	D	E	F	G	H	I	J	L1	L2
Seat & Mid-Ottoman - Zone 1	+\$0	+\$101	+\$16	+\$47	+\$101	+\$170	+\$239	+\$346	+\$461	+\$584	+\$776	+\$1,006	+\$546	+\$699
Back - Zone 2	+\$0	+\$172	+\$27	+\$80	+\$172	+\$290	+\$409	+\$593	+\$791	+\$1,001	+\$1,330	+\$1,725	+\$935	+\$1,198
Arms - Zone 3	+\$0	+\$215	+\$34	+\$100	+\$215	+\$363	+\$511	+\$741	+\$988	+\$1,251	+\$1,662	+\$2,156	+\$1,169	+\$1,498

Model	Upholstery	Moisture Barrier	Arm Cap	Footrest Handle Location	Push Handles	Brake	Foley Hook
	Grade Vendor Pattern Colorway	NMB No Moisture Barrier MB1 Moisture Barrier Seat - add \$169 MB2 Moisture Barrier Seat & Back - add \$414	PAC Polyurethane Arm Cap Set 3LAC 3D Laminate Arm Cap Set - add \$322 BEL Belair FLO Florence Walnut PIN Pinnacle Walnut PIL Pilsner SAC Solid Surface Arm Set - add \$802	LH Left RH Right LRH Left & Right - add \$183	NPH No YPH Yes - add \$116	2CB 2 Locking Caster Brakes CNB Central Brake - add \$778	NFH No Foley Hook YFH Foley Hook - add \$45

Description + General Information

Trendelenburg Recliner with Dual Transfer Arms

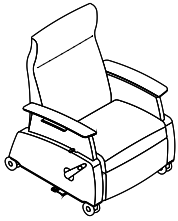

- clean out feature allows for easier cleaning between the back and the seat
- infinite recline up to 25° lay flat position
- nylon bumper guard
- trendelenburg foot pedal at the base quickly repositions the reclined chair to elevate the patient's feet above their head
- replacement parts available, starting on [pg 17](#)
- additional specs, [see pg 3-7](#)

Dimensions	D	W	H	Shipping	
Overall	35	34 ½	46 ¼	Ctn Wt	180
Seat	21	24	19	Cu Ft	37
Arm			27		

	Single Upholstery	Seat & Mid Ottoman Zone 1	Back Zone 2	Arms Zone 3
COM Ydg	7 ¾	1 ¾	3	3 ¾
COL Sq Ft	150	35	60	70

Single Upholstery Specify: Model | Upholstery | Moisture Barrier | Arm Cap | Footrest Handle Location | Push Handles | Brake | Foley Hook

43SPDTAT														
	COM	COL	A	B	C	D	E	F	G	H	I	J	L1	L2
Single Uph	\$7,467	\$7,910	\$7,536	\$7,672	\$7,910	\$8,216	\$8,522	\$8,998	\$9,508	\$10,051	\$10,901	\$11,921	\$9,881	\$10,561

Multiple Upholstery Specify: Model | Seat & Mid Ottoman Uph | Back Uph | Arms Uph | Moisture Barrier | Arm Cap | Footrest Handle Location | Push Handles | Brake | Foley Hook

43SPDTAT_M														
Base Price: \$7,467		To the Base Price, add the appropriate upcharges by grade, per zone												
	COM	COL	A	B	C	D	E	F	G	H	I	J	L1	L2
Seat & Mid-Ottoman - Zone 1	+\$0	+\$101	+\$16	+\$47	+\$101	+\$170	+\$239	+\$346	+\$461	+\$584	+\$776	+\$1,006	+\$546	+\$699
Back - Zone 2	+\$0	+\$172	+\$27	+\$80	+\$172	+\$290	+\$409	+\$593	+\$791	+\$1,001	+\$1,330	+\$1,725	+\$935	+\$1,198
Arms - Zone 3	+\$0	+\$215	+\$34	+\$100	+\$215	+\$363	+\$511	+\$741	+\$988	+\$1,251	+\$1,662	+\$2,156	+\$1,169	+\$1,498

Model	Upholstery	Moisture Barrier	Arm Cap	Footrest Handle Location	Push Handles	Brake	Foley Hook
	Grade Vendor Pattern Colorway	NMB No Moisture Barrier MB1 Moisture Barrier Seat - add \$169 MB2 Moisture Barrier Seat & Back - add \$414	PAC Polyurethane Arm Cap Set 3LAC 3D Laminate Arm Cap Set - add \$322 BEL Belair FLO Florence Walnut PIN Pinnacle Walnut PIL Pilsner SAC Solid Surface Arm Set - add \$802	LH Left RH Right LRH Left & Right - add \$183	NPH No YPH Yes - add \$116	2CB 2 Locking Caster Brakes CNB Central Brake - add \$778	NFH No Foley Hook YFH Foley Hook - add \$45

Description + General Information

Bariatric Recliner with Fixed Arms

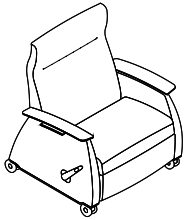

- clean out feature allows for easier cleaning between the back and the seat
- infinite recline up to 60°
- nylon bumper guard
- replacement parts available, starting on [pg 17](#)
- additional specs, [see pg 3-7](#)

Dimensions	D	W	H	Shipping	
Overall	35	38 ½	46 ¼	Ctn Wt	185
Seat	21	29	19	Cu Ft	41
Arm			27		

	Single Upholstery	Seat & Mid Ottoman Zone 1	Back Zone 2	Arms Zone 3
COM Ydg	8	2	3	3
COL Sq Ft	160	40	60	60

Single Upholstery Specify: Model | Upholstery | Moisture Barrier | Arm Cap | Footrest Handle Location | Push Handles | Brake | Heated Seat & Back | Foley Hook | Power In Arm

43SBFA														
	COM	COL	A	B	C	D	E	F	G	H	I	J	L1	L2
Single Uph	\$5,911	\$6,368	\$5,982	\$6,122	\$6,368	\$6,684	\$7,000	\$7,491	\$8,017	\$8,579	\$9,456	\$10,509	\$8,403	\$9,105

Multiple Upholstery Specify: Model | Seat & Mid Ottoman Uph | Back Uph | Arms Uph | Moisture Barrier | Arm Cap | Footrest Handle Location | Push Handles | Brake | Heated Seat & Back | Foley Hook | Power In Arm

43SBFA_M															
Base Price: \$5,911		To the Base Price, add the appropriate upcharges by grade, per zone													
	COM	COL	A	B	C	D	E	F	G	H	I	J	L1	L2	
Seat & Mid-Ottoman - Zone 1	+\$0	+\$115	+\$18	+\$53	+\$115	+\$194	+\$273	+\$395	+\$527	+\$667	+\$887	+\$1,150	+\$623	+\$799	
Back - Zone 2	+\$0	+\$172	+\$27	+\$80	+\$172	+\$290	+\$409	+\$593	+\$790	+\$1,001	+\$1,330	+\$1,725	+\$935	+\$1,198	
Arms - Zone 3	+\$0	+\$172	+\$27	+\$80	+\$172	+\$290	+\$409	+\$593	+\$790	+\$1,001	+\$1,330	+\$1,725	+\$935	+\$1,198	

Model	Upholstery	Moisture Barrier	Arm Cap	Footrest Handle Location	Push Handles	Brake	Heated Seat & Back	Foley Hook	Power in Arm
	Grade	NMB No Moisture Barrier	PAC Polyurethane Arm Cap Set	LH Left	NPH No	2CB 2 Locking Caster Brakes	NHSB No	NFH No Foley Hook	NPU No Power
	Vendor	MB1 Moisture Barrier Seat - add \$220	3LAC 3D Laminate Arm Cap Set - add \$322	RH Right	YPH Yes - add \$116	CNB Central Brake - add \$778	YHSB Yes - add \$1,035	YFH Foley Hook - add \$45	PUL Power in Left Arm - add \$144
	Pattern	MB2 Moisture Barrier Seat & Back - add \$512	BEL Belair	LRH Left & Right - add \$183					PUR Power in Right Arm - add \$144 (as seated)
	Colorway		FLO Florence Walnut PIN Pinnacle Walnut PIL Pilsner SAC Solid Surface Arm Set - add \$802						

Description + General Information

Bariatric Recliner with Single Transfer Arm

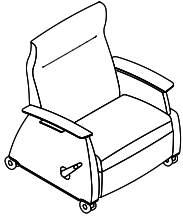

- clean out feature allows for easier cleaning between the back and the seat
- infinite recline up to 60°
- nylon bumper guard
- replacement parts available, starting on [pg 17](#)
- additional specs, [see pg 3-7](#)

Dimensions	D	W	H	Shipping	
Overall	35	38 ½	46 ¼	Ctn Wt	195
Seat	21	29	19	Cu Ft	41
Arm			27		

	Single Upholstery	Seat & Mid Ottoman Zone 1	Back Zone 2	Arms Zone 3
COM Ydg	8 ¼	2	3	3 ½
COL Sq Ft	165	40	60	70

Single Upholstery Specify: Model | Upholstery | Moisture Barrier | Arm Cap | Footrest Handle Location | Push Handles | Brake | Single Transfer Arm | Heated Seat & Back | Foley Hook | Power In Arm

43SBSTA														
	COM	COL	A	B	C	D	E	F	G	H	I	J	L1	L2
Single Uph	\$6,948	\$7,419	\$7,021	\$7,166	\$7,419	\$7,745	\$8,071	\$8,577	\$9,120	\$9,699	\$10,604	\$11,690	\$9,518	\$10,242

Multiple Upholstery Specify: Model | Seat & Mid Ottoman Uph | Back Uph | Arms Uph | Moisture Barrier | Arm Cap | Footrest Handle Location | Push Handles | Brake | Single Transfer Arm | Heated Seat & Back | Foley Hook | Power In Arm

43SBSTA_M														
Base Price: \$6,948		To the Base Price, add the appropriate upcharges by grade, per zone												
	COM	COL	A	B	C	D	E	F	G	H	I	J	L1	L2
Seat & Mid-Ottoman - Zone 1	+\$0	+\$115	+\$18	+\$53	+\$115	+\$194	+\$273	+\$395	+\$527	+\$667	+\$887	+\$1,150	+\$624	+\$799
Back - Zone 2	+\$0	+\$172	+\$27	+\$80	+\$172	+\$290	+\$409	+\$593	+\$790	+\$1,001	+\$1,330	+\$1,725	+\$935	+\$1,198
Arms - Zone 3	+\$0	+\$200	+\$31	+\$93	+\$200	+\$339	+\$477	+\$692	+\$922	+\$1,168	+\$1,552	+\$2,012	+\$1,091	+\$1,398

Model	Upholstery	Moisture Barrier	Arm Cap	Footrest Handle Location	Push Handles	Brake	Single Transfer Arm	Heated Seat & Back	Foley Hook	Power in Arm
	Grade Vendor Pattern Colorway	NMB No Moisture Barrier MB1 Moisture Barrier Seat - add \$220	PAC Polyurethane Arm Cap Set 3LAC 3D Laminate Arm Cap Set - add \$322 BEL Belair FLO Florence Walnut PIN Pinnacle Walnut PIL Pitliner SAC Solid Surface Arm Set - add \$802	LH Left RH Right LRH Left & Right - add \$183	NPH No YPH Yes - add \$116	2CB 2 Locking Caster Brakes CNB Central Brake - add \$778	LTA Left Arm RTA Right Arm (as seated)	NHSB No YHSB Yes - add \$1,035	NFH No Foley Hook YFH Foley Hook - add \$45	NPU No Power PUL Power in Left Arm - add \$144 PUR Power in Right Arm - add \$144 (as seated)

Description + General Information

Bariatric Recliner with Dual Transfer Arms

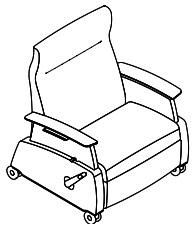

- clean out feature allows for easier cleaning between the back and the seat
- infinite recline up to 60°
- nylon bumper guard
- replacement parts available, starting on [pg 17](#)
- additional specs, [see pg 3-7](#)

Dimensions	D	W	H	Shipping	
Overall	35	38 ½	46 ¼	Ctn Wt	205
Seat	21	29	19	Cu Ft	41
Arm			27		

	Single Upholstery	Seat & Mid Ottoman Zone 1	Back Zone 2	Arms Zone 3
COM Ydg	8 ½	2	3	3 ¾
COL Sq Ft	170	40	60	75

Single Upholstery Specify: Model | Upholstery | Moisture Barrier | Arm Cap | Footrest Handle Location | Push Handles | Brake | Foley Hook

43SBDTA														
	COM	COL	A	B	C	D	E	F	G	H	I	J	L1	L2
Single Uph	\$7,959	\$8,444	\$8,034	\$8,183	\$8,444	\$8,780	\$9,115	\$9,637	\$10,196	\$10,793	\$11,725	\$12,844	\$10,607	\$11,352

Multiple Upholstery Specify: Model | Seat & Mid Ottoman Uph | Back Uph | Arms Uph | Moisture Barrier | Arm Cap | Footrest Handle Location | Push Handles | Brake | Foley Hook

43SBDTA_M															
Base Price: \$7,959		To the Base Price, add the appropriate upcharges by grade, per zone													
	COM	COL	A	B	C	D	E	F	G	H	I	J	L1	L2	
Seat & Mid-Ottoman - Zone 1	+\$0	+\$115	+\$18	+\$53	+\$115	+\$194	+\$272	+\$395	+\$527	+\$667	+\$887	+\$1,150	+\$624	+\$799	
Back - Zone 2	+\$0	+\$172	+\$27	+\$80	+\$172	+\$290	+\$408	+\$593	+\$790	+\$1,001	+\$1,330	+\$1,725	+\$935	+\$1,198	
Arms - Zone 3	+\$0	+\$214	+\$34	+\$99	+\$214	+\$363	+\$510	+\$741	+\$987	+\$1,251	+\$1,662	+\$2,156	+\$1,169	+\$1,497	

Model	Upholstery	Moisture Barrier	Arm Cap	Footrest Handle Location	Push Handles	Brake	Foley Hook
	Grade Vendor Pattern Colorway	NMB No Moisture Barrier MB1 Moisture Barrier Seat - add \$220 MB2 Moisture Barrier Seat & Back - add \$512	PAC Polyurethane Arm Cap Set 3LAC 3D Laminate Arm Cap Set - add \$322 BEL Belair FLO Florence Walnut PIN Pinnacle Walnut PIL Pilsner SAC Solid Surface Arm Set - add \$802	LH Left RH Right LRH Left & Right - add \$183	NPH No YPH Yes - add \$116	2CB 2 Locking Caster Brakes CNB Central Brake - add \$778	NFH No Foley Hook YFH Foley Hook - add \$45

Kindera - Replacement Parts

Easy Replacement Parts

- Designed for healthcare's challenges, Kindera recliner ensures easy replacement parts if damaged
- Replacable high-use parts extend the product's lifespan
- This includes: seat, ottoman, arm caps, individual locking casters and push handles, which are detailed in the following pages



Replacement Parts

Description + General Information

Replacement Seat - Recliner

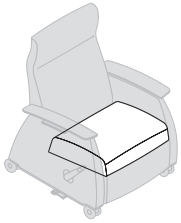

Dimensions	D	W	H
Overall	22	24	7 ½ ₂₂
Upholstery	Shipping		
COM Ydg	1	Ctn Wt	12
COL Sq Ft	20	Cu Ft	3

Single Upholstery Specify: Model | Upholstery | Moisture Barrier

43SRSP														
	COM	COL	A	B	C	D	E	F	G	H	I	J	L1	L2
Single Uph	\$610	\$667	\$619	\$636	\$667	\$707	\$746	\$808	\$873	\$944	\$1,053	\$1,185	\$922	\$1,009

Replacement Footrest - Recliner

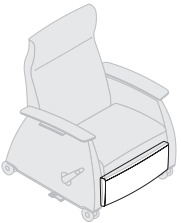

Dimensions	D	W	H
Overall	10	24	2 ½ ₂₂
Upholstery	Shipping		
COM Ydg	¼	Ctn Wt	3
COL Sq Ft	15	Cu Ft	1

Single Upholstery Specify: Model | Upholstery

43SRFRP														
	COM	COL	A	B	C	D	E	F	G	H	I	J	L1	L2
Single Uph	\$333	\$376	\$340	\$353	\$376	\$406	\$435	\$481	\$531	\$583	\$666	\$764	\$567	\$633

Model	Upholstery	Moisture Barrier
	Grade Vendor Pattern Colorway	NMB No Moisture Barrier MB1 Moisture Barrier Seat - add \$220

Replacement Parts

Description + General Information

Replacement Mid-Ottoman and Flap - Recliner

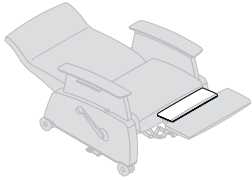

Dimensions	D	W	H
Overall	5	18	1 ½ ₂
Upholstery		Shipping	
COM Ydg	½	Ctn Wt	2
COL Sq Ft	10	Cu Ft	1

Single Upholstery Specify: Model | Upholstery

43SRMOP														
	COM	COL	A	B	C	D	E	F	G	H	I	J	L1	L2
Single Uph	\$194	\$222	\$198	\$207	\$222	\$242	\$262	\$292	\$325	\$360	\$415	\$481	\$349	\$393

Replacement Seat - Bariatric Recliner

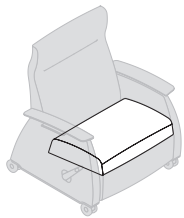

Dimensions	D	W	H
Overall	22	29	7 ½ ₂
Upholstery		Shipping	
COM Ydg	1 ¼	Ctn Wt	16
COL Sq Ft	25	Cu Ft	4

Single Upholstery Specify: Model | Upholstery | Moisture Barrier

43SRSB														
	COM	COL	A	B	C	D	E	F	G	H	I	J	L1	L2
Single Uph	\$724	\$795	\$735	\$757	\$795	\$844	\$894	\$970	\$1,053	\$1,140	\$1,277	\$1,442	\$1,113	\$1,223

Model	Upholstery
	Grade Vendor Pattern Colorway

Replacement Parts

Description + General Information

Replacement Footrest - Bariatric Recliner

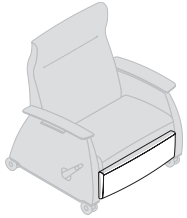

Dimensions	D	W	H
Overall	10	29	2 ½
Upholstery	Shipping		
COM Ydg	1	Ctn Wt	5
COL Sq Ft	20	Cu Ft	1

Single Upholstery Specify: Model | Upholstery

43SRFRB														
	COM	COL	A	B	C	D	E	F	G	H	I	J	L1	L2
Single Uph	\$389	\$446	\$398	\$416	\$446	\$486	\$525	\$587	\$653	\$723	\$832	\$964	\$701	\$789

Replacement Mid-Ottoman and Flap - Bariatric Recliner

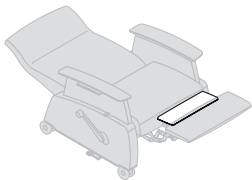

Dimensions	D	W	H
Overall	5	23	1 ½
Upholstery	Shipping		
COM Ydg	¾	Ctn Wt	3
COL Sq Ft	15	Cu Ft	1

Single Upholstery Specify: Model | Upholstery

43SRMOB														
	COM	COL	A	B	C	D	E	F	G	H	I	J	L1	L2
Single Uph	\$224	\$267	\$231	\$244	\$267	\$296	\$326	\$372	\$421	\$474	\$556	\$655	\$458	\$523

Model	Upholstery
	Grade Vendor Pattern Colorway

Replacement Parts

Description	D	W	H	CTN WT	CU FT	① Model	List Price
Replacement Polyurethane Arm Cap - Recliner	25 ¾	4 ¾	1 ½	5	1	43SRPUAC	\$208

- stone grey polyurethane

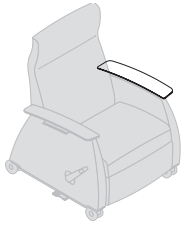

Replacement 3D Laminate Arm Cap - Recliner	25 ¾	4 ¾	1 ½	2	1	43SR3LAC	\$384
--	------	-----	-----	---	---	----------	-------

Specify: Model | 3D Laminate Finish

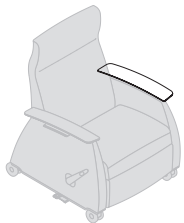

Replacement Solid Surface Arm Cap - Recliner	25 ¾	4 ¾	1 ½	2	1	43SRSSAC	\$622
--	------	-----	-----	---	---	----------	-------

- designer white solid surface

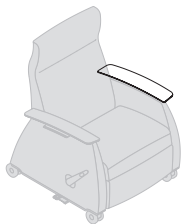

Model	3D Laminate
BEL	Belair
FLO	Florence Walnut
PIN	Pinnacle Walnut
PIL	Pilsner

Replacement Parts

Description	D	W	H	CTN WT	CU FT	① Model	List Price
Replacement Non-Locking Caster	4	3	5 ¼	1	1	43SRCASTER	\$131

- quantity of 1
- 4" swivel non-marking, non-locking caster

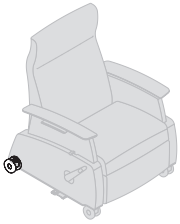

Replacement Individual Locking Caster	5	3	5 ¼	1	1	43SRCASTERLK	\$141
--	---	---	-----	---	---	---------------------	-------

- quantity of 1
- 4" swivel non-marking, locking caster

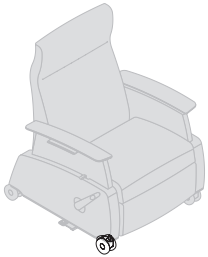

Replacement Push Handle	2 ½	1	7	1	1	43SRBKHNDL	\$140
--------------------------------	-----	---	---	---	---	-------------------	-------

- quantity of 1
- stone grey polyurethane

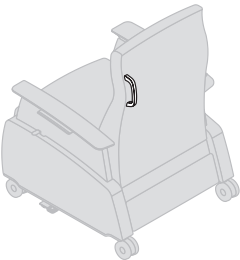

Replacement Foley Hook	¾	¾	2	1	1	43SRHOOK	\$94
-------------------------------	---	---	---	---	---	-----------------	------

- quantity of 1
- black polyurethane

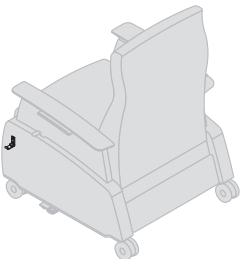

Model	3D Laminate
BEL	Belair
FLO	Florence Walnut
PIN	Pinnacle Walnut
PIL	Pilsner

Somna - Overview

Sleep Sofa

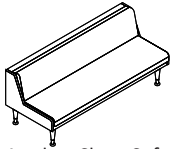

Armless Sleep Sofa
68" - 80" every inch on the inch
[See pages 6-18](#)

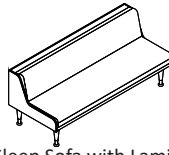

Armless Sleep Sofa with Laminate Wrap
68" - 80" every inch on the inch
[See pages 19-31](#)

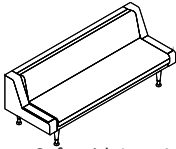

Sleep Sofa with Low Arm
68" - 80" every inch on the inch
[See pages 32-44](#)

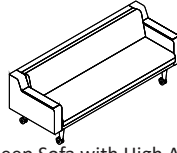

Sleep Sofa with High Arm
68" - 80" every inch on the inch
[See pages 32-45](#)

Accessories



Under mount Power
[See pages 58](#)

Replacement Parts - [begin on pg 59](#)

Somna Order Check List:



Specify:

- 1. Model Number
- 2. Upholstery Selection
 - A. Single Upholstery Models: Vendor, Pattern and Color
 - B. Multiple Upholstery Models (_M): Vendor, Pattern and Color each per zone
- 3. Moisture Barrier - Seat - upcharge applies
- 4. Arm Cap - Polyurethane, 3D Laminate or Solid Surface - upcharge applies
- 5. Laminate Selection
- 6. Metal Frame Finish - Arctic Silver (ASL), Pewter (PEW) or Soft Nickel (SNK)
- 7. Foot/Glide - upcharge applies
 - A. 4 Glides, 2 Casters/2 Glides, 4 Casters
 - B. Glide Type - Easy Slide Disc or Stainless Steel
- 8. Power in Arm/ Power Color - Specify location and color - upcharges apply

Example:

23SU69WLA (model #)	Momentum (fabric vendor)	Canter (pattern name)	Sand (pattern color)	MB1 (moisture barrier)	PAC (arm cap)	ASL (metal finish)	GL (glide/foot)	ESD (glide)	PUL (power location)	P2 (power type)	G (power color)
------------------------	-----------------------------	--------------------------	-------------------------	---------------------------	------------------	-----------------------	--------------------	----------------	-------------------------	--------------------	--------------------

1. Model Number

2. Upholstery Selection - Please supply the following:
Fabric vendor/ Pattern name/ Pattern color

[For a complete list of JSI Standard and Graded-In Textiles click here](#)

- Indicate direction of fabric - Railroaded or Up the Roll
- Please provide illustration, if available

All COM orders must include the following:

- Vendor's name, pattern name and color
- Sample of the fabric attached to the order
- Model numbers of items for fabric application
- Special application instructions
- Customer and purchase order number

Ship prepaid COM material to:
JSI
Attn: COM Department
201 East Martin Street
Receiving B, Dock 71
Orleans, IN 47452

Application of fabric:
Up the Roll Railroaded

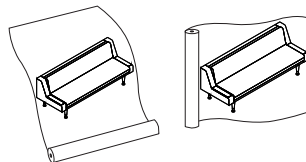

Upholstery Application

Somna offers the ability to be specified with multiply upholsteries to create a unique look.

Both upholstery styles are presented in the price list and eTools.

Models not ending in a _M will be upholstered in the single upholstery for the complete unit.

Models ending with a _M designate multiple upholstery zones will be specified (ex: 23SU68WLA_M) To calculate pricing, add base price + zone 1 upcharge + zone 2 upcharge + zone 3 upcharge.

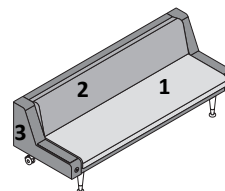

Zone 1 = Seat
Zone 2 = Back
Zone 3 = Frame

When specifying multiple upholstery, make sure to identify specific yardage per zone. This can be found at the top of each product page.

All COM orders will ship at standard lead time from receipt of COM except for orders requiring special custom matched finishes.

- 3. Moisture Barrier** - offers further protection from fluids
 - NMB No Moisture Barrier
 - MB1 Moisurer Barrier Seat only - \$251 list upcharge

4. Arm Cap

Arm Caps are available, on both the Low Arm and High Arm Models, in three different materials:



Polyurethane (PAC) - standard
SGU Stone Grey



Solid Surface (SAC) - upcharge applies
DWH Designer White



3D Laminate (3LAC) - upcharge applies
BEL Belair
FLO Florence Walnut
PIL Pilsner
PIN Pinnacle Walnut



Arm Cap on
Low Arm



Arm Cap on
High Arm

5. Laminate Wrap

ALB Alabaster	MES Mesa
BEL Belair	MIN Mineral
BLK Black	MCH Mocha
BRK Brickdust	OBK Outback
BBL Bridal Blanco	PIL Pilsner
CSK Cask	PIN Pinnacle Walnut
CLY Clay	SHD Shadow
DWH Designer White	SLG Slate Grey
EGR Egret	UMB Umber
FAW Fawn	VAL Valley
FLN Flint	WLH Walnut Heights
FLO Florence Walnut	WEA Weathered Ash
LOF Loft	ZEN Zen Grey

6. Metal Frame Finish

ASL Arctic Silver
PEW Pewter
SNK Soft Nickel

7. Foot/ Glide

Somna recognizes the need for fixed placement as well as full mobility, offering three combinations of glides and casters to suit each need.

Casters are 2 1/2" non-marring swivel casters and are always non-locking in the back. For models specified with all four casters, the front will be individually locking.

Clearance distance from the underneath side of Somna to the floor is 11" for all glide and caster selections. Feet ship unassembled from the sleep sofa - require assembly.

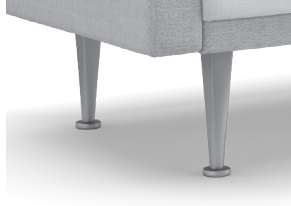

GL
Four Glides



2C2G
Front Glides/ Rear Casters
upcharges apply



4C
Four Casters
upcharges apply



ESD
Easy Slide Disc - White Plastic
upcharges apply on 2C2G
combination



SS
Stainless Steel
upcharges apply

8. Power in Arm

In addition to offering a stand alone, undermount power, Somna also provides recharging capabilities right in the arm.



P1: 110 Plug



P2: USB A&C

Specify location of power

- PUL Power in left arm
- PUR Power in right arm
- PULR Power in both arm and right arm

Specify type of power

- P1 110 Plug
- P2 USB A&C
- P3 110 Plug on left / USB A&C on right
- P4 USB A&C on left / 110 Plug on right

Specify type of power

- P1 110 Plug
- P2 USB A&C

Sleep Surface/Weight Capacity/Cleanable Specs

- Each Somna model incorporates a sleep surface via a mechanism free easy to fold down back, creating a sleep surface separate from the sitting surface.
- The inside back and sleep surface cushion are covered in a durable, moisture resistant, bleach cleanable, grey material.
- Somna is thoughtfully designed to accommodate the regimens of clinical environments with durable arm caps that wipe down quickly and cleanouts to ensure ease of cleaning.
- Built for demanding healthcare facilities, Somna exceeds rigorous testing and each sleep sofa is rated at 275 lbs per seating location. There are three seating locations per model.

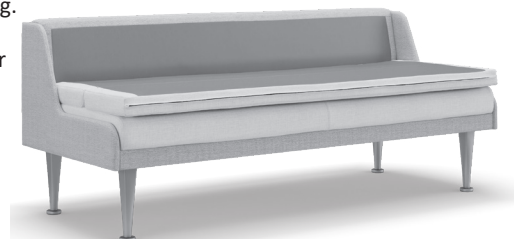

Description + General Information

68 Armless Sleep Sofa

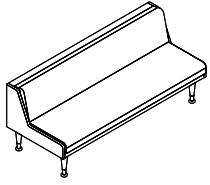

- clean out feature allows for easier cleaning between the back and the seat
- mechanism free fold down back easily converts sofa to sleep position
- under mount, tamper proof power available - order EC49 separately
- replacement parts available, starting on [pg 60](#)
- additional specs, [see pg 5](#)

Dimensions	D	W	H	Shipping	
Overall	32	70 ½	32 ½	Ctn Wt	162
Seat	20	68	19 ¼	Cu Ft	58

	Single Upholstery	Seat Zone 1	Back Zone 2	Frame Zone 3
COM Ydg	7 ½	2 ½	2 ¾	4
COL Sq Ft	135	45	50	72

Single Upholstery Specify: Model | Upholstery | Moisture Barrier | Metal Frame Finish | Foot/Glide

23SU68XA														
	COM	COL	A	B	C	D	E	F	G	H	I	J	L1	L2
Single Uph	\$5,507	\$5,935	\$5,573	\$5,705	\$5,935	\$6,231	\$6,527	\$6,988	\$7,481	\$8,008	\$8,830	\$9,817	\$8,370	\$9,159

Multiple Upholstery Specify: Model | Seat Upholstery | Back Upholstery | Frame Upholstery | Moisture Barrier | Metal Frame Finish | Foot/Glide

23SU68XA_M														
Base Price:	To the Base Price, add the appropriate upcharges by grade, per zone													
	COM	COL	A	B	C	D	E	F	G	H	I	J	L1	L2
Seat - Zone 1	+\$0	+\$140	+\$22	+\$65	+\$140	+\$236	+\$332	+\$482	+\$643	+\$814	+\$1,082	+\$1,403	+\$932	+\$1,189
Back - Zone 2	+\$0	+\$147	+\$23	+\$68	+\$147	+\$248	+\$349	+\$506	+\$674	+\$854	+\$1,135	+\$1,472	+\$978	+\$1,247
Frame - Zone 3	+\$0	+\$218	+\$34	+\$101	+\$218	+\$368	+\$519	+\$753	+\$1,003	+\$1,271	+\$1,689	+\$2,190	+\$1,455	+\$1,856

Model	Upholstery	Moisture Barrier	Metal Frame Finish	Foot/Glide
	Grade Vendor Pattern Colorway	NMB No Moisture Barrier Seat MB1 Moisture Barrier Seat - add \$251	ASL Arctic Silver PEW Pewter SNK Soft Nickel	GL 4 Glides ESD Easy Slide Disc - White Plastic SS Stainless Steel - add \$138 2C2G 2 Casters/2 Glides ESD Easy Slide Disc - White Plastic - add \$30 SS Stainless Steel - add \$100 4C 4 Casters - add \$67

Description + General Information

69 Armless Sleep Sofa

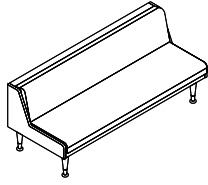

- clean out feature allows for easier cleaning between the back and the seat
- mechanism free fold down back easily converts sofa to sleep position
- under mount, tamper proof power available - order EC49 separately
- replacement parts available, starting on [pg 60](#)
- additional specs, [see pg 5](#)

Dimensions	D	W	H	Shipping	
Overall	32	71 ½	32 ½	Ctn Wt	164
Seat	20	68	19 ¼	Cu Ft	59

	Single Upholstery	Seat Zone 1	Back Zone 2	Frame Zone 3
COM Ydg	7 ½	2 ½	2 ¾	4
COL Sq Ft	135	45	50	72

Single Upholstery Specify: Model | Upholstery | Moisture Barrier | Metal Frame Finish | Foot/Glide

23SU69XA														
	COM	COL	A	B	C	D	E	F	G	H	I	J	L1	L2
Single Uph	\$5,519	\$5,947	\$5,585	\$5,716	\$5,947	\$6,243	\$6,539	\$6,999	\$7,493	\$8,019	\$8,842	\$9,829	\$8,381	\$9,171

Multiple Upholstery Specify: Model | Seat Upholstery | Back Upholstery | Frame Upholstery | Moisture Barrier | Metal Frame Finish | Foot/Glide

23SU69XA_M														
Base Price: \$5,519	To the Base Price, add the appropriate upcharges by grade, per zone													
	COM	COL	A	B	C	D	E	F	G	H	I	J	L1	L2
Seat - Zone 1	+\$0	+\$140	+\$22	+\$65	+\$140	+\$236	+\$332	+\$482	+\$643	+\$814	+\$1,082	+\$1,403	+\$932	+\$1,189
Back - Zone 2	+\$0	+\$147	+\$23	+\$68	+\$147	+\$248	+\$349	+\$506	+\$674	+\$854	+\$1,135	+\$1,472	+\$977	+\$1,247
Frame - Zone 3	+\$0	+\$218	+\$34	+\$101	+\$218	+\$368	+\$519	+\$752	+\$1,003	+\$1,270	+\$1,689	+\$2,190	+\$1,454	+\$1,856

Model	Upholstery	Moisture Barrier	Metal Frame Finish	Foot/Glide
	Grade Vendor Pattern Colorway	NMB No Moisture Barrier Seat MB1 Moisture Barrier Seat - add \$251	ASL Arctic Silver PEW Pewter SNK Soft Nickel	GL 4 Glides ESD Easy Slide Disc - White Plastic SS Stainless Steel - add \$138 2C2G 2 Casters/2 Glides ESD Easy Slide Disc - White Plastic - add \$30 SS Stainless Steel - add \$100 4C 4 Casters - add \$67

Description + General Information

70 Armless Sleep Sofa

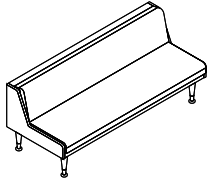

- clean out feature allows for easier cleaning between the back and the seat
- mechanism free fold down back easily converts sofa to sleep position
- under mount, tamper proof power available - order EC49 separately
- replacement parts available, starting on [pg 60](#)
- additional specs, [see pg 5](#)

Dimensions	D	W	H	Shipping	
Overall	32	72 ½	32 ½	Ctn Wt	166
Seat	20	70	19 ¼	Cu Ft	60

	Single Upholstery	Seat Zone 1	Back Zone 2	Frame Zone 3
COM Ydg	7 ½	2 ½	2 ¾	4
COL Sq Ft	135	45	50	72

Single Upholstery Specify: Model | Upholstery | Moisture Barrier | Metal Frame Finish | Foot/Glide

23SU70XA														
	COM	COL	A	B	C	D	E	F	G	H	I	J	L1	L2
Single Uph	\$5,530	\$5,958	\$5,596	\$5,728	\$5,958	\$6,254	\$6,550	\$7,011	\$7,505	\$8,031	\$8,853	\$9,840	\$8,393	\$9,182

Multiple Upholstery Specify: Model | Seat Upholstery | Back Upholstery | Frame Upholstery | Moisture Barrier | Metal Frame Finish | Foot/Glide

23SU70XA_M														
Base Price:	To the Base Price, add the appropriate upcharges by grade, per zone													
	COM	COL	A	B	C	D	E	F	G	H	I	J	L1	L2
Seat - Zone 1	+\$0	+\$140	+\$22	+\$65	+\$140	+\$236	+\$332	+\$482	+\$643	+\$814	+\$1,082	+\$1,403	+\$932	+\$1,189
Back - Zone 2	+\$0	+\$147	+\$23	+\$68	+\$147	+\$248	+\$349	+\$506	+\$675	+\$854	+\$1,135	+\$1,472	+\$978	+\$1,247
Frame - Zone 3	+\$0	+\$218	+\$34	+\$101	+\$218	+\$368	+\$519	+\$753	+\$1,004	+\$1,271	+\$1,689	+\$2,190	+\$1,455	+\$1,856

Model	Upholstery	Moisture Barrier	Metal Frame Finish	Foot/Glide
	Grade Vendor Pattern Colorway	NMB No Moisture Barrier Seat MB1 Moisture Barrier Seat - add \$251	ASL Arctic Silver PEW Pewter SNK Soft Nickel	GL 4 Glides ESD Easy Slide Disc - White Plastic SS Stainless Steel - add \$138 2C2G 2 Casters/2 Glides ESD Easy Slide Disc - White Plastic - add \$30 SS Stainless Steel - add \$100 4C 4 Casters - add \$67

Description + General Information

71 Armless Sleep Sofa

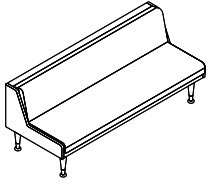

- clean out feature allows for easier cleaning between the back and the seat
- mechanism free fold down back easily converts sofa to sleep position
- under mount, tamper proof power available - order EC49 separately
- replacement parts available, starting on [pg 60](#)
- additional specs, [see pg 5](#)

Dimensions	D	W	H	Shipping	
Overall	32	73 ½	32 ½	Ctn Wt	168
Seat	20	71	19 ¼	Cu Ft	61

	Single Upholstery	Seat Zone 1	Back Zone 2	Frame Zone 3
COM Ydg	7 ½	2 ½	2 ¾	4
COL Sq Ft	135	45	50	72

Single Upholstery Specify: Model | Upholstery | Moisture Barrier | Metal Frame Finish | Foot/Glide

23SU71XA														
	COM	COL	A	B	C	D	E	F	G	H	I	J	L1	L2
Single Uph	\$5,542	\$5,970	\$5,608	\$5,739	\$5,970	\$6,266	\$6,562	\$7,023	\$7,516	\$8,042	\$8,865	\$9,852	\$8,404	\$9,194

Multiple Upholstery Specify: Model | Seat Upholstery | Back Upholstery | Frame Upholstery | Moisture Barrier | Metal Frame Finish | Foot/Glide

23SU71XA_M														
Base Price: \$5,542	To the Base Price, add the appropriate upcharges by grade, per zone													
	COM	COL	A	B	C	D	E	F	G	H	I	J	L1	L2
Seat - Zone 1	+\$0	+\$140	+\$22	+\$65	+\$140	+\$236	+\$332	+\$482	+\$643	+\$814	+\$1,082	+\$1,403	+\$932	+\$1,189
Back - Zone 2	+\$0	+\$147	+\$23	+\$68	+\$147	+\$248	+\$349	+\$506	+\$674	+\$854	+\$1,135	+\$1,472	+\$977	+\$1,247
Frame - Zone 3	+\$0	+\$218	+\$34	+\$101	+\$218	+\$368	+\$519	+\$753	+\$1,003	+\$1,270	+\$1,689	+\$2,190	+\$1,454	+\$1,856

Model	Upholstery	Moisture Barrier	Metal Frame Finish	Foot/Glide
	Grade Vendor Pattern Colorway	NMB No Moisture Barrier Seat MB1 Moisture Barrier Seat - add \$251	ASL Arctic Silver PEW Pewter SNK Soft Nickel	GL 4 Glides ESD Easy Slide Disc - White Plastic SS Stainless Steel - add \$138 2C2G 2 Casters/2 Glides ESD Easy Slide Disc - White Plastic - add \$30 SS Stainless Steel - add \$100 4C 4 Casters - add \$67

Description + General Information

72 Armless Sleep Sofa

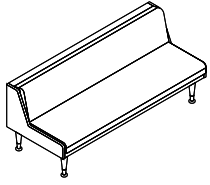

- clean out feature allows for easier cleaning between the back and the seat
- mechanism free fold down back easily converts sofa to sleep position
- under mount, tamper proof power available - order EC49 separately
- replacement parts available, starting on [pg 60](#)
- additional specs, [see pg 5](#)

Dimensions	D	W	H	Shipping	
Overall	32	74 ½	32 ½	Ctn Wt	170
Seat	20	72	19 ¼	Cu Ft	62

	Single Upholstery	Seat Zone 1	Back Zone 2	Frame Zone 3
COM Ydg	7 ½	2 ½	2 ¾	4
COL Sq Ft	135	45	50	72

Single Upholstery Specify: Model | Upholstery | Moisture Barrier | Metal Frame Finish | Foot/Glide

23SU72XA														
	COM	COL	A	B	C	D	E	F	G	H	I	J	L1	L2
Single Uph	\$5,553	\$5,981	\$5,620	\$5,751	\$5,981	\$6,278	\$6,574	\$7,034	\$7,528	\$8,054	\$8,877	\$9,864	\$8,416	\$9,206

Multiple Upholstery Specify: Model | Seat Upholstery | Back Upholstery | Frame Upholstery | Moisture Barrier | Metal Frame Finish | Foot/Glide

23SU72XA_M														
Base Price:	\$5,553 To the Base Price, add the appropriate upcharges by grade, per zone													
	COM	COL	A	B	C	D	E	F	G	H	I	J	L1	L2
Seat - Zone 1	+\$0	+\$140	+\$22	+\$65	+\$140	+\$236	+\$333	+\$482	+\$643	+\$814	+\$1,082	+\$1,403	+\$932	+\$1,189
Back - Zone 2	+\$0	+\$147	+\$23	+\$68	+\$147	+\$248	+\$349	+\$506	+\$675	+\$854	+\$1,135	+\$1,472	+\$978	+\$1,247
Frame - Zone 3	+\$0	+\$218	+\$35	+\$101	+\$218	+\$369	+\$519	+\$753	+\$1,004	+\$1,271	+\$1,689	+\$2,190	+\$1,455	+\$1,856

Model	Upholstery	Moisture Barrier	Metal Frame Finish	Foot/Glide
	Grade Vendor Pattern Colorway	NMB No Moisture Barrier Seat MB1 Moisture Barrier Seat - add \$251	ASL Arctic Silver PEW Pewter SNK Soft Nickel	GL 4 Glides ESD Easy Slide Disc - White Plastic SS Stainless Steel - add \$138 2C2G 2 Casters/2 Glides ESD Easy Slide Disc - White Plastic - add \$30 SS Stainless Steel - add \$100 4C 4 Casters - add \$67

Description + General Information

73 Armless Sleep Sofa

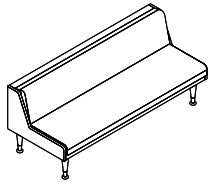

- clean out feature allows for easier cleaning between the back and the seat
- mechanism free fold down back easily converts sofa to sleep position
- under mount, tamper proof power available - order EC49 separately
- replacement parts available, starting on [pg 60](#)
- additional specs, [see pg 5](#)

Dimensions	D	W	H	Shipping	
Overall	32	75 ½	32 ½	Ctn Wt	172
Seat	20	73	19 ¼	Cu Ft	63

	Single Upholstery	Seat Zone 1	Back Zone 2	Frame Zone 3
COM Ydg	7 ½	2 ½	2 ¾	4
COL Sq Ft	135	45	50	72

Single Upholstery Specify: Model | Upholstery | Moisture Barrier | Metal Frame Finish | Foot/Glide

23SU73XA														
	COM	COL	A	B	C	D	E	F	G	H	I	J	L1	L2
Single Uph	\$5,565	\$5,993	\$5,631	\$5,763	\$5,993	\$6,289	\$6,585	\$7,046	\$7,539	\$8,066	\$8,888	\$9,875	\$8,428	\$9,217

Multiple Upholstery Specify: Model | Seat Upholstery | Back Upholstery | Frame Upholstery | Moisture Barrier | Metal Frame Finish | Foot/Glide

23SU73XA_M														
Base Price: \$5,565	To the Base Price, add the appropriate upcharges by grade, per zone													
	COM	COL	A	B	C	D	E	F	G	H	I	J	L1	L2
Seat - Zone 1	+\$0	+\$140	+\$22	+\$65	+\$140	+\$236	+\$332	+\$482	+\$643	+\$814	+\$1,082	+\$1,403	+\$932	+\$1,189
Back - Zone 2	+\$0	+\$147	+\$23	+\$68	+\$147	+\$248	+\$349	+\$506	+\$674	+\$854	+\$1,135	+\$1,472	+\$978	+\$1,247
Frame - Zone 3	+\$0	+\$218	+\$34	+\$101	+\$218	+\$368	+\$519	+\$753	+\$1,003	+\$1,271	+\$1,689	+\$2,190	+\$1,455	+\$1,856

Model	Upholstery	Moisture Barrier	Metal Frame Finish	Foot/Glide
	Grade Vendor Pattern Colorway	NMB No Moisture Barrier Seat MB1 Moisture Barrier Seat - add \$251	ASL Arctic Silver PEW Pewter SNK Soft Nickel	GL 4 Glides ESD Easy Slide Disc - White Plastic SS Stainless Steel - add \$138 2C2G 2 Casters/2 Glides ESD Easy Slide Disc - White Plastic - add \$30 SS Stainless Steel - add \$100 4C 4 Casters - add \$67

Description + General Information

74 Armless Sleep Sofa

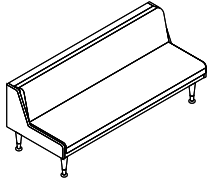

- clean out feature allows for easier cleaning between the back and the seat
- mechanism free fold down back easily converts sofa to sleep position
- under mount, tamper proof power available - order EC49 separately
- replacement parts available, starting on [pg 60](#)
- additional specs, [see pg 5](#)

Dimensions	D	W	H	Shipping	
Overall	32	76 ½	32 ½	Ctn Wt	174
Seat	20	74	19 ¼	Cu Ft	64

	Single Upholstery	Seat Zone 1	Back Zone 2	Frame Zone 3
COM Ydg	7 ½	2 ½	2 ¾	4
COL Sq Ft	135	45	50	72

Single Upholstery Specify: Model | Upholstery | Moisture Barrier | Metal Frame Finish | Foot/Glide

23SU74XA														
	COM	COL	A	B	C	D	E	F	G	H	I	J	L1	L2
Single Uph	\$5,577	\$6,005	\$5,643	\$5,775	\$6,005	\$6,301	\$6,597	\$7,058	\$7,552	\$8,078	\$8,900	\$9,887	\$8,440	\$9,229

Multiple Upholstery Specify: Model | Seat Upholstery | Back Upholstery | Frame Upholstery | Moisture Barrier | Metal Frame Finish | Foot/Glide

23SU74XA_M														
Base Price:	\$5,577 To the Base Price, add the appropriate upcharges by grade, per zone													
	COM	COL	A	B	C	D	E	F	G	H	I	J	L1	L2
Seat - Zone 1	+\$0	+\$140	+\$22	+\$65	+\$140	+\$236	+\$332	+\$482	+\$643	+\$814	+\$1,082	+\$1,403	+\$932	+\$1,189
Back - Zone 2	+\$0	+\$147	+\$23	+\$68	+\$147	+\$248	+\$349	+\$506	+\$675	+\$854	+\$1,135	+\$1,472	+\$978	+\$1,247
Frame - Zone 3	+\$0	+\$218	+\$34	+\$101	+\$218	+\$368	+\$519	+\$753	+\$1,004	+\$1,271	+\$1,689	+\$2,190	+\$1,455	+\$1,856

Model	Upholstery	Moisture Barrier	Metal Frame Finish	Foot/Glide
	Grade Vendor Pattern Colorway	NMB No Moisture Barrier Seat MB1 Moisture Barrier Seat - add \$251	ASL Arctic Silver PEW Pewter SNK Soft Nickel	GL 4 Glides ESD Easy Slide Disc - White Plastic SS Stainless Steel - add \$138 2C2G 2 Casters/2 Glides ESD Easy Slide Disc - White Plastic - add \$30 SS Stainless Steel - add \$100 4C 4 Casters - add \$67

Description + General Information

75 Armless Sleep Sofa

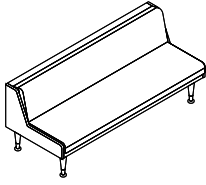

- clean out feature allows for easier cleaning between the back and the seat
- mechanism free fold down back easily converts sofa to sleep position
- under mount, tamper proof power available - order EC49 separately
- replacement parts available, starting on [pg 60](#)
- additional specs, [see pg 5](#)

Dimensions	D	W	H	Shipping	
Overall	32	77 ½	32 ½	Ctn Wt	176
Seat	20	75	19 ¼	Cu Ft	65

	Single Upholstery	Seat Zone 1	Back Zone 2	Frame Zone 3
COM Ydg	7 ½	2 ½	2 ¾	4
COL Sq Ft	135	45	50	72

Single Upholstery Specify: Model | Upholstery | Moisture Barrier | Metal Frame Finish | Foot/Glide

23SU75XA														
	COM	COL	A	B	C	D	E	F	G	H	I	J	L1	L2
Single Uph	\$5,588	\$6,016	\$5,654	\$5,786	\$6,016	\$6,312	\$6,608	\$7,069	\$7,562	\$8,089	\$8,911	\$9,898	\$8,451	\$9,240

Multiple Upholstery Specify: Model | Seat Upholstery | Back Upholstery | Frame Upholstery | Moisture Barrier | Metal Frame Finish | Foot/Glide

23SU75XA_M														
Base Price: \$5,588	To the Base Price, add the appropriate upcharges by grade, per zone													
	COM	COL	A	B	C	D	E	F	G	H	I	J	L1	L2
Seat - Zone 1	+\$0	+\$140	+\$22	+\$65	+\$140	+\$236	+\$332	+\$482	+\$643	+\$814	+\$1,082	+\$1,403	+\$932	+\$1,189
Back - Zone 2	+\$0	+\$147	+\$23	+\$68	+\$147	+\$248	+\$349	+\$506	+\$674	+\$854	+\$1,135	+\$1,472	+\$978	+\$1,247
Frame - Zone 3	+\$0	+\$218	+\$34	+\$101	+\$218	+\$368	+\$519	+\$753	+\$1,003	+\$1,271	+\$1,689	+\$2,190	+\$1,455	+\$1,856

Model	Upholstery	Moisture Barrier	Metal Frame Finish	Foot/Glide
	Grade Vendor Pattern Colorway	NMB No Moisture Barrier Seat MB1 Moisture Barrier Seat - add \$251	ASL Arctic Silver PEW Pewter SNK Soft Nickel	GL 4 Glides ESD Easy Slide Disc - White Plastic SS Stainless Steel - add \$138 2C2G 2 Casters/2 Glides ESD Easy Slide Disc - White Plastic - add \$30 SS Stainless Steel - add \$100 4C 4 Casters - add \$67

Description + General Information

76 Armless Sleep Sofa

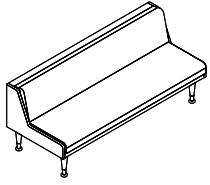

- clean out feature allows for easier cleaning between the back and the seat
- mechanism free fold down back easily converts sofa to sleep position
- under mount, tamper proof power available - order EC49 separately
- replacement parts available, starting on [pg 60](#)
- additional specs, [see pg 5](#)

Dimensions	D	W	H	Shipping	
Overall	32	78 ½	32 ½	Ctn Wt	178
Seat	20	76	19 ¼	Cu Ft	66

	Single Upholstery	Seat Zone 1	Back Zone 2	Frame Zone 3
COM Ydg	7 ½	2 ½	2 ¾	4
COL Sq Ft	135	45	50	72

Single Upholstery Specify: Model | Upholstery | Moisture Barrier | Metal Frame Finish | Foot/Glide

23SU76XA														
	COM	COL	A	B	C	D	E	F	G	H	I	J	L1	L2
Single Uph	\$5,600	\$6,028	\$5,666	\$5,797	\$6,028	\$6,324	\$6,620	\$7,080	\$7,574	\$8,100	\$8,923	\$9,910	\$8,462	\$9,252

Multiple Upholstery Specify: Model | Seat Upholstery | Back Upholstery | Frame Upholstery | Moisture Barrier | Metal Frame Finish | Foot/Glide

23SU76XA_M														
Base Price:	\$5,600 To the Base Price, add the appropriate upcharges by grade, per zone													
	COM	COL	A	B	C	D	E	F	G	H	I	J	L1	L2
Seat - Zone 1	+\$0	+\$140	+\$22	+\$65	+\$140	+\$236	+\$332	+\$482	+\$643	+\$814	+\$1,082	+\$1,403	+\$932	+\$1,189
Back - Zone 2	+\$0	+\$147	+\$23	+\$68	+\$147	+\$248	+\$349	+\$506	+\$674	+\$854	+\$1,135	+\$1,472	+\$977	+\$1,247
Frame - Zone 3	+\$0	+\$218	+\$34	+\$101	+\$218	+\$368	+\$519	+\$752	+\$1,003	+\$1,270	+\$1,689	+\$2,190	+\$1,454	+\$1,856

Model	Upholstery	Moisture Barrier	Metal Frame Finish	Foot/Glide
	Grade Vendor Pattern Colorway	NMB No Moisture Barrier Seat MB1 Moisture Barrier Seat - add \$251	ASL Arctic Silver PEW Pewter SNK Soft Nickel	GL 4 Glides ESD Easy Slide Disc - White Plastic SS Stainless Steel - add \$138 2C2G 2 Casters/2 Glides ESD Easy Slide Disc - White Plastic - add \$30 SS Stainless Steel - add \$100 4C 4 Casters - add \$67

Description + General Information

77 Armless Sleep Sofa

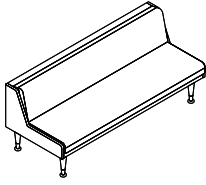

- clean out feature allows for easier cleaning between the back and the seat
- mechanism free fold down back easily converts sofa to sleep position
- under mount, tamper proof power available - order EC49 separately
- replacement parts available, starting on [pg 60](#)
- additional specs, [see pg 5](#)

Dimensions	D	W	H	Shipping	
Overall	32	79 ½	32 ½	Ctn Wt	180
Seat	20	77	19 ¼	Cu Ft	67

	Single Upholstery	Seat Zone 1	Back Zone 2	Frame Zone 3
COM Ydg	7 ½	2 ½	2 ¾	4
COL Sq Ft	135	45	50	72

Single Upholstery Specify: Model | Upholstery | Moisture Barrier | Metal Frame Finish | Foot/Glide

23SU77XA														
	COM	COL	A	B	C	D	E	F	G	H	I	J	L1	L2
Single Uph	\$5,611	\$6,039	\$5,677	\$5,809	\$6,039	\$6,335	\$6,631	\$7,092	\$7,585	\$8,112	\$8,934	\$9,921	\$8,474	\$9,263

Multiple Upholstery Specify: Model | Seat Upholstery | Back Upholstery | Frame Upholstery | Moisture Barrier | Metal Frame Finish | Foot/Glide

23SU77XA_M														
Base Price: \$5,611	To the Base Price, add the appropriate upcharges by grade, per zone													
	COM	COL	A	B	C	D	E	F	G	H	I	J	L1	L2
Seat - Zone 1	+\$0	+\$140	+\$22	+\$65	+\$140	+\$236	+\$332	+\$482	+\$643	+\$814	+\$1,082	+\$1,403	+\$932	+\$1,189
Back - Zone 2	+\$0	+\$147	+\$23	+\$68	+\$147	+\$248	+\$349	+\$506	+\$674	+\$854	+\$1,135	+\$1,472	+\$978	+\$1,247
Frame - Zone 3	+\$0	+\$218	+\$34	+\$101	+\$218	+\$368	+\$519	+\$753	+\$1,003	+\$1,271	+\$1,689	+\$2,190	+\$1,455	+\$1,856

Model	Upholstery	Moisture Barrier	Metal Frame Finish	Foot/Glide
	Grade Vendor Pattern Colorway	NMB No Moisture Barrier Seat MB1 Moisture Barrier Seat - add \$251	ASL Arctic Silver PEW Pewter SNK Soft Nickel	GL 4 Glides ESD Easy Slide Disc - White Plastic SS Stainless Steel - add \$138 2C2G 2 Casters/2 Glides ESD Easy Slide Disc - White Plastic - add \$30 SS Stainless Steel - add \$100 4C 4 Casters - add \$67

Description + General Information

78 Armless Sleep Sofa

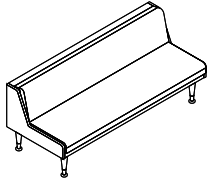

- clean out feature allows for easier cleaning between the back and the seat
- mechanism free fold down back easily converts sofa to sleep position
- under mount, tamper proof power available - order EC49 separately
- replacement parts available, starting on [pg 60](#)
- additional specs, [see pg 5](#)

Dimensions	D	W	H	Shipping	
Overall	32	80 ½	32 ½	Ctn Wt	182
Seat	20	78	19 ¼	Cu Ft	68

	Single Upholstery	Seat Zone 1	Back Zone 2	Frame Zone 2
COM Ydg	7 ½	2 ½	2 ¾	4
COL Sq Ft	135	45	50	72

Single Upholstery Specify: Model | Upholstery | Moisture Barrier | Metal Frame Finish | Foot/Glide

23SU78XA														
	COM	COL	A	B	C	D	E	F	G	H	I	J	L1	L2
Single Uph	\$5,623	\$6,051	\$5,689	\$5,821	\$6,051	\$6,347	\$6,643	\$7,104	\$7,597	\$8,124	\$8,946	\$9,933	\$8,485	\$9,275

Multiple Upholstery Specify: Model | Seat Upholstery | Back Upholstery | Frame Upholstery | Moisture Barrier | Metal Frame Finish | Foot/Glide

23SU78XA_M														
Base Price:	To the Base Price, add the appropriate upcharges by grade, per zone													
	COM	COL	A	B	C	D	E	F	G	H	I	J	L1	L2
Seat - Zone 1	+\$0	+\$140	+\$22	+\$65	+\$140	+\$236	+\$332	+\$482	+\$643	+\$814	+\$1,082	+\$1,403	+\$932	+\$1,189
Back - Zone 2	+\$0	+\$147	+\$23	+\$68	+\$147	+\$248	+\$349	+\$506	+\$674	+\$854	+\$1,135	+\$1,472	+\$977	+\$1,247
Frame - Zone 3	+\$0	+\$218	+\$34	+\$101	+\$218	+\$368	+\$519	+\$753	+\$1,003	+\$1,271	+\$1,689	+\$2,190	+\$1,454	+\$1,856

Model	Upholstery	Moisture Barrier	Metal Frame Finish	Foot/Glide
	Grade Vendor Pattern Colorway	NMB No Moisture Barrier Seat MB1 Moisture Barrier Seat - add \$251	ASL Arctic Silver PEW Pewter SNK Soft Nickel	GL 4 Glides ESD Easy Slide Disc - White Plastic SS Stainless Steel - add \$138 2C2G 2 Casters/2 Glides ESD Easy Slide Disc - White Plastic - add \$30 SS Stainless Steel - add \$100 4C 4 Casters - add \$67

Description + General Information

79 Armless Sleep Sofa

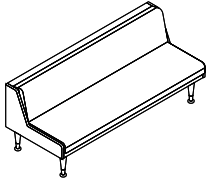

- clean out feature allows for easier cleaning between the back and the seat
- mechanism free fold down back easily converts sofa to sleep position
- under mount, tamper proof power available - order EC49 separately
- replacement parts available, starting on [pg 60](#)
- additional specs, [see pg 5](#)

Dimensions	D	W	H	Shipping	
Overall	32	81 ½	32 ½	Ctn Wt	184
Seat	20	79	19 ¼	Cu Ft	69

	Single Upholstery	Seat Zone 1	Back Zone 2	Frame Zone 3
COM Ydg	7 ½	2 ½	2 ¾	4
COL Sq Ft	135	45	50	72

Single Upholstery Specify: Model | Upholstery | Moisture Barrier | Metal Frame Finish | Foot/Glide

23SU79XA														
	COM	COL	A	B	C	D	E	F	G	H	I	J	L1	L2
Single Uph	\$5,634	\$6,062	\$5,700	\$5,832	\$6,062	\$6,358	\$6,654	\$7,115	\$7,609	\$8,135	\$8,957	\$9,944	\$8,497	\$9,286

Multiple Upholstery Specify: Model | Seat Upholstery | Back Upholstery | Frame Upholstery | Moisture Barrier | Metal Frame Finish | Foot/Glide

23SU79XA_M														
Base Price: \$5,634	To the Base Price, add the appropriate upcharges by grade, per zone													
	COM	COL	A	B	C	D	E	F	G	H	I	J	L1	L2
Seat - Zone 1	+\$0	+\$140	+\$22	+\$65	+\$140	+\$236	+\$332	+\$482	+\$643	+\$814	+\$1,082	+\$1,403	+\$932	+\$1,189
Back - Zone 2	+\$0	+\$147	+\$23	+\$68	+\$147	+\$248	+\$349	+\$506	+\$675	+\$854	+\$1,135	+\$1,472	+\$978	+\$1,247
Frame - Zone 3	+\$0	+\$218	+\$34	+\$101	+\$218	+\$368	+\$519	+\$753	+\$1,004	+\$1,271	+\$1,689	+\$2,190	+\$1,455	+\$1,856

Model	Upholstery	Moisture Barrier	Metal Frame Finish	Foot/Glide
	Grade Vendor Pattern Colorway	NMB No Moisture Barrier Seat MB1 Moisture Barrier Seat - add \$251	ASL Arctic Silver PEW Pewter SNK Soft Nickel	GL 4 Glides ESD Easy Slide Disc - White Plastic SS Stainless Steel - add \$138 2C2G 2 Casters/2 Glides ESD Easy Slide Disc - White Plastic - add \$30 SS Stainless Steel - add \$100 4C 4 Casters - add \$67

Description + General Information

80 Armless Sleep Sofa

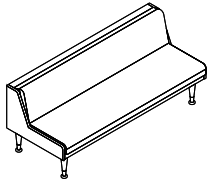

- clean out feature allows for easier cleaning between the back and the seat
- mechanism free fold down back easily converts sofa to sleep position
- under mount, tamper proof power available - order EC49 separately
- replacement parts available, starting on [pg 60](#)
- additional specs, [see pg 5](#)

Dimensions	D	W	H	Shipping	
Overall	32	82 ½	32 ½	Ctn Wt	186
Seat	20	80	19 ¼	Cu Ft	70

	Single Upholstery	Seat Zone 1	Back Zone 2	Frame Zone 3
COM Ydg	7 ½	2 ½	2 ¾	4
COL Sq Ft	135	45	50	72

Single Upholstery Specify: Model | Upholstery | Moisture Barrier | Metal Frame Finish | Foot/Glide

23SU80XA														
	COM	COL	A	B	C	D	E	F	G	H	I	J	L1	L2
Single Uph	\$5,646	\$6,074	\$5,712	\$5,844	\$6,074	\$6,370	\$6,666	\$7,127	\$7,620	\$8,147	\$8,969	\$9,956	\$8,509	\$9,298

Multiple Upholstery Specify: Model | Seat Upholstery | Back Upholstery | Frame Upholstery | Moisture Barrier | Metal Frame Finish | Foot/Glide

23SU80XA_M														
Base Price:	\$5,646 To the Base Price, add the appropriate upcharges by grade, per zone													
	COM	COL	A	B	C	D	E	F	G	H	I	J	L1	L2
Seat - Zone 1	+\$0	+\$140	+\$22	+\$65	+\$140	+\$236	+\$332	+\$482	+\$643	+\$814	+\$1,082	+\$1,403	+\$932	+\$1,189
Back - Zone 2	+\$0	+\$147	+\$23	+\$68	+\$147	+\$248	+\$349	+\$506	+\$674	+\$854	+\$1,135	+\$1,472	+\$978	+\$1,247
Frame - Zone 3	+\$0	+\$218	+\$34	+\$101	+\$218	+\$368	+\$519	+\$753	+\$1,003	+\$1,271	+\$1,689	+\$2,190	+\$1,455	+\$1,856

Model	Upholstery	Moisture Barrier	Metal Frame Finish	Foot/Glide
	Grade Vendor Pattern Colorway	NMB No Moisture Barrier Seat MB1 Moisture Barrier Seat - add \$251	ASL Arctic Silver PEW Pewter SNK Soft Nickel	GL 4 Glides ESD Easy Slide Disc - White Plastic SS Stainless Steel - add \$138 2C2G 2 Casters/2 Glides ESD Easy Slide Disc - White Plastic - add \$30 SS Stainless Steel - add \$100 4C 4 Casters - add \$67

Description + General Information

68 Armless Sleep Sofa with Laminate Wrap

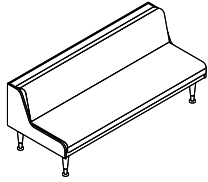

- clean out feature allows for easier cleaning between the back and the seat
- mechanism free fold down back easily converts sofa to sleep position
- under mount, tamper proof power available - order EC49 separately
- replacement parts available, starting on [pg 60](#)
- additional specs, [see pg 5](#)

Dimensions	D	W	H	Shipping	
Overall	32	69 ¾	32 ½	Ctn Wt	193
Seat	20	68	19 ¼	Cu Ft	57

	Single Upholstery	Seat Zone 1	Back Zone 2	Frame Zone 3
COM Ydg	4 ¾	2 ½	2 ¾	1 ½
COL Sq Ft	86	45	50	27

Single Upholstery Specify: Model | Upholstery | Moisture Barrier | Laminate Wrap | Metal Frame Finish | Foot/Glide

23ST68XA														
	COM	COL	A	B	C	D	E	F	G	H	I	J	L1	L2
Single Uph	\$5,507	\$5,780	\$5,549	\$5,633	\$5,780	\$5,969	\$6,157	\$6,451	\$6,765	\$7,101	\$7,625	\$8,254	\$7,332	\$7,835

Multiple Upholstery Specify: Model | Seat Uph | Back Uph | Frame Uph | Moisture Barrier | Laminate Wrap | Metal Frame Finish | Foot/Glide

23ST68XA_M														
Base Price: \$5,507	To the Base Price, add the appropriate upcharges by grade, per zone													
	COM	COL	A	B	C	D	E	F	G	H	I	J	L1	L2
Seat - Zone 1	+\$0	+\$140	+\$22	+\$65	+\$140	+\$236	+\$332	+\$482	+\$643	+\$814	+\$1,082	+\$1,403	+\$932	+\$1,189
Back - Zone 2	+\$0	+\$147	+\$23	+\$68	+\$147	+\$248	+\$349	+\$506	+\$674	+\$854	+\$1,135	+\$1,472	+\$978	+\$1,247
Frame - Zone 3	+\$0	+\$76	+\$12	+\$36	+\$76	+\$129	+\$181	+\$263	+\$351	+\$444	+\$590	+\$765	+\$508	+\$648

Model	Upholstery	Moisture Barrier	Laminate Wrap	Metal Frame Finish	Foot/Glide
	Grade Vendor Pattern Colorway	NMB No Moisture Barrier Seat MB1 Moisture Barrier Seat - add \$251	See Laminate Wrap selection	ASL Arctic Silver PEW Pewter SNK Soft Nickel	GL 4 Glides ESD Easy Slide Disc - White Plastic SS Stainless Steel - add \$138 2C2G 2 Casters/2 Glides ESD Easy Slide Disc - White Plastic - add \$30 SS Stainless Steel - add \$100 4C 4 Casters - add \$67

Description + General Information

69 Armless Sleep Sofa with Laminate Wrap

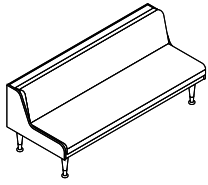

- clean out feature allows for easier cleaning between the back and the seat
- mechanism free fold down back easily converts sofa to sleep position
- under mount, tamper proof power available - order EC49 separately
- replacement parts available, starting on [pg 60](#)
- additional specs, [see pg 5](#)

Dimensions	D	W	H	Shipping	
Overall	32	70 ¾	32 ½	Ctn Wt	195
Seat	20	69	19 ¼	Cu Ft	58

	Single Upholstery	Seat Zone 1	Back Zone 2	Frame Zone 3
COM Ydg	4 ¾	2 ½	2 ¾	1 ½
COL Sq Ft	86	45	50	27

Single Upholstery Specify: Model | Upholstery | Moisture Barrier | Laminate Wrap | Metal Frame Finish | Foot/Glide

23ST69XA														
	COM	COL	A	B	C	D	E	F	G	H	I	J	L1	L2
Single Uph	\$5,519	\$5,792	\$5,561	\$5,645	\$5,792	\$5,981	\$6,169	\$6,463	\$6,777	\$7,113	\$7,637	\$8,266	\$7,344	\$7,847

Multiple Upholstery Specify: Model | Seat Uph | Back Uph | Frame Uph | Moisture Barrier | Laminate Wrap | Metal Frame Finish | Foot/Glide

23ST69XA_M														
Base Price:	\$5,519 To the Base Price, add the appropriate upcharges by grade, per zone													
	COM	COL	A	B	C	D	E	F	G	H	I	J	L1	L2
Seat - Zone 1	+\$0	+\$140	+\$22	+\$65	+\$140	+\$236	+\$332	+\$482	+\$643	+\$814	+\$1,082	+\$1,403	+\$932	+\$1,189
Back - Zone 2	+\$0	+\$147	+\$23	+\$68	+\$147	+\$248	+\$349	+\$506	+\$674	+\$854	+\$1,135	+\$1,472	+\$978	+\$1,247
Frame - Zone 3	+\$0	+\$76	+\$12	+\$36	+\$76	+\$129	+\$181	+\$263	+\$351	+\$444	+\$590	+\$765	+\$508	+\$648

Model	Upholstery	Moisture Barrier	Laminate Wrap	Metal Frame Finish	Foot/Glide
	Grade Vendor Pattern Colorway	NMB No Moisture Barrier Seat MB1 Moisture Barrier Seat - add \$251	See Laminate Wrap selection	ASL Arctic Silver PEW Pewter SNK Soft Nickel	GL 4 Glides ESD Easy Slide Disc - White Plastic SS Stainless Steel - add \$138 2C2G 2 Casters/2 Glides ESD Easy Slide Disc - White Plastic - add \$30 SS Stainless Steel - add \$100 4C 4 Casters - add \$67

Description + General Information

70 Armless Sleep Sofa with Laminate Wrap

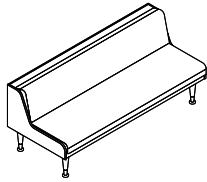

- clean out feature allows for easier cleaning between the back and the seat
- mechanism free fold down back easily converts sofa to sleep position
- under mount, tamper proof power available - order EC49 separately
- replacement parts available, starting on [pg 60](#)
- additional specs, [see pg 5](#)

Dimensions	D	W	H	Shipping	
Overall	32	71 ¾	32 ½	Ctn Wt	198
Seat	20	70	19 ¼	Cu Ft	59

	Single Upholstery	Seat Zone 1	Back Zone 2	Frame Zone 3
COM Ydg	4 ¾	2 ½	2 ¾	1 ½
COL Sq Ft	86	45	50	27

Single Upholstery Specify: Model | Upholstery | Moisture Barrier | Laminate Wrap | Metal Frame Finish | Foot/Glide

23ST70XA														
	COM	COL	A	B	C	D	E	F	G	H	I	J	L1	L2
Single Uph	\$5,530	\$5,803	\$5,572	\$5,656	\$5,803	\$5,992	\$6,180	\$6,474	\$6,789	\$7,124	\$7,648	\$8,277	\$7,355	\$7,858

Multiple Upholstery Specify: Model | Seat Uph | Back Uph | Frame Uph | Moisture Barrier | Laminate Wrap | Metal Frame Finish | Foot/Glide

23ST70XA_M														
Base Price: \$5,530	To the Base Price, add the appropriate upcharges by grade, per zone													
	COM	COL	A	B	C	D	E	F	G	H	I	J	L1	L2
Seat - Zone 1	+\$0	+\$140	+\$22	+\$65	+\$140	+\$236	+\$332	+\$482	+\$643	+\$814	+\$1,082	+\$1,403	+\$932	+\$1,189
Back - Zone 2	+\$0	+\$147	+\$23	+\$68	+\$147	+\$248	+\$349	+\$506	+\$675	+\$854	+\$1,135	+\$1,472	+\$978	+\$1,247
Frame - Zone 3	+\$0	+\$76	+\$12	+\$36	+\$76	+\$129	+\$181	+\$263	+\$351	+\$444	+\$590	+\$765	+\$508	+\$648

Model	Upholstery	Moisture Barrier	Laminate Wrap	Metal Frame Finish	Foot/Glide
	Grade Vendor Pattern Colorway	NMB No Moisture Barrier Seat MB1 Moisture Barrier Seat - add \$251	See Laminate Wrap selection	ASL Arctic Silver PEW Pewter SNK Soft Nickel	GL 4 Glides ESD Easy Slide Disc - White Plastic SS Stainless Steel - add \$138 2C2G 2 Casters/2 Glides ESD Easy Slide Disc - White Plastic - add \$30 SS Stainless Steel - add \$100 4C 4 Casters - add \$67

Description + General Information

71 Armless Sleep Sofa with Laminate Wrap

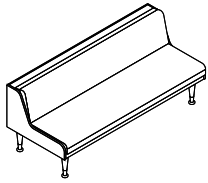

- clean out feature allows for easier cleaning between the back and the seat
- mechanism free fold down back easily converts sofa to sleep position
- under mount, tamper proof power available - order EC49 separately
- replacement parts available, starting on [pg 60](#)
- additional specs, [see pg 5](#)

Dimensions	D	W	H	Shipping	
Overall	32	72 ¾	32 ½	Ctn Wt	200
Seat	20	71	19 ¼	Cu Ft	60

	Single Upholstery	Seat Zone 1	Back Zone 2	Frame Zone 3
COM Ydg	4 ¾	2 ½	2 ¾	1 ½
COL Sq Ft	86	45	50	27

Single Upholstery Specify: Model | Upholstery | Moisture Barrier | Laminate Wrap | Metal Frame Finish | Foot/Glide

23ST71XA														
	COM	COL	A	B	C	D	E	F	G	H	I	J	L1	L2
Single Uph	\$5,542	\$5,815	\$5,584	\$5,668	\$5,815	\$6,004	\$6,192	\$6,486	\$6,800	\$7,136	\$7,660	\$8,289	\$7,367	\$7,870

Multiple Upholstery Specify: Model | Seat Uph | Back Uph | Frame Uph | Moisture Barrier | Laminate Wrap | Metal Frame Finish | Foot/Glide

23ST71XA_M														
Base Price: \$5,542	To the Base Price, add the appropriate upcharges by grade, per zone													
	COM	COL	A	B	C	D	E	F	G	H	I	J	L1	L2
Seat - Zone 1	+\$0	+\$140	+\$22	+\$65	+\$140	+\$236	+\$332	+\$482	+\$643	+\$814	+\$1,082	+\$1,403	+\$932	+\$1,189
Back - Zone 2	+\$0	+\$147	+\$23	+\$68	+\$147	+\$248	+\$349	+\$506	+\$674	+\$854	+\$1,135	+\$1,472	+\$978	+\$1,247
Frame - Zone 3	+\$0	+\$76	+\$12	+\$36	+\$76	+\$129	+\$181	+\$263	+\$351	+\$444	+\$590	+\$765	+\$508	+\$648

Model	Upholstery	Moisture Barrier	Laminate Wrap	Metal Frame Finish	Foot/Glide
	Grade Vendor Pattern Colorway	NMB No Moisture Barrier Seat MB1 Moisture Barrier Seat - add \$251	See Laminate Wrap selection	ASL Arctic Silver PEW Pewter SNK Soft Nickel	GL 4 Glides ESD Easy Slide Disc - White Plastic SS Stainless Steel - add \$138 2C2G 2 Casters/2 Glides ESD Easy Slide Disc - White Plastic - add \$30 SS Stainless Steel - add \$100 4C 4 Casters - add \$67

Description + General Information

72 Armless Sleep Sofa with Laminate Wrap

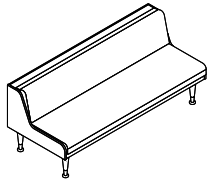

- clean out feature allows for easier cleaning between the back and the seat
- mechanism free fold down back easily converts sofa to sleep position
- under mount, tamper proof power available - order EC49 separately
- replacement parts available, starting on [pg 60](#)
- additional specs, [see pg 5](#)

Dimensions	D	W	H	Shipping	
Overall	32	73 ¾	32 ½	Ctn Wt	203
Seat	20	72	19 ¼	Cu Ft	61

	Single Upholstery	Seat Zone 1	Back Zone 2	Frame Zone 3
COM Ydg	4 ¾	2 ½	2 ¾	1 ½
COL Sq Ft	86	45	50	27

Single Upholstery Specify: Model | Upholstery | Moisture Barrier | Laminate Wrap | Metal Frame Finish | Foot/Glide

23ST72XA														
	COM	COL	A	B	C	D	E	F	G	H	I	J	L1	L2
Single Uph	\$5,553	\$5,826	\$5,595	\$5,679	\$5,826	\$6,015	\$6,204	\$6,497	\$6,812	\$7,147	\$7,671	\$8,300	\$7,378	\$7,881

Multiple Upholstery Specify: Model | Seat Uph | Back Uph | Frame Uph | Moisture Barrier | Laminate Wrap | Metal Frame Finish | Foot/Glide

23ST72XA_M														
Base Price: \$5,553	To the Base Price, add the appropriate upcharges by grade, per zone													
	COM	COL	A	B	C	D	E	F	G	H	I	J	L1	L2
Seat - Zone 1	+\$0	+\$140	+\$22	+\$65	+\$140	+\$236	+\$333	+\$482	+\$643	+\$814	+\$1,082	+\$1,403	+\$932	+\$1,189
Back - Zone 2	+\$0	+\$147	+\$23	+\$68	+\$147	+\$248	+\$349	+\$506	+\$675	+\$854	+\$1,135	+\$1,472	+\$978	+\$1,247
Frame - Zone 3	+\$0	+\$76	+\$12	+\$36	+\$76	+\$129	+\$182	+\$263	+\$351	+\$444	+\$590	+\$765	+\$508	+\$648

Model	Upholstery	Moisture Barrier	Laminate Wrap	Metal Frame Finish	Foot/Glide
	Grade Vendor Pattern Colorway	NMB No Moisture Barrier Seat MB1 Moisture Barrier Seat - add \$251	See Laminate Wrap selection	ASL Arctic Silver PEW Pewter SNK Soft Nickel	GL 4 Glides ESD Easy Slide Disc - White Plastic SS Stainless Steel - add \$138 2C2G 2 Casters/2 Glides ESD Easy Slide Disc - White Plastic - add \$30 SS Stainless Steel - add \$100 4C 4 Casters - add \$67

Description + General Information

73 Armless Sleep Sofa with Laminate Wrap

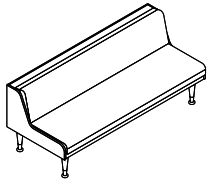

- clean out feature allows for easier cleaning between the back and the seat
- mechanism free fold down back easily converts sofa to sleep position
- under mount, tamper proof power available - order EC49 separately
- replacement parts available, starting on [pg 60](#)
- additional specs, [see pg 5](#)

Dimensions	D	W	H	Shipping	
Overall	32	74 ¾	32 ½	Ctn Wt	205
Seat	20	73	19 ¼	Cu Ft	62

	Single Upholstery	Seat Zone 1	Back Zone 2	Frame Zone 3
COM Ydg	4 ¾	2 ½	2 ¾	1 ½
COL Sq Ft	86	45	50	27

Single Upholstery Specify: Model | Upholstery | Moisture Barrier | Laminate Wrap | Metal Frame Finish | Foot/Glide

23ST73XA														
	COM	COL	A	B	C	D	E	F	G	H	I	J	L1	L2
Single Uph	\$5,565	\$5,838	\$5,607	\$5,691	\$5,838	\$6,027	\$6,215	\$6,509	\$6,823	\$7,159	\$7,683	\$8,312	\$7,390	\$7,893

Multiple Upholstery Specify: Model | Seat Uph | Back Uph | Frame Uph | Moisture Barrier | Laminate Wrap | Metal Frame Finish | Foot/Glide

23ST73XA_M														
Base Price: \$5,565	To the Base Price, add the appropriate upcharges by grade, per zone													
	COM	COL	A	B	C	D	E	F	G	H	I	J	L1	L2
Seat - Zone 1	+\$0	+\$140	+\$22	+\$65	+\$140	+\$236	+\$332	+\$482	+\$643	+\$814	+\$1,082	+\$1,403	+\$932	+\$1,189
Back - Zone 2	+\$0	+\$147	+\$23	+\$68	+\$147	+\$248	+\$349	+\$506	+\$674	+\$854	+\$1,135	+\$1,472	+\$978	+\$1,247
Frame - Zone 3	+\$0	+\$76	+\$12	+\$36	+\$76	+\$129	+\$181	+\$263	+\$351	+\$444	+\$590	+\$765	+\$508	+\$648

Model	Upholstery	Moisture Barrier	Laminate Wrap	Metal Frame Finish	Foot/Glide
	Grade Vendor Pattern Colorway	NMB No Moisture Barrier Seat MB1 Moisture Barrier Seat - add \$251	See Laminate Wrap selection	ASL Arctic Silver PEW Pewter SNK Soft Nickel	GL 4 Glides ESD Easy Slide Disc - White Plastic SS Stainless Steel - add \$138 2C2G 2 Casters/2 Glides ESD Easy Slide Disc - White Plastic - add \$30 SS Stainless Steel - add \$100 4C 4 Casters - add \$67

Description + General Information

74 Armless Sleep Sofa with Laminate Wrap

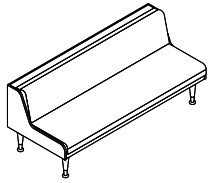

- clean out feature allows for easier cleaning between the back and the seat
- mechanism free fold down back easily converts sofa to sleep position
- under mount, tamper proof power available - order EC49 separately
- replacement parts available, starting on [pg 60](#)
- additional specs, [see pg 5](#)

Dimensions	D	W	H	Shipping	
Overall	32	75 ¾	32 ½	Ctn Wt	207
Seat	20	74	19 ¼	Cu Ft	63

	Single Upholstery	Seat Zone 1	Back Zone 2	Frame Zone 3
COM Ydg	4 ¾	2 ½	2 ¾	1 ½
COL Sq Ft	86	45	50	27

Single Upholstery Specify: Model | Upholstery | Moisture Barrier | Laminate Wrap | Metal Frame Finish | Foot/Glide

23ST74XA														
	COM	COL	A	B	C	D	E	F	G	H	I	J	L1	L2
Single Uph	\$5,577	\$5,850	\$5,619	\$5,703	\$5,850	\$6,038	\$6,227	\$6,521	\$6,835	\$7,171	\$7,695	\$8,324	\$7,401	\$7,905

Multiple Upholstery Specify: Model | Seat Uph | Back Uph | Frame Uph | Moisture Barrier | Laminate Wrap | Metal Frame Finish | Foot/Glide

23ST74XA_M														
Base Price: \$5,577	To the Base Price, add the appropriate upcharges by grade, per zone													
	COM	COL	A	B	C	D	E	F	G	H	I	J	L1	L2
Seat - Zone 1	+\$0	+\$140	+\$22	+\$65	+\$140	+\$236	+\$332	+\$482	+\$643	+\$814	+\$1,082	+\$1,403	+\$932	+\$1,189
Back - Zone 2	+\$0	+\$147	+\$23	+\$68	+\$147	+\$247	+\$349	+\$506	+\$674	+\$854	+\$1,135	+\$1,472	+\$977	+\$1,247
Frame - Zone 3	+\$0	+\$76	+\$12	+\$36	+\$76	+\$129	+\$181	+\$263	+\$351	+\$444	+\$590	+\$765	+\$508	+\$648

Model	Upholstery	Moisture Barrier	Laminate Wrap	Metal Frame Finish	Foot/Glide
	Grade Vendor Pattern Colorway	NMB No Moisture Barrier Seat MB1 Moisture Barrier Seat - add \$251	See Laminate Wrap selection	ASL Arctic Silver PEW Pewter SNK Soft Nickel	GL 4 Glides ESD Easy Slide Disc - White Plastic SS Stainless Steel - add \$138 2C2G 2 Casters/2 Glides ESD Easy Slide Disc - White Plastic - add \$30 SS Stainless Steel - add \$100 4C 4 Casters - add \$67

Description + General Information

75 Armless Sleep Sofa with Laminate Wrap

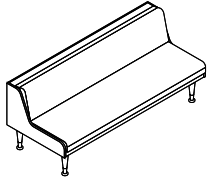

- clean out feature allows for easier cleaning between the back and the seat
- mechanism free fold down back easily converts sofa to sleep position
- under mount, tamper proof power available - order EC49 separately
- replacement parts available, starting on [pg 60](#)
- additional specs, [see pg 5](#)

Dimensions	D	W	H	Shipping	
Overall	32	76 ¾	32 ½	Ctn Wt	209
Seat	20	75	19 ¼	Cu Ft	64

	Single Upholstery	Seat Zone 1	Back Zone 2	Frame Zone 3
COM Ydg	4 ¾	2 ½	2 ¾	1 ½
COL Sq Ft	86	45	50	27

Single Upholstery Specify: Model | Upholstery | Moisture Barrier | TFL Wrap | Metal Frame Finish | Foot/Glide

23ST75XA														
	COM	COL	A	B	C	D	E	F	G	H	I	J	L1	L2
Single Uph	\$5,588	\$5,861	\$5,630	\$5,714	\$5,861	\$6,049	\$6,238	\$6,532	\$6,846	\$7,182	\$7,706	\$8,335	\$7,412	\$7,915

Multiple Upholstery Specify: Model | Seat Uph | Back Uph | Frame Uph | Moisture Barrier | TFL Wrap | Metal Frame Finish | Foot/Glide

23ST75XA_M														
Base Price: \$5,588	To the Base Price, add the appropriate upcharges by grade, per zone													
	COM	COL	A	B	C	D	E	F	G	H	I	J	L1	L2
Seat - Zone 1	+\$0	+\$140	+\$22	+\$65	+\$140	+\$236	+\$332	+\$482	+\$643	+\$814	+\$1,082	+\$1,403	+\$932	+\$1,188
Back - Zone 2	+\$0	+\$147	+\$23	+\$68	+\$147	+\$247	+\$349	+\$506	+\$674	+\$854	+\$1,135	+\$1,472	+\$977	+\$1,247
Frame - Zone 3	+\$0	+\$76	+\$12	+\$36	+\$76	+\$129	+\$181	+\$263	+\$351	+\$444	+\$590	+\$765	+\$508	+\$648

Model	Upholstery	Moisture Barrier	Laminate Wrap	Metal Frame Finish	Foot/Glide
	Grade Vendor Pattern Colorway	NMB No Moisture Barrier Seat MB1 Moisture Barrier Seat - add \$251	See Laminate Wrap selection	ASL Arctic Silver PEW Pewter SNK Soft Nickel	GL 4 Glides ESD Easy Slide Disc - White Plastic SS Stainless Steel - add \$138 2C2G 2 Casters/2 Glides ESD Easy Slide Disc - White Plastic - add \$30 SS Stainless Steel - add \$100 4C 4 Casters - add \$67

Description + General Information

76 Armless Sleep Sofa with Laminate Wrap

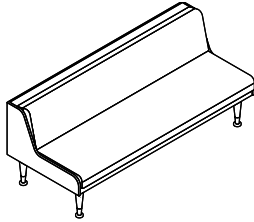

- clean out feature allows for easier cleaning between the back and the seat
- mechanism free fold down back easily converts sofa to sleep position
- under mount, tamper proof power available - order EC49 separately
- replacement parts available, starting on [pg 60](#)
- additional specs, [see pg 5](#)

Dimensions	D	W	H	Shipping	
Overall	32	77 ¾	32 ½	Ctn Wt	212
Seat	20	76	19 ¼	Cu Ft	65

	Single Upholstery	Seat Zone 1	Back Zone 2	Frame Zone 3
COM Ydg	4 ¾	2 ½	2 ¾	1 ½
COL Sq Ft	86	45	50	27

Single Upholstery Specify: Model | Upholstery | Moisture Barrier | TFL Wrap | Metal Frame Finish | Foot/Glide

23ST76XA														
	COM	COL	A	B	C	D	E	F	G	H	I	J	L1	L2
Single Uph	\$5,600	\$5,872	\$5,642	\$5,726	\$5,872	\$6,061	\$6,250	\$6,543	\$6,858	\$7,193	\$7,718	\$8,347	\$7,424	\$7,927

Multiple Upholstery Specify: Model | Seat Uph | Back Uph | Frame Uph | Moisture Barrier | TFL Wrap | Metal Frame Finish | Foot/Glide

23ST76XA_M														
Base Price: \$5,600	To the Base Price, add the appropriate upcharges by grade, per zone													
	COM	COL	A	B	C	D	E	F	G	H	I	J	L1	L2
Seat - Zone 1	+\$0	+\$139	+\$22	+\$65	+\$139	+\$236	+\$332	+\$482	+\$643	+\$814	+\$1,082	+\$1,403	+\$932	+\$1,188
Back - Zone 2	+\$0	+\$146	+\$23	+\$68	+\$146	+\$247	+\$349	+\$506	+\$674	+\$854	+\$1,135	+\$1,472	+\$977	+\$1,247
Frame - Zone 3	+\$0	+\$76	+\$12	+\$36	+\$76	+\$129	+\$181	+\$263	+\$351	+\$444	+\$590	+\$765	+\$508	+\$648

Model	Upholstery	Moisture Barrier	Laminate Wrap	Metal Frame Finish	Foot/Glide
	Grade Vendor Pattern Colorway	NMB No Moisture Barrier Seat MB1 Moisture Barrier Seat - add \$251	See Laminate Wrap selection	ASL Arctic Silver PEW Pewter SNK Soft Nickel	GL 4 Glides ESD Easy Slide Disc - White Plastic SS Stainless Steel - add \$138 2C2G 2 Casters/2 Glides ESD Easy Slide Disc - White Plastic - add \$30 SS Stainless Steel - add \$100 4C 4 Casters - add \$67

Description + General Information

77 Armless Sleep Sofa with Laminate Wrap

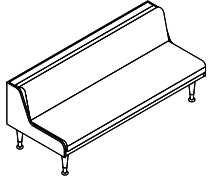

- clean out feature allows for easier cleaning between the back and the seat
- mechanism free fold down back easily converts sofa to sleep position
- under mount, tamper proof power available - order EC49 separately
- replacement parts available, starting on [pg 60](#)
- additional specs, [see pg 5](#)

Dimensions	D	W	H	Shipping	
Overall	32	78 ¾	32 ½	Ctn Wt	214
Seat	20	77	19 ¼	Cu Ft	66

	Single Upholstery	Seat Zone 1	Back Zone 2	Frame Zone 3
COM Ydg	4 ¾	2 ½	2 ¾	1 ½
COL Sq Ft	86	45	50	27

Single Upholstery Specify: Model | Upholstery | Moisture Barrier | TFL Wrap | Metal Frame Finish | Foot/Glide

23ST77XA														
	COM	COL	A	B	C	D	E	F	G	H	I	J	L1	L2
Single Uph	\$5,611	\$5,884	\$5,654	\$5,737	\$5,884	\$6,073	\$6,262	\$6,555	\$6,870	\$7,205	\$7,729	\$8,358	\$7,436	\$7,939

Multiple Upholstery Specify: Model | Seat Uph | Back Uph | Frame Uph | Moisture Barrier | TFL Wrap | Metal Frame Finish | Foot/Glide

23ST77XA_M														
Base Price: \$5,611	To the Base Price, add the appropriate upcharges by grade, per zone													
	COM	COL	A	B	C	D	E	F	G	H	I	J	L1	L2
Seat - Zone 1	+\$0	+\$140	+\$22	+\$65	+\$140	+\$236	+\$333	+\$482	+\$643	+\$814	+\$1,082	+\$1,403	+\$932	+\$1,189
Back - Zone 2	+\$0	+\$147	+\$24	+\$68	+\$147	+\$248	+\$349	+\$506	+\$675	+\$854	+\$1,135	+\$1,472	+\$978	+\$1,247
Frame - Zone 3	+\$0	+\$76	+\$12	+\$36	+\$76	+\$129	+\$182	+\$263	+\$351	+\$444	+\$590	+\$765	+\$508	+\$648

Model	Upholstery	Moisture Barrier	Laminate Wrap	Metal Frame Finish	Foot/Glide
	Grade Vendor Pattern Colorway	NMB No Moisture Barrier Seat MB1 Moisture Barrier Seat - add \$251	See Laminate Wrap selection	ASL Arctic Silver PEW Pewter SNK Soft Nickel	GL 4 Glides ESD Easy Slide Disc - White Plastic SS Stainless Steel - add \$138 2C2G 2 Casters/2 Glides ESD Easy Slide Disc - White Plastic - add \$30 SS Stainless Steel - add \$100 4C 4 Casters - add \$67

Description + General Information

78 Armless Sleep Sofa with Laminate Wrap

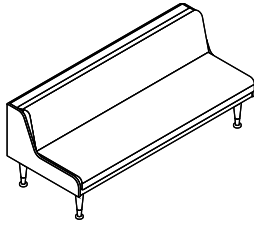

- clean out feature allows for easier cleaning between the back and the seat
- mechanism free fold down back easily converts sofa to sleep position
- under mount, tamper proof power available - order EC49 separately
- replacement parts available, starting on [pg 60](#)
- additional specs, [see pg 5](#)

Dimensions	D	W	H	Shipping	
Overall	32	79 ¾	32 ½	Ctn Wt	217
Seat	20	78	19 ¼	Cu Ft	67

	Single Upholstery	Seat Zone 1	Back Zone 2	Frame Zone 3
COM Ydg	4 ¾	2 ½	2 ¾	1 ½
COL Sq Ft	86	45	50	27

Single Upholstery Specify: Model | Upholstery | Moisture Barrier | TFL Wrap | Metal Frame Finish | Foot/Glide

23ST78XA														
	COM	COL	A	B	C	D	E	F	G	H	I	J	L1	L2
Single Uph	\$5,623	\$5,896	\$5,665	\$5,749	\$5,896	\$6,085	\$6,274	\$6,567	\$6,882	\$7,217	\$7,741	\$8,370	\$7,448	\$7,951

Multiple Upholstery Specify: Model | Seat Uph | Back Uph | Frame Uph | Moisture Barrier | TFL Wrap | Metal Frame Finish | Foot/Glide

23ST78XA_M														
Base Price: \$5,623	To the Base Price, add the appropriate upcharges by grade, per zone													
	COM	COL	A	B	C	D	E	F	G	H	I	J	L1	L2
Seat - Zone 1	+\$0	+\$140	+\$22	+\$65	+\$140	+\$236	+\$333	+\$482	+\$643	+\$814	+\$1,082	+\$1,403	+\$932	+\$1,189
Back - Zone 2	+\$0	+\$147	+\$23	+\$68	+\$147	+\$248	+\$349	+\$506	+\$675	+\$854	+\$1,135	+\$1,472	+\$978	+\$1,247
Frame - Zone 3	+\$0	+\$76	+\$12	+\$36	+\$76	+\$129	+\$182	+\$263	+\$351	+\$444	+\$590	+\$765	+\$508	+\$648

Model	Upholstery	Moisture Barrier	Laminate Wrap	Metal Frame Finish	Foot/Glide
	Grade Vendor Pattern Colorway	NMB No Moisture Barrier Seat MB1 Moisture Barrier Seat - add \$251	See Laminate Wrap selection	ASL Arctic Silver PEW Pewter SNK Soft Nickel	GL 4 Glides ESD Easy Slide Disc - White Plastic SS Stainless Steel - add \$138 2C2G 2 Casters/2 Glides ESD Easy Slide Disc - White Plastic - add \$30 SS Stainless Steel - add \$100 4C 4 Casters - add \$67

Description + General Information

79 Armless Sleep Sofa with Laminate Wrap

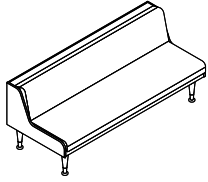

- clean out feature allows for easier cleaning between the back and the seat
- mechanism free fold down back easily converts sofa to sleep position
- under mount, tamper proof power available - order EC49 separately
- replacement parts available, starting on [pg 60](#)
- additional specs, [see pg 5](#)

Dimensions	D	W	H	Shipping	
Overall	32	80 ¾	32 ½	Ctn Wt	219
Seat	20	79	19 ¼	Cu Ft	68

	Single Upholstery	Seat Zone 1	Back Zone 2	Frame Zone 3
COM Ydg	4 ¾	2 ½	2 ¾	1 ½
COL Sq Ft	86	45	50	27

Single Upholstery Specify: Model | Upholstery | Moisture Barrier | TFL Wrap | Metal Frame Finish | Foot/Glide

23ST79XA														
	COM	COL	A	B	C	D	E	F	G	H	I	J	L1	L2
Single Uph	\$5,634	\$5,907	\$5,676	\$5,760	\$5,907	\$6,096	\$6,284	\$6,578	\$6,893	\$7,228	\$7,752	\$8,381	\$7,459	\$7,962

Multiple Upholstery Specify: Model | Seat Uph | Back Uph | Frame Uph | Moisture Barrier | TFL Wrap | Metal Frame Finish | Foot/Glide

23ST79XA_M														
Base Price: \$5,634	To the Base Price, add the appropriate upcharges by grade, per zone													
	COM	COL	A	B	C	D	E	F	G	H	I	J	L1	L2
Seat - Zone 1	+\$0	+\$140	+\$22	+\$65	+\$140	+\$236	+\$332	+\$482	+\$643	+\$814	+\$1,082	+\$1,403	+\$932	+\$1,189
Back - Zone 2	+\$0	+\$147	+\$23	+\$68	+\$147	+\$248	+\$349	+\$506	+\$675	+\$854	+\$1,135	+\$1,472	+\$978	+\$1,247
Frame - Zone 3	+\$0	+\$76	+\$12	+\$36	+\$76	+\$129	+\$181	+\$263	+\$351	+\$444	+\$590	+\$765	+\$508	+\$648

Model	Upholstery	Moisture Barrier	Laminate Wrap	Metal Frame Finish	Foot/Glide
	Grade Vendor Pattern Colorway	NMB No Moisture Barrier Seat MB1 Moisture Barrier Seat - add \$251	See Laminate Wrap selection	ASL Arctic Silver PEW Pewter SNK Soft Nickel	GL 4 Glides ESD Easy Slide Disc - White Plastic SS Stainless Steel - add \$138 2C2G 2 Casters/2 Glides ESD Easy Slide Disc - White Plastic - add \$30 SS Stainless Steel - add \$100 4C 4 Casters - add \$67

Description + General Information

80 Armless Sleep Sofa with Laminate Wrap

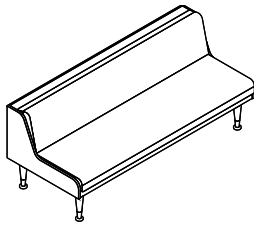

- clean out feature allows for easier cleaning between the back and the seat
- mechanism free fold down back easily converts sofa to sleep position
- under mount, tamper proof power available - order EC49 separately
- replacement parts available, starting on [pg 60](#)
- additional specs, [see pg 5](#)

Dimensions	D	W	H	Shipping	
Overall	32	81 ¾	32 ½	Ctn Wt	221
Seat	20	80	19 ¼	Cu Ft	69

	Single Upholstery	Seat Zone 1	Back Zone 2	Frame Zone 3
COM Ydg	4 ¾	2 ½	2 ¾	1 ½
COL Sq Ft	86	45	50	27

Single Upholstery Specify: Model | Upholstery | Moisture Barrier | TFL Wrap | Metal Frame Finish | Foot/Glide

23ST80XA														
	COM	COL	A	B	C	D	E	F	G	H	I	J	L1	L2
Single Uph	\$5,646	\$5,919	\$5,688	\$5,772	\$5,919	\$6,108	\$6,296	\$6,590	\$6,904	\$7,240	\$7,764	\$8,393	\$7,471	\$7,974

Multiple Upholstery Specify: Model | Seat Uph | Back Uph | Frame Uph | Moisture Barrier | TFL Wrap | Metal Frame Finish | Foot/Glide

23ST80XA_M														
Base Price: \$5,646	To the Base Price, add the appropriate upcharges by grade, per zone													
	COM	COL	A	B	C	D	E	F	G	H	I	J	L1	L2
Seat - Zone 1	+\$0	+\$140	+\$22	+\$65	+\$140	+\$236	+\$332	+\$482	+\$643	+\$814	+\$1,082	+\$1,403	+\$932	+\$1,189
Back - Zone 2	+\$0	+\$147	+\$23	+\$68	+\$147	+\$248	+\$349	+\$506	+\$674	+\$854	+\$1,135	+\$1,472	+\$978	+\$1,247
Frame - Zone 3	+\$0	+\$76	+\$12	+\$36	+\$76	+\$129	+\$181	+\$263	+\$351	+\$444	+\$590	+\$765	+\$508	+\$648

Model	Upholstery	Moisture Barrier	Laminate Wrap	Metal Frame Finish	Foot/Glide
	Grade Vendor Pattern Colorway	NMB No Moisture Barrier Seat MB1 Moisture Barrier Seat - add \$251	See Laminate Wrap selection	ASL Arctic Silver PEW Pewter SNK Soft Nickel	GL 4 Glides ESD Easy Slide Disc - White Plastic SS Stainless Steel - add \$138 2C2G 2 Casters/2 Glides ESD Easy Slide Disc - White Plastic - add \$30 SS Stainless Steel - add \$100 4C 4 Casters - add \$67

Description + General Information

68 Sleep Sofa with Low Arm

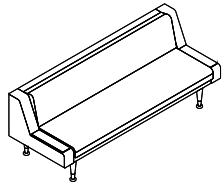

- clean out feature allows for easier cleaning between the back and the seat
- mechanism free fold down back easily converts sofa to sleep position
- under mount, tamper proof power available - order EC49 separately
- replacement parts available, starting on [pg 59](#)
- additional specs, [see pg 5](#)

Dimensions	D	W	H	Shipping	
Overall	32	78	32 ½	Ctn Wt	176
Seat	20	68	19 ¼	Cu Ft	64
Arm			18 ¾		

	Single Upholstery	Seat Zone 1	Back Zone 2	Frame Zone 3
COM Ydg	7 ½	2 ½	2 ¾	4
COL Sq Ft	135	45	50	72

Single Upholstery Specify: Model | Upholstery | Moisture Barrier | Arm Cap | Metal Frame Finish | Foot/Glide | Power

23SU68WLA														
	COM	COL	A	B	C	D	E	F	G	H	I	J	L1	L2
Single Uph	\$6,016	\$6,444	\$6,083	\$6,214	\$6,444	\$6,741	\$7,037	\$7,497	\$7,991	\$8,517	\$9,340	\$10,327	\$8,879	\$9,669

Multiple Upholstery Specify: Model | Seat Uph | Back Uph | Frame Uph | Moisture Barrier | Arm Cap | Metal Frame Finish | Foot/Glide | Power

23SU68WLA_M														
Base Price: \$6,016	To the Base Price, add the appropriate upcharges by grade, per zone													
	COM	COL	A	B	C	D	E	F	G	H	I	J	L1	L2
Seat - Zone 1	+\$0	+\$140	+\$22	+\$65	+\$140	+\$236	+\$333	+\$482	+\$643	+\$814	+\$1,082	+\$1,403	+\$932	+\$1,189
Back - Zone 2	+\$0	+\$147	+\$23	+\$68	+\$147	+\$248	+\$349	+\$506	+\$675	+\$854	+\$1,135	+\$1,472	+\$978	+\$1,247
Frame - Zone 3	+\$0	+\$222	+\$35	+\$103	+\$222	+\$377	+\$530	+\$769	+\$1,025	+\$1,298	+\$1,725	+\$2,236	+\$1,485	+\$1,895

Model	Upholstery	Moisture Barrier	Arm Cap	Metal Frame Finish	Foot/Glide	Power
	Grade Vendor Pattern Colorway	NMB No Moisture Barrier Seat MB1 Moisture Barrier Seat - add \$251	PAC Polyurethane Arm Cap Set 3LAC 3D Laminate Arm Cap Set - add \$228 BEL Belair FLO Florence Walnut PIL Pilsner PIN Pinnacle Walnut SAC Solid Surface Arm Set - add \$425	ASL Arctic Silver PEW Pewter SNK Soft Nickel	GL 4 Glides ESD Easy Slide Disc - White Plastic SS Stainless Steel - add \$138 2C2G 2 Casters/2 Glides ESD Easy Slide Disc - White Plastic - add \$30 SS Stainless Steel - add \$100 4C 4 Casters - add \$67	NPU No Seating Power Unit PUL Power in the Front Left (as seated) P1 110 Plug Internal - add \$174 G Grey W White P2 USB A&C Internal - add \$310 G Grey W White PUR Power in the Front Right (as seated) P1 110 Plug Internal - add \$174 G Grey W White P2 USB A&C Internal - add \$310 G Grey W White PULR Power in the Front Left and Right (as seated) P1 110 Plug Internal - add \$348 G Grey W White P2 USB A&C Internal - add \$620 G Grey W White P3 110 Plug on Left & USB on Right Internal - add \$484 G Grey W White P4 USB on Left & 110 on Right Internal - add \$484 G Grey W White

Description + General Information

69 Sleep Sofa with Low Arm

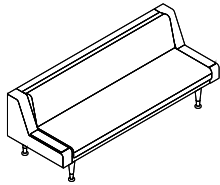

- clean out feature allows for easier cleaning between the back and the seat
- mechanism free fold down back easily converts sofa to sleep position
- under mount, tamper proof power available - order EC49 separately
- replacement parts available, starting on [pg 59](#)
- additional specs, [see pg 5](#)

Dimensions	D	W	H	Shipping	
Overall	32	79	32 ½	Ctn Wt	178
Seat	20	69	19 ¼	Cu Ft	65
Arm			18 ¾		

	Single Upholstery	Seat Zone 1	Back Zone 2	Frame Zone 3
COM Ydg	7 ½	2 ½	2 ¾	4
COL Sq Ft	135	45	50	72

Single Upholstery Specify: Model | Upholstery | Moisture Barrier | Arm Cap | Metal Frame Finish | Foot/Glide | Power

23SU69WLA														
	COM	COL	A	B	C	D	E	F	G	H	I	J	L1	L2
Single Uph	\$6,029	\$6,457	\$6,095	\$6,226	\$6,457	\$6,753	\$7,049	\$7,510	\$8,003	\$8,529	\$9,352	\$10,339	\$8,891	\$9,681

Multiple Upholstery Specify: Model | Seat Uph | Back Uph | Frame Uph | Moisture Barrier | Arm Cap | Metal Frame Finish | Power

23SU69WLA_M														
Base Price: \$6,029	To the Base Price, add the appropriate upcharges by grade, per zone													
	COM	COL	A	B	C	D	E	F	G	H	I	J	L1	L2
Seat - Zone 1	+\$0	+\$140	+\$22	+\$65	+\$140	+\$236	+\$332	+\$482	+\$643	+\$814	+\$1,082	+\$1,403	+\$932	+\$1,189
Back - Zone 2	+\$0	+\$147	+\$23	+\$68	+\$147	+\$248	+\$349	+\$506	+\$674	+\$854	+\$1,135	+\$1,472	+\$977	+\$1,247
Frame - Zone 3	+\$0	+\$222	+\$35	+\$103	+\$222	+\$376	+\$530	+\$769	+\$1,024	+\$1,297	+\$1,724	+\$2,236	+\$1,485	+\$1,895

Model	Upholstery	Moisture Barrier	Arm Cap	Metal Frame Finish	Foot/Glide	Power
	Grade Vendor Pattern Colorway	NMB No Moisture Barrier Seat MB1 Moisture Barrier Seat - add \$251	PAC Polyurethane Arm Cap Set 3LAC 3D Laminate Arm Cap Set - add \$228 BEL Belair FLO Florence Walnut PIL Pilsner PIN Pinnacle Walnut SAC Solid Surface Arm Set - add \$425	ASL Arctic Silver PEW Pewter SNK Soft Nickel	GL 4 Glides ESD Easy Slide Disc - White Plastic SS Stainless Steel - add \$138 2C2G 2 Casters/2 Glides ESD Easy Slide Disc - White Plastic - add \$30 SS Stainless Steel - add \$100 4C 4 Casters - add \$67	NPU No Seating Power Unit PUL Power in the Front Left (as seated) P1 110 Plug Internal - add \$174 G Grey W White P2 USB A&C Internal - add \$310 G Grey W White PUR Power in the Front Right (as seated) P1 110 Plug Internal - add \$174 G Grey W White P2 USB A&C Internal - add \$310 G Grey W White PULR Power in the Front Left and Right (as seated) P1 110 Plug Internal - add \$348 G Grey W White P2 USB A&C Internal - add \$620 G Grey W White P3 110 Plug on Left & USB on Right Internal - add \$484 G Grey W White P4 USB on Left & 110 on Right Internal - add \$484 G Grey W White

Description + General Information

70 Sleep Sofa with Low Arm

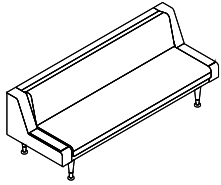

- clean out feature allows for easier cleaning between the back and the seat
- mechanism free fold down back easily converts sofa to sleep position
- under mount, tamper proof power available - order EC49 separately
- replacement parts available, starting on [pg 59](#)
- additional specs, [see pg 5](#)

Dimensions	D	W	H	Shipping	
Overall	32	80	32 ½	Ctn Wt	180
Seat	20	70	19 ¼	Cu Ft	66
Arm			18 ¾		

	Single Upholstery	Seat Zone 1	Back Zone 2	Frame Zone 3
COM Ydg	7 ½	2 ½	2 ¾	4
COL Sq Ft	135	45	50	72

Single Upholstery Specify: Model | Upholstery | Moisture Barrier | Arm Cap | Metal Frame Finish | Foot/Glide | Power

23SU70WLA														
	COM	COL	A	B	C	D	E	F	G	H	I	J	L1	L2
Single Uph	\$6,041	\$6,469	\$6,107	\$6,239	\$6,469	\$6,765	\$7,061	\$7,522	\$8,015	\$8,542	\$9,364	\$10,351	\$8,904	\$9,693

Multiple Upholstery Specify: Model | Seat Uph | Back Uph | Frame Uph | Moisture Barrier | Arm Cap | Metal Frame Finish | Foot/Glide | Power

23SU70WLA_M														
Base Price: \$6,041	To the Base Price, add the appropriate upcharges by grade, per zone													
	COM	COL	A	B	C	D	E	F	G	H	I	J	L1	L2
Seat - Zone 1	+\$0	+\$140	+\$22	+\$65	+\$140	+\$236	+\$332	+\$482	+\$643	+\$814	+\$1,082	+\$1,403	+\$932	+\$1,189
Back - Zone 2	+\$0	+\$147	+\$23	+\$68	+\$147	+\$248	+\$349	+\$506	+\$674	+\$854	+\$1,135	+\$1,472	+\$978	+\$1,247
Frame - Zone 3	+\$0	+\$222	+\$35	+\$103	+\$222	+\$376	+\$530	+\$769	+\$1,024	+\$1,298	+\$1,724	+\$2,236	+\$1,485	+\$1,895

Model	Upholstery	Moisture Barrier	Arm Cap	Metal Frame Finish	Foot/Glide	Power
	Grade Vendor Pattern Colorway	NMB No Moisture Barrier Seat MB1 Moisture Barrier Seat - add \$251	PAC Polyurethane Arm Cap Set 3LAC 3D Laminate Arm Cap Set - add \$228 BEL Belair FLO Florence Walnut PIL Pilsner PIN Pinnacle Walnut SAC Solid Surface Arm Set - add \$425	ASL Arctic Silver PEW Pewter SNK Soft Nickel	GL 4 Glides ESD Easy Slide Disc - White Plastic SS Stainless Steel - add \$138 2C2G 2 Casters/2 Glides ESD Easy Slide Disc - White Plastic - add \$30 SS Stainless Steel - add \$100 4C 4 Casters - add \$67	NPU No Seating Power Unit PUL Power in the Front Left (as seated) P1 110 Plug Internal - add \$174 G Grey W White P2 USB A&C Internal - add \$310 G Grey W White PUR Power in the Front Right (as seated) P1 110 Plug Internal - add \$174 G Grey W White P2 USB A&C Internal - add \$310 G Grey W White PULR Power in the Front Left and Right (as seated) P1 110 Plug Internal - add \$348 G Grey W White P2 USB A&C Internal - add \$620 G Grey W White P3 110 Plug on Left & USB on Right Internal - add \$484 G Grey W White P4 USB on Left & 110 on Right Internal - add \$484 G Grey W White

Description + General Information

71 Sleep Sofa with Low Arm

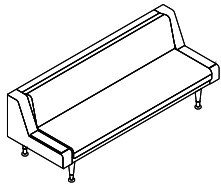

- clean out feature allows for easier cleaning between the back and the seat
- mechanism free fold down back easily converts sofa to sleep position
- under mount, tamper proof power available - order EC49 separately
- replacement parts available, starting on [pg 59](#)
- additional specs, [see pg 5](#)

Dimensions	D	W	H	Shipping	
Overall	32	81	32 ½	Ctn Wt	182
Seat	20	71	19 ¼	Cu Ft	67
Arm			18 ¾		

	Single Upholstery	Seat Zone 1	Back Zone 2	Frame Zone 3
COM Ydg	7 ½	2 ½	2 ¾	4
COL Sq Ft	135	45	50	72

Single Upholstery Specify: Model | Upholstery | Moisture Barrier | Arm Cap | Metal Frame Finish | Foot/Glide | Power

23SU71WLA														
	COM	COL	A	B	C	D	E	F	G	H	I	J	L1	L2
Single Uph	\$6,053	\$6,481	\$6,119	\$6,251	\$6,481	\$6,777	\$7,073	\$7,534	\$8,027	\$8,554	\$9,376	\$10,363	\$8,916	\$9,705

Multiple Upholstery Specify: Model | Seat Uph | Back Uph | Frame Uph | Moisture Barrier | Arm Cap | Metal Frame Finish | Foot/Glide | Power

23SU71WLA_M														
Base Price: \$6,053	To the Base Price, add the appropriate upcharges by grade, per zone													
	COM	COL	A	B	C	D	E	F	G	H	I	J	L1	L2
Seat - Zone 1	+\$0	+\$140	+\$22	+\$65	+\$140	+\$236	+\$332	+\$482	+\$643	+\$814	+\$1,082	+\$1,403	+\$932	+\$1,189
Back - Zone 2	+\$0	+\$147	+\$23	+\$68	+\$147	+\$248	+\$349	+\$506	+\$674	+\$854	+\$1,135	+\$1,472	+\$978	+\$1,247
Frame - Zone 3	+\$0	+\$222	+\$35	+\$103	+\$222	+\$376	+\$530	+\$769	+\$1,024	+\$1,298	+\$1,724	+\$2,236	+\$1,485	+\$1,895

Model	Upholstery	Moisture Barrier	Arm Cap	Metal Frame Finish	Foot/Glide	Power
	Grade Vendor Pattern Colorway	NMB No Moisture Barrier Seat MB1 Moisture Barrier Seat - add \$251	PAC Polyurethane Arm Cap Set 3LAC 3D Laminate Arm Cap Set - add \$228 BEL Belair FLO Florence Walnut PIL Pilsner PIN Pinnacle Walnut SAC Solid Surface Arm Set - add \$425	ASL Arctic Silver PEW Pewter SNK Soft Nickel	GL 4 Glides ESD Easy Slide Disc - White Plastic SS Stainless Steel - add \$138 2C2G 2 Casters/2 Glides ESD Easy Slide Disc - White Plastic - add \$30 SS Stainless Steel - add \$100 4C 4 Casters - add \$67	NPU No Seating Power Unit PUL Power in the Front Left (as seated) P1 110 Plug Internal - add \$174 G Grey W White P2 USB A&C Internal - add \$310 G Grey W White PUR Power in the Front Right (as seated) P1 110 Plug Internal - add \$174 G Grey W White P2 USB A&C Internal - add \$310 G Grey W White PULR Power in the Front Left and Right (as seated) P1 110 Plug Internal - add \$348 G Grey W White P2 USB A&C Internal - add \$620 G Grey W White P3 110 Plug on Left & USB on Right Internal - add \$484 G Grey W White P4 USB on Left & 110 on Right Internal - add \$484 G Grey W White

Description + General Information

72 Sleep Sofa with Low Arm

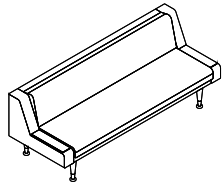

- clean out feature allows for easier cleaning between the back and the seat
- mechanism free fold down back easily converts sofa to sleep position
- under mount, tamper proof power available - order EC49 separately
- replacement parts available, starting on [pg 59](#)
- additional specs, [see pg 5](#)

Dimensions	D	W	H	Shipping	
Overall	32	82	32 ½	Ctn Wt	184
Seat	20	72	19 ¼	Cu Ft	68
Arm			18 ¾		

	Single Upholstery	Seat Zone 1	Back Zone 2	Frame Zone 3
COM Ydg	7 ½	2 ½	2 ¾	4
COL Sq Ft	135	45	50	72

Single Upholstery Specify: Model | Upholstery | Moisture Barrier | Arm Cap | Metal Frame Finish | Foot/Glide | Power

23SU72WLA														
	COM	COL	A	B	C	D	E	F	G	H	I	J	L1	L2
Single Uph	\$6,065	\$6,493	\$6,131	\$6,263	\$6,493	\$6,789	\$7,086	\$7,546	\$8,040	\$8,566	\$9,389	\$10,376	\$8,928	\$9,718

Multiple Upholstery Specify: Model | Seat Uph | Back Uph | Frame Uph | Moisture Barrier | Arm Cap | Metal Frame Finish | Foot/Glide | Power

23SU72WLA_M														
Base Price: \$6,065	To the Base Price, add the appropriate upcharges by grade, per zone													
	COM	COL	A	B	C	D	E	F	G	H	I	J	L1	L2
Seat - Zone 1	+\$0	+\$140	+\$22	+\$65	+\$140	+\$236	+\$333	+\$482	+\$643	+\$814	+\$1,082	+\$1,403	+\$932	+\$1,189
Back - Zone 2	+\$0	+\$147	+\$23	+\$68	+\$147	+\$248	+\$349	+\$506	+\$675	+\$854	+\$1,135	+\$1,472	+\$978	+\$1,247
Frame - Zone 3	+\$0	+\$222	+\$35	+\$103	+\$222	+\$376	+\$530	+\$769	+\$1,025	+\$1,298	+\$1,725	+\$2,236	+\$1,485	+\$1,895

Model	Upholstery	Moisture Barrier	Arm Cap	Metal Frame Finish	Foot/Glide	Power
	Grade Vendor Pattern Colorway	NMB No Moisture Barrier Seat MB1 Moisture Barrier Seat - add \$251	PAC Polyurethane Arm Cap Set 3LAC 3D Laminate Arm Cap Set - add \$228 BEL Belair FLO Florence Walnut PIL Pilsner PIN Pinnacle Walnut SAC Solid Surface Arm Set - add \$425	ASL Arctic Silver PEW Pewter SNK Soft Nickel	GL 4 Glides ESD Easy Slide Disc - White Plastic SS Stainless Steel - add \$138 2C2G 2 Casters/2 Glides ESD Easy Slide Disc - White Plastic - add \$30 SS Stainless Steel - add \$100 4C 4 Casters - add \$67	NPU No Seating Power Unit PUL Power in the Front Left (as seated) P1 110 Plug Internal - add \$174 G Grey W White P2 USB A&C Internal - add \$310 G Grey W White PUR Power in the Front Right (as seated) P1 110 Plug Internal - add \$174 G Grey W White P2 USB A&C Internal - add \$310 G Grey W White PULR Power in the Front Left and Right (as seated) P1 110 Plug Internal - add \$348 G Grey W White P2 USB A&C Internal - add \$620 G Grey W White P3 110 Plug on Left & USB on Right Internal - add \$484 G Grey W White P4 USB on Left & 110 on Right Internal - add \$484 G Grey W White

Description + General Information

73 Sleep Sofa with Low Arm

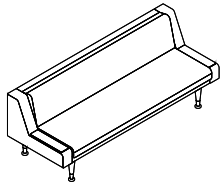

- clean out feature allows for easier cleaning between the back and the seat
- mechanism free fold down back easily converts sofa to sleep position
- under mount, tamper proof power available - order EC49 separately
- replacement parts available, starting on [pg 59](#)
- additional specs, [see pg 5](#)

Dimensions	D	W	H	Shipping	
Overall	32	83	32 ½	Ctn Wt	186
Seat	20	73	19 ¼	Cu Ft	69
Arm			18 ¾		

	Single Upholstery	Seat Zone 1	Back Zone 2	Frame Zone 3
COM Ydg	7 ½	2 ½	2 ¾	4
COL Sq Ft	135	45	50	72

Single Upholstery Specify: Model | Upholstery | Moisture Barrier | Arm Cap | Metal Frame Finish | Foot/Glide | Power

23SU73WLA														
	COM	COL	A	B	C	D	E	F	G	H	I	J	L1	L2
Single Uph	\$6,077	\$6,505	\$6,144	\$6,275	\$6,505	\$6,802	\$7,098	\$7,558	\$8,052	\$8,578	\$9,401	\$10,388	\$8,940	\$9,730

Multiple Upholstery Specify: Model | Seat Uph | Back Uph | Frame Uph | Moisture Barrier | Arm Cap | Metal Frame Finish | Foot/Glide | Power

23SU73WLA_M														
Base Price: \$6,077	To the Base Price, add the appropriate upcharges by grade, per zone													
	COM	COL	A	B	C	D	E	F	G	H	I	J	L1	L2
Seat - Zone 1	+\$0	+\$140	+\$22	+\$65	+\$140	+\$236	+\$333	+\$482	+\$643	+\$814	+\$1,082	+\$1,403	+\$932	+\$1,189
Back - Zone 2	+\$0	+\$147	+\$23	+\$68	+\$147	+\$248	+\$349	+\$506	+\$675	+\$854	+\$1,135	+\$1,472	+\$978	+\$1,247
Frame - Zone 3	+\$0	+\$222	+\$35	+\$103	+\$222	+\$377	+\$530	+\$769	+\$1,025	+\$1,298	+\$1,725	+\$2,236	+\$1,485	+\$1,895

Model	Upholstery	Moisture Barrier	Arm Cap	Metal Frame Finish	Foot/Glide	Power
	Grade Vendor Pattern Colorway	NMB No Moisture Barrier Seat MB1 Moisture Barrier Seat - add \$251	PAC Polyurethane Arm Cap Set 3LAC 3D Laminate Arm Cap Set - add \$228 BEL Belair FLO Florence Walnut PIL Pilsner PIN Pinnacle Walnut SAC Solid Surface Arm Set - add \$425	ASL Arctic Silver PEW Pewter SNK Soft Nickel	GL 4 Glides ESD Easy Slide Disc - White Plastic SS Stainless Steel - add \$138 2C2G 2 Casters/2 Glides ESD Easy Slide Disc - White Plastic - add \$30 SS Stainless Steel - add \$100 4C 4 Casters - add \$67	NPU No Seating Power Unit PUL Power in the Front Left (as seated) P1 110 Plug Internal - add \$174 G Grey W White P2 USB A&C Internal - add \$310 G Grey W White PUR Power in the Front Right (as seated) P1 110 Plug Internal - add \$174 G Grey W White P2 USB A&C Internal - add \$310 G Grey W White PULR Power in the Front Left and Right (as seated) P1 110 Plug Internal - add \$348 G Grey W White P2 USB A&C Internal - add \$620 G Grey W White P3 110 Plug on Left & USB on Right Internal - add \$484 G Grey W White P4 USB on Left & 110 on Right Internal - add \$484 G Grey W White

Description + General Information

74 Sleep Sofa with Low Arm

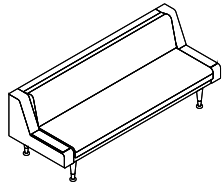

- clean out feature allows for easier cleaning between the back and the seat
- mechanism free fold down back easily converts sofa to sleep position
- under mount, tamper proof power available - order EC49 separately
- replacement parts available, starting on [pg 59](#)
- additional specs, [see pg 5](#)

Dimensions	D	W	H	Shipping	
Overall	32	84	32 ½	Ctn Wt	188
Seat	20	74	19 ¼	Cu Ft	70
Arm			18 ¾		

	Single Upholstery	Seat Zone 1	Back Zone 2	Frame Zone 3
COM Ydg	7 ½	2 ½	2 ¾	4
COL Sq Ft	135	45	50	72

Single Upholstery Specify: Model | Upholstery | Moisture Barrier | Arm Cap | Metal Frame Finish | Foot/Glide | Power

23SU74WLA														
	COM	COL	A	B	C	D	E	F	G	H	I	J	L1	L2
Single Uph	\$6,090	\$6,518	\$6,156	\$6,287	\$6,518	\$6,814	\$7,110	\$7,570	\$8,064	\$8,590	\$9,413	\$10,400	\$8,952	\$9,742

Multiple Upholstery Specify: Model | Seat Uph | Back Uph | Frame Uph | Moisture Barrier | Arm Cap | Metal Frame Finish | Foot/Glide | Power

23SU74WLA_M														
Base Price: \$6,090	To the Base Price, add the appropriate upcharges by grade, per zone													
	COM	COL	A	B	C	D	E	F	G	H	I	J	L1	L2
Seat - Zone 1	+\$0	+\$140	+\$22	+\$65	+\$140	+\$236	+\$332	+\$482	+\$643	+\$814	+\$1,082	+\$1,403	+\$932	+\$1,189
Back - Zone 2	+\$0	+\$147	+\$23	+\$68	+\$147	+\$248	+\$349	+\$506	+\$674	+\$854	+\$1,135	+\$1,472	+\$977	+\$1,247
Frame - Zone 3	+\$0	+\$222	+\$35	+\$103	+\$222	+\$376	+\$530	+\$768	+\$1,024	+\$1,297	+\$1,724	+\$2,236	+\$1,485	+\$1,895

Model	Upholstery	Moisture Barrier	Arm Cap	Metal Frame Finish	Foot/Glide	Power
	Grade Vendor Pattern Colorway	NMB No Moisture Barrier Seat MB1 Moisture Barrier Seat - add \$251	PAC Polyurethane Arm Cap Set 3LAC 3D Laminate Arm Cap Set - add \$228 BEL Belair FLO Florence Walnut PIL Pilsner PIN Pinnacle Walnut SAC Solid Surface Arm Set - add \$425	ASL Arctic Silver PEW Pewter SNK Soft Nickel	GL 4 Glides ESD Easy Slide Disc - White Plastic SS Stainless Steel - add \$138 2C2G 2 Casters/2 Glides ESD Easy Slide Disc - White Plastic - add \$30 SS Stainless Steel - add \$100 4C 4 Casters - add \$67	NPU No Seating Power Unit PUL Power in the Front Left (as seated) P1 110 Plug Internal - add \$174 G Grey W White P2 USB A&C Internal - add \$310 G Grey W White PUR Power in the Front Right (as seated) P1 110 Plug Internal - add \$174 G Grey W White P2 USB A&C Internal - add \$310 G Grey W White PULR Power in the Front Left and Right (as seated) P1 110 Plug Internal - add \$348 G Grey W White P2 USB A&C Internal - add \$620 G Grey W White P3 110 Plug on Left & USB on Right Internal - add \$484 G Grey W White P4 USB on Left & 110 on Right Internal - add \$484 G Grey W White

Description + General Information

75 Sleep Sofa with Low Arm

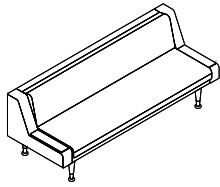

- clean out feature allows for easier cleaning between the back and the seat
- mechanism free fold down back easily converts sofa to sleep position
- under mount, tamper proof power available - order EC49 separately
- replacement parts available, starting on [pg 59](#)
- additional specs, [see pg 5](#)

Dimensions	D	W	H	Shipping	
Overall	32	85	32 ½	Ctn Wt	190
Seat	20	75	19 ¼	Cu Ft	71
Arm			18 ¾		

	Single Upholstery	Seat Zone 1	Back Zone 2	Frame Zone 3
COM Ydg	7 ½	2 ½	2 ¾	4
COL Sq Ft	135	45	50	72

Single Upholstery Specify: Model | Upholstery | Moisture Barrier | Arm Cap | Metal Frame Finish | Foot/Glide | Power

23SU75WLA														
	COM	COL	A	B	C	D	E	F	G	H	I	J	L1	L2
Single Uph	\$6,102	\$6,530	\$6,168	\$6,299	\$6,530	\$6,826	\$7,122	\$7,582	\$8,076	\$8,602	\$9,425	\$10,412	\$8,964	\$9,754

Multiple Upholstery Specify: Model | Seat Uph | Back Uph | Frame Uph | Moisture Barrier | Arm Cap | Metal Frame Finish | Foot/Glide | Power

23SU75WLA_M														
Base Price: \$6,102	To the Base Price, add the appropriate upcharges by grade, per zone													
	COM	COL	A	B	C	D	E	F	G	H	I	J	L1	L2
Seat - Zone 1	+\$0	+\$140	+\$22	+\$65	+\$140	+\$236	+\$332	+\$482	+\$643	+\$814	+\$1,082	+\$1,403	+\$932	+\$1,189
Back - Zone 2	+\$0	+\$147	+\$23	+\$68	+\$147	+\$248	+\$349	+\$506	+\$674	+\$854	+\$1,135	+\$1,472	+\$977	+\$1,247
Frame - Zone 3	+\$0	+\$222	+\$35	+\$103	+\$222	+\$376	+\$530	+\$768	+\$1,024	+\$1,297	+\$1,724	+\$2,236	+\$1,485	+\$1,895

Model	Upholstery	Moisture Barrier	Arm Cap	Metal Frame Finish	Foot/Glide	Power
	Grade Vendor Pattern Colorway	NMB No Moisture Barrier Seat MB1 Moisture Barrier Seat - add \$251	PAC Polyurethane Arm Cap Set 3LAC 3D Laminate Arm Cap Set - add \$228 BEL Belair FLO Florence Walnut PIL Pilsner PIN Pinnacle Walnut SAC Solid Surface Arm Set - add \$425	ASL Arctic Silver PEW Pewter SNK Soft Nickel	GL 4 Glides ESD Easy Slide Disc - White Plastic SS Stainless Steel - add \$138 2C2G 2 Casters/2 Glides ESD Easy Slide Disc - White Plastic - add \$30 SS Stainless Steel - add \$100 4C 4 Casters - add \$67	NPU No Seating Power Unit PUL Power in the Front Left (as seated) P1 110 Plug Internal - add \$174 G Grey W White P2 USB A&C Internal - add \$310 G Grey W White PUR Power in the Front Right (as seated) P1 110 Plug Internal - add \$174 G Grey W White P2 USB A&C Internal - add \$310 G Grey W White PULR Power in the Front Left and Right (as seated) P1 110 Plug Internal - add \$348 G Grey W White P2 USB A&C Internal - add \$620 G Grey W White P3 110 Plug on Left & USB on Right Internal - add \$484 G Grey W White P4 USB on Left & 110 on Right Internal - add \$484 G Grey W White

Description + General Information

76 Sleep Sofa with Low Arm

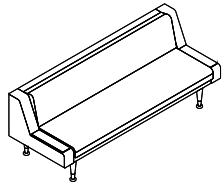

- clean out feature allows for easier cleaning between the back and the seat
- mechanism free fold down back easily converts sofa to sleep position
- under mount, tamper proof power available - order EC49 separately
- replacement parts available, starting on [pg 59](#)
- additional specs, [see pg 5](#)

Dimensions	D	W	H	Shipping	
Overall	32	86	32 ½	Ctn Wt	192
Seat	20	76	19 ¼	Cu Ft	72
Arm			18 ¾		

	Single Upholstery	Seat Zone 1	Back Zone 2	Frame Zone 3
COM Ydg	7 ½	2 ½	2 ¾	4
COL Sq Ft	135	45	50	72

Single Upholstery Specify: Model | Upholstery | Moisture Barrier | Arm Cap | Metal Frame Finish | Foot/Glide | Power

23SU76WLA														
	COM	COL	A	B	C	D	E	F	G	H	I	J	L1	L2
Single Uph	\$6,114	\$6,542	\$6,180	\$6,312	\$6,542	\$6,838	\$7,134	\$7,595	\$8,088	\$8,615	\$9,437	\$10,424	\$8,976	\$9,766

Multiple Upholstery Specify: Model | Seat Uph | Back Uph | Frame Uph | Moisture Barrier | Arm Cap | Metal Frame Finish | Foot/Glide | Power

23SU76WLA_M														
Base Price: \$6,114	To the Base Price, add the appropriate upcharges by grade, per zone													
	COM	COL	A	B	C	D	E	F	G	H	I	J	L1	L2
Seat - Zone 1	+\$0	+\$140	+\$22	+\$65	+\$140	+\$236	+\$332	+\$482	+\$643	+\$814	+\$1,082	+\$1,403	+\$932	+\$1,189
Back - Zone 2	+\$0	+\$147	+\$23	+\$68	+\$147	+\$248	+\$349	+\$506	+\$674	+\$854	+\$1,135	+\$1,472	+\$977	+\$1,247
Frame - Zone 3	+\$0	+\$222	+\$35	+\$103	+\$222	+\$376	+\$530	+\$769	+\$1,024	+\$1,298	+\$1,724	+\$2,236	+\$1,485	+\$1,895

Model	Upholstery	Moisture Barrier	Arm Cap	Metal Frame Finish	Foot/Glide	Power
	Grade Vendor Pattern Colorway	NMB No Moisture Barrier Seat MB1 Moisture Barrier Seat - add \$251	PAC Polyurethane Arm Cap Set 3LAC 3D Laminate Arm Cap Set - add \$228 BEL Belair FLO Florence Walnut PIL Pilsner PIN Pinnacle Walnut SAC Solid Surface Arm Set - add \$425	ASL Arctic Silver PEW Pewter SNK Soft Nickel	GL 4 Glides ESD Easy Slide Disc - White Plastic SS Stainless Steel - add \$138 2C2G 2 Casters/2 Glides ESD Easy Slide Disc - White Plastic - add \$30 SS Stainless Steel - add \$100 4C 4 Casters - add \$67	NPU No Seating Power Unit PUL Power in the Front Left (as seated) P1 110 Plug Internal - add \$174 G Grey W White P2 USB A&C Internal - add \$310 G Grey W White PUR Power in the Front Right (as seated) P1 110 Plug Internal - add \$174 G Grey W White P2 USB A&C Internal - add \$310 G Grey W White PULR Power in the Front Left and Right (as seated) P1 110 Plug Internal - add \$348 G Grey W White P2 USB A&C Internal - add \$620 G Grey W White P3 110 Plug on Left & USB on Right Internal - add \$484 G Grey W White P4 USB on Left & 110 on Right Internal - add \$484 G Grey W White

Description + General Information

77 Sleep Sofa with Low Arm

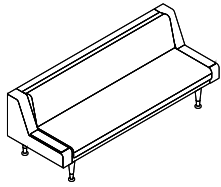

- clean out feature allows for easier cleaning between the back and the seat
- mechanism free fold down back easily converts sofa to sleep position
- under mount, tamper proof power available - order EC49 separately
- replacement parts available, starting on [pg 59](#)
- additional specs, [see pg 5](#)

Dimensions	D	W	H	Shipping	
Overall	32	87	32 ½	Ctn Wt	194
Seat	20	77	19 ¼	Cu Ft	73
Arm			18 ¾		

	Single Upholstery	Seat Zone 1	Back Zone 2	Frame Zone 3
COM Ydg	7 ½	2 ½	2 ¾	4
COL Sq Ft	135	45	50	72

Single Upholstery Specify: Model | Upholstery | Moisture Barrier | Arm Cap | Metal Frame Finish | Foot/Glide | Power

23SU77WLA														
	COM	COL	A	B	C	D	E	F	G	H	I	J	L1	L2
Single Uph	\$6,126	\$6,554	\$6,192	\$6,324	\$6,554	\$6,850	\$7,146	\$7,607	\$8,100	\$8,627	\$9,449	\$10,436	\$8,989	\$9,778

Multiple Upholstery Specify: Model | Seat Uph | Back Uph | Frame Uph | Moisture Barrier | Arm Cap | Metal Frame Finish | Foot/Glide | Power

23SU77WLA_M														
Base Price: \$6,126	To the Base Price, add the appropriate upcharges by grade, per zone													
	COM	COL	A	B	C	D	E	F	G	H	I	J	L1	L2
Seat - Zone 1	+\$0	+\$140	+\$22	+\$65	+\$140	+\$236	+\$332	+\$482	+\$643	+\$814	+\$1,082	+\$1,403	+\$932	+\$1,189
Back - Zone 2	+\$0	+\$147	+\$23	+\$68	+\$147	+\$248	+\$349	+\$506	+\$674	+\$854	+\$1,135	+\$1,472	+\$978	+\$1,247
Frame - Zone 3	+\$0	+\$222	+\$35	+\$103	+\$222	+\$376	+\$530	+\$769	+\$1,024	+\$1,298	+\$1,724	+\$2,236	+\$1,485	+\$1,895

Model	Upholstery	Moisture Barrier	Arm Cap	Metal Frame Finish	Foot/Glide	Power
	Grade Vendor Pattern Colorway	NMB No Moisture Barrier Seat MB1 Moisture Barrier Seat - add \$251	PAC Polyurethane Arm Cap Set 3LAC 3D Laminate Arm Cap Set - add \$228 BEL Belair FLO Florence Walnut PIL Pilsner PIN Pinnacle Walnut SAC Solid Surface Arm Set - add \$425	ASL Arctic Silver PEW Pewter SNK Soft Nickel	GL 4 Glides ESD Easy Slide Disc - White Plastic SS Stainless Steel - add \$138 2C2G 2 Casters/2 Glides ESD Easy Slide Disc - White Plastic - add \$30 SS Stainless Steel - add \$100 4C 4 Casters - add \$67	NPU No Seating Power Unit PUL Power in the Front Left (as seated) P1 110 Plug Internal - add \$174 G Grey W White P2 USB A&C Internal - add \$310 G Grey W White PUR Power in the Front Right (as seated) P1 110 Plug Internal - add \$174 G Grey W White P2 USB A&C Internal - add \$310 G Grey W White PULR Power in the Front Left and Right (as seated) P1 110 Plug Internal - add \$348 G Grey W White P2 USB A&C Internal - add \$620 G Grey W White P3 110 Plug on Left & USB on Right Internal - add \$484 G Grey W White P4 USB on Left & 110 on Right Internal - add \$484 G Grey W White

Description + General Information

78 Sleep Sofa with Low Arm

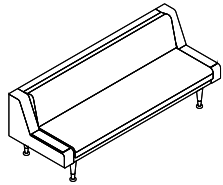

- clean out feature allows for easier cleaning between the back and the seat
- mechanism free fold down back easily converts sofa to sleep position
- under mount, tamper proof power available - order EC49 separately
- replacement parts available, starting on [pg 59](#)
- additional specs, [see pg 5](#)

Dimensions	D	W	H	Shipping	
Overall	32	88	32 ½	Ctn Wt	196
Seat	20	78	19 ¼	Cu Ft	74
Arm			18 ¾		

	Single Upholstery	Seat Zone 1	Back Zone 2	Frame Zone 3
COM Ydg	7 ½	2 ½	2 ¾	4
COL Sq Ft	135	45	50	72

Single Upholstery Specify: Model | Upholstery | Moisture Barrier | Arm Cap | Metal Frame Finish | Foot/Glide | Power

23SU78WLA														
	COM	COL	A	B	C	D	E	F	G	H	I	J	L1	L2
Single Uph	\$6,138	\$6,566	\$6,204	\$6,336	\$6,566	\$6,862	\$7,158	\$7,619	\$8,113	\$8,639	\$9,461	\$10,448	\$9,001	\$9,790

Multiple Upholstery Specify: Model | Seat Uph | Back Uph | Frame Uph | Moisture Barrier | Arm Cap | Metal Frame Finish | Foot/Glide | Power

23SU78WLA_M														
Base Price: \$6,138	To the Base Price, add the appropriate upcharges by grade, per zone													
	COM	COL	A	B	C	D	E	F	G	H	I	J	L1	L2
Seat - Zone 1	+\$0	+\$140	+\$22	+\$65	+\$140	+\$236	+\$332	+\$482	+\$643	+\$814	+\$1,082	+\$1,403	+\$932	+\$1,189
Back - Zone 2	+\$0	+\$147	+\$23	+\$68	+\$147	+\$248	+\$349	+\$506	+\$675	+\$854	+\$1,135	+\$1,472	+\$978	+\$1,247
Frame - Zone 3	+\$0	+\$222	+\$35	+\$103	+\$222	+\$376	+\$530	+\$769	+\$1,025	+\$1,298	+\$1,724	+\$2,236	+\$1,485	+\$1,895

Model	Upholstery	Moisture Barrier	Arm Cap	Metal Frame Finish	Foot/Glide	Power
	Grade Vendor Pattern Colorway	NMB No Moisture Barrier Seat MB1 Moisture Barrier Seat - add \$251	PAC Polyurethane Arm Cap Set 3LAC 3D Laminate Arm Cap Set - add \$228 BEL Belair FLO Florence Walnut PIL Pilsner PIN Pinnacle Walnut SAC Solid Surface Arm Set - add \$425	ASL Arctic Silver PEW Pewter SNK Soft Nickel	GL 4 Glides ESD Easy Slide Disc - White Plastic SS Stainless Steel - add \$138 2C2G 2 Casters/2 Glides ESD Easy Slide Disc - White Plastic - add \$30 SS Stainless Steel - add \$100 4C 4 Casters - add \$67	NPU No Seating Power Unit PUL Power in the Front Left (as seated) P1 110 Plug Internal - add \$174 G Grey W White P2 USB A&C Internal - add \$310 G Grey W White PUR Power in the Front Right (as seated) P1 110 Plug Internal - add \$174 G Grey W White P2 USB A&C Internal - add \$310 G Grey W White PULR Power in the Front Left and Right (as seated) P1 110 Plug Internal - add \$348 G Grey W White P2 USB A&C Internal - add \$620 G Grey W White P3 110 Plug on Left & USB on Right Internal - add \$484 G Grey W White P4 USB on Left & 110 on Right Internal - add \$484 G Grey W White

Description + General Information

79 Sleep Sofa with Low Arm

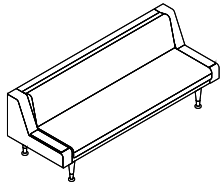

- clean out feature allows for easier cleaning between the back and the seat
- mechanism free fold down back easily converts sofa to sleep position
- under mount, tamper proof power available - order EC49 separately
- replacement parts available, starting on [pg 59](#)
- additional specs, [see pg 5](#)

Dimensions	D	W	H	Shipping	
Overall	32	89	32 ½	Ctn Wt	198
Seat	20	79	19 ¼	Cu Ft	75
Arm			18 ¾		

	Single Upholstery	Seat Zone 1	Back Zone 2	Frame Zone 3
COM Ydg	7 ½	2 ½	2 ¾	4
COL Sq Ft	135	45	50	72

Single Upholstery Specify: Model | Upholstery | Moisture Barrier | Arm Cap | Metal Frame Finish | Foot/Glide | Power

23SU79WLA														
	COM	COL	A	B	C	D	E	F	G	H	I	J	L1	L2
Single Uph	\$6,150	\$6,578	\$6,216	\$6,348	\$6,578	\$6,874	\$7,171	\$7,631	\$8,125	\$8,651	\$9,474	\$10,461	\$9,013	\$9,803

Multiple Upholstery Specify: Model | Seat Uph | Back Uph | Frame Uph | Moisture Barrier | Arm Cap | Metal Frame Finish | Foot/Glide | Power

23SU79WLA_M														
Base Price: \$6,150	To the Base Price, add the appropriate upcharges by grade, per zone													
	COM	COL	A	B	C	D	E	F	G	H	I	J	L1	L2
Seat - Zone 1	+\$0	+\$140	+\$22	+\$65	+\$140	+\$236	+\$333	+\$482	+\$643	+\$814	+\$1,082	+\$1,403	+\$932	+\$1,189
Back - Zone 2	+\$0	+\$147	+\$23	+\$68	+\$147	+\$248	+\$349	+\$506	+\$675	+\$854	+\$1,135	+\$1,472	+\$978	+\$1,247
Frame - Zone 3	+\$0	+\$222	+\$35	+\$103	+\$222	+\$376	+\$530	+\$769	+\$1,025	+\$1,298	+\$1,725	+\$2,236	+\$1,485	+\$1,895

Model	Upholstery	Moisture Barrier	Arm Cap	Metal Frame Finish	Foot/Glide	Power
	Grade Vendor Pattern Colorway	NMB No Moisture Barrier Seat MB1 Moisture Barrier Seat - add \$251	PAC Polyurethane Arm Cap Set 3LAC 3D Laminate Arm Cap Set - add \$228 BEL Belair FLO Florence Walnut PIL Pilsner PIN Pinnacle Walnut SAC Solid Surface Arm Set - add \$425	ASL Arctic Silver PEW Pewter SNK Soft Nickel	GL 4 Glides ESD Easy Slide Disc - White Plastic SS Stainless Steel - add \$138 2C2G 2 Casters/2 Glides ESD Easy Slide Disc - White Plastic - add \$30 SS Stainless Steel - add \$100 4C 4 Casters - add \$67	NPU No Seating Power Unit PUL Power in the Front Left (as seated) P1 110 Plug Internal - add \$174 G Grey W White P2 USB A&C Internal - add \$310 G Grey W White PUR Power in the Front Right (as seated) P1 110 Plug Internal - add \$174 G Grey W White P2 USB A&C Internal - add \$310 G Grey W White PULR Power in the Front Left and Right (as seated) P1 110 Plug Internal - add \$348 G Grey W White P2 USB A&C Internal - add \$620 G Grey W White P3 110 Plug on Left & USB on Right Internal - add \$484 G Grey W White P4 USB on Left & 110 on Right Internal - add \$484 G Grey W White

Description + General Information

80 Sleep Sofa with Low Arm

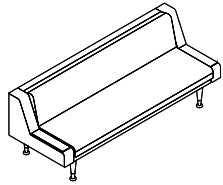

- clean out feature allows for easier cleaning between the back and the seat
- mechanism free fold down back easily converts sofa to sleep position
- under mount, tamper proof power available - order EC49 separately
- replacement parts available, starting on [pg 59](#)
- additional specs, [see pg 5](#)

Dimensions	D	W	H	Shipping	
Overall	32	90	32 ½	Ctn Wt	200
Seat	20	80	19 ¼	Cu Ft	76
Arm			18 ¾		

	Single Upholstery	Seat Zone 1	Back Zone 2	Frame Zone 3
COM Ydg	7 ½	2 ½	2 ¾	4
COL Sq Ft	135	45	50	72

Single Upholstery Specify: Model | Upholstery | Moisture Barrier | Metal Frame Finish | Foot/Glide | Power

23SU80WLA														
	COM	COL	A	B	C	D	E	F	G	H	I	J	L1	L2
Single Uph	\$6,163	\$6,591	\$6,229	\$6,360	\$6,591	\$6,887	\$7,183	\$7,643	\$8,137	\$8,663	\$9,486	\$10,473	\$9,025	\$9,815

Multiple Upholstery Specify: Model | Seat Uph | Back Uph | Frame Uph | Moisture Barrier | Metal Frame Finish | Foot/Glide | Power

23SU80WLA_M														
Base Price: \$6,163	To the Base Price, add the appropriate upcharges by grade, per zone													
	COM	COL	A	B	C	D	E	F	G	H	I	J	L1	L2
Seat - Zone 1	+\$0	+\$140	+\$22	+\$65	+\$140	+\$236	+\$332	+\$482	+\$643	+\$814	+\$1,082	+\$1,403	+\$932	+\$1,189
Back - Zone 2	+\$0	+\$147	+\$23	+\$68	+\$147	+\$248	+\$349	+\$506	+\$674	+\$854	+\$1,135	+\$1,472	+\$977	+\$1,247
Frame - Zone 3	+\$0	+\$222	+\$35	+\$103	+\$222	+\$376	+\$530	+\$768	+\$1,024	+\$1,297	+\$1,724	+\$2,236	+\$1,485	+\$1,895

Model	Upholstery	Moisture Barrier	Arm Cap	Metal Frame Finish	Foot/Glide	Power
	Grade Vendor Pattern Colorway	NMB No Moisture Barrier Seat MB1 Moisture Barrier Seat - add \$251	PAC Polyurethane Arm Cap Set 3LAC 3D Laminate Arm Cap Set - add \$228 BEL Belair FLO Florence Walnut PIL Pilsner PIN Pinnacle Walnut SAC Solid Surface Arm Set - add \$425	ASL Arctic Silver PEW Pewter SNK Soft Nickel	GL 4 Glides ESD Easy Slide Disc - White Plastic SS Stainless Steel - add \$138 2C2G 2 Casters/2 Glides ESD Easy Slide Disc - White Plastic - add \$30 SS Stainless Steel - add \$100 4C 4 Casters - add \$67	NPU No Seating Power Unit PUL Power in the Front Left (as seated) P1 110 Plug Internal - add \$174 G Grey W White P2 USB A&C Internal - add \$310 G Grey W White PUR Power in the Front Right (as seated) P1 110 Plug Internal - add \$174 G Grey W White P2 USB A&C Internal - add \$310 G Grey W White PULR Power in the Front Left and Right (as seated) P1 110 Plug Internal - add \$348 G Grey W White P2 USB A&C Internal - add \$620 G Grey W White P3 110 Plug on Left & USB on Right Internal - add \$484 G Grey W White P4 USB on Left & 110 on Right Internal - add \$484 G Grey W White

Description + General Information

68 Sleep Sofa with High Arm

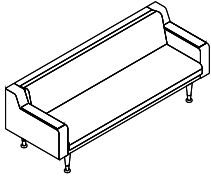

- clean out feature allows for easier cleaning between the back and the seat
- mechanism free fold down back easily converts sofa to sleep position
- under mount, tamper proof power available - order EC49 separately
- replacement parts available, starting on [pg 59](#)
- additional specs, [see pg 5](#)

Dimensions	D	W	H	Shipping	
Overall	32	78	32 ½	Ctn Wt	180
Seat	20	68	19 ¼	Cu Ft	64
Arm			26 ¼		

	Single Upholstery	Seat Zone 1	Back Zone 2	Frame Zone 3
COM Ydg	8 ¼	2 ½	2 ¾	4 ¾
COL Sq Ft	149	45	50	86

Single Upholstery Specify: Model | Upholstery | Moisture Barrier | Arm Cap | Metal Frame Finish | Foot/Glide | Power

23SU68WHA														
	COM	COL	A	B	C	D	E	F	G	H	I	J	L1	L2
Single Uph	\$6,071	\$6,542	\$6,144	\$6,289	\$6,542	\$6,868	\$7,193	\$7,700	\$8,243	\$8,822	\$9,727	\$10,812	\$9,220	\$10,089

Multiple Upholstery Specify: Model | Seat Uph | Back Uph | Frame Uph | Moisture Barrier | Arm Cap | Metal Frame Finish | Foot/Glide | Power

23SU68WHA_M														
Base Price: \$6,071	To the Base Price, add the appropriate upcharges by grade, per zone													
	COM	COL	A	B	C	D	E	F	G	H	I	J	L1	L2
Seat - Zone 1	+\$0	+\$140	+\$22	+\$65	+\$140	+\$236	+\$332	+\$482	+\$643	+\$814	+\$1,082	+\$1,403	+\$932	+\$1,189
Back - Zone 2	+\$0	+\$147	+\$23	+\$68	+\$147	+\$248	+\$349	+\$506	+\$674	+\$854	+\$1,135	+\$1,472	+\$978	+\$1,247
Frame - Zone 3	+\$0	+\$267	+\$42	+\$124	+\$267	+\$452	+\$636	+\$923	+\$1,230	+\$1,558	+\$2,070	+\$2,684	+\$1,783	+\$2,275

Model	Upholstery	Moisture Barrier	Arm Cap	Metal Frame Finish	Foot/Glide	Power
	Grade Vendor Pattern Colorway	NMB No Moisture Barrier Seat MB1 Moisture Barrier Seat - add \$251	PAC Polyurethane Arm Cap Set 3LAC 3D Laminate Arm Cap Set - add \$228 BEL Belair FLO Florence Walnut PIL Pilsner PIN Pinnacle Walnut SAC Solid Surface Arm Set - add \$425	ASL Arctic Silver PEW Pewter SNK Soft Nickel	GL 4 Glides ESD Easy Slide Disc - White Plastic SS Stainless Steel - add \$138 2C2G 2 Casters/2 Glides ESD Easy Slide Disc - White Plastic - add \$30 SS Stainless Steel - add \$100 4C 4 Casters - add \$67	NPU No Seating Power Unit PUL Power in the Front Left (as seated) P1 110 Plug Internal - add \$174 G Grey W White P2 USB A&C Internal - add \$310 G Grey W White PUR Power in the Front Right (as seated) P1 110 Plug Internal - add \$174 G Grey W White P2 USB A&C Internal - add \$310 G Grey W White PULR Power in the Front Left and Right (as seated) P1 110 Plug Internal - add \$348 G Grey W White P2 USB A&C Internal - add \$620 G Grey W White P3 110 Plug on Left & USB on Right Internal - add \$484 G Grey W White P4 USB on Left & 110 on Right Internal - add \$484 G Grey W White

Description + General Information

69 Sleep Sofa with High Arm

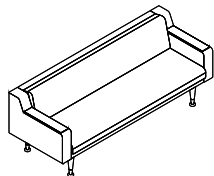

- clean out feature allows for easier cleaning between the back and the seat
- mechanism free fold down back easily converts sofa to sleep position
- under mount, tamper proof power available - order EC49 separately
- replacement parts available, starting on [pg 59](#)
- additional specs, [see pg 5](#)

Dimensions	D	W	H	Shipping	
Overall	32	79	32 ½	Ctn Wt	182
Seat	20	69	19 ¼	Cu Ft	65
Arm			26 ¼		

	Single Upholstery	Seat Zone 1	Back Zone 2	Frame Zone 3
COM Ydg	8 ¼	2 ½	2 ¾	4 ¾
COL Sq Ft	149	45	50	86

Single Upholstery Specify: Model | Upholstery | Moisture Barrier | Arm Cap | Metal Frame Finish | Foot/Glide | Power

23SU69WHA														
	COM	COL	A	B	C	D	E	F	G	H	I	J	L1	L2
Single Uph	\$6,083	\$6,554	\$6,156	\$6,301	\$6,554	\$6,880	\$7,206	\$7,712	\$8,255	\$8,834	\$9,739	\$10,825	\$9,232	\$10,101

Multiple Upholstery Specify: Model | Seat Uph | Back Uph | Frame Uph | Moisture Barrier | Arm Cap | Metal Frame Finish | Foot/Glide | Power

23SU69WHA_M														
Base Price: \$6,083	To the Base Price, add the appropriate upcharges by grade, per zone													
	COM	COL	A	B	C	D	E	F	G	H	I	J	L1	L2
Seat - Zone 1	+\$0	+\$140	+\$22	+\$65	+\$140	+\$236	+\$333	+\$482	+\$643	+\$814	+\$1,082	+\$1,403	+\$932	+\$1,189
Back - Zone 2	+\$0	+\$147	+\$23	+\$68	+\$147	+\$248	+\$349	+\$506	+\$674	+\$854	+\$1,135	+\$1,472	+\$978	+\$1,247
Frame - Zone 3	+\$0	+\$267	+\$42	+\$124	+\$267	+\$452	+\$636	+\$923	+\$1,230	+\$1,558	+\$2,070	+\$2,685	+\$1,783	+\$2,275

Model	Upholstery	Moisture Barrier	Arm Cap	Metal Frame Finish	Foot/Glide	Power
	Grade Vendor Pattern Colorway	NMB No Moisture Barrier Seat MB1 Moisture Barrier Seat - add \$251	PAC Polyurethane Arm Cap Set 3LAC 3D Laminate Arm Cap Set - add \$228 BEL Belair FLO Florence Walnut PIL Pilsner PIN Pinnacle Walnut SAC Solid Surface Arm Set - add \$425	ASL Arctic Silver PEW Pewter SNK Soft Nickel	GL 4 Glides ESD Easy Slide Disc - White Plastic SS Stainless Steel - add \$138 2C2G 2 Casters/2 Glides ESD Easy Slide Disc - White Plastic - add \$30 SS Stainless Steel - add \$100 4C 4 Casters - add \$67	NPU No Seating Power Unit PUL Power in the Front Left (as seated) P1 110 Plug Internal - add \$174 G Grey W White P2 USB A&C Internal - add \$310 G Grey W White PUR Power in the Front Right (as seated) P1 110 Plug Internal - add \$174 G Grey W White P2 USB A&C Internal - add \$310 G Grey W White PULR Power in the Front Left and Right (as seated) P1 110 Plug Internal - add \$348 G Grey W White P2 USB A&C Internal - add \$620 G Grey W White P3 110 Plug on Left & USB on Right Internal - add \$484 G Grey W White P4 USB on Left & 110 on Right Internal - add \$484 G Grey W White

Description + General Information

70 Sleep Sofa with High Arm

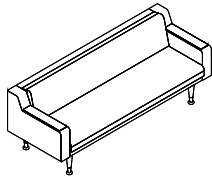

- clean out feature allows for easier cleaning between the back and the seat
- mechanism free fold down back easily converts sofa to sleep position
- under mount, tamper proof power available - order EC49 separately
- replacement parts available, starting on [pg 59](#)
- additional specs, [see pg 5](#)

Dimensions	D	W	H	Shipping	
Overall	32	80	32 ½	Ctn Wt	184
Seat	20	70	19 ¼	Cu Ft	66
Arm			26 ¼		

	Single Upholstery	Seat Zone 1	Back Zone 2	Frame Zone 3
COM Ydg	8 ¼	2 ½	2 ¾	4 ¾
COL Sq Ft	149	45	50	86

Single Upholstery Specify: Model | Upholstery | Moisture Barrier | Arm Cap | Metal Frame Finish | Foot/Glide | Power

23SU70WHA														
	COM	COL	A	B	C	D	E	F	G	H	I	J	L1	L2
Single Uph	\$6,096	\$6,566	\$6,168	\$6,313	\$6,566	\$6,892	\$7,218	\$7,724	\$8,267	\$8,846	\$9,751	\$10,837	\$9,244	\$10,113

Multiple Upholstery Specify: Model | Seat Uph | Back Uph | Frame Uph | Moisture Barrier | Arm Cap | Metal Frame Finish | Foot/Glide | Power

23SU70WHA_M														
Base Price: \$6,096	To the Base Price, add the appropriate upcharges by grade, per zone													
	COM	COL	A	B	C	D	E	F	G	H	I	J	L1	L2
Seat - Zone 1	+\$0	+\$140	+\$22	+\$65	+\$140	+\$236	+\$332	+\$482	+\$643	+\$814	+\$1,081	+\$1,403	+\$932	+\$1,189
Back - Zone 2	+\$0	+\$146	+\$23	+\$68	+\$146	+\$248	+\$349	+\$506	+\$674	+\$854	+\$1,135	+\$1,472	+\$977	+\$1,247
Frame - Zone 3	+\$0	+\$267	+\$41	+\$123	+\$267	+\$451	+\$636	+\$922	+\$1,229	+\$1,557	+\$2,069	+\$2,684	+\$1,782	+\$2,274

Model	Upholstery	Moisture Barrier	Arm Cap	Metal Frame Finish	Foot/Glide	Power
	Grade Vendor Pattern Colorway	NMB No Moisture Barrier Seat MB1 Moisture Barrier Seat - add \$251	PAC Polyurethane Arm Cap Set 3LAC 3D Laminate Arm Cap Set - add \$228 BEL Belair FLO Florence Walnut PIL Pilsner PIN Pinnacle Walnut SAC Solid Surface Arm Set - add \$425	ASL Arctic Silver PEW Pewter SNK Soft Nickel	GL 4 Glides ESD Easy Slide Disc - White Plastic SS Stainless Steel - add \$138 2C2G 2 Casters/2 Glides ESD Easy Slide Disc - White Plastic - add \$30 SS Stainless Steel - add \$100 4C 4 Casters - add \$67	NPU No Seating Power Unit PUL Power in the Front Left (as seated) P1 110 Plug Internal - add \$174 G Grey W White P2 USB A&C Internal - add \$310 G Grey W White PUR Power in the Front Right (as seated) P1 110 Plug Internal - add \$174 G Grey W White P2 USB A&C Internal - add \$310 G Grey W White PULR Power in the Front Left and Right (as seated) P1 110 Plug Internal - add \$348 G Grey W White P2 USB A&C Internal - add \$620 G Grey W White P3 110 Plug on Left & USB on Right Internal - add \$484 G Grey W White P4 USB on Left & 110 on Right Internal - add \$484 G Grey W White

Description + General Information

71 Sleep Sofa with High Arm

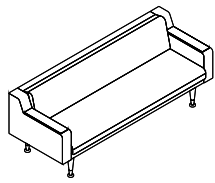

- clean out feature allows for easier cleaning between the back and the seat
- mechanism free fold down back easily converts sofa to sleep position
- under mount, tamper proof power available - order EC49 separately
- replacement parts available, starting on [pg 59](#)
- additional specs, [see pg 5](#)

Dimensions	D	W	H	Shipping	
Overall	32	81	32 ½	Ctn Wt	186
Seat	20	71	19 ¼	Cu Ft	67
Arm			26 ¼		

	Single Upholstery	Seat Zone 1	Back Zone 2	Frame Zone 3
COM Ydg	8 ¼	2 ½	2 ¾	4 ¾
COL Sq Ft	149	45	50	86

Single Upholstery Specify: Model | Upholstery | Moisture Barrier | Arm Cap | Metal Frame Finish | Foot/Glide | Power

23SU71WHA														
	COM	COL	A	B	C	D	E	F	G	H	I	J	L1	L2
Single Uph	\$6,108	\$6,579	\$6,180	\$6,325	\$6,579	\$6,904	\$7,230	\$7,737	\$8,279	\$8,858	\$9,763	\$10,849	\$9,257	\$10,125

Multiple Upholstery Specify: Model | Seat Uph | Back Uph | Frame Uph | Moisture Barrier | Arm Cap | Metal Frame Finish | Foot/Glide | Power

23SU71WHA_M														
Base Price: \$6,108	To the Base Price, add the appropriate upcharges by grade, per zone													
	COM	COL	A	B	C	D	E	F	G	H	I	J	L1	L2
Seat - Zone 1	+\$0	+\$140	+\$22	+\$65	+\$140	+\$236	+\$332	+\$482	+\$643	+\$814	+\$1,081	+\$1,403	+\$932	+\$1,189
Back - Zone 2	+\$0	+\$147	+\$23	+\$68	+\$147	+\$248	+\$349	+\$506	+\$674	+\$854	+\$1,135	+\$1,472	+\$978	+\$1,247
Frame - Zone 3	+\$0	+\$267	+\$41	+\$123	+\$267	+\$451	+\$636	+\$923	+\$1,229	+\$1,557	+\$2,069	+\$2,684	+\$1,783	+\$2,274

Model	Upholstery	Moisture Barrier	Arm Cap	Metal Frame Finish	Foot/Glide	Power
	Grade Vendor Pattern Colorway	NMB No Moisture Barrier Seat MB1 Moisture Barrier Seat - add \$251	PAC Polyurethane Arm Cap Set 3LAC 3D Laminate Arm Cap Set - add \$228 BEL Belair FLO Florence Walnut PIL Pilsner PIN Pinnacle Walnut SAC Solid Surface Arm Set - add \$425	ASL Arctic Silver PEW Pewter SNK Soft Nickel	GL 4 Glides ESD Easy Slide Disc - White Plastic SS Stainless Steel - add \$138 2C2G 2 Casters/2 Glides ESD Easy Slide Disc - White Plastic - add \$30 SS Stainless Steel - add \$100 4C 4 Casters - add \$67	NPU No Seating Power Unit PUL Power in the Front Left (as seated) P1 110 Plug Internal - add \$174 G Grey W White P2 USB A&C Internal - add \$310 G Grey W White PUR Power in the Front Right (as seated) P1 110 Plug Internal - add \$174 G Grey W White P2 USB A&C Internal - add \$310 G Grey W White PULR Power in the Front Left and Right (as seated) P1 110 Plug Internal - add \$348 G Grey W White P2 USB A&C Internal - add \$620 G Grey W White P3 110 Plug on Left & USB on Right Internal - add \$484 G Grey W White P4 USB on Left & 110 on Right Internal - add \$484 G Grey W White

Description + General Information

72 Sleep Sofa with High Arm

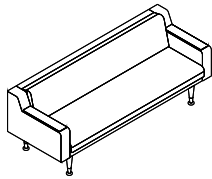

- clean out feature allows for easier cleaning between the back and the seat
- mechanism free fold down back easily converts sofa to sleep position
- under mount, tamper proof power available - order EC49 separately
- replacement parts available, starting on [pg 59](#)
- additional specs, [see pg 5](#)

Dimensions	D	W	H	Shipping	
Overall	32	82	32 ½	Ctn Wt	188
Seat	20	72	19 ¼	Cu Ft	68
Arm			26 ¼		

	Single Upholstery	Seat Zone 1	Back Zone 2	Frame Zone 3
COM Ydg	8 ¼	2 ½	2 ¾	4 ¾
COL Sq Ft	149	45	50	86

Single Upholstery Specify: Model | Upholstery | Moisture Barrier | Arm Cap | Metal Frame Finish | Foot/Glide | Power

23SU72WHA														
	COM	COL	A	B	C	D	E	F	G	H	I	J	L1	L2
Single Uph	\$6,120	\$6,591	\$6,193	\$6,337	\$6,591	\$6,917	\$7,242	\$7,749	\$8,292	\$8,871	\$9,776	\$10,861	\$9,269	\$10,137

Multiple Upholstery Specify: Model | Seat Uph | Back Uph | Frame Uph | Moisture Barrier | Arm Cap | Metal Frame Finish | Foot/Glide | Power

23SU72WHA_M														
Base Price: \$6,120	To the Base Price, add the appropriate upcharges by grade, per zone													
	COM	COL	A	B	C	D	E	F	G	H	I	J	L1	L2
Seat - Zone 1	+\$0	+\$140	+\$22	+\$65	+\$140	+\$236	+\$332	+\$482	+\$643	+\$814	+\$1,082	+\$1,403	+\$932	+\$1,189
Back - Zone 2	+\$0	+\$147	+\$23	+\$68	+\$147	+\$248	+\$349	+\$506	+\$674	+\$854	+\$1,135	+\$1,472	+\$978	+\$1,247
Frame - Zone 3	+\$0	+\$267	+\$42	+\$123	+\$267	+\$452	+\$636	+\$923	+\$1,230	+\$1,558	+\$2,070	+\$2,684	+\$1,783	+\$2,274

Model	Upholstery	Moisture Barrier	Arm Cap	Metal Frame Finish	Foot/Glide	Power
	Grade Vendor Pattern Colorway	NMB No Moisture Barrier Seat MB1 Moisture Barrier Seat - add \$251	PAC Polyurethane Arm Cap Set 3LAC 3D Laminate Arm Cap Set - add \$228 BEL Belair FLO Florence Walnut PIL Pilsner PIN Pinnacle Walnut SAC Solid Surface Arm Set - add \$425	ASL Arctic Silver PEW Pewter SNK Soft Nickel	GL 4 Glides ESD Easy Slide Disc - White Plastic SS Stainless Steel - add \$138 2C2G 2 Casters/2 Glides ESD Easy Slide Disc - White Plastic - add \$30 SS Stainless Steel - add \$100 4C 4 Casters - add \$67	NPU No Seating Power Unit PUL Power in the Front Left (as seated) P1 110 Plug Internal - add \$174 G Grey W White P2 USB A&C Internal - add \$310 G Grey W White PUR Power in the Front Right (as seated) P1 110 Plug Internal - add \$174 G Grey W White P2 USB A&C Internal - add \$310 G Grey W White PULR Power in the Front Left and Right (as seated) P1 110 Plug Internal - add \$348 G Grey W White P2 USB A&C Internal - add \$620 G Grey W White P3 110 Plug on Left & USB on Right Internal - add \$484 G Grey W White P4 USB on Left & 110 on Right Internal - add \$484 G Grey W White

Description + General Information

73 Sleep Sofa with High Arm

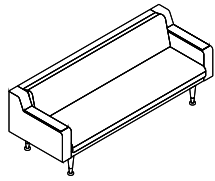

- clean out feature allows for easier cleaning between the back and the seat
- mechanism free fold down back easily converts sofa to sleep position
- under mount, tamper proof power available - order EC49 separately
- replacement parts available, starting on [pg 59](#)
- additional specs, [see pg 5](#)

Dimensions	D	W	H	Shipping	
Overall	32	83	32 ½	Ctn Wt	190
Seat	20	73	19 ¼	Cu Ft	69
Arm			26 ¼		

	Single Upholstery	Seat Zone 1	Back Zone 2	Frame Zone 3
COM Ydg	8 ¼	2 ½	2 ¾	4 ¾
COL Sq Ft	149	45	50	86

Single Upholstery Specify: Model | Upholstery | Moisture Barrier | Arm Cap | Metal Frame Finish | Foot/Glide | Power

23SU73WHA														
	COM	COL	A	B	C	D	E	F	G	H	I	J	L1	L2
Single Uph	\$6,132	\$6,603	\$6,205	\$6,350	\$6,603	\$6,929	\$7,254	\$7,761	\$8,304	\$8,883	\$9,788	\$10,873	\$9,281	\$10,150

Multiple Upholstery Specify: Model | Seat Uph | Back Uph | Frame Uph | Moisture Barrier | Arm Cap | Metal Frame Finish | Foot/Glide | Power

23SU73WHA_M														
Base Price: \$6,132	To the Base Price, add the appropriate upcharges by grade, per zone													
	COM	COL	A	B	C	D	E	F	G	H	I	J	L1	L2
Seat - Zone 1	+\$0	+\$140	+\$22	+\$65	+\$140	+\$236	+\$332	+\$482	+\$643	+\$814	+\$1,082	+\$1,403	+\$932	+\$1,189
Back - Zone 2	+\$0	+\$147	+\$23	+\$68	+\$147	+\$248	+\$349	+\$506	+\$674	+\$854	+\$1,135	+\$1,472	+\$978	+\$1,247
Frame - Zone 3	+\$0	+\$267	+\$42	+\$124	+\$267	+\$452	+\$636	+\$923	+\$1,230	+\$1,558	+\$2,070	+\$2,684	+\$1,783	+\$2,275

Model	Upholstery	Moisture Barrier	Arm Cap	Metal Frame Finish	Foot/Glide	Power
	Grade Vendor Pattern Colorway	NMB No Moisture Barrier Seat MB1 Moisture Barrier Seat - add \$251	PAC Polyurethane Arm Cap Set 3LAC 3D Laminate Arm Cap Set - add \$228 BEL Belair FLO Florence Walnut PIL Pilsner PIN Pinnacle Walnut SAC Solid Surface Arm Set - add \$425	ASL Arctic Silver PEW Pewter SNK Soft Nickel	GL 4 Glides ESD Easy Slide Disc - White Plastic SS Stainless Steel - add \$138 2C2G 2 Casters/2 Glides ESD Easy Slide Disc - White Plastic - add \$30 SS Stainless Steel - add \$100 4C 4 Casters - add \$67	NPU No Seating Power Unit PUL Power in the Front Left (as seated) P1 110 Plug Internal - add \$174 G Grey W White P2 USB A&C Internal - add \$310 G Grey W White PUR Power in the Front Right (as seated) P1 110 Plug Internal - add \$174 G Grey W White P2 USB A&C Internal - add \$310 G Grey W White PULR Power in the Front Left and Right (as seated) P1 110 Plug Internal - add \$348 G Grey W White P2 USB A&C Internal - add \$620 G Grey W White P3 110 Plug on Left & USB on Right Internal - add \$484 G Grey W White P4 USB on Left & 110 on Right Internal - add \$484 G Grey W White

Description + General Information

74 Sleep Sofa with High Arm

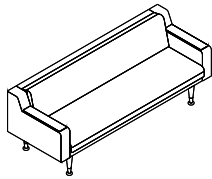

- clean out feature allows for easier cleaning between the back and the seat
- mechanism free fold down back easily converts sofa to sleep position
- under mount, tamper proof power available - order EC49 separately
- replacement parts available, starting on [pg 59](#)
- additional specs, [see pg 5](#)

Dimensions	D	W	H	Shipping	
Overall	32	84	32 ½	Ctn Wt	192
Seat	20	74	19 ¼	Cu Ft	70
Arm			26 ¼		

	Single Upholstery	Seat Zone 1	Back Zone 2	Frame Zone 3
COM Ydg	8 ¼	2 ½	2 ¾	4 ¾
COL Sq Ft	149	45	50	86

Single Upholstery Specify: Model | Upholstery | Moisture Barrier | Arm Cap | Metal Frame Finish | Foot/Glide | Power

23SU74WHA														
	COM	COL	A	B	C	D	E	F	G	H	I	J	L1	L2
Single Uph	\$6,144	\$6,615	\$6,217	\$6,362	\$6,615	\$6,941	\$7,267	\$7,773	\$8,316	\$8,895	\$9,800	\$10,886	\$9,293	\$10,162

Multiple Upholstery Specify: Model | Seat Uph | Back Uph | Frame Uph | Moisture Barrier | Arm Cap | Metal Frame Finish | Foot/Glide | Power

23SU74WHA_M														
Base Price: \$6,144	To the Base Price, add the appropriate upcharges by grade, per zone													
	COM	COL	A	B	C	D	E	F	G	H	I	J	L1	L2
Seat - Zone 1	+\$0	+\$140	+\$22	+\$65	+\$140	+\$236	+\$333	+\$482	+\$643	+\$814	+\$1,082	+\$1,403	+\$932	+\$1,189
Back - Zone 2	+\$0	+\$147	+\$23	+\$68	+\$147	+\$248	+\$349	+\$506	+\$674	+\$854	+\$1,135	+\$1,472	+\$978	+\$1,247
Frame - Zone 3	+\$0	+\$267	+\$42	+\$124	+\$267	+\$452	+\$636	+\$923	+\$1,230	+\$1,558	+\$2,070	+\$2,685	+\$1,783	+\$2,275

Model	Upholstery	Moisture Barrier	Arm Cap	Metal Frame Finish	Foot/Glide	Power
	Grade Vendor Pattern Colorway	NMB No Moisture Barrier Seat MB1 Moisture Barrier Seat - add \$251	PAC Polyurethane Arm Cap Set 3LAC 3D Laminate Arm Cap Set - add \$228 BEL Belair FLO Florence Walnut PIL Pilsner PIN Pinnacle Walnut SAC Solid Surface Arm Set - add \$425	ASL Arctic Silver PEW Pewter SNK Soft Nickel	GL 4 Glides ESD Easy Slide Disc - White Plastic SS Stainless Steel - add \$138 2C2G 2 Casters/2 Glides ESD Easy Slide Disc - White Plastic - add \$30 SS Stainless Steel - add \$100 4C 4 Casters - add \$67	NPU No Seating Power Unit PUL Power in the Front Left (as seated) P1 110 Plug Internal - add \$174 G Grey W White P2 USB A&C Internal - add \$310 G Grey W White PUR Power in the Front Right (as seated) P1 110 Plug Internal - add \$174 G Grey W White P2 USB A&C Internal - add \$310 G Grey W White PULR Power in the Front Left and Right (as seated) P1 110 Plug Internal - add \$348 G Grey W White P2 USB A&C Internal - add \$620 G Grey W White P3 110 Plug on Left & USB on Right Internal - add \$484 G Grey W White P4 USB on Left & 110 on Right Internal - add \$484 G Grey W White

Description + General Information

75 Sleep Sofa with High Arm

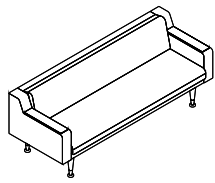

- clean out feature allows for easier cleaning between the back and the seat
- mechanism free fold down back easily converts sofa to sleep position
- under mount, tamper proof power available - order EC49 separately
- replacement parts available, starting on [pg 59](#)
- additional specs, [see pg 5](#)

Dimensions	D	W	H	Shipping	
Overall	32	85	32 ½	Ctn Wt	194
Seat	20	75	19 ¼	Cu Ft	71
Arm			26 ¼		

	Single Upholstery	Seat Zone 1	Back Zone 2	Frame Zone 3
COM Ydg	8 ¼	2 ½	2 ¾	4 ¾
COL Sq Ft	149	45	50	86

Single Upholstery Specify: Model | Upholstery | Moisture Barrier | Arm Cap | Metal Frame Finish | Foot/Glide | Power

23SU75WHA														
	COM	COL	A	B	C	D	E	F	G	H	I	J	L1	L2
Single Uph	\$6,156	\$6,627	\$6,229	\$6,374	\$6,627	\$6,953	\$7,279	\$7,785	\$8,328	\$8,907	\$9,812	\$10,898	\$9,305	\$10,174

Multiple Upholstery Specify: Model | Seat Uph | Back Uph | Frame Uph | Moisture Barrier | Arm Cap | Metal Frame Finish | Foot/Glide | Power

23SU75WHA_M														
Base Price: \$6,156	To the Base Price, add the appropriate upcharges by grade, per zone													
	COM	COL	A	B	C	D	E	F	G	H	I	J	L1	L2
Seat - Zone 1	+\$0	+\$140	+\$22	+\$65	+\$140	+\$236	+\$333	+\$482	+\$643	+\$814	+\$1,082	+\$1,403	+\$932	+\$1,189
Back - Zone 2	+\$0	+\$147	+\$23	+\$68	+\$147	+\$248	+\$349	+\$506	+\$674	+\$854	+\$1,135	+\$1,472	+\$978	+\$1,247
Frame - Zone 3	+\$0	+\$267	+\$42	+\$124	+\$267	+\$452	+\$636	+\$923	+\$1,230	+\$1,558	+\$2,070	+\$2,685	+\$1,783	+\$2,275

Model	Upholstery	Moisture Barrier	Arm Cap	Metal Frame Finish	Foot/Glide	Power
	Grade Vendor Pattern Colorway	NMB No Moisture Barrier Seat MB1 Moisture Barrier Seat - add \$251	PAC Polyurethane Arm Cap Set 3LAC 3D Laminate Arm Cap Set - add \$228 BEL Belair FLO Florence Walnut PIL Pilsner PIN Pinnacle Walnut SAC Solid Surface Arm Set - add \$425	ASL Arctic Silver PEW Pewter SNK Soft Nickel	GL 4 Glides ESD Easy Slide Disc - White Plastic SS Stainless Steel - add \$138 2C2G 2 Casters/2 Glides ESD Easy Slide Disc - White Plastic - add \$30 SS Stainless Steel - add \$100 4C 4 Casters - add \$67	NPU No Seating Power Unit PUL Power in the Front Left (as seated) P1 110 Plug Internal - add \$174 G Grey W White P2 USB A&C Internal - add \$310 G Grey W White PUR Power in the Front Right (as seated) P1 110 Plug Internal - add \$174 G Grey W White P2 USB A&C Internal - add \$310 G Grey W White PULR Power in the Front Left and Right (as seated) P1 110 Plug Internal - add \$348 G Grey W White P2 USB A&C Internal - add \$620 G Grey W White P3 110 Plug on Left & USB on Right Internal - add \$484 G Grey W White P4 USB on Left & 110 on Right Internal - add \$484 G Grey W White

Description + General Information

76 Sleep Sofa with High Arm

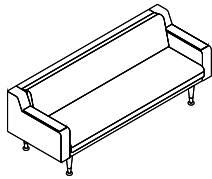

- clean out feature allows for easier cleaning between the back and the seat
- mechanism free fold down back easily converts sofa to sleep position
- under mount, tamper proof power available - order EC49 separately
- replacement parts available, starting on [pg 59](#)
- additional specs, [see pg 5](#)

Dimensions	D	W	H	Shipping	
Overall	32	86	32 ½	Ctn Wt	196
Seat	20	76	19 ¼	Cu Ft	72
Arm			26 ¼		

	Single Upholstery	Seat Zone 1	Back Zone 2	Frame Zone 3
COM Ydg	8 ¼	2 ½	2 ¾	4 ¾
COL Sq Ft	149	45	50	86

Single Upholstery Specify: Model | Upholstery | Moisture Barrier | Arm Cap | Metal Frame Finish | Foot/Glide | Power

23SU76WHA														
	COM	COL	A	B	C	D	E	F	G	H	I	J	L1	L2
Single Uph	\$6,168	\$6,639	\$6,241	\$6,386	\$6,639	\$6,965	\$7,291	\$7,797	\$8,340	\$8,919	\$9,824	\$10,910	\$9,317	\$10,186

Multiple Upholstery Specify: Model | Seat Uph | Back Uph | Frame Uph | Moisture Barrier | Arm Cap | Metal Frame Finish | Foot/Glide | Power

23SU76WHA_M														
Base Price: \$6,168	To the Base Price, add the appropriate upcharges by grade, per zone													
	COM	COL	A	B	C	D	E	F	G	H	I	J	L1	L2
Seat - Zone 1	+\$0	+\$140	+\$22	+\$65	+\$140	+\$236	+\$333	+\$482	+\$643	+\$814	+\$1,082	+\$1,403	+\$932	+\$1,189
Back - Zone 2	+\$0	+\$147	+\$23	+\$68	+\$147	+\$248	+\$349	+\$506	+\$674	+\$854	+\$1,135	+\$1,472	+\$978	+\$1,247
Frame - Zone 3	+\$0	+\$267	+\$42	+\$124	+\$267	+\$452	+\$636	+\$923	+\$1,230	+\$1,558	+\$2,070	+\$2,685	+\$1,783	+\$2,275

Model	Upholstery	Moisture Barrier	Arm Cap	Metal Frame Finish	Foot/Glide	Power
	Grade Vendor Pattern Colorway	NMB No Moisture Barrier Seat MB1 Moisture Barrier Seat - add \$251	PAC Polyurethane Arm Cap Set 3LAC 3D Laminate Arm Cap Set - add \$228 BEL Belair FLO Florence Walnut PIL Pilsner PIN Pinnacle Walnut SAC Solid Surface Arm Set - add \$425	ASL Arctic Silver PEW Pewter SNK Soft Nickel	GL 4 Glides ESD Easy Slide Disc - White Plastic SS Stainless Steel - add \$138 2C2G 2 Casters/2 Glides ESD Easy Slide Disc - White Plastic - add \$30 SS Stainless Steel - add \$100 4C 4 Casters - add \$67	NPU No Seating Power Unit PUL Power in the Front Left (as seated) P1 110 Plug Internal - add \$174 G Grey W White P2 USB A&C Internal - add \$310 G Grey W White PUR Power in the Front Right (as seated) P1 110 Plug Internal - add \$174 G Grey W White P2 USB A&C Internal - add \$310 G Grey W White PULR Power in the Front Left and Right (as seated) P1 110 Plug Internal - add \$348 G Grey W White P2 USB A&C Internal - add \$620 G Grey W White P3 110 Plug on Left & USB on Right Internal - add \$484 G Grey W White P4 USB on Left & 110 on Right Internal - add \$484 G Grey W White

Description + General Information

77 Sleep Sofa with High Arm

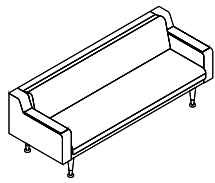

- clean out feature allows for easier cleaning between the back and the seat
- mechanism free fold down back easily converts sofa to sleep position
- under mount, tamper proof power available - order EC49 separately
- replacement parts available, starting on [pg 59](#)
- additional specs, [see pg 5](#)

Dimensions	D	W	H	Shipping	
Overall	32	87	32 ½	Ctn Wt	198
Seat	20	77	19 ¼	Cu Ft	73
Arm			26 ¼		

	Single Upholstery	Seat Zone 1	Back Zone 2	Frame Zone 3
COM Ydg	8 ¼	2 ½	2 ¾	4 ¾
COL Sq Ft	149	45	50	86

Single Upholstery Specify: Model | Upholstery | Moisture Barrier | Arm Cap | Metal Frame Finish | Foot/Glide | Power

23SU77WHA														
	COM	COL	A	B	C	D	E	F	G	H	I	J	L1	L2
Single Uph	\$6,181	\$6,651	\$6,253	\$6,398	\$6,651	\$6,977	\$7,303	\$7,810	\$8,352	\$8,931	\$9,836	\$10,922	\$9,330	\$10,198

Multiple Upholstery Specify: Model | Seat Uph | Back Uph | Frame Uph | Moisture Barrier | Arm Cap | Metal Frame Finish | Foot/Glide | Power

23SU77WHA_M														
Base Price: \$6,181	To the Base Price, add the appropriate upcharges by grade, per zone													
	COM	COL	A	B	C	D	E	F	G	H	I	J	L1	L2
Seat - Zone 1	+\$0	+\$140	+\$22	+\$65	+\$140	+\$236	+\$332	+\$482	+\$643	+\$814	+\$1,081	+\$1,403	+\$932	+\$1,189
Back - Zone 2	+\$0	+\$146	+\$23	+\$68	+\$146	+\$248	+\$349	+\$506	+\$674	+\$854	+\$1,135	+\$1,472	+\$978	+\$1,247
Frame - Zone 3	+\$0	+\$267	+\$41	+\$123	+\$267	+\$451	+\$636	+\$923	+\$1,229	+\$1,557	+\$2,069	+\$2,684	+\$1,783	+\$2,274

Model	Upholstery	Moisture Barrier	Arm Cap	Metal Frame Finish	Foot/Glide	Power
	Grade Vendor Pattern Colorway	NMB No Moisture Barrier Seat MB1 Moisture Barrier Seat - add \$251	PAC Polyurethane Arm Cap Set 3LAC 3D Laminate Arm Cap Set - add \$228 BEL Belair FLO Florence Walnut PIL Pilsner PIN Pinnacle Walnut SAC Solid Surface Arm Set - add \$425	ASL Arctic Silver PEW Pewter SNK Soft Nickel	GL 4 Glides ESD Easy Slide Disc - White Plastic SS Stainless Steel - add \$138 2C2G 2 Casters/2 Glides ESD Easy Slide Disc - White Plastic - add \$30 SS Stainless Steel - add \$100 4C 4 Casters - add \$67	NPU No Seating Power Unit PUL Power in the Front Left (as seated) P1 110 Plug Internal - add \$174 G Grey W White P2 USB A&C Internal - add \$310 G Grey W White PUR Power in the Front Right (as seated) P1 110 Plug Internal - add \$174 G Grey W White P2 USB A&C Internal - add \$310 G Grey W White PULR Power in the Front Left and Right (as seated) P1 110 Plug Internal - add \$348 G Grey W White P2 USB A&C Internal - add \$620 G Grey W White P3 110 Plug on Left & USB on Right Internal - add \$484 G Grey W White P4 USB on Left & 110 on Right Internal - add \$484 G Grey W White

Description + General Information

78 Sleep Sofa with High Arm

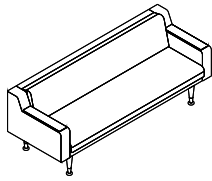

- clean out feature allows for easier cleaning between the back and the seat
- mechanism free fold down back easily converts sofa to sleep position
- under mount, tamper proof power available - order EC49 separately
- replacement parts available, starting on [pg 59](#)
- additional specs, [see pg 5](#)

Dimensions	D	W	H	Shipping	
Overall	32	88	32 ½	Ctn Wt	200
Seat	20	78	19 ¼	Cu Ft	74
Arm			26 ¼		

	Single Upholstery	Seat Zone 1	Back Zone 2	Frame Zone 3
COM Ydg	8 ¼	2 ½	2 ¾	4 ¾
COL Sq Ft	149	45	50	86

Single Upholstery Specify: Model | Upholstery | Moisture Barrier | Arm Cap | Metal Frame Finish | Foot/Glide | Power

23SU78WHA														
	COM	COL	A	B	C	D	E	F	G	H	I	J	L1	L2
Single Uph	\$6,193	\$6,664	\$6,266	\$6,410	\$6,664	\$6,989	\$7,315	\$7,822	\$8,365	\$8,944	\$9,848	\$10,934	\$9,342	\$10,210

Multiple Upholstery Specify: Model | Seat Uph | Back Uph | Frame Uph | Moisture Barrier | Arm Cap | Metal Frame Finish | Foot/Glide | Power

23SU78WHA_M														
Base Price: \$6,193	To the Base Price, add the appropriate upcharges by grade, per zone													
	COM	COL	A	B	C	D	E	F	G	H	I	J	L1	L2
Seat - Zone 1	+\$0	+\$140	+\$22	+\$65	+\$140	+\$236	+\$332	+\$482	+\$643	+\$814	+\$1,081	+\$1,403	+\$932	+\$1,189
Back - Zone 2	+\$0	+\$147	+\$23	+\$68	+\$147	+\$248	+\$349	+\$506	+\$674	+\$854	+\$1,135	+\$1,472	+\$978	+\$1,247
Frame - Zone 3	+\$0	+\$267	+\$42	+\$123	+\$267	+\$451	+\$636	+\$923	+\$1,230	+\$1,558	+\$2,069	+\$2,684	+\$1,783	+\$2,274

Model	Upholstery	Moisture Barrier	Arm Cap	Metal Frame Finish	Foot/Glide	Power
	Grade Vendor Pattern Colorway	NMB No Moisture Barrier Seat MB1 Moisture Barrier Seat - add \$251	PAC Polyurethane Arm Cap Set 3LAC 3D Laminate Arm Cap Set - add \$228 BEL Belair FLO Florence Walnut PIL Pilsner PIN Pinnacle Walnut SAC Solid Surface Arm Set - add \$425	ASL Arctic Silver PEW Pewter SNK Soft Nickel	GL 4 Glides ESD Easy Slide Disc - White Plastic SS Stainless Steel - add \$138 2C2G 2 Casters/2 Glides ESD Easy Slide Disc - White Plastic - add \$30 SS Stainless Steel - add \$100 4C 4 Casters - add \$67	NPU No Seating Power Unit PUL Power in the Front Left (as seated) P1 110 Plug Internal - add \$174 G Grey W White P2 USB A&C Internal - add \$310 G Grey W White PUR Power in the Front Right (as seated) P1 110 Plug Internal - add \$174 G Grey W White P2 USB A&C Internal - add \$310 G Grey W White PULR Power in the Front Left and Right (as seated) P1 110 Plug Internal - add \$348 G Grey W White P2 USB A&C Internal - add \$620 G Grey W White P3 110 Plug on Left & USB on Right Internal - add \$484 G Grey W White P4 USB on Left & 110 on Right Internal - add \$484 G Grey W White

Description + General Information

79 Sleep Sofa with High Arm

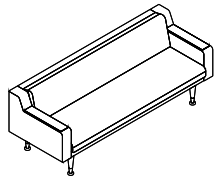

- clean out feature allows for easier cleaning between the back and the seat
- mechanism free fold down back easily converts sofa to sleep position
- under mount, tamper proof power available - order EC49 separately
- replacement parts available, starting on [pg 59](#)
- additional specs, [see pg 5](#)

Dimensions	D	W	H	Shipping	
Overall	32	89	32 ½	Ctn Wt	202
Seat	20	79	19 ¼	Cu Ft	75
Arm			26 ¼		

	Single Upholstery	Seat Zone 1	Back Zone 2	Frame Zone 3
COM Ydg	8 ¼	2 ½	2 ¾	4 ¾
COL Sq Ft	149	45	50	86

Single Upholstery Specify: Model | Upholstery | Moisture Barrier | Arm Cap | Metal Frame Finish | Foot/Glide | Power

23SU79WHA														
	COM	COL	A	B	C	D	E	F	G	H	I	J	L1	L2
Single Uph	\$6,205	\$6,676	\$6,278	\$6,422	\$6,676	\$7,002	\$7,327	\$7,834	\$8,377	\$8,956	\$9,861	\$10,946	\$9,354	\$10,222

Multiple Upholstery Specify: Model | Seat Uph | Back Uph | Frame Uph | Moisture Barrier | Arm Cap | Metal Frame Finish | Foot/Glide | Power

23SU79WHA_M														
Base Price: \$6,205	To the Base Price, add the appropriate upcharges by grade, per zone													
	COM	COL	A	B	C	D	E	F	G	H	I	J	L1	L2
Seat - Zone 1	+\$0	+\$140	+\$22	+\$65	+\$140	+\$236	+\$332	+\$482	+\$643	+\$814	+\$1,082	+\$1,403	+\$932	+\$1,189
Back - Zone 2	+\$0	+\$147	+\$23	+\$68	+\$147	+\$248	+\$349	+\$506	+\$674	+\$854	+\$1,135	+\$1,472	+\$978	+\$1,247
Frame - Zone 3	+\$0	+\$267	+\$42	+\$123	+\$267	+\$452	+\$636	+\$923	+\$1,230	+\$1,558	+\$2,070	+\$2,684	+\$1,783	+\$2,274

Model	Upholstery	Moisture Barrier	Arm Cap	Metal Frame Finish	Foot/Glide	Power
	Grade Vendor Pattern Colorway	NMB No Moisture Barrier Seat MB1 Moisture Barrier Seat - add \$251	PAC Polyurethane Arm Cap Set 3LAC 3D Laminate Arm Cap Set - add \$228 BEL Belair FLO Florence Walnut PIL Pilsner PIN Pinnacle Walnut SAC Solid Surface Arm Set - add \$425	ASL Arctic Silver PEW Pewter SNK Soft Nickel	GL 4 Glides ESD Easy Slide Disc - White Plastic SS Stainless Steel - add \$138 2C2G 2 Casters/2 Glides ESD Easy Slide Disc - White Plastic - add \$30 SS Stainless Steel - add \$100 4C 4 Casters - add \$67	NPU No Seating Power Unit PUL Power in the Front Left (as seated) P1 110 Plug Internal - add \$174 G Grey W White P2 USB A&C Internal - add \$310 G Grey W White PUR Power in the Front Right (as seated) P1 110 Plug Internal - add \$174 G Grey W White P2 USB A&C Internal - add \$310 G Grey W White PULR Power in the Front Left and Right (as seated) P1 110 Plug Internal - add \$348 G Grey W White P2 USB A&C Internal - add \$620 G Grey W White P3 110 Plug on Left & USB on Right Internal - add \$484 G Grey W White P4 USB on Left & 110 on Right Internal - add \$484 G Grey W White

Description + General Information

80 Sleep Sofa with High Arm

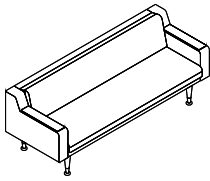

- clean out feature allows for easier cleaning between the back and the seat
- mechanism free fold down back easily converts sofa to sleep position
- under mount, tamper proof power available - order EC49 separately
- replacement parts available, starting on [pg 59](#)
- additional specs, [see pg 5](#)

Dimensions	D	W	H	Shipping	
Overall	32	90	32 ½	Ctn Wt	204
Seat	20	80	19 ¼	Cu Ft	76
Arm			26 ¼		

	Single Upholstery	Seat Zone 1	Back Zone 2	Frame Zone 3
COM Ydg	8 ¼	2 ½	2 ¾	4 ¾
COL Sq Ft	149	45	50	86

Single Upholstery Specify: Model | Upholstery | Moisture Barrier | Arm Cap | Metal Frame Finish | Foot/Glide | Power

23SU80WHA														
	COM	COL	A	B	C	D	E	F	G	H	I	J	L1	L2
Single Uph	\$6,217	\$6,688	\$6,290	\$6,435	\$6,688	\$7,014	\$7,339	\$7,846	\$8,389	\$8,968	\$9,873	\$10,958	\$9,366	\$10,235

Multiple Upholstery Specify: Model | Seat Uph | Back Uph | Frame Uph | Moisture Barrier | Arm Cap | Metal Frame Finish | Foot/Glide | Power

23SU80WHA_M														
Base Price: \$6,217	To the Base Price, add the appropriate upcharges by grade, per zone													
	COM	COL	A	B	C	D	E	F	G	H	I	J	L1	L2
Seat - Zone 1	+\$0	+\$140	+\$22	+\$65	+\$140	+\$236	+\$332	+\$482	+\$643	+\$814	+\$1,082	+\$1,403	+\$932	+\$1,189
Back - Zone 2	+\$0	+\$147	+\$23	+\$68	+\$147	+\$248	+\$349	+\$506	+\$674	+\$854	+\$1,135	+\$1,472	+\$978	+\$1,247
Frame - Zone 3	+\$0	+\$267	+\$42	+\$124	+\$267	+\$452	+\$636	+\$923	+\$1,230	+\$1,558	+\$2,070	+\$2,684	+\$1,783	+\$2,275

Model	Upholstery	Moisture Barrier	Arm Cap	Metal Frame Finish	Foot/Glide	Power
	Grade Vendor Pattern Colorway	NMB No Moisture Barrier Seat MB1 Moisture Barrier Seat - add \$251	PAC Polyurethane Arm Cap Set 3LAC 3D Laminate Arm Cap Set - add \$228 BEL Belair FLO Florence Walnut PIL Pilsner PIN Pinnacle Walnut SAC Solid Surface Arm Set - add \$425	ASL Arctic Silver PEW Pewter SNK Soft Nickel	GL 4 Glides ESD Easy Slide Disc - White Plastic SS Stainless Steel - add \$138 2C2G 2 Casters/2 Glides ESD Easy Slide Disc - White Plastic - add \$30 SS Stainless Steel - add \$100 4C 4 Casters - add \$67	NPU No Seating Power Unit PUL Power in the Front Left (as seated) P1 110 Plug Internal - add \$174 G Grey W White P2 USB A&C Internal - add \$310 G Grey W White PUR Power in the Front Right (as seated) P1 110 Plug Internal - add \$174 G Grey W White P2 USB A&C Internal - add \$310 G Grey W White PULR Power in the Front Left and Right (as seated) P1 110 Plug Internal - add \$348 G Grey W White P2 USB A&C Internal - add \$620 G Grey W White P3 110 Plug on Left & USB on Right Internal - add \$484 G Grey W White P4 USB on Left & 110 on Right Internal - add \$484 G Grey W White

Description	D	W	H	CTN WT	CU FT	① Model	List Price
Under Mount Electrical	4½	4	2¾	3	1	EC49	\$440

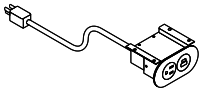

- tamper proof
- 10' cord tamper proof

Specify: Model | Power Color

Model | Power Color

- G Grey
- W White

Easy Replacement Parts

- Designed for healthcare's challenges, Somna sleep sofa ensures easy replacement parts if damaged
- Replacable high-use parts extend the product's lifespan
- This includes: arm caps, fold-down back, feet, casters and glides, which are detailed in the following pages



Description	D	W	H	CTN WT	CU FT	① Model	List Price
Replacement Polyurethane Arm Cap for Low Arm	17½	4¼	1½	4	1	23SRLPACLW	\$200

• stone grey polyurethane

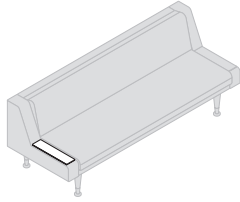

Replacement Polyurethane Arm Cap for High Arm	21¼	4¼	1½	5	1	23SRLPACHW	\$210
--	-----	----	----	---	---	-------------------	-------

• stone grey polyurethane

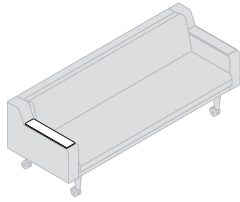

Replacement 3D Laminate Arm Cap for Low Arm	17½	4¼	1½	2	1	23SRL3ACLW	\$210
--	-----	----	----	---	---	-------------------	-------

Specify: Model | 3D Laminate Finish

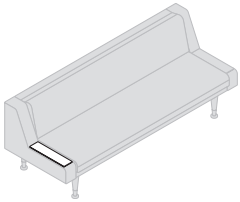

Replacement 3D Laminate Arm Cap for High Arm	21¼	4¼	1½	3	1	23SRL3ACHW	\$220
---	-----	----	----	---	---	-------------------	-------

Specify: Model | 3D Laminate Finish

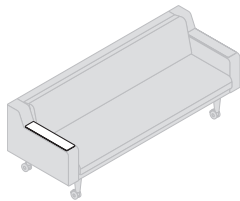

Arm Cap

- 3LAC** 3D Laminate Arm Cap Set
- BEL** Belair
- FLO** Florence Walnut
- PIL** Pilsner
- PIN** Pinnacle Walnut

Description	D	W	H	CTN WT	CU FT	① Model	List Price
Replacement Foot for Caster	4	4	8½	5	1	23SRLCL	\$225



Replacement Foot for Glide	4	4	11	5	1	23SRLML	\$235
----------------------------	---	---	----	---	---	---------	-------



Replacement Front Locking Caster	3¾	2½	4	2	1	23SRLFLC	\$125
----------------------------------	----	----	---	---	---	----------	-------



Replacement Back Non-Locking Caster	3	2½	4	2	1	23SRLBNLC	\$120
-------------------------------------	---	----	---	---	---	-----------	-------



Replacement Easy Slide Disc Glide	2¾	2¾	2¾	2	1	23SRLESG	\$90
-----------------------------------	----	----	----	---	---	----------	------



Replacement Stainless Steel Glide	2¾	2¾	2¾	2	1	23SRLSSG	\$120
-----------------------------------	----	----	----	---	---	----------	-------



Description + General Information

Replacement 68 Sleep Sofa Back Cushion

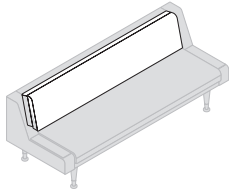

Dimensions	D	W	H
Overall	5 ¾	68	14 ¾
Upholstery		Shipping	
COM Ydg	2 ¾	Ctn Wt	13
COL Sq Ft	50	Cu Ft	5

Specify: Model | Upholstery

23S68RLFDBC														
	COM	COL	A	B	C	D	E	F	G	H	I	J	L1	L2
Single Uph	\$1,543	\$1,689	\$1,565	\$1,610	\$1,689	\$1,790	\$1,891	\$2,048	\$2,217	\$2,396	\$2,677	\$3,014	\$2,520	\$2,789

Replacement 69 Sleep Sofa Back Cushion

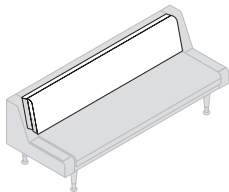

Dimensions	D	W	H
Overall	5 ¾	69	14 ¾
Upholstery		Shipping	
COM Ydg	2 ¾	Ctn Wt	14
COL Sq Ft	50	Cu Ft	5

Specify: Model | Upholstery

23S69RLFDBC														
	COM	COL	A	B	C	D	E	F	G	H	I	J	L1	L2
Single Uph	\$1,547	\$1,693	\$1,570	\$1,615	\$1,693	\$1,794	\$1,895	\$2,053	\$2,221	\$2,401	\$2,681	\$3,018	\$2,524	\$2,794

Model | Upholstery

Grade
Vendor
Pattern
Colorway

Description + General Information

Replacement 70 Sleep Sofa Back Cushion

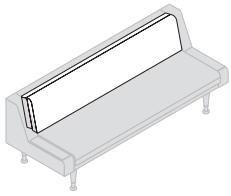

Dimensions	D	W	H
Overall	5 ¾	70	14 ¾
Upholstery		Shipping	
COM Ydg	2 ¾	Ctn Wt	15
COL Sq Ft	50	Cu Ft	5

Specify: Model | Upholstery

23S70RLFDBC														
	COM	COL	A	B	C	D	E	F	G	H	I	J	L1	L2
Single Uph	\$1,551	\$1,697	\$1,574	\$1,619	\$1,697	\$1,799	\$1,900	\$2,057	\$2,225	\$2,405	\$2,686	\$3,023	\$2,528	\$2,798

Replacement 71 Sleep Sofa Back Cushion

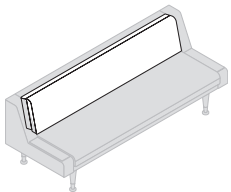

Dimensions	D	W	H
Overall	5 ¾	71	14 ¾
Upholstery		Shipping	
COM Ydg	2 ¾	Ctn Wt	16
COL Sq Ft	50	Cu Ft	5

Specify: Model | Upholstery

23S71RLFDBC														
	COM	COL	A	B	C	D	E	F	G	H	I	J	L1	L2
Single Uph	\$1,556	\$1,702	\$1,578	\$1,623	\$1,702	\$1,803	\$1,904	\$2,061	\$2,229	\$2,409	\$2,690	\$3,027	\$2,533	\$2,802

Model | Upholstery

- Grade
- Vendor
- Pattern
- Colorway

Description + General Information

Replacement 72 Sleep Sofa Back Cushion

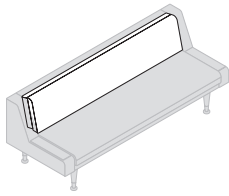

Dimensions	D	W	H
Overall	5 ¾	72	14 ¾
Upholstery		Shipping	
COM Ydg	2 ¾	Ctn Wt	17
COL Sq Ft	50	Cu Ft	6

Specify: Model | Upholstery

23S72RLFDBC														
	COM	COL	A	B	C	D	E	F	G	H	I	J	L1	L2
Single Uph	\$1,560	\$1,706	\$1,582	\$1,627	\$1,706	\$1,807	\$1,908	\$2,065	\$2,234	\$2,413	\$2,694	\$3,031	\$2,537	\$2,806

Replacement 73 Sleep Sofa Back Cushion

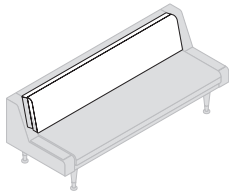

Dimensions	D	W	H
Overall	5 ¾	73	14 ¾
Upholstery		Shipping	
COM Ydg	2 ¾	Ctn Wt	18
COL Sq Ft	50	Cu Ft	6

Specify: Model | Upholstery

23S73RLFDBC														
	COM	COL	A	B	C	D	E	F	G	H	I	J	L1	L2
Single Uph	\$1,564	\$1,710	\$1,587	\$1,632	\$1,710	\$1,811	\$1,912	\$2,070	\$2,238	\$2,418	\$2,698	\$3,035	\$2,541	\$2,811

Model | Upholstery

Grade
Vendor
Pattern
Colorway

Description + General Information

Replacement 74 Sleep Sofa Back Cushion

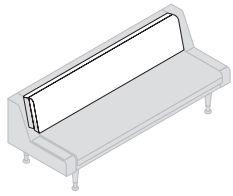

Dimensions	D	W	H
Overall	5 ¾	74	14 ¾
Upholstery		Shipping	
COM Ydg	2 ¾	Ctn Wt	19
COL Sq Ft	50	Cu Ft	6

Specify: Model | Upholstery

23S74RLFDBC														
	COM	COL	A	B	C	D	E	F	G	H	I	J	L1	L2
Single Uph	\$1,568	\$1,714	\$1,591	\$1,636	\$1,714	\$1,816	\$1,917	\$2,074	\$2,242	\$2,422	\$2,703	\$3,040	\$2,545	\$2,815

Replacement 75 Sleep Sofa Back Cushion

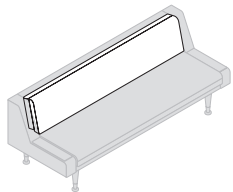

Dimensions	D	W	H
Overall	5 ¾	75	14 ¾
Upholstery		Shipping	
COM Ydg	2 ¾	Ctn Wt	20
COL Sq Ft	50	Cu Ft	6

Specify: Model | Upholstery

23S75RLFDBC														
	COM	COL	A	B	C	D	E	F	G	H	I	J	L1	L2
Single Uph	\$1,573	\$1,719	\$1,595	\$1,640	\$1,719	\$1,820	\$1,921	\$2,078	\$2,246	\$2,426	\$2,707	\$3,044	\$2,550	\$2,819

Model | Upholstery

- Grade
- Vendor
- Pattern
- Colorway

Description + General Information

Replacement 76 Sleep Sofa Back Cushion

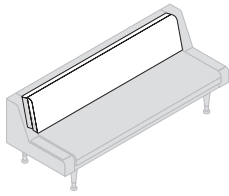

Dimensions	D	W	H
Overall	5 ¾	76	14 ¾
Upholstery		Shipping	
COM Ydg	2 ¾	Ctn Wt	21
COL Sq Ft	50	Cu Ft	6

Specify: Model | Upholstery

23S76RLFDBC														
	COM	COL	A	B	C	D	E	F	G	H	I	J	L1	L2
Single Uph	\$1,577	\$1,723	\$1,599	\$1,644	\$1,723	\$1,824	\$1,925	\$2,082	\$2,251	\$2,430	\$2,711	\$3,048	\$2,554	\$2,823

Replacement 77 Sleep Sofa Back Cushion

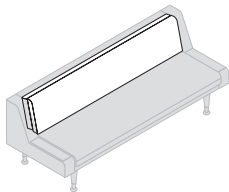

Dimensions	D	W	H
Overall	5 ¾	77	14 ¾
Upholstery		Shipping	
COM Ydg	2 ¾	Ctn Wt	22
COL Sq Ft	50	Cu Ft	6

Specify: Model | Upholstery

23S77RLFDBC														
	COM	COL	A	B	C	D	E	F	G	H	I	J	L1	L2
Single Uph	\$1,581	\$1,727	\$1,604	\$1,649	\$1,727	\$1,828	\$1,929	\$2,087	\$2,255	\$2,435	\$2,715	\$3,052	\$2,558	\$2,828

Model | Upholstery

Grade
Vendor
Pattern
Colorway

Description + General Information

Replacement 78 Sleep Sofa Back Cushion

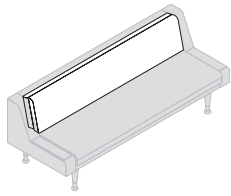

Dimensions	D	W	H
Overall	5 ¾	78	14 ¾
Upholstery		Shipping	
COM Ydg	2 ¾	Ctn Wt	23
COL Sq Ft	50	Cu Ft	6

Specify: Model | Upholstery

23S78RLFDBC														
	COM	COL	A	B	C	D	E	F	G	H	I	J	L1	L2
Single Uph	\$1,585	\$1,731	\$1,608	\$1,653	\$1,731	\$1,832	\$1,934	\$2,091	\$2,259	\$2,439	\$2,720	\$3,057	\$2,562	\$2,832

Replacement 79 Sleep Sofa Back Cushion

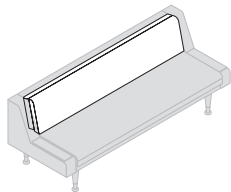

Dimensions	D	W	H
Overall	5 ¾	79	14 ¾
Upholstery		Shipping	
COM Ydg	2 ¾	Ctn Wt	24
COL Sq Ft	50	Cu Ft	6

Specify: Model | Upholstery

23S79RLFDBC														
	COM	COL	A	B	C	D	E	F	G	H	I	J	L1	L2
Single Uph	\$1,590	\$1,736	\$1,612	\$1,657	\$1,736	\$1,837	\$1,938	\$2,095	\$2,263	\$2,443	\$2,724	\$3,061	\$2,567	\$2,836

Model | Upholstery

- Grade
- Vendor
- Pattern
- Colorway

Description + General Information

Replacement 80 Sleep Sofa Back Cushion

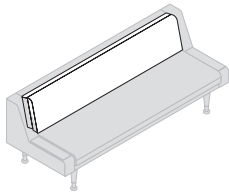

Dimensions	D	W	H
Overall	5 ¾	80	14 ¾
Upholstery		Shipping	
COM Ydg	2 ¾	Ctn Wt	25
COL Sq Ft	50	Cu Ft	6

Specify: Model | Upholstery

23S80RLFDBC														
	COM	COL	A	B	C	D	E	F	G	H	I	J	L1	L2
Single Uph	\$1,594	\$1,740	\$1,616	\$1,661	\$1,740	\$1,841	\$1,942	\$2,099	\$2,268	\$2,447	\$2,728	\$3,065	\$2,571	\$2,840

Model | Upholstery

Grade
Vendor
Pattern
Colorway

Satisse - Overview

Freestanding & Seat Linking



Armless Guest
[See pg 10](#)



Guest
[See pg 11](#)



Two Seat Guest
[See pg 13](#)



Bariatric
[See pg 15](#)



Patient
[See pg 17](#)

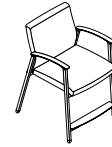

Easy Access
[See pg 19](#)

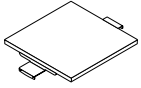

Connecting Inline
[See pg 22](#)



Connecting Corner
[See pg 22](#)



Connecting End
[See pg 22](#)

Glide Linking



Armless Guest
[See pg 29](#)



Guest
[See pg 32](#)



Two Seat
[See pg 35](#)

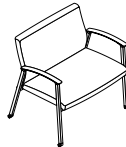

Bariatric
[See pg 38](#)



Inline Glide Linking
[See pg 41](#)



Glide Linking Corner
[See pg 41](#)



Glide Linking End (Right)
[See pg 41](#)

Lounge

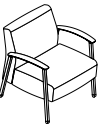

Single Seat
[See pg 45](#)

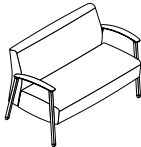

Two Seat
[See pg 46](#)

Freestanding Tables

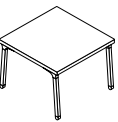

Side Table
[See pg 26](#)

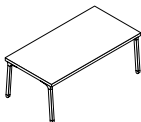

Magazine Table
[See pg 27](#)

Replacement Parts - [begin on pg 47](#)

Satisse Order Check List:



Specify:

- 1. Model Number
- 2. Upholstery Selection
 - A. Single Upholstery Models: Vendor, Pattern and Color
 - B. Multiple Upholstery Models (_M): Vendor, Pattern and Color each per zone
- 3. Moisture Barrier - Seat Only - upcharge applies, Seat and Back - upcharge applies
- 4. Arm Caps - Polyurethane, 3D Laminate, Solid Surface or Wood
- 5. Metal Frame Finish
- 6. Glide
- 7. Top Surface Material - specify material and finish

Example:

20SG1 | Momentum | Silica | Alloy | MB1 | SGU | SNK | G10
 (model #) | (fabric vendor) | (pattern name) | (pattern color) | (moisture barrier) | (polyurethane arm cap) | (metal frame finish) | (glide)

1. Model Number - Consider the application and connection method when specifying a model. Select from freestanding & seat linking or glide linking.

2. Upholstery Selection - Please supply the following:
 Fabric vendor/ Pattern name/ Pattern color

[For a complete list of JSI Standard and Graded-In Textiles click here](#)

- Indicate direction of fabric - Railroaded or Up the Roll
- Please provide illustration, if available

All COM orders must include the following:

- Vendor's name, pattern name and color
- Sample of the fabric attached to the order
- Model numbers of items for fabric application
- Special application instructions
- Customer and purchase order number

Ship prepaid COM material to:
 JSI
 Attn: COM Department
 201 East Martin Street
 Receiving B, Dock 71
 Orleans, IN 47452

Application of fabric:
 Up the Roll Railroaded

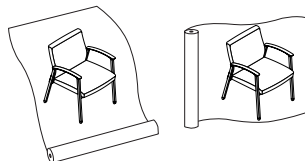

All COM orders will ship at standard lead time from receipt of COM except for orders requiring special custom matched finishes.

Upholstery Application

Satisse offers the ability to be specified with multiply upholsteries to create a unique look.

Both upholstery styles are presented in the price list and eTools. Models not ending in a _M will be upholstered in the single phol-stery for the complete unit.

Models ending with a _M designate multiple upholstery zones will be specified (ex: 20SG1_M) To calculate pricing, add base price + zone 1 upcharge + zone 2 upcharge.

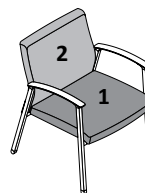

Zone 1 = Seat
 Zone 2 = Back

3. Moisture Barrier - offers further protection from fluids

- NMB No Moisture Barrier
- MB1 Moisture Barrier Seat Only - upcharge applies
- MB2 Moiserer Barrier Seat & Back - upcharge applies

4. Arm Caps

Freestanding & Seat Linking chairs are available in narrow and wide arm width models.



20SG1

Guest Chair with Narrow Arms

1 3/4" arm width



20SGWA1

Guest Chair with Wide Arms

2 1/2" width at center tapers to 2" front and back

Glide linking models are available in narrow width arms only.

Arm Caps are available in four different materials:

Polyurethane (PAC) - standard

MBK Matte Black
SGU Stone Grey

3D Laminate (3LAC) - upcharge applies

BEL Belair
FLO Florence Walnut
PIL Pilsner
PIN Pinnacle Walnut

Solid Surface (SAC) - upcharge applies

DWH Designer White

Wood (WAC) - upcharge applies

BAR Barrel	MCH Mocha
BRK Brickdust	OBK Outback
BUF Buff	PIL Pilsner
CSK Cask	PIN Pinnacle Walnut
CND Cinder	RAV Raven
CLY Clay	RYE Rye
EGR Egret	SAB Sable
FAW Fawn	SAD Saddle
FLX Flax	SIE Sienna
FLN Flint	TRF Truffle
FLO Florence Walnut	UMB Umber
LOF Loft	VAL Valley
MES Mesa	WAL Walnut Heights
MIN Mineral	

5. Metal Frame Finish

ABZ Aged Bronze	PEW Pewter
ASL Arctic Silver	SBZ Soft Bronze
GLD Gold	SNK Soft Nickel
MBK Matte Black	

6. Glides

The style of glides offered on Satisse are dependent upon the model or connection method selected.

Freestanding & Seat Linking

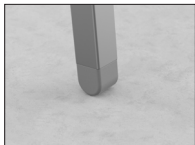

G10

Standard Glide

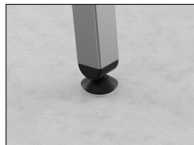

G15

Leveling Glide
(Black)

Glide Linking

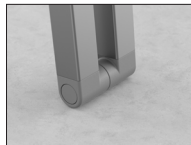

G20

MagLinX™

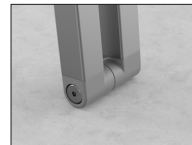

G25

BoltLinX

The G15 leveling glide is always black, the other glides are color coordinated to the metal frame finish selected.

Arctic Silver frame finish dictates Arctic Silver glides.

Pewter or Soft Nickel frame finishes dictate Stone Grey glides.

Aged Bronze, Soft Bronze or Matte Black frame finishes dictate Matte Black glides.

7. Tables

Coordinating tables are available in seat linking, glide linking and freestanding options.

A. Top Material



TFL/HPL Laminate

- ALB Alabaster
- BEL Belair
- BLK Black
- BRK Brickdust
- BBL Bridal Blanco
- CSK Cask
- CLY Clay
- DWH Designer White
- EGR Egret
- FAW Fawn
- FLN Flint
- FLO Florence Walnut
- LOF Loft
- MES Mesa
- MIN Mineral
- MCH Mocha
- OBK Outback
- PIL Pilsner
- PIN Pinnacle Walnut
- SHD Shadow
- SLG Slate Grey
- UMB Umber
- VAL Valley
- WAL Walnut Heights
- WEA Weathered Ash
- ZEN Zen Grey



Essentials Veneer

- BRK Brickdust
- CSK Cask
- FAW Fawn
- FLX Flax
- FLN Flint
- LOF Loft
- MES Mesa
- MIN Mineral
- MCH Mocha
- OBK Outback
- PIL Pilsner
- SIE Sienna
- TRF Truffle
- UMB Umber
- VAL Valley



3D Laminate

- BEL Belair
- FLO Florence Walnut
- PIL Pilsner
- PIN Pinnacle Walnut



Solid Surface

- DWH Designer White

Artisan Veneer

- BAR Barrel
- BUF Buff
- CIN Cinder
- EGR Egret
- RAV Raven
- SAB Sable
- SAD Saddle

B. Metal Frame Finish

- | | |
|-------------------|-----------------|
| ABZ Aged Bronze | PEW Pewter |
| ASL Arctic Silver | SBZ Soft Bronze |
| GLD Gold | SNK Soft Nickel |
| MBK Matte Black | |

C. Glides

The style of glides offered on Satisse are dependent upon the model or connection method selected.

Freestanding & Seat Linking

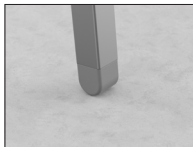

G10

Standard Glide

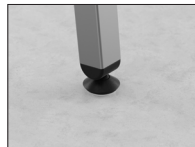

G15

Leveling Glide
(Black)

Glide Linking

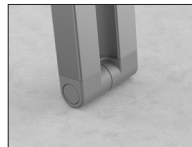

G20

MagLinX™

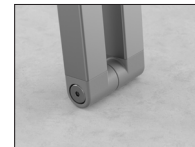

G25

BoltLinX

The G15 leveling glide is always black, the other glides are color coordinated to the metal frame finish selected.

Arctic Silver frame finish dictates Arctic Silver glides.

Pewter or Soft Nickel frame finishes dictate Stone Grey glides.

Aged Bronze, Soft Bronze or Matte Black frame finishes dictate Matte Black glides.

Creating Configuration with Chairs and Tables

Satisse provides two distinct techniques of creating solutions for public seating needs, in the healthcare and private sector.

Glide Linking

Glide Linking is quick connect/disconnect system linking chairs and tables. When patent-pending MagLinx™ glide is specified there is no need for additional hardware.

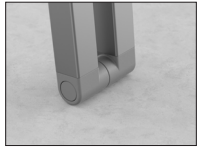

MagLinx™ glides afford a strong connection from unit to unit. Simply align one chair up to a corresponding unit and they snap into place. When the space needs to be rearranged, the units can be quickly pulled apart and reallocated.

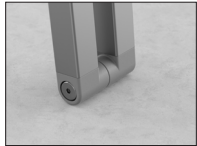

For solutions requiring a more permanent attachment, specify the **BoltLinx** glide which replaces the magnet with a mechanical fastened through bolt.

Right end and left end chairs and tables are available to finish the end of a configuration with a standard glide.

Glide linking models always face the same direction when linked together.

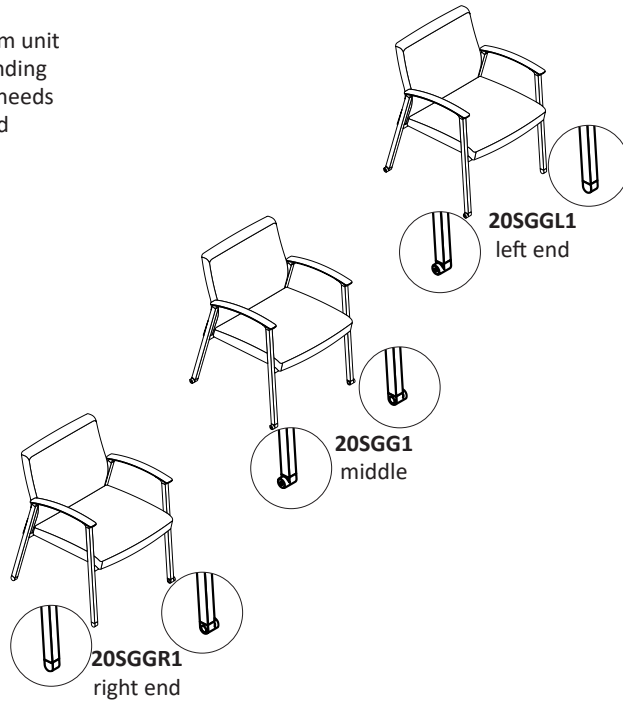

Below illustrates a combination of models to create possible configurations.

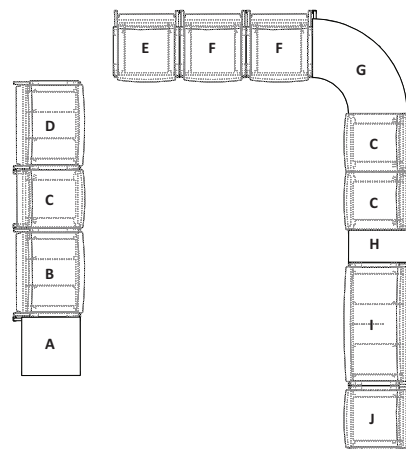
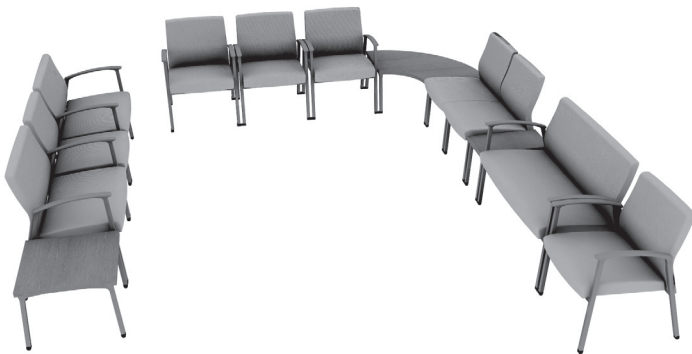

Glide Linking

- A 20TEGR2222T
- B 20SBG1
- C 20SGXAG1
- D 20SBGL1
- E 20SGGR1
- F 20SGG1
- G 20TCG3535T
- H 20TIG12222T
- I 20SGG2
- J 20SGGL1

Seat Linking

An alternate solution to create a run of chairs is to use the connecting hardware at the seat of freestanding models.



Connecting hardware can be placed between two freestanding chairs, and accomodates seat linking armless, narrow or wide arm models.

Connecting tables come with their own brackets and do not require hardware to be ordered separately.



Connecting corner and end tables with supporting legs can be used with all freestanding chairs except easy access.



Connecting inline tables that do not have a support leg can be specified with all freestanding chairs.

Below illustrates a combination of models to create possible configurations. Freestanding chairs that are linked with the additional connecting hardware can face opposite directions.

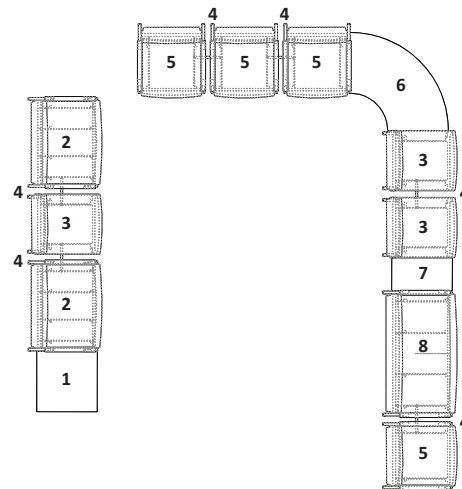

Seat Linking

- 1 20TE2222T
- 2 20SB1
- 3 20SGXA1
- 4 20SCH Connect Hardware
- 5 20SG1
- 6 20T3535T
- 7 20TI1222T
- 8 20SG2

Satisse Features and Options



Satisse frames are fully welded heavy gauge powder coated steel. Available in seven standard finishes.



Polyurethane Armcaps are standard and provide durability, comfort and ease of cleanability. Available in two colors Stone Grey and Matte Black.



Easy Replacement Parts ensure easy part replacement if damaged. This includes chair arms, seat and back. Find the full list of replaceable parts starting on [page 47](#).



3D Laminate Armcaps are available in four [woodgrain finishes](#) and provide an alternate to real wood for ease of cleanability. Upcharge applies.



Clean Out All Satisse seating models come with a clean out feature, allowing debris, dirt and liquids to easily fall onto the floor for effortless maintenance.



Solid Surface Armcaps are available in Designer White providing enhanced durability and cleanability. Upcharge applies.



Wall Saver Satisse chair leg design prevents wall damage by keeping the back away from the wall.



Solid Wood Armcaps are available in a variety of finishes. Upcharge applies.

arm widths



narrow arm
- glide linking chairs
- available in freestanding and seat linking chairs



wide arm
- lounge
- available in freestanding and seat linking chairs

Satisse Arms are available in a narrow arm or wide arm based on model type. The pommel arm grip is subtly curved to support visitors as they shift to stand.

Satisse Features and Options

linking options



glide linking chairs
 - MagLinx™ or BoltLinx glides
 - narrow arm models only



seat linking chairs
 - connecting hardware joins freestanding guest chairs
 - standard or leveling glides
 - narrow or wide arm models

Satisse offers two methods to link or gang seating and tables together. Glide linking models link with a patent-pending MagLinx™ connectors held with a strong magnet for toolless installation. A BoltLinx option is also available.

Seat Linking are freestanding models that can be joined in the field with connecting hardware sold separately. Tables ship with connecting hardware.



standard



leveling

Glides for freestanding and seat linking chairs and tables are available with a standard glide color coordinated to the frame finish or a black leveling glide at an upcharge.



MagLinx™

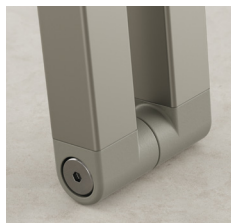

BoltLinx

Glide Linking models for chairs and tables are available with a standard glide color coordinated to match the frame finish.



Coordinating Tables are available in seat linking, glide linking and freestanding options. Finish options include laminate, 3D laminate, veneer and solid surface.

Multiple Upholstery models allow a combination of two upholstery covers on the same unit. See price list for upcharges per model.

Moisture Barrier option is available when a fabric does not provide a fluid barrier or when extra protection is desired. It helps prevent the passage of liquids to the inside of upholstered components.

Weight Capacities are as follows:

400 lb. per seat. Exceeds BIFMA Seating Drop Test to 500 lbs.

600 lb. Bariatric. Exceeds BIFMA Seating Drop Test to 750 lbs.

Testing

ANSI/BIFMA X5.41 (400 lb)-2021 - Large Occupant Public and Lounge Seating Tests¹

ANSI/BIFMA X5.41 (600 lb)-2021 - Large Occupant Public and Lounge Seating Tests²

Tested for 24-hour duty cycle

¹ Meets all criteria, except the minimum seat width

² Limited to Bariatric models only

Freestanding & Seat Linking

Description + General Information

Armless Guest Chair

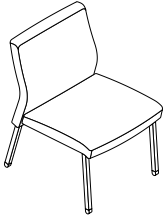

Dimensions	D	W	H	Shipping	
Overall	26 ¾	22	33	Ctn Wt	33
Seat	20	21 ½	18 ½	Cu Ft	14

	Single Upholstery	Seat Zone 1	Back Zone 2
COM Ydg	1 ¾	1	1 ¼
COL Sq Ft	35	20	25

Single Upholstery Specify: Model | Upholstery | Moisture Barrier | Metal Frame Finish | Glide Option

20SGXA1														
	COM	COL	A	B	C	D	E	F	G	H	I	J	L1	L2
Single Uph	\$1,092	\$1,192	\$1,108	\$1,139	\$1,192	\$1,261	\$1,331	\$1,438	\$1,553	\$1,676	\$1,868	\$2,098	\$1,638	\$1,791

Multiple Upholstery Specify: Model | Seat Upholstery | Back Upholstery | Moisture Barrier | Metal Frame Finish | Glide Option

20SGXA1_M														
Base Price: \$1,092	To the Base Price, add the appropriate upcharges by grade, per zone													
	COM	COL	A	B	C	D	E	F	G	H	I	J	L1	L2
Seat - Zone 1	+N/A	+\$58	+\$9	+\$27	+\$58	+\$97	+\$136	+\$198	+\$264	+\$334	+\$443	+\$575	+\$312	+\$400
Back - Zone 2	+N/A	+\$72	+\$11	+\$33	+\$72	+\$121	+\$170	+\$247	+\$330	+\$417	+\$554	+\$719	+\$390	+\$500

Model	Upholstery	Moisture Barrier	Metal Frame Finish	Glide
	Grade Vendor Pattern Colorway	NMB No Moisture Barrier MB1 Moisture Barrier Seat - add \$84 MB2 Moisture Barrier Seat & Back - add \$169	ABZ Aged Bronze ASL Arctic Silver GLD Gold MBK Matte Black PEW Pewter SBZ Soft Bronze SNK Soft Nickel	G10 Non Adjustable Glide G15 Leveling Glide - add \$10

Freestanding & Seat Linking

Description + General Information

Guest Chair with Narrow Arms

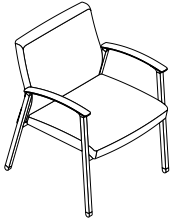

Dimensions	D	W	H	Shipping	
Overall	26 ¾	24 ½	33	Ctn Wt	41
Seat	20	21 ½	18 ½	Cu Ft	16
Arm			26 ¼		

	Single Upholstery	Seat Zone 1	Back Zone 2
COM Ydg	1 ¾	1	1 ¼
COL Sq Ft	35	20	25

Single Upholstery Specify: Model | Upholstery | Moisture Barrier | Arm Cap | Metal Frame Finish | Glide Option

20SG1														
	COM	COL	A	B	C	D	E	F	G	H	I	J	L1	L2
Single Uph	\$1,378	\$1,478	\$1,394	\$1,424	\$1,478	\$1,547	\$1,616	\$1,724	\$1,839	\$1,962	\$2,154	\$2,384	\$1,923	\$2,077

Multiple Upholstery Specify: Model | Seat Upholstery | Back Upholstery | Moisture Barrier | Arm Cap | Metal Frame Finish | Glide Option

20SG1_M														
Base Price: \$1,378	To the Base Price, add the appropriate upcharges by grade, per zone													
	COM	COL	A	B	C	D	E	F	G	H	I	J	L1	L2
Seat - Zone 1	+N/A	+\$57	+\$9	+\$27	+\$57	+\$97	+\$136	+\$198	+\$263	+\$334	+\$443	+\$575	+\$312	+\$399
Back - Zone 2	+N/A	+\$71	+\$11	+\$33	+\$71	+\$121	+\$170	+\$247	+\$329	+\$417	+\$554	+\$718	+\$390	+\$499

Model	Upholstery	Moisture Barrier	Arm Cap	Metal Frame Finish	Glide
	Grade Vendor Pattern Colorway	NMB No Moisture Barrier MB1 Moisture Barrier Seat - add \$84 MB2 Moisture Barrier Seat & Back - add \$169	PAC Polyurethane Arm Cap Set 3LAC 3D Laminate Arm Cap Set - add \$120 WAC Wood Arm Cap Set - add \$62 SAC Solid Surface Arm Cap Set - add \$352 see arm cap finishes	ABZ Aged Bronze ASL Arctic Silver GLD Gold MBK Matte Black PEW Pewter SBZ Soft Bronze SNK Soft Nickel	G10 Non Adjustable Glide G15 Leveling Glide - add \$10

Freestanding & Seat Linking

Description + General Information

Guest Chair with Wide Arms

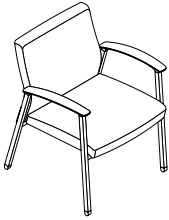

Dimensions	D	W	H	Shipping	
Overall	26 ¾	26	33	Ctn Wt	43
Seat	20	21 ½	18 ½	Cu Ft	17
Arm			26 ¼		

	Single Upholstery	Seat Zone 1	Back Zone 2
COM Ydg	1 ¾	1	1 ¼
COL Sq Ft	35	20	25

Single Upholstery Specify: Model | Upholstery | Moisture Barrier | Arm Cap | Metal Frame Finish | Glide Option

20SGWA1														
	COM	COL	A	B	C	D	E	F	G	H	I	J	L1	L2
Single Uph	\$1,389	\$1,489	\$1,405	\$1,435	\$1,489	\$1,558	\$1,627	\$1,735	\$1,850	\$1,973	\$2,165	\$2,395	\$1,934	\$2,088

Multiple Upholstery Specify: Model | Seat Upholstery | Back Upholstery | Moisture Barrier | Arm Cap | Metal Frame Finish | Glide Option

20SGWA1_M														
Base Price:	To the Base Price, add the appropriate upcharges by grade, per zone													
	COM	COL	A	B	C	D	E	F	G	H	I	J	L1	L2
Seat - Zone 1	+N/A	+\$57	+\$9	+\$27	+\$57	+\$97	+\$136	+\$198	+\$263	+\$334	+\$443	+\$575	+\$312	+\$399
Back - Zone 2	+N/A	+\$71	+\$11	+\$33	+\$71	+\$121	+\$170	+\$247	+\$329	+\$417	+\$554	+\$718	+\$390	+\$499

Model	Upholstery	Moisture Barrier	Arm Cap	Metal Frame Finish	Glide
	Grade Vendor Pattern Colorway	NMB No Moisture Barrier MB1 Moisture Barrier Seat - add \$84 MB2 Moisture Barrier Seat & Back - add \$169	PAC Polyurethane Arm Cap Set 3LAC 3D Laminated Arm Cap Set - add \$129 WAC Wood Arm Cap Set - add \$69 SAC Solid Surface Arm Cap Set - add \$357 see arm cap finishes	ABZ Aged Bronze ASL Arctic Silver GLD Gold MBK Matte Black PEW Pewter SBZ Soft Bronze SNK Soft Nickel	G10 Non Adjustable Glide G15 Leveling Glide - add \$10

Freestanding & Seat Linking

Description + General Information

Two Seat Guest Chair with Narrow Arms

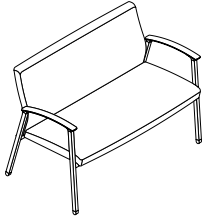

Dimensions	D	W	H	Shipping	
Overall	26 ¾	45 ½	33 ¾	Ctn Wt	75
Seat	20	42 ½	18 ½	Cu Ft	28
Arm			26 ¾		

	Single Upholstery	Seat Zone 1	Back Zone 2
COM Ydg	2 ¾	1 ¼	1 ½
COL Sq Ft	60 ½	27 ½	33

Single Upholstery Specify: Model | Upholstery | Moisture Barrier | Arm Cap | Metal Frame Finish | Glide Option

20SG2														
	COM	COL	A	B	C	D	E	F	G	H	I	J	L1	L2
Single Uph	\$2,165	\$2,322	\$2,189	\$2,238	\$2,322	\$2,431	\$2,539	\$2,708	\$2,889	\$3,082	\$3,384	\$3,745	\$3,118	\$3,384

Multiple Upholstery Specify: Model | Seat Upholstery | Back Upholstery | Moisture Barrier | Arm Cap | Metal Frame Finish | Glide Option

20SG2_M														
Base Price: \$2,165	To the Base Price, add the appropriate upcharges by grade, per zone													
	COM	COL	A	B	C	D	E	F	G	H	I	J	L1	L2
Seat - Zone 1	+N/A	+\$72	+\$12	+\$34	+\$72	+\$121	+\$170	+\$247	+\$330	+\$417	+\$555	+\$719	+\$434	+\$555
Back - Zone 2	+N/A	+\$86	+\$14	+\$40	+\$86	+\$146	+\$204	+\$297	+\$395	+\$501	+\$665	+\$863	+\$521	+\$665

Model	Upholstery	Moisture Barrier	Arm Cap	Metal Frame Finish	Glide
	Grade Vendor Pattern Colorway	NMB No Moisture Barrier MB1 Moisture Barrier Seat - add \$140 MB2 Moisture Barrier Seat & Back - add \$278	PAC Polyurethane Arm Cap Set 3LAC 3D Laminate Arm Cap Set - add \$120 WAC Wood Arm Cap Set - add \$62 SAC Solid Surface Arm Cap Set - add \$352 see arm cap finishes	ABZ Aged Bronze ASL Arctic Silver GLD Gold MBK Matte Black PEW Pewter SBZ Soft Bronze SNK Soft Nickel	G10 Non Adjustable Glide G15 Leveling Glide - add \$10

Freestanding & Seat Linking

Description + General Information

Two Seat Guest Chair with Wide Arms

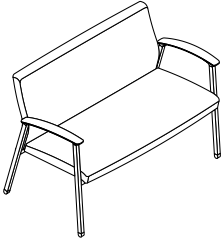

Dimensions	D	W	H	Shipping	
Overall	26 ¾	47	33 ¾	Ctn Wt	77
Seat	20	42 ½	18 ½	Cu Ft	29
Arm			26 ¼		

	Single Upholstery	Seat Zone 1	Back Zone 2
COM Ydg	2 ¾	1 ¼	1 ½
COL Sq Ft	60 ½	27 ½	33

Single Upholstery Specify: Model | Upholstery | Moisture Barrier | Arm Cap | Metal Frame Finish | Glide Option

20SGWA2														
	COM	COL	A	B	C	D	E	F	G	H	I	J	L1	L2
Single Uph	\$2,196	\$2,352	\$2,220	\$2,268	\$2,352	\$2,461	\$2,570	\$2,739	\$2,919	\$3,112	\$3,414	\$3,776	\$3,149	\$3,414

Multiple Upholstery Specify: Model | Seat Upholstery | Back Upholstery | Moisture Barrier | Arm Cap | Metal Frame Finish | Glide Option

20SGWA2_M														
Base Price: \$2,196	To the Base Price, add the appropriate upcharges by grade, per zone													
	COM	COL	A	B	C	D	E	F	G	H	I	J	L1	L2
Seat - Zone 1	+N/A	+\$72	+\$11	+ \$34	+\$72	+\$121	+ \$170	+ \$247	+ \$330	+ \$417	+ \$555	+ \$719	+\$434	+ \$555
Back - Zone 2	+N/A	+\$86	+ \$14	+\$40	+\$86	+\$146	+ \$204	+ \$297	+ \$395	+ \$501	+ \$665	+ \$863	+ \$520	+ \$665

Model	Upholstery	Moisture Barrier	Arm Cap	Metal Frame Finish	Glide
	Grade Vendor Pattern Colorway	NMB No Moisture Barrier MB1 Moisture Barrier Seat - add \$140 MB2 Moisture Barrier Seat & Back - add \$278	PAC Polyurethane Arm Cap Set 3LAC 3D Laminate Arm Cap Set - add \$129 WAC Wood Arm Cap Set - add \$69 SAC Solid Surface Arm Cap Set - add \$357 see arm cap finishes	ABZ Aged Bronze ASL Arctic Silver GLD Gold MBK Matte Black PEW Pewter SBZ Soft Bronze SNK Soft Nickel	G10 Non Adjustable Glide G15 Leveling Glide - add \$10

Freestanding & Seat Linking

Description + General Information

Bariatric Chair with Narrow Arms

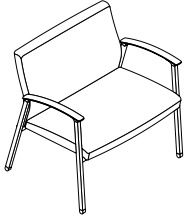

Dimensions	D	W	H	Shipping	
Overall	26 ¾	33	33	Ctn Wt	41
Seat	20	21 ½	19	Cu Ft	21
Arm			26 ¼		

	Single Upholstery	Seat Zone 1	Back Zone 2
COM Ydg	2 ½	1	1 ½
COL Sq Ft	55	22	33

Single Upholstery Specify: Model | Upholstery | Moisture Barrier | Arm Cap | Metal Frame Finish | Glide Option

20SB1														
	COM	COL	A	B	C	D	E	F	G	H	I	J	L1	L2
Single Uph	\$1,872	\$2,014	\$1,894	\$1,938	\$2,014	\$2,113	\$2,212	\$2,365	\$2,530	\$2,705	\$2,980	\$3,309	\$2,738	\$2,980

Multiple Upholstery Specify: Model | Seat Upholstery | Back Upholstery | Moisture Barrier | Arm Cap | Metal Frame Finish | Glide Option

20SB1_M														
Base Price: \$1,872	To the Base Price, add the appropriate upcharges by grade, per zone													
	COM	COL	A	B	C	D	E	F	G	H	I	J	L1	L2
Seat - Zone 1	+N/A	+\$57	+\$9	+\$27	+\$57	+\$97	+\$136	+\$198	+\$264	+\$334	+\$443	+\$575	+\$347	+\$443
Back - Zone 2	+N/A	+\$86	+\$14	+\$40	+\$86	+\$145	+\$204	+\$296	+\$395	+\$500	+\$665	+\$862	+\$520	+\$665

Model	Upholstery	Moisture Barrier	Arm Cap	Metal Frame Finish	Glide
	Grade Vendor Pattern Colorway	NMB No Moisture Barrier MB1 Moisture Barrier Seat - add 140 MB2 Moisture Barrier Seat & Back - add \$278	PAC Polyurethane Arm Cap Set 3LAC 3D Laminate Arm Cap Set - add \$120 WAC Wood Arm Cap Set - add \$62 SAC Solid Surface Arm Cap Set - add \$352 see arm cap finishes	ABZ Aged Bronze ASL Arctic Silver GLD Gold MBK Matte Black PEW Pewter SBZ Soft Bronze SNK Soft Nickel	G10 Non Adjustable Glide G15 Leveling Glide - add \$10

Freestanding & Seat Linking

Description + General Information

Bariatric Chair with Wide Arms

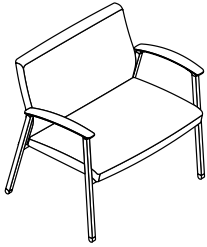

Dimensions	D	W	H	Shipping	
Overall	26 ¾	34 ¾	33 ¾	Ctn Wt	58
Seat	20	30 ¾	19	Cu Ft	22
Arm			26 ¾		

	Single Upholstery	Seat Zone 1	Back Zone 2
COM Ydg	2 ½	1	1 ½
COL Sq Ft	55	22	33

Single Upholstery Specify: Model | Upholstery | Moisture Barrier | Arm Cap | Metal Frame Finish | Glide Option

20SBWA1														
	COM	COL	A	B	C	D	E	F	G	H	I	J	L1	L2
Single Uph	\$1,883	\$2,026	\$1,905	\$1,949	\$2,026	\$2,124	\$2,223	\$2,376	\$2,541	\$2,716	\$2,991	\$3,320	\$2,749	\$2,991

Multiple Upholstery Specify: Model | Seat Upholstery | Back Upholstery | Moisture Barrier | Arm Cap | Metal Frame Finish | Glide Option

20SBWA1_M														
Base Price:	To the Base Price, add the appropriate upcharges by grade, per zone													
	COM	COL	A	B	C	D	E	F	G	H	I	J	L1	L2
Seat - Zone 1	+N/A	+\$57	+\$9	+\$27	+\$57	+\$97	+\$136	+\$198	+\$264	+\$334	+\$443	+\$575	+\$347	+\$443
Back - Zone 2	+N/A	+\$86	+\$14	+\$40	+\$86	+\$145	+\$204	+\$296	+\$395	+\$500	+\$665	+\$862	+\$520	+\$665

Model	Upholstery	Moisture Barrier	Arm Cap	Metal Frame Finish	Glide
	Grade Vendor Pattern Colorway	NMB No Moisture Barrier MB1 Moisture Barrier Seat - add \$140 MB2 Moisture Barrier Seat & Back - add \$278	PAC Polyurethane Arm Cap Set 3LAC 3D Laminated Arm Cap Set - add \$129 WAC Wood Arm Cap Set - add \$69 SAC Solid Surface Arm Cap Set - add \$357 see arm cap finishes	ABZ Aged Bronze ASL Arctic Silver GLD Gold MBK Matte Black PEW Pewter SBZ Soft Bronze SNK Soft Nickel	G10 Non Adjustable Glide G15 Leveling Glide - add \$10

Freestanding & Seat Linking

Description + General Information

Patient Chair with Narrow Arms

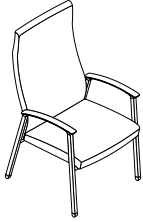

Dimensions	D	W	H	Shipping	
Overall	26 ¾	24 ½	46	Ctn Wt	48
Seat	20	21 ½	18 ½	Cu Ft	22
Arm			26 ¾		

	Single Upholstery	Seat Zone 1	Back Zone 2
COM Ydg	2 ½	1	1 ¾
COL Sq Ft	55	22	38 ½

Single Upholstery Specify: Model | Upholstery | Moisture Barrier | Arm Cap | Metal Frame Finish | Glide Option

20SP1														
	COM	COL	A	B	C	D	E	F	G	H	I	J	L1	L2
Single Uph	\$1,659	\$1,801	\$1,681	\$1,724	\$1,801	\$1,900	\$1,999	\$2,152	\$2,317	\$2,492	\$2,766	\$3,095	\$2,525	\$2,766

Multiple Upholstery Specify: Model | Seat Upholstery | Back Upholstery | Moisture Barrier | Arm Cap | Metal Frame Finish | Glide Option

20SP1_M														
Base Price: \$1,659	To the Base Price, add the appropriate upcharges by grade, per zone													
	COM	COL	A	B	C	D	E	F	G	H	I	J	L1	L2
Seat - Zone 1	+N/A	+\$58	+\$9	+\$27	+\$58	+\$97	+\$136	+\$198	+\$264	+\$334	+\$444	+\$575	+\$347	+\$444
Back - Zone 2	+N/A	+\$101	+\$16	+\$47	+\$101	+\$169	+\$238	+\$346	+\$461	+\$584	+\$776	+\$1,006	+\$607	+\$776

Model	Upholstery	Moisture Barrier	Arm Cap	Metal Frame Finish	Glide
	Grade Vendor Pattern Colorway	NMB No Moisture Barrier MB1 Moisture Barrier Seat - add \$84 MB2 Moisture Barrier Seat & Back - add \$169	PAC Polyurethane Arm Cap Set 3LAC 3D Laminate Arm Cap Set - add \$120 WAC Wood Arm Cap Set - add \$62 SAC Solid Surface Arm Cap Set - add \$352 see arm cap finishes	ABZ Aged Bronze ASL Arctic Silver GLD Gold MBK Matte Black PEW Pewter SBZ Soft Bronze SNK Soft Nickel	G10 Non Adjustable Glide G15 Leveling Glide - add \$10

Freestanding & Seat Linking

Description + General Information

Patient Chair with Wide Arms

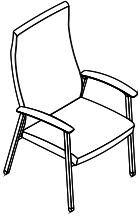

Dimensions	D	W	H	Shipping	
Overall	26 ¾	26	46	Ctn Wt	50
Seat	20	21 ½	18 ½	Cu Ft	23
Arm			26 ¼		

	Single Upholstery	Seat Zone 1	Back Zone 2
COM Ydg	2 ½	1	1 ¾
COL Sq Ft	55	22	38 ½

Single Upholstery Specify: Model | Upholstery | Moisture Barrier | Arm Cap | Metal Frame Finish | Glide Option

20SPWA1														
	COM	COL	A	B	C	D	E	F	G	H	I	J	L1	L2
Single Uph	\$1,670	\$1,812	\$1,692	\$1,736	\$1,812	\$1,911	\$2,010	\$2,163	\$2,328	\$2,503	\$2,777	\$3,106	\$3,205	\$3,614

Multiple Upholstery Specify: Model | Seat Upholstery | Back Upholstery | Moisture Barrier | Arm Cap | Metal Frame Finish | Glide Option

20SPWA1_M														
Base Price: \$1,670	To the Base Price, add the appropriate upcharges by grade, per zone													
	COM	COL	A	B	C	D	E	F	G	H	I	J	L1	L2
Seat - Zone 1	+N/A	+\$58	+\$9	+\$27	+\$58	+\$97	+\$136	+\$198	+\$264	+\$334	+\$444	+\$575	+\$347	+\$444
Back - Zone 2	+N/A	+\$101	+\$16	+\$47	+\$101	+\$169	+\$238	+\$346	+\$461	+\$584	+\$776	+\$1,006	+\$607	+\$776

Model	Upholstery	Moisture Barrier	Arm Cap	Metal Frame Finish	Glide
	Grade Vendor Pattern Colorway	NMB No Moisture Barrier MB1 Moisture Barrier Seat - add \$84 MB2 Moisture Barrier Seat & Back - add \$169	PAC Polyurethane Arm Cap Set 3LAC 3D Laminate Arm Cap Set - add \$129 WAC Wood Arm Cap Set - add \$69 SAC Solid Surface Arm Cap Set - add \$357 see arm cap finishes	ABZ Aged Bronze ASL Arctic Silver GLD Gold MBK Matte Black PEW Pewter SBZ Soft Bronze SNK Soft Nickel	G10 Non Adjustable Glide G15 Leveling Glide - add \$10

Freestanding & Seat Linking

Description + General Information

Easy Access Chair with Narrow Arms

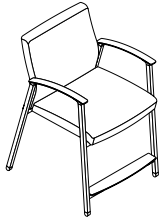

Dimensions	D	W	H	Shipping	
Overall	28	24 ½	39 ½	Ctn Wt	56
Seat	20	21 ½	24	Cu Ft	20
Arm			32 ½		

	Single Upholstery	Seat Zone 1	Back Zone 2
COM Ydg	1 ¾	1	1 ¾
COL Sq Ft	35	22	38 ½

Single Upholstery Specify: Model | Upholstery | Moisture Barrier | Arm Cap | Metal Frame Finish | Glide Option

20SE1														
	COM	COL	A	B	C	D	E	F	G	H	I	J	L1	L2
Single Uph	\$1,570	\$1,670	\$1,585	\$1,616	\$1,670	\$1,739	\$1,808	\$1,915	\$2,031	\$2,153	\$2,345	\$2,576	\$2,115	\$2,269

Multiple Upholstery Specify: Model | Seat Upholstery | Back Upholstery | Moisture Barrier | Arm Cap | Metal Frame Finish | Glide Option

20SE1_M														
Base Price: \$1,570	To the Base Price, add the appropriate upcharges by grade, per zone													
	COM	COL	A	B	C	D	E	F	G	H	I	J	L1	L2
Seat - Zone 1	+N/A	+\$57	+\$9	+\$27	+\$57	+\$97	+\$136	+\$198	+\$263	+\$334	+\$443	+\$575	+\$312	+\$399
Back - Zone 2	+N/A	+\$71	+\$11	+\$33	+\$71	+\$121	+\$170	+\$247	+\$329	+\$417	+\$554	+\$718	+\$390	+\$499

Model	Upholstery	Moisture Barrier	Arm Cap	Metal Frame Finish	Glide
	Grade Vendor Pattern Colorway	NMB No Moisture Barrier MB1 Moisture Barrier Seat - add \$84 MB2 Moisture Barrier Seat & Back - add \$169	PAC Polyurethane Arm Cap Set 3LAC 3D Laminate Arm Cap Set - add \$120 WAC Wood Arm Cap Set - add \$62 SAC Solid Surface Arm Cap Set - add \$352 see arm cap finishes	ABZ Aged Bronze ASL Arctic Silver GLD Gold MBK Matte Black PEW Pewter SBZ Soft Bronze SNK Soft Nickel	G10 Non Adjustable Glide G15 Leveling Glide - add \$10

Freestanding & Seat Linking

Description + General Information

Easy Access Chair with Wide Arms

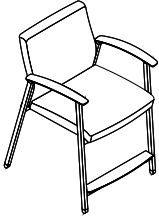

Dimensions	D	W	H	Shipping	
Overall	28	26	39 ½	Ctn Wt	58
Seat	20	21 ½	24	Cu Ft	21
Arm			32 ½		

	Single Upholstery	Seat Zone 1	Back Zone 2
COM Ydg	1 ¾	1	1 ¼
COL Sq Ft	35	20	25

Single Upholstery Specify: Model | Upholstery | Moisture Barrier | Arm Cap | Metal Frame Finish | Glide Option

20SEWA1														
	COM	COL	A	B	C	D	E	F	G	H	I	J	L1	L2
Single Uph	\$1,600	\$1,700	\$1,616	\$1,647	\$1,700	\$1,769	\$1,838	\$1,946	\$2,061	\$2,184	\$2,376	\$2,606	\$2,146	\$2,299

Multiple Upholstery Specify: Model | Seat Upholstery | Back Upholstery | Moisture Barrier | Arm Cap | Metal Frame Finish | Glide Option

20SEWA1_M														
Base Price:	To the Base Price, add the appropriate upcharges by grade, per zone													
	COM	COL	A	B	C	D	E	F	G	H	I	J	L1	L2
Seat - Zone 1	+N/A	+\$58	+\$9	+\$27	+\$58	+\$97	+\$136	+\$198	+\$263	+\$334	+\$443	+\$575	+\$312	+\$399
Back - Zone 2	+N/A	+\$72	+\$11	+\$33	+\$72	+\$121	+\$170	+\$247	+\$329	+\$417	+\$554	+\$718	+\$390	+\$499

Model	Upholstery	Moisture Barrier	Arm Cap	Metal Frame Finish	Glide
	Grade Vendor Pattern Colorway	NMB No Moisture Barrier MB1 Moisture Barrier Seat - add \$84 MB2 Moisture Barrier Seat & Back - add \$169	PAC Polyurethane Arm Cap Set 3LAC 3D Laminated Arm Cap Set - add \$129 WAC Wood Arm Cap Set - add \$69 SAC Solid Surface Arm Cap Set - add \$357 see arm cap finishes	ABZ Aged Bronze ASL Arctic Silver GLD Gold MBK Matte Black PEW Pewter SBZ Soft Bronze SNK Soft Nickel	G10 Non Adjustable Glide G15 Leveling Glide - add \$10

Description	D	W	H	CTN WT	CU FT	① Model	List Price
Connecting Hardware	1 ½	9 ½	¾	2	1	20SCH	\$233

• for connecting freestanding to be seat linking chairs

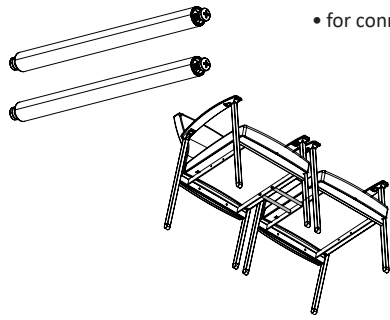

Model

Freestanding & Seat Linking

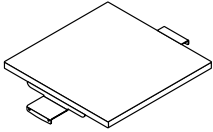
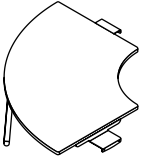
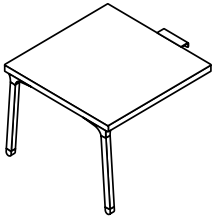
Description	D	W	H	CTN WT	CU FT	① Model	TFL Laminate	HPL Laminate
Connecting Inline Laminate Table 	21 5/8	21 5/8	16	20	2	20TI2222T	\$550	
	21 5/8	21 5/8	16	20	2	20TI2222H		\$605
	11 7/8	21 5/8	16	15	1	20TI1222T	\$510	
	11 7/8	21 5/8	16	15	1	20TI1222H		\$561
Connecting Corner Laminate Table 	35	35	16	28	4	20TC3535T	\$778	
	35	35	16	28	4	20TC3535H		\$870
	30	30	16	24	3	20TC3030T	\$752	
	30	30	16	24	3	20TC3030H		\$823
22" Connecting End Laminate Table Non-Handed 	21 5/8	21 5/8	16	21	3	20TE2222T	\$612	
	21 5/8	21 5/8	16	21	3	20TE2222H		\$672

Model	Top Surface	Metal Frame Finish	Glide (Connecting Corner and End)
	L Laminate See Satisse Laminate Finishes	ABZ Aged Bronze ASL Arctic Silver GLD Gold MBK Matte Black PEW Pewter SBZ Soft Bronze SNK Soft Nickel	G10 Non Adjustable Glide G15 Leveling Glide - add \$10

Freestanding & Seat Linking

Description	D	W	H	CTN WT	CU FT	① Model	List Price
Connecting Inline 3D Laminate Table	21 5/8	21 5/8	16	20	2	20TI2222D	\$674
	11 7/8	21 5/8	16	15	1	20TI1222D	\$598

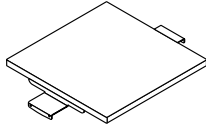

Connecting Corner 3D Laminate Table	35	35	16	28	4	20TC3535D	\$1,168
	30	30	16	24	3	20TC3030D	\$1,075

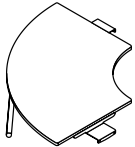

22" Connecting End 3D Laminate Table Non-Handed	21 5/8	21 5/8	16	21	3	20TE2222D	\$746
---	--------	--------	----	----	---	-----------	-------

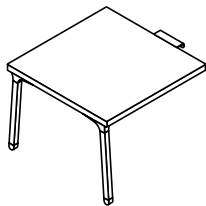

Model	Top Surface	Metal Frame Finish	Glide (Connecting Corner and End)
	D 3D Laminate See Satisse 3D Laminate Finishes	ABZ Aged Bronze ASL Arctic Silver GLD Gold MBK Matte Black PEW Pewter SBZ Soft Bronze SNK Soft Nickel	G10 Non Adjustable Glide G15 Leveling Glide - add \$10

Freestanding & Seat Linking

Description	D	W	H	CTN WT	CU FT	Model	List Price
Connecting Inline Solid Surface Table	21 7/8	21 7/8	16	22	2	20TI2222S	\$1,377
	11 7/8	21 7/8	16	15	1	20TI1222S	\$1,213

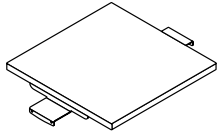

Connecting Corner Solid Surface Table	35	35	16	51	3	20TC3535S	\$1,843
	30	30	16	29	3	20TC3030S	\$1,662

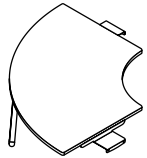

22" Connecting End Solid Surface Table	21 7/8	21 7/8	16	22	2	20TE2222S	\$1,445
---	--------	--------	----	----	---	------------------	----------------

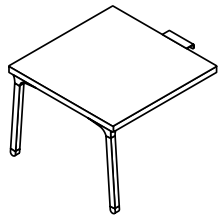

Model	Top Surface	Metal Frame Finish	Glide (Connecting Corner and End)
	S Solid Surface See Satisse Solid Surface Finish	ABZ Aged Bronze ASL Arctic Silver GLD Gold MBK Matte Black PEW Pewter SBZ Soft Bronze SNK Soft Nickel	G10 Non Adjustable Glide G15 Leveling Glide - add \$10

Freestanding & Seat Linking

Description	D	W	H	CTN WT	CU FT	① Model	Essentials Veneer	Artisan Veneer
Connecting Inline Veneer Table	21 5/8	21 5/8	16	20	2	20TI2222V	\$799	\$879
	11 7/8	21 5/8	16	15	1	20TI1222V	\$751	\$826

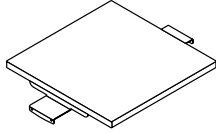

Connecting Corner Veneer Table	35	35	16	28	4	20TC3535V	\$1,231	\$1,354
	30	30	16	24	3	20TC3030V	\$1,109	\$1,220

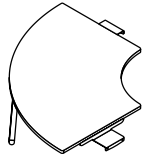

22" Connecting End Veneer Table Non-Handed	21 5/8	21 5/8	16	18	2	20TE2222V	\$887	\$976
--	--------	--------	----	----	---	------------------	-------	-------

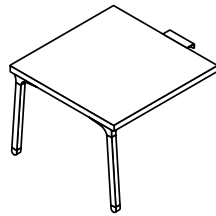

Model	Top Surface	Metal Frame Finish	Glide (Connecting Corner and End)
	V Veneer See Satisse Veneer Finishes	ABZ Aged Bronze ASL Arctic Silver GLD Gold MBK Matte Black PEW Pewter SBZ Soft Bronze SNK Soft Nickel	G10 Non Adjustable Glide G15 Leveling Glide - add \$10

Freestanding Tables

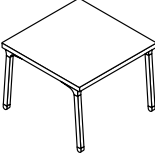
Description	D	W	H	CTN WT	CU FT	① Model	List Price
Side Table 	21 3/8	21 3/8	16	16	2	20TFS2222T - TFL Laminate	\$640
	21 3/8	21 3/8	16	16	2	20TFS2222H - HPL Laminate	\$680
	21 3/8	21 3/8	16	16	2	20TFS2222D - 3D Laminate	\$802
	21 3/8	21 3/8	16	22	2	20TFS2222S - Solid Surface	\$1,487

Model	Top Surface	Metal Frame Finish	Glide
	T Laminate See Satisse TFL Laminate Finishes	ABZ Aged Bronze ASL Arctic Silver	G10 Non Adjustable Glide G15 Leveling Glide - add \$10
	H Laminate See Satisse HPL Laminate Finishes	GLD Gold MBK Matte Black	
	D 3D Laminate See Satisse 3D Laminate Finishes	PEW Pewter	
	S Solid Surface See Satisse Solid Surface Finish	SBZ Soft Bronze SNK Soft Nickel	
	V Veneer See Satisse Veneer Finishes		
	see top surface for pricing		

Freestanding Tables

Description	D	W	H	CTN WT	CU FT	① Model	List Price
Magazine Table	21 5/8	42	16	27	3	20TFM2242T - TFL Laminate	\$767

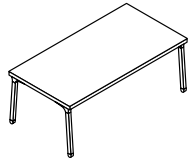

21 5/8	42	16	27	3	20TFM2242H - HPL Laminate	\$818
--------	----	----	----	---	---------------------------	-------

21 5/8	42	16	27	3	20TFM2242D - 3D Laminate	\$1,095
--------	----	----	----	---	--------------------------	---------

21 5/8	42	16	40	3	20TFM2242S - Solid Surface	\$1,782
--------	----	----	----	---	----------------------------	---------

Model	Top Surface	Metal Frame Finish	Glide
T	Laminate See Satisse TFL Laminate Finishes	ABZ Aged Bronze	G10 Non Adjustable Glide
H	Laminate See Satisse HPL Laminate Finishes	ASL Arctic Silver	G15 Leveling Glide - add \$10
D	3D Laminate See Satisse 3D Laminate Finishes	GLD Gold	
S	Solid Surface See Satisse Solid Surface Finish	MBK Matte Black	
V	Veneer See Satisse Veneer Finishes	PEW Pewter	
	see top surface for pricing	SBZ Soft Bronze	
		SNK Soft Nickel	

Freestanding Tables

Description	D	W	H	CTN WT	CU FT	① Model	Essentials Veneer	Artisan Veneer
Side Veneer Table	21 5/8	21 5/8	16	16	2	20TFS2222V	\$914	\$1,005



Magazine Veneer Table	21 5/8	42	16	27	3	20TFM2242V	\$1,050	\$1,155
-----------------------	--------	----	----	----	---	------------	---------	---------

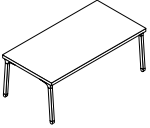

Model	Top Surface	Metal Frame Finish	Glide
	V Veneer See Satisse Veneer Finishes	ABZ Aged Bronze ASL Arctic Silver GLD Gold MBK Matte Black PEW Pewter SBZ Soft Bronze SNK Soft Nickel	G10 Non Adjustable Glide G15 Leveling Glide - add \$10

Glide Linking

Description + General Information

Armless Glide Linking Guest Chair • links on both sides

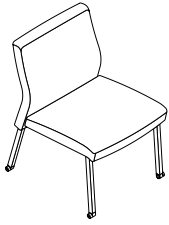

Dimensions	D	W	H	Shipping	
				Ctn Wt	
Overall	26 ¾	22	33	33	
Seat	20	21 ½	18 ½	Cu Ft	14

	Single Upholstery	Seat Zone 1	Back Zone 2
COM Ydg	1 ¾	1	1 ¼
COL Sq Ft	35	20	25

Single Upholstery Specify: Model | Upholstery | Moisture Barrier | Metal Frame Finish | Glide Option

20SGXAG1														
	COM	COL	A	B	C	D	E	F	G	H	I	J	L1	L2
Single Uph	\$1,184	\$1,283	\$1,199	\$1,230	\$1,283	\$1,353	\$1,422	\$1,529	\$1,644	\$1,767	\$1,959	\$2,189	\$1,729	\$1,882

Multiple Upholstery Specify: Model | Seat Upholstery | Back Upholstery | Moisture Barrier | Metal Frame Finish | Glide Option

20SGXAG1_M														
Base Price:\$1,184	To the Base Price, add the appropriate upcharges by grade, per zone													
	COM	COL	A	B	C	D	E	F	G	H	I	J	L1	L2
Seat - Zone 1	+N/A	+\$58	+\$9	+\$27	+\$58	+\$97	+\$136	+\$198	+\$264	+\$334	+\$443	+\$575	+\$312	+\$400
Back - Zone 2	+N/A	+\$72	+\$11	+\$33	+\$72	+\$121	+\$170	+\$248	+\$330	+\$418	+\$554	+\$719	+\$390	+\$500

Model	Upholstery	Moisture Barrier	Metal Frame Finish	Glide
	Grade Vendor Pattern Colorway	NMB No Moisture Barrier MB1 Moisture Barrier Seat - add \$84 MB2 Moisture Barrier Seat & Back - add \$169	ABZ Aged Bronze ASL Arctic Silver GLD Gold MBK Matte Black PEW Pewter SBZ Soft Bronze SNK Soft Nickel	G20 MagLinx™ G25 BoltLinx

Glide Linking

Description + General Information

Armless Glide Linking Guest Chair - Right End • links on left as seated

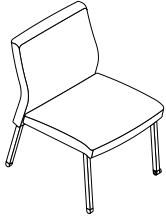

Dimensions	D	W	H	Shipping	
Overall	26 ¾	22	33	Ctn Wt	33
Seat	20	21 ½	18 ½	Cu Ft	14

	Single Upholstery	Seat Zone 1	Back Zone 2
COM Ydg	1 ¾	1	1 ¾
COL Sq Ft	35	20	25

Single Upholstery Specify: Model | Upholstery | Moisture Barrier | Metal Frame Finish | Glide Option

20SGXAGR1														
	COM	COL	A	B	C	D	E	F	G	H	I	J	L1	L2
Single Uph	\$1,184	\$1,283	\$1,199	\$1,230	\$1,283	\$1,353	\$1,422	\$1,529	\$1,644	\$1,767	\$1,959	\$2,189	\$1,729	\$1,882

Multiple Upholstery Specify: Model | Seat Upholstery | Back Upholstery | Moisture Barrier | Metal Frame Finish | Glide Option

20SGXAGR1_M														
Base Price: \$1,184	To the Base Price, add the appropriate upcharges by grade, per zone													
	COM	COL	A	B	C	D	E	F	G	H	I	J	L1	L2
Seat - Zone 1	+N/A	+\$58	+\$9	+\$27	+\$58	+\$97	+\$136	+\$198	+\$264	+\$334	+\$443	+\$575	+\$312	+\$400
Back - Zone 2	+N/A	+\$72	+\$11	+\$33	+\$72	+\$121	+\$170	+\$248	+\$330	+\$418	+\$554	+\$719	+\$390	+\$500

Model	Upholstery	Moisture Barrier	Metal Frame Finish	Glide
	Grade Vendor Pattern Colorway	NMB No Moisture Barrier MB1 Moisture Barrier Seat - add \$84 MB2 Moisture Barrier Seat & Back - add \$169	ABZ Aged Bronze ASL Arctic Silver GLD Gold MBK Matte Black PEW Pewter SBZ Soft Bronze SNK Soft Nickel	G20 MagLinx™ G25 BoltLinx

Glide Linking

Description + General Information

Armless Glide Linking Guest Chair - Left End • links on right as seated

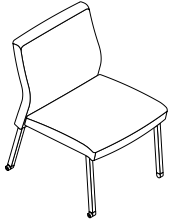

Dimensions	D	W	H	Shipping	
				Ctn Wt	
Overall	26 ¾	22	33	33	
Seat	20	21 ½	18 ½	Cu Ft	14

	Single Upholstery	Seat Zone 1	Back Zone 2
COM Ydg	1 ¾	1	1 ¼
COL Sq Ft	35	20	25

Single Upholstery Specify: Model | Upholstery | Moisture Barrier | Metal Frame Finish | Glide Option

20SGXAGL1														
	COM	COL	A	B	C	D	E	F	G	H	I	J	L1	L2
Single Uph	\$1,184	\$1,283	\$1,199	\$1,230	\$1,283	\$1,353	\$1,422	\$1,529	\$1,644	\$1,767	\$1,959	\$2,189	\$1,729	\$1,882

Multiple Upholstery Specify: Model | Seat Upholstery | Back Upholstery | Moisture Barrier | Metal Frame Finish | Glide Option

20SGXAGL1_M														
Base Price: \$1,184	To the Base Price, add the appropriate upcharges by grade, per zone													
	COM	COL	A	B	C	D	E	F	G	H	I	J	L1	L2
Seat - Zone 1	+N/A	+\$58	+\$9	+\$27	+\$58	+\$97	+\$136	+\$198	+\$264	+\$334	+\$443	+\$575	+\$312	+\$400
Back - Zone 2	+N/A	+\$72	+\$11	+\$33	+\$72	+\$121	+\$170	+\$248	+\$330	+\$418	+\$554	+\$719	+\$390	+\$500

Model	Upholstery	Moisture Barrier	Metal Frame Finish	Glide
	Grade Vendor Pattern Colorway	NMB No Moisture Barrier MB1 Moisture Barrier Seat - add \$84 MB2 Moisture Barrier Seat & Back - add \$169	ABZ Aged Bronze ASL Arctic Silver GLD Gold MBK Matte Black PEW Pewter SBZ Soft Bronze SNK Soft Nickel	G20 MagLinx™ G25 BoltLinx

Glide Linking

Description + General Information

Glide Linking Guest Chair with Narrow Arms • links on both sides

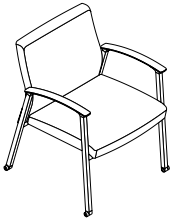

Dimensions	D	W	H	Shipping	
Overall	26 ¾	24 ½	33	Ctn Wt	41
Seat	20	21 ½	18 ½	Cu Ft	16
Arm			26 ¼		

	Single Upholstery	Seat Zone 1	Back Zone 2
COM Ydg	1 ¾	1	1 ¼
COL Sq Ft	35	20	25

Single Upholstery Specify: Model | Upholstery | Moisture Barrier | Arm Cap | Metal Frame Finish | Glide Option

20SGG1														
	COM	COL	A	B	C	D	E	F	G	H	I	J	L1	L2
Single Uph	\$1,479	\$1,579	\$1,495	\$1,525	\$1,579	\$1,648	\$1,717	\$1,825	\$1,940	\$2,063	\$2,255	\$2,485	\$2,024	\$2,178

Multiple Upholstery Specify: Model | Seat Upholstery | Back Upholstery | Moisture Barrier | Arm Cap | Metal Frame Finish | Glide Option

20SGG1_M														
Base Price:	To the Base Price, add the appropriate upcharges by grade, per zone													
	COM	COL	A	B	C	D	E	F	G	H	I	J	L1	L2
Seat - Zone 1	+N/A	+\$58	+\$9	+\$27	+\$58	+\$97	+\$136	+\$198	+\$263	+\$334	+\$443	+\$575	+\$312	+\$399
Back - Zone 2	+N/A	+\$72	+\$11	+\$33	+\$72	+\$121	+\$170	+\$247	+\$329	+\$417	+\$554	+\$718	+\$390	+\$499

Model	Upholstery	Moisture Barrier	Arm Cap	Metal Frame Finish	Glide
	Grade Vendor Pattern Colorway	NMB No Moisture Barrier MB1 Moisture Barrier Seat - add \$84 MB2 Moisture Barrier Seat & Back - add \$169	PAC Polyurethane Arm Cap Set 3LAC 3D Laminate Arm Cap Set - add \$120 WAC Wood Arm Cap Set - add \$62 SAC Solid Surface Arm Cap Set - add \$352 see arm cap finishes	ABZ Aged Bronze ASL Arctic Silver GLD Gold MBK Matte Black PEW Pewter SBZ Soft Bronze SNK Soft Nickel	G20 MagLinx™ G25 BoltLinx

Glide Linking

Description + General Information

Glide Linking Guest Chair with Narrow Arm - Right End • links on left as seated

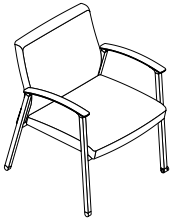

Dimensions	D	W	H	Shipping	
Overall	26 ¾	24 ½	33	Ctn Wt	41
Seat	20	21 ½	18 ½	Cu Ft	16
Arm			26 ¼		

	Single Upholstery	Seat Zone 1	Back Zone 2
COM Ydg	1 ¾	1	1 ¼
COL Sq Ft	35	20	25

Single Upholstery Specify: Model | Upholstery | Moisture Barrier | Arm Cap | Metal Frame Finish | Glide Option

20SGGR1														
	COM	COL	A	B	C	D	E	F	G	H	I	J	L1	L2
Single Uph	\$1,479	\$1,579	\$1,495	\$1,525	\$1,579	\$1,648	\$1,717	\$1,825	\$1,940	\$2,063	\$2,255	\$2,485	\$2,024	\$2,178

Multiple Upholstery Specify: Model | Seat Upholstery | Back Upholstery | Moisture Barrier | Arm Cap | Metal Frame Finish | Glide Option

20SGGR1_M														
Base Price:	\$1,479	To the Base Price, add the appropriate upcharges by grade, per zone												
	COM	COL	A	B	C	D	E	F	G	H	I	J	L1	L2
Seat - Zone 1	+N/A	+\$58	+\$9	+\$27	+\$58	+\$97	+\$136	+\$198	+\$263	+\$334	+\$443	+\$575	+\$312	+\$399
Back - Zone 2	+N/A	+\$72	+\$11	+\$33	+\$72	+\$121	+\$170	+\$247	+\$329	+\$417	+\$554	+\$718	+\$390	+\$499

Model	Upholstery	Moisture Barrier	Arm Cap	Metal Frame Finish	Glide
	Grade Vendor Pattern Colorway	NMB No Moisture Barrier MB1 Moisture Barrier Seat - add \$84 MB2 Moisture Barrier Seat & Back - add \$169	PAC Polyurethane Arm Cap Set 3LAC 3D Laminate Arm Cap Set - add \$120 WAC Wood Arm Cap Set - add \$62 SAC Solid Surface Arm Cap Set - add \$352 see arm cap finishes	ABZ Aged Bronze ASL Arctic Silver GLD Gold MBK Matte Black PEW Pewter SBZ Soft Bronze SNK Soft Nickel	G20 MagLinx™ G25 BoltLinx

Glide Linking

Description + General Information

Glide Linking Guest Chair with Narrow Arms - Left End • links on right as seated

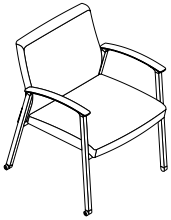

Dimensions	D	W	H	Shipping	
Overall	26 ¾	24 ½	33	Ctn Wt	41
Seat	20	21 ½	18 ½	Cu Ft	16
Arm			26 ¼		

	Single Upholstery	Seat Zone 1	Back Zone 2
COM Ydg	1 ¾	1	1 ¼
COL Sq Ft	35	20	25

Single Upholstery Specify: Model | Upholstery | Moisture Barrier | Arm Cap | Metal Frame Finish | Glide Option

20SGGL1														
	COM	COL	A	B	C	D	E	F	G	H	I	J	L1	L2
Single Uph	\$1,479	\$1,579	\$1,495	\$1,525	\$1,579	\$1,648	\$1,717	\$1,825	\$1,940	\$2,063	\$2,255	\$2,485	\$2,024	\$2,178

Multiple Upholstery Specify: Model | Seat Upholstery | Back Upholstery | Moisture Barrier | Arm Cap | Metal Frame Finish | Glide Option

20SGGL1_M														
Base Price:	To the Base Price, add the appropriate upcharges by grade, per zone													
	COM	COL	A	B	C	D	E	F	G	H	I	J	L1	L2
Seat - Zone 1	+N/A	+\$58	+\$9	+\$27	+\$58	+\$97	+\$136	+\$198	+\$263	+\$334	+\$443	+\$575	+\$312	+\$399
Back - Zone 2	+N/A	+\$72	+\$11	+\$33	+\$72	+\$121	+\$170	+\$247	+\$329	+\$417	+\$554	+\$718	+\$390	+\$499

Model	Upholstery	Moisture Barrier	Arm Cap	Metal Frame Finish	Glide
	Grade Vendor Pattern Colorway	NMB No Moisture Barrier MB1 Moisture Barrier Seat - add \$84 MB2 Moisture Barrier Seat & Back - add \$169	PAC Polyurethane Arm Cap Set 3LAC 3D Laminated Arm Cap Set - add \$120 WAC Wood Arm Cap Set - add \$62 SAC Solid Surface Arm Cap Set - add \$352 see arm cap finishes	ABZ Aged Bronze ASL Arctic Silver GLD Gold MBK Matte Black PEW Pewter SBZ Soft Bronze SNK Soft Nickel	G20 MagLinx™ G25 BoltLinx

Glide Linking

Description + General Information

Two Seat Glide Linking Chair with Narrow Arms • links on both ends

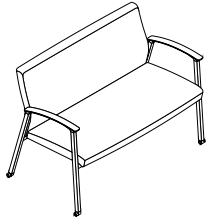

Dimensions	D	W	H	Shipping	
Overall	26 ¾	45 ½	33 ¾	Ctn Wt	75
Seat	20	42 ½	18 ½	Cu Ft	28
Arm			26 ¾		

	Single Upholstery	Seat Zone 1	Back Zone 2
COM Ydg	2 ¾	1 ¼	1 ½
COL Sq Ft	60 ½	27 ½	33

Single Upholstery Specify: Model | Upholstery | Moisture Barrier | Arm Cap | Metal Frame Finish | Glide Option

20SGG2														
	COM	COL	A	B	C	D	E	F	G	H	I	J	L1	L2
Single Uph	\$2,269	\$2,426	\$2,293	\$2,341	\$2,426	\$2,534	\$2,643	\$2,812	\$2,993	\$3,186	\$3,487	\$3,849	\$3,222	\$3,487

Multiple Upholstery Specify: Model | Seat Upholstery | Back Upholstery | Moisture Barrier | Arm Cap | Metal Frame Finish | Glide Option

20SGG2_M														
Base Price: \$2,269	To the Base Price, add the appropriate upcharges by grade, per zone													
	COM	COL	A	B	C	D	E	F	G	H	I	J	L1	L2
Seat - Zone 1	+N/A	+\$72	+\$11	+\$34	+\$72	+\$121	+\$170	+\$247	+\$330	+\$417	+\$555	+\$719	+\$434	+\$555
Back - Zone 2	+N/A	+\$86	+\$14	+\$40	+\$86	+\$146	+\$204	+\$297	+\$395	+\$501	+\$665	+\$863	+\$520	+\$665

Model	Upholstery	Moisture Barrier	Arm Cap	Metal Frame Finish	Glide
	Grade Vendor Pattern Colorway	NMB No Moisture Barrier MB1 Moisture Barrier Seat - add \$140 MB2 Moisture Barrier Seat & Back - add \$278	PAC Polyurethane Arm Cap Set 3LAC 3D Laminate Arm Cap Set - add \$120 WAC Wood Arm Cap Set - add \$62 SAC Solid Surface Arm Cap Set - add \$352 see arm cap finishes	ABZ Aged Bronze ASL Arctic Silver GLD Gold MBK Matte Black PEW Pewter SBZ Soft Bronze SNK Soft Nickel	G20 MagLinx™ G25 BoltLinx

Glide Linking

Description + General Information

Two Seat Glide Linking Guest Chair • links on left as seated with Narrow Arm - Right End

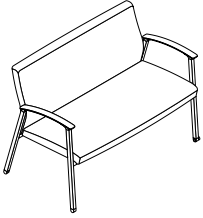

Dimensions	D	W	H	Shipping	
Overall	26 ¾	45 ½	33 ¾	Ctn Wt	75
Seat	20	42 ½	18 ½	Cu Ft	28
Arm			26 ¾		

	Single Upholstery	Seat Zone 1	Back Zone 2
COM Ydg	2 ¾	1 ¼	1 ½
COL Sq Ft	60 ½	27 ½	33

Single Upholstery Specify: Model | Upholstery | Moisture Barrier | Arm Cap | Metal Frame Finish | Glide Option

20SGGR2														
	COM	COL	A	B	C	D	E	F	G	H	I	J	L1	L2
Single Uph	\$2,269	\$2,426	\$2,293	\$2,341	\$2,426	\$2,534	\$2,643	\$2,812	\$2,993	\$3,186	\$3,487	\$3,849	\$3,222	\$3,487

Multiple Upholstery Specify: Model | Seat Upholstery | Back Upholstery | Moisture Barrier | Arm Cap | Metal Frame Finish | Glide Option

20SGGR2_M														
Base Price: \$2,269	To the Base Price, add the appropriate upcharges by grade, per zone													
	COM	COL	A	B	C	D	E	F	G	H	I	J	L1	L2
Seat - Zone 1	+N/A	+\$72	+\$11	+\$34	+\$72	+\$121	+\$170	+\$247	+\$330	+\$417	+\$555	+\$719	+\$434	+\$555
Back - Zone 2	+N/A	+\$86	+\$14	+\$40	+\$86	+\$146	+\$204	+\$297	+\$395	+\$501	+\$665	+\$863	+\$520	+\$665

Model	Upholstery	Moisture Barrier	Arm Cap	Metal Frame Finish	Glide
	Grade Vendor Pattern Colorway	NMB No Moisture Barrier MB1 Moisture Barrier Seat - add \$140 MB2 Moisture Barrier Seat & Back - add \$278	PAC Polyurethane Arm Cap Set 3LAC 3D Laminate Arm Cap Set - add \$120 WAC Wood Arm Cap Set - add \$62 SAC Solid Surface Arm Cap Set - add \$352 see arm cap finishes	ABZ Aged Bronze ASL Arctic Silver GLD Gold MBK Matte Black PEW Pewter SBZ Soft Bronze SNK Soft Nickel	G20 MagLinx™ G25 BoltLinx

Glide Linking

Description + General Information

Two Seat Glide Linking Guest Chair with Narrow Arms - Left End • links on right as seated

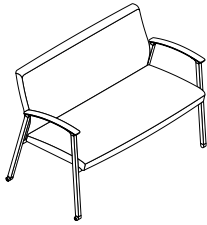

Dimensions	D	W	H	Shipping	
Overall	26 ¾	45 ½	33 ¾	Ctn Wt	75
Seat	20	42 ½	18 ½	Cu Ft	28
Arm			26 ¾		

	Single Upholstery	Seat Zone 1	Back Zone 2
COM Ydg	2 ¾	1 ¼	1 ½
COL Sq Ft	60 ½	27 ½	33

Single Upholstery Specify: Model | Upholstery | Moisture Barrier | Arm Cap | Metal Frame Finish | Glide Option

20SGGL2														
	COM	COL	A	B	C	D	E	F	G	H	I	J	L1	L2
Single Uph	\$2,269	\$2,426	\$2,293	\$2,341	\$2,426	\$2,534	\$2,643	\$2,812	\$2,993	\$3,186	\$3,487	\$3,849	\$3,222	\$3,487

Multiple Upholstery Specify: Model | Seat Upholstery | Back Upholstery | Moisture Barrier | Arm Cap | Metal Frame Finish | Glide Option

20SGGL2_M														
Base Price: \$2,269	To the Base Price, add the appropriate upcharges by grade, per zone													
	COM	COL	A	B	C	D	E	F	G	H	I	J	L1	L2
Seat - Zone 1	+N/A	+\$72	+\$11	+\$34	+\$72	+\$121	+\$170	+\$247	+\$330	+\$417	+\$555	+\$719	+\$434	+\$555
Back - Zone 2	+N/A	+\$86	+\$14	+\$40	+\$86	+\$146	+\$204	+\$297	+\$395	+\$501	+\$665	+\$863	+\$520	+\$665

Model	Upholstery	Moisture Barrier	Arm Cap	Metal Frame Finish	Glide
	Grade Vendor Pattern Colorway	NMB No Moisture Barrier MB1 Moisture Barrier Seat - add \$140 MB2 Moisture Barrier Seat & Back - add \$278	PAC Polyurethane Arm Cap Set 3LAC 3D Laminate Arm Cap Set - add \$120 WAC Wood Arm Cap Set - add \$62 SAC Solid Surface Arm Cap Set - add \$352 see arm cap finishes	ABZ Aged Bronze ASL Arctic Silver GLD Gold MBK Matte Black PEW Pewter SBZ Soft Bronze SNK Soft Nickel	G20 MagLinx™ G25 BoltLinx

Glide Linking

Description + General Information

Bariatric Glide Linking Chair with Narrow Arm • links on both sides

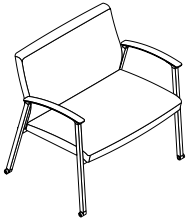

Dimensions	D	W	H	Shipping	
Overall	26 ¾	33	33 ¾	Ctn Wt	56
Seat	20	30 ¾	19	Cu Ft	21
Arm			26 ¾		

	Single Upholstery	Seat Zone 1	Back Zone 2
COM Ydg	2 ½	1	1 ½
COL Sq Ft	55	22	33

Single Upholstery Specify: Model | Upholstery | Moisture Barrier | Arm Cap | Metal Frame Finish | Glide Option

20SBG1														
	COM	COL	A	B	C	D	E	F	G	H	I	J	L1	L2
Single Uph	\$1,973	\$2,116	\$1,995	\$2,039	\$2,116	\$2,214	\$2,313	\$2,466	\$2,631	\$2,806	\$3,081	\$3,410	\$2,839	\$3,081

Multiple Upholstery Specify: Model | Seat Upholstery | Back Upholstery | Moisture Barrier | Arm Cap | Metal Frame Finish | Glide Option

20SBG1_M														
Base Price:	To the Base Price, add the appropriate upcharges by grade, per zone													
	COM	COL	A	B	C	D	E	F	G	H	I	J	L1	L2
Seat - Zone 1	+N/A	+\$57	+\$9	+\$27	+\$57	+\$97	+\$136	+\$198	+\$264	+\$334	+\$443	+\$575	+\$347	+\$443
Back - Zone 2	+N/A	+\$86	+\$14	+\$40	+\$86	+\$145	+\$204	+\$296	+\$395	+\$500	+\$665	+\$862	+\$520	+\$665

Model	Upholstery	Moisture Barrier	Arm Cap	Metal Frame Finish	Glide
	Grade Vendor Pattern Colorway	NMB No Moisture Barrier MB1 Moisture Barrier Seat - add \$140 MB2 Moisture Barrier Seat & Back - add \$278	PAC Polyurethane Arm Cap Set 3LAC 3D Laminated Arm Cap Set - add \$120 WAC Wood Arm Cap Set - add \$62 SAC Solid Surface Arm Cap Set - add \$352 see arm cap finishes	ABZ Aged Bronze ASL Arctic Silver GLD Gold MBK Matte Black PEW Pewter SBZ Soft Bronze SNK Soft Nickel	G20 MagLinx™ G25 BoltLinx

Glide Linking

Description + General Information

Bariatric Glide Linking Chair with Narrow Arm - Right End • links on left as seated

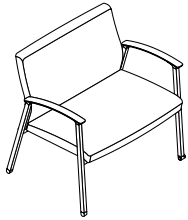

Dimensions	D	W	H	Shipping	
Overall	26 ¾	33	33 ¼	Ctn Wt	56
Seat	20	30 ¼	19	Cu Ft	21
Arm			26 ¼		

	Single Upholstery	Seat Zone 1	Back Zone 2
COM Ydg	2 ½	1	1 ½
COL Sq Ft	55	22	33

Single Upholstery Specify: Model | Upholstery | Moisture Barrier | Arm Cap | Metal Frame Finish | Glide Option

20SBGR1														
	COM	COL	A	B	C	D	E	F	G	H	I	J	L1	L2
Single Uph	\$1,973	\$2,116	\$1,995	\$2,039	\$2,116	\$2,214	\$2,313	\$2,466	\$2,631	\$2,806	\$3,081	\$3,410	\$2,839	\$3,081

Multiple Upholstery Specify: Model | Seat Upholstery | Back Upholstery | Moisture Barrier | Arm Cap | Metal Frame Finish | Glide Option

20SBGR1_M														
Base Price:	To the Base Price, add the appropriate upcharges by grade, per zone													
	COM	COL	A	B	C	D	E	F	G	H	I	J	L1	L2
Seat - Zone 1	+N/A	+\$57	+\$9	+\$27	+\$57	+\$97	+\$136	+\$198	+\$264	+\$334	+\$443	+\$575	+\$347	+\$443
Back - Zone 2	+N/A	+\$86	+\$14	+\$40	+\$86	+\$145	+\$204	+\$296	+\$395	+\$500	+\$665	+\$862	+\$520	+\$665

Model	Upholstery	Moisture Barrier	Arm Cap	Metal Frame Finish	Glide
	Grade Vendor Pattern Colorway	NMB No Moisture Barrier MB1 Moisture Barrier Seat - add \$140 MB2 Moisture Barrier Seat & Back - add \$278	PAC Polyurethane Arm Cap Set 3LAC 3D Laminate Arm Cap Set - add \$120 WAC Wood Arm Cap Set - add \$62 SAC Solid Surface Arm Cap Set - add \$352 see arm cap finishes	ABZ Aged Bronze ASL Arctic Silver GLD Gold MBK Matte Black PEW Pewter SBZ Soft Bronze SNK Soft Nickel	G20 MagLinx™ G25 BoltLinx

Glide Linking

Description + General Information

Bariatric Glide Linking Chair with Narrow Arm - Left End • links on right as seated

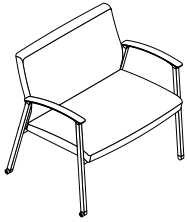

Dimensions	D	W	H	Shipping	
Overall	26 ¾	33	33 ¼	Ctn Wt	56
Seat	20	30 ¼	19	Cu Ft	21
Arm			26 ¼		

	Single Upholstery	Seat Zone 1	Back Zone 2
COM Ydg	2 ½	1	1 ¼
COL Sq Ft	55	20	25

Single Upholstery Specify: Model | Upholstery | Moisture Barrier | Arm Cap | Metal Frame Finish | Glide Option

20SBGL1														
	COM	COL	A	B	C	D	E	F	G	H	I	J	L1	L2
Single Uph	\$1,973	\$2,116	\$1,995	\$2,039	\$2,116	\$2,214	\$2,313	\$2,466	\$2,631	\$2,806	\$3,081	\$3,410	\$2,839	\$3,081

Multiple Upholstery Specify: Model | Seat Upholstery | Back Upholstery | Moisture Barrier | Arm Cap | Metal Frame Finish | Glide Option

20SBGL1_M														
Base Price:	To the Base Price, add the appropriate upcharges by grade, per zone													
	COM	COL	A	B	C	D	E	F	G	H	I	J	L1	L2
Seat - Zone 1	+N/A	+\$57	+\$9	+\$27	+\$57	+\$97	+\$136	+\$198	+\$264	+\$334	+\$443	+\$575	+\$347	+\$443
Back - Zone 2	+N/A	+\$86	+\$14	+\$40	+\$86	+\$145	+\$204	+\$296	+\$395	+\$500	+\$665	+\$862	+\$520	+\$665

Model	Upholstery	Moisture Barrier	Arm Cap	Metal Frame Finish	Glide
	Grade Vendor Pattern Colorway	NMB No Moisture Barrier MB1 Moisture Barrier Seat - add \$140 MB2 Moisture Barrier Seat & Back - add \$278	PAC Polyurethane Arm Cap Set 3LAC 3D Laminated Arm Cap Set - add \$120 WAC Wood Arm Cap Set - add \$62 SAC Solid Surface Arm Cap Set - add \$352 see arm cap finishes	ABZ Aged Bronze ASL Arctic Silver GLD Gold MBK Matte Black PEW Pewter SBZ Soft Bronze SNK Soft Nickel	G20 MagLinx™ G25 BoltLinx

Glide Linking

Description	D	W	H	CTN WT	CU FT	① Model	TFL Laminate	HPL Laminate
Inline Laminate Table Links on Both Sides	21 7/8	21 7/8	16	19	2	20TIG2222T	\$713	
	21 7/8	21 7/8	16	19	2	20TIG2222H		\$758
	11 7/8	21 7/8	16	15	1	20TIG1222T	\$698	
	11 7/8	21 7/8	16	15	1	20TIG1222H		\$729

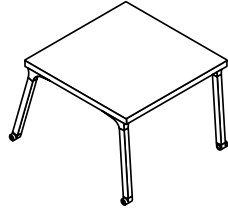

Corner Laminate Table Links on Both Sides	35	35	16	29	3	20TCG3535T	\$983	
	35	35	16	29	3	20TCG3535H		\$1,075
	30	30	16	24	3	20TCG3030T	\$946	
	30	30	16	24	3	20TCG3030H		\$1,017

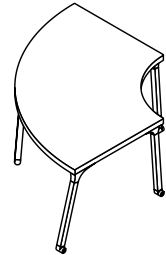

Laminate End Table	21 7/8	21 7/8	16	16	2	right	20TEGR2222T	\$713	
	21 7/8	21 7/8	16	16	2	right	20TEGR2222H		\$758
	21 7/8	21 7/8	16	16	2	left	20TEGL2222T	\$713	
	21 7/8	21 7/8	16	16	2	left	20TEGL2222H		\$758

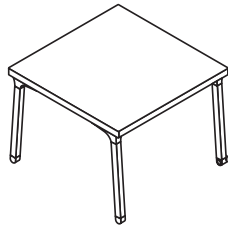

right end shown as seated

Model

Top Surface

TFL Laminate
[See Satisse TFL Finishes](#)
 HPL Laminate
[See Satisse HPL Finishes](#)

see top surface for pricing

Metal Frame Finish

ABZ Aged Bronze
 ASL Arctic Silver
 GLD Gold
 MBK Matte Black
 PEW Pewter
 SBZ Soft Bronze
 SNK Soft Nickel

Glide

G20 MagLinx™
 G25 BoltLinx

Glide Linking

Description	D	W	H	CTN WT	CU FT	Model	List Price
Inline 3D Laminate Table Links on Both Sides	21 7/8	21 7/8	16	19	2	20TIG2222D	\$825
	11 7/8	21 7/8	16	15	1	20TIG1222D	\$772

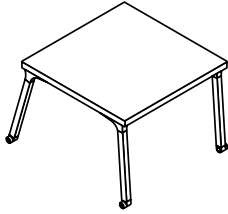

Corner 3D Laminate Table Links on Both Sides	35	35	16	29	3	20TCG3535D	\$1,360
	30	30	16	24	3	20TCG3030D	\$1,137

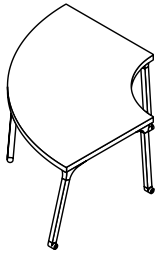

End 3D Laminate Table	21 7/8	21 7/8	16	16	2	right	20TEGR2222D	\$825
	21 7/8	21 7/8	16	16	2	left	20TEGL2222D	\$825

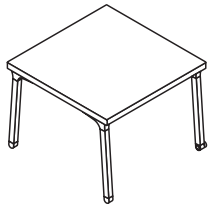

right end shown as seated

Model	Top Surface	Metal Frame Finish	Glide
	D 3D Laminate See Satisse 3D Laminate Finishes see top surface for pricing	ABZ Aged Bronze ASL Arctic Silver GLD Gold MBK Matte Black PEW Pewter SBZ Soft Bronze SNK Soft Nickel	G20 MagLinx™ G25 BoltLinx

Glide Linking

Description	D	W	H	CTN WT	CU FT	① Model	List Price
Inline Solid Surface Table	21 5/8	21 5/8	16	19	2	20TIG2222S	\$1,518
Links on Both Sides	11 7/8	21 5/8	16	16	1	20TIG1222S	\$1,332

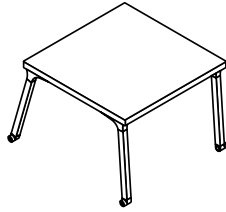

Corner Solid Surface Table	35	35	16	51	3	20TCG3535S	\$2,077
Links on Both Sides	30	30	16	29	3	20TCG3030S	\$1,733

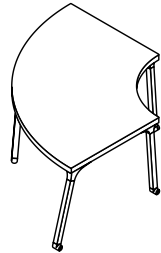

End Solid Surface Table	21 5/8	21 5/8	16	22	2	right	20TEGR2222S	\$1,518
	21 5/8	21 5/8	16	22	2	left	20TEGL2222S	\$1,518

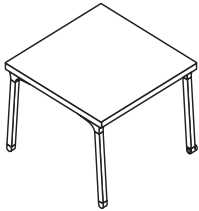

right end shown as seated

Model	Top Surface	Metal Frame Finish	Glide
	S Solid Surface See Satisse Solid Surface Finish	ABZ Aged Bronze ASL Arctic Silver GLD Gold MBK Matte Black PEW Pewter SBZ Soft Bronze SNK Soft Nickel	G20 MagLinx™ G25 BoltLinx

Glide Linking

Description	D	W	H	CTN WT	CU FT	Model	Essentials Veneer	Artisan Veneer
Inline Veneer Table	21 5/8	21 5/8	16	19	2	20TIG2222V	\$956	\$1,052
Links on Both Sides	11 7/8	21 5/8	16	15	1	20TIG1222V	\$940	\$1,034

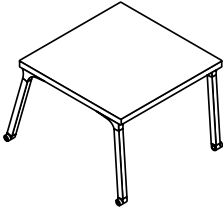

Corner Veneer Table	35	35	16	29	3	20TCG3535V	\$1,437	\$1,581
Links on Both Sides	30	30	16	24	3	20TCG3030V	\$1,170	\$1,287

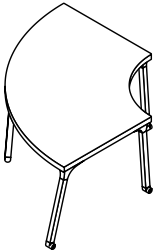

End Veneer Table	21 5/8	21 5/8	16	16	2	right 20TEGR2222V	\$956	\$1,052
	21 5/8	21 5/8	16	16	2	left 20TEGL2222V	\$956	\$1,052

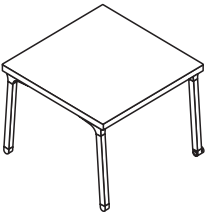

right end shown as seated

Model	Top Surface	Metal Frame Finish	Glide
	V Veneer See Satisse Veneer Finishes	ABZ Aged Bronze ASL Arctic Silver GLD Gold MBK Matte Black PEW Pewter SBZ Soft Bronze SNK Soft Nickel	G20 MagLinx™ G25 BoltLinx

Lounge

Description + General Information

Single Seat Lounge

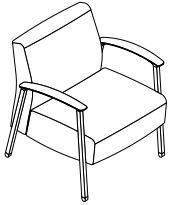

Dimensions	D	W	H	Shipping	
Overall	27 ¾	27 ½	31 ¾	Ctn Wt	51
Seat	20 ½	23	18	Cu Ft	18
Arm			25 ¼		

	Single Upholstery	Seat Zone 1	Back Zone 2
COM Ydg	2 ¾	1 ½	1 ½
COL Sq Ft	60 ½	33	33

Single Upholstery Specify: Model | Upholstery | Moisture Barrier | Arm Cap | Metal Frame Finish | Glide Option

20SL1														
	COM	COL	A	B	C	D	E	F	G	H	I	J	L1	L2
Single Uph	\$1,941	\$2,098	\$1,965	\$2,014	\$2,098	\$2,207	\$2,315	\$2,484	\$2,665	\$2,858	\$3,160	\$3,521	\$2,894	\$3,160

Multiple Upholstery Specify: Model | Seat Upholstery | Back Upholstery | Moisture Barrier | Arm Cap | Metal Frame Finish | Glide Option

20SL1_M														
Base Price: \$1,941	To the Base Price, add the appropriate upcharges by grade, per zone													
	COM	COL	A	B	C	D	E	F	G	H	I	J	L1	L2
Seat - Zone 1	+N/A	+\$86	+\$14	+\$40	+\$86	+\$146	+\$204	+\$297	+\$395	+\$501	+\$665	+\$862	+\$520	+\$665
Back - Zone 2	+N/A	+\$86	+\$14	+\$40	+\$86	+\$146	+\$204	+\$297	+\$395	+\$501	+\$665	+\$862	+\$520	+\$665

Model	Upholstery	Moisture Barrier	Arm Cap	Metal Frame Finish	Glide
	Grade Vendor Pattern Colorway	NMB No Moisture Barrier Back MB1 Moisture Barrier Seat - add \$140 MB2 Moisture Barrier Seat & Back - add \$278	PAC Polyurethane Arm Cap Set 3LAC 3D Laminate Arm Cap Set - add \$164 WAC Wood Arm Cap Set - add \$77 SAC Solid Surface Arm Cap Set - add \$432 see arm cap finishes	ABZ Aged Bronze ASL Arctic Silver GLD Gold MBK Matte Black PEW Pewter SBZ Soft Bronze SNK Soft Nickel	G10 Non Adjustable Glide G15 Leveling Glide - add \$10

Lounge

Description + General Information

Two Seat Lounge

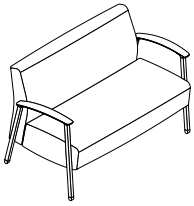

Dimensions	D	W	H	Shipping	
Overall	27 ¾	50	31 ¾	Ctn Wt	88
Seat	20 ½	42 ½	18	Cu Ft	31
Arm			25 ¼		

	Single Upholstery	Seat Zone 1	Back Zone 2
COM Ydg	3 ¾	1 ½	2 ½
COL Sq Ft	82 ½	33	55

Single Upholstery Specify: Model | Upholstery | Moisture Barrier | Arm Cap | Metal Frame Finish | Glide Option

20SL2														
	COM	COL	A	B	C	D	E	F	G	H	I	J	L1	L2
Single Uph	\$2,639	\$2,853	\$2,672	\$2,738	\$2,853	\$3,001	\$3,149	\$3,380	\$3,626	\$3,889	\$4,301	\$4,794	\$3,939	\$4,301

Multiple Upholstery Specify: Model | Seat Upholstery | Back Upholstery | Moisture Barrier | Arm Cap | Metal Frame Finish | Glide Option

20SL2_M														
Base Price: \$2,639	To the Base Price, add the appropriate upcharges by grade, per zone													
	COM	COL	A	B	C	D	E	F	G	H	I	J	L1	L2
Seat - Zone 1	+N/A	+\$86	+\$14	+\$40	+\$86	+\$145	+\$204	+\$297	+\$395	+\$501	+\$665	+\$862	+\$520	+\$665
Back - Zone 2	+N/A	+\$143	+\$22	+\$66	+\$143	+\$242	+\$340	+\$494	+\$658	+\$834	+\$1,108	+\$1,437	+\$867	+\$1,108

Model	Upholstery	Moisture Barrier	Arm Cap	Metal Frame Finish	Glide
	Grade Vendor Pattern Colorway	NMB No Moisture Barrier MB1 Moisture Barrier Seat - add \$166 MB2 Moisture Barrier Seat & Back - add \$344	PAC Polyurethane Arm Cap Set 3LAC 3D Laminate Arm Cap Set - add \$164 WAC Wood Arm Cap Set - add \$77 SAC Solid Surface Arm Cap Set - add \$432 see arm cap finishes	ABZ Aged Bronze ASL Arctic Silver GLD Gold MBK Matte Black PEW Pewter SBZ Soft Bronze SNK Soft Nickel	G10 Non Adjustable Glide G15 Leveling Glide - add \$10

Replacement Part Matrix for Seats and Backs

Product details are on the following pages:

Model Number	20SRS1	20SRS2	20SRB1	20SRB2	20SRBXA	20SRBP	20SRSB	20SRBB	20SRL1	20SRBL1	20SRL2	20SRBL2
20SGXA1	x				x							
20SGXA1_M	x				x							
20SG1	x		x									
20SG1_M	x		x									
20SGWA1	x		x									
20SGWA1_M	x		x									
20SG2		x		x								
20SG2_M		x		x								
20SGWA2		x		x								
20SGWA2_M		x		x								
20SB1							x	x				
20SB1_M							x	x				
20SBWA1							x	x				
20SBWA1_M							x	x				
20SP1	x					x						
20SP1_M	x					x						
20SPWA1	x											
20SPWA1_M	x											
20SE1	x		x									
20SE1_M	x		x									
20SEWA1	x		x									
20SEWA1_M	x		x									
20SGXAG1	x				x							
20SGXAG1_M	x				x							
20SGXAGR1	x				x							
20SGXAGR1_M	x				x							
20SGXAGL1	x				x							
20SGXAGL1_M	x				x							
20SGG1	x		x									
20SGG1_M	x		x									
20SGGR1	x		x									
20SGGR1_M	x		x									
20SGGL1	x		x									
20SGGL1_M	x		x									
20SGG2		x		x								
20SGG2_M		x		x								
20SGGR2		x		x								
20SGGR2_M		x		x								
20SGGL2		x		x								
20SGGL2_M		x		x								
20SBG1							x	x				
20SBG1_M							x	x				
20SBGR1							x	x				
20SBGR1_M							x	x				
20SBGL1							x	x				
20SBGL1_M							x	x				
20SL1									x	x		
20SL1_M									x	x		
20SL2											x	x
20SL2_M											x	x

Replacement Parts

Description + General Information

Replacement Seat - One Seat



Dimensions	D	W	H	Shipping	
Seat	21 ½	21 ½	4 ½	Ctn Wt	10
				Cu Ft	2
COM Ydg	1				
COL Sq Ft	20				

Single Upholstery Specify: Model | Upholstery

20SRS1

	COM	COL	A	B	C	D	E	F	G	H	I	J	L1	L2
Single Uph	\$420	\$477	\$429	\$446	\$477	\$516	\$556	\$617	\$683	\$753	\$863	\$994	\$731	\$819

Replacement Seat - Two Seat Guest

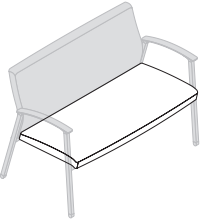

Dimensions	D	W	H	Shipping	
Seat	21 ½	42 ½	4 ½	Ctn Wt	23
				Cu Ft	3
COM Ydg	2 ¼				
COL Sq Ft	27 ½				

Single Upholstery Specify: Model | Upholstery

20SRS2

	COM	COL	A	B	C	D	E	F	G	H	I	J	L1	L2
Single Uph	\$788	\$908	\$836	\$862	\$908	\$967	\$1,026	\$1,119	\$1,217	\$1,323	\$1,487	\$1,684	\$1,342	\$1,487

Model	Upholstery	Moisture Barrier
	Grade Vendor Pattern Colorway	NM No Moisture Barrier MB1 Moisture Barrier Seat add \$84 one seat add \$140 two seat

Replacement Parts

Description + General Information

Replacement Back - One Seat

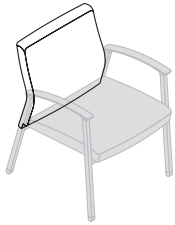

Dimensions	D	W	H	Shipping	
Back	6	21 ½	21 ¼	Ctn Wt	13
				Cu Ft	2
COM Ydg	1 ¼				
COL Sq Ft	25				

Single Upholstery Specify: Model | Upholstery

20SRB1														
	COM	COL	A	B	C	D	E	F	G	H	I	J	L1	L2
Single Uph	\$499	\$570	\$510	\$532	\$570	\$620	\$669	\$746	\$828	\$916	\$1,053	\$1,217	\$888	\$998

Replacement Back - Two Seat Guest

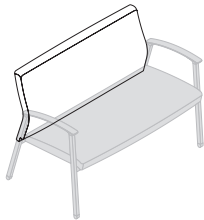

Dimensions	D	W	H	Shipping	
Back	6	42 ½	21 ¼	Ctn Wt	24
				Cu Ft	4
COM Ydg	1 ½				
COL Sq Ft	33				

Single Upholstery Specify: Model | Upholstery

20SRB2														
	COM	COL	A	B	C	D	E	F	G	H	I	J	L1	L2
Single Uph	\$822	\$908	\$836	\$862	\$908	\$967	\$1,026	\$1,119	\$1,217	\$1,323	\$1,487	\$1,684	\$1,342	\$1,487

Model	Upholstery	Moisture Barrier
	Grade Vendor Pattern Colorway	NM No Moisture Barrier MB3 Moisture Barrier Back add \$90 one back add \$160 two back

Replacement Parts

Description + General Information

Replacement Back - Armless Guest

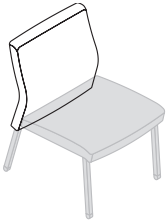

Dimensions	D	W	H	Shipping	
Back	6	21 ½	21 ¼	Ctn Wt	13
				Cu Ft	2
COM Ydg	1 ¼				
COL Sq Ft	25				

Single Upholstery Specify: Model | Upholstery

20SRBXA														
	COM	COL	A	B	C	D	E	F	G	H	I	J	L1	L2
Single Uph	\$499	\$570	\$510	\$532	\$570	\$620	\$669	\$746	\$828	\$916	\$1,053	\$1,217	\$888	\$998

Replacement Back - Patient



Dimensions	D	W	H	Shipping	
Back	6 ¾	21 ½	34	Ctn Wt	19
				Cu Ft	1
COM Ydg	1 ¾				
COL Sq Ft	38 ½				

Single Upholstery Specify: Model | Upholstery

20SRBP														
	COM	COL	A	B	C	D	E	F	G	H	I	J	L1	L2
Single Uph	\$793	\$893	\$809	\$839	\$893	\$962	\$1,031	\$1,139	\$1,254	\$1,377	\$1,569	\$1,799	\$1,400	\$1,569

Model	Upholstery	Moisture Barrier
	Grade Vendor Pattern Colorway	NM No Moisture Barrier MB3 Moisture Barrier Back add \$90 Armless add \$174 Patient

Replacement Parts

Description + General Information

Replacement Seat - Bariatric

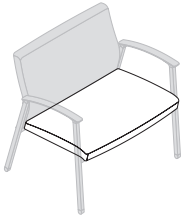

Dimensions	D	W	H	Shipping	
Seat	21 ½	30	4 ½	Ctn Wt	18
				Cu Ft	2
COM Ydg	1				
COL Sq Ft	22				

Single Upholstery Specify: Model | Upholstery

20SRSB														
	COM	COL	A	B	C	D	E	F	G	H	I	J	L1	L2
Single Uph	\$651	\$708	\$660	\$677	\$708	\$747	\$787	\$848	\$914	\$984	\$1,094	\$1,226	\$997	\$1,094

Replacement Back - Bariatric

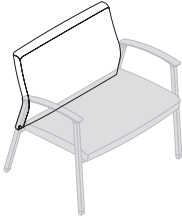

Dimensions	D	W	H	Shipping	
Back	6	30	21 ¼	Ctn Wt	16
				Cu Ft	3
COM Ydg	1 ½				
COL Sq Ft	33				

Single Upholstery Specify: Model | Upholstery

20SRBB														
	COM	COL	A	B	C	D	E	F	G	H	I	J	L1	L2
Single Uph	\$693	\$778	\$706	\$732	\$778	\$838	\$897	\$989	\$1,088	\$1,193	\$1,357	\$1,555	\$1,213	\$1,357

Model	Upholstery	Moisture Barrier
	Grade Vendor Pattern Colorway	NM No Moisture Barrier MBR3 Moisture Barrier Seat - add \$140 MBR4 Moisture Barrier Back - add \$160

Replacement Parts

Description	D	W	H	CTN WT	CU FT	① Model	List Price (per Arm Cap)
Replacement Arm Cap (for Narrow Arm)	18 ½	1 ¾	1 ½	4	1	20SRSPAC - Polyurethane	\$188

- non-handed can be specified for right or left application



	18 ½	1 ¾	1 ½	3	1	20SRS3LAC - 3D Laminate	\$256
--	------	-----	-----	---	---	--------------------------------	--------------

- non-handed can be specified for right or left application

	18 ½	1 ¾	1 ½	3	1	20SRSWAC - Wood	\$297
--	------	-----	-----	---	---	------------------------	--------------

- non-handed can be specified for right or left application

	18 ½	1 ¾	1 ½	4	1	20SRSSAC - Solid Surface	\$357
--	------	-----	-----	---	---	---------------------------------	--------------

- non-handed can be specified for right or left application

Model	Arm Cap
PAC	Polyurethane Arm Cap
3LAC	3D Laminate Arm Cap
WAC	Wood Arm Cap
SAC	Solid Surface Arm Cap

[see arm cap finishes](#)

Replacement Parts

Description	D	W	H	CTN WT	CU FT		① Model	List Price (per Arm Cap)
Replacement Arm Cap for Wide Arm	18 ½	2 ½	1 ½	4	1	right	20SRWPACR - Polyurethane	\$188
	18 ½	2 ½	1 ½	4	1	left	20SRWPACL - Polyurethane	\$188
 right shown	18 ½	2 ½	1 ½	3	1	right	20SRW3LACR - 3D Laminate	\$256
	18 ½	2 ½	1 ½	3	1	left	20SRW3LACL - 3D Laminate	\$256
	18 ½	2 ½	1 ½	3	1	right	20SRWWACR - Wood	\$297
	18 ½	2 ½	1 ½	3	1	left	20SRWWACL - Wood	\$297
	18 ½	2 ½	1 ½	4	1	right	20SRWSACR - Solid Surface	\$357
	18 ½	2 ½	1 ½	4	1	left	20SRWSACL - Solid Surface	\$357

Model	Arm Cap
PAC	Polyurethane Arm Cap
3LAC	3D Laminate Arm Cap
WAC	Wood Arm Cap
SAC	Solid Surface Arm Cap

[see arm cap finishes](#)

Replacement Parts

Description + General Information

Replacement Seat - Lounge

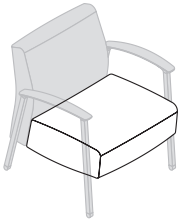

Dimensions	D	W	H	Shipping	
Seat	22 ¾	23	9 ½	Ctn Wt	22
				Cu Ft	4
COM Ydg	1 ½				
COL Sq Ft	33				

Single Upholstery Specify: Model | Upholstery

20SRSL1														
	COM	COL	A	B	C	D	E	F	G	H	I	J	L1	L2
Single Uph	\$843	\$928	\$856	\$882	\$928	\$988	\$1,047	\$1,139	\$1,238	\$1,343	\$1,508	\$1,705	\$1,363	\$1,508

Replacement Back - Lounge

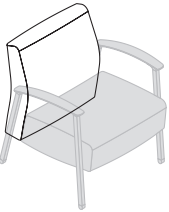

Dimensions	D	W	H	Shipping	
Back	7	23	24	Ctn Wt	20
				Cu Ft	3
COM Ydg	1 ½				
COL Sq Ft	33				

Single Upholstery Specify: Model | Upholstery

20SRBL1														
	COM	COL	A	B	C	D	E	F	G	H	I	J	L1	L2
Single Uph	\$718	\$804	\$732	\$758	\$804	\$863	\$922	\$1,015	\$1,113	\$1,219	\$1,383	\$1,580	\$1,238	\$1,383

Model Upholstery

Grade
Vendor
Pattern
Colorway

Replacement Parts

Description + General Information

Replacement Seat - Two Seat Lounge

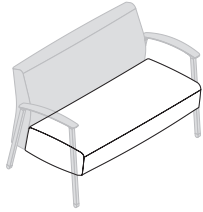

Dimensions	D	W	H	Shipping	
				Ctn Wt	41
Seat	22 ¾	42 ½	9 ½	Cu Ft	6
COM Ydg	1 ½				
COL Sq Ft	33				

Single Upholstery Specify: Model | Upholstery

20SRSL2														
	COM	COL	A	B	C	D	E	F	G	H	I	J	L1	L2
Single Uph	\$1,205	\$1,290	\$1,218	\$1,244	\$1,290	\$1,350	\$1,409	\$1,501	\$1,600	\$1,705	\$1,869	\$2,067	\$1,725	\$1,869

Replacement Back - Two Seat Lounge

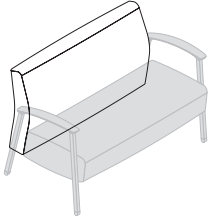

Dimensions	D	W	H	Shipping	
				Ctn Wt	38
Seat	7	42 ½	24	Cu Ft	5
COM Ydg	2 ½				
COL Sq Ft	55				

Single Upholstery Specify: Model | Upholstery

20SRBL2														
	COM	COL	A	B	C	D	E	F	G	H	I	J	L1	L2
Single Uph	\$1,093	\$1,236	\$1,115	\$1,159	\$1,236	\$1,335	\$1,433	\$1,587	\$1,751	\$1,927	\$2,201	\$2,530	\$1,960	\$2,201

Model Upholstery

Grade
Vendor
Pattern
Colorway

Replacement Parts

Description	D	W	H	CTN WT	CU FT	① Model	List Price (per Arm Cap)
Replacement Arm Cap for Lounge Arm	20	2 ½	2	5	1	right 20SRLPACR - Polyurethane	\$188
	20	2 ½	2	5	1	left 20SRLPACL - Polyurethane	\$188



right shown

20	2 ½	2	4	1	right	20SRL3LACR - 3D Laminate	\$279
20	2 ½	2	4	1	left	20SRL3LAACL - 3D Laminate	\$279

20	2 ½	2	4	1	right	20SRLWACR - Wood	\$297
20	2 ½	2	4	1	left	20SRLWACL - Wood	\$297

20	2 ½	2	5	1	right	20SRLSACR - Solid Surface	\$432
20	2 ½	2	5	1	left	20SRLSAACL - Solid Surface	\$432

Model	Arm Cap
PAC	Polyurethane Arm Cap
3LAC	3D Laminate Arm Cap
WAC	Wood Arm Cap
SAC	Solid Surface Arm Cap
	see arm cap finishes

Replacement Parts

Description	D	W	H	CTN WT	CU FT	① Model	List Price
Replacement Footrest	3 ½	21 ½	1 ¾	4	1	20SRFTRPU	\$207

- Matte Black

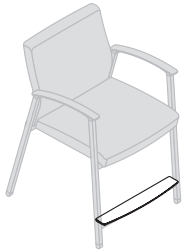

Replacement Leveling G15 Glides	1 ¼	1 ¼	1	1	1	20SRGLIDES	\$100
--	-----	-----	---	---	---	-------------------	--------------

- leveling glides cannot be specified to replace standard G10, MagLinx™ G20 or BoltLink G25
- always Matte Black

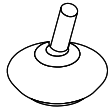

Forge - Overview

Base Cabinets

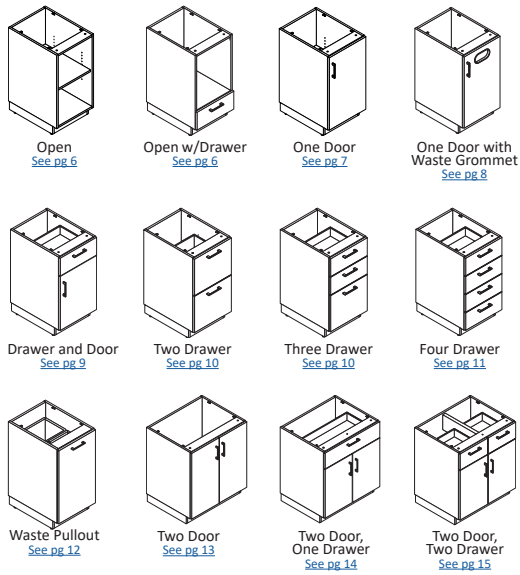

Base Sink Cabinets

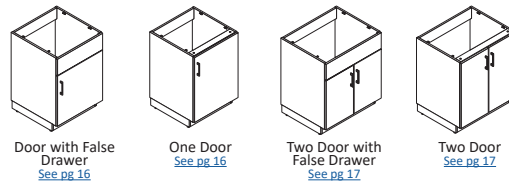

Base Filler & End Panels

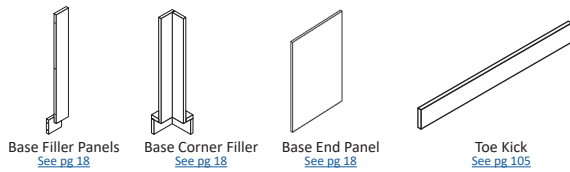

Wall Hanging Base Cabinets

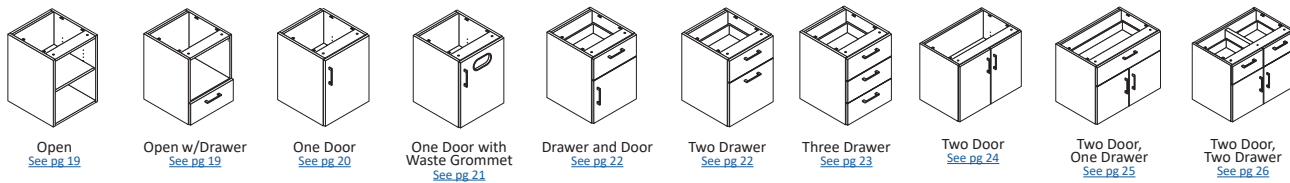

Wall Hanging Sink Cabinets

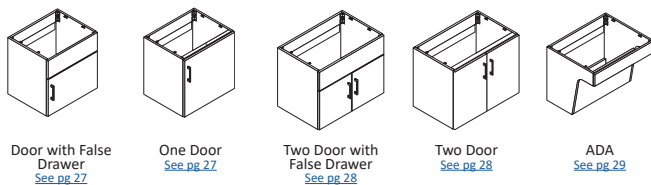

Wall Filler Panels

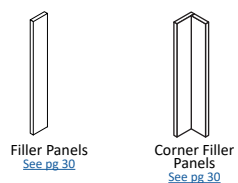

HPL Worksurfaces



Forge - Overview

Solid Surface Worksurfaces

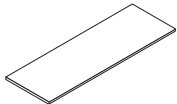

Rectangular Worksurface
[See pg 45](#)

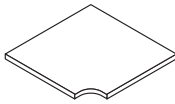

Corner Worksurface
[See pg 51](#)

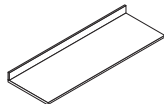

Rectangular Worksurface with Integral Backsplash
[See pg 52](#)

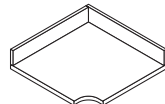

Corner Worksurface with Integral Backsplash
[See pg 58](#)

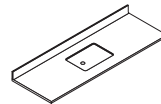

Worksurface with Integral Backsplash & Sink
[See pg 59](#)

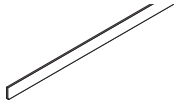

Backsplash
[See pg 65](#)

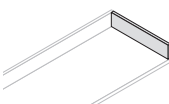

Side Splash
[See pg 68](#)

Accessories



Worsurface Waste Ring
[See pg 69](#)

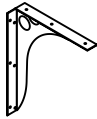

Worsurface Bracket
[See pg 69](#)

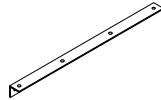

L-Bracket
[See pg 69](#)



Edge Support
[See pg 69](#)



Flat Bracket
[See pg 69](#)

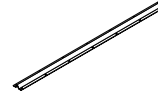

Support Rail
[See pg 69](#)



Support Bracket for End Panel
[See pg 69](#)

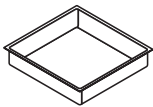

Removable Drawer Liner
[See pg 106](#)



Wall Panel
[See pg 104](#)

Upper Cabinets

Flat Top

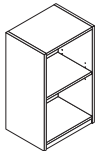

Open
[See pg 70](#)

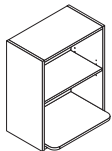

Open with Microwave Shelf
[See pg 70](#)

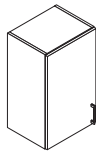

One Door
[See pg 71](#)

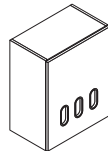

One Door with Glove Box
[See pg 72](#)

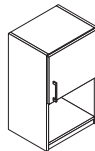

One Door with Open Shelf
[See pg 73](#)

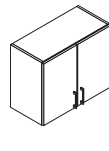

Two Door
[See pg 74](#)

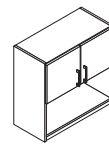

Two Doors with Open Shelf
[See pg 74](#)

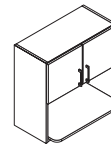

Two Door with Microwave Shelf
[See pg 74](#)

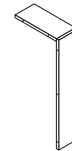

Filler Panel
[See pg 75](#)

Sloped Top

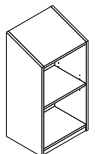

Open
[See pg 76](#)

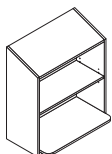

Open with Microwave Shelf
[See pg 76](#)

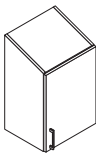

One Door
[See pg 77](#)

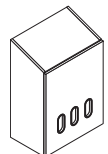

One Door with Glove Box
[See pg 78](#)

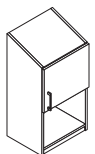

One Door with Open Shelf
[See pg 79](#)

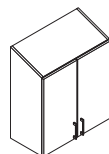

Two Door
[See pg 80](#)

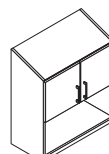

Two Doors with Open Shelf
[See pg 80](#)

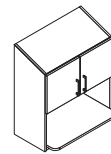

Two Door with Microwave Shelf
[See pg 80](#)

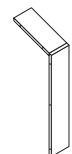

Filler Panel
[See pg 81](#)

Forge - Overview

Storage Cabinets

Flat Top

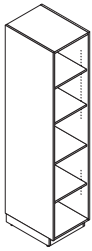

Open
[See pg 82](#)

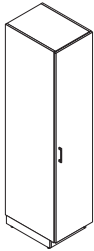

One Door
[See pg 83](#)

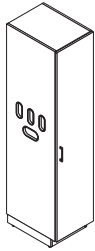

One Door with
Glove Box
[See pg 85](#)

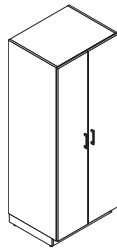

Two Door
[See pg 87](#)

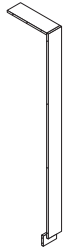

Filler Panels
[See pg 88](#)

Sloped Top

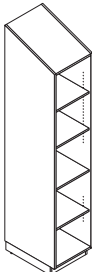

Open
[See pg 89](#)

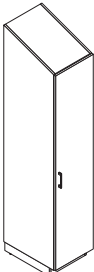

One Door
[See pg 90](#)

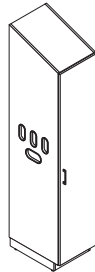

One Door with
Glove Box
[See pg 92](#)

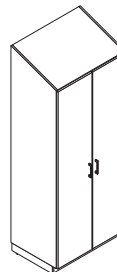

Two Door
[See pg 94](#)



Filler Panels
[See pg 95](#)

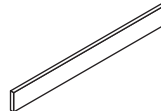

Toe Kick
[See pg 105](#)

Lockers

Flat Top

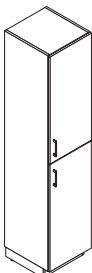

Two Door
[See pg 96](#)

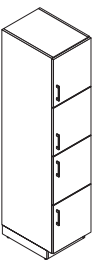

Four Door
[See pg 98](#)

Sloped Top

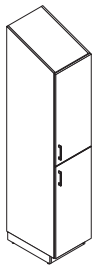

Two Door
[See pg 100](#)

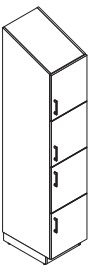

Four Door
[See pg 102](#)

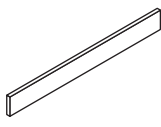

Toe Kick
[See pg 105](#)

Forge Product Information

NOTE: Forge storage must be anchored to a wall (hardware not included); not intended for freestanding use. [Reference Installation Instructions for more details.](#)

WorkSurfaces

Forge offers worksurfaces in both HPL Laminate and Solid Surfaces. Laminate worksurfaces have a 3-ply balanced construction. Tops are 1 3/16" thick with coordinating PVC edges. Worksurfaces feature 3mm eased (PVC) edge on the front; sides and back have coordinating 1mm PVC edge band.

Forge worksurfaces are available in all JSI standard HPL's, consisting of 19 wood grain patterns and 7 solid colors. Each has a coordinating PVC edge color that is automatically used with the standard laminates. The wood grain laminate features an embossed grain to hide finger prints and light scratches. The solid laminate is smooth to the touch with a semi-matte finish.

The chart below lists the laminates available on the Forge product.

TFL - HPL Wood Grain Pattern Laminates

BEL Belair	MIN Mineral
BRK Brickdust	MCH Mocha
CSK Cask	OBK Outback
CLY Clay	PIL Pilsner
EGR Egret	PIN Pinnacle Walnut
FAW Fawn	UMB Umber
FLN Flint	VAL Valley
FLO Florence Walnut	WLH Walnut Heights
LOF Loft	WEA Weathered Ash
MES Mesa	

TFL - HPL Solid Laminates

ALB Alabaster	SHD Shadow
BLK Black	SLG Slate Grey
BBL Bridal Blanco	ZEN Zen Grey
DWH Designer White	

In addition, an extensive list of HPL laminates from Wilsonart and Formica are available at the Tier 2 price, [see pages 107-108.](#) Selecting from the Tier 2 laminates will require a PVC banding to be specified from the standard list.

Solid surface worksurfaces are 1" thick and have a moisture-resistant core. Front edge features a 3mm radius eased edge, sides and back have finished flat edge. Worksurfaces are available in 4 standard JSI colors.

DWH Designer White	ONX Black Onyx Mirage
HST Hot Stone	SOG Soothing Grey

Additional Wilsonart and Corian finishes are available in 4 pricing tiers, [see pages 109-110.](#)

Cabinet Construction

Forge Laminate features TFL (thermally fused laminate) chassis with standard banding. Worksurfaces are available in a HPL (high pressure laminate) with standard banding.

Thermally fused laminate (TFL) with all edges fully banded. Interior material matches exterior. 3/4" thick side panels. Adjustable glides on base cabinets, storage cabinets and lockers; they provide 1" adjustment. Must use toe kick or cove molding to finish off base cabinets.

Grain direction runs vertically on all door/drawer fronts. Door and drawer fronts are banded with a 2mm banding.

Drawers

The unidirectional V-Fold drawer box is a durable miter-fold drawer structure which is glued and doweled. The 1/2" thick drawer sides are wrapped in a high grade white vinyl, with an attached front. The drawer front is attached to the four sided box.

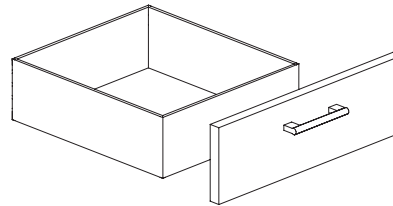

Drawer Suspension

High quality soft close, silver drawer suspension carries a lifetime warranty. Drawers have 100% full extension with over travel. Slides feature steel ball bearings for longer wear and positive, cushioned in/out stops.

Drawer Liner

Seamless, one-piece, white drawer liner available for 18" and 24" wide drawers.

Hinges

Concealed Euro soft close hinges with 110° opening and four adjustment points.

Locking

Cabinets offer locking to provide maximum security and flexibility in configuration. Up-charge applies. Locks are available as a standard keyed lock or a digital keyless lock.

When standard locks are ordered, units are shipped randomly keyed. Key alike units are available upon request for no additional charges. Removable cores for in-field re-keying are standard. Lock face color is available in Arctic Silver or Matte Black.

Digital Keyless Locks come pre-programmed for shared use, but can be field programmed for dedicated use. To lock, enter a 4 to 8 digit code and press the lock button. To unlock reenter the previous 4 to 8 digit code and press the unlock button. User guide ships with cabinet. Keyless lock will be oriented vertically on drawer units and horizontally on doors. Lock face is available in a black finish.



Wall Panels

3/4" thick with standard TFL 1/2" banding.

Forge Product Information

Top Edge Profile

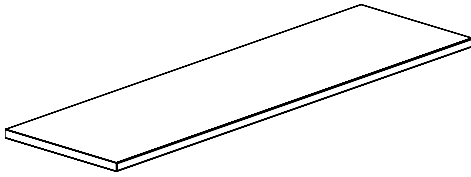

Tops feature a 3mm radius front edge, sides and back are flat

Pull and Color Options

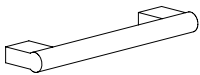

Bar
Matte Black MBK
Polished Nickel PNK



Sweep
Matte Black MBK
Matte Nickel MNK

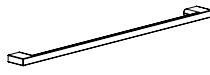

Delve
Aged Bronze ABZ
Arctic Silver ASL
Chrome CHR
Gold GLD
Matte Black MBK
Pewter PEW
Soft Bronze SBZ
Soft Nickel SNK



Prospect
Aged Bronze ABZ
Arctic Silver ASL
Gold GLD
Matte Black MBK
Pewter PEW
Soft Bronze SBZ
Soft Nickel SNK

Bar, Sweep and Delve are ADA compliant.

Pull Alignment

Bar, Sweep and Delve pulls are mounted on the front of drawer/door. Prospect pull overlays the top of the drawer and door front. Bar and Sweep pulls are standard in one length for every application. Delve and Prospect pulls offer an enhanced aesthetic on 30" - 36" wide drawer cabinets with an elongated version. In these cases, the longer pull is used in appropriate applications - user need not specify.

Boring Dimensions

24" wide or smaller

Sweep, Delve and Bar - 128mm

Prospect - 216mm

30" & 36" wide

Delve - 320mm

Prospect - 419mm

Integral Sink

Sink is always Designer White independent of selection of worksurface. Sink location is available in 1" increments from left side of worksurface to centerline of sink with minimum of 12" to centerline from either edge of surface. Sink should always be centered over sink cabinet. Drain hole is nominally 1 3/4" diameter and accepts standard drain hardware (not included).

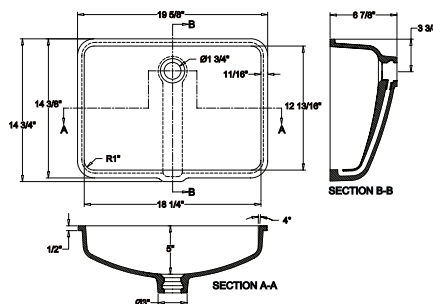
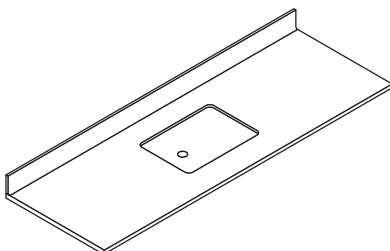

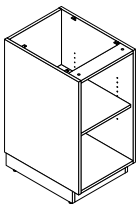
Description	D	W	H	CTN WT	CU FT	Model	List
Open Base Cabinet 	23 ½	36	35	97	21	40C243635BCT	\$1,105
	23 ½	30	35	87	18	40C243035BCT	\$1,065
	23 ½	24	35	76	15	40C242435BCT	\$1,020
	23 ½	21	35	70	13	40C242135BCT	\$980
	23 ½	18	35	65	11	40C241835BCT	\$940
	23 ½	15	35	59	10	40C241535BCT	\$900
	23 ½	12	35	54	8	40C241235BCT	\$855
	23 ½	36	32 ½	93	20	40C243633BCT	\$980
	23 ½	30	32 ½	82	17	40C243033BCT	\$960
	23 ½	24	32 ½	72	14	40C242433BCT	\$940
	23 ½	21	32 ½	66	12	40C242133BCT	\$915
	23 ½	18	32 ½	61	11	40C241833BCT	\$890
	23 ½	15	32 ½	56	9	40C241533BCT	\$865
	23 ½	12	32 ½	51	8	40C241233BCT	\$840

• one adjustable shelf

Specify: Model | Chassis Laminate

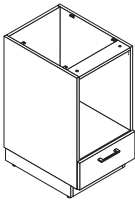
Description	D	W	H	CTN WT	CU FT	Model	List
Open Base Cabinet with Drawer 	24 ¼	36	35	90	22	40C243635BC1T	\$1,875
	24 ¼	30	35	81	18	40C243035BC1T	\$1,810
	24 ¼	24	35	71	15	40C242435BC1T	\$1,750
	24 ¼	21	35	66	13	40C242135BC1T	\$1,690
	24 ¼	18	35	62	12	40C241835BC1T	\$1,630
	24 ¼	15	35	57	10	40C241535BC1T	\$1,570
	24 ¼	12	35	52	8	40C241235BC1T	\$1,510
	24 ¼	36	32 ½	89	20	40C243633BC1T	\$1,770
	24 ¼	30	32 ½	80	17	40C243033BC1T	\$1,705
	24 ¼	24	32 ½	71	14	40C242433BC1T	\$1,642
	24 ¼	21	32 ½	66	13	40C242133BC1T	\$1,579
	24 ¼	18	32 ½	61	11	40C241833BC1T	\$1,516
	24 ¼	15	32 ½	57	9	40C241533BC1T	\$1,453
	24 ¼	12	32 ½	52	8	40C241233BC1T	\$1,390

Specify: Model | Chassis Laminate | Drawer Laminate | Pull | Lock

Model	Chassis Laminate	Drawer Laminate	Pull	Lock
	see Forge Laminate Finishes	see Forge Laminate Finishes	P001 Bar see Bar Pull Color P005 Delve see Delve Pull Color P011 Prospect see Prospect Pull Color P003 Sweep see Sweep Pull Color	NLK No Lock KLK Standard - add \$78 ASL Arctic Silver MBK Matte Black DLK Keyless Lock - add \$232

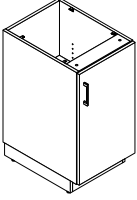
Description	D	W	H	CTN WT	CU FT	Model	List
One Door Base - Right Hinged Cabinet 	24 ¼	24	35	91	15	40C242435BCDRT	\$1,146
	24 ¼	21	35	84	13	40C242135BCDRT	\$1,133
	24 ¼	18	35	76	12	40C241835BCDRT	\$1,120
	24 ¼	15	35	69	10	40C241535BCDRT	\$1,082
	24 ¼	12	35	62	8	40C241235BCDRT	\$1,061
	24 ¼	24	32 ½	86	14	40C242433BCDRT	\$1,053
	24 ¼	21	32 ½	79	13	40C242133BCDRT	\$1,045
	24 ¼	18	32 ½	72	11	40C241833BCDRT	\$1,037
	24 ¼	15	32 ½	65	9	40C241533BCDRT	\$1,029
	24 ¼	12	32 ½	58	8	40C241233BCDRT	\$1,021

• one adjustable shelf

Specify: Model | Chassis Laminate | Door Laminate | Pull | Lock

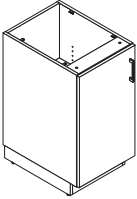
One Door Base - Left Hinged Cabinet 	24 ¼	24	35	91	15	40C242435BCDLT	\$1,146
	24 ¼	21	35	84	13	40C242135BCDLT	\$1,133
	24 ¼	18	35	76	12	40C241835BCDLT	\$1,120
	24 ¼	15	35	69	10	40C241535BCDLT	\$1,082
	24 ¼	12	35	62	8	40C241235BCDLT	\$1,061
	24 ¼	24	32 ½	86	14	40C242433BCDLT	\$1,053
	24 ¼	21	32 ½	79	13	40C242133BCDLT	\$1,045
	24 ¼	18	32 ½	72	11	40C241833BCDLT	\$1,037
	24 ¼	15	32 ½	65	9	40C241533BCDLT	\$1,029
	24 ¼	12	32 ½	58	8	40C241233BCDLT	\$1,021

• one adjustable shelf

Specify: Model | Chassis Laminate | Door Laminate | Pull | Lock

Model	Chassis Laminate	Door Laminate	Pull	Lock
	see Forge Laminate Finishes	see Forge Laminate Finishes	P001 Bar see Bar Pull Color P005 Delve see Delve Pull Color P011 Prospect see Prospect Pull Color P003 Sweep see Sweep Pull Color	NLK No Lock KLK Standard - add \$78 ASL Arctic Silver MBK Matte Black DLK Keyless Lock - add \$232

Description	D	W	H	CTN WT	CU FT	Model	List
One Door Base - Right Hinged Cabinet, Waste Grommet	24 ¼	24	35	91	15	40C242435BCDRTGT	\$1,171
	24 ¼	21	35	84	13	40C242135BCDRTGT	\$1,158
	24 ¼	18	35	76	12	40C241835BCDRTGT	\$1,145
	24 ¼	15	35	69	10	40C241535BCDRTGT	\$1,135
	24 ¼	12	35	62	8	40C241235BCDRTGT	\$1,112
	24 ¼	24	32 ½	86	14	40C242433BCDRTGT	\$1,098
	24 ¼	21	32 ½	79	13	40C242133BCDRTGT	\$1,084
	24 ¼	18	32 ½	72	11	40C241833BCDRTGT	\$1,070
	24 ¼	15	32 ½	65	9	40C241533BCDRTGT	\$1,056
	24 ¼	12	32 ½	58	8	40C241233BCDRTGT	\$1,042

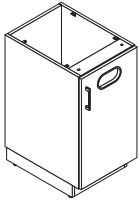

• waste grommet size 7 ½" x 4" x 13/16" - zinc oval grommet

Specify: Model | Chassis Laminate | Door Laminate | Pull | Lock | Waste Grommet Color

One Door Base - Left Hinged Cabinet, Waste Grommet	24 ¼	24	35	91	15	40C242435BCDLTGT	\$1,171
	24 ¼	21	35	84	13	40C242135BCDLTGT	\$1,158
	24 ¼	18	35	76	12	40C241835BCDLTGT	\$1,145
	24 ¼	15	35	69	10	40C241535BCDLTGT	\$1,135
	24 ¼	12	35	62	8	40C241235BCDLTGT	\$1,112
	24 ¼	24	32 ½	86	14	40C242433BCDLTGT	\$1,098
	24 ¼	21	32 ½	79	13	40C242133BCDLTGT	\$1,084
	24 ¼	18	32 ½	72	11	40C241833BCDLTGT	\$1,070
	24 ¼	15	32 ½	65	9	40C241533BCDLTGT	\$1,056
	24 ¼	12	32 ½	58	8	40C241233BCDLTGT	\$1,042

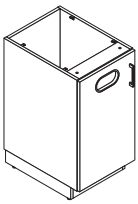

• waste grommet size 7 ½" x 4" x 13/16" - zinc oval grommet

Specify: Model | Chassis Laminate | Door Laminate | Pull | Lock | Waste Grommet Color

Model	Chassis Laminate	Door Laminate	Pull	Lock	Waste Grommet Color
	see Forge Laminate Finishes	see Forge Laminate Finishes	P001 Bar see Bar Pull Color P005 Delve see Delve Pull Color P011 Prospect see Prospect Pull Color P003 Sweep see Sweep Pull Color	NLK No Lock KLK Standard - add \$78 ASL Arctic Silver MBK Matte Black	MBK Matte Black SNK Soft Nickel

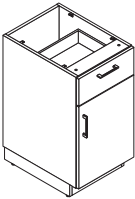
Description	D	W	H	CTN WT	CU FT	Model	List
 <p>One Door - Right Hinged, One Drawer Base Cabinet</p>	24 ¼	24	35	97	15	40C242435BCDDRT	\$1,615
	24 ¼	21	35	90	13	40C242135BCDDRT	\$1,591
	24 ¼	18	35	82	12	40C241835BCDDRT	\$1,486
	24 ¼	15	35	74	10	40C241535BCDDRT	\$1,471
	24 ¼	12	35	67	8	40C241235BCDDRT	\$1,455
	24 ¼	24	32 ½	92	14	40C242433BCDDRT	\$1,439
	24 ¼	21	32 ½	85	13	40C242133BCDDRT	\$1,423
	24 ¼	18	32 ½	77	11	40C241833BCDDRT	\$1,407
	24 ¼	15	32 ½	70	9	40C241533BCDDRT	\$1,391
	24 ¼	12	32 ½	63	8	40C241233BCDDRT	\$1,375

- plastic drawer liner available on top drawer for 18" and 24" wide cabinets, [see page 106](#) for pricing
 - 18" 40CDBL184
 - 24" 40CDBL244
- Note: when locking is specified, only top drawer locks

Specify: Model | Chassis Laminate | Door/Drawer Laminate | Pull | Lock

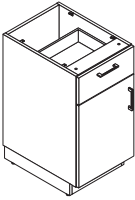
Description	D	W	H	CTN WT	CU FT	Model	List
 <p>One Door - Left Hinged, One Drawer Base Cabinet</p>	24 ¼	24	35	97	15	40C242435BCDDLTL	\$1,615
	24 ¼	21	35	90	13	40C242135BCDDLTL	\$1,591
	24 ¼	18	35	82	12	40C241835BCDDLTL	\$1,486
	24 ¼	15	35	74	10	40C241535BCDDLTL	\$1,471
	24 ¼	12	35	67	8	40C241235BCDDLTL	\$1,455
	24 ¼	24	32 ½	92	14	40C242433BCDDLTL	\$1,439
	24 ¼	21	32 ½	85	13	40C242133BCDDLTL	\$1,423
	24 ¼	18	32 ½	77	11	40C241833BCDDLTL	\$1,407
	24 ¼	15	32 ½	70	9	40C241533BCDDLTL	\$1,391
	24 ¼	12	32 ½	63	8	40C241233BCDDLTL	\$1,375

- plastic drawer liner available on top drawer for 18" and 24" wide cabinets, [see page 106](#) for pricing
 - 18" 40CDBL184
 - 24" 40CDBL244
- Note: when locking is specified, only top drawer locks

Specify: Model | Chassis Laminate | Door/Drawer Laminate | Pull | Lock

Model	Chassis Laminate	Door/Drawer Laminate	Pull	Lock
	see Forge Laminate Finishes	see Forge Laminate Finishes	P001 Bar see Bar Pull Color P005 Delve see Delve Pull Color P011 Prospect see Prospect Pull Color P003 Sweep see Sweep Pull Color	NLK No Lock KLK Standard - add \$78 ASL Arctic Silver MBK Matte Black DLK Keyless Lock - add \$232

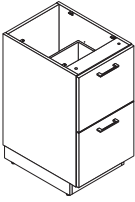
Description	D	W	H	CTN WT	CU FT	Model	List
 <p>Two Drawer Base Cabinet</p>	24 ¼	36	35	129	22	40C243635BC2T	\$1,775
	24 ¼	30	35	114	18	40C243035BC2T	\$1,760
	24 ¼	24	35	99	15	40C242435BC2T	\$1,745
	24 ¼	21	35	92	13	40C242135BC2T	\$1,730
	24 ¼	18	35	84	12	40C241835BC2T	\$1,715
	24 ¼	15	35	77	10	40C241535BC2T	\$1,700
	24 ¼	12	35	70	8	40C241235BC2T	\$1,685
	24 ¼	36	32 ½	122	20	40C243633BC2T	\$1,670
	24 ¼	30	32 ½	108	17	40C243033BC2T	\$1,655
	24 ¼	24	32 ½	94	14	40C242433BC2T	\$1,640
	24 ¼	21	32 ½	87	13	40C242133BC2T	\$1,592
	24 ¼	18	32 ½	80	11	40C241833BC2T	\$1,545
	24 ¼	15	32 ½	73	9	40C241533BC2T	\$1,497
	24 ¼	12	32 ½	66	8	40C241233BC2T	\$1,450

• Note: when locking is specified, only top drawer locks

Specify: Model | Chassis Laminate | Drawer Laminate | Pull | Lock

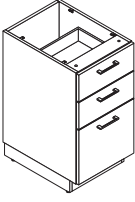
 <p>Three Drawer Base Cabinet</p>	24 ¼	36	35	127	22	40C243635BC3T	\$1,870
	24 ¼	30	35	113	18	40C243035BC3T	\$1,855
	24 ¼	24	35	99	15	40C242435BC3T	\$1,840
	24 ¼	21	35	92	13	40C242135BC3T	\$1,825
	24 ¼	18	35	85	12	40C241835BC3T	\$1,810
	24 ¼	15	35	78	10	40C241535BC3T	\$1,795
	24 ¼	12	35	71	8	40C241235BC3T	\$1,780
	24 ¼	36	32 ½	121	20	40C243633BC3T	\$1,765
	24 ¼	30	32 ½	108	17	40C243033BC3T	\$1,750
	24 ¼	24	32 ½	94	14	40C242433BC3T	\$1,735
	24 ¼	21	32 ½	87	13	40C242133BC3T	\$1,720
	24 ¼	18	32 ½	80	11	40C241833BC3T	\$1,705
	24 ¼	15	32 ½	73	9	40C241533BC3T	\$1,690
	24 ¼	12	32 ½	67	8	40C241233BC3T	\$1,675

• plastic drawer liner available on top two drawers for 18" and 24" wide cabinets, see page 106 for pricing
 - 18" 40CDBL184
 - 24" 40CDBL244

• Note: when locking is specified, only top drawer locks

Model	Chassis Laminate	Drawer Laminate	Pull	Lock
	see Forge Laminate Finishes	see Forge Laminate Finishes	P001 Bar see Bar Pull Color P005 Delve see Delve Pull Color P011 Prospect see Prospect Pull Color P003 Sweep see Sweep Pull Color	NLK No Lock KLK Standard - add \$78 ASL Arctic Silver MBK Matte Black DLK Keyless Lock - add \$232

Description	D	W	H	CTN WT	CU FT	① Model	List
 <p>Four Drawer Base Cabinet</p>	24 ¼	36	35	134	22	40C243635BC4T	\$2,380
	24 ¼	30	35	120	18	40C243035BC4T	\$2,288
	24 ¼	24	35	105	15	40C242435BC4T	\$2,196
	24 ¼	21	35	98	13	40C242135BC4T	\$2,104
	24 ¼	18	35	90	12	40C241835BC4T	\$2,012
	24 ¼	15	35	83	10	40C241535BC4T	\$1,920
	24 ¼	12	35	76	8	40C241235BC4T	\$1,828
	24 ¼	36	32 ½	128	20	40C243633BC4T	\$2,208
	24 ¼	30	32 ½	114	17	40C243033BC4T	\$2,124
	24 ¼	24	32 ½	100	14	40C242433BC4T	\$2,040
	24 ¼	21	32 ½	93	13	40C242133BC4T	\$1,958
	24 ¼	18	32 ½	86	11	40C241833BC4T	\$1,874
	24 ¼	15	32 ½	78	9	40C241533BC4T	\$1,790
	24 ¼	12	32 ½	72	8	40C241233BC4T	\$1,706

- plastic drawer liner available on 18" and 24" wide cabinets, [see page 106](#) for pricing
 - 18" 40CDBL184
 - 24" 40CDBL244
- Note: when locking is specified, only top drawer locks

Specify: Model | Chassis Laminate | Drawer Laminate | Pull | Lock

Model	Chassis Laminate	Drawer Laminate	Pull	Lock
	see Forge Laminate Finishes	see Forge Laminate Finishes	P001 Bar see Bar Pull Color P005 Delve see Delve Pull Color P011 Prospect see Prospect Pull Color P003 Sweep see Sweep Pull Color	NLK No Lock KLK Standard - add \$78 ASL Arctic Silver MBK Matte Black DLK Keyless Lock - add \$232

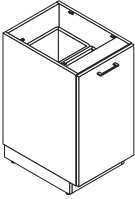
Description	D	W	H	CTN WT	CU FT	① Model	List
 Waste Pullout Drawer Base Cabinet	24 ¼	24	35	93	15	40C242435BCWPT	\$1,790
	24 ¼	21	35	85	13	40C242135BCWPT	\$1,743
	24 ¼	18	35	77	12	40C241835BCWPT	\$1,695
	24 ¼	15	35	72	10	40C241535BCWPT	\$1,676
	24 ¼	24	32 ½	88	14	40C242433BCWPT	\$1,657
	24 ¼	21	32 ½	81	13	40C242133BCWPT	\$1,625
	24 ¼	18	32 ½	73	11	40C241833BCWPT	\$1,594
	24 ¼	15	32 ½	68	9	40C241533BCWPT	\$1,563

- one trash can included in 15"w models
- two trash cans included in 18"-24"w models

Specify: Model | Chassis Laminate | Drawer Laminate | Pull

Model	Chassis Laminate	Drawer Laminate	Pull
	see Forge Laminate Finishes	see Forge Laminate Finishes	P001 Bar see Bar Pull Color P005 Delve see Delve Pull Color P011 Prospect see Prospect Pull Color P003 Sweep see Sweep Pull Color

Description	D	W	H	CTN WT	CU FT	Model	List
Two Door Base Cabinet	24 ¼	36	35	121	22	40C243635BCDT	\$1,505
	24 ¼	30	35	106	18	40C243035BCDT	\$1,450
	24 ¼	36	32 ½	115	20	40C243633BCDT	\$1,425
	24 ¼	30	32 ½	100	17	40C243033BCDT	\$1,370

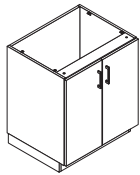

- one adjustable shelf

Specify: Model | Chassis Laminate | Door Laminate | Pull | Lock

Model	Chassis Laminate	Door Laminate	Pull	Lock
	see Forge Laminate Finishes	see Forge Laminate Finishes	P001 Bar see Bar Pull Color P005 Delve see Delve Pull Color P011 Prospect see Prospect Pull Color P003 Sweep see Sweep Pull Color	NLK No Lock KLK Standard - add \$78 ASL Arctic Silver MBK Matte Black DLK Keyless Lock - add \$256

Description	D	W	H	CTN WT	CU FT	Model	List
Two Door, One Drawer Base Cabinet	24 ¼	36	35	129	22	40C243635BCDD1T	\$1,845
	24 ¼	30	35	113	18	40C243035BCDD1T	\$1,790
	24 ¼	36	32 ½	122	20	40C243633BCDD1T	\$1,765
	24 ¼	30	32 ½	107	17	40C243033BCDD1T	\$1,710

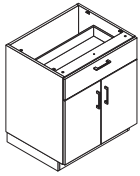

- one adjustable shelf
- Note: when locking is specified, only top drawer locks

Specify: Model | Chassis Laminate | Drawer/Door Laminate | Pull | Lock

Model	Chassis Laminate	Door/Drawer Laminate	Pull	Lock
	see Forge Laminate Finishes	see Forge Laminate Finishes	P001 Bar see Bar Pull Color P005 Delve see Delve Pull Color P011 Prospect see Prospect Pull Color P003 Sweep see Sweep Pull Color	NLK No Lock KLK Standard - add \$78 ASL Arctic Silver MBK Matte Black DLK Keyless Lock - add \$232

Description	D	W	H	CTN WT	CU FT	Model	List
Two Door, Two Drawer Base Cabinet	24 ¼	36	35	132	22	40C243635BCDD2T	\$2,065
	24 ¼	30	35	116	18	40C243035BCDD2T	\$2,010
	24 ¼	36	32 ½	125	20	40C243633BCDD2T	\$1,985
	24 ¼	30	32 ½	110	17	40C243033BCDD2T	\$1,930

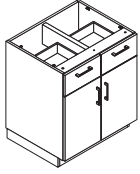

- one adjustable shelf
- 18" plastic drawer liner available for model 40C243635BCDD2T and 40C243633BCDD2T, [see page 106](#)
- Note: when locking is specified, only top drawer locks

Specify: Model | Chassis Laminate | Door/Drawer Laminate | Pull | Lock

Model	Chassis Laminate	Door/Drawer Laminate	Pull	Lock
	see Forge Laminate Finishes	see Forge Laminate Finishes	P001 Bar see Bar Pull Color P005 Delve see Delve Pull Color P011 Prospect see Prospect Pull Color P003 Sweep see Sweep Pull Color	NLK No Lock KLK Standard - add \$156 ASL Arctic Silver MBK Matte Black DLK Keyless Lock - add \$464

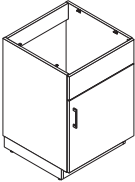
Description	D	W	H	CTN WT	CU FT	Model	List
One Door, False Front Sink Base Cabinet  right shown	Hinged Right						
	24 ¼	24	35	79	15	40C242435BSCDRFT	\$1,335
	24 ¼	24	32 ½	75	14	40C242433BSCDRFT	\$1,265
	Hinged Left						
	24 ¼	24	35	79	15	40C242435BSCDLFT	\$1,335
	24 ¼	24	32 ½	75	14	40C242433BSCDLFT	\$1,265

Specify: Model | Chassis Laminate | Door Laminate | Pull | Lock

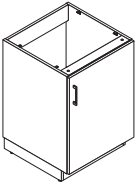
One Door Sink Base Cabinet  right shown	Hinged Right						
	24 ¼	24	35	79	15	40C242435BSCDRT	\$1,320
	24 ¼	24	32 ½	75	14	40C242433BSCDRT	\$1,250
	Hinged Left						
	24 ¼	24	35	79	15	40C242435BSCDLT	\$1,320
	24 ¼	24	32 ½	75	14	40C242433BSCDLT	\$1,250

Specify: Model | Chassis Laminate | Door Laminate | Pull | Lock

Model	Chassis Laminate	Door Laminate	Pull	Lock
	see Forge Laminate Finishes	see Forge Laminate Finishes	P001 Bar see Bar Pull Color P005 Delve see Delve Pull Color P011 Prospect see Prospect Pull Color P003 Sweep see Sweep Pull Color	NLK No Lock KLK Standard - add \$78 ASL Arctic Silver MBK Matte Black DLK Keyless Lock - add \$232

Description	D	W	H	CTN WT	CU FT	Model	List
Two Door, False Front Sink Base Cabinet	24 ¼	36	35	105	22	40C243635BSCDFT	\$1,480
	24 ¼	30	35	93	18	40C243035BSCDFT	\$1,425
	24 ¼	36	32 ½	98	20	40C243633BSCDFT	\$1,400
	24 ¼	30	32 ½	87	17	40C243033BSCDFT	\$1,345

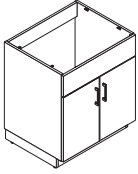

Specify: Model | Chassis Laminate | Door Laminate | Pull | Lock

Two Door Sink Base Cabinet	24 ¼	36	35	105	22	40C243635BSCDT	\$1,470
	24 ¼	30	35	93	18	40C243035BSCDT	\$1,415
	24 ¼	36	32 ½	98	20	40C243633BSCDT	\$1,390
	24 ¼	30	32 ½	87	17	40C243033BSCDT	\$1,335

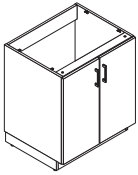

Specify: Model | Chassis Laminate | Door Laminate | Pull | Lock

Model	Chassis Laminate	Door Laminate	Pull	Lock
	see Forge Laminate Finishes	see Forge Laminate Finishes	P001 Bar see Bar Pull Color P005 Delve see Delve Pull Color P011 Prospect see Prospect Pull Color P003 Sweep see Sweep Pull Color	NLK No Lock KLK Standard - add \$78 ASL Arctic Silver MBK Matte Black DLK Keyless Lock - add \$256

Description	D	W	H	CTN WT	CU FT	① Model	List
Base Filler 	6	2	35	4	1	40C6235BFT	\$150
	6	2	32 ½	3	1	40C6233BFT	\$145
<ul style="list-style-type: none"> • includes brackets to attach to cabinet • may be field scribed as needed <p>Specify: Model Chassis Laminate</p>							

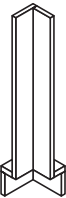
Base Corner Filler 	7	7	35	7	2	40C7735BFT	\$300
	7	7	33	6	2	40C7733BFT	\$290
<ul style="list-style-type: none"> • use with corner surfaces • includes brackets to attach to cabinets <p>Specify: Model Chassis Laminate</p>							

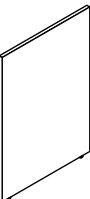
Base End Panel 	23 ½	¾	35	17	2	40C24135BET	\$225
	23 ½	¾	32 ½	16	2	40C24133BET	\$205
<ul style="list-style-type: none"> • can be used for support in place of a base cabinet • brackets must be specified separately, see page 69 <p>Specify: Model Chassis Laminate</p>							

Model	Chassis Laminate
	see Forge Laminate Finishes

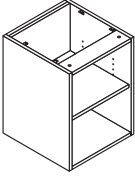
Description	D	W	H	CTN WT	CU FT	Model	List
Open Wall Hanging Base Cabinet 	18 ½	36	23 ½	65	12	40C193624WHBCT	\$985
	18 ½	30	23 ½	57	10	40C193024WHBCT	\$925
	18 ½	24	23 ½	49	8	40C192424WHBCT	\$870
	18 ½	21	23 ½	45	7	40C192124WHBCT	\$810
	18 ½	18	23 ½	41	7	40C191824WHBCT	\$750
	18 ½	15	23 ½	37	6	40C191524WHBCT	\$690
	18 ½	12	23 ½	33	5	40C191224WHBCT	\$630

- one adjustable shelf

Specify: Model | Chassis Laminate

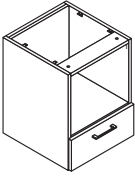
Description	D	W	H	CTN WT	CU FT	Model	List
Open Wall Hanging Base Cabinet with One Drawer 	19 ¼	36	23 ½	74	12	40C193624WHBC1T	\$1,350
	19 ¼	30	23 ½	65	10	40C193024WHBC1T	\$1,275
	19 ¼	24	23 ½	51	9	40C192424WHBC1T	\$1,200
	19 ¼	21	23 ½	47	8	40C192124WHBC1T	\$1,125
	19 ¼	18	23 ½	43	7	40C191824WHBC1T	\$1,050
	19 ¼	15	23 ½	40	6	40C191524WHBC1T	\$975
	19 ¼	12	23 ½	36	5	40C191224WHBC1T	\$900

- one adjustable shelf
- plastic drawer liner available for 18" and 24" wide cabinets, [see page 106](#) for pricing
 18" 40CDBL184
 24" 40CDBL244

Specify: Model | Chassis Laminate | Drawer Laminate | Pull | Lock

Model	Chassis Laminate	Drawer Laminate	Pull	Lock
	see Forge Laminate Finishes	see Forge Laminate Finishes	P001 Bar see Bar Pull Color P005 Delve see Delve Pull Color P011 Prospect see Prospect Pull Color P003 Sweep see Sweep Pull Color	NLK No Lock KLK Standard - add \$78 ASL Arctic Silver MBK Matte Black DLK Keyless Lock - add \$232

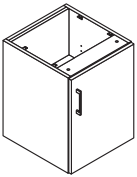
Description	D	W	H	CTN WT	CU FT	Model	List
Door Wall Hanging Base Cabinet  right shown	Hinged Right						
	19 ¼	24	23 ½	61	9	40C192424WHBCDRT	\$915
	19 ¼	21	23 ½	55	8	40C192124WHBCDRT	\$890
	19 ¼	18	23 ½	50	7	40C191824WHBCDRT	\$845
	19 ¼	15	23 ½	44	6	40C191524WHBCDRT	\$831
	19 ¼	12	23 ½	39	5	40C191224WHBCDRT	\$818
	Hinged Left						
	19 ¼	24	23 ½	61	9	40C192424WHBCDLT	\$915
	19 ¼	21	23 ½	55	8	40C192124WHBCDLT	\$890
	19 ¼	18	23 ½	50	7	40C191824WHBCDLT	\$845
	19 ¼	15	23 ½	44	6	40C191524WHBCDLT	\$831
19 ¼	12	23 ½	39	5	40C191224WHBCDLT	\$818	

• one adjustable shelf

Specify: Model | Chassis Laminate | Door Laminate | Pull | Lock

Model	Chassis Laminate	Door Laminate	Pull	Lock
	see Forge Laminate Finishes	see Forge Laminate Finishes	P001 Bar see Bar Pull Color P005 Delve see Delve Pull Color P011 Prospect see Prospect Pull Color P003 Sweep see Sweep Pull Color	NLK No Lock KLK Standard - add \$78 ASL Arctic Silver MBK Matte Black DLK Keyless Lock - add \$232

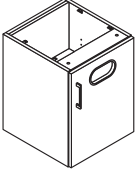
Description	D	W	H	CTN WT	CU FT	Model	List
 <p>right shown</p>	Hinged Right						
	19 ¼	24	23 ½	61	9	40C192424WHBCDRTGT	\$955
	19 ¼	21	23 ½	55	8	40C192124WHBCDRTGT	\$930
	19 ¼	18	23 ½	50	7	40C191824WHBCDRTGT	\$887
	19 ¼	15	23 ½	44	6	40C191524WHBCDRTGT	\$862
	19 ¼	12	23 ½	39	5	40C191224WHBCDRTGT	\$855
	Hinged Left						
	19 ¼	24	23 ½	61	9	40C192424WHBCDLTGT	\$955
	19 ¼	21	23 ½	55	8	40C192124WHBCDLTGT	\$930
	19 ¼	18	23 ½	50	7	40C191824WHBCDLTGT	\$887
19 ¼	15	23 ½	44	6	40C191524WHBCDLTGT	\$862	
19 ¼	12	23 ½	39	5	40C191224WHBCDLTGT	\$855	

• waste grommet size 7 ½" x 4" x 13/16" - zinc oval grommet

Specify: Model | Chassis Laminate | Door Laminate | Pull | Lock | Waste Grommet Color

Model	Chassis Laminate	Door Laminate	Pull	Lock	Waste Grommet Color
	see Forge Laminate Finishes	see Forge Laminate Finishes	P001 Bar see Bar Pull Color P005 Delve see Delve Pull Color P011 Prospect see Prospect Pull Color P003 Sweep see Sweep Pull Color	NLK No Lock KLK Standard - add \$78 ASL Arctic Silver MBK Matte Black	MBK Matte Black SNK Soft Nickel

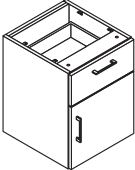
Description	D	W	H	CTN WT	CU FT	Model	List
One Door, One Drawer Wall Hanging Base Cabinet 	Hinged Right						
	19 ¼	24	23 ½	67	9	40C192424WHBCDDRT	\$1,182
	19 ¼	21	23 ½	61	8	40C192124WHBCDDRT	\$1,149
	19 ¼	18	23 ½	55	7	40C191824WHBCDDRT	\$1,115
	19 ¼	15	23 ½	49	6	40C191524WHBCDDRT	\$1,081
	19 ¼	12	23 ½	44	5	40C191224WHBCDDRT	\$1,047

right shown

Hinged Left						
19 ¼	24	23 ½	67	9	40C192424WHBCDDL	\$1,182
19 ¼	21	23 ½	61	8	40C192124WHBCDDL	\$1,149
19 ¼	18	23 ½	55	7	40C191824WHBCDDL	\$1,115
19 ¼	15	23 ½	49	6	40C191524WHBCDDL	\$1,081
19 ¼	12	23 ½	44	5	40C191224WHBCDDL	\$1,047

- plastic drawer liner available on drawer for 18" and 24" wide cabinets, [see page 106](#) for pricing
18" 40CDBL184
24" 40CDBL244
- Note: when locking is specified, only drawer locks

Specify: Model | Chassis Laminate | Door/Drawer Laminate | Pull | Lock

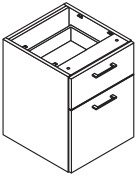
Two Drawer Wall Hanging Base Cabinet 	19 ¼	36	23 ½	98	12	40C193624WHBC2T	\$1,362
	19 ¼	30	23 ½	86	10	40C193024WHBC2T	\$1,332
	19 ¼	24	23 ½	68	9	40C192424WHBC2T	\$1,302
	19 ¼	21	23 ½	63	8	40C192124WHBC2T	\$1,272
	19 ¼	18	23 ½	57	7	40C191824WHBC2T	\$1,242
	19 ¼	15	23 ½	52	6	40C191524WHBC2T	\$1,212
	19 ¼	12	23 ½	46	5	40C191224WHBC2T	\$1,182

- plastic drawer liner available on top drawer for 18" and 24" wide cabinets, [see page 106](#) for pricing
18" 40CDBL184
24" 40CDBL244
- Note: when locking is specified, only top drawer locks

Specify: Model | Chassis Laminate | Drawer Laminate | Pull | Lock

Model	Chassis Laminate	Door/Drawer Laminate	Pull	Lock
	see Forge Laminate Finishes	see Forge Laminate Finishes	P001 Bar see Bar Pull Color P005 Delve see Delve Pull Color P011 Prospect see Prospect Pull Color P003 Sweep see Sweep Pull Color	NLK No Lock KLK Standard - add \$78 ASL Arctic Silver MBK Matte Black DLK Keyless Lock - add \$232

Description	D	W	H	CTN WT	CU FT	① Model	List
Three Drawer Wall Hanging Base Cabinet 	19 ¼	36	23 ½	101	12	40C193624WHBC3T	\$1,500
	19 ¼	30	23 ½	89	10	40C193024WHBC3T	\$1,440
	19 ¼	24	23 ½	71	9	40C192424WHBC3T	\$1,380
	19 ¼	21	23 ½	66	8	40C192124WHBC3T	\$1,320
	19 ¼	18	23 ½	60	7	40C191824WHBC3T	\$1,260
	19 ¼	15	23 ½	54	6	40C191524WHBC3T	\$1,200
	19 ¼	12	23 ½	49	5	40C191224WHBC3T	\$1,140

- plastic drawer liner available for 18" and 24" wide cabinets, [see page 106](#) for pricing
 18" 40CDBL184
 24" 40CDBL244
- Note: when locking is specified, only top drawer locks

Specify: Model | Chassis Laminate | Drawer Laminate | Pull | Lock

Model	Chassis Laminate	Drawer Laminate	Pull	Lock
	see Forge Laminate Finishes	see Forge Laminate Finishes	P001 Bar see Bar Pull Color P005 Delve see Delve Pull Color P011 Prospect see Prospect Pull Color P003 Sweep see Sweep Pull Color	NLK No Lock KLK Standard - add \$78 ASL Arctic Silver MBK Matte Black DLK Keyless Lock - add \$232

Description	D	W	H	CTN WT	CU FT	Model	List
Two Door Wall Hanging Base Cabinet	19 ¼	36	23 ½	93	12	40C193624WHBCDT	\$1,155
	19 ¼	30	23 ½	82	10	40C193024WHBCDT	\$1,100

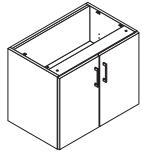

- one adjustable shelf

Specify: Model | Chassis Laminate | Door Laminate | Pull | Lock

Model	Chassis Laminate	Door Laminate	Pull	Lock
	see Forge Laminate Finishes	see Forge Laminate Finishes	P001 Bar see Bar Pull Color P005 Delve see Delve Pull Color P011 Prospect see Prospect Pull Color P003 Sweep see Sweep Pull Color	NLK No Lock KLK Standard - add \$78 ASL Arctic Silver MBK Matte Black DLK Keyless Lock - add \$256

Description	D	W	H	CTN WT	CU FT	Model	List
Two Door, One Drawer Wall Hanging Base Cabinet	19 ¼	36	23 ½	100	12	40C193624WHBCDDT	\$1,375
	19 ¼	30	23 ½	89	10	40C193024WHBCDDT	\$1,260

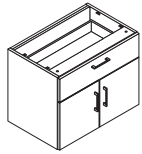

- one adjustable shelf
- Note: when locking is specified, only drawer locks

Specify: Model | Chassis Laminate | Door/Drawer Laminate | Pull | Lock

Model	Chassis Laminate	Door/Drawer Laminate	Pull	Lock
	see Forge Laminate Finishes	see Forge Laminate Finishes	P001 Bar see Bar Pull Color P005 Delve see Delve Pull Color P011 Prospect see Prospect Pull Color P003 Sweep see Sweep Pull Color	NLK No Lock KLK Standard - add \$78 ASL Arctic Silver MBK Matte Black DLK Keyless Lock - add \$232

Description	D	W	H	CTN WT	CU FT	Model	List
Two Door, Two Drawer Wall Hanging Base Cabinet	19 ¼	36	23 ½	104	12	40C193624WHBCDD2T	\$1,450
	19 ¼	30	23 ½	92	10	40C193024WHBCDD2T	\$1,335

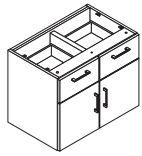

- one adjustable shelf
- 18" plastic drawer liner available for model 40C193624WHBCDD2T, [see page 106](#) for pricing - 18" 40CDBL184
- Note: when locking is specified, only drawer locks

Specify: Model | Chassis Laminate | Door/Drawer Laminate | Pull | Lock

Model	Chassis Laminate	Door/Drawer Laminate	Pull	Lock
	see Forge Laminate Finishes	see Forge Laminate Finishes	P001 Bar see Bar Pull Color P005 Delve see Delve Pull Color P011 Prospect see Prospect Pull Color P003 Sweep see Sweep Pull Color	NLK No Lock KLK Standard - add \$156 ASL Arctic Silver MBK Matte Black DLK Keyless Lock - add \$464

Description	D	W	H	CTN WT	CU FT	Model	List
One Door, False Drawer Front Wall Hanging Sink Cabinet	Hinged Right						
	19 ¼	24	23 ½	53	9	40C192424WHSCDRFT	\$895

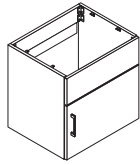

right shown

Hinged Left						
19 ¼	24	23 ½	53	9	40C192424WHSCDLFT	\$895

Specify: Model | Chassis Laminate | Door Laminate | Pull | Lock

One Door Wall Hanging Sink Cabinet	Hinged Right						
	19 ¼	24	23 ½	53	9	40C192424WHSCDRT	\$890

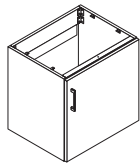

right shown

Hinged Left						
19 ¼	24	23 ½	53	9	40C192424WHSCDLT	\$890

Specify: Model | Chassis Laminate | Door Laminate | Pull | Lock

Model	Chassis Laminate	Door Laminate	Pull	Lock
	see Forge Laminate Finishes	see Forge Laminate Finishes	P001 Bar see Bar Pull Color P005 Delve see Delve Pull Color P011 Prospect see Prospect Pull Color P003 Sweep see Sweep Pull Color	NLK No Lock KLK Standard - add \$78 ASL Arctic Silver MBK Matte Black DLK Keyless Lock - add \$232

Description	D	W	H	CTN WT	CU FT	Model	List
Two Door False Front Wall Hanging Sink Cabinet	19 ¼	36	23 ½	70	12	40C193624WHSCDFT	\$1,045
	19 ¼	30	23 ½	62	10	40C193024WHSCDFT	\$990

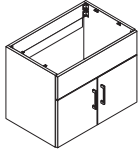

Specify: Model | Chassis Laminate | Door Laminate | Pull | Lock

Two Door Wall Hanging Sink Cabinet	19 ¼	36	23 ½	70	12	40C193624WHSCDT	\$1,045
	19 ¼	30	23 ½	62	10	40C193024WHSCDT	\$990

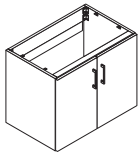

Specify: Model | Chassis Laminate | Door Laminate | Pull | Lock

Model	Chassis Laminate	Door Laminate	Pull	Lock
	see Forge Laminate Finishes	see Forge Laminate Finishes	P001 Bar see Bar Pull Color P005 Delve see Delve Pull Color P011 Prospect see Prospect Pull Color P003 Sweep see Sweep Pull Color	NLK No Lock KLK Standard - add \$78 ASL Arctic Silver MBK Matte Black DLK Keyless Lock - add \$256

Description	D	W	H	CTN WT	CU FT	Model	List
ADA Wall Hanging Sink Cabinet 	24 ¼	36	23 ½	47	15	40C243624ADAT	\$1,250
	24 ¼	30	23 ½	47	15	40C243024ADAT	\$1,195
	19 ¼	36	23 ½	39	12	40C193624ADAT	\$1,135
	19 ¼	30	23 ½	34	10	40C193024ADAT	\$1,080

- removable front panel

Specify: Model | Chassis Laminate | False Front Laminate

Model	Chassis Laminate	False Front Laminate
	see Forge Laminate Finishes	see Forge Laminate Finishes

Description	D	W	H	CTN WT	CU FT	① Model	List
Wall Hanging Filler	6	¾	23 ½	3	1	40C6124WHFT	\$136

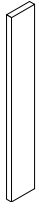

- includes brackets to attach to cabinet
- may be field scribed as needed

Specify: Model | Chassis Laminate

Wall Hanging Corner Filler	4 ¼	4 ¼	23 ½	5	1	40C4424WHFT	\$272
----------------------------	-----	-----	------	---	---	-------------	-------

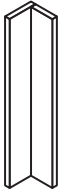

- includes brackets to attach to cabinet

Specify: Model | Chassis Laminate

Model	Chassis Laminate
	see Forge Laminate Finishes

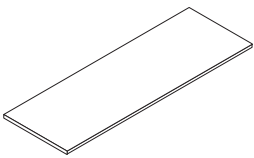
Description	D	W	H	CTN WT	CU FT	① Model	Tier 1	Tier 2
24½" d HPL Worksurfaces 	24 ½	120	1 ⅜	104	7	40C25120TH	\$984	\$1,034
	24 ½	119	1 ⅜	103	7	40C25119TH	\$979	\$1,028
	24 ½	118	1 ⅜	102	7	40C25118TH	\$974	\$1,023
	24 ½	117	1 ⅜	101	7	40C25117TH	\$968	\$1,017
	24 ½	116	1 ⅜	101	6	40C25116TH	\$962	\$1,011
	24 ½	115	1 ⅜	100	6	40C25115TH	\$956	\$1,004
	24 ½	114	1 ⅜	99	6	40C25114TH	\$950	\$998
	24 ½	113	1 ⅜	98	6	40C25113TH	\$944	\$992
	24 ½	112	1 ⅜	97	6	40C25112TH	\$938	\$985
	24 ½	111	1 ⅜	96	6	40C25111TH	\$932	\$979
	24 ½	110	1 ⅜	95	6	40C25110TH	\$926	\$973
	24 ½	109	1 ⅜	95	6	40C25109TH	\$920	\$966
	24 ½	108	1 ⅜	94	6	40C25108TH	\$914	\$960
	24 ½	107	1 ⅜	93	6	40C25107TH	\$906	\$952
	24 ½	106	1 ⅜	92	6	40C25106TH	\$898	\$943
	24 ½	105	1 ⅜	91	6	40C25105TH	\$890	\$935
	24 ½	104	1 ⅜	90	6	40C25104TH	\$882	\$927
	24 ½	103	1 ⅜	89	6	40C25103TH	\$875	\$919
	24 ½	102	1 ⅜	88	6	40C25102TH	\$866	\$910
	24 ½	101	1 ⅜	88	6	40C25101TH	\$857	\$900
	24 ½	100	1 ⅜	87	6	40C25100TH	\$848	\$891
	24 ½	99	1 ⅜	86	6	40C2599TH	\$839	\$881
	24 ½	98	1 ⅜	85	6	40C2598TH	\$830	\$872
	24 ½	97	1 ⅜	84	6	40C2597TH	\$821	\$863
	24 ½	96	1 ⅜	83	5	40C2596TH	\$812	\$853
	24 ½	95	1 ⅜	82	5	40C2595TH	\$801	\$842
	24 ½	94	1 ⅜	82	5	40C2594TH	\$790	\$830
	24 ½	93	1 ⅜	81	5	40C2593TH	\$779	\$818
	24 ½	92	1 ⅜	80	5	40C2592TH	\$768	\$807
	24 ½	91	1 ⅜	79	5	40C2591TH	\$757	\$795
	24 ½	90	1 ⅜	78	5	40C2590TH	\$746	\$784
	24 ½	89	1 ⅜	77	5	40C2589TH	\$735	\$772
24 ½	88	1 ⅜	76	5	40C2588TH	\$724	\$761	
24 ½	87	1 ⅜	75	5	40C2587TH	\$713	\$749	
24 ½	86	1 ⅜	75	5	40C2586TH	\$702	\$738	
24 ½	85	1 ⅜	74	5	40C2585TH	\$691	\$726	

• 3mm front edge, 1mm side and back edges

Specify: Model | Worksurface Laminate | Edge Finish

Model	Worksurface Laminate	Edge Finish
	see Forge Laminate Finishes	see Forge Edge Finishes (when applicable)

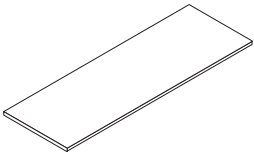
Description	D	W	H	CTN WT	CU FT	① Model	Tier 1	Tier 2
24½" d HPL Worksurfaces (continued) 	24 ½	84	1 ⅜	73	5	40C2584TH	\$680	\$714
	24 ½	83	1 ⅜	72	5	40C2583TH	\$672	\$706
	24 ½	82	1 ⅜	71	5	40C2582TH	\$664	\$698
	24 ½	81	1 ⅜	70	5	40C2581TH	\$656	\$689
	24 ½	80	1 ⅜	69	5	40C2580TH	\$648	\$681
	24 ½	79	1 ⅜	69	5	40C2579TH	\$640	\$672
	24 ½	78	1 ⅜	68	5	40C2578TH	\$632	\$664
	24 ½	77	1 ⅜	67	5	40C2577TH	\$624	\$656
	24 ½	76	1 ⅜	66	4	40C2576TH	\$616	\$647
	24 ½	75	1 ⅜	65	4	40C2575TH	\$608	\$639
	24 ½	74	1 ⅜	64	4	40C2574TH	\$600	\$630
	24 ½	73	1 ⅜	63	4	40C2573TH	\$592	\$622
	24 ½	72	1 ⅜	62	4	40C2572TH	\$584	\$614
	24 ½	71	1 ⅜	62	4	40C2571TH	\$575	\$604
	24 ½	70	1 ⅜	61	4	40C2570TH	\$567	\$596
	24 ½	69	1 ⅜	60	4	40C2569TH	\$559	\$587
	24 ½	68	1 ⅜	59	4	40C2568TH	\$551	\$579
	24 ½	67	1 ⅜	58	4	40C2567TH	\$543	\$571
	24 ½	66	1 ⅜	57	4	40C2566TH	\$535	\$562
	24 ½	65	1 ⅜	56	4	40C2565TH	\$527	\$554
	24 ½	64	1 ⅜	56	4	40C2564TH	\$519	\$545
	24 ½	63	1 ⅜	55	4	40C2563TH	\$511	\$537
	24 ½	62	1 ⅜	54	4	40C2562TH	\$503	\$529
	24 ½	61	1 ⅜	53	4	40C2561TH	\$495	\$520
	24 ½	60	1 ⅜	52	4	40C2560TH	\$487	\$512
	24 ½	59	1 ⅜	51	4	40C2559TH	\$480	\$504
	24 ½	58	1 ⅜	50	4	40C2558TH	\$473	\$497
	24 ½	57	1 ⅜	49	3	40C2557TH	\$465	\$489
	24 ½	56	1 ⅜	49	3	40C2556TH	\$457	\$480
	24 ½	55	1 ⅜	48	3	40C2555TH	\$449	\$472
	24 ½	54	1 ⅜	47	3	40C2554TH	\$440	\$462
	24 ½	53	1 ⅜	46	3	40C2553TH	\$433	\$455
24 ½	52	1 ⅜	45	3	40C2552TH	\$427	\$449	
24 ½	51	1 ⅜	44	3	40C2551TH	\$421	\$443	
24 ½	50	1 ⅜	43	3	40C2550TH	\$415	\$436	
24 ½	49	1 ⅜	43	3	40C2549TH	\$409	\$430	

• 3mm front edge, 1mm side and back edges

Specify: Model | Worksurface Laminate | Edge Finish

Model	Worksurface Laminate	Edge Finish
	see Forge Laminate Finishes	see Forge Edge Finishes (when applicable)

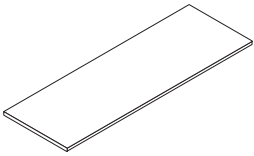
Description	D	W	H	CTN WT	CU FT	① Model	Tier 1	Tier 2
24½" d HPL Worksurfaces (continued) 	24 ½	48	1 ⅜	42	3	40C2548TH	\$403	\$424
	24 ½	47	1 ⅜	41	3	40C2547TH	\$401	\$422
	24 ½	46	1 ⅜	40	3	40C2546TH	\$400	\$420
	24 ½	45	1 ⅜	39	3	40C2545TH	\$398	\$418
	24 ½	44	1 ⅜	38	3	40C2544TH	\$396	\$416
	24 ½	43	1 ⅜	37	3	40C2543TH	\$394	\$414
	24 ½	42	1 ⅜	36	3	40C2542TH	\$393	\$413
	24 ½	41	1 ⅜	36	3	40C2541TH	\$391	\$411
	24 ½	40	1 ⅜	35	3	40C2540TH	\$390	\$410
	24 ½	39	1 ⅜	34	3	40C2539TH	\$388	\$408
	24 ½	38	1 ⅜	33	3	40C2538TH	\$386	\$406
	24 ½	37	1 ⅜	32	2	40C2537TH	\$385	\$405
	24 ½	36	1 ⅜	31	2	40C2536TH	\$383	\$403
	24 ½	35	1 ⅜	30	2	40C2535TH	\$379	\$398
	24 ½	34	1 ⅜	30	2	40C2534TH	\$376	\$395
	24 ½	33	1 ⅜	29	2	40C2533TH	\$373	\$392
	24 ½	32	1 ⅜	28	2	40C2532TH	\$370	\$389
	24 ½	31	1 ⅜	27	2	40C2531TH	\$367	\$386
	24 ½	30	1 ⅜	26	2	40C2530TH	\$364	\$383
	24 ½	29	1 ⅜	25	2	40C2529TH	\$361	\$380
	24 ½	28	1 ⅜	24	2	40C2528TH	\$358	\$376
	24 ½	27	1 ⅜	23	2	40C2527TH	\$356	\$374
	24 ½	26	1 ⅜	23	2	40C2526TH	\$353	\$371
	24 ½	25	1 ⅜	22	2	40C2525TH	\$351	\$369
	24 ½	24	1 ⅜	21	2	40C2524TH	\$349	\$367
	24 ½	23	1 ⅜	20	2	40C2523TH	\$346	\$364
	24 ½	22	1 ⅜	19	2	40C2522TH	\$343	\$361
	24 ½	21	1 ⅜	18	2	40C2521TH	\$340	\$357
	24 ½	20	1 ⅜	17	2	40C2520TH	\$337	\$354
	24 ½	19	1 ⅜	17	2	40C2519TH	\$335	\$352
	24 ½	18	1 ⅜	16	2	40C2518TH	\$333	\$350
	24 ½	17	1 ⅜	15	1	40C2517TH	\$330	\$347
	24 ½	16	1 ⅜	14	1	40C2516TH	\$328	\$345
24 ½	15	1 ⅜	13	1	40C2515TH	\$325	\$342	
24 ½	14	1 ⅜	12	1	40C2514TH	\$323	\$340	
24 ½	13	1 ⅜	11	1	40C2513TH	\$320	\$336	
24 ½	12	1 ⅜	10	1	40C2512TH	\$318	\$334	

• 3mm front edge, 1mm side and back edges

Specify: Model | Worksurface Laminate | Edge Finish

Model	Worksurface Laminate	Edge Finish
	see Forge Laminate Finishes	see Forge Edge Finishes (when applicable)

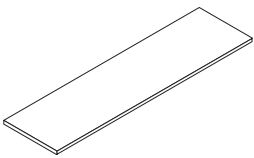
Description	D	W	H	CTN WT	CU FT	① Model	Tier 1	Tier 2
19½" d HPL Worksurfaces 	19 ½	120	1 ⅜	84	5	40C20120TH	\$820	\$861
	19 ½	119	1 ⅜	83	5	40C20119TH	\$815	\$856
	19 ½	118	1 ⅜	83	5	40C20118TH	\$810	\$851
	19 ½	117	1 ⅜	82	5	40C20117TH	\$805	\$846
	19 ½	116	1 ⅜	81	5	40C20116TH	\$800	\$840
	19 ½	115	1 ⅜	81	5	40C20115TH	\$796	\$836
	19 ½	114	1 ⅜	80	5	40C20114TH	\$792	\$832
	19 ½	113	1 ⅜	79	5	40C20113TH	\$788	\$828
	19 ½	112	1 ⅜	78	5	40C20112TH	\$784	\$824
	19 ½	111	1 ⅜	78	5	40C20111TH	\$780	\$819
	19 ½	110	1 ⅜	77	5	40C20110TH	\$776	\$815
	19 ½	109	1 ⅜	76	5	40C20109TH	\$772	\$811
	19 ½	108	1 ⅜	76	5	40C20108TH	\$768	\$807
	19 ½	107	1 ⅜	75	5	40C20107TH	\$763	\$802
	19 ½	106	1 ⅜	74	5	40C20106TH	\$758	\$796
	19 ½	105	1 ⅜	74	5	40C20105TH	\$753	\$791
	19 ½	104	1 ⅜	73	5	40C20104TH	\$747	\$785
	19 ½	103	1 ⅜	72	5	40C20103TH	\$741	\$779
	19 ½	102	1 ⅜	71	5	40C20102TH	\$735	\$772
	19 ½	101	1 ⅜	71	5	40C20101TH	\$727	\$764
	19 ½	100	1 ⅜	70	5	40C20100TH	\$721	\$758
	19 ½	99	1 ⅜	69	5	40C2099TH	\$715	\$751
	19 ½	98	1 ⅜	69	4	40C2098TH	\$709	\$745
	19 ½	97	1 ⅜	68	4	40C2097TH	\$703	\$739
	19 ½	96	1 ⅜	67	4	40C2096TH	\$697	\$732
	19 ½	95	1 ⅜	67	4	40C2095TH	\$687	\$722
	19 ½	94	1 ⅜	66	4	40C2094TH	\$677	\$711
	19 ½	93	1 ⅜	65	4	40C2093TH	\$667	\$701
	19 ½	92	1 ⅜	64	4	40C2092TH	\$658	\$691
	19 ½	91	1 ⅜	64	4	40C2091TH	\$649	\$682
	19 ½	90	1 ⅜	63	4	40C2090TH	\$642	\$675
	19 ½	89	1 ⅜	62	4	40C2089TH	\$633	\$665
19 ½	88	1 ⅜	62	4	40C2088TH	\$624	\$656	
19 ½	87	1 ⅜	61	4	40C2087TH	\$615	\$646	
19 ½	86	1 ⅜	60	4	40C2086TH	\$606	\$637	
19 ½	85	1 ⅜	60	4	40C2085TH	\$597	\$627	

• 3mm front edge, 1mm side and back edges

Specify: Model | Worksurface Laminate | Edge Finish

Model	Worksurface Laminate	Edge Finish
	see Forge Laminate Finishes	see Forge Edge Finishes (when applicable)

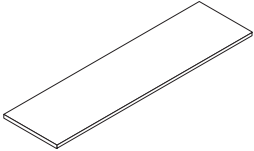
Description	D	W	H	CTN WT	CU FT	① Model	Tier 1	Tier 2
19½" d HPL Worksurfaces (continued) 	19 ½	84	1 ⅜	59	4	40C2084TH	\$588	\$618
	19 ½	83	1 ⅜	58	4	40C2083TH	\$582	\$612
	19 ½	82	1 ⅜	57	4	40C2082TH	\$576	\$605
	19 ½	81	1 ⅜	57	4	40C2081TH	\$571	\$600
	19 ½	80	1 ⅜	56	4	40C2080TH	\$566	\$595
	19 ½	79	1 ⅜	55	4	40C2079TH	\$561	\$590
	19 ½	78	1 ⅜	55	4	40C2078TH	\$556	\$584
	19 ½	77	1 ⅜	54	4	40C2077TH	\$551	\$579
	19 ½	76	1 ⅜	53	4	40C2076TH	\$545	\$573
	19 ½	75	1 ⅜	53	4	40C2075TH	\$539	\$566
	19 ½	74	1 ⅜	52	4	40C2074TH	\$532	\$559
	19 ½	73	1 ⅜	51	3	40C2073TH	\$524	\$551
	19 ½	72	1 ⅜	50	3	40C2072TH	\$518	\$544
	19 ½	71	1 ⅜	50	3	40C2071TH	\$513	\$539
	19 ½	70	1 ⅜	49	3	40C2070TH	\$509	\$535
	19 ½	69	1 ⅜	48	3	40C2069TH	\$504	\$530
	19 ½	68	1 ⅜	48	3	40C2068TH	\$499	\$524
	19 ½	67	1 ⅜	47	3	40C2067TH	\$493	\$518
	19 ½	66	1 ⅜	46	3	40C2066TH	\$486	\$511
	19 ½	65	1 ⅜	46	3	40C2065TH	\$480	\$504
	19 ½	64	1 ⅜	45	3	40C2064TH	\$472	\$496
	19 ½	63	1 ⅜	44	3	40C2063TH	\$466	\$490
	19 ½	62	1 ⅜	43	3	40C2062TH	\$459	\$482
	19 ½	61	1 ⅜	43	3	40C2061TH	\$452	\$475
	19 ½	60	1 ⅜	42	3	40C2060TH	\$446	\$469
	19 ½	59	1 ⅜	41	3	40C2059TH	\$439	\$461
	19 ½	58	1 ⅜	41	3	40C2058TH	\$432	\$454
	19 ½	57	1 ⅜	40	3	40C2057TH	\$425	\$447
	19 ½	56	1 ⅜	39	3	40C2056TH	\$419	\$440
	19 ½	55	1 ⅜	39	3	40C2055TH	\$412	\$433
	19 ½	54	1 ⅜	38	3	40C2054TH	\$405	\$426
	19 ½	53	1 ⅜	37	3	40C2053TH	\$402	\$423
	19 ½	52	1 ⅜	36	3	40C2052TH	\$399	\$419
19 ½	51	1 ⅜	36	3	40C2051TH	\$396	\$416	
19 ½	50	1 ⅜	35	3	40C2050TH	\$393	\$413	
19 ½	49	1 ⅜	34	3	40C2049TH	\$390	\$410	

• 3mm front edge, 1mm side and back edges

Specify: Model | Worksurface Laminate | Edge Finish

Model	Worksurface Laminate	Edge Finish
	see Forge Laminate Finishes	see Forge Edge Finishes (when applicable)

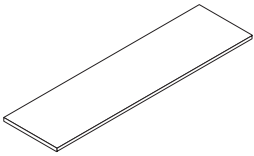
Description	D	W	H	CTN WT	CU FT	① Model	Tier 1	Tier 2
19½" d HPL Worksurfaces (continued) 	19 ½	48	1 ⅜	34	2	40C2048TH	\$387	\$407
	19 ½	47	1 ⅜	33	2	40C2047TH	\$384	\$404
	19 ½	46	1 ⅜	32	2	40C2046TH	\$382	\$402
	19 ½	45	1 ⅜	32	2	40C2045TH	\$379	\$398
	19 ½	44	1 ⅜	31	2	40C2044TH	\$377	\$396
	19 ½	43	1 ⅜	30	2	40C2043TH	\$375	\$394
	19 ½	42	1 ⅜	29	2	40C2042TH	\$373	\$392
	19 ½	41	1 ⅜	29	2	40C2041TH	\$369	\$388
	19 ½	40	1 ⅜	28	2	40C2040TH	\$366	\$385
	19 ½	39	1 ⅜	27	2	40C2039TH	\$362	\$381
	19 ½	38	1 ⅜	27	2	40C2038TH	\$359	\$377
	19 ½	37	1 ⅜	26	2	40C2037TH	\$356	\$374
	19 ½	36	1 ⅜	25	2	40C2036TH	\$353	\$371
	19 ½	35	1 ⅜	25	2	40C2035TH	\$350	\$368
	19 ½	34	1 ⅜	24	2	40C2034TH	\$347	\$365
	19 ½	33	1 ⅜	23	2	40C2033TH	\$344	\$362
	19 ½	32	1 ⅜	22	2	40C2032TH	\$341	\$359
	19 ½	31	1 ⅜	22	2	40C2031TH	\$338	\$355
	19 ½	30	1 ⅜	21	2	40C2030TH	\$335	\$352
	19 ½	29	1 ⅜	20	2	40C2029TH	\$332	\$349
	19 ½	28	1 ⅜	20	2	40C2028TH	\$328	\$345
	19 ½	27	1 ⅜	19	2	40C2027TH	\$324	\$341
	19 ½	26	1 ⅜	18	2	40C2026TH	\$321	\$338
	19 ½	25	1 ⅜	18	2	40C2025TH	\$318	\$334
	19 ½	24	1 ⅜	17	2	40C2024TH	\$315	\$331
	19 ½	23	1 ⅜	16	1	40C2023TH	\$312	\$328
	19 ½	22	1 ⅜	15	1	40C2022TH	\$309	\$325
	19 ½	21	1 ⅜	15	1	40C2021TH	\$307	\$323
	19 ½	20	1 ⅜	14	1	40C2020TH	\$304	\$320
	19 ½	19	1 ⅜	13	1	40C2019TH	\$302	\$318
	19 ½	18	1 ⅜	13	1	40C2018TH	\$300	\$315
	19 ½	17	1 ⅜	12	1	40C2017TH	\$297	\$312
	19 ½	16	1 ⅜	11	1	40C2016TH	\$294	\$309
	19 ½	15	1 ⅜	11	1	40C2015TH	\$290	\$305
19 ½	14	1 ⅜	10	1	40C2014TH	\$287	\$302	
19 ½	13	1 ⅜	9	1	40C2013TH	\$284	\$299	
19 ½	12	1 ⅜	8	1	40C2012TH	\$280	\$294	

• 3mm front edge, 1mm side and back edges

Specify: Model | Worksurface Laminate | Edge Finish

Model	Worksurface Laminate	Edge Finish
	see Forge Laminate Finishes	see Forge Edge Finishes (when applicable)

Description	D	W	H	CTN WT	CU FT	① Model	Tier 1	Tier 2
HPL Corner Worksurfaces	24 ½	29	1 ⅝	35	2	40C2929CTWH	\$579	\$608
	24 ½	24	1 ⅝	24	2	40C2424CTWH	\$545	\$573

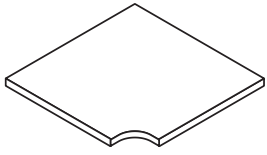

- 3mm front edge, 1mm side and back edges
- brackets must be specified separately, [see page 69](#)

Specify: Model | Worksurface Laminate | Edge Finish

Model	Worksurface Laminate	Edge Finish
	see Forge Laminate Finishes	see Forge Edge Finishes (when applicable)

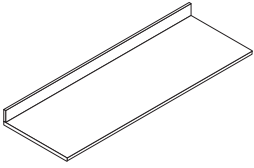
Description	D	W	H	CTN WT	CU FT	① Model	Tier 1	Tier 2
24½" d HPL Worksurfaces with Backsplash 	24 ½	120	5 ⅜	116	14	40C25120TWBH	\$1,130	\$1,187
	24 ½	119	5 ⅜	115	14	40C25119TWBH	\$1,120	\$1,176
	24 ½	118	5 ⅜	114	14	40C25118TWBH	\$1,110	\$1,166
	24 ½	117	5 ⅜	113	14	40C25117TWBH	\$1,100	\$1,155
	24 ½	116	5 ⅜	112	14	40C25116TWBH	\$1,096	\$1,151
	24 ½	115	5 ⅜	111	14	40C25115TWBH	\$1,092	\$1,147
	24 ½	114	5 ⅜	110	14	40C25114TWBH	\$1,088	\$1,143
	24 ½	113	5 ⅜	109	14	40C25113TWBH	\$1,085	\$1,140
	24 ½	112	5 ⅜	108	14	40C25112TWBH	\$1,082	\$1,137
	24 ½	111	5 ⅜	107	13	40C25111TWBH	\$1,076	\$1,130
	24 ½	110	5 ⅜	106	13	40C25110TWBH	\$1,070	\$1,124
	24 ½	109	5 ⅜	105	13	40C25109TWBH	\$1,064	\$1,118
	24 ½	108	5 ⅜	104	13	40C25108TWBH	\$1,058	\$1,111
	24 ½	107	5 ⅜	103	13	40C25107TWBH	\$1,045	\$1,098
	24 ½	106	5 ⅜	102	13	40C25106TWBH	\$1,038	\$1,090
	24 ½	105	5 ⅜	101	13	40C25105TWBH	\$1,031	\$1,083
	24 ½	104	5 ⅜	100	13	40C25104TWBH	\$1,024	\$1,076
	24 ½	103	5 ⅜	99	13	40C25103TWBH	\$1,017	\$1,068
	24 ½	102	5 ⅜	98	12	40C25102TWBH	\$1,010	\$1,061
	24 ½	101	5 ⅜	97	12	40C25101TWBH	\$1,005	\$1,056
	24 ½	100	5 ⅜	97	12	40C25100TWBH	\$999	\$1,049
	24 ½	99	5 ⅜	96	12	40C2599TWBH	\$993	\$1,043
	24 ½	98	5 ⅜	95	12	40C2598TWBH	\$987	\$1,037
	24 ½	97	5 ⅜	94	12	40C2597TWBH	\$981	\$1,031
	24 ½	96	5 ⅜	93	12	40C2596TWBH	\$975	\$1,024
	24 ½	95	5 ⅜	92	12	40C2595TWBH	\$965	\$1,014
	24 ½	94	5 ⅜	91	11	40C2594TWBH	\$963	\$1,012
	24 ½	93	5 ⅜	90	11	40C2593TWBH	\$949	\$997
	24 ½	92	5 ⅜	89	11	40C2592TWBH	\$935	\$982
	24 ½	91	5 ⅜	88	11	40C2591TWBH	\$921	\$968
	24 ½	90	5 ⅜	87	11	40C2590TWBH	\$907	\$953
	24 ½	89	5 ⅜	86	11	40C2589TWBH	\$926	\$973
24 ½	88	5 ⅜	85	11	40C2588TWBH	\$912	\$958	
24 ½	87	5 ⅜	84	11	40C2587TWBH	\$898	\$943	
24 ½	86	5 ⅜	83	11	40C2586TWBH	\$884	\$929	
24 ½	85	5 ⅜	82	10	40C2585TWBH	\$870	\$914	

- 3mm front edge, 1mm side and back edges
- requires backsplash seams to be sealed in the field

Specify: Model | Worksurface Laminate | Edge Finish

Model	Worksurface Laminate	Edge Finish
	see Forge Laminate Finishes	see Forge Edge Finishes (when applicable)

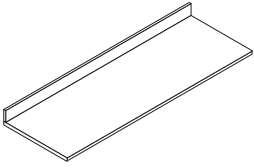
Description	D	W	H	CTN WT	CU FT	① Model	Tier 1	Tier 2
24½" d HPL Worksurfaces with Backsplash (continued) 	24 ½	84	5 ⅜	81	10	40C2584TWBH	\$856	\$899
	24 ½	83	5 ⅜	80	10	40C2583TWBH	\$916	\$962
	24 ½	82	5 ⅜	79	10	40C2582TWBH	\$902	\$948
	24 ½	81	5 ⅜	78	10	40C2581TWBH	\$888	\$933
	24 ½	80	5 ⅜	77	10	40C2580TWBH	\$875	\$919
	24 ½	79	5 ⅜	76	10	40C2579TWBH	\$861	\$905
	24 ½	78	5 ⅜	75	10	40C2578TWBH	\$848	\$891
	24 ½	77	5 ⅜	74	10	40C2577TWBH	\$834	\$876
	24 ½	76	5 ⅜	73	9	40C2576TWBH	\$820	\$861
	24 ½	75	5 ⅜	72	9	40C2575TWBH	\$789	\$829
	24 ½	74	5 ⅜	71	9	40C2574TWBH	\$786	\$826
	24 ½	73	5 ⅜	70	9	40C2573TWBH	\$783	\$823
	24 ½	72	5 ⅜	69	9	40C2572TWBH	\$780	\$819
	24 ½	71	5 ⅜	68	9	40C2571TWBH	\$809	\$850
	24 ½	70	5 ⅜	68	9	40C2570TWBH	\$799	\$839
	24 ½	69	5 ⅜	67	9	40C2569TWBH	\$789	\$829
	24 ½	68	5 ⅜	66	9	40C2568TWBH	\$779	\$818
	24 ½	67	5 ⅜	65	8	40C2567TWBH	\$769	\$808
	24 ½	66	5 ⅜	64	8	40C2566TWBH	\$759	\$797
	24 ½	65	5 ⅜	63	8	40C2565TWBH	\$748	\$786
	24 ½	64	5 ⅜	62	8	40C2564TWBH	\$738	\$775
	24 ½	63	5 ⅜	61	8	40C2563TWBH	\$728	\$765
	24 ½	62	5 ⅜	60	8	40C2562TWBH	\$717	\$753
	24 ½	61	5 ⅜	59	8	40C2561TWBH	\$707	\$743
	24 ½	60	5 ⅜	58	8	40C2560TWBH	\$697	\$732
	24 ½	59	5 ⅜	57	7	40C2559TWBH	\$718	\$754
	24 ½	58	5 ⅜	56	7	40C2558TWBH	\$709	\$745
	24 ½	57	5 ⅜	55	7	40C2557TWBH	\$700	\$735
	24 ½	56	5 ⅜	54	7	40C2556TWBH	\$690	\$725
	24 ½	55	5 ⅜	53	7	40C2555TWBH	\$681	\$716
	24 ½	54	5 ⅜	52	7	40C2554TWBH	\$672	\$706
	24 ½	53	5 ⅜	51	7	40C2553TWBH	\$665	\$699
24 ½	52	5 ⅜	50	7	40C2552TWBH	\$657	\$690	
24 ½	51	5 ⅜	49	7	40C2551TWBH	\$649	\$682	
24 ½	50	5 ⅜	48	6	40C2550TWBH	\$641	\$674	
24 ½	49	5 ⅜	47	6	40C2549TWBH	\$633	\$665	

- 3mm front edge, 1mm side and back edges
- requires backsplash seams to be sealed in the field

Specify: Model | Worksurface Laminate | Edge Finish

Model	Worksurface Laminate	Edge Finish
	see Forge Laminate Finishes	see Forge Edge Finishes (when applicable)

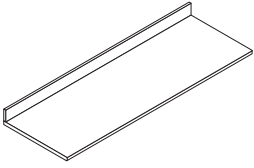
Description	D	W	H	CTN WT	CU FT	① Model	Tier 1	Tier 2
24½" d HPL Worksurfaces with Backsplash (continued) 	24 ½	48	5 ⅜	46	6	40C2548TWBH	\$625	\$657
	24 ½	47	5 ⅜	45	6	40C2547TWBH	\$588	\$618
	24 ½	46	5 ⅜	44	6	40C2546TWBH	\$586	\$616
	24 ½	45	5 ⅜	43	6	40C2545TWBH	\$585	\$615
	24 ½	44	5 ⅜	42	6	40C2544TWBH	\$584	\$614
	24 ½	43	5 ⅜	41	6	40C2543TWBH	\$582	\$612
	24 ½	42	5 ⅜	40	6	40C2542TWBH	\$580	\$609
	24 ½	41	5 ⅜	39	5	40C2541TWBH	\$530	\$557
	24 ½	40	5 ⅜	39	5	40C2540TWBH	\$527	\$554
	24 ½	39	5 ⅜	38	5	40C2539TWBH	\$524	\$551
	24 ½	38	5 ⅜	37	5	40C2538TWBH	\$521	\$548
	24 ½	37	5 ⅜	36	5	40C2537TWBH	\$518	\$544
	24 ½	36	5 ⅜	35	5	40C2536TWBH	\$515	\$541
	24 ½	35	5 ⅜	34	5	40C2535TWBH	\$512	\$538
	24 ½	34	5 ⅜	33	5	40C2534TWBH	\$509	\$535
	24 ½	33	5 ⅜	32	4	40C2533TWBH	\$506	\$532
	24 ½	32	5 ⅜	31	4	40C2532TWBH	\$481	\$506
	24 ½	31	5 ⅜	30	4	40C2531TWBH	\$478	\$502
	24 ½	30	5 ⅜	29	4	40C2530TWBH	\$475	\$499
	24 ½	29	5 ⅜	28	4	40C2529TWBH	\$472	\$496
	24 ½	28	5 ⅜	27	4	40C2528TWBH	\$469	\$493
	24 ½	27	5 ⅜	26	4	40C2527TWBH	\$466	\$490
	24 ½	26	5 ⅜	25	4	40C2526TWBH	\$463	\$487
	24 ½	25	5 ⅜	24	4	40C2525TWBH	\$460	\$483
	24 ½	24	5 ⅜	23	3	40C2524TWBH	\$457	\$480
	24 ½	23	5 ⅜	22	3	40C2523TWBH	\$422	\$444
	24 ½	22	5 ⅜	21	3	40C2522TWBH	\$419	\$440
	24 ½	21	5 ⅜	20	3	40C2521TWBH	\$416	\$437
	24 ½	20	5 ⅜	19	3	40C2520TWBH	\$413	\$434
	24 ½	19	5 ⅜	18	3	40C2519TWBH	\$410	\$431
	24 ½	18	5 ⅜	17	3	40C2518TWBH	\$407	\$428
	24 ½	17	5 ⅜	16	3	40C2517TWBH	\$391	\$411
24 ½	16	5 ⅜	15	3	40C2516TWBH	\$388	\$408	
24 ½	15	5 ⅜	14	2	40C2515TWBH	\$385	\$405	
24 ½	14	5 ⅜	13	2	40C2514TWBH	\$382	\$402	
24 ½	13	5 ⅜	12	2	40C2513TWBH	\$379	\$398	
24 ½	12	5 ⅜	11	2	40C2512TWBH	\$376	\$395	

- 3mm front edge, 1mm side and back edges
- requires backsplash seams to be sealed in the field

Specify: Model | Worksurface Laminate | Edge Finish

Model	Worksurface Laminate	Edge Finish
	see Forge Laminate Finishes	see Forge Edge Finishes (when applicable)

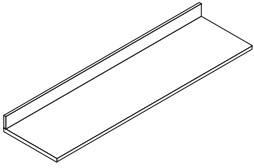
Description	D	W	H	CTN WT	CU FT	① Model	Tier 1	Tier 2
19½" d HPL Worksurfaces with Backsplash 	19 ½	120	5 ⅜	96	11	40C20120TWBH	\$978	\$1,027
	19 ½	119	5 ⅜	95	11	40C20119TWBH	\$944	\$992
	19 ½	118	5 ⅜	94	11	40C20118TWBH	\$936	\$983
	19 ½	117	5 ⅜	93	11	40C20117TWBH	\$928	\$975
	19 ½	116	5 ⅜	93	11	40C20116TWBH	\$925	\$972
	19 ½	115	5 ⅜	92	11	40C20115TWBH	\$922	\$969
	19 ½	114	5 ⅜	91	11	40C20114TWBH	\$919	\$965
	19 ½	113	5 ⅜	90	11	40C20113TWBH	\$916	\$962
	19 ½	112	5 ⅜	89	11	40C20112TWBH	\$914	\$960
	19 ½	111	5 ⅜	89	11	40C20111TWBH	\$912	\$958
	19 ½	110	5 ⅜	88	11	40C20110TWBH	\$909	\$955
	19 ½	109	5 ⅜	87	10	40C20109TWBH	\$907	\$953
	19 ½	108	5 ⅜	86	10	40C20108TWBH	\$905	\$951
	19 ½	107	5 ⅜	85	10	40C20107TWBH	\$903	\$948
	19 ½	106	5 ⅜	85	10	40C20106TWBH	\$899	\$944
	19 ½	105	5 ⅜	84	10	40C20105TWBH	\$890	\$935
	19 ½	104	5 ⅜	83	10	40C20104TWBH	\$882	\$927
	19 ½	103	5 ⅜	82	10	40C20103TWBH	\$873	\$917
	19 ½	102	5 ⅜	81	10	40C20102TWBH	\$865	\$909
	19 ½	101	5 ⅜	81	10	40C20101TWBH	\$853	\$896
	19 ½	100	5 ⅜	80	10	40C20100TWBH	\$845	\$888
	19 ½	99	5 ⅜	79	10	40C2099TWBH	\$846	\$889
	19 ½	98	5 ⅜	78	9	40C2098TWBH	\$838	\$880
	19 ½	97	5 ⅜	77	9	40C2097TWBH	\$830	\$872
	19 ½	96	5 ⅜	77	9	40C2096TWBH	\$822	\$864
	19 ½	95	5 ⅜	76	9	40C2095TWBH	\$824	\$866
	19 ½	94	5 ⅜	75	9	40C2094TWBH	\$816	\$857
	19 ½	93	5 ⅜	74	9	40C2093TWBH	\$808	\$849
	19 ½	92	5 ⅜	73	9	40C2092TWBH	\$800	\$840
	19 ½	91	5 ⅜	73	9	40C2091TWBH	\$792	\$832
	19 ½	90	5 ⅜	72	9	40C2090TWBH	\$784	\$824
	19 ½	89	5 ⅜	71	9	40C2089TWBH	\$777	\$816
	19 ½	88	5 ⅜	70	9	40C2088TWBH	\$769	\$808
19 ½	87	5 ⅜	69	8	40C2087TWBH	\$761	\$800	
19 ½	86	5 ⅜	69	8	40C2086TWBH	\$754	\$792	
19 ½	85	5 ⅜	68	8	40C2085TWBH	\$746	\$784	

- 3mm front edge, 1mm side and back edges
- requires backsplash seams to be sealed in the field

Specify: Model | Worksurface Laminate | Edge Finish

Model	Worksurface Laminate	Edge Finish
	see Forge Laminate Finishes	see Forge Edge Finishes (when applicable)

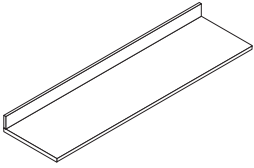
Description	D	W	H	CTN WT	CU FT	① Model	Tier 1	Tier 2
19½" d HPL Worksurfaces with Backsplash (continued) 	19 ½	84	5 ⅜	67	8	40C2084TWBH	\$738	\$775
	19 ½	83	5 ⅜	66	8	40C2083TWBH	\$733	\$770
	19 ½	82	5 ⅜	65	8	40C2082TWBH	\$727	\$764
	19 ½	81	5 ⅜	65	8	40C2081TWBH	\$721	\$758
	19 ½	80	5 ⅜	64	8	40C2080TWBH	\$715	\$751
	19 ½	79	5 ⅜	63	8	40C2079TWBH	\$709	\$745
	19 ½	78	5 ⅜	62	8	40C2078TWBH	\$703	\$739
	19 ½	77	5 ⅜	61	8	40C2077TWBH	\$700	\$735
	19 ½	76	5 ⅜	61	7	40C2076TWBH	\$691	\$726
	19 ½	75	5 ⅜	60	7	40C2075TWBH	\$682	\$717
	19 ½	74	5 ⅜	59	7	40C2074TWBH	\$673	\$707
	19 ½	73	5 ⅜	58	7	40C2073TWBH	\$664	\$698
	19 ½	72	5 ⅜	57	7	40C2072TWBH	\$655	\$688
	19 ½	71	5 ⅜	57	7	40C2071TWBH	\$682	\$717
	19 ½	70	5 ⅜	56	7	40C2070TWBH	\$672	\$706
	19 ½	69	5 ⅜	55	7	40C2069TWBH	\$662	\$696
	19 ½	68	5 ⅜	54	7	40C2068TWBH	\$652	\$685
	19 ½	67	5 ⅜	53	7	40C2067TWBH	\$642	\$675
	19 ½	66	5 ⅜	53	7	40C2066TWBH	\$632	\$664
	19 ½	65	5 ⅜	52	6	40C2065TWBH	\$622	\$654
	19 ½	64	5 ⅜	51	6	40C2064TWBH	\$612	\$643
	19 ½	63	5 ⅜	50	6	40C2063TWBH	\$602	\$633
	19 ½	62	5 ⅜	49	6	40C2062TWBH	\$592	\$622
	19 ½	61	5 ⅜	49	6	40C2061TWBH	\$586	\$616
	19 ½	60	5 ⅜	48	6	40C2060TWBH	\$581	\$611
	19 ½	59	5 ⅜	47	6	40C2059TWBH	\$576	\$605
	19 ½	58	5 ⅜	46	6	40C2058TWBH	\$570	\$599
	19 ½	57	5 ⅜	45	6	40C2057TWBH	\$565	\$594
	19 ½	56	5 ⅜	45	6	40C2056TWBH	\$560	\$588
	19 ½	55	5 ⅜	44	6	40C2055TWBH	\$552	\$580
	19 ½	54	5 ⅜	43	6	40C2054TWBH	\$545	\$573
	19 ½	53	5 ⅜	42	5	40C2053TWBH	\$540	\$567
19 ½	52	5 ⅜	41	5	40C2052TWBH	\$535	\$562	
19 ½	51	5 ⅜	41	5	40C2051TWBH	\$531	\$558	
19 ½	50	5 ⅜	40	5	40C2050TWBH	\$527	\$554	
19 ½	49	5 ⅜	39	5	40C2049TWBH	\$522	\$549	

- 3mm front edge, 1mm side and back edges
- requires backsplash seams to be sealed in the field

Specify: Model | Worksurface Laminate | Edge Finish

Model	Worksurface Laminate	Edge Finish
	see Forge Laminate Finishes	see Forge Edge Finishes (when applicable)

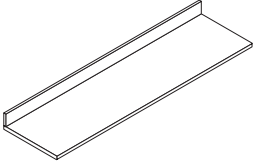
Description	D	W	H	CTN WT	CU FT	① Model	Tier 1	Tier 2
19½" d HPL Worksurfaces with Backsplash (continued) 	19 ½	48	5 ⅜	38	5	40C2048TWBH	\$517	\$543
	19 ½	47	5 ⅜	37	5	40C2047TWBH	\$515	\$541
	19 ½	46	5 ⅜	37	5	40C2046TWBH	\$512	\$538
	19 ½	45	5 ⅜	36	5	40C2045TWBH	\$509	\$535
	19 ½	44	5 ⅜	35	5	40C2044TWBH	\$507	\$533
	19 ½	43	5 ⅜	34	5	40C2043TWBH	\$504	\$530
	19 ½	42	5 ⅜	33	4	40C2042TWBH	\$501	\$527
	19 ½	41	5 ⅜	33	4	40C2041TWBH	\$496	\$521
	19 ½	40	5 ⅜	32	4	40C2040TWBH	\$492	\$517
	19 ½	39	5 ⅜	31	4	40C2039TWBH	\$488	\$513
	19 ½	38	5 ⅜	30	4	40C2038TWBH	\$484	\$509
	19 ½	37	5 ⅜	29	4	40C2037TWBH	\$480	\$504
	19 ½	36	5 ⅜	29	4	40C2036TWBH	\$476	\$500
	19 ½	35	5 ⅜	28	4	40C2035TWBH	\$471	\$495
	19 ½	34	5 ⅜	27	4	40C2034TWBH	\$467	\$491
	19 ½	33	5 ⅜	26	4	40C2033TWBH	\$463	\$487
	19 ½	32	5 ⅜	25	4	40C2032TWBH	\$459	\$482
	19 ½	31	5 ⅜	25	3	40C2031TWBH	\$455	\$478
	19 ½	30	5 ⅜	24	3	40C2030TWBH	\$451	\$474
	19 ½	29	5 ⅜	23	3	40C2029TWBH	\$445	\$468
	19 ½	28	5 ⅜	22	3	40C2028TWBH	\$440	\$462
	19 ½	27	5 ⅜	21	3	40C2027TWBH	\$435	\$457
	19 ½	26	5 ⅜	21	3	40C2026TWBH	\$430	\$452
	19 ½	25	5 ⅜	20	3	40C2025TWBH	\$425	\$447
	19 ½	24	5 ⅜	19	3	40C2024TWBH	\$420	\$441
	19 ½	23	5 ⅜	18	3	40C2023TWBH	\$412	\$433
	19 ½	22	5 ⅜	17	3	40C2022TWBH	\$404	\$425
	19 ½	21	5 ⅜	17	3	40C2021TWBH	\$396	\$416
	19 ½	20	5 ⅜	16	2	40C2020TWBH	\$388	\$408
	19 ½	19	5 ⅜	15	2	40C2019TWBH	\$380	\$399
	19 ½	18	5 ⅜	14	2	40C2018TWBH	\$372	\$391
	19 ½	17	5 ⅜	13	2	40C2017TWBH	\$368	\$387
	19 ½	16	5 ⅜	13	2	40C2016TWBH	\$364	\$383
19 ½	15	5 ⅜	12	2	40C2015TWBH	\$360	\$378	
19 ½	14	5 ⅜	11	2	40C2014TWBH	\$355	\$373	
19 ½	13	5 ⅜	10	2	40C2013TWBH	\$351	\$369	
19 ½	12	5 ⅜	9	2	40C2012TWBH	\$347	\$365	

- 3mm front edge, 1mm side and back edges
- requires backsplash seams to be sealed in the field

Specify: Model | Worksurface Laminate | Edge Finish

Model	Worksurface Laminate	Edge Finish
	see Forge Laminate Finishes	see Forge Edge Finishes (when applicable)

Description	D	W	H	CTN WT	CU FT	① Model	Tier 1	Tier 2
HPL Corner Worksurface with Backsplash	24 1/2	29	5 3/6	42	4	40C2929CTWHBS	\$690	\$725
	19 1/2	24	5 3/6	30	3	40C2424CTWHBS	\$650	\$683

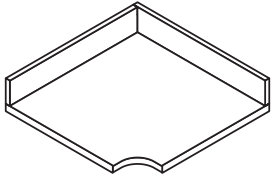

- requires backsplash seams to be sealed in the field
- brackets must be specified separately, [see page 69](#)

Specify: Model | Worksurface Laminate | Edge Finish

HPL Side Splash	3/4	23 3/8	4	2	1	40C123SSH	\$99	\$104
	3/4	18 3/8	4	2	1	40C118SSH	\$97	\$102

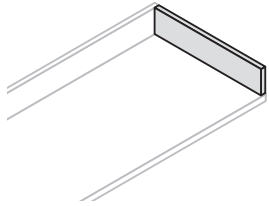

Specify: Model | Worksurface Laminate

HPL Side Splash Flush with Storage Cabinets	3/4	22 1/2	4	2	1	40C123SSFH	\$94	\$99
	3/4	17 1/2	4	2	1	40C118SSFH	\$92	\$97

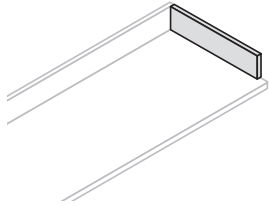

- aligns flush with storage cabinet chassis

Specify: Model | Worksurface Laminate

Model	Worksurface Laminate	Edge Finish
	see Forge Laminate Finishes	see Forge Edge Finishes (when applicable)

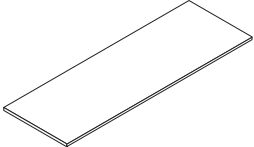
Description	D	W	H	CTN WT	CU FT	① Model	Tier 1	Tier 2	Tier 3	Tier 4
24½" d Solid Surface Worksurfaces 	24 ½	120	1	137	6	40C25120TS	\$4,001	\$4,441	\$5,201	\$6,402
	24 ½	119	1	136	6	40C25119TS	\$3,971	\$4,407	\$5,162	\$6,353
	24 ½	118	1	135	6	40C25118TS	\$3,942	\$4,375	\$5,124	\$6,306
	24 ½	117	1	134	6	40C25117TS	\$3,912	\$4,342	\$5,085	\$6,258
	24 ½	116	1	132	6	40C25116TS	\$3,882	\$4,308	\$5,046	\$6,210
	24 ½	115	1	131	6	40C25115TS	\$3,853	\$4,276	\$5,008	\$6,164
	24 ½	114	1	130	6	40C25114TS	\$3,824	\$4,244	\$4,971	\$6,118
	24 ½	113	1	129	6	40C25113TS	\$3,779	\$4,194	\$4,912	\$6,046
	24 ½	112	1	128	6	40C25112TS	\$3,733	\$4,143	\$4,852	\$5,972
	24 ½	111	1	127	6	40C25111TS	\$3,707	\$4,114	\$4,818	\$5,930
	24 ½	110	1	126	6	40C25110TS	\$3,682	\$4,086	\$4,786	\$5,890
	24 ½	109	1	125	6	40C25109TS	\$3,657	\$4,059	\$4,753	\$5,850
	24 ½	108	1	123	6	40C25108TS	\$3,632	\$4,031	\$4,721	\$5,810
	24 ½	107	1	122	6	40C25107TS	\$3,607	\$4,003	\$4,688	\$5,770
	24 ½	106	1	121	5	40C25106TS	\$3,582	\$3,975	\$4,656	\$5,730
	24 ½	105	1	120	5	40C25105TS	\$3,557	\$3,948	\$4,623	\$5,690
	24 ½	104	1	119	5	40C25104TS	\$3,532	\$3,920	\$4,591	\$5,650
	24 ½	103	1	118	5	40C25103TS	\$3,476	\$3,858	\$4,519	\$5,562
	24 ½	102	1	117	5	40C25102TS	\$3,420	\$3,796	\$4,446	\$5,472
	24 ½	101	1	116	5	40C25101TS	\$3,364	\$3,734	\$4,373	\$5,382
	24 ½	100	1	114	5	40C25100TS	\$3,308	\$3,672	\$4,300	\$5,293
	24 ½	99	1	113	5	40C2599TS	\$3,279	\$3,639	\$4,262	\$5,246
	24 ½	98	1	112	5	40C2598TS	\$3,251	\$3,608	\$4,226	\$5,201
	24 ½	97	1	111	5	40C2597TS	\$3,223	\$3,577	\$4,189	\$5,156
	24 ½	96	1	110	5	40C2596TS	\$3,195	\$3,546	\$4,153	\$5,111
	24 ½	95	1	109	5	40C2595TS	\$3,157	\$3,504	\$4,103	\$5,050
	24 ½	94	1	108	5	40C2594TS	\$3,120	\$3,463	\$4,055	\$4,991
	24 ½	93	1	106	5	40C2593TS	\$3,083	\$3,422	\$4,007	\$4,932
	24 ½	92	1	105	5	40C2592TS	\$3,046	\$3,381	\$3,959	\$4,873
	24 ½	91	1	104	5	40C2591TS	\$3,009	\$3,339	\$3,911	\$4,814
	24 ½	90	1	103	5	40C2590TS	\$2,972	\$3,298	\$3,863	\$4,754
	24 ½	89	1	102	5	40C2589TS	\$2,934	\$3,256	\$3,814	\$4,694
24 ½	88	1	101	5	40C2588TS	\$2,897	\$3,215	\$3,765	\$4,634	
24 ½	87	1	100	5	40C2587TS	\$2,860	\$3,174	\$3,717	\$4,575	
24 ½	86	1	99	5	40C2586TS	\$2,823	\$3,133	\$3,669	\$4,516	
24 ½	85	1	97	4	40C2585TS	\$2,786	\$3,092	\$3,621	\$4,457	

• 3mm radius front edge, sides and back are flat

Specify: Model | Worksurface Solid Surface

Model	Worksurface Solid Surface
	see Forge Solid Surface Finishes

Description	D	W	H	CTN WT	CU FT	① Model	Tier 1	Tier 2	Tier 3	Tier 4
24½" d Solid Surface Worksurfaces (continued)	24 ½	84	1	96	4	40C2584TS	\$2,749	\$3,051	\$3,573	\$4,398
	24 ½	83	1	95	4	40C2583TS	\$2,711	\$3,009	\$3,524	\$4,337
	24 ½	82	1	94	4	40C2582TS	\$2,674	\$2,968	\$3,476	\$4,278
	24 ½	81	1	93	4	40C2581TS	\$2,636	\$2,925	\$3,426	\$4,217
	24 ½	80	1	92	4	40C2580TS	\$2,599	\$2,884	\$3,378	\$4,158
	24 ½	79	1	91	4	40C2579TS	\$2,562	\$2,843	\$3,330	\$4,098
	24 ½	78	1	90	4	40C2578TS	\$2,525	\$2,802	\$3,282	\$4,039
	24 ½	77	1	88	4	40C2577TS	\$2,487	\$2,760	\$3,232	\$3,978
	24 ½	76	1	87	4	40C2576TS	\$2,450	\$2,719	\$3,184	\$3,919
	24 ½	75	1	86	4	40C2575TS	\$2,413	\$2,678	\$3,136	\$3,860
	24 ½	74	1	85	4	40C2574TS	\$2,375	\$2,636	\$3,087	\$3,799
	24 ½	73	1	84	4	40C2573TS	\$2,338	\$2,595	\$3,039	\$3,740
	24 ½	72	1	83	4	40C2572TS	\$2,301	\$2,554	\$2,991	\$3,681
	24 ½	71	1	82	4	40C2571TS	\$2,273	\$2,523	\$2,955	\$3,637
	24 ½	70	1	80	4	40C2570TS	\$2,244	\$2,491	\$2,917	\$3,590
	24 ½	69	1	79	4	40C2569TS	\$2,215	\$2,459	\$2,880	\$3,544
	24 ½	68	1	78	4	40C2568TS	\$2,186	\$2,426	\$2,842	\$3,498
	24 ½	67	1	77	4	40C2567TS	\$2,157	\$2,394	\$2,804	\$3,451
	24 ½	66	1	76	4	40C2566TS	\$2,128	\$2,362	\$2,766	\$3,405
	24 ½	65	1	75	4	40C2565TS	\$2,103	\$2,334	\$2,733	\$3,364
	24 ½	64	1	74	4	40C2564TS	\$2,077	\$2,305	\$2,699	\$3,322
	24 ½	63	1	73	3	40C2563TS	\$2,051	\$2,276	\$2,666	\$3,281
	24 ½	62	1	71	3	40C2562TS	\$2,025	\$2,247	\$2,632	\$3,239
	24 ½	61	1	70	3	40C2561TS	\$1,999	\$2,218	\$2,598	\$3,198
	24 ½	60	1	69	3	40C2560TS	\$1,973	\$2,189	\$2,564	\$3,156
	24 ½	59	1	68	3	40C2559TS	\$1,947	\$2,161	\$2,530	\$3,114
	24 ½	58	1	67	3	40C2558TS	\$1,921	\$2,132	\$2,497	\$3,073
	24 ½	57	1	66	3	40C2557TS	\$1,888	\$2,095	\$2,454	\$3,020
	24 ½	56	1	65	3	40C2556TS	\$1,856	\$2,060	\$2,412	\$2,969
	24 ½	55	1	64	3	40C2555TS	\$1,824	\$2,024	\$2,371	\$2,918
	24 ½	54	1	62	3	40C2554TS	\$1,792	\$1,989	\$2,329	\$2,866
	24 ½	53	1	61	3	40C2553TS	\$1,766	\$1,960	\$2,296	\$2,826
24 ½	52	1	60	3	40C2552TS	\$1,740	\$1,931	\$2,262	\$2,784	
24 ½	51	1	59	3	40C2551TS	\$1,715	\$1,904	\$2,230	\$2,744	
24 ½	50	1	58	3	40C2550TS	\$1,689	\$1,875	\$2,196	\$2,702	
24 ½	49	1	57	3	40C2549TS	\$1,664	\$1,847	\$2,163	\$2,662	

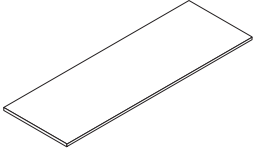

• 3mm radius front edge, sides and back are flat

Specify: Model | Worksurface Solid Surface

Model	Worksurface Solid Surface
	see Forge Solid Surface Finishes

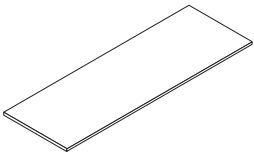
Description	D	W	H	CTN WT	CU FT	① Model	Tier 1	Tier 2	Tier 3	Tier 4
24½" d Solid Surface Worksurfaces (continued) 	24 ½	48	1	56	3	40C2548TS	\$1,639	\$1,819	\$2,131	\$2,622
	24 ½	47	1	55	3	40C2547TS	\$1,626	\$1,804	\$2,113	\$2,601
	24 ½	46	1	53	3	40C2546TS	\$1,613	\$1,790	\$2,096	\$2,580
	24 ½	45	1	52	3	40C2545TS	\$1,600	\$1,775	\$2,079	\$2,559
	24 ½	44	1	51	3	40C2544TS	\$1,587	\$1,761	\$2,062	\$2,538
	24 ½	43	1	50	3	40C2543TS	\$1,574	\$1,747	\$2,046	\$2,518
	24 ½	42	1	49	3	40C2542TS	\$1,561	\$1,732	\$2,029	\$2,497
	24 ½	41	1	48	2	40C2541TS	\$1,523	\$1,690	\$1,979	\$2,436
	24 ½	40	1	47	2	40C2540TS	\$1,486	\$1,649	\$1,931	\$2,377
	24 ½	39	1	45	2	40C2539TS	\$1,448	\$1,607	\$1,882	\$2,316
	24 ½	38	1	44	2	40C2538TS	\$1,411	\$1,566	\$1,834	\$2,257
	24 ½	37	1	43	2	40C2537TS	\$1,373	\$1,523	\$1,784	\$2,196
	24 ½	36	1	42	2	40C2536TS	\$1,336	\$1,482	\$1,736	\$2,137
	24 ½	35	1	41	2	40C2535TS	\$1,289	\$1,430	\$1,675	\$2,062
	24 ½	34	1	40	2	40C2534TS	\$1,242	\$1,378	\$1,614	\$1,986
	24 ½	33	1	39	2	40C2533TS	\$1,196	\$1,327	\$1,554	\$1,913
	24 ½	32	1	38	2	40C2532TS	\$1,149	\$1,275	\$1,493	\$1,838
	24 ½	31	1	36	2	40C2531TS	\$1,103	\$1,224	\$1,433	\$1,764
	24 ½	30	1	35	2	40C2530TS	\$1,057	\$1,173	\$1,373	\$1,690
	24 ½	29	1	34	2	40C2529TS	\$1,033	\$1,147	\$1,343	\$1,653
	24 ½	28	1	33	2	40C2528TS	\$1,011	\$1,122	\$1,314	\$1,618
	24 ½	27	1	32	2	40C2527TS	\$988	\$1,097	\$1,284	\$1,581
	24 ½	26	1	31	2	40C2526TS	\$966	\$1,072	\$1,256	\$1,546
	24 ½	25	1	30	2	40C2525TS	\$943	\$1,047	\$1,226	\$1,509
	24 ½	24	1	29	2	40C2524TS	\$921	\$1,022	\$1,197	\$1,474
	24 ½	23	1	27	2	40C2523TS	\$911	\$1,011	\$1,184	\$1,458
	24 ½	22	1	26	2	40C2522TS	\$901	\$1,000	\$1,171	\$1,441
	24 ½	21	1	25	2	40C2521TS	\$883	\$980	\$1,147	\$1,412
	24 ½	20	1	24	2	40C2520TS	\$865	\$960	\$1,124	\$1,383
	24 ½	19	1	23	1	40C2519TS	\$847	\$940	\$1,100	\$1,354
	24 ½	18	1	22	1	40C2518TS	\$829	\$920	\$1,077	\$1,326
	24 ½	17	1	21	1	40C2517TS	\$823	\$914	\$1,070	\$1,317
24 ½	16	1	19	1	40C2516TS	\$818	\$908	\$1,063	\$1,309	
24 ½	15	1	18	1	40C2515TS	\$813	\$902	\$1,057	\$1,301	
24 ½	14	1	17	1	40C2514TS	\$808	\$897	\$1,050	\$1,293	
24 ½	13	1	16	1	40C2513TS	\$803	\$891	\$1,044	\$1,285	
24 ½	12	1	15	1	40C2512TS	\$798	\$886	\$1,037	\$1,277	

• 3mm radius front edge, sides and back are flat

Specify: Model | Worksurface Solid Surface

Model | Worksurface Solid Surface

[see Forge Solid Surface Finishes](#)

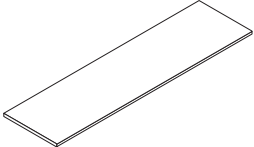
Description	D	W	H	CTN WT	CU FT	① Model	Tier 1	Tier 2	Tier 3	Tier 4
1 1/2" d Solid Surface Worksurfaces 	19 1/2	120	1	109	5	40C20120TS	\$3,132	\$3,477	\$4,072	\$5,011
	19 1/2	119	1	108	5	40C20119TS	\$3,104	\$3,445	\$4,035	\$4,966
	19 1/2	118	1	107	5	40C20118TS	\$3,077	\$3,415	\$3,999	\$4,922
	19 1/2	117	1	107	5	40C20117TS	\$3,050	\$3,385	\$3,964	\$4,879
	19 1/2	116	1	106	5	40C20116TS	\$3,022	\$3,354	\$3,928	\$4,834
	19 1/2	115	1	105	5	40C20115TS	\$2,995	\$3,324	\$3,893	\$4,791
	19 1/2	114	1	104	5	40C20114TS	\$2,968	\$3,294	\$3,858	\$4,748
	19 1/2	113	1	103	5	40C20113TS	\$2,922	\$3,243	\$3,799	\$4,675
	19 1/2	112	1	102	5	40C20112TS	\$2,876	\$3,192	\$3,739	\$4,602
	19 1/2	111	1	101	5	40C20111TS	\$2,849	\$3,162	\$3,704	\$4,558
	19 1/2	110	1	100	5	40C20110TS	\$2,824	\$3,135	\$3,671	\$4,518
	19 1/2	109	1	99	5	40C20109TS	\$2,799	\$3,107	\$3,639	\$4,478
	19 1/2	108	1	98	5	40C20108TS	\$2,774	\$3,079	\$3,606	\$4,438
	19 1/2	107	1	98	5	40C20107TS	\$2,748	\$3,050	\$3,572	\$4,397
	19 1/2	106	1	97	5	40C20106TS	\$2,723	\$3,023	\$3,540	\$4,357
	19 1/2	105	1	96	4	40C20105TS	\$2,698	\$2,995	\$3,507	\$4,317
	19 1/2	104	1	95	4	40C20104TS	\$2,672	\$2,966	\$3,474	\$4,275
	19 1/2	103	1	94	4	40C20103TS	\$2,639	\$2,929	\$3,430	\$4,222
	19 1/2	102	1	93	4	40C20102TS	\$2,607	\$2,893	\$3,388	\$4,170
	19 1/2	101	1	92	4	40C20101TS	\$2,575	\$2,858	\$3,347	\$4,119
	19 1/2	100	1	91	4	40C20100TS	\$2,543	\$2,822	\$3,305	\$4,068
	19 1/2	99	1	90	4	40C2099TS	\$2,529	\$2,807	\$3,288	\$4,046
	19 1/2	98	1	89	4	40C2098TS	\$2,515	\$2,792	\$3,270	\$4,024
	19 1/2	97	1	89	4	40C2097TS	\$2,501	\$2,776	\$3,251	\$4,002
	19 1/2	96	1	88	4	40C2096TS	\$2,487	\$2,761	\$3,233	\$3,979
	19 1/2	95	1	87	4	40C2095TS	\$2,461	\$2,731	\$3,199	\$3,937
	19 1/2	94	1	86	4	40C2094TS	\$2,434	\$2,701	\$3,164	\$3,894
	19 1/2	93	1	85	4	40C2093TS	\$2,407	\$2,671	\$3,128	\$3,850
	19 1/2	92	1	84	4	40C2092TS	\$2,380	\$2,641	\$3,093	\$3,807
	19 1/2	91	1	83	4	40C2091TS	\$2,353	\$2,611	\$3,058	\$3,764
	19 1/2	90	1	82	4	40C2090TS	\$2,326	\$2,581	\$3,023	\$3,721
	19 1/2	89	1	81	4	40C2089TS	\$2,299	\$2,551	\$2,988	\$3,678
19 1/2	88	1	80	4	40C2088TS	\$2,272	\$2,521	\$2,953	\$3,634	
19 1/2	87	1	80	4	40C2087TS	\$2,245	\$2,491	\$2,918	\$3,591	
19 1/2	86	1	79	4	40C2086TS	\$2,218	\$2,461	\$2,883	\$3,548	
19 1/2	85	1	78	4	40C2085TS	\$2,191	\$2,431	\$2,848	\$3,505	

• 3mm radius front edge, sides and back are flat

Specify: Model | Worksurface Solid Surface

Model	Worksurface Solid Surface
	see Forge Solid Surface Finishes

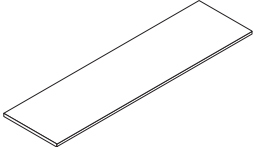
Description	D	W	H	CTN WT	CU FT	① Model	Tier 1	Tier 2	Tier 3	Tier 4
19½" d Solid Surface Worksurfaces (continued) 	19 ½	84	1	77	4	40C2084TS	\$2,164	\$2,401	\$2,813	\$3,462
	19 ½	83	1	76	4	40C2083TS	\$2,138	\$2,373	\$2,779	\$3,421
	19 ½	82	1	75	4	40C2082TS	\$2,113	\$2,345	\$2,747	\$3,381
	19 ½	81	1	74	4	40C2081TS	\$2,087	\$2,317	\$2,713	\$3,339
	19 ½	80	1	73	4	40C2080TS	\$2,062	\$2,289	\$2,681	\$3,299
	19 ½	79	1	72	4	40C2079TS	\$2,037	\$2,261	\$2,648	\$3,259
	19 ½	78	1	71	3	40C2078TS	\$2,012	\$2,233	\$2,616	\$3,219
	19 ½	77	1	71	3	40C2077TS	\$1,987	\$2,206	\$2,583	\$3,179
	19 ½	76	1	70	3	40C2076TS	\$1,962	\$2,178	\$2,551	\$3,139
	19 ½	75	1	69	3	40C2075TS	\$1,937	\$2,150	\$2,518	\$3,099
	19 ½	74	1	68	3	40C2074TS	\$1,912	\$2,122	\$2,486	\$3,059
	19 ½	73	1	67	3	40C2073TS	\$1,887	\$2,095	\$2,453	\$3,019
	19 ½	72	1	66	3	40C2072TS	\$1,862	\$2,067	\$2,421	\$2,979
	19 ½	71	1	65	3	40C2071TS	\$1,843	\$2,046	\$2,396	\$2,949
	19 ½	70	1	64	3	40C2070TS	\$1,823	\$2,024	\$2,370	\$2,917
	19 ½	69	1	63	3	40C2069TS	\$1,803	\$2,001	\$2,344	\$2,885
	19 ½	68	1	62	3	40C2068TS	\$1,783	\$1,979	\$2,318	\$2,853
	19 ½	67	1	62	3	40C2067TS	\$1,763	\$1,957	\$2,292	\$2,821
	19 ½	66	1	61	3	40C2066TS	\$1,743	\$1,935	\$2,266	\$2,789
	19 ½	65	1	60	3	40C2065TS	\$1,723	\$1,913	\$2,240	\$2,757
	19 ½	64	1	59	3	40C2064TS	\$1,703	\$1,890	\$2,214	\$2,725
	19 ½	63	1	58	3	40C2063TS	\$1,683	\$1,868	\$2,188	\$2,693
	19 ½	62	1	57	3	40C2062TS	\$1,663	\$1,846	\$2,162	\$2,661
	19 ½	61	1	56	3	40C2061TS	\$1,644	\$1,825	\$2,137	\$2,630
	19 ½	60	1	55	3	40C2060TS	\$1,624	\$1,803	\$2,111	\$2,598
	19 ½	59	1	54	3	40C2059TS	\$1,604	\$1,780	\$2,085	\$2,566
	19 ½	58	1	53	3	40C2058TS	\$1,584	\$1,758	\$2,059	\$2,534
	19 ½	57	1	53	3	40C2057TS	\$1,568	\$1,740	\$2,038	\$2,509
	19 ½	56	1	52	3	40C2056TS	\$1,553	\$1,724	\$2,019	\$2,485
	19 ½	55	1	51	3	40C2055TS	\$1,538	\$1,707	\$1,999	\$2,461
	19 ½	54	1	50	3	40C2054TS	\$1,522	\$1,689	\$1,979	\$2,435
	19 ½	53	1	49	3	40C2053TS	\$1,503	\$1,668	\$1,954	\$2,405
19 ½	52	1	48	3	40C2052TS	\$1,485	\$1,648	\$1,931	\$2,376	
19 ½	51	1	47	2	40C2051TS	\$1,466	\$1,627	\$1,906	\$2,346	
19 ½	50	1	46	2	40C2050TS	\$1,448	\$1,607	\$1,882	\$2,317	
19 ½	49	1	45	2	40C2049TS	\$1,429	\$1,586	\$1,858	\$2,286	

• 3mm radius front edge, sides and back are flat

Specify: Model | Worksurface Solid Surface

Model	Worksurface Solid Surface
	see Forge Solid Surface Finishes

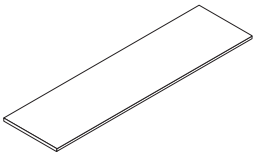
Description	D	W	H	CTN WT	CU FT	① Model	Tier 1	Tier 2	Tier 3	Tier 4
19½" d Solid Surface Worksurfaces (continued) 	19 ½	48	1	44	2	40C2048TS	\$1,411	\$1,566	\$1,834	\$2,258
	19 ½	47	1	44	2	40C2047TS	\$1,357	\$1,506	\$1,763	\$2,170
	19 ½	46	1	43	2	40C2046TS	\$1,304	\$1,447	\$1,695	\$2,086
	19 ½	45	1	42	2	40C2045TS	\$1,251	\$1,388	\$1,626	\$2,001
	19 ½	44	1	41	2	40C2044TS	\$1,198	\$1,329	\$1,557	\$1,916
	19 ½	43	1	40	2	40C2043TS	\$1,145	\$1,270	\$1,488	\$1,831
	19 ½	42	1	39	2	40C2042TS	\$1,092	\$1,212	\$1,419	\$1,746
	19 ½	41	1	38	2	40C2041TS	\$1,080	\$1,199	\$1,404	\$1,728
	19 ½	40	1	37	2	40C2040TS	\$1,069	\$1,187	\$1,390	\$1,710
	19 ½	39	1	36	2	40C2039TS	\$1,058	\$1,174	\$1,375	\$1,693
	19 ½	38	1	35	2	40C2038TS	\$1,046	\$1,161	\$1,360	\$1,674
	19 ½	37	1	35	2	40C2037TS	\$1,035	\$1,149	\$1,346	\$1,656
	19 ½	36	1	34	2	40C2036TS	\$1,023	\$1,136	\$1,330	\$1,637
	19 ½	35	1	33	2	40C2035TS	\$999	\$1,109	\$1,299	\$1,598
	19 ½	34	1	32	2	40C2034TS	\$976	\$1,083	\$1,269	\$1,562
	19 ½	33	1	31	2	40C2033TS	\$953	\$1,058	\$1,239	\$1,525
	19 ½	32	1	30	2	40C2032TS	\$930	\$1,032	\$1,209	\$1,488
	19 ½	31	1	29	2	40C2031TS	\$907	\$1,007	\$1,179	\$1,451
	19 ½	30	1	28	2	40C2030TS	\$884	\$981	\$1,149	\$1,414
	19 ½	29	1	27	2	40C2029TS	\$878	\$975	\$1,141	\$1,405
	19 ½	28	1	26	2	40C2028TS	\$873	\$969	\$1,135	\$1,397
	19 ½	27	1	26	2	40C2027TS	\$868	\$963	\$1,128	\$1,389
	19 ½	26	1	25	2	40C2026TS	\$863	\$958	\$1,122	\$1,381
	19 ½	25	1	24	2	40C2025TS	\$858	\$952	\$1,115	\$1,373
	19 ½	24	1	23	1	40C2024TS	\$853	\$947	\$1,109	\$1,365
	19 ½	23	1	22	1	40C2023TS	\$822	\$912	\$1,069	\$1,315
	19 ½	22	1	21	1	40C2022TS	\$791	\$878	\$1,028	\$1,266
	19 ½	21	1	20	1	40C2021TS	\$786	\$872	\$1,022	\$1,258
	19 ½	20	1	19	1	40C2020TS	\$781	\$867	\$1,015	\$1,250
	19 ½	19	1	18	1	40C2019TS	\$776	\$861	\$1,009	\$1,242
	19 ½	18	1	17	1	40C2018TS	\$771	\$855	\$1,002	\$1,233
	19 ½	17	1	17	1	40C2017TS	\$769	\$854	\$1,000	\$1,230
19 ½	16	1	16	1	40C2016TS	\$767	\$851	\$997	\$1,227	
19 ½	15	1	15	1	40C2015TS	\$765	\$849	\$995	\$1,224	
19 ½	14	1	14	1	40C2014TS	\$763	\$847	\$992	\$1,221	
19 ½	13	1	13	1	40C2013TS	\$761	\$845	\$989	\$1,218	
19 ½	12	1	12	1	40C2012TS	\$759	\$842	\$987	\$1,214	

• 3mm radius front edge, sides and back are flat

Specify: Model | Worksurface Solid Surface

Model	Worksurface Solid Surface
	see Forge Solid Surface Finishes

Description	D	W	H	CTN WT	CU FT	① Model	Tier 1	Tier 2	Tier 3	Tier 4
Solid Surface Corner Worksurfaces	29	29	1 3/16	35	2	40C2929CTS	\$1,549	\$1,719	\$2,014	\$2,478
	24	24	1 3/16	24	2	40C2424CTS	\$1,276	\$1,416	\$1,659	\$2,042

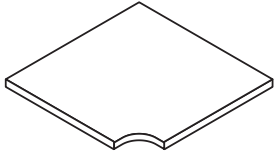

- 3mm radius front edge, sides and back are flat
- brackets must be specified separately, [see page 69](#)

Specify: Model | Worksurface Solid Surface

Model | Worksurface Solid Surface

[see Forge Solid Surface Finishes](#)

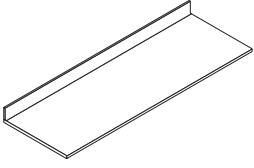
Description	D	W	H	CTN WT	CU FT	① Model	Tier 1	Tier 2	Tier 3	Tier 4
24½" d Solid Surface Worksurfaces with Integral Backsplash 	24 ½	120	5	153	14	40C25120TWBS	\$4,503	\$4,998	\$5,854	\$7,205
	24 ½	119	5	152	13	40C25119TWBS	\$4,466	\$4,957	\$5,806	\$7,146
	24 ½	118	5	151	13	40C25118TWBS	\$4,428	\$4,915	\$5,756	\$7,085
	24 ½	117	5	149	13	40C25117TWBS	\$4,390	\$4,873	\$5,707	\$7,024
	24 ½	116	5	148	13	40C25116TWBS	\$4,352	\$4,831	\$5,658	\$6,963
	24 ½	115	5	147	13	40C25115TWBS	\$4,314	\$4,789	\$5,608	\$6,902
	24 ½	114	5	146	13	40C25114TWBS	\$4,276	\$4,746	\$5,559	\$6,842
	24 ½	113	5	144	13	40C25113TWBS	\$4,238	\$4,704	\$5,509	\$6,781
	24 ½	112	5	143	13	40C25112TWBS	\$4,200	\$4,662	\$5,460	\$6,720
	24 ½	111	5	142	13	40C25111TWBS	\$4,162	\$4,620	\$5,411	\$6,659
	24 ½	110	5	141	13	40C25110TWBS	\$4,124	\$4,578	\$5,361	\$6,598
	24 ½	109	5	139	12	40C25109TWBS	\$4,086	\$4,535	\$5,312	\$6,538
	24 ½	108	5	138	12	40C25108TWBS	\$4,048	\$4,493	\$5,262	\$6,477
	24 ½	107	5	137	12	40C25107TWBS	\$4,011	\$4,452	\$5,214	\$6,418
	24 ½	106	5	136	12	40C25106TWBS	\$3,973	\$4,410	\$5,165	\$6,357
	24 ½	105	5	134	12	40C25105TWBS	\$3,935	\$4,368	\$5,116	\$6,296
	24 ½	104	5	133	12	40C25104TWBS	\$3,897	\$4,326	\$5,066	\$6,235
	24 ½	103	5	132	12	40C25103TWBS	\$3,859	\$4,283	\$5,017	\$6,174
	24 ½	102	5	130	12	40C25102TWBS	\$3,821	\$4,241	\$4,967	\$6,114
	24 ½	101	5	129	12	40C25101TWBS	\$3,783	\$4,199	\$4,918	\$6,053
	24 ½	100	5	128	11	40C25100TWBS	\$3,745	\$4,157	\$4,869	\$5,992
	24 ½	99	5	127	11	40C2599TWBS	\$3,707	\$4,115	\$4,819	\$5,931
	24 ½	98	5	125	11	40C2598TWBS	\$3,669	\$4,073	\$4,770	\$5,870
	24 ½	97	5	124	11	40C2597TWBS	\$3,631	\$4,030	\$4,720	\$5,810
	24 ½	96	5	123	11	40C2596TWBS	\$3,593	\$3,988	\$4,671	\$5,749
	24 ½	95	5	122	11	40C2595TWBS	\$3,555	\$3,941	\$4,616	\$5,681
	24 ½	94	5	120	11	40C2594TWBS	\$3,509	\$3,894	\$4,561	\$5,614
	24 ½	93	5	119	11	40C2593TWBS	\$3,468	\$3,849	\$4,508	\$5,548
	24 ½	92	5	118	11	40C2592TWBS	\$3,426	\$3,802	\$4,453	\$5,481
	24 ½	91	5	117	10	40C2591TWBS	\$3,384	\$3,756	\$4,399	\$5,414
	24 ½	90	5	115	10	40C2590TWBS	\$3,343	\$3,710	\$4,345	\$5,348
	24 ½	89	5	114	10	40C2589TWBS	\$3,301	\$3,664	\$4,291	\$5,281
24 ½	88	5	113	10	40C2588TWBS	\$3,259	\$3,617	\$4,236	\$5,214	
24 ½	87	5	111	10	40C2587TWBS	\$3,218	\$3,571	\$4,183	\$5,148	
24 ½	86	5	110	10	40C2586TWBS	\$3,176	\$3,525	\$4,128	\$5,081	
24 ½	85	5	109	10	40C2585TWBS	\$3,134	\$3,478	\$4,074	\$5,014	

- 3mm radius front edge, sides and back are flat
- 4" h backsplash

Specify: Model | Worksurface Solid Surface

Model	Worksurface Solid Surface
	see Forge Solid Surface Finishes

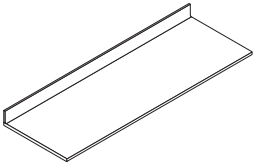
Description	D	W	H	CTN WT	CU FT	① Model	Tier 1	Tier 2	Tier 3	Tier 4
24½" d Solid Surface Worksurfaces with Integral Backsplash (continued) 	24 ½	84	5	108	10	40C2584TWBS	\$3,093	\$3,433	\$4,020	\$4,948
	24 ½	83	5	106	10	40C2583TWBS	\$3,051	\$3,386	\$3,966	\$4,881
	24 ½	82	5	105	10	40C2582TWBS	\$3,009	\$3,339	\$3,911	\$4,814
	24 ½	81	5	104	9	40C2581TWBS	\$2,967	\$3,293	\$3,856	\$4,746
	24 ½	80	5	103	9	40C2580TWBS	\$2,925	\$3,246	\$3,802	\$4,679
	24 ½	79	5	101	9	40C2579TWBS	\$2,883	\$3,200	\$3,747	\$4,612
	24 ½	78	5	100	9	40C2578TWBS	\$2,841	\$3,153	\$3,693	\$4,545
	24 ½	77	5	99	9	40C2577TWBS	\$2,802	\$3,110	\$3,643	\$4,483
	24 ½	76	5	98	9	40C2576TWBS	\$2,764	\$3,068	\$3,593	\$4,422
	24 ½	75	5	96	9	40C2575TWBS	\$2,725	\$3,025	\$3,543	\$4,360
	24 ½	74	5	95	9	40C2574TWBS	\$2,687	\$2,983	\$3,493	\$4,299
	24 ½	73	5	94	9	40C2573TWBS	\$2,648	\$2,939	\$3,442	\$4,237
	24 ½	72	5	92	8	40C2572TWBS	\$2,610	\$2,897	\$3,393	\$4,176
	24 ½	71	5	91	8	40C2571TWBS	\$2,576	\$2,859	\$3,348	\$4,121
	24 ½	70	5	90	8	40C2570TWBS	\$2,543	\$2,822	\$3,305	\$4,068
	24 ½	69	5	89	8	40C2569TWBS	\$2,510	\$2,786	\$3,262	\$4,015
	24 ½	68	5	87	8	40C2568TWBS	\$2,477	\$2,749	\$3,219	\$3,962
	24 ½	67	5	86	8	40C2567TWBS	\$2,444	\$2,712	\$3,177	\$3,910
	24 ½	66	5	85	8	40C2566TWBS	\$2,411	\$2,676	\$3,134	\$3,857
	24 ½	65	5	84	8	40C2565TWBS	\$2,378	\$2,639	\$3,091	\$3,804
	24 ½	64	5	82	8	40C2564TWBS	\$2,345	\$2,602	\$3,048	\$3,751
	24 ½	63	5	81	7	40C2563TWBS	\$2,312	\$2,566	\$3,005	\$3,698
	24 ½	62	5	80	7	40C2562TWBS	\$2,279	\$2,529	\$2,962	\$3,646
	24 ½	61	5	79	7	40C2561TWBS	\$2,246	\$2,493	\$2,919	\$3,593
	24 ½	60	5	77	7	40C2560TWBS	\$2,213	\$2,456	\$2,876	\$3,540
	24 ½	59	5	76	7	40C2559TWBS	\$2,180	\$2,419	\$2,833	\$3,487
	24 ½	58	5	75	7	40C2558TWBS	\$2,147	\$2,383	\$2,790	\$3,434
	24 ½	57	5	73	7	40C2557TWBS	\$2,114	\$2,346	\$2,748	\$3,382
	24 ½	56	5	72	7	40C2556TWBS	\$2,085	\$2,314	\$2,711	\$3,336
	24 ½	55	5	71	7	40C2555TWBS	\$2,055	\$2,281	\$2,672	\$3,288
	24 ½	54	5	70	7	40C2554TWBS	\$2,025	\$2,248	\$2,633	\$3,240
	24 ½	53	5	68	6	40C2553TWBS	\$1,995	\$2,214	\$2,594	\$3,192
24 ½	52	5	67	6	40C2552TWBS	\$1,965	\$2,181	\$2,555	\$3,144	
24 ½	51	5	66	6	40C2551TWBS	\$1,936	\$2,149	\$2,517	\$3,098	
24 ½	50	5	65	6	40C2550TWBS	\$1,906	\$2,116	\$2,478	\$3,050	
24 ½	49	5	63	6	40C2549TWBS	\$1,876	\$2,082	\$2,439	\$3,002	

• 3mm radius front edge, sides and back are flat

Specify: Model | Worksurface Solid Surface

Model	Worksurface Solid Surface
	see Forge Solid Surface Finishes

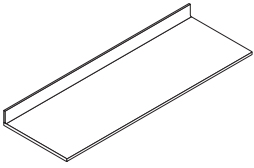
Description	D	W	H	CTN WT	CU FT	① Model	Tier 1	Tier 2	Tier 3	Tier 4
24½" d Solid Surface Worksurfaces with Integral Backsplash (continued) 	24 ½	48	5	62	6	40C2548TWBS	\$1,846	\$2,049	\$2,400	\$2,954
	24 ½	47	5	61	6	40C2547TWBS	\$1,838	\$2,019	\$2,365	\$2,910
	24 ½	46	5	60	6	40C2546TWBS	\$1,811	\$1,989	\$2,330	\$2,867
	24 ½	45	5	58	6	40C2545TWBS	\$1,784	\$1,959	\$2,295	\$2,824
	24 ½	44	5	57	5	40C2544TWBS	\$1,757	\$1,929	\$2,259	\$2,781
	24 ½	43	5	56	5	40C2543TWBS	\$1,730	\$1,899	\$2,224	\$2,738
	24 ½	42	5	54	5	40C2542TWBS	\$1,703	\$1,869	\$2,189	\$2,694
	24 ½	41	5	53	5	40C2541TWBS	\$1,676	\$1,839	\$2,154	\$2,651
	24 ½	40	5	52	5	40C2540TWBS	\$1,649	\$1,809	\$2,119	\$2,608
	24 ½	39	5	51	5	40C2539TWBS	\$1,622	\$1,779	\$2,084	\$2,565
	24 ½	38	5	49	5	40C2538TWBS	\$1,595	\$1,749	\$2,049	\$2,522
	24 ½	37	5	48	5	40C2537TWBS	\$1,568	\$1,719	\$2,014	\$2,478
	24 ½	36	5	47	5	40C2536TWBS	\$1,522	\$1,689	\$1,979	\$2,435
	24 ½	35	5	46	4	40C2535TWBS	\$1,461	\$1,622	\$1,899	\$2,338
	24 ½	34	5	44	4	40C2534TWBS	\$1,400	\$1,554	\$1,820	\$2,240
	24 ½	33	5	43	4	40C2533TWBS	\$1,339	\$1,486	\$1,741	\$2,142
	24 ½	32	5	42	4	40C2532TWBS	\$1,286	\$1,428	\$1,672	\$2,058
	24 ½	31	5	41	4	40C2531TWBS	\$1,234	\$1,370	\$1,605	\$1,975
	24 ½	30	5	39	4	40C2530TWBS	\$1,183	\$1,313	\$1,538	\$1,893
	24 ½	29	5	38	4	40C2529TWBS	\$1,157	\$1,284	\$1,504	\$1,850
	24 ½	28	5	37	4	40C2528TWBS	\$1,132	\$1,256	\$1,471	\$1,810
	24 ½	27	5	35	4	40C2527TWBS	\$1,107	\$1,228	\$1,439	\$1,770
	24 ½	26	5	34	4	40C2526TWBS	\$1,082	\$1,200	\$1,406	\$1,730
	24 ½	25	5	33	3	40C2525TWBS	\$1,057	\$1,173	\$1,373	\$1,690
	24 ½	24	5	32	3	40C2524TWBS	\$1,032	\$1,145	\$1,341	\$1,650
	24 ½	23	5	30	3	40C2523TWBS	\$1,016	\$1,128	\$1,321	\$1,626
	24 ½	22	5	29	3	40C2522TWBS	\$1,002	\$1,113	\$1,303	\$1,604
	24 ½	21	5	28	3	40C2521TWBS	\$988	\$1,097	\$1,285	\$1,581
	24 ½	20	5	27	3	40C2520TWBS	\$968	\$1,074	\$1,258	\$1,549
	24 ½	19	5	25	3	40C2519TWBS	\$948	\$1,052	\$1,232	\$1,517
	24 ½	18	5	24	3	40C2518TWBS	\$928	\$1,030	\$1,206	\$1,485
	24 ½	17	5	23	3	40C2517TWBS	\$923	\$1,024	\$1,199	\$1,476
24 ½	16	5	22	2	40C2516TWBS	\$917	\$1,017	\$1,192	\$1,466	
24 ½	15	5	20	2	40C2515TWBS	\$911	\$1,011	\$1,184	\$1,457	
24 ½	14	5	19	2	40C2514TWBS	\$905	\$1,004	\$1,176	\$1,447	
24 ½	13	5	18	2	40C2513TWBS	\$899	\$997	\$1,168	\$1,438	
24 ½	12	5	16	2	40C2512TWBS	\$893	\$991	\$1,160	\$1,428	

• 3mm radius front edge, sides and back are flat

Specify: Model | Worksurface Solid Surface

Model | Worksurface Solid Surface

[see Forge Solid Surface Finishes](#)

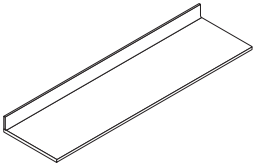
Description	D	W	H	CTN WT	CU FT	① Model	Tier 1	Tier 2	Tier 3	Tier 4
19½" d Solid Surface Worksurfaces with Integral Backsplash 	19 ½	120	5	125	11	40C20120TWBS	\$3,522	\$3,909	\$4,579	\$5,635
	19 ½	119	5	124	11	40C20119TWBS	\$3,492	\$3,876	\$4,539	\$5,586
	19 ½	118	5	123	11	40C20118TWBS	\$3,462	\$3,842	\$4,500	\$5,538
	19 ½	117	5	122	11	40C20117TWBS	\$3,432	\$3,809	\$4,461	\$5,490
	19 ½	116	5	121	11	40C20116TWBS	\$3,401	\$3,775	\$4,421	\$5,442
	19 ½	115	5	120	11	40C20115TWBS	\$3,371	\$3,742	\$4,382	\$5,394
	19 ½	114	5	119	11	40C20114TWBS	\$3,340	\$3,707	\$4,342	\$5,344
	19 ½	113	5	118	11	40C20113TWBS	\$3,305	\$3,669	\$4,297	\$5,288
	19 ½	112	5	117	10	40C20112TWBS	\$3,270	\$3,630	\$4,251	\$5,232
	19 ½	111	5	116	10	40C20111TWBS	\$3,235	\$3,591	\$4,206	\$5,176
	19 ½	110	5	115	10	40C20110TWBS	\$3,200	\$3,552	\$4,160	\$5,120
	19 ½	109	5	114	10	40C20109TWBS	\$3,165	\$3,513	\$4,115	\$5,064
	19 ½	108	5	113	10	40C20108TWBS	\$3,130	\$3,474	\$4,069	\$5,008
	19 ½	107	5	112	10	40C20107TWBS	\$3,087	\$3,426	\$4,012	\$4,938
	19 ½	106	5	111	10	40C20106TWBS	\$3,046	\$3,381	\$3,959	\$4,873
	19 ½	105	5	110	10	40C20105TWBS	\$3,005	\$3,335	\$3,906	\$4,807
	19 ½	104	5	109	10	40C20104TWBS	\$2,964	\$3,289	\$3,853	\$4,742
	19 ½	103	5	108	10	40C20103TWBS	\$2,923	\$3,244	\$3,799	\$4,676
	19 ½	102	5	107	10	40C20102TWBS	\$2,882	\$3,198	\$3,746	\$4,610
	19 ½	101	5	106	9	40C20101TWBS	\$2,862	\$3,176	\$3,720	\$4,578
	19 ½	100	5	104	9	40C20100TWBS	\$2,841	\$3,153	\$3,693	\$4,545
	19 ½	99	5	103	9	40C2099TWBS	\$2,830	\$3,141	\$3,678	\$4,527
	19 ½	98	5	102	9	40C2098TWBS	\$2,820	\$3,130	\$3,665	\$4,511
	19 ½	97	5	101	9	40C2097TWBS	\$2,809	\$3,117	\$3,651	\$4,494
	19 ½	96	5	100	9	40C2096TWBS	\$2,799	\$3,106	\$3,638	\$4,478
	19 ½	95	5	99	9	40C2095TWBS	\$2,767	\$3,071	\$3,596	\$4,426
	19 ½	94	5	98	9	40C2094TWBS	\$2,736	\$3,036	\$3,556	\$4,377
	19 ½	93	5	97	9	40C2093TWBS	\$2,705	\$3,002	\$3,516	\$4,327
	19 ½	92	5	96	9	40C2092TWBS	\$2,673	\$2,966	\$3,474	\$4,276
	19 ½	91	5	95	9	40C2091TWBS	\$2,643	\$2,933	\$3,435	\$4,228
19 ½	90	5	94	9	40C2090TWBS	\$2,614	\$2,901	\$3,398	\$4,182	
19 ½	89	5	93	8	40C2089TWBS	\$2,584	\$2,868	\$3,359	\$4,134	
19 ½	88	5	92	8	40C2088TWBS	\$2,555	\$2,835	\$3,321	\$4,087	
19 ½	87	5	91	8	40C2087TWBS	\$2,525	\$2,802	\$3,282	\$4,039	
19 ½	86	5	90	8	40C2086TWBS	\$2,496	\$2,770	\$3,244	\$3,993	
19 ½	85	5	89	8	40C2085TWBS	\$2,466	\$2,737	\$3,205	\$3,945	

• 3mm radius front edge, sides and back are flat

Specify: Model | Worksurface Solid Surface

Model	Worksurface Solid Surface
	see Forge Solid Surface Finishes

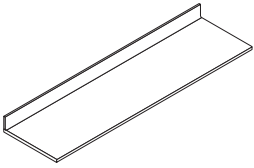
Description	D	W	H	CTN WT	CU FT	① Model	Tier 1	Tier 2	Tier 3	Tier 4
19½" d Solid Surface Worksurfaces with Integral Backsplash (continued) 	19 ½	84	5	88	8	40C2084TWBS	\$2,437	\$2,705	\$3,167	\$3,898
	19 ½	83	5	87	8	40C2083TWBS	\$2,411	\$2,676	\$3,134	\$3,858
	19 ½	82	5	86	8	40C2082TWBS	\$2,386	\$2,648	\$3,102	\$3,818
	19 ½	81	5	85	8	40C2081TWBS	\$2,360	\$2,620	\$3,068	\$3,776
	19 ½	80	5	84	8	40C2080TWBS	\$2,335	\$2,592	\$3,036	\$3,736
	19 ½	79	5	83	8	40C2079TWBS	\$2,309	\$2,563	\$3,002	\$3,694
	19 ½	78	5	82	7	40C2078TWBS	\$2,284	\$2,535	\$2,969	\$3,654
	19 ½	77	5	81	7	40C2077TWBS	\$2,252	\$2,499	\$2,927	\$3,602
	19 ½	76	5	80	7	40C2076TWBS	\$2,221	\$2,465	\$2,887	\$3,553
	19 ½	75	5	79	7	40C2075TWBS	\$2,190	\$2,430	\$2,846	\$3,503
	19 ½	74	5	78	7	40C2074TWBS	\$2,159	\$2,396	\$2,806	\$3,454
	19 ½	73	5	77	7	40C2073TWBS	\$2,128	\$2,362	\$2,766	\$3,404
	19 ½	72	5	76	7	40C2072TWBS	\$2,097	\$2,327	\$2,725	\$3,354
	19 ½	71	5	75	7	40C2071TWBS	\$2,074	\$2,302	\$2,696	\$3,318
	19 ½	70	5	73	7	40C2070TWBS	\$2,052	\$2,278	\$2,668	\$3,283
	19 ½	69	5	72	7	40C2069TWBS	\$2,030	\$2,253	\$2,639	\$3,248
	19 ½	68	5	71	7	40C2068TWBS	\$2,008	\$2,229	\$2,610	\$3,213
	19 ½	67	5	70	7	40C2067TWBS	\$1,986	\$2,204	\$2,582	\$3,178
	19 ½	66	5	69	6	40C2066TWBS	\$1,964	\$2,180	\$2,553	\$3,142
	19 ½	65	5	68	6	40C2065TWBS	\$1,942	\$2,156	\$2,525	\$3,107
	19 ½	64	5	67	6	40C2064TWBS	\$1,920	\$2,131	\$2,496	\$3,072
	19 ½	63	5	66	6	40C2063TWBS	\$1,898	\$2,107	\$2,467	\$3,037
	19 ½	62	5	65	6	40C2062TWBS	\$1,876	\$2,082	\$2,439	\$3,002
	19 ½	61	5	64	6	40C2061TWBS	\$1,856	\$2,060	\$2,412	\$2,969
	19 ½	60	5	63	6	40C2060TWBS	\$1,837	\$2,039	\$2,387	\$2,938
	19 ½	59	5	62	6	40C2059TWBS	\$1,818	\$2,017	\$2,363	\$2,908
	19 ½	58	5	61	6	40C2058TWBS	\$1,798	\$1,995	\$2,337	\$2,876
	19 ½	57	5	60	6	40C2057TWBS	\$1,779	\$1,974	\$2,312	\$2,846
	19 ½	56	5	59	6	40C2056TWBS	\$1,760	\$1,953	\$2,287	\$2,815
	19 ½	55	5	58	5	40C2055TWBS	\$1,736	\$1,927	\$2,257	\$2,778
19 ½	54	5	57	5	40C2054TWBS	\$1,712	\$1,900	\$2,226	\$2,739	
19 ½	53	5	56	5	40C2053TWBS	\$1,692	\$1,878	\$2,200	\$2,707	
19 ½	52	5	55	5	40C2052TWBS	\$1,671	\$1,855	\$2,172	\$2,674	
19 ½	51	5	54	5	40C2051TWBS	\$1,650	\$1,832	\$2,145	\$2,640	
19 ½	50	5	53	5	40C2050TWBS	\$1,630	\$1,809	\$2,119	\$2,608	
19 ½	49	5	52	5	40C2049TWBS	\$1,609	\$1,786	\$2,092	\$2,574	

• 3mm radius front edge, sides and back are flat

Specify: Model | Worksurface Solid Surface

Model	Worksurface Solid Surface
	see Forge Solid Surface Finishes

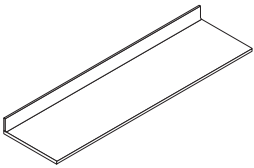
Description	D	W	H	CTN WT	CU FT	① Model	Tier 1	Tier 2	Tier 3	Tier 4
19½" d Solid Surface Worksurfaces with Integral Backsplash (continued) 	19 ½	48	5	51	5	40C2048TWBS	\$1,588	\$1,763	\$2,064	\$2,541
	19 ½	47	5	50	5	40C2047TWBS	\$1,528	\$1,696	\$1,986	\$2,444
	19 ½	46	5	49	5	40C2046TWBS	\$1,468	\$1,629	\$1,908	\$2,348
	19 ½	45	5	48	5	40C2045TWBS	\$1,408	\$1,562	\$1,830	\$2,252
	19 ½	44	5	47	5	40C2044TWBS	\$1,349	\$1,497	\$1,753	\$2,158
	19 ½	43	5	46	4	40C2043TWBS	\$1,289	\$1,430	\$1,675	\$2,062
	19 ½	42	5	45	4	40C2042TWBS	\$1,230	\$1,365	\$1,598	\$1,967
	19 ½	41	5	44	4	40C2041TWBS	\$1,210	\$1,343	\$1,572	\$1,935
	19 ½	40	5	42	4	40C2040TWBS	\$1,191	\$1,321	\$1,548	\$1,905
	19 ½	39	5	41	4	40C2039TWBS	\$1,171	\$1,299	\$1,522	\$1,873
	19 ½	38	5	40	4	40C2038TWBS	\$1,152	\$1,278	\$1,497	\$1,842
	19 ½	37	5	39	4	40C2037TWBS	\$1,132	\$1,256	\$1,471	\$1,810
	19 ½	36	5	38	4	40C2036TWBS	\$1,113	\$1,235	\$1,446	\$1,780
	19 ½	35	5	37	4	40C2035TWBS	\$1,093	\$1,213	\$1,420	\$1,748
	19 ½	34	5	36	4	40C2034TWBS	\$1,074	\$1,192	\$1,396	\$1,718
	19 ½	33	5	35	4	40C2033TWBS	\$1,055	\$1,170	\$1,371	\$1,687
	19 ½	32	5	34	3	40C2032TWBS	\$1,036	\$1,149	\$1,346	\$1,657
	19 ½	31	5	33	3	40C2031TWBS	\$1,017	\$1,128	\$1,321	\$1,626
	19 ½	30	5	32	3	40C2030TWBS	\$998	\$1,107	\$1,297	\$1,596
	19 ½	29	5	31	3	40C2029TWBS	\$991	\$1,100	\$1,288	\$1,586
	19 ½	28	5	30	3	40C2028TWBS	\$985	\$1,093	\$1,281	\$1,576
	19 ½	27	5	29	3	40C2027TWBS	\$979	\$1,087	\$1,273	\$1,566
	19 ½	26	5	28	3	40C2026TWBS	\$973	\$1,080	\$1,265	\$1,557
	19 ½	25	5	27	3	40C2025TWBS	\$967	\$1,073	\$1,257	\$1,547
	19 ½	24	5	26	3	40C2024TWBS	\$961	\$1,067	\$1,249	\$1,538
	19 ½	23	5	25	3	40C2023TWBS	\$945	\$1,049	\$1,229	\$1,512
	19 ½	22	5	24	3	40C2022TWBS	\$929	\$1,031	\$1,208	\$1,486
	19 ½	21	5	23	2	40C2021TWBS	\$913	\$1,013	\$1,187	\$1,461
	19 ½	20	5	22	2	40C2020TWBS	\$897	\$996	\$1,166	\$1,435
	19 ½	19	5	21	2	40C2019TWBS	\$881	\$978	\$1,145	\$1,410
	19 ½	18	5	20	2	40C2018TWBS	\$865	\$960	\$1,125	\$1,384
	19 ½	17	5	19	2	40C2017TWBS	\$860	\$954	\$1,117	\$1,375
19 ½	16	5	18	2	40C2016TWBS	\$855	\$948	\$1,111	\$1,367	
19 ½	15	5	17	2	40C2015TWBS	\$850	\$943	\$1,104	\$1,359	
19 ½	14	5	16	2	40C2014TWBS	\$844	\$937	\$1,097	\$1,350	
19 ½	13	5	15	2	40C2013TWBS	\$839	\$931	\$1,091	\$1,342	
19 ½	12	5	14	2	40C2012TWBS	\$834	\$926	\$1,084	\$1,334	

• 3mm radius front edge, sides and back are flat

Specify: Model | Worksurface Solid Surface

Model	Worksurface Solid Surface
	see Forge Solid Surface Finishes

Description	D	W	H	CTN WT	CU FT	① Model	Tier 1	Tier 2	Tier 3	Tier 4
Solid Surface Corner	29	29	5 3/16	42	4	40C2929CTSBS	\$1,766	\$1,960	\$2,296	\$2,826
Worksurface with Integral Backsplash	24	24	5 3/16	30	3	40C2424CTSBS	\$1,485	\$1,648	\$1,931	\$2,376

- 3mm radius front edge, sides and back are flat
- brackets must be specified separately, [see page 69](#)

Specify: Model | Worksurface Solid Surface

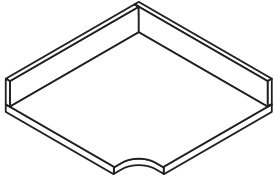

Model	Worksurface Solid Surface
	see Forge Solid Surface Finishes

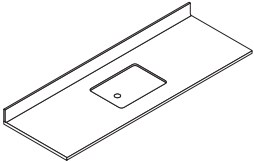
Description	D	W	H	CTN WT	CU FT	① Model	Tier 1	Tier 2	Tier 3	Tier 4
24½" d Solid Surface Worksurfaces with Integral Backsplash & Sink 	24 ½	120	5	173	26	40C25120TWBSSS	\$6,502	\$6,860	\$7,477	\$8,453
	24 ½	119	5	172	26	40C25119TWBSSS	\$6,468	\$6,824	\$7,438	\$8,408
	24 ½	118	5	171	25	40C25118TWBSSS	\$6,434	\$6,788	\$7,399	\$8,364
	24 ½	117	5	169	25	40C25117TWBSSS	\$6,400	\$6,752	\$7,360	\$8,320
	24 ½	116	5	168	25	40C25116TWBSSS	\$6,366	\$6,716	\$7,321	\$8,276
	24 ½	115	5	167	25	40C25115TWBSSS	\$6,332	\$6,680	\$7,282	\$8,232
	24 ½	114	5	166	25	40C25114TWBSSS	\$6,298	\$6,644	\$7,243	\$8,187
	24 ½	113	5	164	24	40C25113TWBSSS	\$6,245	\$6,588	\$7,182	\$8,119
	24 ½	112	5	163	24	40C25112TWBSSS	\$6,192	\$6,533	\$7,121	\$8,050
	24 ½	111	5	162	24	40C25111TWBSSS	\$6,162	\$6,501	\$7,086	\$8,011
	24 ½	110	5	161	24	40C25110TWBSSS	\$6,133	\$6,470	\$7,053	\$7,973
	24 ½	109	5	159	23	40C25109TWBSSS	\$6,104	\$6,440	\$7,020	\$7,935
	24 ½	108	5	158	23	40C25108TWBSSS	\$6,075	\$6,409	\$6,986	\$7,898
	24 ½	107	5	157	23	40C25107TWBSSS	\$6,046	\$6,379	\$6,953	\$7,860
	24 ½	106	5	156	23	40C25106TWBSSS	\$6,016	\$6,347	\$6,918	\$7,821
	24 ½	105	5	154	23	40C25105TWBSSS	\$5,987	\$6,316	\$6,885	\$7,783
	24 ½	104	5	153	22	40C25104TWBSSS	\$5,958	\$6,286	\$6,852	\$7,745
	24 ½	103	5	152	22	40C25103TWBSSS	\$5,908	\$6,233	\$6,794	\$7,680
	24 ½	102	5	150	22	40C25102TWBSSS	\$5,860	\$6,182	\$6,739	\$7,618
	24 ½	101	5	149	22	40C25101TWBSSS	\$5,812	\$6,132	\$6,684	\$7,556
	24 ½	100	5	148	22	40C25100TWBSSS	\$5,764	\$6,081	\$6,629	\$7,493
	24 ½	99	5	147	21	40C2599TWBSSS	\$5,716	\$6,030	\$6,573	\$7,431
	24 ½	98	5	145	21	40C2598TWBSSS	\$5,668	\$5,980	\$6,518	\$7,368
	24 ½	97	5	144	21	40C2597TWBSSS	\$5,620	\$5,929	\$6,463	\$7,306
	24 ½	96	5	143	21	40C2596TWBSSS	\$5,572	\$5,878	\$6,408	\$7,244
	24 ½	95	5	142	21	40C2595TWBSSS	\$5,531	\$5,835	\$6,361	\$7,190
	24 ½	94	5	140	20	40C2594TWBSSS	\$5,488	\$5,790	\$6,311	\$7,134
	24 ½	93	5	139	20	40C2593TWBSSS	\$5,445	\$5,744	\$6,262	\$7,079
	24 ½	92	5	138	20	40C2592TWBSSS	\$5,402	\$5,699	\$6,212	\$7,023
	24 ½	91	5	137	20	40C2591TWBSSS	\$5,359	\$5,654	\$6,163	\$6,967
24 ½	90	5	135	20	40C2590TWBSSS	\$5,316	\$5,608	\$6,113	\$6,911	
24 ½	89	5	134	19	40C2589TWBSSS	\$5,273	\$5,563	\$6,064	\$6,855	
24 ½	88	5	133	19	40C2588TWBSSS	\$5,230	\$5,518	\$6,015	\$6,799	
24 ½	87	5	131	19	40C2587TWBSSS	\$5,187	\$5,472	\$5,965	\$6,743	
24 ½	86	5	130	19	40C2586TWBSSS	\$5,144	\$5,427	\$5,916	\$6,687	
24 ½	85	5	129	19	40C2585TWBSSS	\$5,101	\$5,382	\$5,866	\$6,631	

- 3mm radius front edge, sides and back are flat
- Integral Sink is always Designer White

Specify: Model | Worksurface Solid Surface | Sink Location

Model	Worksurface Solid Surface	Sink Location
	see Forge Solid Surface Finishes	Sink location is available in 1" increments from left side of worksurface to centerline of sink with minimum of 12" to centerline from either edge of surface. Sink should always be centered over sink cabinet

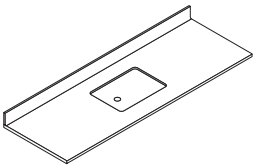
Description	D	W	H	CTN WT	CU FT	① Model	Tier 1	Tier 2	Tier 3	Tier 4
24½" d Solid Surface Worksurfaces with Integral Backsplash & Sink (continued) 	24 ½	84	5	128	18	40C2584TWBSSS	\$5,058	\$5,336	\$5,817	\$6,575
	24 ½	83	5	126	18	40C2583TWBSSS	\$5,012	\$5,288	\$5,764	\$6,516
	24 ½	82	5	125	18	40C2582TWBSSS	\$4,967	\$5,240	\$5,712	\$6,457
	24 ½	81	5	124	18	40C2581TWBSSS	\$4,921	\$5,192	\$5,659	\$6,397
	24 ½	80	5	123	17	40C2580TWBSSS	\$4,876	\$5,144	\$5,607	\$6,339
	24 ½	79	5	121	17	40C2579TWBSSS	\$4,830	\$5,096	\$5,555	\$6,279
	24 ½	78	5	120	17	40C2578TWBSSS	\$4,785	\$5,048	\$5,503	\$6,221
	24 ½	77	5	119	17	40C2577TWBSSS	\$4,740	\$5,001	\$5,451	\$6,162
	24 ½	76	5	118	17	40C2576TWBSSS	\$4,695	\$4,953	\$5,399	\$6,104
	24 ½	75	5	116	16	40C2575TWBSSS	\$4,668	\$4,925	\$5,368	\$6,068
	24 ½	74	5	115	16	40C2574TWBSSS	\$4,640	\$4,895	\$5,336	\$6,032
	24 ½	73	5	114	16	40C2573TWBSSS	\$4,613	\$4,867	\$5,305	\$5,997
	24 ½	72	5	112	16	40C2572TWBSSS	\$4,585	\$4,837	\$5,273	\$5,961
	24 ½	71	5	111	16	40C2571TWBSSS	\$4,544	\$4,794	\$5,226	\$5,907
	24 ½	70	5	110	15	40C2570TWBSSS	\$4,502	\$4,750	\$5,177	\$5,853
	24 ½	69	5	109	15	40C2569TWBSSS	\$4,460	\$4,705	\$5,129	\$5,798
	24 ½	68	5	107	15	40C2568TWBSSS	\$4,418	\$4,661	\$5,081	\$5,743
	24 ½	67	5	106	15	40C2567TWBSSS	\$4,376	\$4,617	\$5,032	\$5,689
	24 ½	66	5	105	15	40C2566TWBSSS	\$4,334	\$4,572	\$4,984	\$5,634
	24 ½	65	5	104	14	40C2565TWBSSS	\$4,292	\$4,528	\$4,936	\$5,580
	24 ½	64	5	102	14	40C2564TWBSSS	\$4,250	\$4,484	\$4,888	\$5,525
	24 ½	63	5	101	14	40C2563TWBSSS	\$4,227	\$4,459	\$4,861	\$5,495
	24 ½	62	5	100	14	40C2562TWBSSS	\$4,203	\$4,434	\$4,833	\$5,464
	24 ½	61	5	99	14	40C2561TWBSSS	\$4,179	\$4,409	\$4,806	\$5,433
	24 ½	60	5	97	13	40C2560TWBSSS	\$4,155	\$4,384	\$4,778	\$5,402
	24 ½	59	5	96	13	40C2559TWBSSS	\$4,122	\$4,349	\$4,740	\$5,359
	24 ½	58	5	95	13	40C2558TWBSSS	\$4,089	\$4,314	\$4,702	\$5,316
	24 ½	57	5	93	13	40C2557TWBSSS	\$4,056	\$4,279	\$4,664	\$5,273
	24 ½	56	5	92	13	40C2556TWBSSS	\$4,023	\$4,244	\$4,626	\$5,230
	24 ½	55	5	91	12	40C2555TWBSSS	\$3,990	\$4,209	\$4,589	\$5,187
24 ½	54	5	90	12	40C2554TWBSSS	\$3,957	\$4,175	\$4,551	\$5,144	
24 ½	53	5	88	12	40C2553TWBSSS	\$3,935	\$4,151	\$4,525	\$5,116	
24 ½	52	5	87	12	40C2552TWBSSS	\$3,914	\$4,129	\$4,501	\$5,088	
24 ½	51	5	86	11	40C2551TWBSSS	\$3,893	\$4,107	\$4,477	\$5,061	
24 ½	50	5	85	11	40C2550TWBSSS	\$3,872	\$4,085	\$4,453	\$5,034	
24 ½	49	5	83	11	40C2549TWBSSS	\$3,829	\$4,040	\$4,403	\$4,978	

- 3mm radius front edge, sides and back are flat
- Integral Sink is always Designer White

Specify: Model | Worksurface Solid Surface | Sink Location

Model	Worksurface Solid Surface	Sink Location
	see Forge Solid Surface Finishes	Sink location is available in 1" increments from left side of worksurface to centerline of sink with minimum of 12" to centerline from either edge of surface. Sink should always be centered over sink cabinet

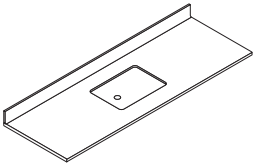
Description	D	W	H	CTN WT	CU FT	① Model	Tier 1	Tier 2	Tier 3	Tier 4
24½" d Solid Surface Worksurfaces with Integral Backsplash & Sink (continued) 	24 ½	48	5	82	11	40C2548TWBSSS	\$3,785	\$3,993	\$4,353	\$4,921
	24 ½	47	5	81	11	40C2547TWBSSS	\$3,770	\$3,977	\$4,336	\$4,901
	24 ½	46	5	80	10	40C2546TWBSSS	\$3,755	\$3,962	\$4,318	\$4,882
	24 ½	45	5	78	10	40C2545TWBSSS	\$3,740	\$3,946	\$4,301	\$4,862
	24 ½	44	5	77	10	40C2544TWBSSS	\$3,725	\$3,930	\$4,284	\$4,843
	24 ½	43	5	76	10	40C2543TWBSSS	\$3,710	\$3,914	\$4,267	\$4,823
	24 ½	42	5	74	10	40C2542TWBSSS	\$3,695	\$3,898	\$4,249	\$4,804
	24 ½	41	5	73	9	40C2541TWBSSS	\$3,651	\$3,852	\$4,199	\$4,746
	24 ½	40	5	72	9	40C2540TWBSSS	\$3,608	\$3,806	\$4,149	\$4,690
	24 ½	39	5	71	9	40C2539TWBSSS	\$3,565	\$3,761	\$4,100	\$4,635
	24 ½	38	5	69	9	40C2538TWBSSS	\$3,521	\$3,715	\$4,049	\$4,577
	24 ½	37	5	68	9	40C2537TWBSSS	\$3,478	\$3,669	\$4,000	\$4,521
	24 ½	36	5	67	8	40C2536TWBSSS	\$3,435	\$3,624	\$3,950	\$4,466
	24 ½	35	5	66	8	40C2535TWBSSS	\$3,356	\$3,582	\$3,904	\$4,414
	24 ½	34	5	64	8	40C2534TWBSSS	\$3,317	\$3,541	\$3,859	\$4,363
	24 ½	33	5	63	8	40C2533TWBSSS	\$3,278	\$3,458	\$3,770	\$4,261
	24 ½	32	5	62	8	40C2532TWBSSS	\$3,224	\$3,401	\$3,708	\$4,191
	24 ½	31	5	61	7	40C2531TWBSSS	\$3,171	\$3,345	\$3,647	\$4,122
	24 ½	30	5	59	7	40C2530TWBSSS	\$3,118	\$3,289	\$3,586	\$4,053
	24 ½	29	5	58	7	40C2529TWBSSS	\$3,096	\$3,266	\$3,560	\$4,025
	24 ½	28	5	57	7	40C2528TWBSSS	\$3,073	\$3,242	\$3,534	\$3,995
	24 ½	27	5	55	6	40C2527TWBSSS	\$3,050	\$3,218	\$3,508	\$3,965
	24 ½	26	5	54	6	40C2526TWBSSS	\$3,039	\$3,206	\$3,495	\$3,951
	24 ½	25	5	53	6	40C2525TWBSSS	\$2,999	\$3,164	\$3,449	\$3,899
24 ½	24	5	52	6	40C2524TWBSSS	\$2,959	\$3,122	\$3,403	\$3,847	

- 3mm radius front edge, sides and back are flat
- Integral Sink is always Designer White

Specify: Model | Worksurface Solid Surface | Sink Location

Model	Worksurface Solid Surface	Sink Location
	see Forge Solid Surface Finishes	Sink location is available in 1" increments from left side of worksurface to centerline of sink with minimum of 12" to centerline from either edge of surface. Sink should always be centered over sink cabinet

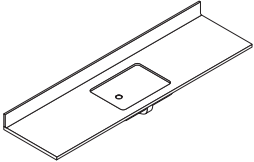
Description	D	W	H	CTN WT	CU FT	① Model	Tier 1	Tier 2	Tier 3	Tier 4
19½" d Solid Surface Worksurfaces with Integral Backsplash & Sink 	19 ½	120	5	144	21	40C20120TWBSSS	\$5,500	\$5,803	\$6,325	\$7,150
	19 ½	119	5	143	21	40C20119TWBSSS	\$5,463	\$5,763	\$6,282	\$7,102
	19 ½	118	5	142	21	40C20118TWBSSS	\$5,426	\$5,724	\$6,240	\$7,054
	19 ½	117	5	141	20	40C20117TWBSSS	\$5,389	\$5,685	\$6,197	\$7,006
	19 ½	116	5	140	20	40C20116TWBSSS	\$5,352	\$5,646	\$6,155	\$6,958
	19 ½	115	5	139	20	40C20115TWBSSS	\$5,316	\$5,608	\$6,113	\$6,911
	19 ½	114	5	138	20	40C20114TWBSSS	\$5,279	\$5,569	\$6,071	\$6,863
	19 ½	113	5	137	20	40C20113TWBSSS	\$5,242	\$5,530	\$6,028	\$6,815
	19 ½	112	5	136	20	40C20112TWBSSS	\$5,205	\$5,491	\$5,986	\$6,767
	19 ½	111	5	135	19	40C20111TWBSSS	\$5,179	\$5,464	\$5,956	\$6,733
	19 ½	110	5	133	19	40C20110TWBSSS	\$5,152	\$5,435	\$5,925	\$6,698
	19 ½	109	5	132	19	40C20109TWBSSS	\$5,125	\$5,407	\$5,894	\$6,663
	19 ½	108	5	131	19	40C20108TWBSSS	\$5,098	\$5,378	\$5,863	\$6,627
	19 ½	107	5	130	19	40C20107TWBSSS	\$5,067	\$5,346	\$5,827	\$6,587
	19 ½	106	5	129	19	40C20106TWBSSS	\$5,035	\$5,312	\$5,790	\$6,546
	19 ½	105	5	128	18	40C20105TWBSSS	\$5,003	\$5,278	\$5,753	\$6,504
	19 ½	104	5	127	18	40C20104TWBSSS	\$4,972	\$5,245	\$5,718	\$6,464
	19 ½	103	5	126	18	40C20103TWBSSS	\$4,909	\$5,179	\$5,645	\$6,382
	19 ½	102	5	125	18	40C20102TWBSSS	\$4,845	\$5,111	\$5,572	\$6,299
	19 ½	101	5	124	18	40C20101TWBSSS	\$4,830	\$5,096	\$5,555	\$6,279
	19 ½	100	5	123	18	40C20100TWBSSS	\$4,816	\$5,081	\$5,538	\$6,261
	19 ½	99	5	122	17	40C2099TWBSSS	\$4,802	\$5,066	\$5,522	\$6,243
	19 ½	98	5	121	17	40C2098TWBSSS	\$4,788	\$5,051	\$5,506	\$6,224
	19 ½	97	5	120	17	40C2097TWBSSS	\$4,774	\$5,037	\$5,490	\$6,206
	19 ½	96	5	119	17	40C2096TWBSSS	\$4,760	\$5,022	\$5,474	\$6,188
	19 ½	95	5	118	17	40C2095TWBSSS	\$4,729	\$4,989	\$5,438	\$6,148
	19 ½	94	5	117	17	40C2094TWBSSS	\$4,698	\$4,956	\$5,403	\$6,107
	19 ½	93	5	116	16	40C2093TWBSSS	\$4,667	\$4,924	\$5,367	\$6,067
	19 ½	92	5	115	16	40C2092TWBSSS	\$4,636	\$4,891	\$5,331	\$6,027
	19 ½	91	5	114	16	40C2091TWBSSS	\$4,605	\$4,858	\$5,296	\$5,987
19 ½	90	5	113	16	40C2090TWBSSS	\$4,574	\$4,826	\$5,260	\$5,946	
19 ½	89	5	112	16	40C2089TWBSSS	\$4,543	\$4,793	\$5,224	\$5,906	
19 ½	88	5	111	16	40C2088TWBSSS	\$4,512	\$4,760	\$5,189	\$5,866	
19 ½	87	5	110	15	40C2087TWBSSS	\$4,481	\$4,727	\$5,153	\$5,825	
19 ½	86	5	109	15	40C2086TWBSSS	\$4,450	\$4,695	\$5,118	\$5,785	
19 ½	85	5	108	15	40C2085TWBSSS	\$4,419	\$4,662	\$5,082	\$5,745	

- 3mm radius front edge, sides and back are flat
- Integral Sink is always Designer White

Specify: Model | Worksurface Solid Surface | Sink Location

Model	Worksurface Solid Surface	Sink Location
	see Forge Solid Surface Finishes	Sink location is available in 1" increments from left side of worksurface to centerline of sink with minimum of 12" to centerline from either edge of surface. Sink should always be centered over sink cabinet

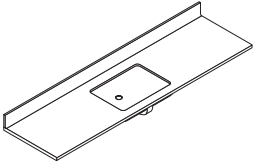
Description	D	W	H	CTN WT	CU FT	① Model	Tier 1	Tier 2	Tier 3	Tier 4
19½" d Solid Surface Worksurfaces with Integral Backsplash & Sink (continued) 	19 ½	84	5	107	15	40C2084TWBSSS	\$4,388	\$4,629	\$5,046	\$5,704
	19 ½	83	5	106	15	40C2083TWBSSS	\$4,362	\$4,602	\$5,016	\$5,671
	19 ½	82	5	105	15	40C2082TWBSSS	\$4,336	\$4,574	\$4,986	\$5,637
	19 ½	81	5	104	14	40C2081TWBSSS	\$4,310	\$4,547	\$4,957	\$5,603
	19 ½	80	5	103	14	40C2080TWBSSS	\$4,284	\$4,520	\$4,927	\$5,569
	19 ½	79	5	102	14	40C2079TWBSSS	\$4,258	\$4,492	\$4,897	\$5,535
	19 ½	78	5	101	14	40C2078TWBSSS	\$4,232	\$4,465	\$4,867	\$5,502
	19 ½	77	5	100	14	40C2077TWBSSS	\$4,185	\$4,415	\$4,813	\$5,441
	19 ½	76	5	99	14	40C2076TWBSSS	\$4,138	\$4,366	\$4,759	\$5,379
	19 ½	75	5	98	13	40C2075TWBSSS	\$4,113	\$4,339	\$4,730	\$5,347
	19 ½	74	5	97	13	40C2074TWBSSS	\$4,089	\$4,314	\$4,702	\$5,316
	19 ½	73	5	96	13	40C2073TWBSSS	\$4,065	\$4,289	\$4,675	\$5,285
	19 ½	72	5	95	13	40C2072TWBSSS	\$4,041	\$4,263	\$4,647	\$5,253
	19 ½	71	5	94	13	40C2071TWBSSS	\$4,014	\$4,235	\$4,616	\$5,218
	19 ½	70	5	93	13	40C2070TWBSSS	\$3,986	\$4,205	\$4,584	\$5,182
	19 ½	69	5	92	12	40C2069TWBSSS	\$3,959	\$4,177	\$4,553	\$5,147
	19 ½	68	5	91	12	40C2068TWBSSS	\$3,931	\$4,147	\$4,521	\$5,110
	19 ½	67	5	90	12	40C2067TWBSSS	\$3,903	\$4,118	\$4,488	\$5,074
	19 ½	66	5	89	12	40C2066TWBSSS	\$3,876	\$4,089	\$4,457	\$5,039
	19 ½	65	5	88	12	40C2065TWBSSS	\$3,848	\$4,060	\$4,425	\$5,002
	19 ½	64	5	87	12	40C2064TWBSSS	\$3,820	\$4,030	\$4,393	\$4,966
	19 ½	63	5	86	11	40C2063TWBSSS	\$3,802	\$4,011	\$4,372	\$4,943
	19 ½	62	5	85	11	40C2062TWBSSS	\$3,783	\$3,991	\$4,350	\$4,918
	19 ½	61	5	84	11	40C2061TWBSSS	\$3,764	\$3,971	\$4,329	\$4,893
	19 ½	60	5	83	11	40C2060TWBSSS	\$3,745	\$3,951	\$4,307	\$4,869
	19 ½	59	5	82	11	40C2059TWBSSS	\$3,729	\$3,934	\$4,288	\$4,848
	19 ½	58	5	81	11	40C2058TWBSSS	\$3,713	\$3,917	\$4,270	\$4,827
	19 ½	57	5	80	10	40C2057TWBSSS	\$3,697	\$3,900	\$4,252	\$4,806
	19 ½	56	5	79	10	40C2056TWBSSS	\$3,682	\$3,885	\$4,234	\$4,787
	19 ½	55	5	78	10	40C2055TWBSSS	\$3,666	\$3,868	\$4,216	\$4,766
19 ½	54	5	77	10	40C2054TWBSSS	\$3,650	\$3,851	\$4,198	\$4,745	
19 ½	53	5	76	10	40C2053TWBSSS	\$3,633	\$3,833	\$4,178	\$4,723	
19 ½	52	5	75	10	40C2052TWBSSS	\$3,617	\$3,816	\$4,160	\$4,702	
19 ½	51	5	74	9	40C2051TWBSSS	\$3,601	\$3,799	\$4,141	\$4,681	
19 ½	50	5	72	9	40C2050TWBSSS	\$3,585	\$3,782	\$4,123	\$4,661	
19 ½	49	5	71	9	40C2049TWBSSS	\$3,556	\$3,752	\$4,089	\$4,623	

- 3mm radius front edge, sides and back are flat
- Integral Sink is always Designer White

Specify: Model | Worksurface Solid Surface | Sink Location

Model	Worksurface Solid Surface	Sink Location
	see Forge Solid Surface Finishes	Sink location is available in 1" increments from left side of worksurface to centerline of sink with minimum of 12" to centerline from either edge of surface. Sink should always be centered over sink cabinet

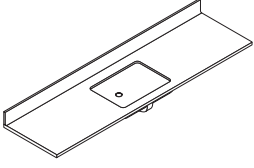
Description	D	W	H	CTN WT	CU FT	① Model	Tier 1	Tier 2	Tier 3	Tier 4
19½" d Solid Surface Worksurfaces with Integral Backsplash & Sink (continued) 	19 ½	48	5	70	9	40C2048TWBSSS	\$3,526	\$3,720	\$4,055	\$4,584
	19 ½	47	5	69	9	40C2047TWBSSS	\$3,464	\$3,655	\$3,984	\$4,503
	19 ½	46	5	68	9	40C2046TWBSSS	\$3,402	\$3,589	\$3,912	\$4,423
	19 ½	45	5	67	8	40C2045TWBSSS	\$3,340	\$3,524	\$3,841	\$4,342
	19 ½	44	5	66	8	40C2044TWBSSS	\$3,279	\$3,459	\$3,771	\$4,263
	19 ½	43	5	65	8	40C2043TWBSSS	\$3,217	\$3,394	\$3,700	\$4,182
	19 ½	42	5	64	8	40C2042TWBSSS	\$3,155	\$3,329	\$3,628	\$4,102
	19 ½	41	5	63	8	40C2041TWBSSS	\$3,140	\$3,313	\$3,611	\$4,082
	19 ½	40	5	62	8	40C2040TWBSSS	\$3,128	\$3,300	\$3,597	\$4,066
	19 ½	39	5	61	7	40C2039TWBSSS	\$3,116	\$3,287	\$3,583	\$4,051
	19 ½	38	5	60	7	40C2038TWBSSS	\$3,104	\$3,275	\$3,570	\$4,035
	19 ½	37	5	59	7	40C2037TWBSSS	\$3,092	\$3,262	\$3,556	\$4,020
	19 ½	36	5	58	7	40C2036TWBSSS	\$3,080	\$3,249	\$3,542	\$4,004
	19 ½	35	5	57	7	40C2035TWBSSS	\$3,060	\$3,228	\$3,519	\$3,978
	19 ½	34	5	56	7	40C2034TWBSSS	\$3,040	\$3,207	\$3,496	\$3,952
	19 ½	33	5	55	6	40C2033TWBSSS	\$3,020	\$3,186	\$3,473	\$3,926
	19 ½	32	5	54	6	40C2032TWBSSS	\$3,000	\$3,165	\$3,450	\$3,900
	19 ½	31	5	53	6	40C2031TWBSSS	\$2,959	\$3,122	\$3,403	\$3,847
	19 ½	30	5	52	6	40C2030TWBSSS	\$2,918	\$3,078	\$3,356	\$3,793
	19 ½	29	5	51	6	40C2029TWBSSS	\$2,911	\$3,071	\$3,348	\$3,784
19 ½	28	5	50	6	40C2028TWBSSS	\$2,905	\$3,065	\$3,341	\$3,777	
19 ½	27	5	49	5	40C2027TWBSSS	\$2,899	\$3,058	\$3,334	\$3,769	
19 ½	26	5	48	5	40C2026TWBSSS	\$2,893	\$3,052	\$3,327	\$3,761	
19 ½	25	5	47	5	40C2025TWBSSS	\$2,886	\$3,045	\$3,319	\$3,752	
19 ½	24	5	46	5	40C2024TWBSSS	\$2,880	\$3,038	\$3,312	\$3,744	

- 3mm radius front edge, sides and back are flat
- Integral Sink is always Designer White

Specify: Model | Worksurface Solid Surface | Sink Location

Model	Worksurface Solid Surface	Sink Location
	see Forge Solid Surface Finishes	Sink location is available in 1" increments from left side of worksurface to centerline of sink with minimum of 12" to centerline from either edge of surface. Sink should always be centered over sink cabinet

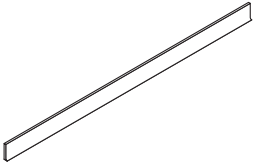
Description	D	W	H	CTN WT	CU FT	① Model	Tier 1	Tier 2	Tier 3	Tier 4
Solid Surface Backsplash 	½	120	4	16	2	40C1120BS	\$838	\$930	\$1,089	\$1,341
	½	119	4	16	2	40C1119BS	\$774	\$859	\$1,006	\$1,238
	½	118	4	16	2	40C1118BS	\$771	\$856	\$1,002	\$1,234
	½	117	4	16	2	40C1117BS	\$768	\$852	\$998	\$1,229
	½	116	4	15	2	40C1116BS	\$765	\$849	\$995	\$1,224
	½	115	4	15	2	40C1115BS	\$762	\$846	\$991	\$1,219
	½	114	4	15	2	40C1114BS	\$759	\$842	\$987	\$1,214
	½	113	4	15	1	40C1113BS	\$756	\$839	\$983	\$1,210
	½	112	4	15	1	40C1112BS	\$753	\$836	\$979	\$1,205
	½	111	4	15	1	40C1111BS	\$750	\$833	\$975	\$1,200
	½	110	4	15	1	40C1110BS	\$747	\$829	\$971	\$1,195
	½	109	4	15	1	40C1109BS	\$744	\$826	\$967	\$1,190
	½	108	4	14	1	40C1108BS	\$741	\$823	\$963	\$1,186
	½	107	4	14	1	40C1107BS	\$738	\$819	\$959	\$1,181
	½	106	4	14	1	40C1106BS	\$736	\$817	\$957	\$1,178
	½	105	4	14	1	40C1105BS	\$733	\$814	\$953	\$1,173
	½	104	4	14	1	40C1104BS	\$731	\$811	\$950	\$1,170
	½	103	4	14	1	40C1103BS	\$728	\$808	\$946	\$1,165
	½	102	4	14	1	40C1102BS	\$725	\$805	\$943	\$1,160
	½	101	4	14	1	40C1101BS	\$710	\$788	\$923	\$1,136
	½	100	4	13	1	40C1100BS	\$705	\$783	\$917	\$1,128
	½	99	4	13	1	40C199BS	\$700	\$777	\$910	\$1,120
	½	98	4	13	1	40C198BS	\$696	\$773	\$905	\$1,114
	½	97	4	13	1	40C197BS	\$691	\$767	\$898	\$1,106
	½	96	4	13	1	40C196BS	\$687	\$763	\$893	\$1,099
	½	95	4	13	1	40C195BS	\$609	\$676	\$792	\$974
	½	94	4	13	1	40C194BS	\$606	\$673	\$788	\$970
	½	93	4	12	1	40C193BS	\$603	\$669	\$784	\$965
	½	92	4	12	1	40C192BS	\$600	\$666	\$780	\$960
	½	91	4	12	1	40C191BS	\$597	\$663	\$776	\$955
	½	90	4	12	1	40C190BS	\$594	\$659	\$772	\$950
	½	89	4	12	1	40C189BS	\$591	\$656	\$768	\$946
½	88	4	12	1	40C188BS	\$588	\$653	\$764	\$941	
½	87	4	12	1	40C187BS	\$585	\$649	\$761	\$936	
½	86	4	12	1	40C186BS	\$582	\$646	\$757	\$931	
½	85	4	11	1	40C185BS	\$579	\$643	\$753	\$926	

Specify: Model | Worksurface Solid Surface

Model	Worksurface Solid Surface
	see Forge Solid Surface Finishes

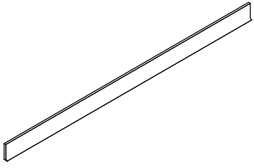
Description	D	W	H	CTN WT	CU FT	① Model	Tier 1	Tier 2	Tier 3	Tier 4
Solid Surface Backsplash (continued) 	½	84	4	11	1	40C184BS	\$575	\$638	\$748	\$920
	½	83	4	11	1	40C183BS	\$572	\$635	\$744	\$915
	½	82	4	11	1	40C182BS	\$569	\$632	\$740	\$910
	½	81	4	11	1	40C181BS	\$565	\$627	\$735	\$904
	½	80	4	11	1	40C180BS	\$562	\$624	\$731	\$899
	½	79	4	11	1	40C179BS	\$559	\$620	\$727	\$894
	½	78	4	11	1	40C178BS	\$555	\$616	\$722	\$888
	½	77	4	10	1	40C177BS	\$552	\$613	\$718	\$883
	½	76	4	10	1	40C176BS	\$549	\$609	\$714	\$878
	½	75	4	10	1	40C175BS	\$545	\$605	\$709	\$872
	½	74	4	10	1	40C174BS	\$542	\$602	\$705	\$867
	½	73	4	10	1	40C173BS	\$539	\$598	\$701	\$862
	½	72	4	10	1	40C172BS	\$536	\$595	\$697	\$858
	½	71	4	10	1	40C171BS	\$465	\$516	\$605	\$744
	½	70	4	9	1	40C170BS	\$462	\$513	\$601	\$739
	½	69	4	9	1	40C169BS	\$460	\$511	\$598	\$736
	½	68	4	9	1	40C168BS	\$457	\$507	\$594	\$731
	½	67	4	9	1	40C167BS	\$454	\$504	\$590	\$726
	½	66	4	9	1	40C166BS	\$452	\$502	\$588	\$723
	½	65	4	9	1	40C165BS	\$449	\$498	\$584	\$718
	½	64	4	9	1	40C164BS	\$447	\$496	\$581	\$715
	½	63	4	9	1	40C163BS	\$445	\$494	\$579	\$712
	½	62	4	8	1	40C162BS	\$442	\$491	\$575	\$707
	½	61	4	8	1	40C161BS	\$440	\$488	\$572	\$704
	½	60	4	8	1	40C160BS	\$438	\$486	\$569	\$701
	½	59	4	8	1	40C159BS	\$435	\$483	\$566	\$696
	½	58	4	8	1	40C158BS	\$433	\$481	\$563	\$693
	½	57	4	8	1	40C157BS	\$430	\$477	\$559	\$688
	½	56	4	8	1	40C156BS	\$428	\$475	\$556	\$685
	½	55	4	8	1	40C155BS	\$425	\$472	\$553	\$680
½	54	4	7	1	40C154BS	\$423	\$470	\$550	\$677	
½	53	4	7	1	40C153BS	\$349	\$387	\$454	\$558	
½	52	4	7	1	40C152BS	\$347	\$385	\$451	\$555	
½	51	4	7	1	40C151BS	\$345	\$383	\$449	\$552	
½	50	4	7	1	40C150BS	\$342	\$380	\$445	\$547	
½	49	4	7	1	40C149BS	\$340	\$377	\$442	\$544	

Specify: Model | Worksurface Solid Surface

Model	Worksurface Solid Surface
	see Forge Solid Surface Finishes

Description	D	W	H	CTN WT	CU FT	① Model	Tier 1	Tier 2	Tier 3	Tier 4
Solid Surface Backsplash (continued)	½	48	4	7	1	40C148BS	\$338	\$375	\$439	\$541
	½	47	4	7	1	40C147BS	\$335	\$372	\$436	\$536
	½	46	4	6	1	40C146BS	\$333	\$370	\$433	\$533
	½	45	4	6	1	40C145BS	\$331	\$367	\$430	\$530
	½	44	4	6	1	40C144BS	\$328	\$364	\$426	\$525
	½	43	4	6	1	40C143BS	\$326	\$362	\$424	\$522
	½	42	4	6	1	40C142BS	\$324	\$360	\$421	\$518
	½	41	4	6	1	40C141BS	\$321	\$356	\$417	\$514
	½	40	4	6	1	40C140BS	\$319	\$354	\$415	\$510
	½	39	4	5	1	40C139BS	\$317	\$352	\$412	\$507
	½	38	4	5	1	40C138BS	\$314	\$349	\$408	\$502
	½	37	4	5	1	40C137BS	\$312	\$346	\$406	\$499
	½	36	4	5	1	40C136BS	\$310	\$344	\$403	\$496
	½	35	4	5	1	40C135BS	\$303	\$336	\$394	\$485
	½	34	4	5	1	40C134BS	\$297	\$330	\$386	\$475
	½	33	4	5	1	40C133BS	\$291	\$323	\$378	\$466
	½	32	4	5	1	40C132BS	\$285	\$316	\$371	\$456
	½	31	4	4	1	40C131BS	\$280	\$311	\$364	\$448
	½	30	4	4	1	40C130BS	\$275	\$305	\$358	\$440
	½	29	4	4	1	40C129BS	\$217	\$241	\$282	\$347
	½	28	4	4	1	40C128BS	\$215	\$239	\$280	\$344
	½	27	4	4	1	40C127BS	\$214	\$238	\$278	\$342
	½	26	4	4	1	40C126BS	\$212	\$235	\$276	\$339
	½	25	4	4	1	40C125BS	\$211	\$234	\$274	\$338
	½	24	4	4	1	40C124BS	\$209	\$232	\$272	\$334
	½	23	4	3	1	40C123BS	\$208	\$231	\$270	\$333
	½	22	4	3	1	40C122BS	\$206	\$229	\$268	\$330
	½	21	4	3	1	40C121BS	\$205	\$228	\$267	\$328
	½	20	4	3	1	40C120BS	\$203	\$225	\$264	\$325
	½	19	4	3	1	40C119BS	\$202	\$224	\$263	\$323
	½	18	4	3	1	40C118BS	\$200	\$222	\$260	\$320
	½	17	4	3	1	40C117BS	\$176	\$195	\$229	\$282
	½	16	4	2	1	40C116BS	\$173	\$192	\$225	\$277
½	15	4	2	1	40C115BS	\$169	\$188	\$220	\$270	
½	14	4	2	1	40C114BS	\$166	\$184	\$216	\$266	
½	13	4	2	1	40C113BS	\$163	\$181	\$212	\$261	
½	12	4	2	1	40C112BS	\$160	\$178	\$208	\$256	

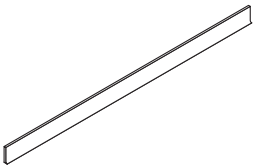

Specify: Model | Worksurface Solid Surface

Model	Worksurface Solid Surface
	see Forge Solid Surface Finishes

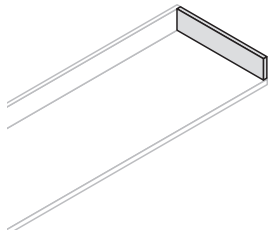
Description	D	W	H	CTN WT	CU FT	① Model	Tier 1	Tier 2	Tier 3	Tier 4	
 <p>Solid Surface Side Splash</p>	Right										
	½	23 ¾	4	3	1	40C123RSSS	\$237	\$263	\$308	\$379	
	½	18 ¾	4	3	1	40C118RSSS	\$200	\$222	\$260	\$320	
	Left										
	½	23 ¾	4	3	1	40C123LSSS	\$237	\$263	\$308	\$379	
	½	18 ¾	4	3	1	40C118LSSS	\$200	\$222	\$260	\$320	
<ul style="list-style-type: none"> • handed <p>Specify: Model Worksurface Solid Surface Side Splash</p>											

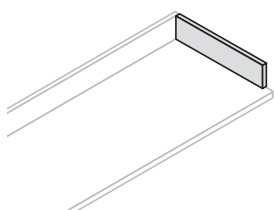
 <p>Solid Surface Side Splash Flush with Storage Cabinets</p>	Right										
	½	22 ½	4	3	1	40C123RSSFS	\$237	\$263	\$308	\$379	
	½	17 ½	4	3	1	40C118RSSFS	\$200	\$222	\$260	\$320	
	Left										
	½	22 ½	4	3	1	40C123LSSFS	\$237	\$263	\$308	\$379	
	½	17 ½	4	3	1	40C118LSSFS	\$200	\$222	\$260	\$320	
<ul style="list-style-type: none"> • handed • aligns flush with storage cabinet chassis <p>Specify: Model Worksurface Solid Surface Side Splash</p>											

Model	Worksurface Solid Surface	Side Splash
	see Forge Solid Surface Finishes	CIBS Compatible with Integrated Backsplash CSBS Compatible with Straight Backsplash

Description	D	W	H	CTN WT	CU FT	① Model	List
Worksurface Waste Ring	6 ¾	6 ¾	2	1	1	GPWSWR	\$369



- use with laminate and solid surface tops
- field cut and installed
- stainless steel finish

Specify: Model

Worksurface Bracket	15	1 ¾	18	3	1	GPWSBRKT18W (White)	\$463
	15	1 ¾	18	3	1	GPWSBRKT18B (Black)	\$463

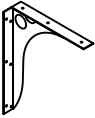

- used with 19½" or 24½"d surfaces
- includes hardware to attach to worksurface
- hardware to attach to wall is not included

Specify: Model

L-Bracket	1	21	1	4	1	GPLBRKT24	\$97
	1	17	1	3	1	GPLBRKT20	\$92

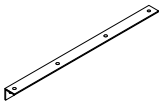

- GPLBRKT24 should be used with 24 ½"d worksurface
- GPLBRKT20 should be used with 19 ½"d worksurface
- attaches to the wall or storage cabinet
- one GPLBRKT20 is required with corner worksurface
- silver finish

Specify: Model

Edge Support	1 ⅙	2	1 ⅙	1	1	GPLBRKT04	\$12
---------------------	-----	---	-----	---	---	-----------	------



- two brackets may be used in place of L-bracket to attach worksurface to storage cabinet
- two brackets are required with base end panel
- one bracket may be used to anchor end panel to the wall
- black finish

Specify: Model

Flat Bracket	2	6		1	1	GPFBRKT	\$17
---------------------	---	---	--	---	---	---------	------



- required for use with corner worksurface
- two brackets are required at each seam
- black finish

Specify: Model

Support Rail	2	43	¾	3	1	GP0243SB	\$80
	2	37	¾	3	1	GP0237SB	\$76

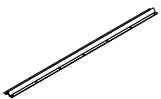

- GP0243SB used where unsupported width span is 43" to 50"
- GP0237SB used for unsupported width span of 37" to 43"
- black finish

Specify: Model

Support Bracket for End Panel	9 ⅙	1	9 ⅙	2	1	GPEPSB	\$96
--------------------------------------	-----	---	-----	---	---	--------	------

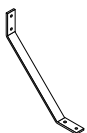

- used to support base end panels that are not attached to the wall
- black finish

Specify: Model

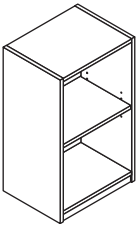
Description	D	W	H	CTN WT	CU FT	① Model	List
Open Upper Cabinet 	13 ¾	36	30	69	12	40C143630UCT	\$785
	13 ¾	30	30	61	10	40C143030UCT	\$708
	13 ¾	24	30	52	8	40C142430UCT	\$632
	13 ¾	21	30	47	7	40C142130UCT	\$556
	13 ¾	18	30	43	6	40C141830UCT	\$480
	13 ¾	15	30	38	5	40C141530UCT	\$420
	13 ¾	12	30	34	5	40C141230UCT	\$365
	13 ¾	36	24	61	9	40C143624UCT	\$722
	13 ¾	30	24	53	8	40C143024UCT	\$655
	13 ¾	24	24	45	7	40C142424UCT	\$595
	13 ¾	21	24	41	6	40C142124UCT	\$535
	13 ¾	18	24	37	5	40C141824UCT	\$475
	13 ¾	15	24	33	4	40C141524UCT	\$415
	13 ¾	12	24	29	4	40C141224UCT	\$355

• one adjustable shelf

Specify: Model | Chassis Laminate

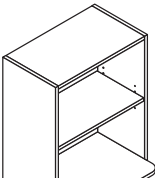
Open Upper Microwave Shelf Cabinet 	17 ¾	36	30	72	12	40C143630UCMT	\$850
	17 ¾	30	30	63	10	40C143030UCMT	\$795
	17 ¾	24	30	54	8	40C142430UCMT	\$740
	17 ¾	36	24	64	9	40C143624UCMT	\$787
	17 ¾	30	24	56	8	40C143024UCMT	\$720
	17 ¾	24	24	47	7	40C142424UCMT	\$660

• one adjustable shelf

Specify: Model | Chassis Laminate

Model	Chassis Laminate
	see Forge Laminate Finishes

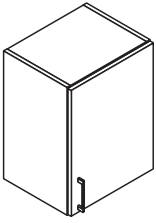
Description	D	W	H	CTN WT	CU FT	Model	List
 <p>right shown</p>	30" h Right Hinged						
	14 ½	24	30	67	8	40C152430UCDRT	\$1,011
	14 ½	21	30	61	7	40C152130UCDRT	\$938
	14 ½	18	30	54	7	40C151830UCDRT	\$865
	14 ½	15	30	48	6	40C151530UCDRT	\$793
	14 ½	12	30	41	5	40C151230UCDRT	\$720
	30" h Left Hinged						
	14 ½	24	30	67	8	40C152430UCDLT	\$1,011
	14 ½	21	30	61	7	40C152130UCDLT	\$938
	14 ½	18	30	54	7	40C151830UCDLT	\$865
	14 ½	15	30	48	6	40C151530UCDLT	\$793
	14 ½	12	30	41	5	40C151230UCDLT	\$720
	24" h Right Hinged						
	14 ½	24	24	57	7	40C152424UCDRT	\$945
	14 ½	21	24	52	6	40C152124UCDRT	\$875
	14 ½	18	24	46	5	40C151824UCDRT	\$805
	14 ½	15	24	40	5	40C151524UCDRT	\$735
	14 ½	12	24	35	4	40C151224UCDRT	\$665
	24" h Left Hinged						
	14 ½	24	24	57	7	40C152424UCDLT	\$945
14 ½	21	24	52	6	40C152124UCDLT	\$875	
14 ½	18	24	46	5	40C151824UCDLT	\$805	
14 ½	15	24	40	5	40C151524UCDLT	\$735	
14 ½	12	24	35	4	40C151224UCDLT	\$665	

• one adjustable shelf

Specify: Model | Chassis Laminate | Door Laminate | Pull | Lock

Model	Chassis Laminate	Door Laminate	Pull	Lock
	see Forge Laminate Finishes	see Forge Laminate Finishes	P001 Bar see Bar Pull Color P005 Delve see Delve Pull Color P011 Prospect see Prospect Pull Color P003 Sweep see Sweep Pull Color	NLK No Lock KLK Standard - add \$78 ASL Arctic Silver MBK Matte Black DLK Keyless Lock - add \$232

Description	D	W	H	CTN WT	CU FT	Model	List
Upper Door Cabinet with Glove Box	14 ½	24	30	67	8	40C152430UCDGBT	\$1,105
	14 ½	21	30	61	7	40C152130UCDGBT	\$1,070
	14 ½	18	30	54	7	40C151830UCDGBT	\$1,035
	14 ½	24	24	57	7	40C152424UCDGBT	\$1,000
	14 ½	21	24	52	6	40C152124UCDGBT	\$965
	14 ½	18	24	46	5	40C151824UCDGBT	\$930

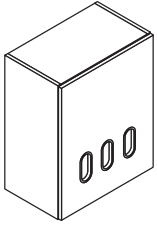

- one fixed shelf
- metal glove box holder is included
- zinc oval glove grommet size 6 ½" x 3" x 13/16"
- 24" & 21"w units have 3 glove box openings
- 18"w units have 2 glove box openings

Specify: Model | Chassis Laminate | Door Laminate | Lock | Waste Grommet Color

Model	Chassis Laminate	Door Laminate	Lock	Waste Grommet Color
	see Forge Laminate Finishes	see Forge Laminate Finishes	NLK No Lock KLK Standard - add \$78 ASL Arctic Silver MBK Matte Black	MBK Matte Black SNK Soft Nickel

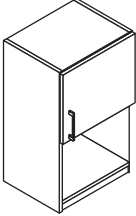
Description	D	W	H	CTN WT	CU FT	① Model	List
Upper Door with Open Shelf Cabinet  right shown	Right Hinged						
	14 ½	24	30	59	8	40C152430UCHDRT	\$855
	14 ½	21	30	54	7	40C152130UCHDRT	\$790
	14 ½	18	30	48	7	40C151830UCHDRT	\$725
	14 ½	15	30	43	6	40C151530UCHDRT	\$660
	14 ½	12	30	37	5	40C151230UCHDRT	\$595
	Left Hinged						
	14 ½	24	30	59	8	40C152430UCHDLT	\$855
	14 ½	21	30	54	7	40C152130UCHDLT	\$790
	14 ½	18	30	48	7	40C151830UCHDLT	\$725
	14 ½	15	30	43	6	40C151530UCHDLT	\$660
14 ½	12	30	37	5	40C151230UCHDLT	\$595	

- one adjustable shelf

Specify: Model | Chassis Laminate | Door Laminate | Pull | Lock

Model	Chassis Laminate	Door Laminate	Pull	Lock
	see Forge Laminate Finishes	see Forge Laminate Finishes	P001 Bar see Bar Pull Color P005 Delve see Delve Pull Color P011 Prospect see Prospect Pull Color P003 Sweep see Sweep Pull Color	NLK No Lock KLK Standard - add \$78 ASL Arctic Silver MBK Matte Black DLK Keyless Lock - add \$232

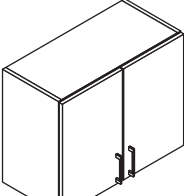
Description	D	W	H	CTN WT	CU FT	① Model	List
	14 ½	36	30	92	12	40C153630UCDT	\$1,280
	14 ½	30	30	80	10	40C153030UCDT	\$1,180
	14 ½	24	30	67	8	40C152430UCDT	\$1,080
	14 ½	36	24	80	10	40C153624UCDT	\$1,175
	14 ½	30	24	69	8	40C153024UCDT	\$1,075
	14 ½	24	24	57	7	40C152424UCDT	\$975

• one adjustable shelf

Specify: Model | Chassis Laminate | Door Laminate | Pull | Lock

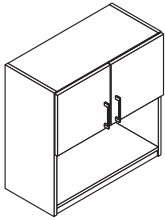
	14 ½	36	30	81	12	40C153630UCHDHT	\$1,070
	14 ½	30	30	70	10	40C153030UCHDHT	\$980
	14 ½	24	30	59	8	40C152430UCHDHT	\$890

• one adjustable shelf

Specify: Model | Chassis Laminate | Door Laminate | Pull | Lock

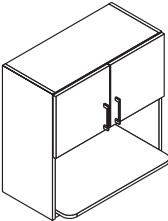
	17 ¾	36	30	84	12	40C153630UCHDMT	\$1,141
	17 ¾	30	30	72	10	40C153030UCHDMT	\$1,060
	17 ¾	24	30	61	8	40C152430UCHDMT	\$980

Specify: Model | Chassis Laminate | Door Laminate | Pull | Lock

Model	Chassis Laminate	Door Laminate	Pull	Lock
	see Forge Laminate Finishes	see Forge Laminate Finishes	P001 Bar see Bar Pull Color P005 Delve see Delve Pull Color P011 Prospect see Prospect Pull Color P003 Sweep see Sweep Pull Color	NLK No Lock KLK Standard - add \$78 ASL Arctic Silver MBK Matte Black DLK Keyless Lock - add \$256

Description	D	W	H	CTN WT	CU FT	Model	List
Upper Filler	13 ¾	6	30	4	3	40C14630UFT	\$191
	13 ¾	6	24	4	2	40C14624UFT	\$145

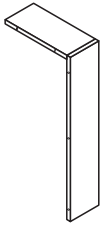

- includes brackets to attach to cabinet
- may be field scribed as needed

Specify: Model | Chassis Laminate

Model	Chassis Laminate
	see Forge Laminate Finishes

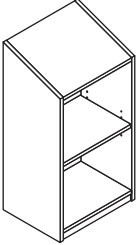
Description	D	W	H	CTN WT	CU FT	① Model	List
Sloped Top Open Upper Cabinet 	13 ¾	36	35	72	13	40C143635UCST	\$865
	13 ¾	30	35	63	11	40C143035UCST	\$792
	13 ¾	24	35	53	9	40C142435UCST	\$722
	13 ¾	21	35	49	8	40C142135UCST	\$652
	13 ¾	18	35	44	7	40C141835UCST	\$582
	13 ¾	15	35	40	6	40C141535UCST	\$512
	13 ¾	12	35	35	5	40C141235UCST	\$442
	13 ¾	36	29	64	11	40C143629UCST	\$795
	13 ¾	30	29	55	9	40C143029UCST	\$722
	13 ¾	24	29	47	8	40C142429UCST	\$649
	13 ¾	21	29	43	7	40C142129UCST	\$576
	13 ¾	18	29	39	6	40C141829UCST	\$503
	13 ¾	15	29	35	5	40C141529UCST	\$430
	13 ¾	12	29	30	4	40C141229UCST	\$370

• one adjustable shelf

Specify: Model | Chassis Laminate

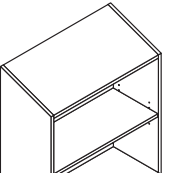
Sloped Top Open Upper Microwave Shelf Cabinet 	17 ¾	36	35	13	75	40C143635UCSMT	\$1,081
	17 ¾	30	35	11	65	40C143035UCSMT	\$1,008
	17 ¾	24	35	9	55	40C142435UCSMT	\$938
	17 ¾	36	29	11	67	40C143629UCSMT	\$865
	17 ¾	30	29	9	58	40C143029UCSMT	\$792
	17 ¾	24	29	8	49	40C142429UCSMT	\$719

• one adjustable shelf

Specify: Model | Chassis Laminate

Model	Chassis Laminate
	see Forge Laminate Finishes

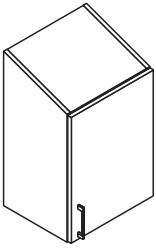
Description	D	W	H	CTN WT	CU FT	Model	List
 <p>right shown</p>	35" h Right Hinged						
	14 ½	24	35	69	10	40C152435UCDSRT	\$1,086
	14 ½	21	35	62	9	40C152135UCDSRT	\$1,013
	14 ½	18	35	56	8	40C151835UCDSRT	\$940
	14 ½	15	35	49	6	40C151535UCDSRT	\$867
	14 ½	12	35	43	5	40C151235UCDSRT	\$794
	35" h Left Hinged						
	14 ½	24	35	69	10	40C152435UCDSL	\$1,086
	14 ½	21	35	62	9	40C152135UCDSL	\$1,013
	14 ½	18	35	56	8	40C151835UCDSL	\$940
	14 ½	15	35	49	6	40C151535UCDSL	\$867
	14 ½	12	35	43	5	40C151235UCDSL	\$794
	29" h Right Hinged						
	14 ½	24	29	59	8	40C152429UCDSRT	\$1,014
	14 ½	21	29	54	7	40C152129UCDSRT	\$941
	14 ½	18	29	48	6	40C151829UCDSRT	\$868
	14 ½	15	29	42	5	40C151529UCDSRT	\$795
	14 ½	12	29	36	5	40C151229UCDSRT	\$722
	29" h Left Hinged						
	14 ½	24	29	59	8	40C152429UCDSL	\$1,014
14 ½	21	29	54	7	40C152129UCDSL	\$941	
14 ½	18	29	48	6	40C151829UCDSL	\$868	
14 ½	15	29	42	5	40C151529UCDSL	\$795	
14 ½	12	29	36	5	40C151229UCDSL	\$722	

• one adjustable shelf

Specify: Model | Chassis Laminate | Door Laminate | Pull | Lock

Model	Chassis Laminate	Door Laminate	Pull	Lock
	see Forge Laminate Finishes	see Forge Laminate Finishes	P001 Bar see Bar Pull Color P005 Delve see Delve Pull Color P011 Prospect see Prospect Pull Color P003 Sweep see Sweep Pull Color	NLK No Lock KLK Standard - add \$78 ASL Arctic Silver MBK Matte Black DLK Keyless Lock - add \$232

Description	D	W	H	CTN WT	CU FT	Model	List
Sloped Top Upper Door Cabinet with Glove Box	14 ½	24	35	69	10	40C152435UCDGBST	\$1,240
	14 ½	21	35	62	9	40C152135UCDGBST	\$1,185
	14 ½	18	35	56	8	40C151835UCDGBST	\$1,130
	14 ½	24	29	59	8	40C152429UCDGBST	\$1,105
	14 ½	21	29	54	7	40C152129UCDGBST	\$1,070
	14 ½	18	29	54	7	40C151829UCDGBST	\$1,035

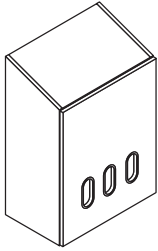

- one fixed shelf
- metal glove box holder is included
- zinc oval glove grommet size 6 ½" x 3" x 13/16"
- 24" & 21"w units have 3 glove box openings
- 18"w units have 2 glove box openings

Specify: Model | Chassis Laminate | Door Laminate | Lock | Waste Grommet Color

Model	Chassis Laminate	Door Laminate	Lock	Waste Grommet Color
	see Forge Laminate Finishes	see Forge Laminate Finishes	NLK No Lock KLK Standard - add \$78 ASL Arctic Silver MBK Matte Black	MBK Matte Black SNK Soft Nickel

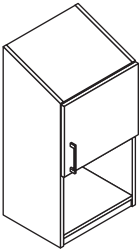
Description	D	W	H	CTN WT	CU FT	Model	List
Sloped Top Upper Door with Open Shelf Cabinet  right shown	Right Hinged						
	14 ½	24	35	61	10	40C152435UCHDSRT	\$990
	14 ½	21	35	56	9	40C152135UCHDSRT	\$900
	14 ½	18	35	50	8	40C151835UCHDSRT	\$810
	14 ½	15	35	45	6	40C151535UCHDSRT	\$730
	14 ½	12	35	39	5	40C151235UCHDSRT	\$640
	Left Hinged						
	14 ½	24	35	61	10	40C152435UCHDSL	\$990
	14 ½	21	35	56	9	40C152135UCHDSL	\$900
	14 ½	18	35	50	8	40C151835UCHDSL	\$810
14 ½	15	35	45	6	40C151535UCHDSL	\$730	
14 ½	12	35	39	5	40C151235UCHDSL	\$640	

• one adjustable shelf

Specify: Model | Chassis Laminate | Door Laminate | Pull | Lock

Model	Chassis Laminate	Door Laminate	Pull	Lock
	see Forge Laminate Finishes	see Forge Laminate Finishes	P001 Bar see Bar Pull Color P005 Delve see Delve Pull Color P011 Prospect see Prospect Pull Color P003 Sweep see Sweep Pull Color	NLK No Lock KLK Standard - add \$78 ASL Arctic Silver MBK Matte Black DLK Keyless Lock - add \$232

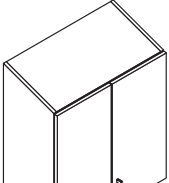
Description	D	W	H	CTN WT	CU FT	Model	List
Sloped Top Two Door Upper Cabinet 	14 ½	36	35	95	14	40C153635UCDST	\$1,380
	14 ½	30	35	82	12	40C153035UCDST	\$1,280
	14 ½	24	35	69	10	40C152435UCDST	\$1,175
	14 ½	36	29	82	12	40C153629UCDST	\$1,275
	14 ½	30	29	71	10	40C153029UCDST	\$1,170
	14 ½	24	29	59	8	40C152429UCDST	\$1,065

• one adjustable shelf

Specify: Model | Chassis Laminate | Door Laminate | Pull | Lock

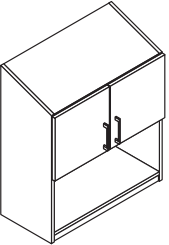
Sloped Top Two Doors with Open Shelf Cabinet 	14 ½	36	35	83	14	40C153635UCHDST	\$1,233
	14 ½	30	35	72	12	40C153035UCHDST	\$1,005
	14 ½	24	35	61	10	40C152435UCHDST	\$925

• one adjustable shelf

Specify: Model | Chassis Laminate | Door Laminate | Pull | Lock

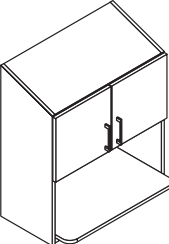
Sloped Top Two Doors with Microwave Shelf Cabinet 	18 ½	36	35	86	14	40C153635UCHDSMT	\$1,305
	18 ½	30	35	74	12	40C153035UCHDSMT	\$1,140
	18 ½	24	35	63	10	40C152435UCHDSMT	\$1,105

Specify: Model | Chassis Laminate | Door Laminate | Pull | Lock

Model	Chassis Laminate	Door Laminate	Pull	Lock
	see Forge Laminate Finishes	see Forge Laminate Finishes	P001 Bar see Bar Pull Color P005 Delve see Delve Pull Color P011 Prospect see Prospect Pull Color P003 Sweep see Sweep Pull Color	NLK No Lock KLK Standard - add \$78 ASL Arctic Silver MBK Matte Black DLK Keyless Lock - add \$256

Description	D	W	H	CTN WT	CU FT	Model	List
Sloped Top Upper Filler	13 ¾	6	35	6	3	40C14635UFST	\$202
	13 ¾	6	29	5	3	40C14629UFST	\$191

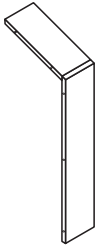

- includes brackets to attach to cabinet
- may be field scribed as needed

Specify: Model | Chassis Laminate

Model	Chassis Laminate
	see Forge Laminate Finishes

24"d Models

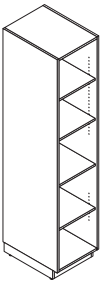
Description	D	W	H	CTN WT	CU FT	① Model	List
 <p>1 fixed & 3 adjustable shelves shown</p>	23 ½	36	84	246	49	40C243684SCOT	\$2,495
	23 ½	30	84	218	41	40C243084SCOT	\$2,350
	23 ½	24	84	190	33	40C242484SCOT	\$2,200
	23 ½	21	84	176	30	40C242184SCOT	\$2,050
	23 ½	18	84	162	26	40C241884SCOT	\$1,895
	23 ½	15	84	148	22	40C241584SCOT	\$1,745
	23 ½	12	84	134	18	40C241284SCOT	\$1,595
	23 ½	36	78	236	45	40C243678SCOT	\$2,210
	23 ½	30	78	209	38	40C243078SCOT	\$2,095
	23 ½	24	78	182	31	40C242478SCOT	\$1,980
	23 ½	21	78	168	28	40C242178SCOT	\$1,863
	23 ½	18	78	155	24	40C241878SCOT	\$1,748
	23 ½	15	78	141	21	40C241578SCOT	\$1,633
	23 ½	12	78	127	17	40C241278SCOT	\$1,518

Specify: Model | Chassis Laminate | Interior Configuration

19"d Models

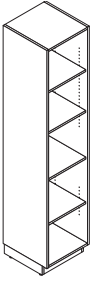
Description	D	W	H	CTN WT	CU FT	① Model	List
 <p>1 fixed & 3 adjustable shelves shown</p>	18 ½	36	84	229	39	40C193684SCOT	\$2,258
	18 ½	30	84	201	33	40C193084SCOT	\$2,110
	18 ½	24	84	173	27	40C192484SCOT	\$1,965
	18 ½	21	84	159	24	40C192184SCOT	\$1,820
	18 ½	18	84	145	21	40C191884SCOT	\$1,675
	18 ½	15	84	131	18	40C191584SCOT	\$1,525
	18 ½	12	84	116	15	40C191284SCOT	\$1,375
	18 ½	36	78	220	37	40C193678SCOT	\$1,970
	18 ½	30	78	193	31	40C193078SCOT	\$1,855
	18 ½	24	78	166	25	40C192478SCOT	\$1,740
	18 ½	21	78	152	22	40C192178SCOT	\$1,695
	18 ½	18	78	139	19	40C191878SCOT	\$1,580
	18 ½	15	78	125	17	40C191578SCOT	\$1,465
	18 ½	12	78	111	14	40C191278SCOT	\$1,350

Specify: Model | Chassis Laminate | Interior Configuration

Model	Chassis Laminate	Interior Configuration
	see Forge Laminate Finishes	CH Coat Hook CR2FS Coat Rod & 2 Fixed Shelves - add \$42 1F3AS 1 Fixed & 3 Adjustable Shelves - add \$150

24"d Models

Description	D	W	H	CTN WT	CU FT	Model	List
 right shown	84"h Right Hinged						
	24 ¼	24	84	231	33	40C242484SCDRT	\$2,510
	24 ¼	21	84	212	30	40C242184SCDRT	\$2,365
	24 ¼	18	84	193	26	40C241884SCDRT	\$2,217
	24 ¼	15	84	174	22	40C241584SCDRT	\$2,010
	24 ¼	12	84	154	18	40C241284SCDRT	\$1,860
	84"h Left Hinged						
	24 ¼	24	84	231	33	40C242484SCDLT	\$2,510
	24 ¼	21	84	212	30	40C242184SCDLT	\$2,365
	24 ¼	18	84	193	26	40C241884SCDLT	\$2,217
	24 ¼	15	84	174	22	40C241584SCDLT	\$2,010
	24 ¼	12	84	154	18	40C241284SCDLT	\$1,860
	78"h Right Hinged						
	24 ¼	24	78	220	31	40C242478SCDRT	\$2,229
	24 ¼	21	78	202	28	40C242178SCDRT	\$2,134
	24 ¼	18	78	183	24	40C241878SCDRT	\$2,039
	24 ¼	15	78	165	21	40C241578SCDRT	\$1,924
	24 ¼	12	78	146	17	40C241278SCDRT	\$1,810
	78"h Left Hinged						
	24 ¼	24	78	220	31	40C242478SCDLT	\$2,229
24 ¼	21	78	202	28	40C242178SCDLT	\$2,134	
24 ¼	18	78	183	24	40C241878SCDLT	\$2,039	
24 ¼	15	78	165	21	40C241578SCDLT	\$1,924	
24 ¼	12	78	146	17	40C241278SCDLT	\$1,810	

Specify: Model | Chassis Laminate | Door Laminate | Interior Configuration | Pull | Lock

Model	Chassis Laminate	Door Laminate	Interior Configuration	Pull	Lock
	see Forge Laminate Finishes	see Forge Laminate Finishes	CH Coat Hook CR2FS Coat Rod & 2 Fixed Shelves - add \$42 1F3AS 1 Fixed & 3 Adjustable Shelves - add \$150	P001 Bar see Bar Pull Color P005 Delve see Delve Pull Color P011 Prospect see Prospect Pull Color P003 Sweep see Sweep Pull Color	NLK No Lock KLK Standard - add \$78 ASL Arctic Silver MBK Matte Black DLK Keyless Lock - add \$232

19"d Models

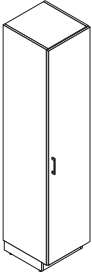
Description	D	W	H	CTN WT	CU FT	Model	List
 <p>Storage Cabinet</p> <p>right shown</p>	84"h Right Hinged						
	19 ¼	24	84	214	27	40C192484SCDRT	\$2,270
	19 ¼	21	84	195	24	40C192184SCDRT	\$2,055
	19 ¼	18	84	176	21	40C191884SCDRT	\$1,940
	19 ¼	15	84	156	18	40C191584SCDRT	\$1,805
	19 ¼	12	84	137	15	40C191284SCDRT	\$1,700
	84"h Left Hinged						
	19 ¼	24	84	214	27	40C192484SCDLT	\$2,270
	19 ¼	21	84	195	24	40C192184SCDLT	\$2,055
	19 ¼	18	84	176	21	40C191884SCDLT	\$1,940
	19 ¼	15	84	156	18	40C191584SCDLT	\$1,805
	19 ¼	12	84	137	15	40C191284SCDLT	\$1,700
	78"h Right Hinged						
	19 ¼	24	78	204	25	40C192478SCDRT	\$1,995
	19 ¼	21	78	186	22	40C192178SCDRT	\$1,880
	19 ¼	18	78	167	19	40C191878SCDRT	\$1,775
	19 ¼	15	78	149	17	40C191578SCDRT	\$1,695
	19 ¼	12	78	130	14	40C191278SCDRT	\$1,609
	78"h Left Hinged						
	19 ¼	24	78	204	25	40C192478SCDLT	\$1,995
19 ¼	21	78	186	22	40C192178SCDLT	\$1,880	
19 ¼	18	78	167	19	40C191878SCDLT	\$1,775	
19 ¼	15	78	149	17	40C191578SCDLT	\$1,695	
19 ¼	12	78	130	14	40C191278SCDLT	\$1,609	

Specify: Model | Chassis Laminate | Door Laminate | Interior Configuration | Pull | Lock

Model	Chassis Laminate	Door Laminate	Interior Configuration	Pull	Lock
	see Forge Laminate Finishes	see Forge Laminate Finishes	CH Coat Hook CR2FS Coat Rod & 2 Fixed Shelves - add \$42 1F3AS 1 Fixed & 3 Adjustable Shelves - add \$150	P001 Bar see Bar Pull Color P005 Delve see Delve Pull Color P011 Prospect see Prospect Pull Color P003 Sweep see Sweep Pull Color	NLK No Lock KLK Standard - add \$78 ASL Arctic Silver MBK Matte Black DLK Keyless Lock - add \$232

24"d Models

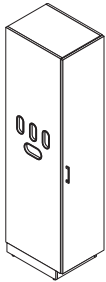
Description	D	W	H	CTN WT	CU FT	Model	List
Storage Cabinet with Glove Box  right shown	84"h Right Hinged						
	24 ¼	24	84	231	33	40C242484SCDGBRT	\$2,750
	24 ¼	21	84	212	30	40C242184SCDGBRT	\$2,605
	24 ¼	18	84	193	26	40C241884SCDGBRT	\$2,457
	24 ¼	15	84	174	22	40C241584SCDGBRT	\$2,312
	24 ¼	12	84	154	18	40C241284SCDGBRT	\$2,167
	84"h Left Hinged						
	24 ¼	24	84	231	33	40C242484SCDGBLT	\$2,750
	24 ¼	21	84	212	30	40C242184SCDGBLT	\$2,605
	24 ¼	18	84	193	26	40C241884SCDGBLT	\$2,457
24 ¼	15	84	174	22	40C241584SCDGBLT	\$2,312	
24 ¼	12	84	154	18	40C241284SCDGBLT	\$2,167	
78"h Right Hinged							
24 ¼	24	78	220	31	40C242478SCDGBRT	\$2,509	
24 ¼	21	78	202	28	40C242178SCDGBRT	\$2,394	
24 ¼	18	78	183	24	40C241878SCDGBRT	\$2,279	
24 ¼	15	78	165	21	40C241578SCDGBRT	\$2,164	
24 ¼	12	78	146	17	40C241278SCDGBRT	\$2,050	
78"h Left Hinged							
24 ¼	24	78	220	31	40C242478SCDGBLT	\$2,509	
24 ¼	21	78	202	28	40C242178SCDGBLT	\$2,394	
24 ¼	18	78	183	24	40C241878SCDGBLT	\$2,279	
24 ¼	15	78	165	21	40C241578SCDGBLT	\$2,164	
24 ¼	12	78	146	17	40C241278SCDGBLT	\$2,050	

- metal glove box holder is included
- glove grommet size 6 ½" x 3" x 13/16" - zinc oval grommet
- waste grommet size 7 ½" x 4" x 13/16" - zinc oval grommet

Specify: Model | Chassis Laminate | Door Laminate | Pull | Lock | Waste Grommet Color

Model	Chassis Laminate	Door Laminate	Pull	Lock	Waste Grommet Color
	see Forge Laminate Finishes	see Forge Laminate Finishes	P001 Bar see Bar Pull Color P005 Delve see Delve Pull Color P011 Prospect see Prospect Pull Color P003 Sweep see Sweep Pull Color	NLK No Lock KLK Standard - add \$78 ASL Arctic Silver MBK Matte Black DLK Keyless Lock - add \$232	MBK Matte Black SNK Soft Nickel

19" d Models

Description	D	W	H	CTN WT	CU FT	Model	List
Storage Cabinet with Glove Box  right shown	84" h Right Hinged						
	19 ¼	24	84	214	27	40C192484SCDGBRT	\$2,495
	19 ¼	21	84	195	24	40C192184SCDGBRT	\$2,362
	19 ¼	18	84	176	21	40C191884SCDGBRT	\$2,195
	19 ¼	15	84	156	18	40C191584SCDGBRT	\$2,058
	19 ¼	12	84	137	15	40C191284SCDGBRT	\$1,943
	84" h Left Hinged						
	19 ¼	24	84	214	27	40C192484SCDGBLT	\$2,495
	19 ¼	21	84	195	24	40C192184SCDGBLT	\$2,362
	19 ¼	18	84	176	21	40C191884SCDGBLT	\$2,195
19 ¼	15	84	156	18	40C191584SCDGBLT	\$2,058	
19 ¼	12	84	137	15	40C191284SCDGBLT	\$1,943	
78" h Right Hinged							
19 ¼	24	78	204	25	40C192478SCDGBRT	\$2,285	
19 ¼	21	78	186	22	40C192178SCDGBRT	\$2,170	
19 ¼	18	78	167	19	40C191878SCDGBRT	\$2,055	
19 ¼	15	78	149	17	40C191578SCDGBRT	\$1,940	
19 ¼	12	78	130	14	40C191278SCDGBRT	\$1,850	
78" h Left Hinged							
19 ¼	24	78	204	25	40C192478SCDGBLT	\$2,285	
19 ¼	21	78	186	22	40C192178SCDGBLT	\$2,170	
19 ¼	18	78	167	19	40C191878SCDGBLT	\$2,055	
19 ¼	15	78	149	17	40C191578SCDGBLT	\$1,940	
19 ¼	12	78	130	14	40C191278SCDGBLT	\$1,850	

• metal glove box holder is included

Specify: Model | Chassis Laminate | Door Laminate | Pull | Lock | Waste Grommet Color

Model	Chassis Laminate	Door Laminate	Pull	Lock	Waste Grommet Color
	see Forge Laminate Finishes	see Forge Laminate Finishes	P001 Bar see Bar Pull Color P005 Delve see Delve Pull Color P011 Prospect see Prospect Pull Color P003 Sweep see Sweep Pull Color	NLK No Lock KLK Standard - add \$78 ASL Arctic Silver MBK Matte Black DLK Keyless Lock - add \$232	MBK Matte Black SNK Soft Nickel

24"d Models

Description	D	W	H	CTN WT	CU FT	① Model	List
Storage Cabinet with Doors	24 ¼	36	84	308	49	40C243684SCDT	\$3,160
	24 ¼	30	84	270	41	40C243084SCDT	\$3,025
	24 ¼	36	78	294	45	40C243678SCDT	\$2,885
	24 ¼	30	78	257	38	40C243078SCDT	\$2,750

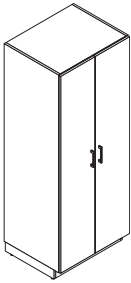

Specify: Model | Chassis Laminate | Door Laminate | Interior Configuration | Pull | Lock

19"d Models

Description	D	W	H	CTN WT	CU FT	① Model	List
Storage Cabinet with Doors	19 ¼	36	84	291	39	40C193684SCDT	\$2,920
	19 ¼	30	84	252	33	40C193084SCDT	\$2,785
	19 ¼	36	78	278	37	40C193678SCDT	\$2,705
	19 ¼	30	78	241	31	40C193078SCDT	\$2,570

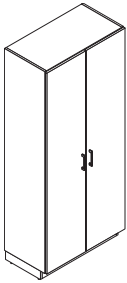

Specify: Model | Chassis Laminate | Door Laminate | Interior Configuration | Pull | Lock

Model	Chassis Laminate	Door Laminate	Interior Configuration	Pull	Lock
	see Forge Laminate Finishes	see Forge Laminate Finishes	CH Coat Hook CR2FS Coat Rod & 2 Fixed Shelves - add \$42 1F3AS 1 Fixed & 3 Adjustable Shelves - add \$150	P001 Bar see Bar Pull Color P005 Delve see Delve Pull Color P011 Prospect see Prospect Pull Color P003 Sweep see Sweep Pull Color	NLK No Lock KLK Standard - add \$102 ASL Arctic Silver MBK Matte Black DLK Keyless Lock - add \$256

24"d Models

Description	D	W	H	CTN WT	CU FT	① Model	List
Storage Filler	23 ½	6	84	0	0	40C24684SFT	\$335
	23 ½	6	78	0	0	40C24678SFT	\$320

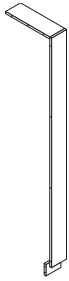

- includes brackets to attach to cabinet
- may be field scribed as needed

Specify: Model | Chassis Laminate

19"d Models

Description	D	W	H	CTN WT	CU FT	① Model	List
Storage Filler	19 ¼	6	84	7	9	40C19684SFT	\$322
	19 ¼	6	78	7	8	40C19678SFT	\$305

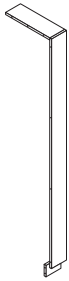

- includes brackets to attach to cabinet
- may be field scribed as needed

Specify: Model | Chassis Laminate

Model	Chassis Laminate
	see Forge Laminate Finishes

24"d Models

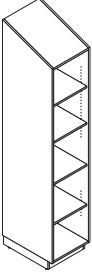
Description	D	W	H	CTN WT	CU FT	Model	List
 <p>1 fixed & 3 adjustable shelves shown</p>	23 ½	36	92 ½	258	53	40C243693SCSOT	\$2,550
	23 ½	30	92 ½	229	45	40C243093SCSOT	\$2,400
	23 ½	24	92 ½	199	37	40C242493SCSOT	\$2,250
	23 ½	21	92 ½	185	33	40C242193SCSOT	\$2,110
	23 ½	18	92 ½	170	28	40C241893SCSOT	\$1,960
	23 ½	15	92 ½	155	24	40C241593SCSOT	\$1,810
	23 ½	12	92 ½	140	20	40C241293SCSOT	\$1,660
	23 ½	36	86 ½	247	50	40C243687SCSOT	\$2,255
	23 ½	30	86 ½	219	42	40C243087SCSOT	\$2,140
	23 ½	24	86 ½	190	34	40C242487SCSOT	\$2,025
	23 ½	21	86 ½	176	30	40C242187SCSOT	\$1,910
	23 ½	18	86 ½	162	27	40C241887SCSOT	\$1,795
	23 ½	15	86 ½	147	23	40C241587SCSOT	\$1,680
	23 ½	12	86 ½	133	19	40C241287SCSOT	\$1,565

Specify: Model | Chassis Laminate | Interior Configuration

19"d Models

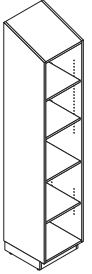
Description	D	W	H	CTN WT	CU FT	Model	List
 <p>1 fixed & 3 adjustable shelves shown</p>	18 ½	36	90 ¾	236	43	40C193691SCSOT	\$2,345
	18 ½	30	90 ¾	207	36	40C193091SCSOT	\$2,240
	18 ½	24	90 ¾	177	30	40C192491SCSOT	\$2,090
	18 ½	21	90 ¾	163	26	40C192191SCSOT	\$1,900
	18 ½	18	90 ¾	148	23	40C191891SCSOT	\$1,800
	18 ½	15	90 ¾	134	20	40C191591SCSOT	\$1,650
	18 ½	12	90 ¾	119	16	40C191291SCSOT	\$1,500
	18 ½	36	84 ¾	228	40	40C193685SCSOT	\$2,070
	18 ½	30	84 ¾	199	34	40C193085SCSOT	\$1,955
	18 ½	24	84 ¾	170	28	40C192485SCSOT	\$1,840
	18 ½	21	84 ¾	156	25	40C192185SCSOT	\$1,725
	18 ½	18	84 ¾	142	21	40C191885SCSOT	\$1,610
	18 ½	15	84 ¾	128	18	40C191585SCSOT	\$1,495
	18 ½	12	84 ¾	113	15	40C191285SCSOT	\$1,425

Specify: Model | Chassis Laminate | Interior Configuration

Model	Chassis Laminate	Interior Configuration
	see Forge Laminate Finishes	CH Coat Hook CR2FS Coat Rod & 2 Fixed Shelves - add \$42 1F3AS 1 Fixed & 3 Adjustable Shelves - add \$150

24"d Models

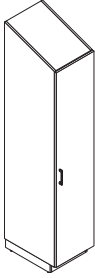
Description	D	W	H	CTN WT	CU FT	Model	List
 <p>right shown</p>	92 ½" h Right Hinged						
	24 ¼	24	92 ½	240	37	40C242493SCDSRT	\$2,540
	24 ¼	21	92 ½	221	33	40C242193SCDSRT	\$2,388
	24 ¼	18	92 ½	201	28	40C241893SCDSRT	\$2,244
	24 ¼	15	92 ½	181	24	40C241593SCDSRT	\$2,105
	24 ¼	12	92 ½	161	20	40C241293SCDSRT	\$1,961
	92 ½" h Left Hinged						
	24 ¼	24	92 ½	240	37	40C242493SCDSL	\$2,540
	24 ¼	21	92 ½	221	33	40C242193SCDSL	\$2,388
	24 ¼	18	92 ½	201	28	40C241893SCDSL	\$2,244
	24 ¼	15	92 ½	181	24	40C241593SCDSL	\$2,105
	24 ¼	12	92 ½	161	20	40C241293SCDSL	\$1,961
	86 ½" h Right Hinged						
	24 ¼	24	86 ½	228	34	40C242487SCDSRT	\$2,250
	24 ¼	21	86 ½	209	30	40C242187SCDSRT	\$2,140
	24 ¼	18	86 ½	190	27	40C241887SCDSRT	\$2,120
	24 ¼	15	86 ½	171	23	40C241587SCDSRT	\$2,010
	24 ¼	12	86 ½	152	19	40C241287SCDSRT	\$1,810
86 ½" h Left Hinged							
24 ¼	24	86 ½	228	34	40C242487SCDSL	\$2,250	
24 ¼	21	86 ½	209	30	40C242187SCDSL	\$2,140	
24 ¼	18	86 ½	190	27	40C241887SCDSL	\$2,120	
24 ¼	15	86 ½	171	23	40C241587SCDSL	\$2,010	
24 ¼	12	86 ½	152	19	40C241287SCDSL	\$1,810	

Specify: Model | Chassis Laminate | Door Laminate | Interior Configuration | Pull | Lock

Model	Chassis Laminate	Door Laminate	Interior Configuration	Pull	Lock
	see Forge Laminate Finishes	see Forge Laminate Finishes	CH Coat Hook CR2FS Coat Rod & 2 Fixed Shelves - add \$42 1F3AS 1 Fixed & 3 Adjustable Shelves - add \$150	P001 Bar see Bar Pull Color P005 Delve see Delve Pull Color P011 Prospect see Prospect Pull Color P003 Sweep see Sweep Pull Color	NLK No Lock KLK Standard - add \$78 ASL Arctic Silver MBK Matte Black DLK Keyless Lock - add \$232

19"d Models

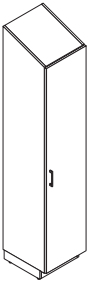
Description	D	W	H	CTN WT	CU FT	Model	List
 <p>right shown</p>	90 3/4" h Right Hinged						
	19 1/4	24	90 3/4	218	30	40C192491SCDSRT	\$2,330
	19 1/4	21	90 3/4	199	26	40C192191SCDSRT	\$2,228
	19 1/4	18	90 3/4	179	23	40C191891SCDSRT	\$2,084
	19 1/4	15	90 3/4	159	20	40C191591SCDSRT	\$1,890
	19 1/4	12	90 3/4	139	16	40C191291SCDSRT	\$1,796
	90 3/4" h Left Hinged						
	19 1/4	24	90 3/4	218	30	40C192491SCDSL	\$2,330
	19 1/4	21	90 3/4	199	26	40C192191SCDSL	\$2,228
	19 1/4	18	90 3/4	179	23	40C191891SCDSL	\$2,084
19 1/4	15	90 3/4	159	20	40C191591SCDSL	\$1,890	
19 1/4	12	90 3/4	139	16	40C191291SCDSL	\$1,796	
84 3/4" h Right Hinged							
19 1/4	24	84 3/4	208	28	40C192485SCDSRT	\$2,040	
19 1/4	21	84 3/4	190	25	40C192185SCDSRT	\$1,945	
19 1/4	18	84 3/4	170	21	40C191885SCDSRT	\$1,835	
19 1/4	15	84 3/4	152	18	40C191585SCDSRT	\$1,740	
19 1/4	12	84 3/4	132	15	40C191285SCDSRT	\$1,650	
84 3/4" h Left Hinged							
19 1/4	24	84 3/4	208	28	40C192485SCDSL	\$2,040	
19 1/4	21	84 3/4	190	25	40C192185SCDSL	\$1,945	
19 1/4	18	84 3/4	170	21	40C191885SCDSL	\$1,835	
19 1/4	15	84 3/4	152	18	40C191585SCDSL	\$1,740	
19 1/4	12	84 3/4	132	15	40C191285SCDSL	\$1,650	

Specify: Model | Chassis Laminate | Door Laminate | Interior Configuration | Pull | Lock

Model	Chassis Laminate	Door Laminate	Interior Configuration	Pull	Lock
	see Forge Laminate Finishes	see Forge Laminate Finishes	CH Coat Hook CR2FS Coat Rod & 2 Fixed Shelves - add \$42 1F3AS 1 Fixed & 3 Adjustable Shelves - add \$150	P001 Bar see Bar Pull Color P005 Delve see Delve Pull Color P011 Prospect see Prospect Pull Color P003 Sweep see Sweep Pull Color	NLK No Lock KLK Standard - add \$78 ASL Arctic Silver MBK Matte Black DLK Keyless Lock - add \$232

24" d Models

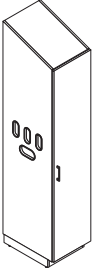
Description	D	W	H	CTN WT	CU FT	Model	List
 <p>right shown</p>	92 ½" h Right Hinged						
	24 ¼	24	92 ½	240	37	40C242493SCDGBSRT	\$2,780
	24 ¼	21	92 ½	221	33	40C242193SCDGBSRT	\$2,635
	24 ¼	18	92 ½	201	28	40C241893SCDGBSRT	\$2,490
	24 ¼	15	92 ½	181	24	40C241593SCDGBSRT	\$2,345
	24 ¼	12	92 ½	161	20	40C241293SCDGBSRT	\$2,200
	92 ½" h Left Hinged						
	24 ¼	24	92 ½	240	37	40C242493SCDGBSLT	\$2,780
	24 ¼	21	92 ½	221	33	40C242193SCDGBSLT	\$2,635
	24 ¼	18	92 ½	201	28	40C241893SCDGBSLT	\$2,490
	24 ¼	15	92 ½	181	24	40C241593SCDGBSLT	\$2,345
	24 ¼	12	92 ½	161	20	40C241293SCDGBSLT	\$2,200
	86 ½" h Right Hinged						
	24 ¼	24	86 ½	228	34	40C242487SCDGBSRT	\$2,580
	24 ¼	21	86 ½	209	30	40C242187SCDGBSRT	\$2,470
	24 ¼	18	86 ½	190	27	40C241887SCDGBSRT	\$2,360
	24 ¼	15	86 ½	171	23	40C241587SCDGBSRT	\$2,250
	24 ¼	12	86 ½	152	19	40C241287SCDGBSRT	\$2,140
	86 ½" h Left Hinged						
	24 ¼	24	86 ½	228	34	40C242487SCDGBSLT	\$2,580
24 ¼	21	86 ½	209	30	40C242187SCDGBSLT	\$2,470	
24 ¼	18	86 ½	190	27	40C241887SCDGBSLT	\$2,360	
24 ¼	15	86 ½	171	23	40C241587SCDGBSLT	\$2,250	
24 ¼	12	86 ½	152	19	40C241287SCDGBSLT	\$2,140	

• metal glove box holder is included

Specify: Model | Chassis Laminate | Door Laminate | Pull | Lock | Waste Grommet Color

Model	Chassis Laminate	Door Laminate	Pull	Lock	Waste Grommet Color
	see Forge Laminate Finishes	see Forge Laminate Finishes	P001 Bar see Bar Pull Color P005 Delve see Delve Pull Color P011 Prospect see Prospect Pull Color P003 Sweep see Sweep Pull Color	NLK No Lock KLK Standard - add \$78 ASL Arctic Silver MBK Matte Black DLK Keyless Lock - add \$232	MBK Matte Black SNK Soft Nickel

19" d Models

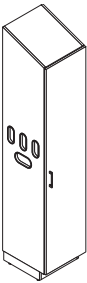
Description	D	W	H	CTN WT	CU FT	Model	List
 <p>right shown</p>	90 3/4" h Right Hinged						
	19 1/4	24	90 3/4	218	30	40C192491SCDGBSRT	\$2,575
	19 1/4	21	90 3/4	199	26	40C192191SCDGBSRT	\$2,395
	19 1/4	18	90 3/4	179	23	40C191891SCDGBSRT	\$2,308
	19 1/4	15	90 3/4	159	20	40C191591SCDGBSRT	\$2,165
	19 1/4	12	90 3/4	139	16	40C191291SCDGBSRT	\$1,990
	90 3/4" h Left Hinged						
	19 1/4	24	90 3/4	218	30	40C192491SCDGBSLT	\$2,575
	19 1/4	21	90 3/4	199	26	40C192191SCDGBSLT	\$2,395
	19 1/4	18	90 3/4	179	23	40C191891SCDGBSLT	\$2,308
	19 1/4	15	90 3/4	159	20	40C191591SCDGBSLT	\$2,165
	19 1/4	12	90 3/4	139	16	40C191291SCDGBSLT	\$1,990
	84 3/4" h Right Hinged						
	19 1/4	24	84 3/4	208	28	40C192485SCDGBSRT	\$2,370
	19 1/4	21	84 3/4	190	25	40C192185SCDGBSRT	\$2,290
	19 1/4	18	84 3/4	170	21	40C191885SCDGBSRT	\$2,180
	19 1/4	15	84 3/4	152	18	40C191585SCDGBSRT	\$2,020
	19 1/4	12	84 3/4	132	15	40C191285SCDGBSRT	\$1,930
	84 3/4" h Left Hinged						
	19 1/4	24	84 3/4	208	28	40C192485SCDGBSLT	\$2,370
19 1/4	21	84 3/4	190	25	40C192185SCDGBSLT	\$2,290	
19 1/4	18	84 3/4	170	21	40C191885SCDGBSLT	\$2,180	
19 1/4	15	84 3/4	152	18	40C191585SCDGBSLT	\$2,020	
19 1/4	12	84 3/4	132	15	40C191285SCDGBSLT	\$1,930	

• metal glove box holder is included

Specify: Model | Chassis Laminate | Door Laminate | Pull | Lock | Waste Grommet Color

Model	Chassis Laminate	Door Laminate	Pull	Lock	Waste Grommet Color
	see Forge Laminate Finishes	see Forge Laminate Finishes	P001 Bar see Bar Pull Color P005 Delve see Delve Pull Color P011 Prospect see Prospect Pull Color P003 Sweep see Sweep Pull Color	NLK No Lock KLK Standard - add \$78 ASL Arctic Silver MBK Matte Black DLK Keyless Lock - add \$232	MBK Matte Black SNK Soft Nickel

24"d Models

Description	D	W	H	CTN WT	CU FT	① Model	List
Sloped Top Storage Cabinet with Doors	24 ¼	36	92 ½	320	53	40C243693SCDST	\$3,220
	24 ¼	30	92 ½	280	45	40C243093SCDST	\$3,085
	24 ¼	36	86 ½	305	50	40C243687SCDST	\$2,935
	24 ¼	30	86 ½	266	42	40C243087SCDST	\$2,800

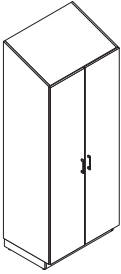

Specify: Model | Chassis Laminate | Door Laminate | Interior Configuration | Pull | Lock

19"d Models

Description	D	W	H	CTN WT	CU FT	① Model	List
Sloped Top Storage Cabinet with Doors	19 ¼	36	90 ¾	298	43	40C193691SCDST	\$2,995
	19 ¼	30	90 ¾	258	36	40C193091SCDST	\$2,860
	19 ¼	36	84 ¾	285	40	40C193685SCDST	\$2,785
	19 ¼	30	84 ¾	247	34	40C193085SCDST	\$2,650

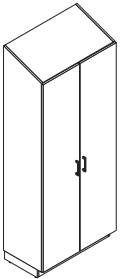

Specify: Model | Chassis Laminate | Door Laminate | Interior Configuration | Pull | Lock

Model	Chassis Laminate	Door Laminate	Interior Configuration	Pull	Lock
	see Forge Laminate Finishes	see Forge Laminate Finishes	CH Coat Hook CR2FS Coat Rod & 2 Fixed Shelves - add \$42 1F3AS 1 Fixed & 3 Adjustable Shelves - add \$150	P001 Bar see Bar Pull Color P005 Delve see Delve Pull Color P011 Prospect see Prospect Pull Color P003 Sweep see Sweep Pull Color	NLK No Lock KLK Standard - add \$102 ASL Arctic Silver MBK Matte Black DLK Keyless Lock - add \$256

24"d Models

Description	D	W	H	CTN WT	CU FT	Model	List
Sloped Top Storage Filler	23 ½	6	92 ½	8	12	40C24693SFST	\$357
	23 ½	6	86 ½	7	12	40C24687SFST	\$340

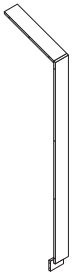

- includes brackets to attach to cabinet
- may be field scribed as needed

Specify: Model | Chassis Laminate

19"d Models

Description	D	W	H	CTN WT	CU FT	Model	List
Sloped Top Storage Filler	19 ¼	6	90 ¾	7	10	40C19691SFST	\$338
	19 ¼	6	84 ¾	7	9	40C19685SFST	\$322



- includes brackets to attach to cabinet
- may be field scribed as needed

Specify: Model | Chassis Laminate

Model	Chassis Laminate
	see Forge Laminate Finishes

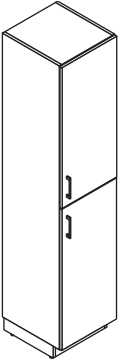
Description	D	W	H	CTN WT	CU FT	Model	List
 <p>right shown</p>	Right Hinged						
	24 ¼	24	84	208	33	40C242484SCDR2T	\$2,295
	24 ¼	21	84	193	30	40C242184SCDR2T	\$2,187
	24 ¼	18	84	177	26	40C241884SCDR2T	\$2,080
	24 ¼	15	84	162	22	40C241584SCDR2T	\$1,973
	24 ¼	12	84	146	18	40C241284SCDR2T	\$1,866
	19 ¼	24	84	179	28	40C192484SCDR2T	\$2,075
	19 ¼	21	84	164	25	40C192184SCDR2T	\$1,897
	19 ¼	18	84	149	22	40C191884SCDR2T	\$1,720
	19 ¼	15	84	134	19	40C191584SCDR2T	\$1,643
	19 ¼	12	84	119	15	40C191284SCDR2T	\$1,566
	Left Hinged						
	24 ¼	24	84	208	33	40C242484SCDL2T	\$2,295
	24 ¼	21	84	193	30	40C242184SCDL2T	\$2,187
	24 ¼	18	84	177	26	40C241884SCDL2T	\$2,080
	24 ¼	15	84	162	22	40C241584SCDL2T	\$1,973
	24 ¼	12	84	146	18	40C241284SCDL2T	\$1,866
	19 ¼	24	84	179	28	40C192484SCDL2T	\$2,075
	19 ¼	21	84	164	25	40C192184SCDL2T	\$1,897
19 ¼	18	84	149	22	40C191884SCDL2T	\$1,720	
19 ¼	15	84	134	19	40C191584SCDL2T	\$1,643	
19 ¼	12	84	119	15	40C191284SCDL2T	\$1,566	

Specify: Model | Chassis Laminate | Door Laminate | Pull | Lock

Model	Chassis Laminate	Door Laminate	Pull	Lock
	see Forge Laminate Finishes	see Forge Laminate Finishes	P001 Bar see Bar Pull Color P005 Delve see Delve Pull Color P011 Prospect see Prospect Pull Color P003 Sweep see Sweep Pull Color	NLK No Lock KLK Standard - add \$156 ASL Arctic Silver MBK Matte Black DLK Keyless Lock - add \$464

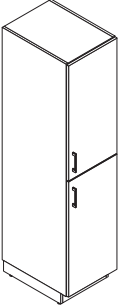
Description	D	W	H	CTN WT	CU FT	Model	List
 <p>right shown</p>	Right Hinged						
	24 ¼	24	78	196	31	40C242478SCDR2T	\$1,840
	24 ¼	21	78	182	28	40C242178SCDR2T	\$1,800
	24 ¼	18	78	167	24	40C241878SCDR2T	\$1,755
	24 ¼	15	78	152	21	40C241578SCDR2T	\$1,561
	24 ¼	12	78	137	17	40C241278SCDR2T	\$1,425
	19 ¼	24	78	169	26	40C192478SCDR2T	\$1,800
	19 ¼	21	78	155	23	40C192178SCDR2T	\$1,630
	19 ¼	18	78	141	20	40C191878SCDR2T	\$1,560
	19 ¼	15	78	127	17	40C191578SCDR2T	\$1,467
	19 ¼	12	78	112	14	40C191278SCDR2T	\$1,375
	Left Hinged						
	24 ¼	24	78	196	31	40C242478SCDL2T	\$1,840
	24 ¼	21	78	182	28	40C242178SCDL2T	\$1,800
	24 ¼	18	78	167	24	40C241878SCDL2T	\$1,755
	24 ¼	15	78	152	21	40C241578SCDL2T	\$1,561
	24 ¼	12	78	137	17	40C241278SCDL2T	\$1,425
	19 ¼	24	78	169	26	40C192478SCDL2T	\$1,800
	19 ¼	21	78	155	23	40C192178SCDL2T	\$1,630
19 ¼	18	78	141	20	40C191878SCDL2T	\$1,560	
19 ¼	15	78	127	17	40C191578SCDL2T	\$1,467	
19 ¼	12	78	112	14	40C191278SCDL2T	\$1,375	

Specify: Model | Chassis Laminate | Door Laminate | Pull | Lock

Model	Chassis Laminate	Door Laminate	Pull	Lock
	see Forge Laminate Finishes	see Forge Laminate Finishes	P001 Bar see Bar Pull Color P005 Delve see Delve Pull Color P011 Prospect see Prospect Pull Color P003 Sweep see Sweep Pull Color	NLK No Lock KLK Standard - add \$156 ASL Arctic Silver MBK Matte Black DLK Keyless Lock - add \$464

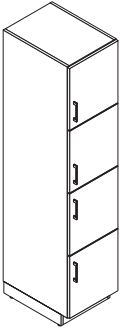
Description	D	W	H	CTN WT	CU FT	Model	List
 <p>right shown</p>	Right Hinged						
	24 ¼	24	84	219	33	40C242484SCDR4T	\$2,585
	24 ¼	21	84	202	30	40C242184SCDR4T	\$2,405
	24 ¼	18	84	185	26	40C241884SCDR4T	\$2,225
	24 ¼	15	84	168	22	40C241584SCDR4T	\$2,045
	24 ¼	12	84	151	18	40C241284SCDR4T	\$1,865
	19 ¼	24	84	189	28	40C192484SCDR4T	\$2,350
	19 ¼	21	84	172	25	40C192184SCDR4T	\$2,161
	19 ¼	18	84	156	22	40C191884SCDR4T	\$1,971
	19 ¼	15	84	140	19	40C191584SCDR4T	\$1,782
	19 ¼	12	84	123	15	40C191284SCDR4T	\$1,593
	Left Hinged						
	24 ¼	24	84	219	33	40C242484SCDL4T	\$2,585
	24 ¼	21	84	202	30	40C242184SCDL4T	\$2,405
	24 ¼	18	84	185	26	40C241884SCDL4T	\$2,225
	24 ¼	15	84	168	22	40C241584SCDL4T	\$2,045
	24 ¼	12	84	151	18	40C241284SCDL4T	\$1,865
	19 ¼	24	84	194	28	40C192484SCDL4T	\$2,350
	19 ¼	21	84	177	25	40C192184SCDL4T	\$2,161
19 ¼	18	84	160	22	40C191884SCDL4T	\$1,971	
19 ¼	15	84	143	19	40C191584SCDL4T	\$1,782	
19 ¼	12	84	126	15	40C191284SCDL4T	\$1,593	

Specify: Model | Chassis Laminate | Door Laminate | Pull | Lock

Model	Chassis Laminate	Door Laminate	Pull	Lock
	see Forge Laminate Finishes	see Forge Laminate Finishes	P001 Bar see Bar Pull Color P005 Delve see Delve Pull Color P011 Prospect see Prospect Pull Color P003 Sweep see Sweep Pull Color	NLK No Lock KLK Standard - add \$312 ASL Arctic Silver MBK Matte Black DLK Keyless Lock - add \$928

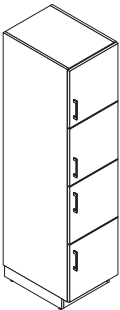
Description	D	W	H	CTN WT	CU FT	Model	List
 <p>right shown</p>	Right Hinged						
	24 ¼	24	78	207	31	40C242478SCDR4T	\$2,271
	24 ¼	21	78	191	28	40C242178SCDR4T	\$2,144
	24 ¼	18	78	174	24	40C241878SCDR4T	\$2,017
	24 ¼	15	78	158	21	40C241578SCDR4T	\$1,890
	24 ¼	12	78	142	17	40C241278SCDR4T	\$1,763
	19 ¼	24	78	178	26	40C192478SCDR4T	\$2,042
	19 ¼	21	78	163	23	40C192178SCDR4T	\$1,921
	19 ¼	18	78	147	20	40C191878SCDR4T	\$1,800
	19 ¼	15	78	132	17	40C191578SCDR4T	\$1,678
	19 ¼	12	78	116	14	40C191278SCDR4T	\$1,557
	Left Hinged						
	24 ¼	24	78	207	31	40C242478SCDL4T	\$2,271
	24 ¼	21	78	191	28	40C242178SCDL4T	\$2,144
	24 ¼	18	78	174	24	40C241878SCDL4T	\$2,017
	24 ¼	15	78	158	21	40C241578SCDL4T	\$1,890
	24 ¼	12	78	142	17	40C241278SCDL4T	\$1,763
	19 ¼	24	78	184	26	40C192478SCDL4T	\$2,042
	19 ¼	21	78	168	23	40C192178SCDL4T	\$1,921
19 ¼	18	78	152	20	40C191878SCDL4T	\$1,800	
19 ¼	15	78	136	17	40C191578SCDL4T	\$1,678	
19 ¼	12	78	120	14	40C191278SCDL4T	\$1,557	

Specify: Model | Chassis Laminate | Door Laminate | Pull | Lock

Model	Chassis Laminate	Door Laminate	Pull	Lock
	see Forge Laminate Finishes	see Forge Laminate Finishes	P001 Bar see Bar Pull Color P005 Delve see Delve Pull Color P011 Prospect see Prospect Pull Color P003 Sweep see Sweep Pull Color	NLK No Lock KLK Standard - add \$312 ASL Arctic Silver MBK Matte Black DLK Keyless Lock - add \$928

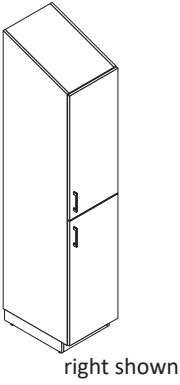
Description	D	W	H	CTN WT	CU FT	Model	List
Sloped Top Two Door Lockers 92 1/2" h Right Hinged							
	24 1/4	24	92 1/2	208	37	40C242493SCDR2ST	\$2,360
	24 1/4	21	92 1/2	193	33	40C242193SCDR2ST	\$2,252
	24 1/4	18	92 1/2	177	28	40C241893SCDR2ST	\$2,145
	24 1/4	15	92 1/2	162	24	40C241593SCDR2ST	\$2,038
	24 1/4	12	92 1/2	146	20	40C241293SCDR2ST	\$1,931
92 1/2" h Left Hinged							
	24 1/4	24	92 1/2	208	37	40C242493SCDL2ST	\$2,360
	24 1/4	21	92 1/2	193	33	40C242193SCDL2ST	\$2,252
	24 1/4	18	92 1/2	177	28	40C241893SCDL2ST	\$2,145
	24 1/4	15	92 1/2	162	24	40C241593SCDL2ST	\$2,038
	24 1/4	12	92 1/2	146	20	40C241293SCDL2ST	\$1,931
90 3/4" h Right Hinged							
	19 1/4	24	90 3/4	181	30	40C192491SCDR2ST	\$2,143
	19 1/4	21	90 3/4	166	27	40C192191SCDR2ST	\$1,965
	19 1/4	18	90 3/4	151	24	40C191891SCDR2ST	\$1,788
	19 1/4	15	90 3/4	136	20	40C191591SCDR2ST	\$1,711
	19 1/4	12	90 3/4	121	17	40C191291SCDR2ST	\$1,634
90 3/4" h Left Hinged							
	19 1/4	24	90 3/4	181	30	40C192491SCDL2ST	\$2,143
	19 1/4	21	90 3/4	166	27	40C192191SCDL2ST	\$1,965
	19 1/4	18	90 3/4	151	24	40C191891SCDL2ST	\$1,788
	19 1/4	15	90 3/4	136	20	40C191591SCDL2ST	\$1,711
	19 1/4	12	90 3/4	121	17	40C191291SCDL2ST	\$1,634

Specify: Model | Chassis Laminate | Door Laminate | Pull | Lock

Model	Chassis Laminate	Door Laminate	Pull	Lock
	see Forge Laminate Finishes	see Forge Laminate Finishes	P001 Bar see Bar Pull Color P005 Delve see Delve Pull Color P011 Prospect see Prospect Pull Color P003 Sweep see Sweep Pull Color	NLK No Lock KLK Standard - add \$156 ASL Arctic Silver MBK Matte Black DLK Keyless Lock - add \$464

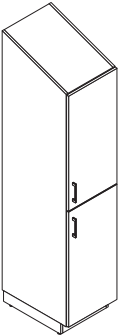
Description	D	W	H	CTN WT	CU FT	Model	List
Sloped Top Two Door Lockers 86 1/2" h Right Hinged							
	24 1/4	24	86 1/2	196	34	40C242487SCDR2ST	\$1,905
	24 1/4	21	86 1/2	182	30	40C242187SCDR2ST	\$1,865
	24 1/4	18	86 1/2	167	27	40C241887SCDR2ST	\$1,820
	24 1/4	15	86 1/2	152	23	40C241587SCDR2ST	\$1,626
	24 1/4	12	86 1/2	137	19	40C241287SCDR2ST	\$1,490
86 1/2" h Left Hinged							
	24 1/4	24	86 1/2	196	34	40C242487SCDL2ST	\$1,905
	24 1/4	21	86 1/2	182	30	40C242187SCDL2ST	\$1,865
	24 1/4	18	86 1/2	167	27	40C241887SCDL2ST	\$1,820
	24 1/4	15	86 1/2	152	23	40C241587SCDL2ST	\$1,626
	24 1/4	12	86 1/2	137	19	40C241287SCDL2ST	\$1,490
84 3/4" h Right Hinged							
	19 1/4	24	84 3/4	171	29	40C192485SCDR2ST	\$1,868
	19 1/4	21	84 3/4	157	25	40C192185SCDR2ST	\$1,698
	19 1/4	18	84 3/4	142	22	40C191885SCDR2ST	\$1,628
	19 1/4	15	84 3/4	128	19	40C191585SCDR2ST	\$1,535
	19 1/4	12	84 3/4	114	16	40C191285SCDR2ST	\$1,443
84 3/4" h Left Hinged							
	19 1/4	24	84 3/4	171	29	40C192485SCDL2ST	\$1,868
	19 1/4	21	84 3/4	157	25	40C192185SCDL2ST	\$1,698
	19 1/4	18	84 3/4	142	22	40C191885SCDL2ST	\$1,628
	19 1/4	15	84 3/4	128	19	40C191585SCDL2ST	\$1,535
	19 1/4	12	84 3/4	114	16	40C191285SCDL2ST	\$1,443

Specify: Model | Chassis Laminate | Door Laminate | Pull | Lock

Model	Chassis Laminate	Door Laminate	Pull	Lock
	see Forge Laminate Finishes	see Forge Laminate Finishes	P001 Bar see Bar Pull Color P005 Delve see Delve Pull Color P011 Prospect see Prospect Pull Color P003 Sweep see Sweep Pull Color	NLK No Lock KLK Standard - add \$156 ASL Arctic Silver MBK Matte Black DLK Keyless Lock - add \$464

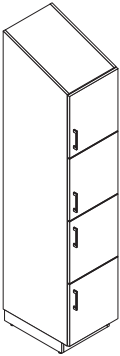
Description	D	W	H	CTN WT	CU FT	Model	List
 <p>right shown</p>	92 ½" h Right Hinged						
	24 ¼	24	92 ½	219	37	40C242493SCDR4ST	\$2,672
	24 ¼	21	92 ½	202	33	40C242193SCDR4ST	\$2,492
	24 ¼	18	92 ½	185	28	40C241893SCDR4ST	\$2,312
	24 ¼	15	92 ½	168	24	40C241593SCDR4ST	\$2,132
	24 ¼	12	92 ½	151	20	40C241293SCDR4ST	\$1,952
	92 ½" h Left Hinged						
	24 ¼	24	92 ½	219	37	40C242493SCDL4ST	\$2,672
	24 ¼	21	92 ½	202	33	40C242193SCDL4ST	\$2,492
	24 ¼	18	92 ½	185	28	40C241893SCDL4ST	\$2,312
	24 ¼	15	92 ½	168	24	40C241593SCDL4ST	\$2,132
	24 ¼	12	92 ½	151	20	40C241293SCDL4ST	\$1,952
	90 ¾" h Right Hinged						
	19 ¼	24	90 ¾	190	30	40C192491SCDR4ST	\$2,445
	19 ¼	21	90 ¾	174	27	40C192191SCDR4ST	\$2,256
	19 ¼	18	90 ¾	157	24	40C191891SCDR4ST	\$2,066
	19 ¼	15	90 ¾	141	20	40C191591SCDR4ST	\$1,877
	19 ¼	12	90 ¾	125	17	40C191291SCDR4ST	\$1,688
	90 ¾" h Left Hinged						
	19 ¼	24	90 ¾	190	30	40C192491SCDL4ST	\$2,445
19 ¼	21	90 ¾	174	27	40C192191SCDL4ST	\$2,256	
19 ¼	18	90 ¾	157	24	40C191891SCDL4ST	\$2,066	
19 ¼	15	90 ¾	141	20	40C191591SCDL4ST	\$1,877	
19 ¼	12	90 ¾	125	17	40C191291SCDL4ST	\$1,688	

Specify: Model | Chassis Laminate | Door Laminate | Pull | Lock

Model	Chassis Laminate	Door Laminate	Pull	Lock
	see Forge Laminate Finishes	see Forge Laminate Finishes	P001 Bar see Bar Pull Color P005 Delve see Delve Pull Color P011 Prospect see Prospect Pull Color P003 Sweep see Sweep Pull Color	NLK No Lock KLK Standard - add \$312 ASL Arctic Silver MBK Matte Black DLK Keyless Lock - add \$928

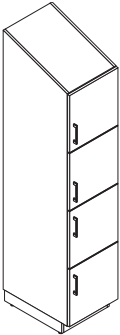
Description	D	W	H	CTN WT	CU FT	Model	List
 <p>right shown</p>	86 ½" h Right Hinged						
	24 ¼	24	86 ½	207	34	40C242487SCDR4ST	\$2,363
	24 ¼	21	86 ½	191	30	40C242187SCDR4ST	\$2,236
	24 ¼	18	86 ½	174	27	40C241887SCDR4ST	\$2,109
	24 ¼	15	86 ½	158	23	40C241587SCDR4ST	\$1,982
	24 ¼	12	86 ½	142	19	40C241287SCDR4ST	\$1,855
	86 ½" h Left Hinged						
	24 ¼	24	86 ½	207	34	40C242487SCDL4ST	\$2,363
	24 ¼	21	86 ½	191	30	40C242187SCDL4ST	\$2,236
	24 ¼	18	86 ½	174	27	40C241887SCDL4ST	\$2,109
	24 ¼	15	86 ½	158	23	40C241587SCDL4ST	\$1,982
	24 ¼	12	86 ½	142	19	40C241287SCDL4ST	\$1,855
	84 ¾" h Right Hinged						
	19 ¼	24	84 ¾	180	29	40C192485SCDR4ST	\$2,134
	19 ¼	21	84 ¾	165	25	40C192185SCDR4ST	\$2,013
	19 ¼	18	84 ¾	149	22	40C191885SCDR4ST	\$1,892
	19 ¼	15	84 ¾	133	19	40C191585SCDR4ST	\$1,770
	19 ¼	12	84 ¾	118	16	40C191285SCDR4ST	\$1,649
	84 ¾" h Right Hinged						
	19 ¼	24	84 ¾	180	29	40C192485SCDL4ST	\$2,134
19 ¼	21	84 ¾	165	25	40C192185SCDL4ST	\$2,013	
19 ¼	18	84 ¾	149	22	40C191885SCDL4ST	\$1,892	
19 ¼	15	84 ¾	133	19	40C191585SCDL4ST	\$1,770	
19 ¼	12	84 ¾	118	16	40C191285SCDL4ST	\$1,649	

Specify: Model | Chassis Laminate | Door Laminate | Pull | Lock

Model	Chassis Laminate	Door Laminate	Pull	Lock
	see Forge Laminate Finishes	see Forge Laminate Finishes	P001 Bar see Bar Pull Color P005 Delve see Delve Pull Color P011 Prospect see Prospect Pull Color P003 Sweep see Sweep Pull Color	NLK No Lock KLK Standard - add \$312 ASL Arctic Silver MBK Matte Black DLK Keyless Lock - add \$928

Description	D	W	H	CTN WT	CU FT	Model	List
	¾	36	42	33	3	40C3642WPT	\$480
	¾	30	42	28	3	40C3042WPT	\$476
	¾	24	42	22	2	40C2442WPT	\$472
	¾	21	42	20	2	40C2142WPT	\$469
	¾	18	42	17	2	40C1842WPT	\$466
	¾	36	36	29	3	40C3636WPT	\$408
	¾	30	36	24	2	40C3036WPT	\$404
	¾	24	36	19	2	40C2436WPT	\$400
	¾	21	36	17	2	40C2136WPT	\$397
	¾	18	36	14	2	40C1836WPT	\$394
	¾	36	30	24	2	40C3630WPT	\$328
	¾	30	30	20	2	40C3030WPT	\$324
	¾	24	30	16	2	40C2430WPT	\$320
	¾	21	30	14	2	40C2130WPT	\$317
	¾	18	30	12	1	40C1830WPT	\$314
	¾	36	24	19	2	40C3624WPT	\$287
	¾	30	24	16	2	40C3024WPT	\$283
	¾	24	24	13	2	40C2424WPT	\$279
	¾	21	24	11	1	40C2124WPT	\$276
	¾	18	24	10	1	40C1824WPT	\$273
¾	36	18	15	2	40C3618WPT	\$270	
¾	30	18	12	1	40C3018WPT	\$267	
¾	24	18	10	1	40C2418WPT	\$264	
¾	21	18	9	1	40C2118WPT	\$261	
¾	18	18	7	1	40C1818WPT	\$258	

Specify: Model | Chassis Laminate

Model	Chassis Laminate
	see Forge Laminate Finishes

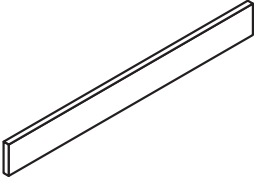
Description	D	W	H	CTN WT	CU FT	Model	List
 <p>Toe Kick</p>	¾	96	4	8	1	40C496TKT	\$215
	¾	95 ½	4	8	1	40C495TKT	\$213
	¾	93	4	8	1	40C493TKT	\$211
	¾	92 ½	4	8	1	40C492TKT	\$209
	¾	90	4	8	1	40C490TKT	\$207
	¾	89 ½	4	8	1	40C489TKT	\$205
	¾	87	4	8	1	40C487TKT	\$203
	¾	86 ½	4	7	1	40C486TKT	\$201
	¾	84	4	7	1	40C484TKT	\$199
	¾	83 ½	4	7	1	40C483TKT	\$197
	¾	81	4	7	1	40C481TKT	\$195
	¾	80 ½	4	7	1	40C480TKT	\$193
	¾	78	4	7	1	40C478TKT	\$192
	¾	77 ½	4	7	1	40C477TKT	\$190
	¾	75	4	7	1	40C475TKT	\$188
	¾	74 ½	4	7	1	40C474TKT	\$186
	¾	72	4	6	1	40C472TKT	\$184
	¾	71 ½	4	6	1	40C471TKT	\$182
	¾	69	4	6	1	40C469TKT	\$180
	¾	68 ½	4	6	1	40C468TKT	\$178
	¾	66	4	6	1	40C466TKT	\$176
	¾	65 ½	4	6	1	40C465TKT	\$174
	¾	63	4	6	1	40C463TKT	\$172
	¾	62 ½	4	6	1	40C462TKT	\$170
	¾	60	4	5	1	40C460TKT	\$168
	¾	59 ½	4	5	1	40C459TKT	\$166
	¾	57	4	5	1	40C457TKT	\$164
	¾	56 ½	4	5	1	40C456TKT	\$162
	¾	54	4	5	1	40C454TKT	\$160
	¾	53 ½	4	5	1	40C453TKT	\$158
¾	51	4	5	1	40C451TKT	\$156	
¾	50 ½	4	5	1	40C450TKT	\$154	
¾	48	4	4	1	40C448TKT	\$153	
¾	47 ½	4	4	1	40C447TKT	\$151	

Specify: Model | Chassis Laminate

Model	Chassis Laminate
	see Forge Laminate Finishes

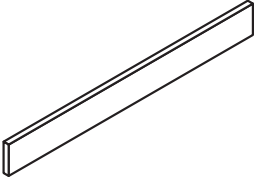
Description	D	W	H	CTN WT	CU FT	① Model	List
Toe Kick (continued)	¾	45	4	4	1	40C445TKT	\$149
	¾	44 ½	4	4	1	40C444TKT	\$147
	¾	42	4	4	1	40C442TKT	\$146
	¾	41 ½	4	4	1	40C441TKT	\$144
	¾	39	4	4	1	40C439TKT	\$142
	¾	38 ½	4	4	1	40C438TKT	\$140
	¾	36	4	3	1	40C436TKT	\$138
	¾	35 ½	4	3	1	40C435TKT	\$136
	¾	33	4	3	1	40C433TKT	\$134
	¾	32 ½	4	3	1	40C432TKT	\$132
	¾	30	4	3	1	40C430TKT	\$130
	¾	29 ½	4	3	1	40C429TKT	\$128
	¾	27	4	3	1	40C427TKT	\$126
	¾	26 ½	4	3	1	40C426TKT	\$124
	¾	24	4	2	1	40C424TKT	\$123
	¾	23 ½	4	2	1	40C423TKT	\$121
	¾	21	4	2	1	40C421TKT	\$119
	¾	20 ½	4	2	1	40C420TKT	\$118
	¾	18	4	2	1	40C418TKT	\$116
	¾	17 ½	4	2	1	40C417TKT	\$114
	¾	15	4	2	1	40C415TKT	\$112
¾	14 ½	4	2	1	40C414TKT	\$111	
¾	12	4	2	1	40C412TKT	\$109	
¾	11 ½	4	1	1	40C411TKT	\$107	

Specify: Model | Chassis Laminate

Removable Drawer Liner	15 ⅞	15 ¼	3	1	2	40CDBL244	\$134
	15 ⅞	21 ¼	3	1	2	40CDBL184	\$122

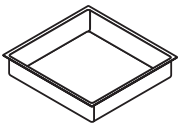

Specify: Model

Model Chassis Laminate
[see Forge Laminate Finishes](#)



Formica Laminate

Forge offers an extensive program for laminates beyond our Standard Program. Always reference below the most current listing and tier pricing when using a Graded-In Laminate; on page 108 select the color of the PVC edge color.

Laminate	Pattern-Sheen	Tier	Laminate	Pattern-Sheen	Tier	Laminate	Pattern-Sheen	Tier	Laminate	Pattern-Sheen	Tier
Acajou Mahogany	7008-58	2	Dark Chocolate	2200-58	2	Mission White	933-58	2	Smoke Onyx	3710-58	2
Aged Ash	8844-58	2	Denim	8822-58	2	Mocha Travertine	3456-58	2	Smoke Quarstone	6220-58	2
Algae	8796-58	2	Desert Beige	899-58	2	Mojave	8751-58	2	Smokey Brown Pear	5488-58	2
Almond	920-58	2	Dover White	7197-58	2	Moonstone	7872-58	2	Solar Orange	8235-58	2
Aluminum	9318-58	2	Earth	5342-58	2	Mouse	928-58	2	Sorrel Cherry	5886-58	2
Amber Kashmir	6227-58	2	Earth Wash	7213-58	2	Muslin Fabric	6127-58	2	Spectrum Blue	851-58	2
Amber Maple	7012-58	2	Earthen Twill	8828-58	2	Natural Ash	8843-58	2	Spectrum Green	7897-58	2
Antique White	932-58	2	Earthen Warp	5880-58	2	Natural Birch	7481-58	2	Spectrum Red	845-58	2
Argento Romano	6697-58	2	Earthenware	8241-58	2	Natural Canvas	7022-58	2	Stainless	9319-58	2
Artichoke	800-58	2	Earthenware	6999-58	2	Natural Gray Felt	4971-58	2	Star Dune	9309-58	2
Ashwood Beige	5785-58	2	Brushstroke		2	Natural Maple	756-58	2	Starched Paperfold	8678-58	2
Ashwood Bone	5784-58	2	Ebony	9012-58	2	Natural Oak	346-58	2	Stone Grafix	503-58	2
Ashwood Oak	5786-58	2	Ebony Oxide	299-58	2	Natural Recycled Kraft	9684-58	2	Stop Red	839-58	2
Basalt Slate	3690-58	2	Elemental Concrete	8830-58	2	Natural Riftwood	9282-58	2	Storm	912-58	2
Beige Elm	5794-58	2	Elemental Stone	8831-58	2	Natural Teak	8849-58	2	Storm Solidz	3505-58	2
Belmonte Granite	3496-58	2	Espresso Pear	5489-58	2	Navy Blue	969-58	2	Storm Teakwood	8908-58	2
Birchbark	8684-58	2	Finnish Oak	118-58	2	Navy Grafix	7018-58	2	Sugar Glass	3705-58	2
Black	909-58	2	Flax Gauze	7708-58	2	Neo Cloud	6314-58	2	Surf	923-58	2
Black Bardiglio	5019-58	2	Flint Crystal	3518-58	2	Neutral Twill	8826-58	2	Swede Rift Oak	8676-58	2
Black Birchply	8552-58	2	Fog	961-58	2	Neutral Weft	5875-58	2	Taupe Walnut	5787-58	2
Black Recycled Kraft	9685-58	2	Folkstone	927-58	2	Neutral White	918-58	2	Terril	2297-58	2
Black Riftwood	6414-58	2	Folkstone Celesta	692-58	2	New Burgundy	7966-58	2	Thermo Walnut	6402-58	2
Black Shalestone	9527-58	2	Folkstone Grafix	507-58	2	Night Forest	8244-58	2	Travertine	3526-58	2
Black Walnut	3485-58	2	Formal Walnut	5782-58	2	Night Shade	8243-58	2	Tula Oak	8589-58	2
Blackened Fiberwood	8916-58	2	Fossil	5349-58	2	Noble Mahogany	9236-58	2	Venetian Gold Granite	6223-58	2
Blackened Legno	8848-58	2	Fox Teakwood	8907-58	2	Nocturne	5323-58	2	Vibrant Green	6901-58	2
Blackened Steel	8918-58	2	Geriba Gray	9308-58	2	Noir Cedar	1547-58	2	Walnut Butcherblock	3712-58	2
Blackstone	271-58	2	Ginger Root Maple	7288-58	2	Noir Envision	7500-58	2	Walnut Fiberwood	8915-58	2
Bleached Legno	8845-58	2	Glamour Cherry	6208-58	2	Nut Brown Cherry	5790-58	2	Walnut Riftwood	9283-58	2
Blond Cedar	8576-58	2	Glass Cloth	8683-58	2	Oiled Legno	8846-58	2	Walnut Softwood	4925-58	2
Blossom Cherrywood	758-58	2	Gold Braze	1193-58	2	Oiled Walnut	5487-58	2	Washi Paperfold	8680-58	2
Blue Felt	9320-58	2	Graphite	837-58	2	Orange Felt	4973-58	2	Waxed Maple	8905-58	2
Blush	8238-58	2	Graphite Elm	5796-58	2	Origami Paperfold	8679-58	2	Weathered Ash	8842-58	2
Brazilian Brown Granite	6222-58	2	Graphite Grafix	515-58	2	Otter	3202-58	2	Weathered Fiberwood	8914-58	2
Brite White	459-58	2	Graphite Twill	8829-58	2	Oxidized Beamwood	9484-58	2	Wenge Strand	6306-58	2
Bronzed Steel	8919-58	2	Gray Fabric	6129-58	2	Oyster Grey	929-58	2	Wheat Strand	6212-58	2
Bubble Art	8958-58	2	Gray Grafix	9300-58	2	Pale Brushstroke	6997-58	2	White	949-58	2
Buff Elm	5793-58	2	Gray Onyx	7409-58	2	Paloma Polar	6698-58	2	White Ash	8841-58	2
Burnished Coin	3708-58	2	Grayed Oak	5791-58	2	Patine Bronze	3707-58	2	White Bardiglio	9306-58	2
Burnished Iron	3709-58	2	Graystone	464-58	2	Patine Concrete	3706-58	2	White Drops	8824-58	2
Burnt Strand	6307-58	2	Green Felt	4974-58	2	Pearl	934-58	2	White Ice Granite	9476-58	2
Butterum Granite	7732-58	2	Green Slate	8793-58	2	Pecan Walnut	6996-58	2	White Marble	9310-58	2
Camel Elm	5795-58	2	Greige Softwood	4924-58	2	Pecan Woodline	5883-58	2	Herringbone		2
Cardboard Solidz	7813-58	2	Gull Grey	9242-58	2	Pencil Wood	7747-58	2	White Onyx	827-58	2
Carrara Bianco	6696-58	2	Hard Rock Maple	86992-58	2	Perlato Granite	3522-58	2	White Painted Wood	8902-58	2
Carrara Envision	7494-58	2	Hazel Walnut	5788-58	2	Planked Coffee Oak	7413-58	2	White Pearl Cascade	3720-58	2
Cascara Teakwood	8909-58	2	Ice Onyx	7408-58	2	Planked Deluxe Pear	6206-58	2	White Shalestone	9525-58	2
Cassis	6903-58	2	Inked Oak	5792-58	2	Planked Raw Oak	7412-58	2	White Twill	9285-58	2
Ceruse Gray Walnut	6994-58	2	Ivory Kashmir	6226-58	2	Planked Urban Oak	9312-58	2	White Washed	6372-58	2
Chambray Fabric	6130-58	2	Jadeite	1198-58	2	Platinum	902-58	2	Birchply		2
Charcoal Boomerang	6942-58	2	Jamocho Granite	7734-58	2	Portico Marble	7735-58	2	Wild Cherry	5904-58	2
Chelsea Maple	9238-58	2	Just Rose	8858-58	2	Prestige Walnut	6209-58	2	Winter Sky	8792-58	2
Cherry Heartwood	9240-58	2	Labrador Granite	3692-58	2	Pumice	858-58	2	Wood Brushstroke	6998-58	2
Cherry Walnut	6995-58	2	Layered Black Sand	9510-58	2	Purple Dye	1196-58	2	Woolen Cloth	8682-58	2
Chestnut Woodline	5884-58	2	Layered Sand	9511-58	2	Raw Birchply	8910-58	2	Yellow Felt	4972-58	2
Chrome Yellow	1485-58	2	Layered White Sand	9512-58	2	Raw Cedar	1545-58	2			
Cinnamon Cherry	8955-58	2	Lime Stone	7264-58	2	Sail White	463-58	2			
Citadel	1097-58	2	Liquid Glass	8240-58	2	Sand Crystal	3517-58	2			
Citadel Warp	5882-58	2	Luxe Mango	8685-58	2	Sand Maple	9237-58	2			
Classic White	9244-58	2	Macchiato Walnut	6932-58	2	Sarum Grey	2770-58	2			
Clementine	2962-58	2	Maple Woodline	6925-58	2	Sarum Twill	8827-58	2			
Clove Spice Cherry	5789-58	2	Marine Blue	914-58	2	Scandi Rift Oak	8677-58	2			
Cocoa Maple	7739-58	2	Marmara Beige	7406-58	2	Sea Salt	9529-58	2			
Cocoa Oak	9374-58	2	Marmara Gray	7407-58	2	Seasoned Planked Elm	6477-58	2			
Cognac Maple	7738-58	2	Matrix Blue	8795-58	2	Select Cherry	7759-58	2			
Concrete Formwood	6362-58	2	Mdf Solidz	7812-58	2	Sheer Fabric	6126-58	2			
Concrete Stone	7267-58	2	Midnight Stone	6280-58	2	Silver Quartzite	9497-58	2			
Cotton Cloth	8681-58	2	Milk	9634-58	2	Silver Riftwood	6413-58	2			
Cream Softwood	4923-58	2	Millennium Oak	5887-58	2	Silver Shalestone	9307-58	2			
Danish Maple	8906-58	2	Mineral Jet	3450-58	2	Slate Noir	3711-58	2			
			Mineral Spa	6920-58	2	Smoke	3245-58	2			

Wilsonart Laminate

Forge offers an extensive program for laminates beyond our Standard Program. Always reference below the most current listing and tier pricing when using a Graded-In Laminate; see below on the PVC edge color selection.

Laminate	Pattern-Sheen	Tier	Laminate	Pattern-Sheen	Tier	Laminate	Pattern-Sheen	Tier	Laminate	Pattern-Sheen	Tier
Almond Leather	2932-60	2	Florence Walnut	7993-38	2	Lowell Ash	7994-38	2	Port	D14-60	2
Anitque White	1572-60	2	Fonthill Pear	10745-60	2	Mangalore Mango	7984-38	2	Pressed Linen	4991-38	2
Anzio Marble	5037-38	2	Forged Steel	4995-60	2	Manitoba Maple	7911-60	2	Raw Cotton	4947-38	2
Atlantis	D25-60	2	Fossil Shale	D504-60	2	Midnight	D505-60	2	River Cherry	7937-38	2
Bannister Oak	7806-60	2	French Linen	5016-38	2	Mission Maple	7990-38	2	Rustic Slate	4888-38	2
Beige	1530-60	2	French Pear	8220-38	2	Misted Zephyr	4843-60	2	Sable Soapstone	4883-38	2
Beigewood	7850-60	2	Frosty White	1573-60	2	Monticello Maple	7925-38	2	Sap Walnut	8221-38	2
Boardwalk Oak	7983-38	2	Fusion Maple	7909-60	2	Morelia Maple	7985-38	2	Shadow Zephyr	4857-60	2
Brazilwood	7946-38	2	Graphite	10657-60	2	Morro Zephyr	4846-60	2	Sheer Mesh	4876-38	2
Brittany Blue	D321-60	2	Graphite Nebula	4623-60	2	Natural Almond	D30-60	2	Sierra Cascade	5005-38	2
Bronze Legacy	4656-60	2	Green Tigris	4667-60	2	Natural Cotton	4946-38	2	Silicon Ev	4811-60	2
Buka Bark	7982-38	2	Grey	1500-60	2	Natural Recon	7996-38	2	Solar Oak	7816-60	2
Burnished Chestnut	4796-60	2	Grey Glace	4142-60	2	Natural Rift	7954-38	2	Steel Mesh	4879-38	2
Candy Apple	13096-60	2	Grey Mesh	4877-38	2	Natural Tigris	4669-60	2	Sterling Ash	7995-38	2
Canyon Zephyr	4842-60	2	Grey Nebula	4622-60	2	Navy Legacy	4651-60	2	Sunny Side Up	13089-60	2
Carbon Ev	4820-60	2	Grey Pampas	4168-60	2	Neo Walnut	7991-38	2	Tailored Linen	4992-38	2
Carbon Mesh	4880-60	2	Gumball	13102-60	2	Neutral Glace	4143-60	2	Titanium EV	4810-60	2
Castle Oak	7928-38	2	Handspun Chestnut	5036-38	2	New Age Oak	7938-38	2	Tungsten EV	4814-60	2
Casual Linen	4944-38	2	Handspun Dove	5034-38	2	Nordic Linen	5015-38	2	Tuscan Walnut	7921-38	2
Catalina	13092-60	2	Handspun Pearl	5033-38	2	Nori	13091-60	2	Twilight Zephyr	4845-60	2
Cement	D503-60	2	Hanspun Slate	5035-38	2	North Sea	D90-60	2	Wallaby	D439-60	2
Centizo Cherry	8239-38	2	Harvest Maple	7953-38	2	Norwegian Ash	8241-38	2	Washi Crystal	5017-38	2
Classic Linen	4843-38	2	high Rise	4996-38	2	Oiled Soapstone	4882-38	2	Washi Pewter	5018-38	2
Cloud Nebula	4830-60	2	Hollyberry	D307-60	2	Orange Grove	D501-60	2	White	1570-60	2
Cloud Zephyr	4856-60	2	Huntington Mplae	7929-38	2	Organic Cotton	4945-38	2	White Carrara	4924-38	2
Coffee Bean	D495-60	2	Indigo	D379-60	2	Palisades Oak	7987-38	2	White Cascade	5003-38	2
Crisp Linen	4942-38	2	Invory Birch	8219-38	2	Pampas	4170-60	2	White Nebula	4621-60	2
Crystal	D388-60	2	Jubilee Oak	8242-38	2	Pasadena Oak	7966-38	2	White Sand	D403-60	2
Desert Zephyr	4841-60	2	Kensington Maple	10776-60	2	Pearl Soapstone	4886-38	2	White Tigris	4783-60	2
Dove Grey	D92-60	2	Khaki Brown	D50-60	2	Pepperdust	D327-60	2	Wild Cherry	7054-60	2
Dragon Fly	13088-60	2	Kingswood Walnut	8218-38	2	Pewter	D73-60	2	Windswept Pewter	4795-60	2
Ebony Recon	7997-38	2	Lapis Blue	D417-60	2	Pewter Brush	4779-60	2	Woolamai Brush	4746-60	2
Evening Tigris	4674-60	2	Limber Maple	10734-60	2	Pewter Mesh	4878-38	2			
Fashion Grey	D381-60	2	Linen	D427-60	2	Pinnacle Walnut	7992-38	2			
Flax Linen	4930-38	2	Loden Zephyr	4844-60	2	Platinum	D315-60	2			

PVC Edge Selection

Tier 2 and 3 Laminates require the additional specification of a PVC edge band. Choose from one of the following JSI standard options.

ALB	Alabaster	MES	Mesa
BEL	Belair	MIN	Mineral
BLK	Black	MCH	Mocha
BRK	Brickdust	OBK	Outback
BBL	Bridal Blanco	PIL	Pilsner
CSK	Cask	PIN	Pinnacle Walnut
CLY	Clay	SHD	Shadow
DWH	Designer White	SLG	Slate Grey
EGR	Egret	UMB	Umber
FAW	Fawn	VAL	Valley
FLN	Flint	WLH	Walnut Heights
FLO	Florence Walnut	WEA	Weathered Ash
LOF	Loft	ZEN	Zen Grey

Wilsonart Solid Surface

Forge offers an extensive program for Solid Surface beyond our Standard Program. Always reference below the most current listing and tier pricing when using a Graded-In Solid Surface.

Solid Surface	Pattern	Tier	Solid Surface	Pattern	Tier
Angel Falls	9223SS	3	Silver Smoke	9226SS	3
Antique White	1572SL	2	Steel Grey Tempest	9194TM	2
Arctic Drift	9246SS	3	Titanium Grey	9222SS	2
Arctic Dune	9253CM	3	Tumbled Stone	9220CE	3
Arctic Melange	9070ML	2	Whisper White	9237SS	3
Aspen Quartzite	9245SS	3	White Stone	9208CS	3
Avalanche Melange	9175ML	2	Whitewater	9198EA	3
Baja Melange	9030ML	2	Yukon Riverstone	9196RS	2
Basalt Concrete	9254SS	3	Zen Grey	9115GS	2
Beachfront	9233SS	2			
Beige Tempest	1530TM	2			
Beige Travertine	9236SS	3			
Bluestone	9074EA	3			
Brooklyn Concrete	9219GS	2			
Calacutta Perlato	9913SS	3			
Calming Waves	9240SS	3			
Cannon Beach	9250SS	2			
Caramel Melange	9033ML	2			
Carbone Marmo	9914SS	3			
Carrara Emporio	9909SS	3			
Cashmere Mirage	9135MG	2			
Chai Cream Mirage	9111MG	2			
Chicory Cream Melange	9047ML	2			
Chilled Earth	9228SS	2			
Cloud Mist	9243SS	3			
Coconut Oil	9100GS	2			
Cool Basalt	9251SS	2			
Cream Swirl	9242SS	3			
Dusk Ice	9203CE	3			
Europa	9210CM	3			
Flint Rock	9207CS	3			
French Blue Melange	9024ML	2			
Frosty White	1573SL	2			
Frosty White Mirage	1573MG	2			
Gold Glitz	9108CS	3			
Golden Sail	9234SS	3			
Grey Beola	9218CM	3			
Grey Lace	9224SS	3			
Gulf Coast	9239SS	3			
Hidden Space	9227SS	2			
Ice Statuario	9912SS	3			
Iron Falls	9238SS	3			
Jovian	9211CM	3			
Kimberlite	9215CE	3			
Luminous White	9221SP	2			
Mansoned Concrete	9252SS	3			
Maple Harvest	9106CS	3			
Marzipan Mirage	9130MG	2			
Metro Concrete	9249SS	2			
Midnight Frost	9244SS	3			
Midnight Melange	9091ML	2			
Milk Glass Spectra	9077ST	2			
Mink Concrete	9248SS	2			
Monte Amiata	9911SS	3			
Moon Geyser	9209CM	3			
Morning Ice	9204CE	3			
Mystique	9200CS	3			
Night Stars	9105CS	3			
Northern Melange	9195ML	2			
Oatmeal	9101GS	2			
Paris Fog	9110CS	3			
Peace Grey	9232SS	2			
Pearl Mirage	9199MG	2			
Pebble	9036EA	3			
Powder White	9230SS	2			
Quarry Melange	9041ML	2			
Quiet Swirl	9241SS	3			
Relaxed White	9247SS	2			
Saharan Night	9225SS	3			
Sea Stone	9202CS	3			

Corian Solid Surface

Forge offers an extensive program for Solid Surface beyond our Standard Program. Always reference below the most current listing and tier pricing when using a Graded-In Solid Surface.

Solid Surface	Pattern	Tier	Solid Surface	Pattern	Tier
Abalone	COR-ABA	3	Sahara	COR-SAH	4
Antarctica	COR-ANT	3	Sand Storm	COR-SST	4
Archeologic	COR-ARC	3	Sandalwood	COR-SDL	4
Arctic Ice	COR-AIC	4	Sandstone	COR-SAN	3
Arrowroot	COR-ARR	4	Savannah	COR-SAV	4
Artista Beige	COR-ABE	3	Sepia Linear	COR-SLI	4
Artista Canvas	COR-ACA	3	Serene Sage	COR-SSA	4
Artista Dust	COR-ADU	3	Silt	COR-SIL	3
Artista Gray	COR-AGR	3	Silver Birch	COR-SBI	4
Ash Aggregate	COR-AAG	4	Silver Gray	COR-SGR	2
Ash Concrete	COR-ACO	4	Silver Linear	COR-SLN	4
Aurora	COR-AUR	3	Silverite	COR-SLV	4
Bisque	COR-BIS	2	Smoke Drift Prima	COR-SDP	4
Bleached NuWood	COR-BNU	4	Sorrel	COR-SOR	4
Bone	COR-BON	2	Sparkling Granita	COR-SPG	4
Cameo White	COR-CWH	2	Sparkling White	COR-SWH	3
Canvas	COR-CNV	4	Stonique	COR-STO	3
Canyon	COR-CAN	3	Vanilla	COR-VAN	2
Carbon Aggregate	COR-CAG	4	Venaro White	COR-VWH	4
Carbon Concrete	COR-CCO	4	Verdant	COR-VER	4
Carrara Crema	COR-CCR	4	Weathered Aggregate	COR-WAG	4
Carrara Lino	COR-CLI	4	Weathered Concrete	COR-WCO	4
Cirrus White	COR-CIW	4	Whipped Cream	COR-WCR	4
Clam Shell	COR-CSH	4	Whisper	COR-WHI	4
Concrete	COR-CON	4	White Jasmine	COR-WJA	4
Cosmos Prima	COR-CPR	4	White Onyx	COR-WON	4
Deep Anthracite	COR-DAN	4	Willow	COR-WIL	4
Deep Black Quartz	COR-DBQ	4	Windswept Prima	COR-WPR	4
Deep Cloud	COR-DCL	4	Witch Hazel	COR-WHA	4
Deep Espresso	COR-DES	4			
Deep Mink	COR-DMI	4			
Deep Night Sky	COR-DNS	4			
Deep Nocturne	COR-DNO	4			
Deep Sable	COR-DSA	4			
Deep Storm	COR-DST	4			
Deep Titanium	COR-DTI	4			
Designer White	COR-DWH	3			
Doeskin	COR-DOE	4			
Domino Terrazzo	COR-DTE	4			
Dove	COR-DOV	3			
Dune Prima	COR-DPR	4			
Elegant Gray	COR-EGR	3			
Evening Prima	COR-EPR	4			
Everest	COR-EVE	3			
Excavage	COR-EXC	3			
Glacier Ice	COR-GIC	3			
Glacier White	COR-GWH	2			
Gray Onyx	COR-GON	4			
Hazelnut	COR-HAZ	4			
Hot	COR-HOT	4			
Juniper	COR-JUN	4			
Laguna	COR-LAG	4			
Laguna Terrazzo	COR-LTE	4			
Lava Rock	COR-LRO	4			
Limestone Prima	COR-LPR	4			
Linen	COR-LIN	2			
Matterhorn	COR-MAT	3			
Modern White	COR-MWH	3			
Natural Gray	COR-NGR	4			
Neutral Aggregate	COR-NAG	4			
Neutral Concrete	COR-NCO	3			
Nimbus Prima	COR-NPR	4			
Pearl Gray	COR-PGR	2			
Pebble Lane	COR-PLA	3			
Peppered Terrazzo	COR-PTE	4			
Platinum	COR-PAT	4			
Provence NuWood	COR-PNU	4			
Rain Cloud	COR-RCL	4			
Rice Paper	COR-RPA	4			
Rosemary	COR-ROS	4			
Sagebrush	COR-SAG	4			