

Knox Guest Quickship Order Check List:

Need it **NOW!**
JSI QUICKSHIP



Specify:

- 1. Model Number
- 2. Fabric Selection - vendor, pattern and color
- 3. Plastic Color or Wood Finish
- 4. Metal Frame - Arctic Silver (ASL) or Matte Black (MBK)

Example:

| | | | | | | |
|--------------------------------|-----------------------------------|------------------------------------|--------------------------------|-----------------------------|------------------------------|------------------------|
| QKN3001WUF (model #) | MAHARAM (fabric vendor) | MESSENGER (pattern name) | ONYX (pattern color) | ASL (metal color) | MA1 (wood species) | BAR (finish) |
|--------------------------------|-----------------------------------|------------------------------------|--------------------------------|-----------------------------|------------------------------|------------------------|

1. Model Number

2. Quickship Seating Fabric Selection - Please supply the following:
 Fabric vendor/Pattern name/Pattern color

[Please consult carded textiles on website for a list of colorways available on Quickship from each pattern](#)

3. Plastic Color or Wood Finish Options

Plastic Colors:

| | |
|------------------|-------------------|
| GRM Grey Matters | TBM Tricorn Black |
|------------------|-------------------|

Maple Wood Finish Options:

| | |
|---------------------|---------------------|
| BAR Barrel | MCH Mocha |
| BRK Brickdust | OBK Outback |
| BUF Buff | PIL Pilsner |
| CSK Cask | PIN Pinnacle Walnut |
| CND Cinder | RAV Raven |
| CLY Clay | RYE Rye |
| EGR Egret | SAB Sable |
| FAW Fawn | SAD Saddle |
| FLX Flax | SIE Sienna |
| FLN Flint | TRF Truffle |
| FLO Florence Walnut | UMB Umber |
| LOF Loft | VAL Valley |
| MES Mesa | WLH Walnut Heights |
| MIN Mineral | |

4. Metal Frame Colors:

| | |
|-------------------|-----------------|
| ASL Arctic Silver | MBK Matte Black |
|-------------------|-----------------|

Back Materials

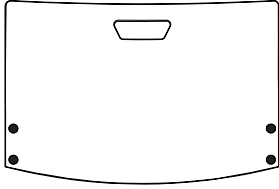

Plastic Back

Available Colors - [see pg SQS10](#)

Handle cut is standard

Front fasteners match frame back Screw caps match plastic color

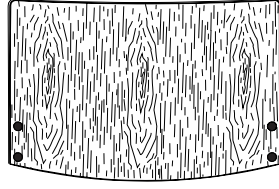

Maple Veneer Back

Handle cut is NOT available

Maple Finishes - [see pg SQS10](#)

Front fasteners and screw cap covers coordinate with frame on armless models; Front fasteners match frame and arms on arm models

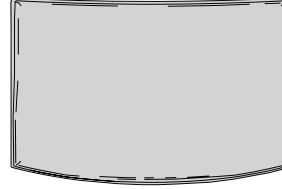

Upholstered Flex Back

Handle cut is NOT available

All fasteners are hidden.

Back Screw Cap Cover

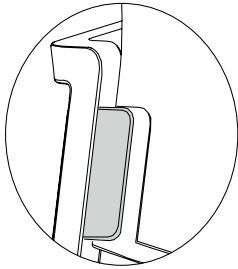

All chairs with plastic on wood backs have screw cap covers on the back side.

Upholstered multiply seating chairs have screw cap covers on the back side. All other upholstered chairs cover the hardware with the upholstery.

Seat Materials

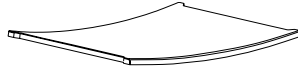

Plastic Seat

Available Colors - [see pg SQS10](#)

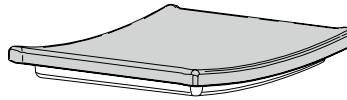

Upholstered Seat

Seat pan offers a recess to add additional comfort
Seat foam is molded with a high resilient foam

Multiple Fabrics

Units can be specified with a contrasting upholstery. When this feature is determined the unit **will be priced based on the highest grade fabric**. At the time of ordering identify the location of each textile according to the following code.

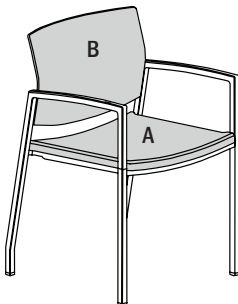

A = Seat
B = Back

Arms

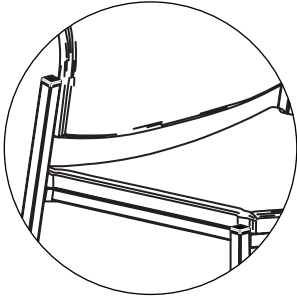

Armless

Available on guest seating

Armless style allows for linking

Tube cap matches the frame color

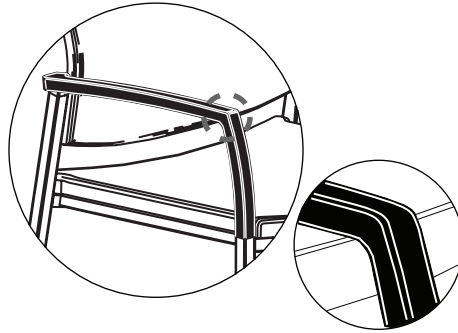

Flared Arms

Available on guest or swivel seating

Linking NOT available

Allows for stacking

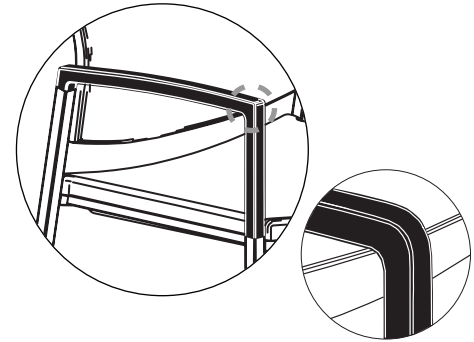

Straight Arm

Available on guest or swivel seating

Allows linking

Stacking NOT allowed

Specifications

Frame Construction

1. Tubular steel frame, 1⁷/₈" , 12 gauge fabricated welded frame.
2. Caster chair frames have a gusset for additional strength.
3. All guest frames have a clear neoprene bumper on the inside of the leg to protect finish when stacking.

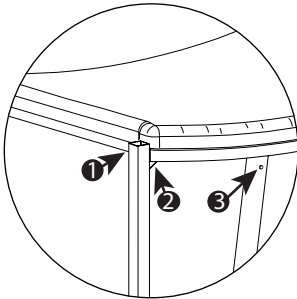

Casters

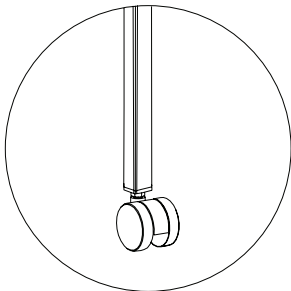

Guest chairs ending in a **C** are standard with a 50mm black nylon dual wheel caster.

Glides

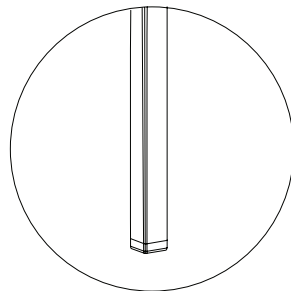

All other guest chairs are standard with nylon glides, color matched to frame.

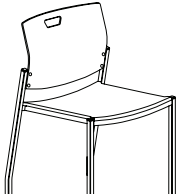
| Description | Model | Specifications | | | List Price Per Grade | |
|---|--|-------------------|----------|----------|----------------------|---|
| Armless Stack Chair  plastic seat | QKN3003PP - All Plastic QKN3003PU - Seat Uph. · stacks six high · linking bracket available, order separately, see page SQS21 · passes a 500 lb load rating test · wall saver | Dimensions | D | W | H | All Plastic \$497 A \$656 B \$675 C \$705 F \$847 |
| | | Overall | 21 ¼ | 21 ¼ | 32 | |
| | | Seat | 17 ¾ | 19 | 18 ½ | |
| | | Shipping | | | | |
| | | Ctn Wt | 15 | | | |
| | | Cu Ft | 11 | | | |

All Plastic Specify: Model | Plastic Color | Metal Frame Color

Seat Uph. Specify: Model | Seat Fabric Grade Selection | Plastic Color | Metal Frame Color

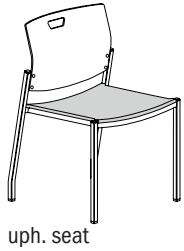

| | | | | | |
|--|-------------------|----------|----------|----------|---|
| QKN3003PP-3 - All Plastic QKN3003PU-3 - Seat Uph. · sets of 3 packaged together - must have all same options · stacks six high · linking bracket available, order separately, see page SQS21 · passes a 500 lb load rating test · wall saver | Dimensions | D | W | H | All Plastic \$1,279 A \$1,668 B \$1,703 C \$1,766 F \$2,047 |
| | Overall | 21 ¼ | 21 ¼ | 32 | |
| | Seat | 17 ¾ | 19 | 18 ½ | |
| | Shipping | | | | |
| | Ctn Wt | 41 | | | |
| | Cu Ft | 15 | | | |

All Plastic Specify: Model | Plastic Color | Metal Frame Color

Seat Uph. Specify: Model | Seat Fabric Grade Selection | Plastic Color | Metal Frame Color

Armless Stack Chair - Wood Back/Upholstered Seat

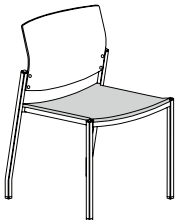

| | | | | | |
|--|-------------------|----------|----------|----------|--|
| QKN3003WU · stacks six high · standard maple veneer back available in maple finishes · linking bracket available, order separately, see page SQS21 · passes a 500 lb load rating test · wall saver | Dimensions | D | W | H | A \$868 B \$886 C \$916 F \$1,058 |
| | Overall | 21 ¼ | 21 ¼ | 32 | |
| | Seat | 17 ¾ | 19 | 18 ½ | |
| | Shipping | | | | |
| | Ctn Wt | 16 | | | |
| | Cu Ft | 11 | | | |

Specify: Model | Seat Fabric Grade Selection | Metal Frame Color | Maple Wood Species | Finish

| | | | | | |
|--|-------------------|----------|----------|----------|--|
| QKN3003WU-3 · sets of 3 packaged together - must have all same options · stacks six high · standard maple veneer back available in maple finishes · linking bracket available, order separately, see page SQS21 · passes a 500 lb load rating test · wall saver | Dimensions | D | W | H | A \$2,190 B \$2,225 C \$2,286 F \$2,570 |
| | Overall | 21 ¼ | 21 ¼ | 32 | |
| | Seat | 17 ¾ | 19 | 18 ½ | |
| | Shipping | | | | |
| | Ctn Wt | 44 | | | |
| | Cu Ft | 15 | | | |

Specify: Model | Seat Fabric Grade Selection | Metal Frame Color | Maple Wood Species | Finish

Description

① Model

Specifications

List Price Per Grade

Armless Stack Chair -
All Upholstered

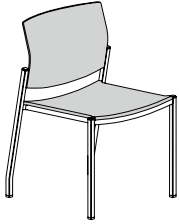

QKN3003UU

- stacks six high
- linking bracket available, order separately, see page [SQS21](#)
- passes a 500 lb load rating test
- wall saver

| Dimensions | D | W | H |
|------------|------|----------|------|
| Overall | 21 ¼ | 21 ¼ | 32 |
| Seat | 17 ¾ | 19 | 18 ½ |
| Upholstery | | Shipping | |
| COM Ydg | 1 ¼ | Ctn Wt | 17 |
| COL Sq Ft | 23 | Cu Ft | 11 |

| | |
|---|---------|
| A | \$799 |
| B | \$827 |
| C | \$881 |
| F | \$1,115 |

Specify: Model | Seat Fabric Grade Selection | Back Fabric Grade Selection | Highest Fabric Grade Selection | Metal Frame Color

QKN3003UU-3

- sets of 3 packaged together - must have all same options
- stacks six high
- linking bracket available, order separately, see page [SQS21](#)
- passes a 500 lb load rating test
- wall saver

| Dimensions | D | W | H |
|------------|------|----------|------|
| Overall | 21 ¼ | 21 ¼ | 32 |
| Seat | 17 ¾ | 19 | 18 ½ |
| Upholstery | | Shipping | |
| COM Ydg | 2 ¾ | Ctn Wt | 47 |
| COL Sq Ft | 50 | Cu Ft | 15 |

| | |
|---|---------|
| A | \$2,033 |
| B | \$2,097 |
| C | \$2,210 |
| F | \$2,727 |

Specify: Model | Seat Fabric Grade Selection | Back Fabric Grade Selection | Highest Fabric Grade Selection | Metal Frame Color

Armless Stack Chair with Casters

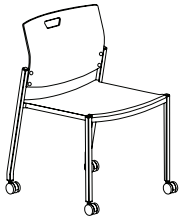

plastic seat

QKN3003PPC - All Plastic QKN3003PUC - Seat Uph.

- stacks six high
- wall saver

| Dimensions | D | W | H |
|------------|------|----------|------|
| Overall | 21 ¼ | 21 ¼ | 32 |
| Seat | 17 ¾ | 19 | 18 ½ |
| Upholstery | | Shipping | |
| COM Ydg | ¾ | Ctn Wt | 15 |
| COL Sq Ft | 14 | Cu Ft | 11 |

| | |
|-------------|-------|
| All Plastic | \$523 |
| A | \$688 |
| B | \$705 |
| C | \$736 |
| F | \$878 |

All Plastic Specify: Model | Plastic Color | Metal Frame Color

Seat Uph. Specify: Model | Seat Fabric Grade Selection | Plastic Color | Metal Frame Color

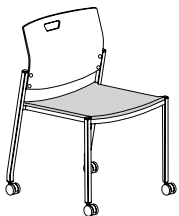

uph. seat

QKN3003PPC-3 - All Plastic QKN3003PUC-3 - Seat Uph.

- sets of 3 packaged together - must have all same options
- stacks six high
- wall saver

| Dimensions | D | W | H |
|------------|------|----------|------|
| Overall | 21 ¼ | 21 ¼ | 32 |
| Seat | 17 ¾ | 19 | 18 ½ |
| Upholstery | | Shipping | |
| COM Ydg | 1 ½ | Ctn Wt | 41 |
| COL Sq Ft | 27 | Cu Ft | 15 |

| | |
|-------------|---------|
| All Plastic | \$1,333 |
| A | \$1,721 |
| B | \$1,756 |
| C | \$1,819 |
| F | \$2,102 |

All Plastic Specify: Model | Plastic Color | Metal Frame Color

Seat Uph. Specify: Model | Seat Fabric Grade Selection | Plastic Color | Metal Frame Color

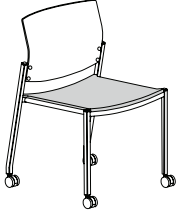
| Description | Model | Specifications | | | List Price Per Grade | | |
|---|--|-------------------|----------|----------|----------------------|---------|-----------|
| Armless Stack Chair with Casters - Wood Back/Upholstered Seat  | QKN3003WUC <ul style="list-style-type: none"> stacks six high standard maple veneer back available in maple finishes wall saver | Dimensions | D | W | H | A \$889 | |
| | | Overall | 21 ¼ | 21 ¼ | 32 | B \$908 | |
| | | Seat | 17 ¾ | 19 | 18 ½ | C \$937 | |
| | | Shipping | | | | | F \$1,080 |
| | | Ctn Wt | 16 | | | | |
| | | Cu Ft | 11 | | | | |

Specify: Model | Seat Fabric Grade Selection | Metal Frame Color | Maple Wood Species | Finish

| | | | | | | |
|--|-------------------|----------|----------|----------|-----------|-----------|
| QKN3003WUC-3 <ul style="list-style-type: none"> sets of 3 packaged together - must have all same options stacks six high standard maple veneer back available in maple finishes wall saver | Dimensions | D | W | H | A \$2,247 | |
| | Overall | 21 ¼ | 21 ¼ | 32 | B \$2,281 | |
| | Seat | 17 ¾ | 19 | 18 ½ | C \$2,344 | |
| | Shipping | | | | | F \$2,626 |
| | Ctn Wt | 44 | | | | |
| | Cu Ft | 15 | | | | |

Specify: Model | Seat Fabric Grade Selection | Metal Frame Color | Maple Wood Species | Finish

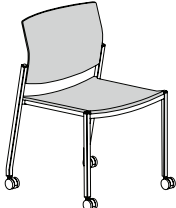
| | | | | | | | |
|--|--|-------------------|----------|----------|----------|---------|-----------|
| Armless Stack Chair with Casters - All Upholstered  | QKN3003UUC <ul style="list-style-type: none"> stacks six high wall saver | Dimensions | D | W | H | A \$802 | |
| | | Overall | 21 ¼ | 21 ¼ | 32 | B \$830 | |
| | | Seat | 17 ¾ | 19 | 18 ½ | C \$883 | |
| | | Shipping | | | | | F \$1,117 |
| | | Ctn Wt | 17 | | | | |
| | | Cu Ft | 11 | | | | |

Specify: Model | Seat Fabric Grade Selection | Back Fabric Grade Selection | Highest Fabric Grade Selection | Metal Frame Color

| | | | | | | |
|--|-------------------|----------|----------|----------|-----------|-----------|
| QKN3003UUC-3 <ul style="list-style-type: none"> sets of 3 packaged together - must have all same options stacks six high wall saver | Dimensions | D | W | H | A \$2,086 | |
| | Overall | 21 ¼ | 21 ¼ | 32 | B \$2,152 | |
| | Seat | 17 ¾ | 19 | 18 ½ | C \$2,264 | |
| | Shipping | | | | | F \$2,782 |
| | Ctn Wt | 47 | | | | |
| | Cu Ft | 15 | | | | |

Specify: Model | Seat Fabric Grade Selection | Back Fabric Grade Selection | Highest Fabric Grade Selection | Metal Frame Color

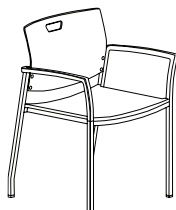
| Description | ① Model | Specifications | List Price Per Grade | | | | | | | | | | | | | | | | | | | | | | | | | | | | |
|---|---|--|----------------------|---|---|---|---------|------|------|----|------|------|------|------|-----|--|--|------|----------|--|--|--|--------|----|--|--|-------|----|--|--|---|
| Flared Arm Stack Chair  plastic seat | QKN3001PPF - All Plastic QKN3001PUF - Seat Uph. <ul style="list-style-type: none"> stacks six high passes a 500 lb load rating test wall saver | <table border="1"> <thead> <tr> <th>Dimensions</th> <th>D</th> <th>W</th> <th>H</th> </tr> </thead> <tbody> <tr> <td>Overall</td> <td>21 ¼</td> <td>24 ⅞</td> <td>32</td> </tr> <tr> <td>Seat</td> <td>17 ¾</td> <td>21 ½</td> <td>18 ½</td> </tr> <tr> <td>Arm</td> <td></td> <td></td> <td>26 ⅝</td> </tr> <tr> <th colspan="4">Shipping</th> </tr> <tr> <td>Ctn Wt</td> <td>16</td> <td></td> <td></td> </tr> <tr> <td>Cu Ft</td> <td>12</td> <td></td> <td></td> </tr> </tbody> </table> | Dimensions | D | W | H | Overall | 21 ¼ | 24 ⅞ | 32 | Seat | 17 ¾ | 21 ½ | 18 ½ | Arm | | | 26 ⅝ | Shipping | | | | Ctn Wt | 16 | | | Cu Ft | 12 | | | All Plastic \$592 A \$744 B \$761 C \$792 F \$934 |
| | | Dimensions | D | W | H | | | | | | | | | | | | | | | | | | | | | | | | | | |
| Overall | 21 ¼ | 24 ⅞ | 32 | | | | | | | | | | | | | | | | | | | | | | | | | | | | |
| Seat | 17 ¾ | 21 ½ | 18 ½ | | | | | | | | | | | | | | | | | | | | | | | | | | | | |
| Arm | | | 26 ⅝ | | | | | | | | | | | | | | | | | | | | | | | | | | | | |
| Shipping | | | | | | | | | | | | | | | | | | | | | | | | | | | | | | | |
| Ctn Wt | 16 | | | | | | | | | | | | | | | | | | | | | | | | | | | | | | |
| Cu Ft | 12 | | | | | | | | | | | | | | | | | | | | | | | | | | | | | | |

All Plastic Specify: Model | Plastic Color | Metal Frame Color

Seat Uph. Specify: Model | Seat Fabric Grade Selection | Plastic Color | Metal Frame Color

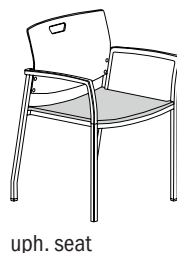

| QKN3001PPF-3 - All Plastic QKN3001PUF-3 - Seat Uph. <ul style="list-style-type: none"> sets of 3 packaged together - must have all same options stacks six high passes a 500 lb load rating test wall saver | <table border="1"> <thead> <tr> <th>Dimensions</th> <th>D</th> <th>W</th> <th>H</th> </tr> </thead> <tbody> <tr> <td>Overall</td> <td>21 ¼</td> <td>24 ⅞</td> <td>32</td> </tr> <tr> <td>Seat</td> <td>17 ¾</td> <td>21 ½</td> <td>18 ½</td> </tr> <tr> <td>Arm</td> <td></td> <td></td> <td>26 ⅝</td> </tr> <tr> <th colspan="4">Shipping</th> </tr> <tr> <td>Ctn Wt</td> <td>44</td> <td></td> <td></td> </tr> <tr> <td>Cu Ft</td> <td>16</td> <td></td> <td></td> </tr> </tbody> </table> | Dimensions | D | W | H | Overall | 21 ¼ | 24 ⅞ | 32 | Seat | 17 ¾ | 21 ½ | 18 ½ | Arm | | | 26 ⅝ | Shipping | | | | Ctn Wt | 44 | | | Cu Ft | 16 | | | All Plastic \$1,539 A \$1,930 B \$1,963 C \$2,025 F \$2,308 |
|---|--|------------|------|---|---|---------|------|------|----|------|------|------|------|-----|--|--|------|----------|--|--|--|--------|----|--|--|-------|----|--|--|---|
| | Dimensions | D | W | H | | | | | | | | | | | | | | | | | | | | | | | | | | |
| Overall | 21 ¼ | 24 ⅞ | 32 | | | | | | | | | | | | | | | | | | | | | | | | | | | |
| Seat | 17 ¾ | 21 ½ | 18 ½ | | | | | | | | | | | | | | | | | | | | | | | | | | | |
| Arm | | | 26 ⅝ | | | | | | | | | | | | | | | | | | | | | | | | | | | |
| Shipping | | | | | | | | | | | | | | | | | | | | | | | | | | | | | | |
| Ctn Wt | 44 | | | | | | | | | | | | | | | | | | | | | | | | | | | | | |
| Cu Ft | 16 | | | | | | | | | | | | | | | | | | | | | | | | | | | | | |

All Plastic Specify: Model | Plastic Color | Metal Frame Color

Seat Uph. Specify: Model | Seat Fabric Grade Selection | Plastic Color | Metal Frame Color

Flared Arm Stack Chair - Wood Back/Upholstered Seat

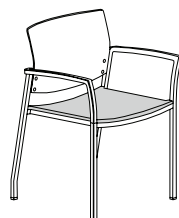

| QKN3001WUF <ul style="list-style-type: none"> stacks six high standard maple veneer back available in maple finishes nylon arms available in matte black passes a 500 lb load rating test wall saver | <table border="1"> <thead> <tr> <th>Dimensions</th> <th>D</th> <th>W</th> <th>H</th> </tr> </thead> <tbody> <tr> <td>Overall</td> <td>21 ¼</td> <td>24 ⅞</td> <td>32</td> </tr> <tr> <td>Seat</td> <td>17 ¾</td> <td>21 ½</td> <td>18 ½</td> </tr> <tr> <td>Arm</td> <td></td> <td></td> <td>26 ⅝</td> </tr> <tr> <th colspan="4">Shipping</th> </tr> <tr> <td>Ctn Wt</td> <td>16</td> <td></td> <td></td> </tr> <tr> <td>Cu Ft</td> <td>12</td> <td></td> <td></td> </tr> </tbody> </table> | Dimensions | D | W | H | Overall | 21 ¼ | 24 ⅞ | 32 | Seat | 17 ¾ | 21 ½ | 18 ½ | Arm | | | 26 ⅝ | Shipping | | | | Ctn Wt | 16 | | | Cu Ft | 12 | | | A \$961 B \$978 C \$1,009 F \$1,152 |
|---|--|------------|------|---|---|---------|------|------|----|------|------|------|------|-----|--|--|------|----------|--|--|--|--------|----|--|--|-------|----|--|--|--|
| | Dimensions | D | W | H | | | | | | | | | | | | | | | | | | | | | | | | | | |
| Overall | 21 ¼ | 24 ⅞ | 32 | | | | | | | | | | | | | | | | | | | | | | | | | | | |
| Seat | 17 ¾ | 21 ½ | 18 ½ | | | | | | | | | | | | | | | | | | | | | | | | | | | |
| Arm | | | 26 ⅝ | | | | | | | | | | | | | | | | | | | | | | | | | | | |
| Shipping | | | | | | | | | | | | | | | | | | | | | | | | | | | | | | |
| Ctn Wt | 16 | | | | | | | | | | | | | | | | | | | | | | | | | | | | | |
| Cu Ft | 12 | | | | | | | | | | | | | | | | | | | | | | | | | | | | | |

Specify: Model | Seat Fabric Grade Selection | Metal Frame Color | Maple Wood Finishes | Finish

| QKN3001WUF-3 <ul style="list-style-type: none"> sets of 3 packaged together - must have all same options stacks six high standard maple veneer back available in maple finishes nylon arms available in matte black passes a 500 lb load rating test wall saver | <table border="1"> <thead> <tr> <th>Dimensions</th> <th>D</th> <th>W</th> <th>H</th> </tr> </thead> <tbody> <tr> <td>Overall</td> <td>21 ¼</td> <td>24 ⅞</td> <td>32</td> </tr> <tr> <td>Seat</td> <td>17 ¾</td> <td>21 ½</td> <td>18 ½</td> </tr> <tr> <td>Arm</td> <td></td> <td></td> <td>26 ⅝</td> </tr> <tr> <th colspan="4">Shipping</th> </tr> <tr> <td>Ctn Wt</td> <td>44</td> <td></td> <td></td> </tr> <tr> <td>Cu Ft</td> <td>16</td> <td></td> <td></td> </tr> </tbody> </table> | Dimensions | D | W | H | Overall | 21 ¼ | 24 ⅞ | 32 | Seat | 17 ¾ | 21 ½ | 18 ½ | Arm | | | 26 ⅝ | Shipping | | | | Ctn Wt | 44 | | | Cu Ft | 16 | | | A \$2,428 B \$2,462 C \$2,524 F \$2,807 |
|---|--|------------|------|---|---|---------|------|------|----|------|------|------|------|-----|--|--|------|----------|--|--|--|--------|----|--|--|-------|----|--|--|--|
| | Dimensions | D | W | H | | | | | | | | | | | | | | | | | | | | | | | | | | |
| Overall | 21 ¼ | 24 ⅞ | 32 | | | | | | | | | | | | | | | | | | | | | | | | | | | |
| Seat | 17 ¾ | 21 ½ | 18 ½ | | | | | | | | | | | | | | | | | | | | | | | | | | | |
| Arm | | | 26 ⅝ | | | | | | | | | | | | | | | | | | | | | | | | | | | |
| Shipping | | | | | | | | | | | | | | | | | | | | | | | | | | | | | | |
| Ctn Wt | 44 | | | | | | | | | | | | | | | | | | | | | | | | | | | | | |
| Cu Ft | 16 | | | | | | | | | | | | | | | | | | | | | | | | | | | | | |

Specify: Model | Seat Fabric Grade Selection | Metal Frame Color | Maple Wood Finishes | Finish

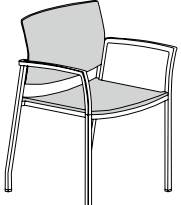
| Description | Model | Specifications | | | List Price Per Grade | |
|--|---|-------------------|----------|----------|----------------------|-----------|
| Flared Arm Stack Chair - All Upholstered  | QKN3001UUF · stacks six high · nylon arms available in matte black · passes a 500 lb load rating test · wall saver | Dimensions | D | W | H | A \$894 |
| | | Overall | 21 ¼ | 24 ½ | 32 | B \$922 |
| | | Seat | 17 ¾ | 21 ½ | 18 ½ | C \$974 |
| | | Arm | | | 26 ¾ | F \$1,210 |
| | | Shipping | | | | |
| | | Ctn Wt | 18 | | | |
| | | Cu Ft | 12 | | | |

Specify: Model | Seat Fabric Grade Selection | Back Fabric Grade Selection | Highest Fabric Grade Selection | Metal Frame Color

| | | | | | |
|---|-------------------|----------|----------|----------|-----------|
| QKN3001UUF-3 · sets of 3 packaged together - must have all same options · stacks six high · nylon arms available in matte black · passes a 500 lb load rating test · wall saver | Dimensions | D | W | H | A \$2,299 |
| | Overall | 21 ¼ | 24 ½ | 32 | B \$2,362 |
| | Seat | 17 ¾ | 21 ½ | 18 ½ | C \$2,476 |
| | Arm | | | 26 ¾ | F \$2,992 |
| | Shipping | | | | |
| | Ctn Wt | 50 | | | |
| | Cu Ft | 16 | | | |

Specify: Model | Seat Fabric Grade Selection | Back Fabric Grade Selection | Highest Fabric Grade Selection | Metal Frame Color

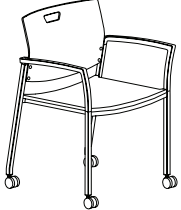
| Description | Model | Specifications | | | All Plastic | |
|---|---|-------------------|----------|----------|-------------|---------|
| Flared Arm Stack Chair with Casters  | QKN3001PPFC - All Plastic QKN3001PUFC - Seat Uph. · stacks six high · wall saver | Dimensions | D | W | H | \$614 |
| | | Overall | 21 ¼ | 24 ½ | 32 | A \$765 |
| | | Seat | 17 ¾ | 21 ½ | 18 ½ | B \$783 |
| | | Arm | | | 26 ¾ | C \$813 |
| | | Shipping | | | F \$956 | |
| | | Ctn Wt | 16 | | | |
| | | Cu Ft | 12 | | | |

plastic seat

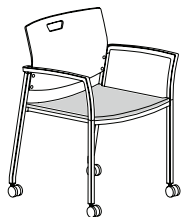

uph. seat

All Plastic Specify: Model | Plastic Color | Metal Frame Color

Seat Uph. Specify: Model | Seat Fabric Grade Selection | Plastic Color | Metal Frame Color

| | | | | | |
|---|-------------------|----------|----------|-----------|---------------------|
| QKN3001PPFC-3 - All Plastic QKN3001PUFC-3 - Seat Uph. · sets of 3 packaged together - must have all same options · stacks six high · wall saver | Dimensions | D | W | H | All Plastic \$1,592 |
| | Overall | 21 ¼ | 24 ½ | 32 | A \$1,983 |
| | Seat | 17 ¾ | 21 ½ | 18 ½ | B \$2,017 |
| | Arm | | | 26 ¾ | C \$2,079 |
| | Shipping | | | F \$2,361 | |
| | Ctn Wt | 44 | | | |
| | Cu Ft | 16 | | | |

All Plastic Specify: Model | Plastic Color | Metal Frame Color

Seat Uph. Specify: Model | Seat Fabric Grade Selection | Plastic Color | Metal Frame Color

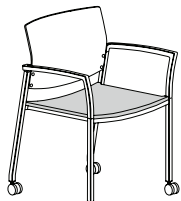
| Description | ① Model | Specifications | List Price Per Grade | | | | | | | | | | | | | | | | |
|---|---|--|----------------------|----|-------|----|---------|------|------|----|------|------|------|------|-----|--|--|------|--|
| Flared Arm Chair with Casters - Wood Back/Upholstered Seat  | QKN3001WUFC · stacks six high · standard maple veneer back available in maple finishes · wall saver | <table border="1"> <thead> <tr> <th>Dimensions</th> <th>D</th> <th>W</th> <th>H</th> </tr> </thead> <tbody> <tr> <td>Overall</td> <td>21 ¼</td> <td>24 ⅞</td> <td>32</td> </tr> <tr> <td>Seat</td> <td>17 ¾</td> <td>21 ½</td> <td>18 ½</td> </tr> <tr> <td>Arm</td> <td></td> <td></td> <td>26 ⅝</td> </tr> </tbody> </table> | Dimensions | D | W | H | Overall | 21 ¼ | 24 ⅞ | 32 | Seat | 17 ¾ | 21 ½ | 18 ½ | Arm | | | 26 ⅝ | A \$981 B \$998 C \$1,030 F \$1,170 |
| | | Dimensions | D | W | H | | | | | | | | | | | | | | |
| Overall | 21 ¼ | 24 ⅞ | 32 | | | | | | | | | | | | | | | | |
| Seat | 17 ¾ | 21 ½ | 18 ½ | | | | | | | | | | | | | | | | |
| Arm | | | 26 ⅝ | | | | | | | | | | | | | | | | |
| <table border="1"> <thead> <tr> <th colspan="2">Shipping</th> </tr> </thead> <tbody> <tr> <td>Ctn Wt</td> <td>16</td> </tr> <tr> <td>Cu Ft</td> <td>12</td> </tr> </tbody> </table> | Shipping | | Ctn Wt | 16 | Cu Ft | 12 | | | | | | | | | | | | | |
| Shipping | | | | | | | | | | | | | | | | | | | |
| Ctn Wt | 16 | | | | | | | | | | | | | | | | | | |
| Cu Ft | 12 | | | | | | | | | | | | | | | | | | |

Specify: Model | Seat Fabric Grade Selection | Metal Frame Color | Maple Wood Finishes | Finish

| QKN3001WUFC-3 · sets of 3 packaged together - must have all same options · stacks six high · standard maple veneer back available in maple finishes · wall saver | <table border="1"> <thead> <tr> <th>Dimensions</th> <th>D</th> <th>W</th> <th>H</th> </tr> </thead> <tbody> <tr> <td>Overall</td> <td>21 ¼</td> <td>24 ⅞</td> <td>32</td> </tr> <tr> <td>Seat</td> <td>17 ¾</td> <td>21 ½</td> <td>18 ½</td> </tr> <tr> <td>Arm</td> <td></td> <td></td> <td>26 ⅝</td> </tr> </tbody> </table> | Dimensions | D | W | H | Overall | 21 ¼ | 24 ⅞ | 32 | Seat | 17 ¾ | 21 ½ | 18 ½ | Arm | | | 26 ⅝ | A \$2,482 B \$2,518 C \$2,578 F \$2,862 |
|---|--|------------|--------|----|-------|---------|------|------|----|------|------|------|------|-----|--|--|------|--|
| | Dimensions | D | W | H | | | | | | | | | | | | | | |
| Overall | 21 ¼ | 24 ⅞ | 32 | | | | | | | | | | | | | | | |
| Seat | 17 ¾ | 21 ½ | 18 ½ | | | | | | | | | | | | | | | |
| Arm | | | 26 ⅝ | | | | | | | | | | | | | | | |
| <table border="1"> <thead> <tr> <th colspan="2">Shipping</th> </tr> </thead> <tbody> <tr> <td>Ctn Wt</td> <td>44</td> </tr> <tr> <td>Cu Ft</td> <td>16</td> </tr> </tbody> </table> | Shipping | | Ctn Wt | 44 | Cu Ft | 16 | | | | | | | | | | | | |
| Shipping | | | | | | | | | | | | | | | | | | |
| Ctn Wt | 44 | | | | | | | | | | | | | | | | | |
| Cu Ft | 16 | | | | | | | | | | | | | | | | | |

Specify: Model | Seat Fabric Grade Selection | Metal Frame Color | Maple Wood Finishes | Finish

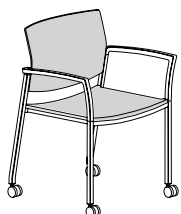
| Flared Arm Stack Chair with Casters - All Upholstered  | QKN3001UUFC · stacks six high · nylon arms available in matte black · wall saver | <table border="1"> <thead> <tr> <th>Dimensions</th> <th>D</th> <th>W</th> <th>H</th> </tr> </thead> <tbody> <tr> <td>Overall</td> <td>21 ¼</td> <td>24 ⅞</td> <td>32</td> </tr> <tr> <td>Seat</td> <td>17 ¾</td> <td>21 ½</td> <td>18 ½</td> </tr> <tr> <td>Arm</td> <td></td> <td></td> <td>26 ⅝</td> </tr> </tbody> </table> | Dimensions | D | W | H | Overall | 21 ¼ | 24 ⅞ | 32 | Seat | 17 ¾ | 21 ½ | 18 ½ | Arm | | | 26 ⅝ | A \$913 B \$940 C \$993 F \$1,227 |
|---|--|--|------------|----|-------|----|---------|------|------|----|------|------|------|------|-----|--|--|------|--|
| | | Dimensions | D | W | H | | | | | | | | | | | | | | |
| Overall | 21 ¼ | 24 ⅞ | 32 | | | | | | | | | | | | | | | | |
| Seat | 17 ¾ | 21 ½ | 18 ½ | | | | | | | | | | | | | | | | |
| Arm | | | 26 ⅝ | | | | | | | | | | | | | | | | |
| <table border="1"> <thead> <tr> <th colspan="2">Shipping</th> </tr> </thead> <tbody> <tr> <td>Ctn Wt</td> <td>18</td> </tr> <tr> <td>Cu Ft</td> <td>12</td> </tr> </tbody> </table> | Shipping | | Ctn Wt | 18 | Cu Ft | 12 | | | | | | | | | | | | | |
| Shipping | | | | | | | | | | | | | | | | | | | |
| Ctn Wt | 18 | | | | | | | | | | | | | | | | | | |
| Cu Ft | 12 | | | | | | | | | | | | | | | | | | |

Specify: Model | Seat Fabric Grade Selection | Back Fabric Grade Selection | Highest Fabric Grade Selection | Metal Frame Color

| QKN3001UUFC-3 · sets of 3 packaged together - must have all same options · stacks six high · wall saver | <table border="1"> <thead> <tr> <th>Dimensions</th> <th>D</th> <th>W</th> <th>H</th> </tr> </thead> <tbody> <tr> <td>Overall</td> <td>21 ¼</td> <td>24 ⅞</td> <td>32</td> </tr> <tr> <td>Seat</td> <td>17 ¾</td> <td>21 ½</td> <td>18 ½</td> </tr> <tr> <td>Arm</td> <td></td> <td></td> <td>26 ⅝</td> </tr> </tbody> </table> | Dimensions | D | W | H | Overall | 21 ¼ | 24 ⅞ | 32 | Seat | 17 ¾ | 21 ½ | 18 ½ | Arm | | | 26 ⅝ | A \$2,352 B \$2,417 C \$2,529 F \$3,047 |
|---|--|------------|--------|----|-------|---------|------|------|----|------|------|------|------|-----|--|--|------|--|
| | Dimensions | D | W | H | | | | | | | | | | | | | | |
| Overall | 21 ¼ | 24 ⅞ | 32 | | | | | | | | | | | | | | | |
| Seat | 17 ¾ | 21 ½ | 18 ½ | | | | | | | | | | | | | | | |
| Arm | | | 26 ⅝ | | | | | | | | | | | | | | | |
| <table border="1"> <thead> <tr> <th colspan="2">Shipping</th> </tr> </thead> <tbody> <tr> <td>Ctn Wt</td> <td>50</td> </tr> <tr> <td>Cu Ft</td> <td>16</td> </tr> </tbody> </table> | Shipping | | Ctn Wt | 50 | Cu Ft | 16 | | | | | | | | | | | | |
| Shipping | | | | | | | | | | | | | | | | | | |
| Ctn Wt | 50 | | | | | | | | | | | | | | | | | |
| Cu Ft | 16 | | | | | | | | | | | | | | | | | |

Specify: Model | Seat Fabric Grade Selection | Back Fabric Grade Selection | Highest Fabric Grade Selection | Metal Frame Color

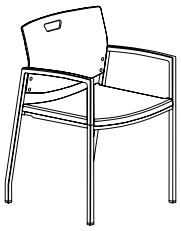
| Description | Model | Specifications | | | List Price Per Grade | |
|--|---|-------------------|----------|----------|----------------------|--------------------------|
| Straight Arm Chair  | QKN3001PPS - All Plastic QKN3001PUS - Seat Uph. · non-stacking · linking bracket available, order separately, see page SQS21 · passes a 500 lb load rating test · wall saver | Dimensions | D | W | H | All Plastic \$590 |
| | | Overall | 21 ¼ | 21 ¼ | 32 | A \$742 |
| | | Seat | 17 ¾ | 19 ¾ | 18 ½ | B \$760 |
| | | Arm | | | 26 ¾ | C \$791 |
| | | Shipping | | | | F \$932 |
| | | Ctn Wt | 16 | | | |
| | | Cu Ft | 11 | | | |

KN3001PPS
plastic seat

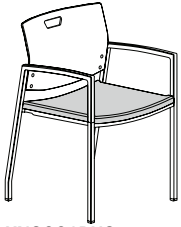

KN3001PUS
uph. seat

All Plastic Specify: Model | Plastic Color | Metal Frame Color

Seat Uph. Specify: Model | Seat Fabric Grade Selection | Plastic Color | Metal Frame Color

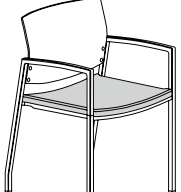
| Description | Model | Specifications | | | List Price Per Grade | |
|--|--|-------------------|----------|----------|----------------------|------------------|
| Straight Arm Chair - Wood Back/Upholstered Seat  | QKN3001WUS · non-stacking · standard maple veneer back available in maple finishes · linking bracket available, order separately, see page SQS21 · passes a 500 lb load rating test · wall saver | Dimensions | D | W | H | A \$959 |
| | | Overall | 21 ¼ | 21 ¼ | 32 | B \$976 |
| | | Seat | 17 ¾ | 19 ¾ | 18 ½ | C \$1,008 |
| | | Arm | | | 26 ¾ | F \$1,150 |
| | | Shipping | | | | |
| | | Ctn Wt | 17 | | | |
| | | Cu Ft | 11 | | | |

Straight Arm Chair - Wood Back/Upholstered Seat

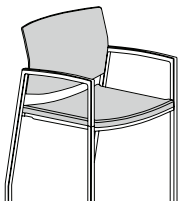

Specify: Model | Seat Fabric Grade Selection | Maple Wood Finishes | Finish | Metal Frame Color

| Description | Model | Specifications | | | List Price Per Grade | |
|--|--|-------------------|----------|----------|----------------------|------------------|
| Straight Arm Chair - All Upholstered  | QKN3001UUS · non-stacking · linking bracket available, order separately, see page SQS21 · passes a 500 lb load rating test · wall saver | Dimensions | D | W | H | A \$893 |
| | | Overall | 21 ¼ | 21 ¼ | 32 | B \$921 |
| | | Seat | 17 ¾ | 19 ¾ | 18 ½ | C \$973 |
| | | Arm | | | 26 ¾ | F \$1,208 |
| | | Shipping | | | | |
| | | Ctn Wt | 18 | | | |
| | | Cu Ft | 11 | | | |

Straight Arm Chair - All Upholstered

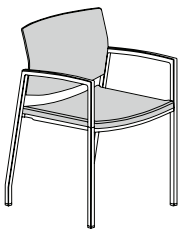

Specify: Model | Seat Fabric Grade Selection | Back Fabric Grade Selection | Highest Fabric Grade Selection | Metal Frame Color

| Description | ① Model | Specifications | List Price Per Grade | | | | | | | | | | | | | | | | | | | | | | | | | | | | |
|---|--|--|----------------------|---|---|---|---------|------|------|----|------|------|------|------|-----|--|--|------|----------|--|--|--|--------|----|--|--|-------|----|--|--|---|
| Straight Arm Chair with Casters  | QKN3001PPSC - All Plastic | <table border="1"> <thead> <tr> <th>Dimensions</th> <th>D</th> <th>W</th> <th>H</th> </tr> </thead> <tbody> <tr> <td>Overall</td> <td>21 ¼</td> <td>21 ¼</td> <td>32</td> </tr> <tr> <td>Seat</td> <td>17 ¾</td> <td>19 ¾</td> <td>18 ½</td> </tr> <tr> <td>Arm</td> <td></td> <td></td> <td>26 ⅝</td> </tr> <tr> <th colspan="4">Shipping</th> </tr> <tr> <td>Ctn Wt</td> <td>16</td> <td></td> <td></td> </tr> <tr> <td>Cu Ft</td> <td>11</td> <td></td> <td></td> </tr> </tbody> </table> | Dimensions | D | W | H | Overall | 21 ¼ | 21 ¼ | 32 | Seat | 17 ¾ | 19 ¾ | 18 ½ | Arm | | | 26 ⅝ | Shipping | | | | Ctn Wt | 16 | | | Cu Ft | 11 | | | All Plastic \$612 A \$763 B \$781 C \$812 F \$954 |
| | Dimensions | | D | W | H | | | | | | | | | | | | | | | | | | | | | | | | | | |
| Overall | 21 ¼ | 21 ¼ | 32 | | | | | | | | | | | | | | | | | | | | | | | | | | | | |
| Seat | 17 ¾ | 19 ¾ | 18 ½ | | | | | | | | | | | | | | | | | | | | | | | | | | | | |
| Arm | | | 26 ⅝ | | | | | | | | | | | | | | | | | | | | | | | | | | | | |
| Shipping | | | | | | | | | | | | | | | | | | | | | | | | | | | | | | | |
| Ctn Wt | 16 | | | | | | | | | | | | | | | | | | | | | | | | | | | | | | |
| Cu Ft | 11 | | | | | | | | | | | | | | | | | | | | | | | | | | | | | | |
| KN3001PPSC plastic seat | QKN3001PUSC - Seat Uph. · non-stacking · wall saver | | | | | | | | | | | | | | | | | | | | | | | | | | | | | | |

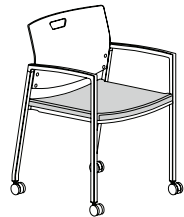

KN3001PUSC
uph. seat

All Plastic Specify: Model | Plastic Color | Metal Frame Color

Seat Uph. Specify: Model | Seat Fabric Grade Selection | Plastic Color | Metal Frame Color

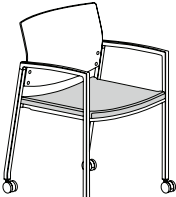
| Straight Arm Chair with Casters - Wood Back/Upholstered Seat  | QKN3001WUSC | <table border="1"> <thead> <tr> <th>Dimensions</th> <th>D</th> <th>W</th> <th>H</th> </tr> </thead> <tbody> <tr> <td>Overall</td> <td>21 ¼</td> <td>21 ¼</td> <td>32</td> </tr> <tr> <td>Seat</td> <td>17 ¾</td> <td>19 ¾</td> <td>18 ½</td> </tr> <tr> <td>Arm</td> <td></td> <td></td> <td>26 ⅝</td> </tr> <tr> <th colspan="4">Shipping</th> </tr> <tr> <td>Ctn Wt</td> <td>17</td> <td></td> <td></td> </tr> <tr> <td>Cu Ft</td> <td>11</td> <td></td> <td></td> </tr> </tbody> </table> | Dimensions | D | W | H | Overall | 21 ¼ | 21 ¼ | 32 | Seat | 17 ¾ | 19 ¾ | 18 ½ | Arm | | | 26 ⅝ | Shipping | | | | Ctn Wt | 17 | | | Cu Ft | 11 | | | A \$993 B \$1,010 C \$1,041 F \$1,183 |
|--|--|--|------------|---|---|---|---------|------|------|----|------|------|------|------|-----|--|--|------|----------|--|--|--|--------|----|--|--|-------|----|--|--|--|
| | Dimensions | | D | W | H | | | | | | | | | | | | | | | | | | | | | | | | | | |
| Overall | 21 ¼ | 21 ¼ | 32 | | | | | | | | | | | | | | | | | | | | | | | | | | | | |
| Seat | 17 ¾ | 19 ¾ | 18 ½ | | | | | | | | | | | | | | | | | | | | | | | | | | | | |
| Arm | | | 26 ⅝ | | | | | | | | | | | | | | | | | | | | | | | | | | | | |
| Shipping | | | | | | | | | | | | | | | | | | | | | | | | | | | | | | | |
| Ctn Wt | 17 | | | | | | | | | | | | | | | | | | | | | | | | | | | | | | |
| Cu Ft | 11 | | | | | | | | | | | | | | | | | | | | | | | | | | | | | | |
| | · non-stacking · standard maple veneer back available in maple finishes · wall saver | | | | | | | | | | | | | | | | | | | | | | | | | | | | | | |

Specify: Model | Seat Fabric Grade Selection | Maple Wood Finishes | Finish | Metal Frame Color

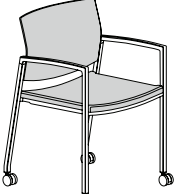
| Straight Arm Chair with Casters - All Upholstered  | QKN3001UUSC | <table border="1"> <thead> <tr> <th>Dimensions</th> <th>D</th> <th>W</th> <th>H</th> </tr> </thead> <tbody> <tr> <td>Overall</td> <td>21 ¼</td> <td>21 ¼</td> <td>32</td> </tr> <tr> <td>Seat</td> <td>17 ¾</td> <td>19 ¾</td> <td>18 ½</td> </tr> <tr> <td>Arm</td> <td></td> <td></td> <td>26 ⅝</td> </tr> <tr> <th colspan="4">Shipping</th> </tr> <tr> <td>Ctn Wt</td> <td>18</td> <td></td> <td></td> </tr> <tr> <td>Cu Ft</td> <td>11</td> <td></td> <td></td> </tr> </tbody> </table> | Dimensions | D | W | H | Overall | 21 ¼ | 21 ¼ | 32 | Seat | 17 ¾ | 19 ¾ | 18 ½ | Arm | | | 26 ⅝ | Shipping | | | | Ctn Wt | 18 | | | Cu Ft | 11 | | | A \$914 B \$941 C \$994 F \$1,228 |
|--|--------------------------------|--|------------|---|---|---|---------|------|------|----|------|------|------|------|-----|--|--|------|----------|--|--|--|--------|----|--|--|-------|----|--|--|--|
| | Dimensions | | D | W | H | | | | | | | | | | | | | | | | | | | | | | | | | | |
| Overall | 21 ¼ | 21 ¼ | 32 | | | | | | | | | | | | | | | | | | | | | | | | | | | | |
| Seat | 17 ¾ | 19 ¾ | 18 ½ | | | | | | | | | | | | | | | | | | | | | | | | | | | | |
| Arm | | | 26 ⅝ | | | | | | | | | | | | | | | | | | | | | | | | | | | | |
| Shipping | | | | | | | | | | | | | | | | | | | | | | | | | | | | | | | |
| Ctn Wt | 18 | | | | | | | | | | | | | | | | | | | | | | | | | | | | | | |
| Cu Ft | 11 | | | | | | | | | | | | | | | | | | | | | | | | | | | | | | |
| | · non-stacking · wall saver | | | | | | | | | | | | | | | | | | | | | | | | | | | | | | |

Specify: Model | Seat Fabric Grade Selection | Back Fabric Grade Selection | Highest Fabric Grade Selection | Metal Frame Color

| Description | D | W | H | CTN WT | CU FT | ① Model | List Price |
|----------------|----|------|------|-----------|----------|---------|------------|
| Transport Cart | 34 | 23 ¾ | 40 ¾ | 29 | 22 | QTC01 | \$981 |



- 16 gauge steel tube
- 4" heavy duty casters
- only available in black
- stacks six armless or flared single chairs

Specify: Model

| | | | | | | | |
|-----------------|--|--|--|---|---|-----------|------|
| Linking Bracket | | | | 1 | 1 | QKN30BRKT | \$68 |
|-----------------|--|--|--|---|---|-----------|------|

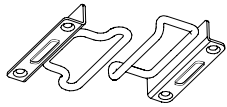

- matte black wire loop ganging bracket set

Specify: Model

Knox Swivel Quickship Order Check List:



Specify:

- 1. Model Number
- 2. Fabric Selection - vendor, pattern and color
- 3. Plastic Color or Wood Finish Back
- 4. Metal Frame - Arctic Silver (ASL) or Matte Black (MBK)

Example:

QKN3000WUS | **MOMENTUM** | **Silica Leather** | **Almond** | **ASL**
 (model #) | (fabric vendor) | (pattern name) | (pattern color) | (metal color)

1. Model Number

2. Quickship Seating Fabric Selection - Please supply the following:

Fabric vendor/Pattern name/Pattern color

[Please consult carded textiles on website for a list of colorways available on Quickship from each pattern](#)

3. Plastic Color or Wood Finish Options

Plastic Colors:

GRM Grey Matters TBM Tricorn Black

Maple Wood Species Options:

| | |
|---------------------|---------------------|
| BAR Barrel | MCH Mocha |
| BRK Brickdust | OBK Outback |
| BUF Buff | PIL Pilsner |
| CSK Cask | PIN Pinnacle Walnut |
| CND Cinder | RAV Raven |
| CLY Clay | RYE Rye |
| EGR Egret | SAB Sable |
| FAW Fawn | SAD Saddle |
| FLX Flax | SIE Sienna |
| FLN Flint | TRF Truffle |
| FLO Florence Walnut | UMB Umber |
| LOF Loft | VAL Valley |
| MES Mesa | WLH Walnut Heights |
| MIN Mineral | |

4. Metal Frame Colors:

ASL Arctic Silver MBK Matte Black

Back Materials

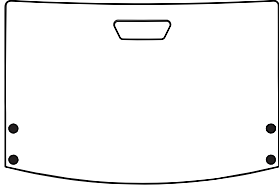

Plastic Back

Available Colors - [see pg SQS22](#)

Handle cut is standard

Front fasteners match frame back Screw caps match plastic color

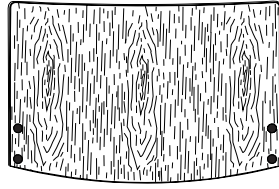

Maple Veneer Back

Maple Finishes - [see pg SQS22](#)

Front fasteners and screw cap covers coordinate with frame on armless models; Front fasteners match frame and arms on arm models

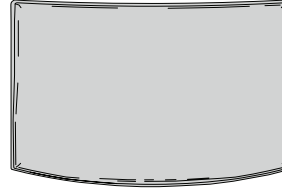

Upholstered Flex Back

Handle cut is NOT available

All fasteners are hidden.

Seat Materials



Plastic Seat

Available Colors - [see pg SQS22](#)

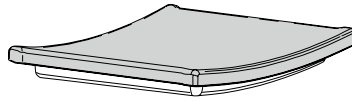

Upholstered Seat



Seat pan offers a recess to add additional comfort
Seat foam is molded with a high resilient foam

Multiple Fabrics

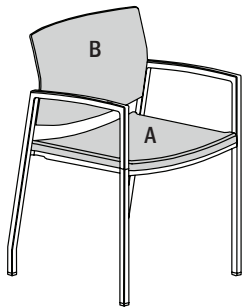
Units can be specified with a contrasting upholstery. When this feature is determined the unit **will be priced based on the highest grade fabric**. At the time of ordering identify the location of each textile according to the following code.



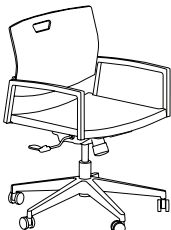

A = Seat
B = Back

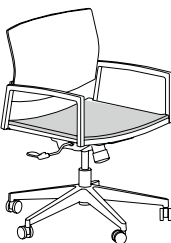
| Description | ① Model | Specifications | List Price Per Grade | | | | | | | | | | | | | | | | |
|---|--|--|----------------------|----|-------|----|---------|--------|--------|--------|------|--------|--------|--------|-----|--|--|--------|---|
| Straight Arm Swivel Chair  KN3000PPS plastic seat | QKN3000PPS - All Plastic QKN3000PUS - Seat Uph. <ul style="list-style-type: none"> standard black nylon base with hard tread dual casters overall height range 31 1/2" - 36 3/4" seat height range 16 1/2" - 22 1/4" arm height range 30 3/8" - 24 5/8" | <table border="1"> <thead> <tr> <th>Dimensions</th> <th>D</th> <th>W</th> <th>H</th> </tr> </thead> <tbody> <tr> <td>Overall</td> <td>28 1/2</td> <td>28 1/2</td> <td>36 3/4</td> </tr> <tr> <td>Seat</td> <td>17 3/8</td> <td>19 3/8</td> <td>22 1/4</td> </tr> <tr> <td>Arm</td> <td></td> <td></td> <td>30 3/8</td> </tr> </tbody> </table> | Dimensions | D | W | H | Overall | 28 1/2 | 28 1/2 | 36 3/4 | Seat | 17 3/8 | 19 3/8 | 22 1/4 | Arm | | | 30 3/8 | All Plastic \$839 A \$996 B \$1,014 C \$1,045 F \$1,186 |
| | | Dimensions | D | W | H | | | | | | | | | | | | | | |
| Overall | 28 1/2 | 28 1/2 | 36 3/4 | | | | | | | | | | | | | | | | |
| Seat | 17 3/8 | 19 3/8 | 22 1/4 | | | | | | | | | | | | | | | | |
| Arm | | | 30 3/8 | | | | | | | | | | | | | | | | |
| <table border="1"> <thead> <tr> <th colspan="2">Shipping</th> </tr> </thead> <tbody> <tr> <td>Ctn Wt</td> <td>30</td> </tr> <tr> <td>Cu Ft</td> <td>20</td> </tr> </tbody> </table> | Shipping | | Ctn Wt | 30 | Cu Ft | 20 | | | | | | | | | | | | | |
| Shipping | | | | | | | | | | | | | | | | | | | |
| Ctn Wt | 30 | | | | | | | | | | | | | | | | | | |
| Cu Ft | 20 | | | | | | | | | | | | | | | | | | |
|  KN3000PUS uph. seat | All Plastic Specify: Model Plastic Color Metal Frame Color Seat Uph. Specify: Model Seat Fabric Grade Selection Plastic Color Metal Frame Color | | | | | | | | | | | | | | | | | | |

| Straight Arm Swivel Chair - Wood Back/Upholstered Seat  | QKN3000WUS <ul style="list-style-type: none"> standard black nylon base with hard tread dual casters standard maple veneer back available in maple finishes overall height range 31 1/2" - 36 3/4" seat height range 16 1/2" - 22 1/4" arm height range 30 3/8" - 24 5/8" | <table border="1"> <thead> <tr> <th>Dimensions</th> <th>D</th> <th>W</th> <th>H</th> </tr> </thead> <tbody> <tr> <td>Overall</td> <td>28 1/2</td> <td>28 1/2</td> <td>36 3/4</td> </tr> <tr> <td>Seat</td> <td>17 3/8</td> <td>19 3/8</td> <td>22 1/4</td> </tr> <tr> <td>Arm</td> <td></td> <td></td> <td>30 3/8</td> </tr> </tbody> </table> | Dimensions | D | W | H | Overall | 28 1/2 | 28 1/2 | 36 3/4 | Seat | 17 3/8 | 19 3/8 | 22 1/4 | Arm | | | 30 3/8 | A \$1,213 B \$1,232 C \$1,262 F \$1,404 |
|---|---|--|------------|----|-------|----|---------|--------|--------|--------|------|--------|--------|--------|-----|--|--|--------|--|
| | | Dimensions | D | W | H | | | | | | | | | | | | | | |
| Overall | 28 1/2 | 28 1/2 | 36 3/4 | | | | | | | | | | | | | | | | |
| Seat | 17 3/8 | 19 3/8 | 22 1/4 | | | | | | | | | | | | | | | | |
| Arm | | | 30 3/8 | | | | | | | | | | | | | | | | |
| <table border="1"> <thead> <tr> <th colspan="2">Shipping</th> </tr> </thead> <tbody> <tr> <td>Ctn Wt</td> <td>30</td> </tr> <tr> <td>Cu Ft</td> <td>20</td> </tr> </tbody> </table> | Shipping | | Ctn Wt | 30 | Cu Ft | 20 | | | | | | | | | | | | | |
| Shipping | | | | | | | | | | | | | | | | | | | |
| Ctn Wt | 30 | | | | | | | | | | | | | | | | | | |
| Cu Ft | 20 | | | | | | | | | | | | | | | | | | |
| | Specify: Model Seat Fabric Grade Selection Maple Wood Finishes Metal Frame Color | | | | | | | | | | | | | | | | | | |

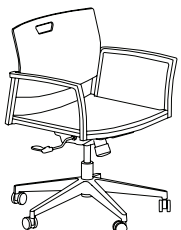
| Straight Arm Swivel Chair - All Upholstered  | QKN3000UUS <ul style="list-style-type: none"> standard black nylon base with hard tread dual casters multiple fabrics, see page SQS23 overall height range 31 1/2" - 36 3/4" seat height range 16 1/2" - 22 1/4" arm height range 30 3/8" - 24 5/8" | <table border="1"> <thead> <tr> <th>Dimensions</th> <th>D</th> <th>W</th> <th>H</th> </tr> </thead> <tbody> <tr> <td>Overall</td> <td>28 1/2</td> <td>28 1/2</td> <td>36 3/4</td> </tr> <tr> <td>Seat</td> <td>17 3/8</td> <td>19 3/8</td> <td>22 1/4</td> </tr> <tr> <td>Arm</td> <td></td> <td></td> <td>30 3/8</td> </tr> </tbody> </table> | Dimensions | D | W | H | Overall | 28 1/2 | 28 1/2 | 36 3/4 | Seat | 17 3/8 | 19 3/8 | 22 1/4 | Arm | | | 30 3/8 | A \$1,146 B \$1,175 C \$1,227 F \$1,461 |
|---|---|--|------------|----|-------|----|---------|--------|--------|--------|------|--------|--------|--------|-----|--|--|--------|--|
| | | Dimensions | D | W | H | | | | | | | | | | | | | | |
| Overall | 28 1/2 | 28 1/2 | 36 3/4 | | | | | | | | | | | | | | | | |
| Seat | 17 3/8 | 19 3/8 | 22 1/4 | | | | | | | | | | | | | | | | |
| Arm | | | 30 3/8 | | | | | | | | | | | | | | | | |
| <table border="1"> <thead> <tr> <th colspan="2">Shipping</th> </tr> </thead> <tbody> <tr> <td>Ctn Wt</td> <td>31</td> </tr> <tr> <td>Cu Ft</td> <td>20</td> </tr> </tbody> </table> | Shipping | | Ctn Wt | 31 | Cu Ft | 20 | | | | | | | | | | | | | |
| Shipping | | | | | | | | | | | | | | | | | | | |
| Ctn Wt | 31 | | | | | | | | | | | | | | | | | | |
| Cu Ft | 20 | | | | | | | | | | | | | | | | | | |
| | Specify: Model Seat Fabric Grade Selection Back Fabric Grade Selection Highest Fabric Grade Selection Metal Frame Color | | | | | | | | | | | | | | | | | | |

| Description | Model | Specifications | List Price Per Grade | | | | | | | | | | | | | | | | | | | | | | |
|---|---|--|----------------------|---|---|---|---------|--------|--------|--------|------|--------|--------|--------|-----|--|--|--------|---|----------|--|--------|----|-------|----|
| Flared Arm Swivel Chair  KN3000PPF plastic seat | QKN3000PPF - All Plastic QKN3000PUF - Seat Uph. • standard black nylon base with hard tread dual casters • overall height range 31 1/2" - 36 3/4" • seat height range 16 1/2" - 22 1/4" • arm height range 30 3/8" - 24 5/8" | <table border="1"> <thead> <tr> <th>Dimensions</th> <th>D</th> <th>W</th> <th>H</th> </tr> </thead> <tbody> <tr> <td>Overall</td> <td>28 1/2</td> <td>28 1/2</td> <td>36 3/4</td> </tr> <tr> <td>Seat</td> <td>17 3/8</td> <td>21 1/2</td> <td>22 1/4</td> </tr> <tr> <td>Arm</td> <td></td> <td></td> <td>30 3/8</td> </tr> </tbody> </table> | Dimensions | D | W | H | Overall | 28 1/2 | 28 1/2 | 36 3/4 | Seat | 17 3/8 | 21 1/2 | 22 1/4 | Arm | | | 30 3/8 | <table border="1"> <thead> <tr> <th colspan="2">Shipping</th> </tr> </thead> <tbody> <tr> <td>Ctn Wt</td> <td>30</td> </tr> <tr> <td>Cu Ft</td> <td>20</td> </tr> </tbody> </table> | Shipping | | Ctn Wt | 30 | Cu Ft | 20 |
| | | Dimensions | D | W | H | | | | | | | | | | | | | | | | | | | | |
| Overall | 28 1/2 | 28 1/2 | 36 3/4 | | | | | | | | | | | | | | | | | | | | | | |
| Seat | 17 3/8 | 21 1/2 | 22 1/4 | | | | | | | | | | | | | | | | | | | | | | |
| Arm | | | 30 3/8 | | | | | | | | | | | | | | | | | | | | | | |
| Shipping | | | | | | | | | | | | | | | | | | | | | | | | | |
| Ctn Wt | 30 | | | | | | | | | | | | | | | | | | | | | | | | |
| Cu Ft | 20 | | | | | | | | | | | | | | | | | | | | | | | | |
|  KN3000PUF uph. seat | All Plastic Specify: Model Plastic Color Metal Frame Color Seat Uph. Specify: Model Seat Fabric Grade Selection Plastic Color Metal Frame Color | | | | | | | | | | | | | | | | | | | | | | | | |

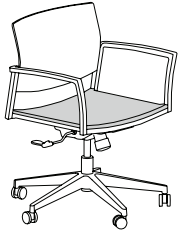
| Flared Arm Swivel Chair - Wood Back/Upholstered Seat  | QKN3000WUF • standard black nylon base with hard tread dual casters • standard maple veneer back available in maple finishes • overall height range 31 1/2" - 36 3/4" • seat height range 16 1/2" - 22 1/4" • arm height range 30 3/8" - 24 5/8" | <table border="1"> <thead> <tr> <th>Dimensions</th> <th>D</th> <th>W</th> <th>H</th> </tr> </thead> <tbody> <tr> <td>Overall</td> <td>28 1/2</td> <td>28 1/2</td> <td>36 3/4</td> </tr> <tr> <td>Seat</td> <td>17 3/8</td> <td>21 1/2</td> <td>22 1/4</td> </tr> <tr> <td>Arm</td> <td></td> <td></td> <td>30 3/8</td> </tr> </tbody> </table> | Dimensions | D | W | H | Overall | 28 1/2 | 28 1/2 | 36 3/4 | Seat | 17 3/8 | 21 1/2 | 22 1/4 | Arm | | | 30 3/8 | <table border="1"> <thead> <tr> <th colspan="2">Shipping</th> </tr> </thead> <tbody> <tr> <td>Ctn Wt</td> <td>30</td> </tr> <tr> <td>Cu Ft</td> <td>20</td> </tr> </tbody> </table> | Shipping | | Ctn Wt | 30 | Cu Ft | 20 |
|---|--|--|------------|---|---|---|---------|--------|--------|--------|------|--------|--------|--------|-----|--|--|--------|---|----------|--|--------|----|-------|----|
| | | Dimensions | D | W | H | | | | | | | | | | | | | | | | | | | | |
| Overall | 28 1/2 | 28 1/2 | 36 3/4 | | | | | | | | | | | | | | | | | | | | | | |
| Seat | 17 3/8 | 21 1/2 | 22 1/4 | | | | | | | | | | | | | | | | | | | | | | |
| Arm | | | 30 3/8 | | | | | | | | | | | | | | | | | | | | | | |
| Shipping | | | | | | | | | | | | | | | | | | | | | | | | | |
| Ctn Wt | 30 | | | | | | | | | | | | | | | | | | | | | | | | |
| Cu Ft | 20 | | | | | | | | | | | | | | | | | | | | | | | | |
| | Specify: Model Seat Fabric Grade Selection Maple Wood Finishes Finish Metal Frame Color | | | | | | | | | | | | | | | | | | | | | | | | |

| Flared Arm Swivel Chair - All Upholstered.  | QKN3000UUF • standard black nylon base with hard tread dual casters • multiple fabrics, see page SQS23 • overall height range 31 1/2" - 36 3/4" • seat height range 16 1/2" - 22 1/4" • arm height range 30 3/8" - 24 5/8" | <table border="1"> <thead> <tr> <th>Dimensions</th> <th>D</th> <th>W</th> <th>H</th> </tr> </thead> <tbody> <tr> <td>Overall</td> <td>58 1/2</td> <td>28 1/2</td> <td>36 3/4</td> </tr> <tr> <td>Seat</td> <td>17 3/8</td> <td>21 1/2</td> <td>22 1/4</td> </tr> <tr> <td>Arm</td> <td></td> <td></td> <td>30 3/8</td> </tr> </tbody> </table> | Dimensions | D | W | H | Overall | 58 1/2 | 28 1/2 | 36 3/4 | Seat | 17 3/8 | 21 1/2 | 22 1/4 | Arm | | | 30 3/8 | <table border="1"> <thead> <tr> <th colspan="2">Shipping</th> </tr> </thead> <tbody> <tr> <td>Ctn Wt</td> <td>31</td> </tr> <tr> <td>Cu Ft</td> <td>20</td> </tr> </tbody> </table> | Shipping | | Ctn Wt | 31 | Cu Ft | 20 |
|--|--|--|------------|---|---|---|---------|--------|--------|--------|------|--------|--------|--------|-----|--|--|--------|---|----------|--|--------|----|-------|----|
| | | Dimensions | D | W | H | | | | | | | | | | | | | | | | | | | | |
| Overall | 58 1/2 | 28 1/2 | 36 3/4 | | | | | | | | | | | | | | | | | | | | | | |
| Seat | 17 3/8 | 21 1/2 | 22 1/4 | | | | | | | | | | | | | | | | | | | | | | |
| Arm | | | 30 3/8 | | | | | | | | | | | | | | | | | | | | | | |
| Shipping | | | | | | | | | | | | | | | | | | | | | | | | | |
| Ctn Wt | 31 | | | | | | | | | | | | | | | | | | | | | | | | |
| Cu Ft | 20 | | | | | | | | | | | | | | | | | | | | | | | | |
| | Specify: Model Seat Fabric Grade Selection Back Fabric Grade Selection Highest Fabric Grade Selection Metal Frame Color | | | | | | | | | | | | | | | | | | | | | | | | |