

# Ziva Lounge Order Check List:



**Specify:**

- 1. Model Number
- 2. Fabric Selection - vendor, pattern and color (select models offer contrasting upholstery, see page ZV7 for details)
- 3. Front Casters and Back Handle (single seat); add \$180 list
- 4. Optional Tablet Arm - Indicate left (TBL) or right (TBR); laminate or veneer add \$663 list, solid surface add \$785 list
- 5. Optional Side Power - Black (B) or White; add \$560 list each and indicate left or right
- 6. Optional Back Power - Select 20-watt USB-C+A or Single Simplex Plug (SSP); Black (B) or White; upcharge applies
- 7. Optional Stand Up Surface with Privacy Screen - stand up surface specify JSI standard laminate and privacy screen; upcharge applies

**Example:**

ZV6665 | MOMENTUM | VOX | MYSTIC  
 (model #) | (fabric vendor) | (pattern name) | (pattern color)

**1. Model number**

**3. Fabric Selection** - Please supply the following:  
 Fabric vendor/ Pattern name/ Pattern color

[For a complete list of JSI Standard and Graded-In Textiles click here](#)

When specifying contrasting upholstery complete the form on page 329. Use higher grade pricing.

- Fabric for Ziva is always railroaded
- Please provide illustration, if available

**All COM orders must include the following:**

- Vendor's name, pattern name and color
- Sample of the fabric attached to the order
- Model numbers of items for fabric application
- Special application instructions (e.g., all stripes will be applied front to back unless specified otherwise)
- Customer and purchase order number

Ship prepaid COM material to:  
 JSI  
 Attn: COM Dept  
 201 East Martin Street  
 Receiving B, Dock 71  
 Orleans, IN 47452

Application of fabric:  
 Railroaded

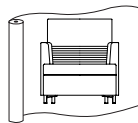

All COM orders will ship at standard lead time from receipt of COM except for orders requiring special custom matched finishes.

**3. Front Casters and Back Handle** - (single seat) - add \$180 list

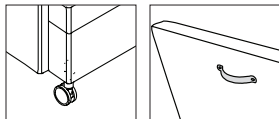

**4. Tablet Arm:**

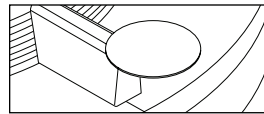

- 14" dia
- Specify Tablet Arm option (TBL) or right (TBR); laminate or veneer add \$663 list, solid surface add \$785 list for each tablet arm specified. For material offering see Ziva table top selection on page ZV4

**5. Side Power:**

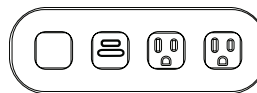

**Power Outlet - add \$560 list**  
 1- Open Port  
 1- 20-watt USB-C+A  
 2- 120 volt

**6. Back Power:**



1- 20-watt USB-C+A



1- 120 Volt

upcharges vary, see specific model numbers

**7. Standup Surface Laminate Color Selection:**

|     |                 |     |                 |
|-----|-----------------|-----|-----------------|
| ALB | Alabaster       | MES | Mesa            |
| BEL | Belair          | MIN | Mineral         |
| BLK | Black           | MCH | Mocha           |
| BRK | Brickdust       | OBK | Outback         |
| BBL | Bridal Blanco   | PIL | Pilsner         |
| CSK | Cask            | PIN | Pinnacle Walnut |
| CLY | Clay            | SHD | Shadow          |
| DWH | Designer White  | SLG | Slate Grey      |
| EGR | Egret           | UMB | Umber           |
| FAW | Fawn            | VAL | Valley          |
| FLN | Flint           | WLH | Walnut Heights  |
| FLO | Florence Walnut | WEA | Weathered Ash   |
| LOF | Loft            | ZEN | Zen Grey        |

**Privacy Screen Colors:**

|     |          |     |             |
|-----|----------|-----|-------------|
| ASH | Ash Grey | MLK | Milky       |
| CRE | Cream    | SIL | Silver Grey |
| GRY | Grey     | WHT | White       |

**Overview**

Ziva is a comprehensive collection of freestanding and configurable seating with an offering of occasional and work tables.

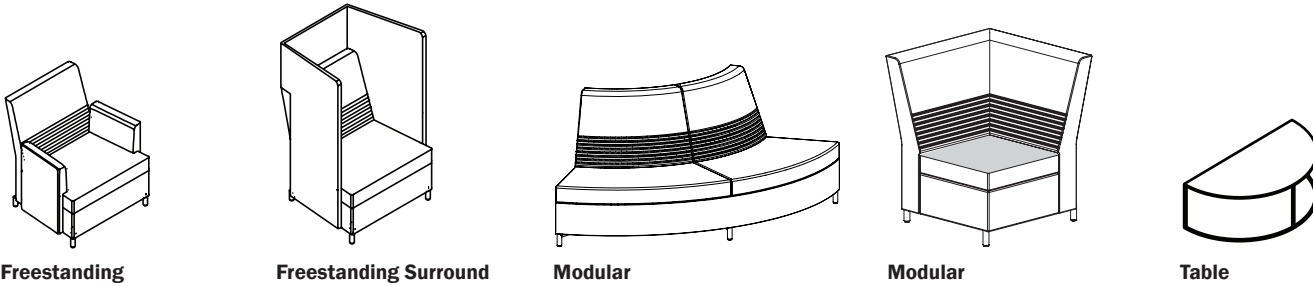

**Freestanding**

**Freestanding Surround**

**Modular**

**Modular**

**Table**

**Features**

Functional details are integrated into the high design of Ziva. The linear stitch pattern in the lumbar area creates interest, while adding comfort. End and middle arms allow for optional tablet. The custom foot allows for leveling and supports the caster option, if mobility is needed. An upper privacy surround on the single or two seater has acoustical capabilities, creating visual and audible privacy for the seated user.

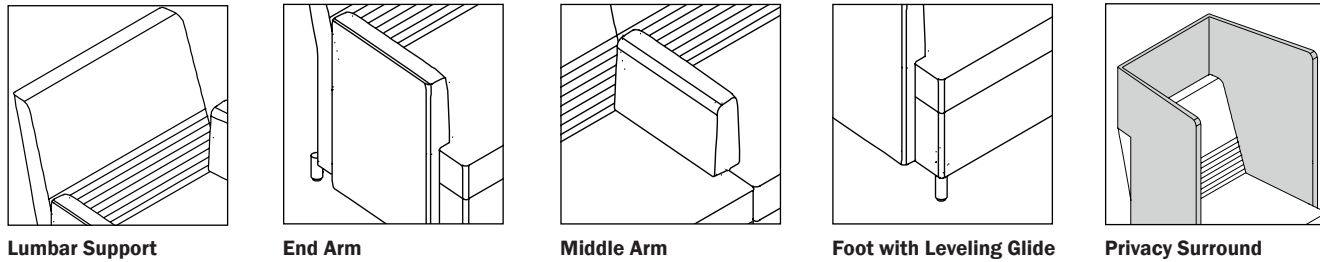

**Lumbar Support**

**End Arm**

**Middle Arm**

**Foot with Leveling Glide**

**Privacy Surround**

**Product Options**

The models come with a variety of options. The front casters and back handle on the single seat provides for mobility. Several options in power and charging along with a stand up surface providing solutions for versatile environment.

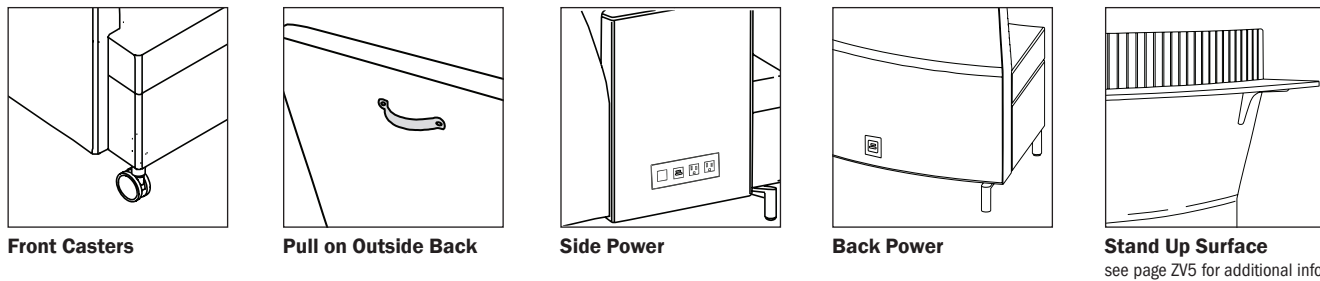

**Front Casters**

**Pull on Outside Back**

**Side Power**

**Back Power**

**Stand Up Surface**

see page ZV5 for additional information

**Product Options**

Selected Ziva lounge models may be specified with power in two different locations. Power outlets on the side of units (including the end arm or the privacy surround) will have **A** configuration. Power outlets on the lower center back have the option of **B** or **C** configuration per model. All units are available in black or white and have a 10' cord.

**Side Power Option**

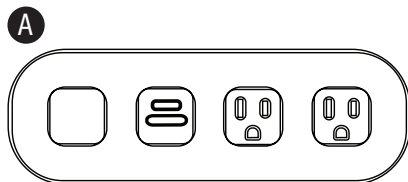

**A Power Outlet**

- 1- Open Port
  - 1- 20-watt USB-C+A
  - 2- 120 volt
- open port allow unit to be customized, adapter kit is included

**Back Power Option**

- B Power Outlet**
- 1 - 20- watt USB-C+A /per device

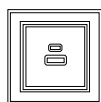

**C Power Outlet**

- 1- 120 volt /per device

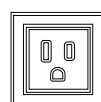

**Back Option Devices Per Model**

| Model Type                   | # of Devices | USB   | Simplex |
|------------------------------|--------------|-------|---------|
| single seat                  | 1            | \$295 | \$205   |
| two seat                     | 2            | \$590 | \$410   |
| three seat                   | 3            | \$885 | \$614   |
| wedge with full back         | 1            | \$295 | \$205   |
| quarter round full back      | 2            | \$590 | \$410   |
| quarter round w/partial back | 1            | \$295 | \$205   |

all devices must be the same per model

**Configurable**

**Quarter Round**

Ziva's modular lounge with 54" and 72" outside radius or 14" and 32" inside radius can provide for solutions for small or large spaces. All radius will work together to create unique solutions.

**2 - 54" Quarter Round**

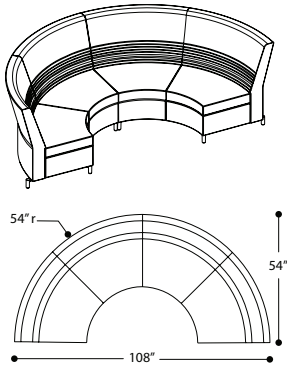

**2 - 72" Quarter Round**

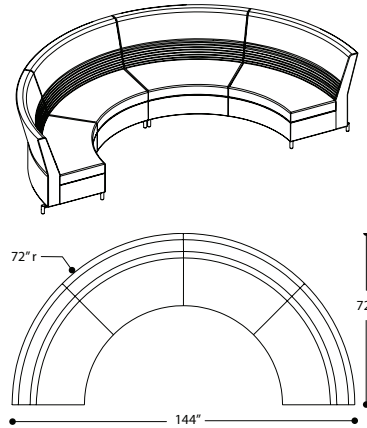

**Modular Units**

Maximum configurability is achieved with wedge, quarter round and in-line units. Modular benches available in round or in-line enhance the layout possibilities while creating an open plan solution.

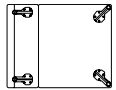

**In-Line**

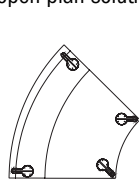

**54" Outside Wedge**

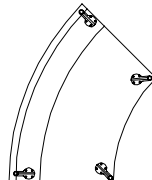

**72" Outside Wedge**

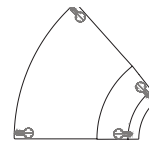

**14" Inside Wedge**

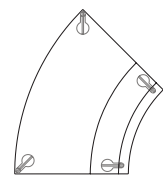

**32" Inside Wedge**

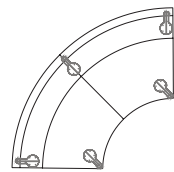

**54" Outside Qtr Round**

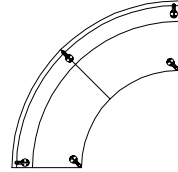

**72" Outside Qtr. Round**

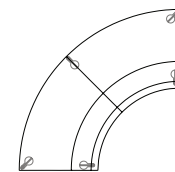

**14" Inside Qtr. Round**

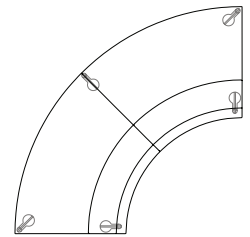

**32" Inside Qtr. Round**

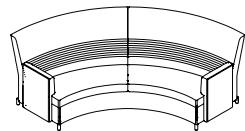

**Outside Back with Arms**

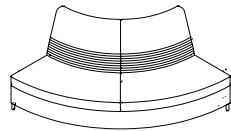

**Inside Back**

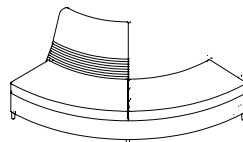

**Partial Back**

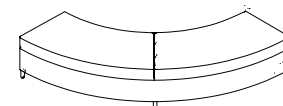

**Bench**

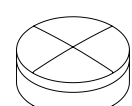

**Ottoman**

**Recommended Combinations**

Ziva is designed to fit the user's preference. To uphold the design statement of Ziva, it is recommended that adjacent layouts have backs on the same side (example 1 & 2) or attached to a bench (example 3). Opposite facing configurations may be achieved by placing a bench or benches in between the two directions (example 4).

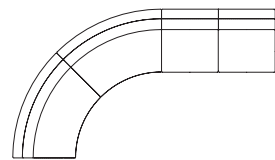

(example 1)

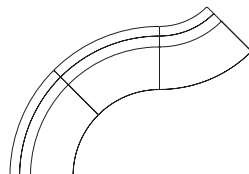

(example 2)

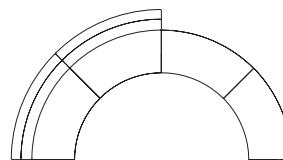

(example 3)

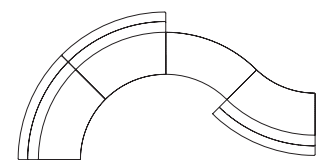

(example 4)

**Ottomans and Tables**

Ottomans and tables can complete a layout and provide functionality. The ottomans are available in four diameters. Both the ottoman or the half round coffee table fit perfectly inside round configurations.

The light scale tables have an Arctic Silver powder coat frame with wood, laminate or solid surface top. The versatile work height tables serve as an end table and arm rest. They can be positioned over benches or the seated user to be used as a work surface. Tables are available in square, rectangle, or half round. They are designed to be used individually or paired up with a matching table.

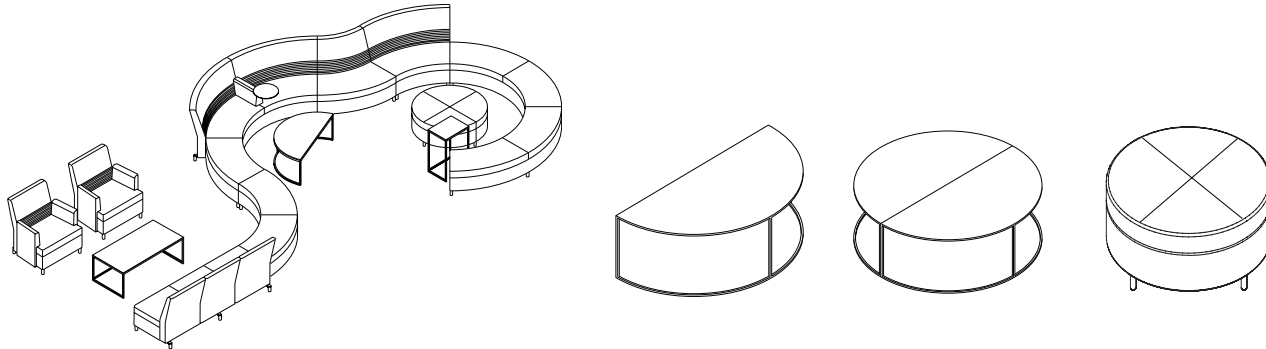

**Tablet Table Option**

All arms on freestanding and modular units are available with an optional 14" diameter tablet. It is offered in 3/4" thick wood, 3/4" thick laminate or 1/2" thick solid surface. The wood tablet is available in Cherry, Maple and Walnut.

The tablet is on a swivel mechanism allowing it to be placed closer to the user. The recommended weight limit for the tablet is 75lbs. JSI does not warrant any damage as a result of excessive weight.

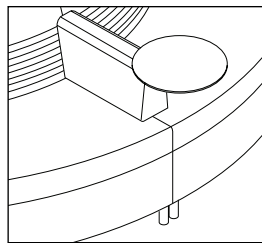

**Tablet Arm**  
(shown on a middle arm)

- Veneer - add \$663
- Laminate - add \$663
- Solid Surface - add \$785

**ESS Essentials Veneer Collection**

|     |           |     |         |
|-----|-----------|-----|---------|
| BRK | Brickdust | OBK | Outback |
| CSK | Cask      | PIL | Pilsner |
| CLY | Clay      | SIE | Sienna  |
| FLX | Flax      | TRF | Truffle |
| MES | Mesa      | UMB | Umber   |
| MCH | Mocha     |     |         |

**Solid Surface**

|     |                   |
|-----|-------------------|
| DWH | Designer White    |
| HST | Hot Stone         |
| ONX | Black Onyx Mirage |
| SOG | Soothing Grey     |

**HPL Wood Grain Pattern Laminates**

|     |                 |     |                 |
|-----|-----------------|-----|-----------------|
| BEL | Belair          | MIN | Mineral         |
| BRK | Brickdust       | MCH | Mocha           |
| CSK | Cask            | OBK | Outback         |
| CLY | Clay            | PIL | Pilsner         |
| EGR | Egret           | PIN | Pinnacle Walnut |
| FAW | Fawn            | UMB | Umber           |
| FLN | Flint           | VAL | Valley          |
| FLO | Florence Walnut | WLH | Walnut Heights  |
| LOF | Loft            | WEA | Weathered Ash   |
| MES | Mesa            |     |                 |

**HPL Solid Laminates**

|     |                |     |            |
|-----|----------------|-----|------------|
| ALB | Alabaster      | SHD | Shadow     |
| BLK | Black          | SLG | Slate Grey |
| BBL | Bridal Blanco  | ZEN | Zen Grey   |
| DWH | Designer White |     |            |

ZIVA

**Stand Up Surface with Privacy Screen**

Stand Up Surface is 3/4" thick provides 9 1/4" deep surface, mounted at 35"h. This option is available on many of the units, and come with acoustical texture privacy panels. The privacy screen is available in six colors.

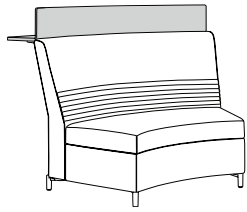

**Stand Up Surface**  
All JSI standard laminates

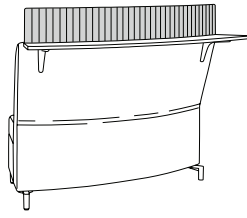

**Privacy Screen**  
Ash Grey    Grey    Silver Grey  
Cream      Milk      White

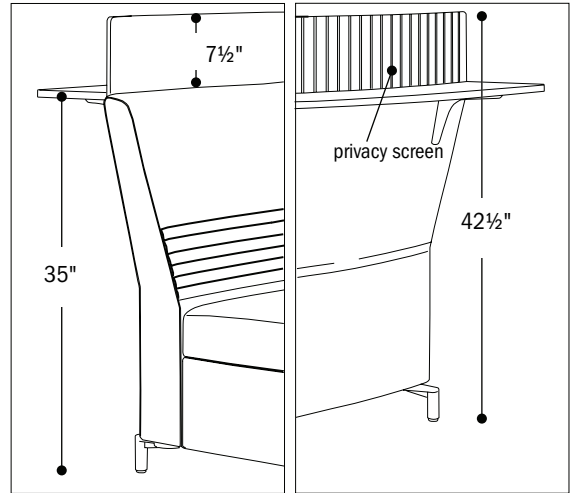
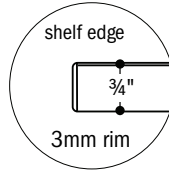

**Use JSI Counter Height Stools for proper seating height.**

**54"r modular units**

|               |         |
|---------------|---------|
| ZV6550-OB     | \$666   |
| ZV6588-ROB    | \$666   |
| ZV6588-LOB    | \$666   |
| ZV6588-FOB    | \$1,427 |
| ZV6588-FOB-RA | \$1,427 |
| ZV6588-FOB-LA | \$1,427 |

**72"r modular units**

|               |         |
|---------------|---------|
| ZV6650-OB     | \$876   |
| ZV6688-ROB    | \$876   |
| ZV6688-LOB    | \$876   |
| ZV6688-FOB    | \$1,642 |
| ZV6688-FOB-RA | \$1,642 |
| ZV6688-FOB-LA | \$1,642 |

**freestanding models**

|               |         |
|---------------|---------|
| ZV6660        | \$666   |
| ZV6670        | \$915   |
| ZV6680        | \$1,206 |
| ZV6665        | \$666   |
| ZV6675        | \$915   |
| ZV6685        | \$1,206 |
| ZV6628-FB     | \$666   |
| ZV6655-FB     | \$915   |
| ZV6683-FB     | \$1,206 |
| ZV6688-FOB-2A | \$1,642 |

**Lounge**

**Rights and Lefts**

The handedness of the chair is determined by seated position.

**Frame Construction**

Frame interior is upholstery grade plywood with glued solid hardwood cross members reinforced with wood screws.

**Seat Construction**

Seat has synthetic sheet webbing with cross strap and 3 5/8" thick high resiliency polyurethane multi-density foam.

**Back Construction**

Back has 1 3/4" thick polyurethane foam, back lumbar has 10 channel stitch detail thru 3/8" thick polyurethane foam.

**Arm Construction**

3/4" of high grade polyurethane foam covers a plywood constructed arm frame.

**Upholstery Detail**

Contrasting fabric available on the back or the arms and seat.

**Patterned fabric is not recommended as the fabric may not align at the same location.**

Screen & Shelf - Outside Back Tables

**Frame Construction**

Arctic Silver powder-coat finish over a fabricated and welded tubular frame.

**Top Construction - Veneer**

1.5 mm rimmed core with veneer surface.

**Legs**

Die cast zinc with matte chrome finish.  
1" of height adjustability on the glide.

**Tablet Arm**

3/4" thick with Veneer or 1/2" thick Solid surface. Mechanism allows for a full 360 degree of swivel and writing surface of 14" diameter.

**Important Upholstery Information**

To reduce the number of seams and to achieve a clean look, **Railroaded** off the roll application is standard for Ziva. Line art and pricing for Ziva reflects railroaded fabric. **Due to the size of Ziva and minimal seams, patterned fabrics with the nap (side to side), and leather are not recommended.**

JSI strives to achieve customer satisfaction, therefore requests for patterned fabrics, with a nap application, and leather will be reviewed on a case by case basis. Fill out the sample form on the next page and contact Customer Service. Additional fabric yardage may be required and will be the customer's responsibility. The customer may also be asked to approve additional seaming. Other additional charges may apply. If a patterned fabric is specified, JSI does not guarantee matching at seams.

**Standard Seaming**

The back and seat are upholstered separately and therefore will have no joining seams, only tailoring seams as per the product design. Shown below are examples of seams required to join the fabric on the seat and surround. (marked with a ●)

The seat seam is hidden on freestanding and modular units with full backs. Partial back modular units have seaming on the bench section on the same side as the back.

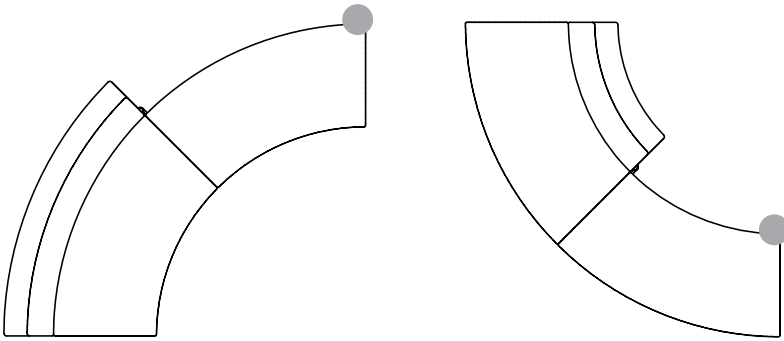

Benches (freestanding and modular) and ottomans have tailoring seams to align with the feet on the seat platform.

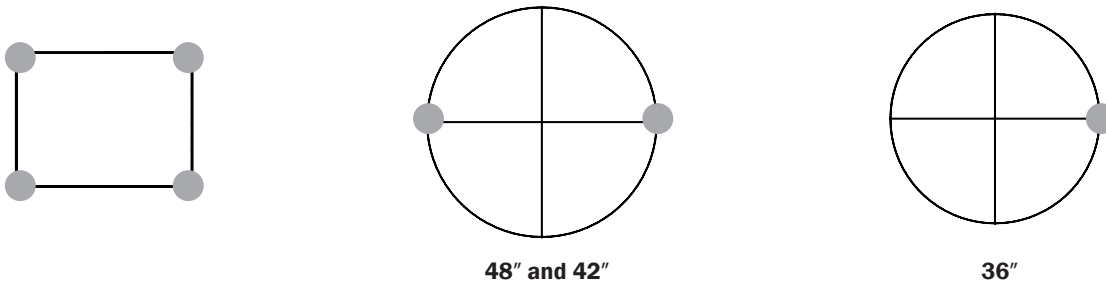

Privacy Surround will have a fabric joining seam on the front band of surround.

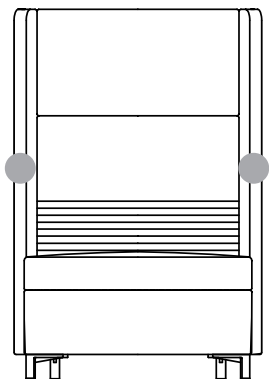

**Seating Material Options**

This form must accompany order when specifying contrasting or complementary upholstery.

**Call for yardage and pricing.**

Area (a), (b) and (c) are upholstery and can be specified in contrasting fabric. Legs and handle are a die-cast zinc with a matte chrome finish.

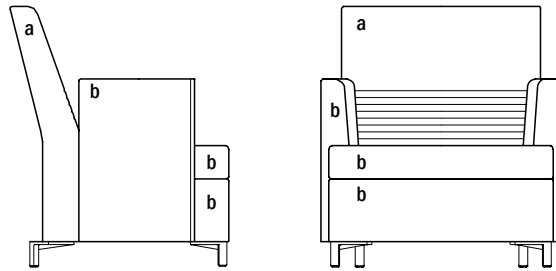

**Freestanding & Modular**

Model Number: \_\_\_\_\_

Back (a): \_\_\_\_\_

Arms, Seat & Base (b): \_\_\_\_\_

photo copy or scan

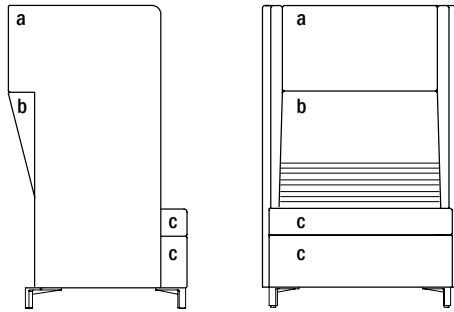

**Freestanding with Surround**

Model Number: \_\_\_\_\_

Surround (a): \_\_\_\_\_

Back (b): \_\_\_\_\_

Seat & Base (c): \_\_\_\_\_

**Large Configurations**

When using three or more modular units that will be connected as a single configuration, it is very helpful if the models and upholstery fabric are listed in sequence. This will assist in the order entry process and assure a better match of the configuration. Refer to the diagrams below.

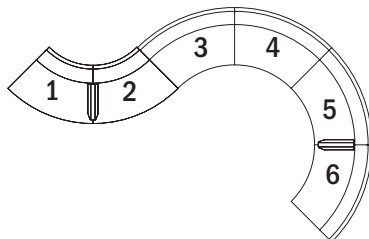
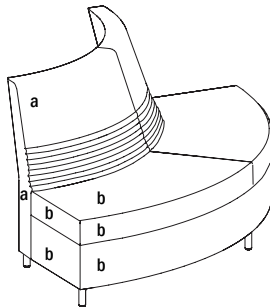

| Sequence   | Model # | Fabric a | Fabric b |
|------------|---------|----------|----------|
| 1 of _____ | _____   | _____    | _____    |
| 2 of _____ | _____   | _____    | _____    |
| 3 of _____ | _____   | _____    | _____    |
| 4 of _____ | _____   | _____    | _____    |
| 5 of _____ | _____   | _____    | _____    |
| 6 of _____ | _____   | _____    | _____    |
| 7 of _____ | _____   | _____    | _____    |
| 8 of _____ | _____   | _____    | _____    |
| 9 of _____ | _____   | _____    | _____    |

# Ziva

## FREESTANDING



### Description

### 1 Model

### Specifications

### List Price Per Grade

#### Single Seat

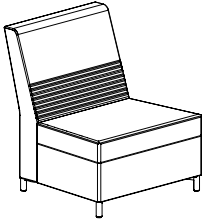

#### ZV6660

- upholstered seat and back
- armless
- fabric application is railroad
- front casters and pull available, specify and add \$180 list
- seat side power available, specify and add \$560 list; indicate right or left as seated and color Black (B) or White (W)
- power available in the center of the lower extreme back, USB-C+A add \$295 list or single simplex add \$205 list; specify USB or Simplex and color Black (B) or White (W)

| Dimensions | D                              | W                              | H                              |
|------------|--------------------------------|--------------------------------|--------------------------------|
| Overall    | 30 <sup>3</sup> / <sub>8</sub> | 31                             | 36                             |
| Seat       | 20 <sup>1</sup> / <sub>2</sub> | 29 <sup>3</sup> / <sub>8</sub> | 17 <sup>1</sup> / <sub>2</sub> |
| Upholstery |                                | Shipping                       |                                |
| COM Ydg    | 3 <sup>1</sup> / <sub>2</sub>  | Ctn Wt                         | 82                             |
|            |                                | Cu Ft                          | 23                             |

|     |         |
|-----|---------|
| COM | \$2,733 |
| A   | \$2,794 |
| B   | \$2,909 |
| C   | \$3,109 |
| D   | \$3,363 |
| E   | \$3,622 |
| F   | \$3,897 |
| G   | \$4,281 |
| H   | \$4,695 |
| I   | \$5,337 |
| J   | \$6,110 |

#### Two Seat

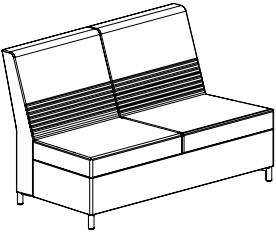

#### ZV6670

- upholstered seat and back
- armless
- fabric application is railroad
- seat side power available, specify and add \$560 list; indicate right or left as seated and color Black (B) or White (W)
- power available in the left and right of the lower extreme back, USB-C+A add \$590 list or single simplex add \$410 list; specify USB or Simplex and color Black (B) or White (W)

| Dimensions | D                              | W                              | H                              |
|------------|--------------------------------|--------------------------------|--------------------------------|
| Overall    | 30 <sup>3</sup> / <sub>8</sub> | 58 <sup>1</sup> / <sub>2</sub> | 36                             |
| Seat       | 20 <sup>1</sup> / <sub>2</sub> | 56 <sup>3</sup> / <sub>4</sub> | 17 <sup>1</sup> / <sub>2</sub> |
| Upholstery |                                | Shipping                       |                                |
| COM Ydg    | 7                              | Ctn Wt                         | 154                            |
|            |                                | Cu Ft                          | 42                             |

|     |          |
|-----|----------|
| COM | \$4,579  |
| A   | \$4,697  |
| B   | \$4,927  |
| C   | \$5,324  |
| D   | \$5,840  |
| E   | \$6,356  |
| F   | \$6,901  |
| G   | \$7,670  |
| H   | \$8,497  |
| I   | \$9,785  |
| J   | \$11,333 |



**Description**

Three Seat

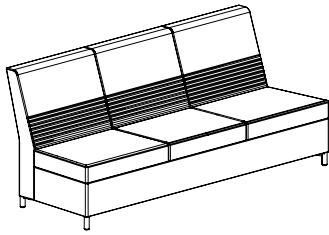

**1 Model**

**ZV6680**

- upholstered seat and back
- armless
- fabric application is railroad
- seat side power available, specify and add \$560 list; indicate right or left as seated and color Black (B) or White (W)
- power available in the left, right and center of the lower extreme back, USB-C+A add \$885 list or single simplex add \$614 list; specify USB or Simplex and color Black (B) or White (W)

**Specifications**

| Dimensions | D      | W        | H      |
|------------|--------|----------|--------|
| Overall    | 30 3/8 | 86       | 36     |
| Seat       | 20 1/2 | 84 3/8   | 17 1/2 |
| Upholstery |        | Shipping |        |
| COM Ydg    | 10 1/2 | Ctn Wt   | 224    |
|            |        | Cu Ft    | 62     |

**List Price Per Grade**

|     |          |
|-----|----------|
| COM | \$6,873  |
| A   | \$7,051  |
| B   | \$7,392  |
| C   | \$7,997  |
| D   | \$8,770  |
| E   | \$9,542  |
| F   | \$10,355 |
| G   | \$11,519 |
| H   | \$12,751 |
| I   | \$14,683 |
| J   | \$17,004 |

**To Order, Specify:**

- 1 Model Number
- 2 Fabric Selection - vendor, pattern and color  
Visit [www.jsifurniture.com/finishes-and-materials/textiles](http://www.jsifurniture.com/finishes-and-materials/textiles) for our textiles program. See selection of standard and graded in manufacturers and patterns.
- 3 Side Power; see page [ZV1](#)
- 4 Back Power; see page [ZV1](#)

**Specifications**

- Fabric is railroaded.
- Non-patterned textile is recommended.
- Frame interior is upholstery grade plywood with glued solid hardwood cross members reinforced with wood screws.
- Seat has synthetic sheet webbing with cross strap and 3 3/8" thick high resiliency seat polyurethane multi-density foam.
- Back has 1 3/4" thick polyurethane foam, back lumbar has 10 channel stitch detail thru 3/8" thick polyurethane foam.
- 3/4" of high grade polyurethane foam covers a plywood constructed arm frame.

# Ziva

## FREESTANDING



### Description

### ① Model

### Specifications

### List Price Per Grade

#### Single Seat

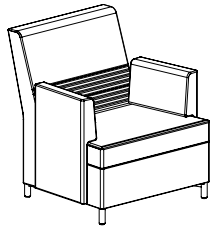

#### ZV6665

- upholstered seat, back and arms
- fabric application is railroad
- front casters and pull available, specify and add \$180 list
- tablet available, specify and add \$785 list for standard solid surface or \$663 list for laminate or veneer; indicate right or left as seated and finish
- seat side power available, specify and add \$560 list; indicate right or left as seated and color Black (B) or White (W)
- power available in the center of the lower extreme back, USB-C+A add \$295 list or single simplex add \$186 list; specify USB or Simplex and color Black (B) or White (W)
- stand up surface with privacy screen available, add \$666; specify standard JSI laminate for top and the color of felt board for the privacy screen

| Dimensions | D      | W        | H      |
|------------|--------|----------|--------|
| Overall    | 30 3/8 | 33 1/8   | 36     |
| Seat       | 20 1/2 | 24 1/4   | 17 1/2 |
| Arm        |        |          | 26     |
| Upholstery |        | Shipping |        |
| COM Ydg    | 5      | Ctn Wt   | 97     |
|            |        | Cu Ft    | 24     |

|     |         |
|-----|---------|
| COM | \$3,492 |
| A   | \$3,573 |
| B   | \$3,737 |
| C   | \$4,024 |
| D   | \$4,391 |
| E   | \$4,759 |
| F   | \$5,147 |
| G   | \$5,698 |
| H   | \$6,287 |
| I   | \$7,210 |
| J   | \$8,311 |

#### Two Seat

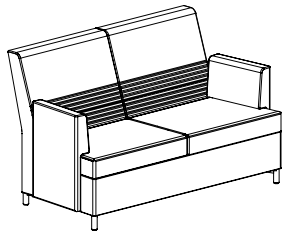

#### ZV6675

- upholstered seat, back and arms
- fabric application is railroad
- tablet available, specify and add \$785 list for standard solid surface or \$663 list for laminate or veneer; indicate right or left as seated and finish
- seat side power available, specify and add \$560 list; indicate right or left as seated and color Black (B) or White (W)
- power available in the left and right of the lower extreme back, USB-C+A add \$590 list or single simplex add \$410 list; specify USB or Simplex and color Black (B) or White (W)
- stand up surface with privacy screen available, add \$915; specify standard JSI laminate for top and the color of felt board for the privacy screen

| Dimensions | D      | W        | H      |
|------------|--------|----------|--------|
| Overall    | 30 3/8 | 60 3/4   | 36     |
| Seat       | 20 1/2 | 51 3/4   | 17 1/2 |
| Arm        |        |          | 26     |
| Upholstery |        | Shipping |        |
| COM Ydg    | 8 1/2  | Ctn Wt   | 198    |
|            |        | Cu Ft    | 44     |

|     |          |
|-----|----------|
| COM | \$5,438  |
| A   | \$5,577  |
| B   | \$5,857  |
| C   | \$6,345  |
| D   | \$6,967  |
| E   | \$7,592  |
| F   | \$8,255  |
| G   | \$9,194  |
| H   | \$10,193 |
| I   | \$11,757 |
| J   | \$13,636 |

**Description**

Three Seat

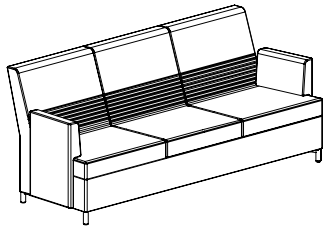

**1 Model**

**ZV6685**

- upholstered seat, back and arms
- fabric application is railroad
- tablet available, specify and add \$785 list for standard solid surface or \$663 list for laminate or veneer; indicate right or left as seated and finish
- seat side power available, specify and add \$560 list; indicate right or left as seated and color Black (B) or White (W)
- power available in the left, right and center of the lower extreme back, USB-C+A add \$885 list or single simplex add \$614 list; specify USB or Simplex and color Black (B) or White (W)
- stand up surface with privacy screen available, add \$1,206; specify standard JSI laminate for top and the color of felt board for the privacy screen

**Specifications**

| Dimensions | D        | W      | H      |
|------------|----------|--------|--------|
| Overall    | 30 3/8   | 88 1/4 | 36     |
| Seat       | 20 1/2   | 79 1/4 | 17 1/2 |
| Arm        |          |        | 26     |
| Upholstery | Shipping |        |        |
| COM Ydg    | 12       | Ctn Wt | 258    |
|            |          | Cu Ft  | 63     |

**List Price Per Grade**

|     |          |
|-----|----------|
| COM | \$7,755  |
| A   | \$7,953  |
| B   | \$8,347  |
| C   | \$9,036  |
| D   | \$9,918  |
| E   | \$10,801 |
| F   | \$11,733 |
| G   | \$13,061 |
| H   | \$14,470 |
| I   | \$16,681 |
| J   | \$19,330 |

**To Order, Specify:**

- 1 Model Number
- 2 Fabric Selection - vendor, pattern and color  
Visit [www.jsifurniture.com/finishes-and-materials/textiles](http://www.jsifurniture.com/finishes-and-materials/textiles) for our textiles program. See selection of standard and graded in manufacturers and patterns.
- 3 Tablet Table Option Selection  
[See Tablet Table Option Selection](#)
- 4 Side Power; see page [ZV1](#)
- 5 Back Power; see page [ZV1](#)
- 6 Standup Surface Laminate Color Selection  
[See Laminate Color Selection](#)

**Specifications**

- Fabric is railroaded.
- Non-patterned textile is recommended.
- Frame interior is upholstery grade plywood with glued solid hardwood cross members reinforced with wood screws.
- Seat has synthetic sheet webbing with cross strap and 3 3/8" thick high resiliency seat polyurethane multi-density foam.
- Back has 1 3/4" thick polyurethane foam, back lumbar has 10 channel stitch detail thru 3/8" thick polyurethane foam.
- 3/4" of high grade polyurethane foam covers a plywood constructed arm frame.

# Ziva

## FREESTANDING



### Description

### ① Model

### Specifications

### List Price Per Grade

#### Single Seat with Surround

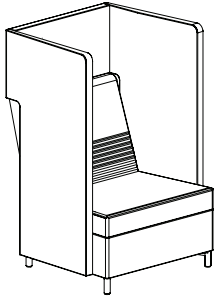

#### ZV6660-PS

- upholstered seat, back and surround
- fabric application is railroad
- front casters and pull available, specify and add \$180 list
- seat side power available, specify and add \$560 list; indicate right or left as seated and color Black (B) or White (W)

| Dimensions | D      | W        | H      |
|------------|--------|----------|--------|
| Overall    | 30 3/8 | 33 3/4   | 50 1/2 |
| Seat       | 20 1/2 | 24 1/4   | 17 1/2 |
| Upholstery |        | Shipping |        |
| COM Ydg    | 8 1/2  | Ctn Wt   | 119    |
|            |        | Cu Ft    | 37     |

|     |          |
|-----|----------|
| COM | \$4,453  |
| A   | \$4,593  |
| B   | \$4,872  |
| C   | \$5,359  |
| D   | \$5,984  |
| E   | \$6,610  |
| F   | \$7,269  |
| G   | \$8,209  |
| H   | \$9,209  |
| I   | \$10,775 |
| J   | \$12,650 |

#### Two Seat with Surround

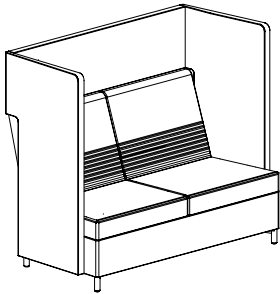

#### ZV6670-PS

- upholstered seat, back and surround
- fabric application is railroad
- seat side power available, specify and add \$560 list; indicate right or left as seated and color Black (B) or White (W)

| Dimensions | D      | W        | H      |
|------------|--------|----------|--------|
| Overall    | 30 3/8 | 61 1/4   | 50 1/2 |
| Seat       | 20 1/2 | 51 3/4   | 17 1/2 |
| Upholstery |        | Shipping |        |
| COM Ydg    | 12 3/4 | Ctn Wt   | 211    |
|            |        | Cu Ft    | 61     |

|     |          |
|-----|----------|
| COM | \$5,953  |
| A   | \$6,166  |
| B   | \$6,582  |
| C   | \$7,313  |
| D   | \$8,249  |
| E   | \$9,190  |
| F   | \$10,181 |
| G   | \$11,585 |
| H   | \$13,088 |
| I   | \$15,435 |
| J   | \$18,253 |

#### Two Seat with Surround and Middle Arm

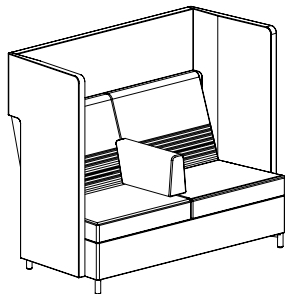

#### ZV6672-PS

- upholstered seat, back and surround
- fabric application is railroad
- tablet available, specify and add \$785 list for standard solid surface or \$663 list for laminate or veneer
- seat side power available, specify and add \$560 list; indicate right or left as seated and color Black (B) or White (W)

| Dimensions | D      | W        | H      |
|------------|--------|----------|--------|
| Overall    | 30 3/8 | 61 1/4   | 50 1/2 |
| Seat       | 20 1/2 | 51 3/4   | 17 1/2 |
| Upholstery |        | Shipping |        |
| COM Ydg    | 13 1/2 | Ctn Wt   | 225    |
|            |        | Cu Ft    | 61     |

|     |          |
|-----|----------|
| COM | \$6,277  |
| A   | \$6,503  |
| B   | \$6,943  |
| C   | \$7,715  |
| D   | \$8,708  |
| E   | \$9,701  |
| F   | \$10,752 |
| G   | \$12,241 |
| H   | \$13,831 |
| I   | \$16,316 |
| J   | \$19,296 |

ZIVA

**Description**

72" Radius Quarter Round with Outside Back and Arms

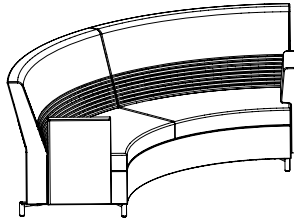

**1 Model**

**ZV6688-F0B-2A**

- upholstered seat, back and arms
- fabric application is railroad. Non-patterned fabrics are recommended
- tablet available, specify and add \$785 list for standard solid surface or \$663 list for laminate or veneer; indicate right or left as seated and finish
- seat side power available, specify and add \$560 list; indicate right or left as seated and color Black (B) or White (W)
- power available in the left and right of the lower extreme back, USB-C+A add \$590 list or single simplex add \$410 list; specify USB or Simplex and color Black (B) or White (W)
- stand up surface with privacy screen available, add \$1,642; specify standard JSI laminate for top and the color of felt board for the privacy screen

**Specifications**

| Dimensions | D    | W        | H    |
|------------|------|----------|------|
| Overall    | 42 ½ | 101 ½    | 36   |
| Seat       | 20 ½ | 59 ¼     | 17 ½ |
| Arm        |      |          | 26   |
| Upholstery |      | Shipping |      |
| COM Ydg    | 12 ½ | Ctn Wt   | 269  |
|            |      | Cu Ft    | 97   |

**List Price Per Grade**

|     |          |
|-----|----------|
| COM | \$7,320  |
| A   | \$7,529  |
| B   | \$7,936  |
| C   | \$8,652  |
| D   | \$9,575  |
| E   | \$10,493 |
| F   | \$11,466 |
| G   | \$12,842 |
| H   | \$14,315 |
| I   | \$16,614 |
| J   | \$19,377 |

32" Radius Quarter Round with Inside Back and Arms

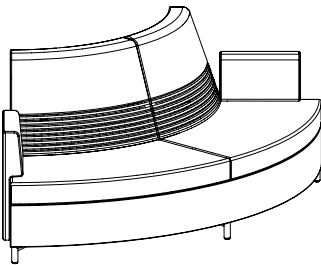

**ZV6688-FIB-2A**

- upholstered seat, back and arms
- fabric application is railroad. Non-patterned fabrics are recommended
- tablet available, specify and add \$785 list for standard solid surface or \$663 list for laminate or veneer; indicate right or left as seated and finish
- seat side power available, specify and add \$560 list; indicate right or left as seated and color Black (B) or White (W)

| Dimensions | D    | W        | H    |
|------------|------|----------|------|
| Overall    | 39 ½ | 87 ⅝     | 36   |
| Seat       | 20 ½ | 45 ⅝     | 17 ½ |
| Arm        |      |          | 26   |
| Upholstery |      | Shipping |      |
| COM Ydg    | 9 ½  | Ctn Wt   | 254  |
|            |      | Cu Ft    | 81   |

|     |          |
|-----|----------|
| COM | \$7,211  |
| A   | \$7,366  |
| B   | \$7,680  |
| C   | \$8,222  |
| D   | \$8,920  |
| E   | \$9,622  |
| F   | \$10,356 |
| G   | \$11,406 |
| H   | \$12,526 |
| I   | \$14,273 |
| J   | \$16,371 |

**To Order, Specify:**

- 1 Model Number
- 2 Fabric Selection - vendor, pattern and color  
Visit [www.jsifurniture.com/finishes-and-materials/textiles](http://www.jsifurniture.com/finishes-and-materials/textiles) for our textiles program. See selection of standard and graded in manufacturers and patterns.
- 3 Tablet Table Option Selection  
[See Tablet Table Option Selection](#)
- 4 Side Power; see page [ZV1](#)
- 5 Back Power; see page [ZV1](#)
- 6 Standup Surface Laminate Color Selection  
[See Laminate Color Selection](#)

**Specifications**

- Fabric is railroaded.
- Non-patterned textile is recommended.
- Frame interior is upholstery grade plywood with glued solid hardwood cross members reinforced with wood screws.
- Seat has synthetic sheet webbing with cross strap and 3 ¾" thick high resiliency seat polyurethane multi-density foam.
- Back has 1 ¾" thick polyurethane foam, back lumbar has 10 channel stitch detail thru ¾" thick polyurethane foam.
- ¾" of high grade polyurethane foam covers a plywood constructed arm frame.

Description

1 Model

Specifications

List Price Per Grade

In-Line Single Seat

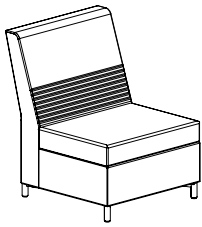

ZV6628-FB

- upholstered seat and back
- armless
- fabric application is railroad. Non-patterned fabrics are recommended
- seat side power available, specify and add \$560 list; indicate right or left as seated and color Black (B) or White (W)
- power available in the center of the lower extreme back, USB-C+A add \$295 list or single simplex add \$186 list; specify USB or Simplex and color Black (B) or White (W)
- stand up surface with privacy screen available, add \$666; specify standard JSI laminate for top and the color of felt board for the privacy screen

| Dimensions | D      | W        | H      |
|------------|--------|----------|--------|
| Overall    | 30 3/8 | 27 1/2   | 36     |
| Seat       | 20 1/2 | 27 1/2   | 17 1/2 |
| Upholstery |        | Shipping |        |
| COM Ydg    | 3 1/2  | Ctn Wt   | 82     |
|            |        | Cu Ft    | 20     |

|     |         |
|-----|---------|
| COM | \$2,649 |
| A   | \$2,709 |
| B   | \$2,824 |
| C   | \$3,024 |
| D   | \$3,280 |
| E   | \$3,539 |
| F   | \$3,810 |
| G   | \$4,195 |
| H   | \$4,609 |
| I   | \$5,251 |
| J   | \$6,028 |

In-Line Two Seat

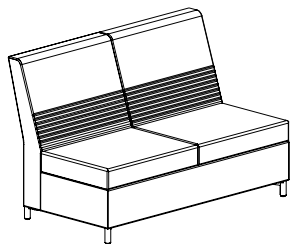

ZV6655-FB

- upholstered seat and back
- armless
- fabric application is railroad. Non-patterned fabrics are recommended
- seat side power available, specify and add \$560 list; indicate right or left as seated and color Black (B) or White (W)
- power available in the left and right of the lower extreme back, USB-C+A add \$590 list or single simplex add \$410 list; specify USB or Simplex and color Black (B) or White (W)
- stand up surface with privacy screen available, add \$915; specify standard JSI laminate for top and the color of felt board for the privacy screen

| Dimensions | D      | W        | H      |
|------------|--------|----------|--------|
| Overall    | 30 3/8 | 55       | 36     |
| Seat       | 20 1/2 | 55 1/8   | 17 1/2 |
| Upholstery |        | Shipping |        |
| COM Ydg    | 7      | Ctn Wt   | 154    |
|            |        | Cu Ft    | 40     |

|     |          |
|-----|----------|
| COM | \$4,633  |
| A   | \$4,749  |
| B   | \$4,979  |
| C   | \$5,378  |
| D   | \$5,895  |
| E   | \$6,408  |
| F   | \$6,955  |
| G   | \$7,724  |
| H   | \$8,552  |
| I   | \$9,837  |
| J   | \$11,384 |

**Description**

**1 Model**

**Specifications**

**List Price Per Grade**

In-Line Three Seat

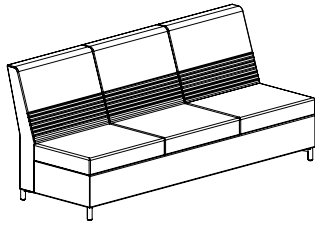

**ZV6683-FB**

- upholstered seat and back
- armless
- fabric application is railroad. Non-patterned fabrics are recommended
- seat side power available, specify and add \$560 list; indicate right or left as seated and color Black (B) or White (W)
- power available in the left, right and center of the lower extreme back, USB-C+A add \$885 list or single simplex add \$614 list; specify USB or Simplex and color Black (B) or White (W)
- stand up surface with privacy screen available, add \$1,206; specify standard JSI laminate for top and the color of felt board for the privacy screen

| Dimensions | D      | W        | H      |
|------------|--------|----------|--------|
| Overall    | 30 3/8 | 82 1/2   | 36     |
| Seat       | 20 1/2 | 82 5/8   | 17 1/2 |
| Upholstery |        | Shipping |        |
| COM Ydg    | 10 1/2 | Ctn Wt   | 224    |
|            |        | Cu Ft    | 59     |

| COM | \$7,061  |
|-----|----------|
| A   | \$7,234  |
| B   | \$7,579  |
| C   | \$8,182  |
| D   | \$8,953  |
| E   | \$9,723  |
| F   | \$10,542 |
| G   | \$11,697 |
| H   | \$12,933 |
| I   | \$14,867 |
| J   | \$17,185 |

72" Radius Wedge with Outside Back

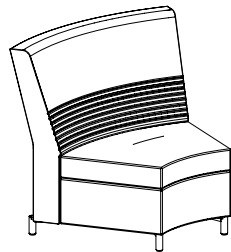

**ZV6650-OB**

- upholstered seat and back
- armless
- fabric application is railroad. Non-patterned fabrics are recommended
- seat side power available, specify and add \$560 list; indicate right or left as seated and color Black (B) or White (W)
- power available in the center of the lower extreme back, USB-C+A add \$295 list or single simplex add \$186 list; specify USB or Simplex and color Black (B) or White (W)
- stand up surface with privacy screen available, add \$876; specify standard JSI laminate for top and the color of felt board for the privacy screen

| Dimensions | D      | W        | H      |
|------------|--------|----------|--------|
| Overall    | 33 1/2 | 54 7/8   | 36     |
| Seat       | 20 1/2 | 31 1/8   | 17 1/2 |
| Upholstery |        | Shipping |        |
| COM Ydg    | 5 1/2  | Ctn Wt   | 129    |
|            |        | Cu Ft    | 44     |

| COM | \$3,549 |
|-----|---------|
| A   | \$3,638 |
| B   | \$3,816 |
| C   | \$4,134 |
| D   | \$4,536 |
| E   | \$4,943 |
| F   | \$5,370 |
| G   | \$5,976 |
| H   | \$6,625 |
| I   | \$7,636 |
| J   | \$8,850 |

**To Order, Specify:**

- 1 Model Number
- 2 Fabric Selection - vendor, pattern and color  
Visit [www.jsifurniture.com/finishes-and-materials/textiles](http://www.jsifurniture.com/finishes-and-materials/textiles) for our textiles program. See selection of standard and graded in manufacturers and patterns.
- 3 Tablet Table Option Selection  
[See Tablet Table Option Selection](#)
- 4 Side Power; see page [ZV1](#)
- 5 Back Power; see page [ZV1](#)
- 6 Standup Surface Laminate Color Selection  
[See Laminate Color Selection](#)

**Specifications**

- Fabric is railroaded.
- Non-patterned textile is recommended.
- Frame interior is upholstery grade plywood with glued solid hardwood cross members reinforced with wood screws.
- Seat has synthetic sheet webbing with cross strap and 3 3/8" thick high resiliency seat polyurethane multi-density foam.
- Back has 1 3/4" thick polyurethane foam, back lumbar has 10 channel stitch detail thru 3/8" thick polyurethane foam.
- 3/4" of high grade polyurethane foam covers a plywood constructed arm frame.

Description

72" Radius Quarter Round with Partial Outside Back

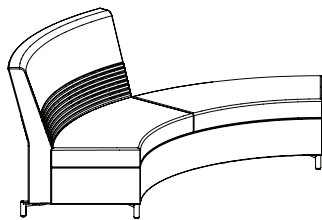

right shown

1 Model

ZV6688-ROB  
ZV6688-LOB

- upholstered seat and back
- armless
- fabric application is railroad. Non-patterned fabrics are recommended
- seat side power available, specify and add \$560 list; indicate right or left as seated and color Black (B) or White (W)
- power available in the center of the lower extreme back, USB-C+A add \$295 list or single simplex add \$186 list; specify USB or Simplex and color Black (B) or White (W)
- stand up surface with privacy screen available, add \$876; specify standard JSI laminate for top and the color of felt board for the privacy screen

Specifications

| Dimensions | D    | W        | H    |
|------------|------|----------|------|
| Overall    | 42 ½ | 94 ⅞     | 36   |
| Seat       | 20 ½ | 59 ¼     | 17 ½ |
| Upholstery |      | Shipping |      |
| COM Ydg    | 7    | Ctn Wt   | 231  |
|            |      | Cu Ft    | 92   |

List Price Per Grade

|     |          |
|-----|----------|
| COM | \$5,065  |
| A   | \$5,181  |
| B   | \$5,412  |
| C   | \$5,812  |
| D   | \$6,325  |
| E   | \$6,842  |
| F   | \$7,387  |
| G   | \$8,158  |
| H   | \$8,983  |
| I   | \$10,273 |
| J   | \$11,817 |

72" Radius Quarter Round with Outside Back

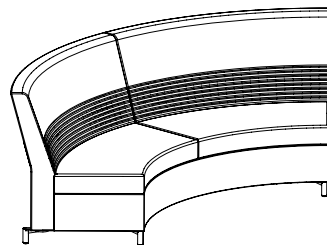

ZV6688-FOB

- upholstered seat and back
- armless
- fabric application is railroad. Non-patterned fabrics are recommended
- seat side power available, specify and add \$560 list; indicate right or left as seated and color Black (B) or White (W)
- power available in the left and right of the lower extreme back, USB-C+A add \$590 list or single simplex add \$410 list; specify USB or Simplex and color Black (B) or White (W)
- stand up surface with privacy screen available, add \$1,642; specify standard JSI laminate for top and the color of felt board for the privacy screen

| Dimensions | D    | W        | H    |
|------------|------|----------|------|
| Overall    | 42 ½ | 101 ½    | 36   |
| Seat       | 20 ½ | 59 ¼     | 17 ½ |
| Upholstery |      | Shipping |      |
| COM Ydg    | 11   | Ctn Wt   | 190  |
|            |      | Cu Ft    | 100  |

|     |          |
|-----|----------|
| COM | \$6,434  |
| A   | \$6,615  |
| B   | \$6,974  |
| C   | \$7,606  |
| D   | \$8,414  |
| E   | \$9,226  |
| F   | \$10,076 |
| G   | \$11,293 |
| H   | \$12,588 |
| I   | \$14,612 |
| J   | \$17,039 |



**Description**

72" Radius Quarter Round with Outside Back and Arm

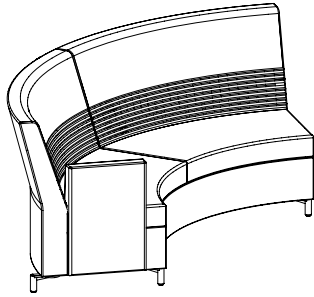

right shown

**1 Model**

**ZV6688-FOB-RA**  
**ZV6688-FOB-LA**

- upholstered seat, back and arms
- fabric application is railroad. Non-patterned fabrics are recommended
- tablet available, specify and add \$785 list for standard solid surface or \$663 list for laminate or veneer
- seat side power available, specify and add \$560 list; indicate right or left as seated and color Black (B) or White (W)
- power available in the left and right of the lower extreme back, USB-C+A add \$590 list or single simplex add \$410 list; specify USB or Simplex and color Black (B) or White (W)
- stand up surface with privacy screen available, add \$1,642; specify standard JSI laminate for top and the color of felt board for the privacy screen

**Specifications**

| Dimensions | D        | W      | H    |
|------------|----------|--------|------|
| Overall    | 42 ½     | 101 ½  | 36   |
| Seat       | 20 ½     | 59 ¼   | 17 ½ |
| Arm        |          |        | 26   |
| Upholstery | Shipping |        |      |
| COM Ydg    | 11 ¾     | Ctn Wt | 275  |
|            |          | Cu Ft  | 100  |

**List Price Per Grade**

|     |          |
|-----|----------|
| COM | \$6,922  |
| A   | \$7,119  |
| B   | \$7,502  |
| C   | \$8,177  |
| D   | \$9,041  |
| E   | \$9,905  |
| F   | \$10,820 |
| G   | \$12,117 |
| H   | \$13,500 |
| I   | \$15,661 |
| J   | \$18,257 |

**To Order, Specify:**

- 1 Model Number
- 2 Fabric Selection - vendor, pattern and color  
Visit [www.jsifurniture.com/finishes-and-materials/textiles](http://www.jsifurniture.com/finishes-and-materials/textiles) for our textiles program. See selection of standard and graded in manufacturers and patterns.
- 3 Tablet Table Option Selection  
[See Tablet Table Option Selection](#)
- 4 Side Power; see page [ZV1](#)
- 5 Back Power; see page [ZV1](#)
- 6 Standup Surface Laminate Color Selection  
[See Laminate Color Selection](#)

**Specifications**

- Fabric is railroaded.
- Non-patterned textile is recommended.
- Frame interior is upholstery grade plywood with glued solid hardwood cross members reinforced with wood screws.
- Seat has synthetic sheet webbing with cross strap and 3 ¾" thick high resiliency seat polyurethane multi-density foam.
- Back has 1 ¾" thick polyurethane foam, back lumbar has 10 channel stitch detail thru ¾" thick polyurethane foam.
- ¾" of high grade polyurethane foam covers a plywood constructed arm frame.

Description

1 Model

Specifications

List Price Per Grade

32" Radius Wedge with Inside Back

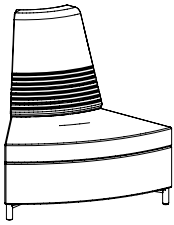

**ZV6651-IB**

- upholstered seat and back
- armless
- fabric application is railroad. Non-patterned fabrics are recommended
- seat side power available, specify and add \$560 list; indicate right or left as seated and color Black (B) or White (W)

| Dimensions | D      | W        | H      |
|------------|--------|----------|--------|
| Overall    | 32 3/4 | 47 3/8   | 36     |
| Seat       | 20 1/2 | 25 1/8   | 17 1/2 |
| Upholstery |        | Shipping |        |
| COM Ydg    | 4      | Ctn Wt   | 114    |
|            |        | Cu Ft    | 37     |

|     |         |
|-----|---------|
| COM | \$3,496 |
| A   | \$3,562 |
| B   | \$3,695 |
| C   | \$3,923 |
| D   | \$4,216 |
| E   | \$4,509 |
| F   | \$4,821 |
| G   | \$5,263 |
| H   | \$5,730 |
| I   | \$6,468 |
| J   | \$7,353 |

32" Radius Quarter Round with Partial Inside Back

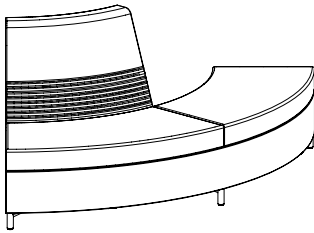

right shown

**ZV6688-RIB**  
**ZV6688-LIB**

- upholstered seat and back
- armless
- fabric application is railroad. Non-patterned fabrics are recommended
- seat side power available, specify and add \$560 list; indicate right or left as seated and color Black (B) or White (W)

| Dimensions | D      | W        | H      |
|------------|--------|----------|--------|
| Overall    | 39 1/2 | 87 5/8   | 36     |
| Seat       | 20 1/2 | 52 7/8   | 17 1/2 |
| Upholstery |        | Shipping |        |
| COM Ydg    | 5 1/2  | Ctn Wt   | 189    |
|            |        | Cu Ft    | 81     |

|     |          |
|-----|----------|
| COM | \$5,008  |
| A   | \$5,099  |
| B   | \$5,280  |
| C   | \$5,596  |
| D   | \$5,999  |
| E   | \$6,406  |
| F   | \$6,830  |
| G   | \$7,438  |
| H   | \$8,088  |
| I   | \$9,099  |
| J   | \$10,312 |

32" Radius Quarter Round with Inside Back

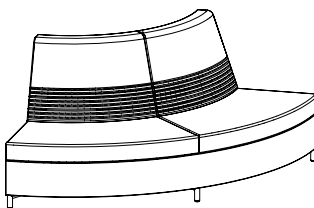

**ZV6688-FIB**

- upholstered seat and back
- armless
- fabric application is railroad. Non-patterned fabrics are recommended
- seat side power available, specify and add \$560 list; indicate right or left as seated and color Black (B) or White (W)

| Dimensions | D      | W        | H      |
|------------|--------|----------|--------|
| Overall    | 39 1/2 | 87 5/8   | 36     |
| Seat       | 20 1/2 | 45 5/8   | 17 1/2 |
| Upholstery |        | Shipping |        |
| COM Ydg    | 8      | Ctn Wt   | 231    |
|            |        | Cu Ft    | 81     |

|     |          |
|-----|----------|
| COM | \$6,320  |
| A   | \$6,450  |
| B   | \$6,713  |
| C   | \$7,172  |
| D   | \$7,761  |
| E   | \$8,348  |
| F   | \$8,969  |
| G   | \$9,856  |
| H   | \$10,796 |
| I   | \$12,270 |
| J   | \$14,034 |

**Description**

32" Radius Quarter Round with Inside Back

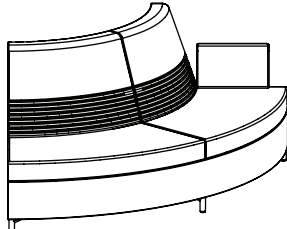

right shown

**1 Model**

**ZV6688-FIB-RA**  
**ZV6688-FIB-LA**

- upholstered seat, back and arms
- fabric application is railroad. Non-patterned fabrics are recommended
- tablet available, specify and add \$785 list for standard solid surface or \$663 list for laminate or veneer
- seat side power available, specify and add \$560 list; indicate right or left as seated and color Black (B) or White (W)

**Specifications**

| Dimensions | D        | W      | H    |
|------------|----------|--------|------|
| Overall    | 39 ½     | 87 ¾   | 36   |
| Seat       | 20 ½     | 45 ¾   | 17 ½ |
| Arm        |          |        | 26   |
| Upholstery | Shipping |        |      |
| COM Ydg    | 8 ¾      | Ctn Wt | 242  |
|            |          | Cu Ft  | 81   |

**List Price Per Grade**

|     |          |
|-----|----------|
| COM | \$6,813  |
| A   | \$6,956  |
| B   | \$7,242  |
| C   | \$7,744  |
| D   | \$8,388  |
| E   | \$9,034  |
| F   | \$9,712  |
| G   | \$10,677 |
| H   | \$11,709 |
| I   | \$13,318 |
| J   | \$15,252 |

**To Order, Specify:**

- 1 Model Number
- 2 Fabric Selection - vendor, pattern and color  
Visit [www.jsifurniture.com/finishes-and-materials/textiles](http://www.jsifurniture.com/finishes-and-materials/textiles) for our textiles program. See selection of standard and graded in manufacturers and patterns.
- 3 Side Power; see page [ZV1](#)

**Specifications**

- Fabric is railroaded.
- Non-patterned textile is recommended.
- Frame interior is upholstery grade plywood with glued solid hardwood cross members reinforced with wood screws.
- Seat has synthetic sheet webbing with cross strap and 3 ¾" thick high resiliency seat polyurethane multi-density foam.
- Back has 1 ¾" thick polyurethane foam, back lumbar has 10 channel stitch detail thru ¾" thick polyurethane foam.
- ¾" of high grade polyurethane foam covers a plywood constructed arm frame.

Description

1 Model

Specifications

List Price Per Grade

54" Radius Wedge with Outside Back

ZV6550-OB

- upholstered seat and back
- armless
- fabric application is railroad. Non-patterned fabrics are recommended
- seat side power available, specify and add \$560 list; indicate right or left as seated and color Black (B) or White (W)
- power available in the center of the lower extreme back, USB-C+A add \$295 list or single simplex add \$186 list; specify USB or Simplex and color Black (B) or White (W)
- stand up surface with privacy screen available, add \$666; specify standard JSI laminate for top and the color of felt board for the privacy screen

| Dimensions | D      | W        | H      |
|------------|--------|----------|--------|
| Overall    | 33 1/2 | 41 1/8   | 36     |
| Seat       | 20 1/2 | 18 1/4   | 17 1/2 |
| Upholstery |        | Shipping |        |
| COM Ydg    | 3 3/4  | Ctn Wt   | 78     |
|            |        | Cu Ft    | 34     |

|     |         |
|-----|---------|
| COM | \$2,941 |
| A   | \$3,003 |
| B   | \$3,124 |
| C   | \$3,336 |
| D   | \$3,610 |
| E   | \$3,882 |
| F   | \$4,305 |
| G   | \$4,759 |
| H   | \$5,244 |
| I   | \$6,002 |
| J   | \$6,910 |

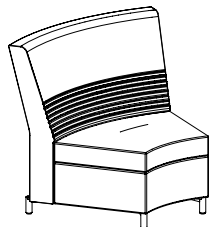

54" Radius Quarter Round with Partial Outside Back

ZV6588-ROB  
ZV6588-LOB

- upholstered seat and back
- armless
- fabric application is railroad. Non-patterned fabrics are recommended
- seat side power available, specify and add \$560 list; indicate right or left as seated and color Black (B) or White (W)
- power available in the center of the lower extreme back, USB-C+A add \$295 list or single simplex add \$186 list; specify USB or Simplex and color Black (B) or white (W)
- stand up surface with privacy screen available, add \$666; specify standard JSI laminate for top and the color of felt board for the privacy screen

| Dimensions | D      | W        | H      |
|------------|--------|----------|--------|
| Overall    | 42 1/2 | 95 1/8   | 36     |
| Seat       | 20 1/2 | 33 1/2   | 17 1/2 |
| Upholstery |        | Shipping |        |
| COM Ydg    | 4 3/4  | Ctn Wt   | 139    |
|            |        | Cu Ft    | 95     |

|     |         |
|-----|---------|
| COM | \$4,146 |
| A   | \$4,223 |
| B   | \$4,380 |
| C   | \$4,650 |
| D   | \$5,000 |
| E   | \$5,346 |
| F   | \$5,891 |
| G   | \$6,468 |
| H   | \$7,089 |
| I   | \$8,058 |
| J   | \$9,217 |

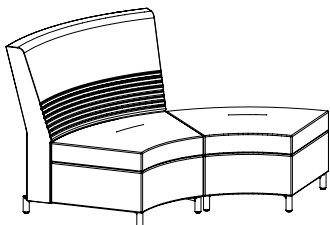

right shown

**Description**

**54" Radius Quarter Round with Outside Back**

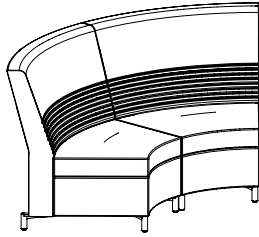

**1 Model**

**ZV6588-FOB**

- upholstered seat and back
- armless
- fabric application is railroad. Non-patterned fabrics are recommended
- seat side power available, specify and add \$560 list; indicate right or left as seated and color Black (B) or White (W)
- power available in the left and right of the lower extreme back, USB-C+A add \$590 list or single simplex add \$410 list; specify USB or Simplex and color Black (B) or white (W)
- stand up surface with privacy screen available, add \$1,427; specify standard JSI laminate for top and the color of felt board for the privacy screen

**Specifications**

| Dimensions | D    | W        | H    |
|------------|------|----------|------|
| Overall    | 44 ½ | 75 ¾     | 36   |
| Seat       | 20 ½ | 33 ½     | 17 ½ |
| Upholstery |      | Shipping |      |
| COM Ydg    | 6 ½  | Ctn Wt   | 132  |
|            |      | Cu Ft    | 81   |

**List Price Per Grade**

|     |          |
|-----|----------|
| COM | \$5,046  |
| A   | \$5,151  |
| B   | \$5,363  |
| C   | \$5,727  |
| D   | \$6,195  |
| E   | \$6,666  |
| F   | \$7,396  |
| G   | \$8,178  |
| H   | \$9,013  |
| I   | \$10,318 |
| J   | \$11,883 |

**54" Radius Quarter Round with Outside Back and Arm**

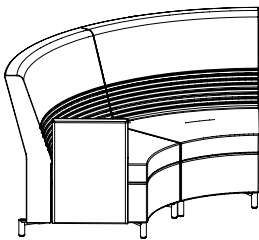

**ZV6588-FOB-RA**

**ZV6588-FOB-LA**

- upholstered seat, back and arms
- fabric application is railroad. Non-patterned fabrics are recommended
- tablet available, specify and add \$785 list for standard solid surface or \$663 list for laminate or veneer
- seat side power available, specify and add \$560 list; indicate right or left as seated and color Black (B) or White (W)
- power available in the left and right of the lower extreme back, USB-C+A add \$590 list or single simplex add \$410 list; specify USB or Simplex and color Black (B) or white (W)
- stand up surface with privacy screen available, add \$1,427; specify standard JSI laminate for top and the color of felt board for the privacy screen

| Dimensions | D    | W        | H    |
|------------|------|----------|------|
| Overall    | 45 ½ | 75 ¾     | 36   |
| Seat       | 20 ½ | 33 ½     | 17 ½ |
| Arm        |      |          | 26   |
| Upholstery |      | Shipping |      |
| COM Ydg    | 6 ¾  | Ctn Wt   | 142  |
|            |      | Cu Ft    | 81   |

|     |          |
|-----|----------|
| COM | \$5,288  |
| A   | \$5,404  |
| B   | \$5,627  |
| C   | \$6,022  |
| D   | \$6,530  |
| E   | \$7,037  |
| F   | \$7,827  |
| G   | \$8,671  |
| H   | \$9,576  |
| I   | \$10,983 |
| J   | \$12,677 |

**To Order, Specify:**

- 1 Model Number
- 2 Fabric Selection - vendor, pattern and color  
Visit [www.jsifurniture.com/finishes-and-materials/textiles](http://www.jsifurniture.com/finishes-and-materials/textiles) for our textiles program. See selection of standard and graded in manufacturers and patterns.
- 3 Tablet Table Option Selection  
[See Tablet Table Option Selection](#)
- 4 Side Power; see page [ZV1](#)
- 5 Back Power; see page [ZV1](#)
- 6 Standup Surface Laminate Color Selection  
[See Laminate Color Selection](#)

**Specifications**

- Fabric is railroaded.
- Non-patterned textile is recommended.
- Frame interior is upholstery grade plywood with glued solid hardwood cross members reinforced with wood screws.
- Seat has synthetic sheet webbing with cross strap and 3 ¾" thick high resiliency seat polyurethane multi-density foam.
- Back has 1 ¾" thick polyurethane foam, back lumbar has 10 channel stitch detail thru ¾" thick polyurethane foam.
- ¾" of high grade polyurethane foam covers a plywood constructed arm frame.

Description

① Model

Specifications

List Price Per Grade

14" Radius Wedge with Inside Back

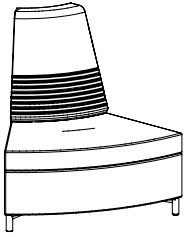

**ZV6551-IB**

- upholstered seat and back
- armless
- fabric application is railroad. Non-patterned fabrics are recommended
- seat side power available, specify and add \$560 list; indicate right or left as seated and color Black (B) or White (W)

| Dimensions | D      | W        | H      |
|------------|--------|----------|--------|
| Overall    | 32 3/4 | 36 3/8   | 36     |
| Seat       | 20 1/2 | 19 1/2   | 17 1/2 |
| Upholstery |        | Shipping |        |
| COM Ydg    | 3      | Ctn Wt   | 115    |
|            |        | Cu Ft    | 29     |

|     |         |
|-----|---------|
| COM | \$2,644 |
| A   | \$2,693 |
| B   | \$2,791 |
| C   | \$2,959 |
| D   | \$3,179 |
| E   | \$3,401 |
| F   | \$3,744 |
| G   | \$4,107 |
| H   | \$4,499 |
| I   | \$5,106 |
| J   | \$5,840 |

14" Radius Quarter Round with Inside Back

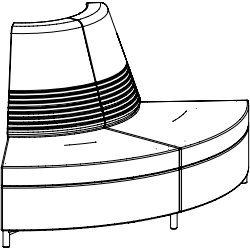

**ZV6588-FIB**

- upholstered seat and back
- armless
- fabric application is railroad. Non-patterned fabrics are recommended
- seat side power available, specify and add \$560 list; indicate right or left as seated and color Black (B) or White (W)

| Dimensions | D      | W        | H      |
|------------|--------|----------|--------|
| Overall    | 39 1/2 | 66 1/2   | 36     |
| Seat       | 20 1/2 | 35 1/2   | 17 1/2 |
| Upholstery |        | Shipping |        |
| COM Ydg    | 5      | Ctn Wt   | 102    |
|            |        | Cu Ft    | 63     |

|     |         |
|-----|---------|
| COM | \$4,465 |
| A   | \$4,552 |
| B   | \$4,718 |
| C   | \$5,014 |
| D   | \$5,392 |
| E   | \$5,772 |
| F   | \$6,361 |
| G   | \$6,991 |
| H   | \$7,665 |
| I   | \$8,716 |
| J   | \$9,980 |

Description

14" Radius Quarter Round with Inside Back and Arm

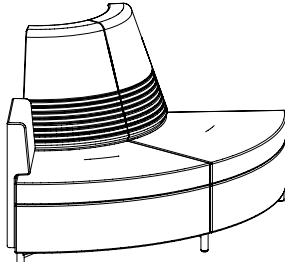

right shown

1 Model

ZV6588-FIB-RA  
ZV6588-FIB-LA

- upholstered seat, back and arms
- fabric application is railroad. Non-patterned fabrics are recommended
- tablet available, specify and add \$785 list for standard solid surface or \$663 list for laminate or veneer
- seat side power available, specify and add \$560 list; indicate right or left as seated and color Black (B) or White (W)

Specifications

| Dimensions | D        | W      | H    |
|------------|----------|--------|------|
| Overall    | 39 ½     | 66 ½   | 36   |
| Seat       | 20 ½     | 35 ½   | 17 ½ |
| Arm        |          |        | 26   |
| Upholstery | Shipping |        |      |
| COM Ydg    | 5 ¾      | Ctn Wt | 112  |
|            |          | Cu Ft  | 63   |

List Price Per Grade

|     |          |
|-----|----------|
| COM | \$4,671  |
| A   | \$4,767  |
| B   | \$4,955  |
| C   | \$5,285  |
| D   | \$5,709  |
| E   | \$6,133  |
| F   | \$6,793  |
| G   | \$7,499  |
| H   | \$8,255  |
| I   | \$9,433  |
| J   | \$10,848 |

To Order, Specify:

- 1 Model Number
- 2 Fabric Selection - vendor, pattern and color  
Visit [www.jsifurniture.com/finishes-and-materials/textiles](http://www.jsifurniture.com/finishes-and-materials/textiles) for our textiles program. See selection of standard and graded in manufacturers and patterns.
- 3 Side Power; see page [ZV1](#)

Specifications

- Fabric is railroaded.
- Non-patterned textile is recommended.
- Frame interior is upholstery grade plywood with glued solid hardwood cross members reinforced with wood screws.
- Seat has synthetic sheet webbing with cross strap and 3 ¾" thick high resiliency seat polyurethane multi-density foam.
- Back has 1 ¾" thick polyurethane foam, back lumbar has 10 channel stitch detail thru ¾" thick polyurethane foam.
- ¾" of high grade polyurethane foam covers a plywood constructed arm frame.

Description

① Model

Specifications

List Price Per Grade

Singe Seat Bench

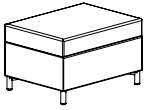

**ZV6628**

- upholstered seat
- fabric application is railroad. Non-patterned fabrics are recommended
- seat side power available, specify and add \$560 list; indicate right or left as seated and color Black (B) or White (W)

| Dimensions | D    | W        | H    |
|------------|------|----------|------|
| Overall    | 20 ½ | 27 ½     | 17 ½ |
| Upholstery |      | Shipping |      |
| COM Ydg    | 2    | Ctn Wt   | 50   |
|            |      | Cu Ft    | 7    |

|     |         |
|-----|---------|
| COM | \$2,171 |
| A   | \$2,208 |
| B   | \$2,271 |
| C   | \$2,387 |
| D   | \$2,532 |
| E   | \$2,679 |
| F   | \$2,837 |
| G   | \$3,055 |
| H   | \$3,291 |
| I   | \$3,661 |
| J   | \$4,100 |

Two Seat Bench

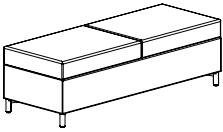

**ZV6655**

- upholstered seat
- fabric application is railroad. Non-patterned fabrics are recommended
- seat side power available, specify and add \$560 list; indicate right or left as seated and color Black (B) or White (W)

| Dimensions | D    | W        | H    |
|------------|------|----------|------|
| Overall    | 20 ½ | 55       | 17 ½ |
| Upholstery |      | Shipping |      |
| COM Ydg    | 4    | Ctn Wt   | 73   |
|            |      | Cu Ft    | 14   |

|     |         |
|-----|---------|
| COM | \$3,683 |
| A   | \$3,751 |
| B   | \$3,881 |
| C   | \$4,111 |
| D   | \$4,405 |
| E   | \$4,701 |
| F   | \$5,009 |
| G   | \$5,452 |
| H   | \$5,922 |
| I   | \$6,661 |
| J   | \$7,544 |

Three Seat Bench

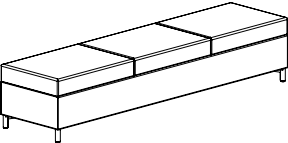

**ZV6683**

- upholstered seat
- fabric application is railroad. Non-patterned fabrics are recommended
- seat side power available, specify and add \$560 list; indicate right or left as seated and color Black (B) or White (W)

| Dimensions | D    | W        | H    |
|------------|------|----------|------|
| Overall    | 20 ½ | 82 ½     | 17 ½ |
| Upholstery |      | Shipping |      |
| COM Ydg    | 6    | Ctn Wt   | 146  |
|            |      | Cu Ft    | 21   |

|     |          |
|-----|----------|
| COM | \$5,260  |
| A   | \$5,359  |
| B   | \$5,557  |
| C   | \$5,899  |
| D   | \$6,344  |
| E   | \$6,781  |
| F   | \$7,248  |
| G   | \$7,908  |
| H   | \$8,615  |
| I   | \$9,722  |
| J   | \$11,047 |



**Description**

**1 Model**

**Specifications**

**List Price Per Grade**

**72" Radius Wedge Bench**

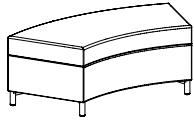

**ZV6647**

- upholstered seat
- fabric application is railroad. Non-patterned fabrics are recommended
- seat side power available, specify and add \$560 list; indicate right or left as seated and color Black (B) or White (W)

| Dimensions | D      | W        | H      |
|------------|--------|----------|--------|
| Overall    | 23 5/8 | 47 3/8   | 17 1/2 |
| Upholstery |        | Shipping |        |
| COM Ydg    | 2 3/4  | Ctn Wt   | 57     |
|            |        | Cu Ft    | 14     |

|     |         |
|-----|---------|
| COM | \$2,282 |
| A   | \$2,328 |
| B   | \$2,419 |
| C   | \$2,580 |
| D   | \$2,781 |
| E   | \$2,984 |
| F   | \$3,197 |
| G   | \$3,502 |
| H   | \$3,826 |
| I   | \$4,330 |
| J   | \$4,937 |

**72" Radius Quarter Round Bench**

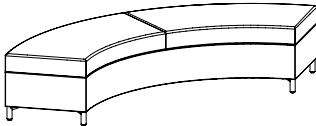

**ZV6688**

- upholstered seat
- fabric application is railroad. Non-patterned fabrics are recommended
- seat side power available, specify and add \$560 list; indicate right or left as seated and color Black (B) or White (W)

| Dimensions | D      | W        | H      |
|------------|--------|----------|--------|
| Overall    | 32 5/8 | 87 5/8   | 17 1/2 |
| Upholstery |        | Shipping |        |
| COM Ydg    | 5 1/2  | Ctn Wt   | 105    |
|            |        | Cu Ft    | 34     |

|     |         |
|-----|---------|
| COM | \$4,024 |
| A   | \$4,114 |
| B   | \$4,295 |
| C   | \$4,611 |
| D   | \$5,014 |
| E   | \$5,418 |
| F   | \$5,848 |
| G   | \$6,454 |
| H   | \$7,103 |
| I   | \$8,115 |
| J   | \$9,330 |

**54" Radius Wedge Bench**

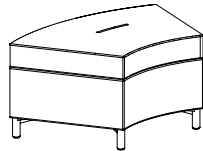

**ZV6547**

- upholstered seat
- armless
- fabric application is railroad. Non-patterned fabrics are recommended

| Dimensions | D      | W        | H      |
|------------|--------|----------|--------|
| Overall    | 29 5/8 | 34 3/8   | 17 1/2 |
| Upholstery |        | Shipping |        |
| COM Ydg    | 2      | Ctn Wt   | 34     |
|            |        | Cu Ft    | 13     |

|     |         |
|-----|---------|
| COM | \$2,021 |
| A   | \$2,054 |
| B   | \$2,125 |
| C   | \$2,241 |
| D   | \$2,394 |
| E   | \$2,546 |
| F   | \$2,781 |
| G   | \$3,034 |
| H   | \$3,303 |
| I   | \$3,722 |
| J   | \$4,229 |

**54" Radius Quarter Round Bench**

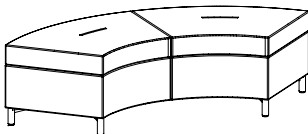

**ZV6588**

- upholstered seat
- armless
- fabric application is railroad. Non-patterned fabrics are recommended

| Dimensions | D      | W        | H      |
|------------|--------|----------|--------|
| Overall    | 32 5/8 | 63 5/8   | 17 1/2 |
| Upholstery |        | Shipping |        |
| COM Ydg    | 3      | Ctn Wt   | 63     |
|            |        | Cu Ft    | 26     |

|     |         |
|-----|---------|
| COM | \$3,216 |
| A   | \$3,266 |
| B   | \$3,368 |
| C   | \$3,546 |
| D   | \$3,770 |
| E   | \$3,998 |
| F   | \$4,353 |
| G   | \$4,734 |
| H   | \$5,135 |
| I   | \$5,767 |
| J   | \$6,526 |

**To Order, Specify:**

- 1 Model Number
- 2 Fabric Selection - vendor, pattern and color  
Visit [www.jsifurniture.com/finishes-and-materials/textiles](http://www.jsifurniture.com/finishes-and-materials/textiles) for our textiles program. See selection of standard and graded in manufacturers and patterns.

**Specifications**

- Fabric is railroaded.
- Non-patterned textile is recommended.
- Frame interior is upholstery grade plywood with glued solid hardwood cross members reinforced with wood screws.
- Seat has synthetic sheet webbing with cross strap and 3 5/8" thick high resiliency seat polyurethane multi-density foam.
- Back has 1 3/4" thick polyurethane foam, back lumbar has 10 channel stitch detail thru 3/8" thick polyurethane foam.
- 3/4" of high grade polyurethane foam covers a plywood constructed arm frame.
- Linking bracket included.

Description

**1 Model**

Specifications

List Price Per Grade

48" dia. Ottoman



**ZV6648**

- upholstered seat
- fabric application is railroad. Non-patterned fabrics are recommended

| Dimensions | D  | W        | H    |
|------------|----|----------|------|
| Overall    | 48 | 48       | 17 ½ |
| Upholstery |    | Shipping |      |
| COM Ydg    | 4  | Ctn Wt   | 95   |
|            |    | Cu Ft    | 27   |

|     |         |
|-----|---------|
| COM | \$3,090 |
| A   | \$3,159 |
| B   | \$3,288 |
| C   | \$3,518 |
| D   | \$3,811 |
| E   | \$4,107 |
| F   | \$4,419 |
| G   | \$4,859 |
| H   | \$5,329 |
| I   | \$6,066 |
| J   | \$6,951 |

42" dia. Ottoman

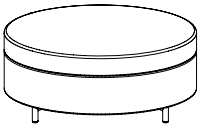

**ZV6642**

- upholstered seat
- fabric application is railroad. Non-patterned fabrics are recommended

| Dimensions | D  | W        | H    |
|------------|----|----------|------|
| Overall    | 42 | 42       | 17 ½ |
| Upholstery |    | Shipping |      |
| COM Ydg    | 4  | Ctn Wt   | 79   |
|            |    | Cu Ft    | 21   |

|     |         |
|-----|---------|
| COM | \$2,605 |
| A   | \$2,671 |
| B   | \$2,803 |
| C   | \$3,033 |
| D   | \$3,325 |
| E   | \$3,621 |
| F   | \$3,931 |
| G   | \$4,374 |
| H   | \$4,844 |
| I   | \$5,579 |
| J   | \$6,465 |

36" dia. Ottoman

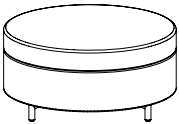

**ZV6636**

- upholstered seat
- fabric application is railroad. Non-patterned fabrics are recommended

| Dimensions | D   | W        | H    |
|------------|-----|----------|------|
| Overall    | 36  | 36       | 17 ½ |
| Upholstery |     | Shipping |      |
| COM Ydg    | 3 ½ | Ctn Wt   | 65   |
|            |     | Cu Ft    | 16   |

|     |         |
|-----|---------|
| COM | \$2,099 |
| A   | \$2,160 |
| B   | \$2,274 |
| C   | \$2,472 |
| D   | \$2,730 |
| E   | \$2,988 |
| F   | \$3,263 |
| G   | \$3,648 |
| H   | \$4,061 |
| I   | \$4,703 |
| J   | \$5,476 |

Description

24" dia. Ottoman

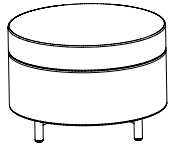

1 Model

ZV6624

- upholstered seat
- fabric application is railroad.
- Non-patterned fabrics are recommended

Specifications

| Dimensions | D     | W        | H      |
|------------|-------|----------|--------|
| Overall    | 24    | 24       | 17 1/2 |
| Upholstery |       | Shipping |        |
| COM Ydg    | 1 1/2 | Ctn Wt   | 48     |
|            |       | Cu Ft    | 8      |

List Price Per Grade

|     |         |
|-----|---------|
| COM | \$1,626 |
| A   | \$1,652 |
| B   | \$1,702 |
| C   | \$1,790 |
| D   | \$1,905 |
| E   | \$2,017 |
| F   | \$2,194 |
| G   | \$2,382 |
| H   | \$2,588 |
| I   | \$2,901 |
| J   | \$3,280 |

To Order, Specify:

- 1 Model Number
- 2 Fabric Selection - vendor, pattern and color  
Visit [www.jsifurniture.com/finishes-and-materials/textiles](http://www.jsifurniture.com/finishes-and-materials/textiles) for our textiles program. See selection of standard and graded in manufacturers and patterns.

Specifications

- Fabric is railroaded.
- Non-patterned textile is recommended.
- Frame interior is upholstery grade plywood with glued solid hardwood cross members reinforced with wood screws.
- Seat has synthetic sheet webbing with cross strap and 3 3/8" thick high resiliency seat polyurethane multi-density foam.
- Back has 1 3/4" thick polyurethane foam, back lumbar has 10 channel stitch detail thru 3/8" thick polyurethane foam.
- 3/4" of high grade polyurethane foam covers a plywood constructed arm frame.
- Linking bracket included.

# Ziva

## MODULAR



### Description

### 1 Model

### Specifications

### List Price Per Grade

Square Corner Unit  
Center - Fabric Diagonal

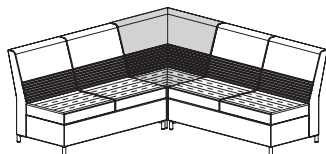
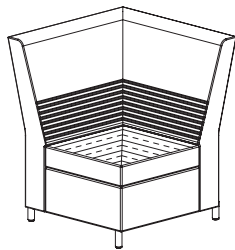

\*CUD - in application

#### ZV6600-CUD

- upholstered seat and back
- fabric runs diagonal
- power available in the left and right of the lower extreme back, USB-C+A add \$590 list or single simplex add \$410 list; specify USB or Simplex and color Black (B) or White (W)
- stand up surface with privacy screen available, add \$819; specify standard JSI laminate for top and the color of felt board for the privacy screen

| Dimensions | D      | W        | H      |
|------------|--------|----------|--------|
| Overall    | 30 3/8 | 30 3/8   | 36     |
| Seat       | 20 1/2 | 20 1/2   | 17 1/2 |
| Upholstery |        | Shipping |        |
| COM Ydg    | 4      | Ctn Wt   | 79     |
|            |        | Cu Ft    | 30     |

|     |         |
|-----|---------|
| COM | \$3,266 |
| A   | \$3,331 |
| B   | \$3,457 |
| C   | \$3,678 |
| D   | \$3,963 |
| E   | \$4,246 |
| F   | \$4,692 |
| G   | \$5,166 |
| H   | \$5,671 |
| I   | \$6,464 |
| J   | \$7,412 |

Square Corner Unit  
Right - Fabric Runs Right

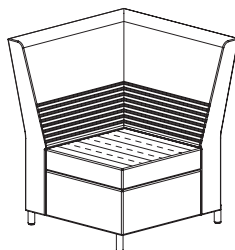

right shown

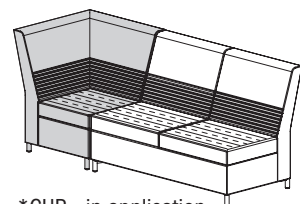

\*CUR - in application

#### ZV6600-CUR

#### ZV6600-CUL

- upholstered seat and back
- fabric runs to the right
- seat side power available, specify and add \$560 list; indicate color Black (B) or White (W)
- power available in the left and right of the lower extreme back, USB-C+A add \$590 list or single simplex add \$410 list; specify USB or Simplex and color Black (B) or White (W)
- stand up surface with privacy screen available, add \$819; specify standard JSI laminate for top and the color of felt board for the privacy screen

| Dimensions | D      | W        | H      |
|------------|--------|----------|--------|
| Overall    | 30 3/8 | 30 3/8   | 36     |
| Seat       | 20 1/2 | 20 1/2   | 17 1/2 |
| Upholstery |        | Shipping |        |
| COM Ydg    | 4      | Ctn Wt   | 79     |
|            |        | Cu Ft    | 30     |

|     |         |
|-----|---------|
| COM | \$3,266 |
| A   | \$3,331 |
| B   | \$3,457 |
| C   | \$3,678 |
| D   | \$3,963 |
| E   | \$4,246 |
| F   | \$4,692 |
| G   | \$5,166 |
| H   | \$5,671 |
| I   | \$6,464 |
| J   | \$7,412 |

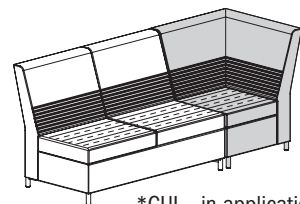

\*CUL - in application

Description

1 Model

Specifications

List Price Per Grade

Corner Table Unit with Upholstery  
- Laminate Diagonal

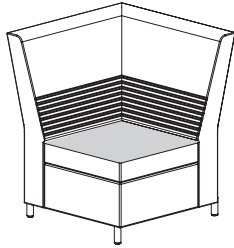

ZV6600-CTF

- upholstered back and worksurface
- fabric runs to the left
- surface is laminate
- power available in the left and right of the lower extreme back, USB-C+A add \$590 list or single simplex add \$410 list; specify USB or Simplex and color Black (B) or White (W)
- stand up surface with privacy screen available, add \$819; specify standard JSI laminate for top and the color of felt board for the privacy screen

| Dimensions | D      | W        | H      |
|------------|--------|----------|--------|
| Overall    | 30 3/8 | 30 3/8   | 36     |
| Seat       | 20 1/2 | 20 1/2   | 17 1/2 |
| Upholstery |        | Shipping |        |
| COM Ydg    | 4      | Ctn Wt   | 82     |
|            |        | Cu Ft    | 30     |

|     |         |
|-----|---------|
| COM | \$3,405 |
| A   | \$3,465 |
| B   | \$3,588 |
| C   | \$3,799 |
| D   | \$4,075 |
| E   | \$4,347 |
| F   | \$4,774 |
| G   | \$5,231 |
| H   | \$5,716 |
| I   | \$6,476 |
| J   | \$7,388 |

Corner Table Unit with Upholstery -  
Veneer Diagonal

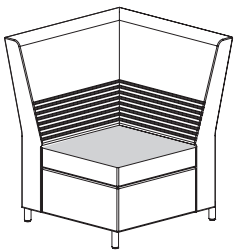

ZV6600-CVV

- upholstered back and worksurface
- fabric runs diagonal
- surface is veneer - grain runs diagonal
- power available in the left and right of the lower extreme back, USB-C+A add \$590 list or single simplex add \$410 list; specify USB or Simplex and color Black (B) or White (W)
- stand up surface with privacy screen available, add \$819; specify standard JSI laminate for top and the color of felt board for the privacy screen

| Dimensions | D      | W        | H      |
|------------|--------|----------|--------|
| Overall    | 30 3/8 | 30 3/8   | 36     |
| Seat       | 20 1/2 | 20 1/2   | 17 1/2 |
| Upholstery |        | Shipping |        |
| COM Ydg    | 4      | Ctn Wt   | 82     |
|            |        | Cu Ft    | 30     |

|     |         |
|-----|---------|
| COM | \$3,690 |
| A   | \$3,749 |
| B   | \$3,869 |
| C   | \$4,085 |
| D   | \$4,359 |
| E   | \$4,633 |
| F   | \$5,057 |
| G   | \$5,515 |
| H   | \$6,001 |
| I   | \$6,762 |
| J   | \$7,677 |

To Order, Specify:

- 1 Model Number
- 2 Fabric Selection - vendor, pattern and color  
Visit [www.jsifurniture.com/finishes-and-materials/textiles](http://www.jsifurniture.com/finishes-and-materials/textiles) for our textiles program. See selection of standard and graded in manufacturers and patterns.
- 3 Back Power; see page ZV1
- 4 Standup Surface Laminate Color Selection  
[See Laminate Color Selection](#)

Specifications

- Fabric is railroaded.
- Non-patterned textile is recommended.
- Frame interior is upholstery grade plywood with glued solid hardwood cross members reinforced with wood screws.
- Seat has synthetic sheet webbing with cross strap and 3 3/8" thick high resiliency seat polyurethane multi-density foam.
- Back has 1 3/4" thick polyurethane foam, back lumbar has 10 channel stitch detail thru 3/8" thick polyurethane foam.
- 3/4" of high grade polyurethane foam covers a plywood constructed arm frame.

# Ziva

## MODULAR

### Description

### Model

### Specifications

### List Price Per Grade

Square Corner Ottoman -  
Fabric Diagonal

#### ZV6610-BD

- fabric runs to the left
- fabric runs diagonal
- seat side power available, specify and add \$560 list; indicate right or left as seated and color Black (B) or White (W)

| Dimensions | D  | W        | H   |
|------------|----|----------|-----|
| Overall    | 26 | 26       | 17½ |
| Seat       | 26 | 26       | 17½ |
| Upholstery |    | Shipping |     |
| COM Ydg    | 2½ | Ctn Wt   | 43  |
|            |    | Cu Ft    | 10  |

|     |         |
|-----|---------|
| COM | \$2,057 |
| A   | \$2,096 |
| B   | \$2,171 |
| C   | \$2,306 |
| D   | \$2,475 |
| E   | \$2,648 |
| F   | \$2,913 |
| G   | \$3,199 |
| H   | \$3,505 |
| I   | \$3,984 |
| J   | \$4,554 |

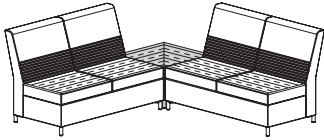
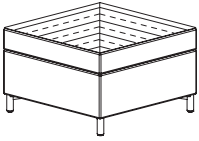

Square Corner Ottoman-  
Fabric Railroad

#### ZV6610-BR

- fabric runs railroad
- seat side power available, specify and add \$560 list; indicate right or left as seated and color Black (B) or White (W)

| Dimensions | D  | W        | H   |
|------------|----|----------|-----|
| Overall    | 26 | 26       | 17½ |
| Seat       | 26 | 26       | 17½ |
| Upholstery |    | Shipping |     |
| COM Ydg    | 2½ | Ctn Wt   | 43  |
|            |    | Cu Ft    | 10  |

|     |         |
|-----|---------|
| COM | \$2,057 |
| A   | \$2,096 |
| B   | \$2,171 |
| C   | \$2,306 |
| D   | \$2,475 |
| E   | \$2,648 |
| F   | \$2,913 |
| G   | \$3,199 |
| H   | \$3,505 |
| I   | \$3,984 |
| J   | \$4,554 |

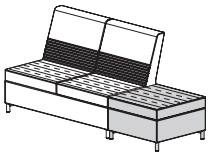
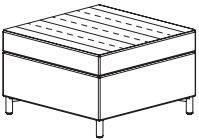

**Description**

**1 Model**

**Specifications**

**List Price Per Grade**

Table Ottoman with Upholstery -  
Veneer Surface

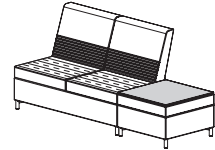
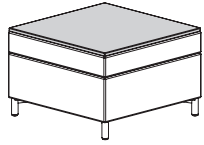

**ZV6610-TVW**

- veneer top
- fabric chassis
- surface is veneer
- seat side power available, specify and add \$560 list; indicate right or left as seated and color Black (B) or White (W)

| Dimensions | D  | W        | H   |
|------------|----|----------|-----|
| Overall    | 26 | 26       | 17½ |
| Seat       | 26 | 26       | 17½ |
| Upholstery |    | Shipping |     |
| COM Ydg    | 2½ | Ctn Wt   | 46  |
|            |    | Cu Ft    | 10  |

|     |         |
|-----|---------|
| COM | \$2,544 |
| A   | \$2,581 |
| B   | \$2,658 |
| C   | \$2,791 |
| D   | \$2,962 |
| E   | \$3,133 |
| F   | \$3,403 |
| G   | \$3,689 |
| H   | \$3,992 |
| I   | \$4,470 |
| J   | \$5,040 |

Table Ottoman with Upholstery -  
Laminate Surface

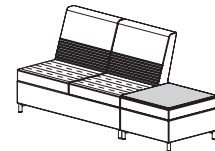
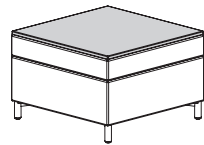

**ZV6610-TTF**

- laminate top
- fabric chassis
- surface is laminate
- seat side power available, specify and add \$560 list; indicate right or left as seated and color Black (B) or White (W)

| Dimensions | D  | W        | H   |
|------------|----|----------|-----|
| Overall    | 26 | 26       | 17½ |
| Seat       | 26 | 26       | 17½ |
| Upholstery |    | Shipping |     |
| COM Ydg    | 2½ | Ctn Wt   | 46  |
|            |    | Cu Ft    | 10  |

|     |         |
|-----|---------|
| COM | \$2,255 |
| A   | \$2,294 |
| B   | \$2,370 |
| C   | \$2,504 |
| D   | \$2,675 |
| E   | \$2,847 |
| F   | \$3,116 |
| G   | \$3,401 |
| H   | \$3,705 |
| I   | \$4,182 |
| J   | \$4,752 |

**To Order, Specify:**

- 1 Model Number
- 2 Fabric Selection - vendor, pattern and color  
Visit [www.jsifurniture.com/finishes-and-materials/textiles](http://www.jsifurniture.com/finishes-and-materials/textiles) for our textiles program. See selection of standard and graded in manufacturers and patterns.
- 3 Side Power; see page [ZV1](#)

**Specifications**

- Fabric is railroaded.
- Non-patterned textile is recommended.
- Frame interior is upholstery grade plywood with glued solid hardwood cross members reinforced with wood screws.
- Seat has synthetic sheet webbing with cross strap and 3 ¾" thick high resiliency seat polyurethane multi-density foam.
- Back has 1 ¾" thick polyurethane foam, back lumbar has 10 channel stitch detail thru ¾" thick polyurethane foam.
- ¾" of high grade polyurethane foam covers a plywood constructed arm frame.

# Ziva

## MODULAR



### Description

### Model

### Specifications

### List Price Per Grade

Table Ottoman with Upholstery -  
Veneer Surface Diagonal Grain

#### ZV6610-DWV

- veneer top - grain runs diagonal
- fabric chassis
- surface is veneer - grain runs diagonal
- seat side power available, specify and add \$560 list; indicate right or left as seated and color Black (B) or White (W)

| Dimensions | D  | W        | H   |
|------------|----|----------|-----|
| Overall    | 26 | 26       | 17½ |
| Seat       | 26 | 26       | 17½ |
| Upholstery |    | Shipping |     |
| COM Ydg    | 2½ | Ctn Wt   | 46  |
|            |    | Cu Ft    | 10  |

|     |         |
|-----|---------|
| COM | \$2,544 |
| A   | \$2,581 |
| B   | \$2,658 |
| C   | \$2,791 |
| D   | \$2,962 |
| E   | \$3,133 |
| F   | \$3,403 |
| G   | \$3,689 |
| H   | \$3,992 |
| I   | \$4,470 |
| J   | \$5,040 |

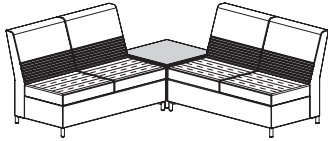
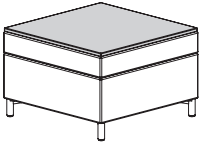

Table Ottoman with Upholstery -  
Laminate Surface Diagonal Grain

#### ZV6610-DTF

- laminate top- grain runs diagonal
- fabric chassis
- surface is laminate - grain runs diagonal
- seat side power available, specify and add \$560 list; indicate right or left as seated and color Black (B) or White (W)

| Dimensions | D  | W        | H   |
|------------|----|----------|-----|
| Overall    | 26 | 26       | 17½ |
| Seat       | 26 | 26       | 17½ |
| Upholstery |    | Shipping |     |
| COM Ydg    | 2½ | Ctn Wt   | 46  |
|            |    | Cu Ft    | 10  |

|     |         |
|-----|---------|
| COM | \$2,255 |
| A   | \$2,294 |
| B   | \$2,370 |
| C   | \$2,504 |
| D   | \$2,675 |
| E   | \$2,847 |
| F   | \$3,116 |
| G   | \$3,401 |
| H   | \$3,705 |
| I   | \$4,182 |
| J   | \$4,752 |

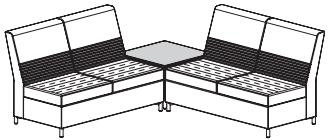
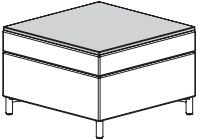



Description

Table Ottoman with Upholstery -  
Solid Surface

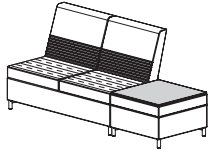
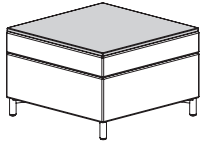

1 Model

ZV6610-TSS

- solid surface top
- fabric chassis
- surface is solid surface
- seat side power available, specify and add \$560 list; indicate right or left as seated and color Black (B) or White (W)

Specifications

| Dimensions | D  | W        | H   |
|------------|----|----------|-----|
| Overall    | 26 | 26       | 17½ |
| Seat       | 26 | 26       | 17½ |
| Upholstery |    | Shipping |     |
| COM Ydg    | 2½ | Ctn Wt   | 46  |
|            |    | Cu Ft    | 10  |

List Price Per Grade

|     |         |
|-----|---------|
| COM | \$3,022 |
| A   | \$3,064 |
| B   | \$3,139 |
| C   | \$3,272 |
| D   | \$3,443 |
| E   | \$3,614 |
| F   | \$3,881 |
| G   | \$4,167 |
| H   | \$4,180 |
| I   | \$4,948 |
| J   | \$5,521 |

To Order, Specify:

- 1 Model Number
- 2 Fabric Selection - vendor, pattern and color  
Visit [www.jsifurniture.com/finishes-and-materials/textiles](http://www.jsifurniture.com/finishes-and-materials/textiles) for our textiles program. See selection of standard and graded in manufacturers and patterns.
- 3 Side Power; see page [ZV1](#)

Specifications

- Fabric is railroaded.
- Non-patterned textile is recommended.
- Frame interior is upholstery grade plywood with glued solid hardwood cross members reinforced with wood screws.
- Seat has synthetic sheet webbing with cross strap and 3 ¾" thick high resiliency seat polyurethane multi-density foam.
- Back has 1 ¾" thick polyurethane foam, back lumbar has 10 channel stitch detail thru ¾" thick polyurethane foam.
- ¾" of high grade polyurethane foam covers a plywood constructed arm frame.

Description

1 Model

Specifications

List Price Per Grade

72" Radius Quarter Round with Partial Outside Back and Right Arm

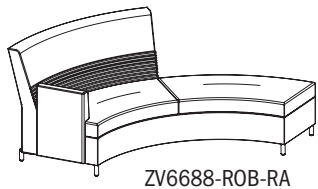

ZV6688-ROB-RA

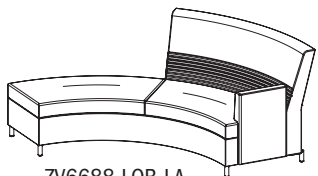

ZV6688-LOB-LA

**ZV6688-ROB-RA**  
**ZV6688-LOB-LA**

- upholstered seat and back
- fabric application is railroad. Non-patterned fabrics are recommended
- seat side power available, specify and add \$560 list; indicate right or left as seated and color Black (B) or White (W)
- power available in the center of the lower extreme back, USB-C+A add \$295 list or single simplex add \$186 list; specify USB or Simplex and color Black (B) or White (W)
- stand up surface with privacy screen available, add \$876; specify standard JSI laminate for top and the color of felt board for the privacy screen
- tablet available, specify and add \$785 list for standard solid surface or \$663 list for laminate or veneer

| Dimensions | D        | W      | H      |
|------------|----------|--------|--------|
| Overall    | 42 1/2   | 95 7/8 | 36     |
| Seat       | 20 1/2   | 26     | 17 1/2 |
| Arm        |          |        |        |
| Upholstery | Shipping |        |        |
| COM Ydg    | 7 3/4    | Ctn Wt | 231    |
|            |          | Cu Ft  | 92     |

|     |          |
|-----|----------|
| COM | \$5,558  |
| A   | \$5,692  |
| B   | \$5,947  |
| C   | \$6,396  |
| D   | \$6,973  |
| E   | \$7,554  |
| F   | \$8,195  |
| G   | \$9,069  |
| H   | \$10,003 |
| I   | \$11,467 |
| J   | \$13,218 |

72" Radius Quarter Round with Outside Back and Center Arm

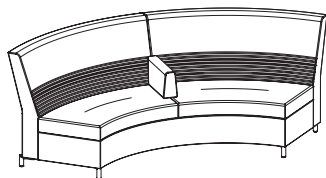

**ZV6688-FOB-CA**

- upholstered seat and back
- fabric application is railroad. Non-patterned fabrics are recommended
- seat side power available, specify and add \$560 list; indicate right or left as seated and color Black (B) or White (W)
- power available in the left and right of the lower extreme back, USB-C+A add \$590 list or single simplex add \$410 list; specify USB or Simplex and color Black (B) or White (W)
- stand up surface with privacy screen available, add \$1,642; specify standard JSI laminate for top and the color of felt board for the privacy screen

| Dimensions | D        | W       | H      |
|------------|----------|---------|--------|
| Overall    | 42 1/2   | 101 1/2 | 36     |
| Seat       | 20 1/2   | 26      | 17 1/2 |
| Upholstery | Shipping |         |        |
| COM Ydg    | 11 3/4   | Ctn Wt  | 190    |
|            |          | Cu Ft   | 100    |

|     |          |
|-----|----------|
| COM | \$6,928  |
| A   | \$7,125  |
| B   | \$7,512  |
| C   | \$8,191  |
| D   | \$9,061  |
| E   | \$9,937  |
| F   | \$10,886 |
| G   | \$12,203 |
| H   | \$13,609 |
| I   | \$15,805 |
| J   | \$18,441 |

**Description**

72" Radius Quarter Round with Outside Back and Right and Center Arm

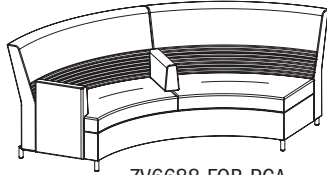

ZV6688-FOB-RCA

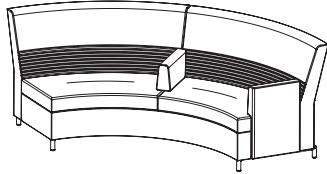

ZV6688-FOB-LCA

**1 Model**

**ZV6688-FOB-RCA**  
**ZV6688-FOB-LCA**

- upholstered seat and back
- fabric application is railroad. Non-patterned fabrics are recommended
- seat side power available, specify and add \$560 list; indicate right or left as seated and color Black (B) or White (W)
- power available in the left and right of the lower extreme back, USB-C+A add \$590 list or single simplex add \$410 list; specify USB or Simplex and color Black (B) or White (W)
- stand up surface with privacy screen available, add \$1,642; specify standard JSI laminate for top and the color of felt board for the privacy screen

**Specifications**

| Dimensions | D        | W      | H    |
|------------|----------|--------|------|
| Overall    | 42 ½     | 101 ½  | 36   |
| Seat       | 20 ½     | 26     | 17 ½ |
| Arm        |          |        |      |
| Upholstery | Shipping |        |      |
| COM Ydg    | 12 ½     | Ctn Wt | 200  |
|            |          | Cu Ft  | 100  |

**List Price Per Grade**

|     |          |
|-----|----------|
| COM | \$7,417  |
| A   | \$7,628  |
| B   | \$8,038  |
| C   | \$8,763  |
| D   | \$9,688  |
| E   | \$10,617 |
| F   | \$11,629 |
| G   | \$13,028 |
| H   | \$14,523 |
| I   | \$16,854 |
| J   | \$19,660 |

**To Order, Specify:**

- 1 Model Number
- 2 Fabric Selection - vendor, pattern and color  
Visit [www.jsifurniture.com/finishes-and-materials/textiles](http://www.jsifurniture.com/finishes-and-materials/textiles) for our textiles program. See selection of standard and graded in manufacturers and patterns.
- 3 Tablet Table Option Selection  
[See Tablet Table Option Selection](#)
- 4 Side Power; see page [ZV1](#)
- 5 Back Power; see page [ZV1](#)
- 6 Standup Surface Laminate Color Selection  
[See Laminate Color Selection](#)

**Specifications**

- Fabric is railroaded.
- Non-patterned textile is recommended.
- Frame interior is upholstery grade plywood with glued solid hardwood cross members reinforced with wood screws.
- Seat has synthetic sheet webbing with cross strap and 3 ¾" thick high resiliency seat polyurethane multi-density foam.
- Back has 1 ¾" thick polyurethane foam, back lumbar has 10 channel stitch detail thru ¾" thick polyurethane foam.
- ¾" of high grade polyurethane foam covers a plywood constructed arm frame.

# Ziva

## MODULAR



### Description

### Model

### Specifications

### List Price Per Grade

32" Radius Quarter Round with Partial Inside Back and Right Arm

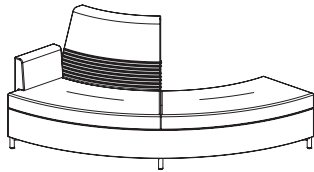

ZV6688-RIB-RA

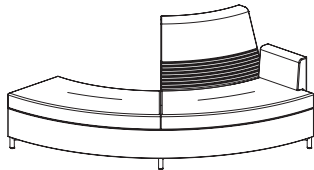

ZV6688-LIB-LA

**ZV6688-RIB-RA**  
**ZV6688-LIB-LA**

- upholstered seat and back
- fabric application is railroad. Non-patterned fabrics are recommended
- seat side power available, specify and add \$560 list; indicate right or left as seated and color Black (B) or White (W)
- tablet available, specify and add \$785 list for standard solid surface or \$663 list for laminate or veneer

| Dimensions | D        | W      | H      |
|------------|----------|--------|--------|
| Overall    | 39 1/2   | 88 3/8 | 36     |
| Seat       | 20 1/2   | 26     | 17 1/2 |
| Arm        |          |        |        |
| Upholstery | Shipping |        |        |
| COM Ydg    | 6 1/4    | Ctn Wt | 189    |
|            |          | Cu Ft  | 81     |

|     |          |
|-----|----------|
| COM | \$5,503  |
| A   | \$5,610  |
| B   | \$5,816  |
| C   | \$6,182  |
| D   | \$6,647  |
| E   | \$7,114  |
| F   | \$7,639  |
| G   | \$8,348  |
| H   | \$9,107  |
| I   | \$10,292 |
| J   | \$11,715 |

32" Radius Quarter Round with Inside Back and Center Arm

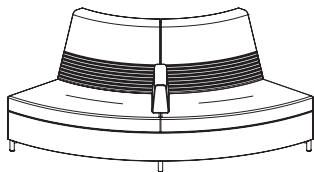

**ZV6688-FIB-CA**

- upholstered seat and back
- fabric application is railroad. Non-patterned fabrics are recommended
- seat side power available, specify and add \$560 list; indicate right or left as seated and color Black (B) or White (W)

| Dimensions | D        | W      | H      |
|------------|----------|--------|--------|
| Overall    | 39 1/2   | 87 5/8 | 36     |
| Seat       | 20 1/2   | 26     | 17 1/2 |
| Arm        |          |        |        |
| Upholstery | Shipping |        |        |
| COM Ydg    | 8 3/4    | Ctn Wt | 231    |
|            |          | Cu Ft  | 81     |

|     |          |
|-----|----------|
| COM | \$6,813  |
| A   | \$6,960  |
| B   | \$7,247  |
| C   | \$7,759  |
| D   | \$8,409  |
| E   | \$9,060  |
| F   | \$9,777  |
| G   | \$10,766 |
| H   | \$11,817 |
| I   | \$13,463 |
| J   | \$15,439 |

32" Radius Quarter Round with Inside Back and Right and Center Arm

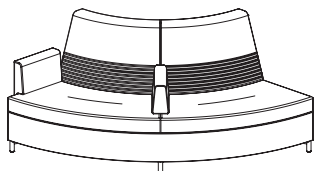

ZV6688-FIB-RCA

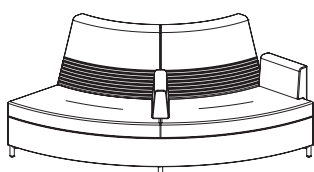

ZV6688-FIB-LCA

**ZV6688-FIB-RCA**  
**ZV6688-FIB-LCA**

- upholstered seat and back
- fabric application is railroad. Non-patterned fabrics are recommended
- seat side power available, specify and add \$560 list; indicate right or left as seated and color Black (B) or White (W)
- tablet available, specify and add \$785 list for standard solid surface or \$663 list for laminate or veneer

| Dimensions | D        | W      | H      |
|------------|----------|--------|--------|
| Overall    | 39 1/2   | 87 5/8 | 36     |
| Seat       | 20 1/2   | 26     | 17 1/2 |
| Arm        |          |        |        |
| Upholstery | Shipping |        |        |
| COM Ydg    | 9 1/2    | Ctn Wt | 242    |
|            |          | Cu Ft  | 81     |

|     |          |
|-----|----------|
| COM | \$7,306  |
| A   | \$7,465  |
| B   | \$7,777  |
| C   | \$8,329  |
| D   | \$9,036  |
| E   | \$9,743  |
| F   | \$10,522 |
| G   | \$11,587 |
| H   | \$12,729 |
| I   | \$14,512 |
| J   | \$16,653 |

ZIVA

**Description**

**1 Model**

**Specifications**

**List Price Per Grade**

54" Radius Quarter Round with Partial Outside Back and Right Arm

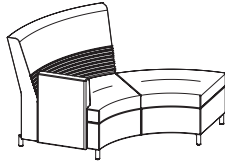

ZV6588-ROB-RA

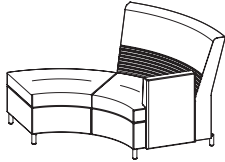

ZV6588-LOB-LA

- ZV6588-ROB-RA**  
**ZV6588-LOB-LA**
- upholstered seat and back
  - fabric application is railroad. Non-patterned fabrics are recommended
  - seat side power available, specify and add \$560 list; indicate right or left as seated and color Black (B) or White (W)
  - power available in the center of the lower extreme back, USB-C+A add \$295 list or single simplex add \$186 list; specify USB or Simplex and color Black (B) or White (W)
  - tablet available, specify and add \$785 list for standard solid surface or \$663 list for laminate or veneer
  - stand up surface with privacy screen available, add \$666; specify standard JSI laminate for top and the color of felt board for the privacy screen

| Dimensions | D        | W      | H    |
|------------|----------|--------|------|
| Overall    | 42 ½     | 96 ⅞   | 36   |
| Seat       | 20 ½     | 33 ½   | 17 ½ |
| Arm        |          |        |      |
| Upholstery | Shipping |        |      |
| COM Ydg    | 5 ½      | Ctn Wt | 139  |
|            |          | Cu Ft  | 95   |

|     |          |
|-----|----------|
| COM | \$4,641  |
| A   | \$4,734  |
| B   | \$4,916  |
| C   | \$5,236  |
| D   | \$5,647  |
| E   | \$6,058  |
| F   | \$6,698  |
| G   | \$7,379  |
| H   | \$8,110  |
| I   | \$9,250  |
| J   | \$10,621 |

14" Radius Quarter Round with Inside Back and Center Arm

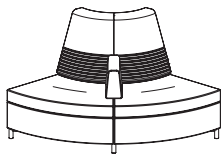

- ZV6588-FIB-CA**
- upholstered seat and back
  - fabric application is railroad. Non-patterned fabrics are recommended
  - seat side power available, specify and add \$560 list; indicate right or left as seated and color Black (B) or White (W)
  - tablet available, specify and add \$785 list for standard solid surface or \$663 list for laminate or veneer

| Dimensions | D        | W      | H    |
|------------|----------|--------|------|
| Overall    | 39 ½     | 66 ½   | 36   |
| Seat       | 20 ½     | 35 ½   | 17 ½ |
| Arm        |          |        |      |
| Upholstery | Shipping |        |      |
| COM Ydg    | 5 ¾      | Ctn Wt | 102  |
|            |          | Cu Ft  | 63   |

|     |          |
|-----|----------|
| COM | \$4,959  |
| A   | \$5,060  |
| B   | \$5,252  |
| C   | \$5,601  |
| D   | \$6,041  |
| E   | \$6,482  |
| F   | \$7,170  |
| G   | \$7,902  |
| H   | \$8,686  |
| I   | \$9,908  |
| J   | \$11,383 |

**To Order, Specify:**

- 1 Model Number
- 2 Fabric Selection - vendor, pattern and color  
Visit [www.jsifurniture.com/finishes-and-materials/textiles](http://www.jsifurniture.com/finishes-and-materials/textiles) for our textiles program. See selection of standard and graded in manufacturers and patterns.
- 3 Side Power; see page [ZV1](#)
- 4 Tablet Table Option Selection  
[See Tablet Table Option Selection](#)

**Specifications**

- Fabric is railroaded.
- Non-patterned textile is recommended.
- Frame interior is upholstery grade plywood with glued solid hardwood cross members reinforced with wood screws.
- Seat has synthetic sheet webbing with cross strap and 3 ⅝" thick high resiliency seat polyurethane multi-density foam.
- Back has 1 ¾" thick polyurethane foam, back lumbar has 10 channel stitch detail thru ¾" thick polyurethane foam.
- ¾" of high grade polyurethane foam covers a plywood constructed arm frame.

## Ziva Tables Order Check List:



**Specify:**

- 1. Model Number**
- 2. Top Material**
  - a.) **Veneer**
    - 1.) **Wood Finish**
  - b.) **Laminate**
    - 1.) **Laminate Color**
  - c.) **Solid Surface**
    - 1.) **Solid Surface Color**

**Example:**

**ZVV2448-18MT** | **VENEER** | **MCH**  
 (model #) | (top material) | (finish)

**1. Model Number**

**2b.) Laminate**

**2. Top Material Selection:**

**a.) Veneer**

**ESS Essentials Veneer Collection**

|     |           |     |         |
|-----|-----------|-----|---------|
| BRK | Brickdust | MIN | Mineral |
| CSK | Cask      | MCH | Mocha   |
| CLY | Clay      | OBK | Outback |
| FAW | Fawn      | PIL | Pilsner |
| FLX | Flax      | SIE | Sienna  |
| FLN | Flint     | TRF | Truffle |
| LOF | Loft      | UMB | Umber   |
| MES | Mesa      | VAL | Valley  |

**ART Artisan Veneer Collection**

|     |        |     |        |
|-----|--------|-----|--------|
| BAR | Barrel | RAV | Raven  |
| BUF | Buff   | RYE | Rye    |
| CND | Cinder | SAB | Sable  |
| EGR | Egret  | SAD | Saddle |

**HPL Wood Grain Pattern Laminates**

|     |                 |     |                 |
|-----|-----------------|-----|-----------------|
| BEL | Belair          | MIN | Mineral         |
| BRK | Brickdust       | MCH | Mocha           |
| CSK | Cask            | OBK | Outback         |
| CLY | Clay            | PIL | Pilsner         |
| EGR | Egret           | PIN | Pinnacle Walnut |
| FAW | Fawn            | UMB | Umber           |
| FLN | Flint           | VAL | Valley          |
| FLO | Florence Walnut | WLH | Walnut Heights  |
| LOF | Loft            | WEA | Weathered Ash   |
| MES | Mesa            |     |                 |

**HPL Solid Laminates**

|     |                |     |            |
|-----|----------------|-----|------------|
| ALB | Alabaster      | SHD | Shadow     |
| BLK | Black          | SLG | Slate Grey |
| BBL | Bridal Blanco  | ZEN | Zen Grey   |
| DWH | Designer White |     |            |

**3c.) Solid Surface**

|     |                |     |                   |
|-----|----------------|-----|-------------------|
| DWH | Designer White | ONX | Black Onyx Mirage |
| HST | Hot Stone      | SOG | Soothing Grey     |

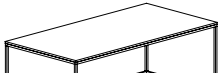
| Description  | D  | W  | H  | CTN WT | CU FT | ① Model      | Laminate | Essentials Veneer | Artisan Veneer | Solid Surface |
|--|----|----|----|--------|-------|--------------|----------|-------------------|----------------|---------------|
| <b>Coffee Table</b><br> | 24 | 48 | 18 | 51     | 15    | ZVT2448-18MT | \$2,842  |                   |                |               |
|  | 24 | 48 | 18 | 51     | 15    | ZVW2448-18MT |          | \$2,842           | \$2,982        |               |
|  | 24 | 48 | 18 | 51     | 15    | ZVS2448-18MT |          |                   |                | \$3,071       |

· Arctic Silver powder-coated frame

|   |    |    |    |    |    |              |         |         |         |         |
|---|----|----|----|----|----|--------------|---------|---------|---------|---------|
| <b>Square Coffee Table</b><br> | 30 | 30 | 18 | 42 | 12 | ZVT3030-18MT | \$2,675 |         |         |         |
|   | 30 | 30 | 18 | 42 | 12 | ZVW3030-18MT |         | \$2,675 | \$2,805 |         |
|   | 30 | 30 | 18 | 42 | 12 | ZVS3030-18MT |         |         |         | \$2,895 |

· Arctic Silver powder-coated frame

|   |    |    |    |    |    |               |         |         |         |         |
|---|----|----|----|----|----|---------------|---------|---------|---------|---------|
| <b>Half Round Coffee Table</b><br> | 24 | 48 | 18 | 45 | 15 | ZVT2448-18HRT | \$2,647 |         |         |         |
|   | 24 | 48 | 18 | 45 | 15 | ZVW2448-18HRT |         | \$2,647 | \$2,775 |         |
|   | 24 | 48 | 18 | 45 | 15 | ZVS2448-18HRT |         |         |         | \$2,863 |

· Arctic Silver powder-coated frame

|  |    |    |    |    |   |              |         |         |         |         |
|--|----|----|----|----|---|--------------|---------|---------|---------|---------|
| <b>Work Height Table</b><br> | 15 | 30 | 26 | 21 | 8 | ZVT1530-26WT | \$2,316 |         |         |         |
|  | 15 | 30 | 26 | 21 | 8 | ZVW1530-26WT |         | \$2,316 | \$2,430 |         |
|  | 15 | 30 | 26 | 21 | 8 | ZVS1530-26WT |         |         |         | \$2,501 |

· Arctic Silver powder-coated frame

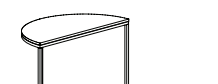
|  |    |    |    |    |   |               |         |         |         |         |
|--|----|----|----|----|---|---------------|---------|---------|---------|---------|
| <b>Half Round Work Height Table</b><br> | 12 | 24 | 26 | 17 | 6 | ZVT2448-26HRT | \$1,643 |         |         |         |
|  | 12 | 24 | 26 | 17 | 6 | ZVW2448-26HRT |         | \$1,643 | \$1,566 |         |
|  | 12 | 24 | 26 | 17 | 6 | ZVS2448-26HRT |         |         |         | \$1,777 |

· Arctic Silver powder-coated frame

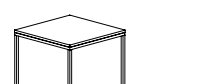
|  |    |    |    |    |   |              |         |         |         |         |
|--|----|----|----|----|---|--------------|---------|---------|---------|---------|
| <b>Square Work Height Table</b><br> | 15 | 15 | 26 | 14 | 5 | ZVT1515-26PT | \$1,753 |         |         |         |
|  | 15 | 15 | 26 | 14 | 5 | ZVW1515-26PT |         | \$1,753 | \$1,838 |         |
|  | 15 | 15 | 26 | 14 | 5 | ZVS1515-26PT |         |         |         | \$1,896 |

· Arctic Silver powder-coated frame

**To Order, Specify:**

- ① Model Number
- ② Top Material:
  - a.) Veneer
    - 1.) Finish Color [See Finish Color Options](#)
  - b.) Laminate
    - 1.) Laminate Color [See Laminate Color Options](#)
  - c.) Solid Surface [See Solid Surface Color Options](#)

ZIVA